

Table of Contents

The NOAA KLM User's Guide is a comprehensive document describing the orbital and spacecraft characteristics, instruments, data formats, miscellaneous but pertinent information of the NOAA-K,L,M,N,N' satellites, as well as, the Metop series satellites as it pertains to the NOAA instruments.

- **Cover Page:**
- **Disclaimer:** A disclaimer from the editor of the NOAA KLM User's Guide.
- **Acknowledgments:** A letter of thanks for all those who helped out.
- **Acronyms and Abbreviations:** A listing of acronyms and abbreviations used in the NOAA KLM User's Guide.
- **List of Figures:** A listing of all figures in the NOAA KLM User's Guide.
- **List of Tables:** A listing of all tables in the NOAA KLM User's Guide.
- **NOAA-N, -N' Supplement:** A Listing of links with specific changes for the NOAA-N and -N' spacecraft.
- **Amendments:** A listing of revisions made to the NOAA KLM User's Guide.

Section 1:

- **Section 1.0:** Introduction to the NOAA KLM System
- **Section 1.1:** The NOAA KLM Concept
- **Section 1.2:** NOAA KLM Spacecraft Characteristics

Section 2:

- **Section 2.0:** NOAA Polar Satellite Navigation and Earth Location
- **Section 2.1:** Navigating the Polar Satellites
- **Section 2.2:** Earth Locating the Polar Satellite Data
- **Section 2.3:** Navigation and Earth Location Processing Within NOAA
- **Section 2.4:** Interpolating the Level 1b Earth Location Data

Section 3:

- **Section 3.0:** Description of the NOAA KLM Sensor Package

- **Section 3.1:** Advanced Very High Resolution Radiometer/3 (AVHRR/3)
- **Section 3.2:** High Resolution Infrared Radiation Sounder (HIRS)
- **Section 3.3:** Advanced Microwave Sounding Unit-A (AMSU-A)
- **Section 3.4:** Advanced Microwave Sounding Unit - B (AMSU-B)
- **Section 3.5:** Space Environment Monitor (SEM-2)
- **Section 3.6:** Data Collection System/2 (DCS/2)
- **Section 3.7:** Search and Rescue Satellite (SARSAT) Instrument
- **Section 3.8:** Solar Backscatter Ultraviolet Spectral Radiometer (SBUV/2)
- **Section 3.9:** Microwave Humidity Sounder (MHS) [For NOAA-N and -N' only]

Section 4:

- **Section 4.0:** Real-Time Data Systems for Local Users
- **Section 4.1:** HRPT System
- **Section 4.2:** APT System
- **Section 4.3:** Direct Sounder Broadcast (DSB)
- **Section 4.4:** Data Collection and Location System

Section 5:

- **Section 5.0:** Tracking Procedures for Directional Antennas used to Acquire Data From Real-Time Transmissions System Sensors
- **Section 5.1:** TBUS Bulletin
- **Section 5.2:** Alternate Sources and Forms of Satellite Prediction Position Information

Section 6:

- **Section 6.0:** Ingest and Pre-processing
- **Section 6.1:** Ingest
- **Section 6.2:** Pre-processing
- **Section 6.3:** Calibration
- **Section 6.4:** Monitoring and Quality Assurance

Section 7:

- **Section 7.0:** Calibration of NOAA KLM Instruments

- **Section 7.1:** AVHRR
- **Section 7.2:** HIRS/3
- **Section 7.3:** AMSU-A and AMSU-B
- **Section 7.4:** SBUV/2
- **Section 7.5:** SEM-2
- **Section 7.6:** MHS [For NOAA-N and -P only]

Section 8:

- **Section 8.0:** Level 1b Database
- **Section 8.1:** Data Representation and Storage
- **Section 8.2:** Level 1b Data Set Names
- **Section 8.3:** Data Distribution Formats

Section 9:

- **Section 9.0:** NESDIS Operational Products
- **Section 9.1:** Sea Surface Temperature (SST) Products
- **Section 9.2:** Mapped GAC Products
- **Section 9.3:** Radiation Budget Products
- **Section 9.4:** Sounding Products (ATOVS and AMSU-B)
- **Section 9.5:** NOAA CoastWatch Products
- **Section 9.6:** Snow and Ice Products
- **Section 9.7:** Ozone (SBUV/2) Products
- **Section 9.8:** Aerosol/Optical Thickness Products
- **Section 9.9:** Comprehensive Large Array-data Stewardship System (CLASS)

Appendices:

- **Appendix A:** APT Predict (TBUS) Bulletin
- **Appendix B:** Using Brouwer-Mean Elements from the TBUS Bulletin
- **Appendix C:** Polar Stereographic Earth Location Routines
- **Appendix D:** Miscellaneous Parameters for the Polar Orbiter Satellites
- **Appendix E:** Index of Internet Resources

- **Appendix F:** Ordering Retrospective Data
- **Appendix G:** Data Changes and Problem Record
- **Appendix H:** Orbit Injection
- **Appendix I:** Formulation of a Generic Algorithm for Earth locating data from NOAA Polar Orbiter Satellites
- **Appendix J:** Instrument Scan Properties

- **Appendix K:** Conversion of Blackbody Temperatures to AVHRR Radiances
- **Appendix L:** References
- **Appendix M:** Implementation of AMSU-B Correction Algorithm
- **Appendix N:** Software for Converting IBM Floating Point Numbers to IEEE Numbers
- **Appendix O:** Procedure for Scheduling AVHRR LAC Data
- **Appendix P:** Fundamental Constants

NOAA KLM USER'S GUIDE

with NOAA-N, N Prime, and MetOp SUPPLEMENTS

last updated April 2014

Edited by:

Jeffrey Robel and Axel Graumann

Original List of Contributors:

Kathy Kidwell (NOAA)		
Roberto Aleman (NASA)	Geof Goodrum (NOAA)	Tsan Mo (NOAA)
Irving Ruff (NOAA)	Joe Askew (NOAA)	Axel Graumann (NOAA)
Bob Muckle (NOAA)	John Sapper (NOAA)	Dudley Bowman (NOAA)
Phil Green (NOAA)	Sam Patterson (NOAA)	Jerry Sullivan (NOAA)
Stan Brown (NOAA)	Emily Harrod (NOAA)	Norm Peterski (NASA)
Jeremy Throwe (NOAA)	Ellen Brown (NOAA)	Mary Hollinger (NOAA)
Walt Planet (NOAA)	Dave Wark (NOAA)	Wendell Clouse (NOAA)
Jack Knoll (NASA)	Bruce Ramsay (NOAA)	Mike Weinreb (NOAA)
Doug Fineberg (NASA)	Sergey Krimchansky (NASA)	Nagaraja Rao (NOAA)
Wayne Winston (NOAA)	Larry Flynn (NOAA)	Larry McMillin (NOAA)
George Robinson (NASA)	Tom Wrublewski (NOAA)	Harold Goldberg (NASA)
Tony Miller (NASA)	Doug Ross (NOAA)	Tom Kleespies (NOAA)

**National Oceanic and Atmospheric Administration
National Environmental Satellite, Data, and Information Service
National Climatic Data Center
Remote Sensing and Applications Division
Veach-Baley Federal Building
151 Patten Ave
Asheville, NC 28801-5001
Telephone: (828) 271-4800
Fax: (828) 271-4876
Email: ncdc.satorder@noaa.gov**

Disclaimer

While every effort has been made to ensure that this documentation is accurate and reliable, NOAA cannot assume liability for any damages caused by inaccuracies in the NOAA polar orbiter data or documentation, or as a result of the failure of the data or software to function in a particular manner.

The maintenance of this document has historically focused primarily on assuring file format descriptions, platforms, and instrument descriptions are current. Information regarding ground system configurations, data production systems and other information not related to understanding and using of the datasets themselves may not be current.

Phone numbers, fax numbers, physical addresses, e-mail addresses and Internet Uniform Resource Locators (URLs) are subject to change. NOAA makes no warranty, expressed or implied, nor does the fact of distribution constitute a warranty.

Acknowledgments

The original version of the NOAA KLM User's Guide is based on the work done by Katherine B. Kidwell and has been frequently updated to reflect instrument changes, new platforms, additional products, as well as, changes to the processing, data access and archive procedures. Many thanks to the dedicated people within the offices of NOAA and NASA and to the various stakeholders, who have made this document an essential resource of information to thousands of users worldwide.

Again I wish to thank Kathy for the fine work that she did in maintaining and enlarging this document and in the support she gave me when I assumed her responsibilities.

Jeffrey M. Robel

Acronyms and Abbreviations

A/D	Analog/Digital
AC	Alternating Current
ACF	Albedo Correction Factor
ADACS	Attitude Determination and Control Subsystem
ADE	Array Drive Electronics
AELDS	Advanced Earth Location Data System
AFGWC	Air Force Global Weather Central
AFSCN	Air Force Satellite Control Network
AFTN	Aeronautical Fixed Telecommunications Network
AGC	Automatic Gain Control
AGS	Ascent Guidance Software
AIP	AMSU Information Processor
AKM	Apogee Kick Motor
AM	Amplitude Modulation
AMSAT	Radio Amateur Satellite Corporation
AMSU	Advanced Microwave Sounding Unit
AMSU-A	Advanced Microwave Sounding Unit-A
AMSU-B	Advanced Microwave Sounding Unit-B
APT	Automatic Picture Transmission
ARIA	Advanced Range Instrumented Aircraft
ARS	Archive Retrieval System
asc	Ascending
ASCII	American Standard Coded Information Interchange
ASE	Available Solar Energy
ASR	Available Solar Radiation
ATMS	Advanced Technology Microwave Sounder
ATN	Advanced TIROS-N
ATOVS	Advanced TIROS Operational Vertical Sounder
AVHRR/3	Advanced Very High Resolution Radiometer Version 3
BCA	Battery charge Assembly
BIP	Band Interleaved by Pixel
BM	Brouwer Mean
bps	bits per second
BRDF	Bidirectional Reflectance Distribution Function
BRU	Battery Reconditioning Unit
BT	Brightness Temperature
BTX	Beacon Transmitter
C	Celsius or Centigrade
CAC	Climate Analysis Center
CCR	Cloud Cover Radiometer Contractor Change Request
CCS	Command and Control Subsystems
CCT	Computer Compatible Tape

ccw	counter clockwise
CD	Coefficient of Drag
CDA	Command and Data Acquisition
CDEM	Continuous dynode Electron Multiplier
CEMES	Centre d'Etudes de la Meteorologie Spatiale (France)
CEMSCS	Central EnvironMental Satellite Computer System
CGMS	Coordination Group for Meteorological Satellites
ch	channel
CIU	Control Interface Unit
CLASS	Comprehensive Large Array-data Stewardship System
CLAVR-x	Clouds from AVHRR Extended
CLW	Cloud Liquid Water
cm	centimeter
CMMD VER	Command Verification
CNES	Centre National D'Etudes Spatiales (France)
CODATA	Committee on Data for Science and Technology (International Council for Science)
CPC	Controls Power Converter
CPIDS	Calibration Parameters Input Data Sets
CSP	Calibration Start Pulse
CU	Control Unit
cw	clockwise
D/A	Digital/Analog
DACS	Data Acquisition and Control Subsystems
DAU	Decryption Authentication Unit
dB	decibel
dBm	decibels per milliwatt
dBW	decibels referenced to a watt
DC	Direct Current
DCS/2	Data Collection System/2
DDS	Data Distribution Server
desc	descending
DHS	Data Handling Subsystem
DIGB	Digital "B"
DMSP	Defense Meteorological Satellite Program
DOD	Department of Defense
DPD	DCS/SAR Processor Diplexer
DPSS	Data Processing and Services Subsystem
DPU	Data Processing Unit
Dr	Data Record
DRU	Data Recovery Unit
DSB	Direct Sounder Broadcast
DSN	Digital Signal (level) N
DTR	Data Transfer Rate
EAA	Equal Areas/Equal Aspect

EBCDIC	Extended binary Coded Decimal Interchange Code
ECAL	Electronic Calibration
ECF	Earth Centered Fixed (coordinate system)
EDR	Environmental Data Record
ELM	Electronics Module
ELT	Emergency Locator Transmitters
EMI	ElectroMagnetic Interference
eof	end of file
eor	end of record
EPIRB	Emergency Position Indicating Radio Beacon (located by SARSAT)
ERBE	Earth Radiation Budget Experiment
ESA	Earth Sensor Assemble ElectroStatic Analyzers
ESM	Equipment Support Module
ETSR	Extraterrestrial Solar Spectral Irradiance
EU	Electronic Unit Engineering Unit
EUMETSAT	European Organization for the Exploration of Meteorological Satellites
eV	electron volts
FGGE	First GARPE Global Experiment
FIFO	First In First Out
FM	Frequency Modulation
FNMOC	Fleet Numerical Meteorology and Oceanography Center (Navy)
FOV	Field of View
FRAC	Full Resolution Area Coverage
ftp	file transfer protocol
FW	Filter Wheel
FWHM	Full Width at Half Maximum
GAC	Global Area Coverage
GARP	Global Atmospheric Research Program
GCMD	Global Change Master Directory
GDO	Gunn diode Oscillator
GHA	Greenwich Hour Angle
GHz	Gigahertz
GMS	Geostationary Meteorological Satellite
GOES	Geostationary Operational Meteorological Satellite
GRT	Ground Reference Time
GTS	Global Telecommunications Service
GUI	Graphical User Interface
HIF	Historical Instrument File
HIRS/3	High Resolution Infrared Radiation Sounder Version 3
HRPT	High Resolution Picture Transmission

HTML	Hyper Text Markup Language
HV	High Voltage
HVPS	High Voltage Power Supply
Hz	Hertz
I/O	Input/Output
ICE	Inductosyn Control Electronics
ICT	Internal Cold Target
IF	Intermediate Frequency
IFC	In-Flight Calibration
IFOV	Instantaneous field of View
IMP	Instrument Mounting Platform
IMS	Ice Mapping System
IMU	Inertial Measurement Unit
in	inch
IPD	Information Processing Division
IR	Infrared
IRR	InterRange Ratio
ITT-A/CD	International Telephone and Telegraph – Aerospace/Communications Division
IWT	Internal Warm Target
JIC	Joint Ice Center
K	Kelvin
ka	kilo ampres
kbps	kilobits per second
keV	kilo electron Volts
kg	kilograms
kHz	kilo Hertz
km	kilometer
kpps	kilo pulses per second
KWBC	National Weather Service Telecommunications Gateway
LAC	Local Area Coverage
lbs	pounds
LED	Light Emitting Diode
LIFO	Last In First Out
LOS	Line of Sight Loss of Signal
LRC	Longitude Rotation Convention
LS	Level Sensor
LSB	Least Significant Bit
LSE	Land Surface Emissivity
LSP	Least Significant Portion
LST	Local Solar Time Land Surface Temperature
LUT	Local User Terminals
LVPS	Low Voltage Power Supply

LW	Long Wave
MASS	Microwave and Antenna Subsystem
max	maximum
mb	millibars
mbps	megabits per second
MDD	Meteorological Data Distribution
MDE	Motor Drive Electronics
MEPED	Medium Energy Proton and Electron Detector
MeV	Milli electron volt
MFP	Major Frame Pulse
MHS	Microwave Humidity Sounder
MHz	Mega Hertz
mi	mile
MIRP	Manipulated Information Rate Processor
MIRS	Microwave Integrated Retrieval System
mm	millimeter
mps	meters per second
mr	milliradian
MSB	Most Significant Bit
msec	microsecond
MSP	Most Significant Portion
MSPPS	Microwave Surface and Precipitation Products System
MSU	Microwave Sounding Unit
MTF	Modulation Transfer Function
mux	multiplexer
MW	microwave
N/A	Not Available
NASA	National Aeronautics and Space Administration
NCDC	National Climatic Data Center
NCEP	National Center for Environmental Prediction
NE Δ N	Noise Equivalent Radiance
NE Δ T	Noise Equivalent Delta Temperature
NESDIS	National Environmental Satellite, Data and Information Services
NH	Northern Hemisphere
NIC	National Ice Center
NIST	National Institute of Standards and Technology
nm	nanometers
NMC	National Meteorological Center
NPP	NPOESS Preparatory Project
NPOESS	National Polar-orbiting Operational Environmental Satellite System
NOAA	National Oceanic and Atmospheric Administration
NOAASIS	NOAA Satellite Information System
NODC	National Oceanographic Data Center

NOHRSC	National Operational Hydrologic Remote Sensing Center
NORAD	North American Air Defense Command (currently USSC)
NRZ-L	Non-return to sea level
NRZ	Non-return to zero
NWS	National Weather Service
OIG	Orbital Interest Group
OLR	Outgoing Longwave Radiation
OOPS	Operational Ozone Product System
ORA	Office of Research and Applications (NOAA/NESDIS)
OSDPD	Office of Satellite Data Processing and Distribution (NOAA/NESDIS)
OSPO	Office of Satellite and Product Operations
OSO	Office of Satellite Operations (NOAA/NESDIS)
OT	Optical Thickness
PACS	Polar Acquisition and Control System
PC37DF	Primary Component 37 Day File
PCB	Printed Control Board
PDPS	Polar Data Processing System
PEU	Processing Electronics Unit
PH37DF	Primary Histogram 37 Day File
PHD	Pulse Height Discriminators
PLLO	Phase Locked Loop Oscillators
PM	Phase Modulation
PMF	Product Master File
PMT	Photo Multiplier Tube
PMW	Position Mode Wavelength
pn	pseudo noise
POES	Polar Operational Environmental Satellite
Pps	Pulses per second
PROM	Programmable Read-Only Memory
PRT	Platinum Resistance Thermistors
PSB	Product Systems Branch
PSE	Power Supply Electronics
PSG	Polar Stereographic
PSU	Power Supply Unit
PWR	Power
QC	Quality Control
RAM	Random Access Memory
RAOB	Radiosonde Observation
RBPGS	Radiation Budget Product Generation System
RCE	Reaction Control Equipment
RCS	Reaction Control System
REF	Reference
RF	Radio Frequency
RFI	Radio Frequency Interference

rms, RMS	Root Mean Squared
ROM	Read Only Memory
rpm	revolutions per minute
RPU	Receiving and Power Unit
RSS	Reaction Support Structure
RTOVS	Revised TIROS Operational Vertical Sounder
RTTY	Radio Teletype
RWA	Reaction Wheel Assemblies
RWM	Read Write Memory
s/c	spacecraft
S/N	Signal to noise ratio
SA	Solar Array
SAA	Satellite Active Archive Solar Azimuth Angle
SAD	Solar Array Drive
SAIP	Stored AMSU Ingest Processing
SAR	Search and Rescue
SARP-2	Search and Rescue Processor-2
SARR	Search and Rescue Repeater
SARSAT	Search and Rescue Satellite Aided Tracking
SATCU	Solar Array Telemetry Commutator Unit
SBA	Spin Bearing Assembly
SBUV/2	Solar Backscatter Ultraviolet Version 2
SCF	Satellite Control Facility (USAF)
SDEV	Standard Deviation
SDR	Sensor Data Record
SEA	Solar Elevation Angle
sec	second
SEC	Space Environment Center
SEM-2	Space Environment Monitor Version 2
SGP4	Simplified General Perturbation
SH	Southern Hemisphere
SLA	Search and Rescue L-Band Antenna
SM	Sensor Module
SMSO	Sweep Mode Solar Observations
SOA	S-Band Omni Antenna
SOCC	Satellite Operations Control Center
SPN	Shared Processing Network
SPU	Signal Processing Unit
sr	steradian
SRA	SAR Receiver Antenna
SSB	Satellite Services Branch (NCDC)
SSBUV	Space Shuttle SBUV
SSD	Satellite Services Division Solid State Detector

SSM/T2	Special Sensor Microwave/Water Vapor Profiler
SSM/T	Special Sensor Microwave/Temperature
SSM/I	Special Sensor Microwave/Imager
SSP	Sub-Satellite Point
SST	Sea Surface Temperature
SSU	Stratospheric Sounding Unit
STAR	Center for Satellite Applications and Research
STIP	Stored TIROS Information Processing
STU	Scan Timing Unit Standard Time Unit
STX	Station Transmission Assembly
SUBCOM	subcommutator
SW	Short Wave
SWE	Snow Water Equivalent
SZA	Solar Zenith Angle
TARM	TIROS Atmospheric Radiance Module
T/V	Thermal/Vacuum
TBD	To Be Determined
TBUS	TIROS Bulletin United States
TCE	Thermal Control Electronics
TCS	Thermal Control Systems
TDR	Temperature Data Record
TED	Total Energy Detector
TIP	TIROS Information Processor
TIROS	Television Infrared Observation Satellite
TLE	Two-line Element
TLM	Telemetry
TOVS	TIROS Operational Vertical Sounder
TPW	Total Precipitable Water
TU	Transport Units
UDA	UHF Data Collection System Antenna
UEF	User Ephemeris File
UHF	Ultra High Frequency
URL	Uniform Resource Locator
USAF	United States Air Force
USO	Ultra Stable Oscillator
USSC	U.S. Space Command (formerly NORAD)
UTC	Coordinated Universal Time (same as GMT)
UV	Ultraviolet
V/C	Vector Control
V	Volt
VAFB/WR	Vandenberg Air Force Base/Western Range
VCO	Voltage Controlled Oscillator
VDC	Volts DC
VHF	Very High Frequency

VHRR	Very High Resolution Radiometer
VIS	Visible
VPD	Vacuum Photo Diode
VRA	VHF Real-time Antenna
VS	Variable block Span (IBM)
VTF	Vacuum Test Fixture
VTX	VHF Real-time Transmitter
W	watts
WEFAX	Weather Facsimile (from meteorological satellites)
WLC	Wavelength Calibration
WMO	World Meteorological Organization
WR	Western Range Work Request
WWW	World Wide Web
XBT	Expendable Bathythermograph
XSU	Cross Strap Unit

List of Figures

Figure 1.2-1 NOAA KLM System Functional Design	1-6
Figure 1.2.1-1. NOAA KLM Spacecraft Configuration	1-8
Figure 1.2.2.5-1. SARSAT Concept	1-16
Figure 1.2.3-1. RCE Functional Schematic	1-19
Figure 1.2.4-1. ADACS Simplified Block Diagram	1-20
Figure 2.3.2-1. Sample plot available from Graphical orbit locator	2-7
Figure 2.3.2-2. Sample plot available from Graphical Orbit Locator	2-8
Figure 2.4.1-1. Relationship of sub-satellite point to Earth	2-11
Figure 2.4.1-2. Angular relationship between satellite, surface and Earth Center	2-12
Figure 2.4.4-1. Earth Location of LAC and GAC spots near nadir	2-19
Figure 2.4.4-2. Position of the two LAC spots that straddle nadir	2-20
Figure 3.1.2.1-1. AVHRR-3 Exploded view	3-6
Figure 3.3.2.1-1 Frequency translation of a broadband signal in heterodyne reception	3-39
Figure 3.3.2.1-2. Schematic illustration of a single passband channel	3-40
Figure 3.3.2.1-3. Schematic illustration of a double sideband channel	3-41
Figure 3.3.2.1-4. Schematic illustration of a quadruple sideband channel	3-42
Figure 3.3.2.2-1. AMSU-A1 Instrument	3-45
Figure 3.3.2.2-2 AMSU-A2 Instrument	3-45
Figure 3.4.1-1 Microwave Characteristics of the Atmosphere	3-46
Figure 3.4.2.1-1. AMSU-B General Configuration	3-49
Figure 3.7-1. SARSAT instrument package	3-64
Figure 3.7.2.3-1. SARP-2 Block diagram	3-67
Figure 3.8.2-1. SBUV/2 Instrument	3-70
Figure 3.9.1-1. MHS Channels and Passband Arrangement	3-72

Figure 3.9.2.1-1. MHS General Assembly	3-75
Figure 3.9.2.2-1. MHS Scanning Principle	3-76
Figure 3.9.2.4-1. MHS Operating Modes	3-78
Figure 4.1.5.1-1. AIP Output Format for NOAA KLM	4-43
Figure 4.1.5.2-1. AIP Output Format for NOAA-N, N'	4-48
Figure 4.2.2-1. APT Frame Format	4-53
Figure 4.2.3-1. APT Linearization	4-55
Figure 4.2.3-2. APT Video Line Format	4-56
Figure 4.2.3-3. APT Synchronization Details	4-57
Figure 4.3.3.1-1. TIP Minor Frame Format for NOAA KLM	4-59
Figure 4.3.3.2-1. TIP Minor Frame Format for NOAA-N, N'	4-63
Figure 5.1-1. Schematic representation of TBUS-1/TBUS-2 information	5-3
Figure 6.0-1. Polar Data Processing Flow	6-2
Figure 7.1.2.2-1. AVHRR Thermal Channel Calibration Sequence	7-6
Figure 9.7.3-1. 1b Data Table	9-128
Figure 9.7.1.4-1. SBUV 1b Data Set Record IDs	9-130
Figure 9.7.2.2-1. PMF Archive Tape Data Set Organization	9-153
Figure A-1. Schematic Representation of Information Conveyed in TBUS-1 and TBUS-2.	A-2
Figure A.3-1. Global Octant Map	A-12
Figure C-1. Definition of latitude angle	C-3
Figure C-2. Definition of longitude angle	C-4
Figure C-3. Arrangement of array containing two hemispheres	C-5
Figure C-4. Example of CENTI=254 and CENTJ=258	C-7
Figure D.1-1. Spectral Response Curve for NOAA-15 Channel 1	D-19

Figure D.1-2. Spectral Response Curve for NOAA-15 Channel 2	D-20
Figure D.1-3. Spectral Response Curve for NOAA-15 Channel 3A	D-21
Figure D.1-4. Spectral Response Curve for NOAA-15 Channel 3B	D-22
Figure D.1-5. Spectral Response Curve for NOAA-15 Channel 4	D-23
Figure D.1-6. Spectral Response Curve for NOAA-15 Channel 5	D-24
Figure D.2-1. Spectral Response Curve for NOAA-16 Channel 1	D-92
Figure D.2-1. Spectral Response Curve for NOAA-16 Channel 2	D-93
Figure D.2-3. Spectral Response Curve for NOAA-16 Channel 3A	D-94
Figure D.2-4. Spectral Response Curve for NOAA-16 Channel 3B	D-95
Figure D.2-5. Spectral Response Curve for NOAA-16 Channel 4	D-96
Figure D.2-6. Spectral Response Curve for NOAA-16 Channel 5	D-97
Figure D.3-1. Spectral Response Curve for NOAA-17 Channel 1	D-130
Figure D.3-2. Spectral Response Curve for NOAA-17 Channel 2	D-131
Figure D.3-3. Spectral Response Curve for NOAA-17 Channel 3A	D-132
Figure D.3-4. Spectral Response Curve for NOAA-17 Channel 3B	D-133
Figure D.3-5. Spectral Response Curve for NOAA-17 Channel 4	D-135
Figure D.3-6. Spectral Response Curve for NOAA-17 Channel 5	D-136
Figure D.4-1. Spectral Response Curve for NOAA-18 Channel 1	D-198
Figure D.4-2. Spectral Response Curve for NOAA-18 Channel 2	D-199
Figure D.4-3. Spectral Response Curve for NOAA-18 Channel 3A	D-200
Figure D.4-4. Spectral Response Curve for NOAA-18 Channel 3B	D-201
Figure D.4-5. Spectral Response Curve for NOAA-18 Channel 4	D-202
Figure D.4-6. Spectral Response Curve for NOAA-18 Channel 5	D-203
Figure D.5-1. Spectral Response Curve for MetOp-A Channel 1	D-505
Figure D.5-2. Spectral Response Curve for MetOp-A Channel 2	D-506

Figure D.5-3. Spectral Response Curve for MetOp-A Channel 3A	D-507
Figure D.5-4. Spectral Response Curve for MetOp-A Channel 3B	D-508
Figure D.5-5. Spectral Response Curve for MetOp-A Channel 4	D-509
Figure D.5-6. Spectral Response Curve for MetOp-A Channel 5	D-510
Figure I.2-1. The Geometry of the Satellite and Its Scan Spot Relative to the Earth and the Earth-centered-inertial Coordinate System	I-3
Figure I.2-2. The Nominal Scanning Coordinate System	I-4
Figure I.2-3. The Scan Angle Within the Nominal Scanning Coordinate System	I-5
Figure I.2-4. The Earth-centered-inertial Coordinate and the Earth-centered-fixed Coordinate System	I-10
Figure I.3-1. Cross Section in the Plane of 00 E and 1800 E of the Earth Ellipsoid Showing the Geocentric and Geodetic Latitudes of a Feature	I-14
Figure J.1-1. Simulated Earth Surface Footprint of GAC and LAC Data	J-7
Figure J.1-2. AVHRR/3 Signal Position as a Function of Scan Angle	J-8
Figure J.2-1. Scan Angles for HIRS/3 and HIRS/4 Instruments	J-10
Figure J.2-2. Simulated Earth-surface Footprints for HIRS/3, HIRS/4 and AMSU-A (Detail), Half-Scan	J-11
Figure J.2-3. Simulated Earth-Surface Footprints for HIRS/3, HIRS/4 and AMSU-A, Full Scan	J-12
Figure J.3-1. AMSU-A Scanning Characteristics	J-15
Figure J.3-2. AMSU-A1 Antenna Position with Respect to Frame Synchronization P	J-16
Figure J.3-3. AMSU-A2 Antenna Position with Respect to Frame Synchronization Pulse	J-16
Figure J.3-4. AMSU-B Scanning	J-17
Figure J.3-5. Definition of AMSU-B Scan Plane and Motion	J-18
Figure J.3-6. MHS Scan Profile Velocity versus Time	J-19

List of Tables

Table 1.2-1. Mission Characteristics	1-4
Table 1.2.1-1. NOAA KLM Physical Characteristics	1-8
Table 1.2.1.3-1. Government-furnished Satellite Equipment List.	1-9
Table 1.2.2.1-1. AVHRR/3 Channels	1-11
Table 1.2.2.3-1. SBUV/2 Spectral Characteristics (Discrete Mode)	1-12
Table 1.2.2.4-1. SEM-2 Characteristics	1-13
Table 1.2.2.5-1. SARSAT Subsystem Characteristics	1-14
Table 1.2.2.6-1. DCS-2 System Characteristics	1-17
Table 1.2.5.1-1. APT Line Characteristics NOAA KLM Satellites	1-23
Table 1.2.6-1. NOAA KLM Data Handling Subsystem Data Inputs	1-23
Table 1.2.6-2. NOAA KLM Data Handling Subsystem Data Outputs	1-24
Table 1.2.7-1. Ascent, Early-Orbit and Contingency RF Communications Link Characteristics Summary	1-28
Table 1.2.7-2. NOAA KLM Operational Link Summary	1-29
Table 2.3.2-1. Sample NOAA-14 Equator Crossing Data	2-9
Table 2.3.2-2. Sample NOAA-14 TIP Clock Error Database	2-9
Table 2.4.2-1. Errors for Linear Interpolation Between Adjacent Located AVHRR Points for Latitude = 40°	2-13
Table 2.4.2-2. Errors for Lagrangian Interpolation Between Three Adjacent Located AVHRR Points at Latitude = 40°	2-14
Table 2.4.2-3. Errors for Lagrangian Interpolation From Three Limbward Located AVHRR Points at Latitude = 40°	2-15
Table 2.4.2-4. Errors for Lagrangian Interpolation From Five Limbward Located AVHRR Points at Latitude = 40°	2-16

Table 3.1.2.1-1. Summary of AVHRR/3 Spectral Channel Characteristics	3-2
Table 3.1.2.1-2. AVHRR/3 System Performance Characteristics	3-2
Table 3.1.2.1-3. AVHRR/3 Visible Channel Gain and Intercept Characteristics	3-5
Table 3.2.1.1-1. HIRS/3 System Characteristics	3-11
Table 3.2.1.1-2. HIRS/3 Spectral Characteristics	3-12
Table 3.2.1.2.1-1. HIRS/3 Sensor Temperature Ranges	3-14
Table 3.2.1.4-1. Functions of Bits 1-26 in the HIRS/3 Elements	3-16
Table 3.2.1.4-2. Functions of Bits 287-288 in the HIRS/3 Elements	3-17
Table 3.2.1.4-3. HIRS/3 Digital “A” Radiometric and Housekeeping Functions	3-18
Table 3.2.1.4-4. HIRS/3 Digital “A” Status Telemetry	3-22
Table 3.2.2.1-1. HIRS/4 System Characteristics	3-24
Table 3.2.2.1-2. HIRS/4 Spectral Requirements	3-26
Table 3.2.2.2.1-1. HIRS/4 Sensor Temperature Ranges	3-28
Table 3.2.2.4-1. HIRS/4 Digital “A” Data Output Format	3-31
Table 3.3.2.1-1. Channel Characteristics and Specifications of AMSU-A	3-37
Table 3.3.2.2-1. The number of PRTs in each AMSU-A module	3-43
Table 3.4.1-1. AMSU-B Channel Characteristics (based on actual instrument build and measured NE)T from thermal vacuum data)	3-47
Table 3.4.2.4-1. AMSU-B Systems Requirements Summary	3-51
Table 3.5.1.2-1. Particle types and energy intervals measured by the MEPED directional sensors	3-53
Table 3.5.2.2-1. Proton telescope detection energy levels	3-55
Table 3.5.2.2-2. Electron telescope detection energy intervals	3-55
Table 3.9.1-1. MHS Channels and Passband Characteristics	3-72
Table 4.1.2-1. HRPT Transmission Characteristics	4-1

Table 4.1.2-2. HRPT Parameters for NOAA KLM and NOAA-N,-N'	4-2
Table 4.1.3.1-1. HRPT Minor Frame Format for NOAA KLM	4-3
Table 4.1.3.2-1. HRPT Minor Frame Format for NOAA-N, -N'	4-6
Table 4.1.4.1-1. AMSU-A1 Digital "A" Data Format – Full Scan Mode for NOAA KLM	4-9
Table 4.1.4.1-2. AMSU-A1 Data Word Description	4-12
Table 4.1.4.2-1. AMSU-A2 Digital "A" Data Format – Full Scan Mode for NOAA KLM	4-15
Table 4.1.4.2-2. AMSU-A2 Data Word Description	4-17
Table 4.1.4.3-1. AMSU-B Digital "A" Data Format for NOAA KLM	4-20
Table 4.1.4.3-2. Meaning of Variables in Table 4.1.4.3-1	4-26
Table 4.1.3-3. AMSU-B Data Word Description	4-26
Table 4.1.4.4-1. MHS modes	4-29
Table 4.1.4.4-2. MIU AIP Bytes 6 and 7	4-31
Table 4.1.4.4-3. AIP Normal Mode Telemetry Data	4-31
Table 4.1.4.4-4. MIU AIP Bytes 48-97 (Normal Telemetry Mode)	4-32
Table 4.1.4.4-5 MIU AIP Telemetry Bytes 98-101 - Normal Telemetry Mode	4-35
Table 4.1.4.4-6. MIU TIP Telemetry Frame - Normal	4-37
Table 4.1.4.4-7. Science Data Bus telemetry packet types	4-39
Table 4.1.4.4-8. Science Data Packet Fields	4-39
Table 4.1.4.4-9. Format of the Status Word Field	4-39
Table 4.1.4.4-10. Format of Signal Processing Status Field	4-40
Table 4.1.4.4-11. SPE MUX Code Subfield format	4-40
Table 4.1.4.4-12. Receiver Gains Sub Field	4-41
Table 4.1.4.4-13. Science Data Field Format	4-41
Table 4.1.4.4-14. Pixel Subfield Format	4-41
Table 4.1.4.4-15. OBCT Subfield Format	4-42

Table 4.1.4.4-16. Full Housekeeping Telemetry Data Block	4-42
Table 4.1.4.4-17. Raw Current Consumption Data Field Format	4-43
Table 4.1.5.1-1. AIP Minor Frame Format for NOAA KLM	4-45
Table 4.1.5.2-1. AIP Minor Frame Format for NOAA-N, -N'	4-49
Table 4.2.2-1. APT Transmission Characteristics	4-52
Table 4.2.3-1 APT Linearization Algorithm	4-54
Table 4.2.3-2. APT Parameters	4-55
Table 4.3.2-1 DSB Transmission Characteristics	4-58
Table 4.3.2-2 TIP Parameters	4-58
Table 4.3.3.1-1. TIP Minor Frame Format for NOAA KLM	4-59
Table 4.3.3.2-1. TIP Minor Frame format for NOAA-N, -N'	4-63
Table 4.3.4.1.1-1 Digital "A" Status Telemetry	4-70
Table 4.3.4.1.1-2. Digital "A" Status Telemetry (Element 63, Status Words)	4-73
Table 4.3.4.1.2-1 HIRS/4 Digital "A" Data Output Format	4-76
Table 4.3.4.2-1. SEM Digital "A" Telemetry Data Assignment	4-79
Table 4.3.4.2-2. MEPED Digital "A" Data	4-81
Table 4.3.4.2-3. TED Digital "A" Data	4-81
Table 4.3.4.3.1-1. SBUV/2 Data Format Discrete Modes	4-82
Table 4.3.4.3.1-2. SBUV/2 Data Format Discrete Mode Detailed Description	4-84
Table 4.3.4.3.1-3. SBUV/2 Data Discrete Mode Temperature Monitor Description	4-86
Table 4.3.4.3.1-4. SBUV/2 Data Format Discrete Mode Voltage and Current Monitors Description	4-86
Table 4.3.4.3.1-5. SBUV/2 Description of Command Sequence State Monitors	4-87
Table 4.3.4.3.1-6. Data Description of the Electronic Calibration Step Decoding using Timing Monitors and the Retrace Monitor	4-88

Table 4.3.4.3.1-7. SBUV/2 Data Format Discrete Mode Analog Sub-Multiplexer Data Assignment	4-88
Table 7.1.1.1-1. Dual Gain Ranges for the Visible and Near-Infrared Channels of the AVHRR/3 (Nominal Specifications)	7-4
Table 7.3-1. Differences between the AMSU-A and AMSU-B procedures	7-16
Table 7.4.1.1-1. Nominal Values for TED Energy Flux Calibration Factors	7-26
Table 7.5.1.2-1. CDEM Threshold Levels	7-27
Table 7.5.2.1-1. MEPED Telescope Calibrated Geometric Factors	7-28
Table 7.5.2.1-2. MEPED Omnidirectional Sensor Calibrated Geometric Factors	7-29
Table 7.5.2.2-1. MEPED Thresholds and IFC Phase for Measurement	7-30
Table 8.2-1. NOAA Level 1b Data Set Names	8-4
Table 8.3.1.2-1. Format of ARS Header Record	8-8
Table 8.3.1.3.1-1. LAC/HRPT Data Characteristics	8-10
Table 8.3.1.3.2.1-1. Format of LAC/HRPT Data Set Header Record (Version 2, pre-April 28, 2005)	8-11
Table 8.3.1.3.2.2-1. Format of LAC/HRPT Data Set Header Record (Version 5, post-November 14, 2006, all spacecraft)	8-31
Table 8.3.1.3.3.1-1. Format of packed LAC/HRPT Data Sets (Version 2, pre-April 28, 2005)	8-45
Table 8.3.1.3.3.1-2. LAC/HRPT 8-bit Extract Structure	8-56
Table 8.3.1.3.3.1-3. LAC/HRPT 16-bit Extract Structure	8-56
Table 8.3.1.3.3.2-1. Format of LAC/HRPT Data Record for NOAA-N (Version 5, post-November 14, 2006, all spacecraft)	8-57
Table 8.3.1.4.1-1. GAC Data Characteristics	8-69
Table 8.3.1.4.3.1-1. Format of packed GAC Data Record for NOAA KLM (Version 2,	

pre-April 28, 2005)	8-71
Table 8.3.1.4.3.1-2. GAC 8-bit Extract Structure	8-83
Table 8.3.1.4.3.1-3. GAC 16-bit Extract Structure	8-83
Table 8.3.1.4.3.2-1. Format of GAC data record for NOAA-N (Version 4, post-January 24, 2006, all spacecraft)	8-84
Table 8.3.1.5.1.1-1. HIRS/3 Data Characteristics	8-97
Table 8.3.1.5.2.1-1. Format of HIRS/3 Data Set Header Record (Flown on NOAA KLM, version 2, pre-April 28, 2005)	8-98
Table 8.3.1.5.2.2-1. Format of HIRS/4 Data Set Header Record (Flown on NOAA-18, NOAA-19 and Metop series, version 4, post-January 25, 2006)	8-115
Table 8.3.1.5.3.1-1. Format of HIRS/3 Data Record (Version 2, pre-April 28, 2005)	8-142
Table 8.3.1.5.3.2-1. Format of HIRS/4 Data Format (Version 4, post-January 25, 2006, NOAA-18, NOAA-19 and Metop Series)	8-169
Table 8.3.1.6.1-1. AMSU-A Data Characteristics	8-187
Table 8.3.1.6.2.2-1. Format of AMSU-A Data Set Header Record (Version 4, post-January 25, 2006, All Spacecraft)	8-208
Table 8.3.1.6.2.2-1. Format of AMSU-A Data Record Format (Version 4, post-January 25, 2006, All Spacecraft)	8-231
Table 8.3.1.7.1-1. AMSU-B Data Characteristics	8-247
Table 8.3.1.7.2.1-1. Format of AMSU-B Data Set Header Record for NOAA KLM (Version 2, pre-April 28, 2005)	8-247
Table 8.3.1.7.2.2-1. Format of AMSU-B Data Set Header Record for NOAA-N (Version 4, post-January 25, 2006, All Spacecraft)	8-259
Table 8.3.1.7.3.1-1. NOAA KLM Data Record Format (Version 2, pre-April 22, 2005)	8-268
Table 8.3.1.7.3.2-1 NOAA-N Format (Version 4, post-January 25, 2006, NOAA KLM)	8-285

Table 8.3.1.8.2-1. Format of SEM-2 Data Set Header Record	8-296
Table 8.3.1.8.3-1. Format of SEM-2 Data Record	8-301
Table 8.3.1.9.1-1. MHS modes	8-309
Table 8.3.1.9.2-1. MHS Primary Header Record Format	8-310
Table 8.3.1.9.3.1-1. Format of MHS Level 1b Record (Science Packet)	8-321
Table 8.3.1.9.3.2-1. Format of MHS Level 1b Record (Extended Test Data Packet)	8-333
Table 8.3.1.9.3.3-1. Format of MHS Level 1b Record (Extended Memory Data Packet)	8-336
Table 8.3.1.9.3.4-1. Format of MHS Level 1b Record (Unknown Packet)	8-340
Table 9.1-1. Format of the SST Header File	9-2
Table 9.1.1.1-1. Format of the Directory Record for any SST Field Accumulation File	9-6
Table 9.1.1.2-1. Format of the Field Documentation Record	9-7
Table 9.1.1.3-1. Format of the Parameters in the Grid Intersection	9-12
Table 9.1.1.3-2. Format of the Latitudinal Row Identifier	9-13
Table 9.1.2-1. Format of the Block Directory record	9-15
Table 9.1.2-2. Format of Observation Data Record	9-16
Table 9.1.2-3. Format of the Eight Day SST Observation Unit	9-18
Table 9.1.2-4. SST Observation Types	9-19
Table 9.1.2-5. SST Observation Source Codes	9-20
Table 9.1.3-1. Format of Monthly Mean Data Field	9-22
Table 9.2.1-1. General structure of the polar stereographic KLM Master Map File	9-24
Table 9.2.1-2. Format of documentation record for polar stereographic KLM Master Map data	9-25
Table 9.2.2-1. General structure of the Mercator KLM Master Map File	9-29
Table 9.3.1.1-1. Description of the Primary Components 37 Day File (PC37DF) Header	9-31
Table 9.3.1.1-2. Format of Record 1 of a Hemisphere Pair in a Day Bin	9-34

Table 9.3.1.1-3. Format of Record 2 of a Hemisphere Pair of a Day Bin	9-36
Table 9.3.1.1-4. Field Mnemonic for radiation budget monthly mean data	9-37
Table 9.3.1.2-1. Format of Header Record for Monthly/Seasonal/Annual Mean Data	9-38
Table 9.3.1.2-2. Format of Monthly Mean Data Record 1 of a Hemisphere Pair	9-40
Table 9.3.1.2-3. Format of Monthly Mean Data Record 2 of a Hemisphere Pair	9-41
Table 9.3.1.3-1. Format of Seasonal/Annual Mean Data Record 1 of a Hemisphere Pair	9-42
Table 9.3.1.3-2. Format of Seasonal/Annual Mean Data Record 2 of a Hemisphere Pair	9-42
Table 9.4.1.1-1. Format of header record for ATOVS retrieval data file	9-45
Table 9.4.1.1-2. Format of ATOVS Retrieval Data Record	9-46
Table 9.4.1.1-3. Geographical Bins for ATOVS	9-52
Table 9.4.1.2-1. Format of Metadata Archive Header Record	9-54
Table 9.4.1.2-2. Format of Data Record 1 of Metadata archive file	9-54
Table 9.4.1.2-3. Format of Data Record 2 of Metadata archive file	9-55
Table 9.4.1.2-4. Format of Data Record 3 of Metadata archive file	9-56
Table 9.4.1.2-5. Format of Data Record 4 of Metadata archive file	9-57
Table 9.4.1.3-1. Format of Header Record for Radiosonde Matchup File	9-58
Table 9.4.1.3-2. Format of Class Header Record for Radiosonde Matchup File	9-59
Table 9.4.1.3-3. Format of Data Records for the Radiosonde Matchup File	9-60
Table 9.4.2-1. Header Record Format of Orbit Archive File	9-71
Table 9.4.2-2. Format of Orbit Archive File Retrieval Data Records	9-72
Table 9.4.2.1-1. Format of the Header Record of the AMSU-B Metadata Archive File.	9-75
Table 9.4.2.1-2. Format of AMSU-B Metadata Archive File, Data Record A (Mixing Ratios) (15,4,6)	9-75
Table 9.4.2.1-3. Format of AMSU-B Metadata Archive File, Data Record B (Brightness Temperatures) (5,4,6)	9-76

Table 9.4.2.2-1. Format of Header record for AMSU-B Radiosonde Match Archive File	9-77
Table 9.4.2.2-2. Format of Data record for AMSU-B Radiosonde Match Archive File	9-78
Table 9.5-1. CoastWatch Region Specifications	9-87
Table 9.6.3-1. Comparison of Microwave Sensors	9-95
Table 9.6.3-2. AMSU-A and -B Products	9-97
Table 9.6.3-3. Difference between Day-1 and Day-2 Files	9-99
Table 9.6.3-4. AMSU-A HDF-EOS Swath: NPR.AAOP files on DDS	9-100
Table 9.6.3-5. AMSU-A HDF-EOS Swath Attributes	9-102
Table 9.6.3-6. Format of AMSU-B HDF-EOS Swath: NPR.ABOP files on DDS	9-103
Table 9.6.3-7. AMSU-B HDF-EOS Swath Attributes	9-104
Table 9.6.3-8. AMSU-B HDF-EOS PS Grid: NPR.ABMP files on DDS	9-105
Table 9.6.3-9. Product Error Flags	9-106
Table 9.6.4-1 POES and METOP Deliverables	9-107
Table 9.6.4.2-1 Dynamic Metadata	9-111
Table 9.6.4.3-1. MIRS HDF-EOS Sounding Swath Attributes	9-113
Table 9.6.4.3-2. MIRS HDF-EOS Sounding Swath Data Fields	9-113
Table 9.6.4.3-3: MIRS Image Swath Attributes	9-115
Table 9.6.4.3-4: MIRS Image Swath Data Fields	9-115
Table 9.7.1.2.7-1. 1b Data Set Instrument Status and Data Quality Flags	9-123
Table 9.7.1.2.9-1. Fill Values on Data Records	9-125
Table 9.7.1.3-1. Daily 1b Standard Header Record Data Set Order	9-126
Table 9.7.1.4-0. List of Tables in 1b Data Set	9-129
Table 9.7.1.4-1. SBUV Level 1b Data Set Record Layouts	9-131
Table 9.7.1.4-2. Byte/bit Breakdown of NESDIS Orbital Header Data	9-132
Table 9.7.1.4-3. Ancillary Data Spectral Information Data Record	9-133

Table 9.7.1.4-4. Ancillary Data Multiple Scattering Coefficients Data Record	9-134
Table 9.7.1.4-5. Ancillary Data Total Ozone Tables Data Record	9-134
Table 9.7.1.4-6. Ancillary Data A Priori Information Data Record	9-134
Table 9.7.1.4-7. Prelaunch Calibration Data Record	9-135
Table 9.7.1.4-8. Day 1 Solar Flux Data Record	9-135
Table 9.7.1.4-9. Interrange Ratios Data Record	9-136
Table 9.7.1.4-10. Albedo Correction Factor Data Record	9-136
Table 9.7.1.4-11. SBUV/2 Orbital Header Record	9-137
Table 9.7.1.4-12. Discrete Data Record	9-137
Table 9.7.1.4-13. Sweep Data Record Data Identification, Attitude, Earth Location Data	
Digital B and Status Flags	9-140
Table 9.7.1.4-14. Byte/bit Breakdown of Discrete Data	9-141
Table 9.7.1.4-15. Byte/bit Breakdown of Discrete/Sweep Data	9-141
Table 9.7.1.4-16. Byte/bit Breakdown of Discrete Data	9-142
Table 9.7.1.4-17. Byte/bit Breakdown of Discrete/Sweep Data	9-143
Table 9.7.1.4-18. Byte/bit Breakdown of Sweep Data	9-144
Table 9.7.1.4-19. SBUV/2 Orbital Statistical Record	9-145
Table 9.7.1.4-20. SBUV/2 Daily Statistical Record	9-146
Table 9.7.1.5-1. Digital A Subcom Housing Channels	9-148
Table 9.7.1.5-2. Analog Telemetry Points	9-150
Table 9.7.2.2-1. PMF Record Layout for Day.(Version 6)	9-152
Table 9.7.2.2-2. Ozone Pressure Levels	9-154
Table 9.7.2.2-3. Ozone Pressure Layers and Levels (Version 6)	9-156
Table 9.7.2.2-4. PMF Orbital Header Record. (Version 6)	9-158
Table 9.7.2.2-4. PMF Data Record.(Version 6)	9-159

Table 9.7.2.2-6. PMF Orbital Trailer Record. (Version 6)	9-162
Table 9.7.2.2-7. PMF Daily Trailer Record.(Version 6)	9-162
Table 9.7.2.2-5. SBUV/2 Ozone - Product Master File (PMF) BUFR Words. (Version 6)	9-163
Table 9.7.2.2-9 Version 8 Header Record I layout	9-176
Table 9.7.2.2-10 Version 8 Header record II layout	9-177
Table 9.7.2.2-11 Version 8 Data record layout	9-177
Table 9.7.2.2.12 Version 8 Trailer record layout	9-180
Table 9.7.2.2-13 BUFR input table	9-181
Table 9.7.3-1. OOPS Standard Header Record I	9-184
Table 9.7.3-2. OOPS Standard Header Record II	9-185
Table 9.8.1.2-1. Aerosol Daily Summary Directory Record Format	9-215
Table .8.1.3-1. Aerosol Daily Summary File Documentation Record Format	9-216
Table 9.8.2.2-1. Documentation Record Format for Aerosol Weekly 100 km Field File	9-217
Table 9.8.2.3-1. Format of Grid Intersection in Data Record	9-221
Table 9.8.2.3-2. Row Identification Information	9-223
Table 9.8.3.2-1. Header Record Format	9-229
Table 9.8.3.3-1. Grid intersection format	9-229
Table 9.8.4.2-1. Format of Directory Record	9-231
Table 9.8.4.3-1. Data Record Format	9-231
Table 9.8.4.4-1. Satellite Aerosol/SST Observation Format	9-233
Table 9.8.4.4-2. Aerosol/SST Observation Type Codes	9-235
Table 9.8.4.4-3. Aerosol/SST Observation Source Codes	9-235
Table 9.8.5.2-1. Directory Record Format	9-236
Table A-1. Code Symbols for Heading and Parts I-III	A-3
Table A-2. Satellite Identifier in TBUS Bulletins	A-3

Table A.3-1. Explanation of Code Symbols	A-7
Table A.3-2. Part IV Code Symbols	A-9
Table A.5-1. Decoding Exercise of Sample APT Predict (TBUS) Bulletin from Section A.4.	A-12
Table A.6-1. Format of Standard Two-Line Orbital Element Set	A-17
Table A.6-2. Definition of Satellite ID and International Designator	A-17
Table A.7-1. Example of Decoded Two-Line Orbital Element Message	A-18
Table C-1. Subroutines IJTOLL and LLTOIJ Argument list	C-1
Table D-1. POES Program Instrument Utilization Status	D-1
D-2. MetOp Program Instrument Utilization Status	D-2
Table D.1-1. Measured Channel Characteristics for NOAA-15 AMSU-A and AMSU-B	D-3
Table D.1-2. NOAA-15 IWT PRT Count to Temperature Coefficients for HIRS/3	D-4
Table D.1-3. NOAA-15 HIRS/3 Channel 20 Slope and Intercept (Albedo %)	D-4
Table D.1-4. NOAA-15 HIRS/3 Central Wave Numbers and Band Correction Coefficients	D-6
Table D.1-5. Normalized Response Functions for the NOAA-15 HIRS/3 Thermal Channels	D-6
Table D.1-6. NOAA-15 AVHRR/3 Pre-launch Calibration Coefficients (Albedo Representation)	D-10
Table D.1-7. NOAA-15 AVHRR/3 Visible Channel Information	D-10
Table D.1-8. NOAA-15 AVHRR/3 Conversion Coefficients	D-11
Table D.1-9. NOAA-15 PRT Weighting Factors	D-11
Table D.1-10. Summary of NOAA-15 AVHRR Spectral Response Data (as a Function of Wavenumber) for Each Channel	D-11
Table D.1-11. NOAA-15 AVHRR/3 Thermal Channel Temperature to Radiance	

Coefficients	D-18
Table D.1-12. NOAA-15 AVHRR/3 Spectral Response Values for Channels 1, 2 and 3A	D-25
Table D.1-13. NOAA-15 AVHRR/3 Spectral Response Values for Channels 3B, 4 and 5	D-31
Table D.1-14. NOAA-15 Radiance of Space and Coefficients for Nonlinear Radiance Correction Quadratic	D-37
Table D.1-15. NOAA-15 AMSU PRT Temperature Conversion Coefficients	D-38
Table D.1-16. NOAA-15 HIRS/302 Secondary Telescope Temperature Coefficients (K)	D-39
Table D.2-1. Measured Channel Characteristics for NOAA-16 AMSU-A and AMSU-B	D-40
Table D.2-2. NOAA-16 IWT PRT Count to Temperature Coefficients for HIRS/301	D-41
Table D.2-3. NOAA-16 HIRS/301 Channel 20 Slope and Intercept (Albedo %)	D-42
Table D.2-4. NOAA-16 HIRS/301 Central Wave Numbers and Band Correction Coefficients	D-42
Table D.2-5. NOAA-16 HIRS/301 Secondary Telescope Temperature Coefficients	D-42
Table D.2-6. Normalized Response Functions for the NOAA-16 HIRS/301 Thermal Channels	D-43
Table D.2-7. NOAA-16 AVHRR/3 Pre-launch Calibration Coefficients (Albedo Representation)	D-82
Table D.2-8. NOAA-16 AVHRR/3 Visible Channel Information	D-83
Table D.2-9. NOAA-16 AVHRR/3 Conversion Coefficients	D-84
Table D.2-10. NOAA-16 PRT Weighting Factors	D-84
Table D.2-11. Summary of NOAA-16 AVHRR Spectral Response Data (as a Function of Wavenumber) for Each Channel	D-84
Table D.2-12. NOAA-16 AVHRR/3 Thermal Channel Radiance-to-Temperature Coefficients	D-92

Table D.2-13. NOAA-16 AVHRR/3 Spectral Response Values for Channels 1, 2 and 3A	D-98
Table D.2-14. NOAA-16 AVHRR/3 Spectral Response Values for Channels 3B, 4 and 5	D-104
Table D.2-15. NOAA-16 Radiance of Space and Coefficients for Nonlinear Radiance Correction Quadratic	D-110
Table D.2-16. NOAA-16 AMSU PRT Temperature Conversion Coefficients	D-110
Table D.3-1. NOAA-17 PRT Weighting Factors	D-112
Table D.3-2. NOAA-17 Radiance of Space and Coefficients for Nonlinear Radiance Correction Quadratic	D-112
Table D.3-3. NOAA-17 AVHRR/3 Conversion Coefficients	D-113
Table D.3-4. NOAA-17 AVHRR/3 Pre-launch Calibration Coefficients (Albedo Representation)	D-113
Table D.3-5. Summary of NOAA-17 AVHRR Spectral Response Data (as a Function of Wavenumber) for Each Channel	D-113
Table D.3-6. NOAA-17 AVHRR/3 Visible Channel Information	D-118
Table D.3-7. NOAA-17 AVHRR/3 Thermal Channel Temperature-to-Radiance Coefficients	D-118
Table D.3-8. NOAA-17 AVHRR/3 Spectral Response Values for Channels 1, 2 and 3A	D-119
Table D.3-9. NOAA-17 AVHRR/3 Spectral Response Values for Channels 3B, 4 and 5	D-125
Table D.3-10. NOAA-17 HIRS/303 Central Wave Numbers (vc) and Band Correction Coefficients (b and c)	D-137
Table D.3-11. NOAA-17 IWT PRT Count to Temperature Coefficients for HIRS/3	D-137
Table D.3-12. NOAA-17 HIRS/303 Secondary Telescope Temperature Coefficients	D-137
Table D.3-13. Normalized Response Functions for the NOAA-17 HIRS/3 Thermal Channels	D-138

Table D.3-14. NOAA-17 HIRS/3 Channel 20 Slope and Intercept (Albedo %)	D-177
Table D.3-15. NOAA-17 AMSU PRT Temperature Conversion Coefficients	D-178
Table D.3-16. Measured Channel Characteristics for NOAA-17 AMSU-A and AMSU-B	D-179
Table D.4-1. NOAA-18 PRT Weighting Factors	D-180
Table D.4-2. NOAA-18 Radiance of Space and Coefficients for Nonlinear Radiance Correction Quadratic	D-180
Table D.4-3. NOAA-18 AVHRR/3 Conversion Coefficients	D-180
Table D.4-4. NOAA-18 AVHRR/3 Pre-launch Calibration Coefficients (Albedo Representation)	D-181
Table D.4-5. Summary of NOAA-18 AVHRR Spectral Response Data (as a Function of Wavenumber) for Each Channel	D-181
Table D.4-6. NOAA-18 AVHRR/3 Solar Reflectance Channel Information	D-186
Table D.4-7. NOAA-18 AVHRR/3 Thermal Channel Temperature-to-Radiance Coefficients	D-186
Table D.4-8. NOAA-18 AVHRR/3 Spectral Response Values for Channels 1, 2 and 3A	D-186
Table D.4-9. NOAA-18 AVHRR/3 Spectral Response Values for Channels 3B, 4 and 5	D-193
Table D.4-10. NOAA-18 HIRS (H305) Central Wave Numbers (vC), Half power Bandwidth and Band Correction Coefficients (b and c)	D-205
Table D.4-11. NOAA-18 IWT PRT Count to Temperature Coefficients for HIRS/305	D-205
Table D.4-12. NOAA-17 HIRS/305 Primary, Secondary and Tertiary Telescope Temperature Coefficients	D-206
Table D.4-13. Normalized Response Functions for the NOAA-18 HIRS H305 Thermal Channels	D-206
Table D.4-14. NOAA-18 HIRS/305 Channel 20 Slope and Intercept (Albedo %)	D-478

Table D.4-15. N-18 AMSU-A1 (S/N 109, ID=33) PRT Temperature Conversion Coefficients	D-478
Table D.4-16. N-18 AMSU-A2 (S/N 105, ID=18) PRT Temperature Conversion Coefficients	D-481
Table D.4-17. N-18 AMSU-A Measured Channel Characteristics	D-481
Table D.4-18. N-18 MHS Coefficients for Converting PRT Resistance (ohms) to PRT Temperature (K)	D-482
Table D.4-19. N-18 MHS Resistances (ohms) for Three PRT Calibration Channels	D-482
Table D.4-20. N-18 MHS Coefficients for Converting Counts into Temperatures (K)	D-482
Table D.4-21. N-18 MHS Coefficients for Converting Counts into Current (amps) for Current Monitors	D-483
Table D.4-22. N-18 MHS Coefficients for Converting Volts into Temperatures (K)	D-483
Table D.4-23. N-18 MHS Values of the Nonlinearity Parameters u ($m^2\text{-sr-cm}^{-1}$)/mW	D-483
Table D.4-24. N-18 MHS Wavenumbers and Band-correction Factors	D-484
Table D.4-25. N-18 MHS (PFM, S/N=101) Channel IF Characteristics	D-484
Table D.5-1. MetOp-A PRT Weighting Factors	D-485
Table D.5-2. MetOp-A Radiance of Space and Coefficients for Nonlinear Radiance Correction Quadratic	D-485
Table D.5-3. MetOp-A AVHRR/3 Conversion Coefficients	D-485
Table D.5-4. MetOp-A AVHRR/3 Pre-launch Calibration Coefficients (Albedo Representation)	D-485
Table D.5-5. Summary of MetOp-A AVHRR Spectral Response Data (as a Function of Wavenumber) for Each Channel	D-486
Table D.5-6. MetOp-A AVHRR/3 Solar Reflectance Channel Information	D-490
Table D.5-7. MetOp-A AVHRR/3 Thermal Channel Temperature-to-Radiance	

Coefficients	D-490
Table D.5-8. MetOp-A AVHRR/3 Spectral Response Values for Channels 1, 2 and 3A	D-491
Table D.5-9. MetOp-A AVHRR/3 Spectral Response Values for Channels 3B, 4 and 5	D-497
Table D.5-10. MetOp-A HIRS (H306) Central Wave Numbers (ν_C), Half Power Bandwidth and Band Correction Coefficients (b and c)	D-507
Table D.5-11. MetOp-A IWT PRT Count to Temperature Coefficients for HIRS/306	D-511
Table D.5-12. MetOp-A HIRS/306 Primary, Secondary and Tertiary Telescope Temp (C)	D-511
Table D.5-13. Normalized Response Functions for the MetOp-A HIRS H306 Thermal Channels	D-512
Table D.5-14. MetOp-A HIRS/306 Channel 20 Slope and Intercept (Albedo %)	D-768
Table D.5-15. MetOp-A AMSU-A1 (S/N 106, ID=XX) PRT Temperature Conversion Coefficients	D-768
Table D.5-16. MetOp-A AMSU-A2 (S/N 105, ID=18) PRT Temperature Conversion Coefficients	D-769
Table D.5-17. MetOp-A AMSU-A Measured Channel Characteristics	D-770
Table D.5-18. MetOp-A MHS Coefficients for Converting PRT Resistance (Ohms) to PRT Temperature (K)	D-770
Table D.5-19. MetOp-A MHS Resistances (Ohms) for Three PRT Calibration Channels	D-771
Table D.5-20. MetOp-A MHS Coefficients for Converting Counts into Temperatures (K)	D-771
Table D.5-21. MetOp-A MHS Coefficients for Converting Counts into Current (amps) For Current Monitors	D-771
Table D.5-22. MetOp-A MHS Coefficients for Converting Volts into Temperatures (K)	D-771
Table D.5-23. MetOp-A MHS Values of the Nonlinearity Parameters $\mu(m^2\text{-sr-cm}^{-1})/mW$	D-771
Table D.5-24. MetOp-A MHS Wavenumbers and Band-Correction Factors	D-772
Table D.5-25. MetOp-A MHS (PFM, S/N=103) Channel IF Characteristics	D-772

Table D.6-1. NOAA-19 PRT Weighting Factors	D-773
Table D.6-2. NOAA-19 Radiance of Space and Coefficients for Nonlinear Radiance Correction Quadratic	D-773
Table D.6-3. NOAA-19 AVHRR/3 Conversion Coefficients	D-773
Table D.6-4. NOAA-19 AVHRR/3 Pre-launch Calibration Coefficients (Albedo Representation)	D-774
Table D.6-5. Summary of NOAA-19 AVHRR Spectral Response Data (as a Function of Wavenumber) for Each Channel	D-774
Table D.6-6. NOAA-19 AVHRR/3 Solar Reflectance Channel Information	D-779
Table D.6-7. NOAA-19 AVHRR/3 Thermal Channel Temperature-to-Radiance Coefficients	D-779
Table D.6-8. NOAA-19 AVHRR/3 Spectral Response Values for Channels 1, 2 and 3A	D-779
Table D.6-9. NOAA-19 AVHRR/3 Spectral Response Values for Channels 3B, 4 and 5	D-786
Table D.6-10. NOAA-19 HIRS (H308) Central Wave Numbers (vC), Half power Bandwidth and Band Correction Coefficients (b and c)	D-798
Table D.6-11. NOAA-19 IWT PRT Count to Temperature Coefficients for HIRS/308	D-798
Table D.6-12. NOAA-19 HIRS/308 Primary, Secondary and Tertiary Telescope Temperature Coefficients	D-799
Table D.6-13. Normalized Response Functions for the NOAA-19 HIRS H308 Thermal Channels	D-799
Table D.6-14. NOAA-19 HIRS/308 Channel 20 Slope and Intercept (Albedo %)	D-1054
Table D.6-15. NOAA-19 AMSU-A1 (S/N 109, ID=33) PRT Temperature Conversion Coefficients	D-1055
Table D.6-16. N-19 AMSU-A2 (S/N 109, ID=34) PRT Temperature Conversion Coefficients	D-1056

Table D.6-17. NOAA-19 AMSU-A Measured Channel Characteristics	D-1056
Table D.6-18. NOAA-19 MHS Coefficients for Converting PRT Resistance (ohms) to PRT Temperature (K)	D-1057
Table D.6-19. NOAA-19 MHS Resistances (ohms) for Three PRT Calibration Channels	D-1057
Table D.6-20. NOAA-19 MHS Coefficients for Converting Counts into Temperatures(K)	D-1057
Table D.6-21. NOAA-19 MHS Coefficients for Converting Counts into Current (amps) for Current Monitors	D-1058
Table D.6-22. NOAA-19 MHS Coefficients for Converting Volts into Temperatures (K)	D-1058
Table D.6-23. N-19 MHS Values of the Nonlinearity Parameters u ($m^2\text{-sr-cm}^{-1}$)/mW	D-1058
Table D.6-24. NOAA-19 MHS Wavenumbers and Band-correction Factors	D-1058
Table D.6-25. NOAA-19 MHS (PFM, S/N=101) Channel IF Characteristics	D-1059
Table D.7-1. MetOp-B PRT Weighting Factors	D-1059
Table D.7-2. MetOp-B Radiance of Space and Coefficients for Nonlinear Radiance Correction Quadratic	D-1059
Table D.7-3. MetOp-B AVHRR/3 Conversion Coefficients	D-1060
Table D.7-4. MetOp-B AVHRR/3 Pre-launch Calibration Coefficients (Albedo Representation)	D-1060
Table D.7-5. Summary of MetOp-B AVHRR Spectral Response Data (as a Function of Wavenumber) for Each Channel	D-1060
Table D.7-6. MetOp-B AVHRR/3 Solar Reflectance Channel Information	D-1061
Table D.7-7. MetOp-B AVHRR/3 Thermal Channel Temperature-to-Radiance Coefficients	D-1061
Table D.7-8. MetOp-B AVHRR/3 Spectral Response Values for Channels 1, 2 and 3A	D-1062
Table D.7-9. MetOp-B AVHRR/3 Spectral Response Values for Channels 3B, 4 and 5	D-1068
Table D.7-10. MetOp-B HIRS (H307) Central Wave Numbers (ν_C), Half Power	

Bandwidth and Band Correction Coefficients (b and c)	D-1080
Table D.7-11. MetOp-B IWT PRT Count to Temperature Coefficients for HIRS/307	D-1080
Table D.7-12. MetOp-B HIRS/307 Primary, Secondary and Tertiary Telescope Temp (C)	D-1081
Table D.7-13. Normalized Response Functions for the MetOp-B HIRS H307 Thermal Channels	D-1081
Table D.7-14. MetOp-B HIRS/307 Channel 20 Slope and Intercept (Albedo %)	D-1441
Table D.7-15. MetOp-B AMSU-A1 (S/N 108, ID=XX) PRT Temperature Conversion Coefficients	D-1441
Table D.7-16. MetOp-B AMSU-A2 (S/N 106, ID=XX) PRT Temperature Conversion Coefficients	D-1442
Table D.7-17. MetOp-B AMSU-A Measured Channel Characteristics	D-1443
Table D.7-18. MetOp-B MHS Coefficients for Converting PRT Resistance (Ohms) to PRT Temperature (K)	D-1443
Table D.7-19. MetOp-B MHS Resistances (Ohms) for Three PRT Calibration Channels	D-1444
Table D.7-20. MetOp-B MHS Coefficients for Converting Counts into Temperatures (K)	D-1444
Table D.7-21. MetOp-B MHS Coefficients for Converting Counts into Current (amps) For Current Monitors	D-1444
Table D.7-22. MetOp-B MHS Coefficients for Converting Volts into Temperatures (K)	D-1444
Table D.7-23. MetOp-B MHS Values of the Nonlinearity Parameters $\mu(m^2-sr-cm^{-1})/mW$	D-1444
Table D.7-24. MetOp-B MHS Wavenumbers and Band-Correction Factors	D-1445
Table D.7-25. MetOp-B MHS (PFM, S/N=103) Channel IF Characteristics	D-1445
Table G.1-1. Comparison of Error in the HIRS/3 Channels Resulting from Incorrect Generation of In-flight Thermal Calibration Coefficients	G-3
Table G.1-2. List of Datasets that Were Resynched with the AVHRR on NOAA-15	G-10
Table G.1-3 RMS Differences between temperature coefficients and temperatures	

produced from the incorrect coefficients	G-23
Table G.1-4 New NOAA-16 AVHRR A301 visible Channel Calibration Coefficients	G-23
Table G.1-5 Channel 3B RMS temperature differences (in K) between datasets using the old and new Planck constant values	G-32
Table J-1. Satellite Scanning Instrument Parameters for TIROS-N through NOAA-14	J-1
Table J-2. NOAA Satellite Scanning Instrument Parameters for NOAA KLM and NOAA-N, N'	J-3
Table J.3-1. Synopsis of Microwave Scan Initiation and FOV Information	J-13
Table M-1. NOAA-15 RFI Coefficients for AMSU-B	M-2
Table M-2. NOAA-17 RFI Coefficients for AMSU-B	M-2
Table M.8-1. Location of Transmitter Power in Spacecraft Telemetry	M-9
Table M.9-1. AMSU-B Bias Corrections for NOAA-15 (as of 22 Sept 1998).	M-9
Table M.9-2. AMSU-B Bias Corrections for NOAA-15 (as of 28 Sept 1999)	M-12
Table M.9-3. AMSU-B Bias Corrections for NOAA-15 Version 1.7 (11 Nov 1999)	M-14
Table M.9-4. AMSU-B Bias Corrections for NOAA-15, Version 1.8 (10 January 2000)	M-20
Table M.9-5. AMSU-B Bias Corrections for NOAA-15, Version 1.9 (4 May 2000)	M-22
Table M.9-6. AMSU-B Bias Corrections for NOAA-15, Version 2.0 (10 July 2000)	M-23
Table M.9-7. AMSU-B Bias Corrections for NOAA-15, Version 2.1 (9 November 2000)	M-24
Table M.9-8. AMSU-B Bias Corrections for NOAA-15, Version 2.2 (4 December 2000)	M-25
Table M.9-9. AMSU-B Bias Corrections for NOAA-15, Version 2.3 (6 March 2001)	M-26
Table M.9-10. AMSU-B RFI Corrections for NOAA-17, Version 1.0 (12 July 2002)	M-27
Table M.9-11. AMSU-B RFI Corrections for NOAA-15, Version 2.4 (13 Aug. 2004)	M-29

NOAA-N, -N Prime Supplement

Below is a summary of format changes for the NOAA-N and N Prime spacecrafts.

When NOAA-N (NOAA-18) was launched a number of changes were made to the data formats; necessitated by the replacement of AMSU-B with the Microwave Humidity Sounder (MHS), the replacement of HIRS/3 with HIRS/4, and changes in the direct readout formats. All effort was made to keep the changes to a minimum.

These changes to the NOAA Level 1b formats were implemented on January 25, 2005, and was applied to all satellite (NOAA-15, -16, -17, and 18) from that date forward. The format changes were known as version 3.

Part of the updates to the NOAA-N and N Prime Level 1b formats is the inclusion of additional or secondary header records. These header records contain ancillary dataset names and any metadata needed for data reprocessing. Software applications should use the "Count of Header Records in the Data Set" field, located in the first or primary header record to calculate the position of the first data record and skip the secondary header records.

The following sections in the NOAA KLM User's Guide provide the user with detailed information on the specific changes.

1) Microwave Humidity Sounder (MHS) instrument replaced the AMSU-B

Section 3.9 describes the MHS instrument

Section 7.6 describes calibration procedures for MHS

Section 8.3.1.9 describes the MHS Level 1b format

2) HIRS/4 instead of HIRS/3 instrument

Section 3.2 (originally describing HIRS/3 only) has been modified to accommodate HIRS/4 description.

Section 8.3.1.5 describes the Level 1b data set structure for HIRS/3 and HIRS/4.

3) AVHRR changes

Section 8.3.1.1 describes the Level 1b data set structure.

Section 8.3.1.3 describes the AVHRR/3 Level 1b dataset format for LAC/HRPT.

Section 8.3.1.4 describes the AVHRR/3 Level 1b dataset format for GAC.

4) Advanced DCS (A-DCS) changes

Section 3.6 (originally describing DCS) has been modified to include A-DCS for NOAA-N Prime.

5) Direct Readout formats

Section 4.1.2 describes the transmitter frequency and website which provides latest information on individual POES spacecraft.

Section 4.1.3.2 describes the HRPT Minor frame format for NOAA-N,-N Prime

1.0 INTRODUCTION TO THE NOAA KLM SYSTEM

The National Oceanic and Atmospheric Administration (NOAA) and the National Aeronautics and Space Administration (NASA) jointly administer the civilian polar orbiting spacecraft system for the United States. Upon successful achievement of orbit, NASA conducts an engineering evaluation and checkout of each satellite. During the instrument turn-on checkout period, the NASA team directs the satellite, and obtains and analyzes engineering data necessary to the evaluation. Upon completion of testing, the satellite is turned over to NOAA for routine operational control.

In the Spring of 1998, a new series of NOAA Polar Operational Environmental Satellites (POES) commenced with the launch of NOAA-K (NOAA-15) and ended with NOAA-N Prime (NOAA-19). This series, represented an improvement over the previous series of NOAA polar-orbiting satellites which began with TIROS-N (launched in October 1978), and continued with NOAA-6 through NOAA-14 (launched in December 1994).

In order to eliminate redundancy for NOAA's POES satellite data users, the documents *NOAA Polar Orbiter Data User's Guide*, the *NOAA Technical Memorandum NESS 95 (The TIROS-N, NOAA A-G Satellite Series)*, the *NOAA Technical Memorandum NESS 107 (Data Extraction and Calibration of TIROS-N/NOAA Radiometers)* and the *TIROS-N Series Direct Readout Services Users Guide* were combined into one document. The contents of this document, originally titled *NOAA KLM User's Guide* include information to the NOAA-K, -L, -M system with additions made as newer satellites were launched, namely, NOAA-N and NOAA-N Prime and the European Metop satellites, Metop-1 and Metop-2. These also carry the AVHRR and ATOVS instruments. The information within this document include descriptions of the spacecraft characteristics, orbital considerations, sensor package, calibration, and formats for Level 1b data and selected operational products. Due to limited resources in maintaining this large document over the years some of the information that is deemed not contingent to the understanding of the data and products themselves remains in its original form. This includes tracking procedures to acquire data from real-time transmission, systems sensors, ingest and preprocessing. Questions related to any information within this document should be directed to NCDC.satorder@noaa.gov.

1.1 THE NOAA KLM CONCEPT

The NOAA KLM POES satellites began a new era of improved environmental monitoring in support of NOAA missions. The instrument payload has significant improvements and additions/deletions. The instrument changes have affected the spacecraft subsystems and data formats.

The NOAA KLM satellites include improvements to instruments that are evolutionary and significant. The initial concept was to add more passive microwave instruments and channels in place of the four channel Microwave Sounding Unit (MSU) and the three channel Stratospheric Sounding Unit (SSU). During the satellite system design process, it became evident that the increased size, fields of view, and power requirements for the new instruments would have significant impacts on the spacecraft power, data handling, and attitude control systems. The NOAA KLM spacecraft were significantly heavier than previous spacecraft (2231.7 kg versus 1712.3) and required a more powerful Apogee Kick Motor (AKM) solid rocket booster and expendable launch vehicle, TITAN-II, to obtain orbit. Combined with command system security and frequency changes, NOAA KLM satellites look very much like previous satellites to the casual observer, but have significant changes to essentially every subsystem. To meet the

increased power requirements, two additional solar panels have been added and the solar array has about 45% more output. The batteries, propulsion tank capacity, the size of the reaction wheels and magnetic coils used for momentum unloading and attitude control have also increased in capacity. The spacecraft structure has been stiffened primarily to support the heavier AMSU instruments and improve launch vehicle load margins. Several antennas have been relocated and/or built with new materials and processes to improve performance. Flight computer memory has been doubled and the flight software modified to meet new requirements.

The Advanced Microwave Sounding Units (AMSU-A1, AMSU-A2, and AMSU-B) are state-of-the-art passive microwave sounders that will significantly enhance NOAA's atmospheric sounding and non-sounding products suite. AMSU is expected to improve global sounding (especially in the presence of clouds), water vapor profiles and information on precipitation and ice. The AMSU instruments have better spatial resolution and upper atmospheric sounding capabilities than the previous MSU instrument flown on the TIROS-N series.

The Advanced Very High Resolution Radiometer (AVHRR/3) provides spectral and gain changes to the visible channels that will allow improved low energy/light detection and adds a sixth channel, called 3A, at 1.6 microns for improved snow and ice discrimination. Scan mechanism lifetime and jitter performance have been improved with changes to lubricants, motors and bearings. A fairly large external sun shield has been added to the AVHRR/3 scan motor housing to reduce sunlight impingement and associated calibration problems that have been briefly observed during some prior missions. Channel 3A will be time shared with the previous 3.7 micron channel, now called channel 3B.

The first half of the dynamic range for AVHRR/3 channels 1 and 2 represents 0 to 25% albedo while channel 3A has the first half of its dynamic range used for detection of albedo level changes from 0 to 12.5% albedo. These are referred to as dual slope or split gains. Previous AVHRR instruments used one linear calibration equation for each visible channel and now two are required for each visible channel. NOAA will be monitoring the dual slopes of the ramp calibrations more closely to assure that the linearity of the electronics and inflection points for the dual slopes do not change as the instrument ages or with other factors such as temperature, orbital or seasonal effects. The new visible channel ramp calibrations do not use the full dynamic range as was done previously and have been observed to change slightly as the instrument temperature changes.

The Automatic Picture Transmission (APT) user sees channel 3B as channel 6 using the wedge six grey scale modulation index.

The AMSU instruments required the addition of a new spacecraft data processing box called the AMSU Information Processor (AIP) and changes to the High Resolution Picture Transmission (HRPT), Local Area Coverage (LAC), and Global Area Coverage (GAC) formats to accommodate the new AMSU data. The AIP receives data from AMSU-A1, AMSU-A2, and AMSU-B at a combined data rate of 7.2 kbps and from the TIROS Information Processor (TIP) at 8.32 kbps. The AIP generates three data streams: (1) AMSU data only which is sent to the MIRP for merging into HRPT, Local Area Coverage (LAC) or recorded HRPT, and Global Area Coverage (GAC); (2) combined AMSU/TIP sent to the spacecraft Cross-Strap Unit (XSU) for tape recording if needed; (3) AMSU/TIP for direct transmission from the XSU. The HRPT is still broadcast at the old data rate of 665.5 kbps with the new AMSU data replacing what were previously spare words. Note that if the non-redundant MIRP was to fail, it would still be possible for NOAA to obtain global sounding data. Also note that Direct Sounder Broadcast (DSB) of TIP data does not include AMSU data. DSB users will have access to HIRS/3, DCS-2, SEM-2, and SBUV/2 data as defined in the new TIP format. Most of the previously used or spare TIP words now contain DCS-2 data to satisfy the growing needs of Data Collection System (DCS) users.

The High Resolution Infrared Radiation Sounder (HIRS/3) has spectral channel changes that were made primarily to improve soundings and to be congruent with the specifications developed for the GOES-I through -M Sounders. The HIRS/3 cooler set point was decreased to approximately 100K which will improve the two infrared detectors' performance. The HIRS/3 scan profile was also changed to eliminate the viewing of the second/cold blackbody internal calibration target from the automatic calibration sequence and to use the additional time to perform another scan (38 total scans per calibration sequence) of the earth. It was cost effective to leave the second calibration target in the instrument and leave its viewing as a commandable option. The HIRS/3 instrument has been improved for longer lifetime and produces lower noise levels (better NEDN performance).

The Space Environment Monitor (SEM-2) has improved calibration and particle detection capabilities. The Total Energy Detector (TED) measures to a lower energy of 0.05 KeV and the TED integral F (ALPHA) has two ranges of 0.05 to 1 and 1 to 20 KeV. The Medium Energy Proton and Electron Detector (MEPED) has a fourth Omni directional proton measure at 140 MEV. The MEPED has a new fixed mounting on the spacecraft and the TED has also been relocated to maximize particle detection abilities.

The Solar Backscatter Ultra Violet Spectral Radiometer (SBUV/2) has undergone relatively modest improvements. Its Programmable Read Only Memory (PROM) will be changed to a Random Access Memory (RAM) due to parts obsolescence and to provide more operational flexibility. The grating drive system has been improved to provide more torque margin. The diffuser angle was changed 9 degrees to improve the accuracy of radiometric data in the Irradiance mode. Range 3 data is provided from the PMT anode. The SBUV/2 is planned for afternoon missions only and is not presently planned for flight on NOAA-K although NOAA-K was tested with it and can be launched into either orbit.

The Data Collection System (DCS) data rate increased from 1200 to 2560 bps and the number of Data Recovery Units (DRUs) doubled from 4 to 8. DCS-2 bandwidth increased from 24 KHz to 80 KHz.

The Search and Rescue Processor (SARP-2) Data Recovery Units increased from 2 to 3 to handle more global distress messages and to better detect interfering signals. SARP output message formats are significantly different and commandable capability exists to issue pseudo messages for improved isolation of interfering signals from the ground.

Efforts have been made to improve reliability and performance while minimizing cost and impacts to users of POES satellite data. While the POES satellites may superficially appear to be production line copies, they have all been uniquely different. NOAA KLM era marked significant evolutionary and revolutionary improvements to NOAA's abilities to satisfy its multifaceted environmental monitoring and prediction missions.

1.2 NOAA KLM SPACECRAFT CHARACTERISTICS

The primary mission was to design, fabricate, integrate, test and launch five operational NOAA polar-orbiting satellites into Sun-synchronous orbits. These satellites are designated NOAA-K, L, M, N, N'. NOAA KLM mission characteristics are shown in Table 1.2-1.

Table 1.2-1. Mission Characteristics.	
Item	NOAA KLM Specifications
Launch Date	NOAA-K (NOAA-15): May 13, 1998 NOAA-L (NOAA-16): September 21, 2000 NOAA-M (NOAA-17): June 24, 2002 (mid morning orbit) NOAA-N (NOAA-18): May 20, 2005 NOAA-N' (NOAA-19): Feb 6, 2009
Mission Life	2 years minimum required
Orbit	Sun-synchronous, 833 ± 19 km or 870 ± 19 km
Launch Vehicles	U.S. Air Force (USAF) Titan II
Spacecraft – Operational	
Mass	1478.9 kg on orbit/2231.7 kg at launch
Length/Diameter	4.18 m / 1.88 m
Propulsion	Mono propellant hydrazine, GN ₂ and AKM
Attitude Control	3-axis stabilized
Power	Direct energy transfer
Thermal	Passive and active controls
Data Rates -Real Time	
TIROS Information Processor (TIP)	8.32 kilobits per second (kbps) includes low rate instrument (except AMSU) and spacecraft housekeeping and can be recorded
High Resolution Picture Transmission (HRPT)	665.4 kbps includes all instrument data and spacecraft housekeeping and can be recorded.
Automatic Picture Transmission (APT)	Approximately 2 kHz medium resolution imagery from two selected AVHRR sensor channels.
Data Rates – Recorded	
Global Area Coverage (GAC)	665.4 kbps include low-rate instrument, spacecraft housekeeping and medium resolution imagery.

Local Area Coverage (LAC)	665.4 kbps HRPT except the data field is randomized to record.
Playback	2.66 Megabits per second (mbps) during normal operations.
Ground System*	
Operation Control	NOAA/SOCC CDA stations at Wallops and Fairbanks. DSN 26-m and AFSCN for contingency support.
Forward Data Link	S-band command uplink encrypted.
Return Data Link	Housekeeping telemetry from HRPT and GAC downlinks.
Science Data Capture	Tape playback direct to CDA (typically eleven 12-minute contacts per day), relayed to the NOAA/DDS in Suitland, MD.
Science Data Processing	NOAA/DDS, Air Force Global Weather Central (AFGWC), International Weather Services and ARGOS

*at time of NOAA-K launch

The spacecrafts were all launched from the Vandenberg Air Force Base in California using modified, standardized Titan and Delta II launch vehicles and each spacecraft mission was required to be compatible with the existing NOAA ground system.

Reliability and continuous high performance were of utmost importance during the design process for the NOAA KLM satellites, and, just as importantly, the KLM satellites were required to provide continuity to the NOAA polar-orbiting observing system to ensure continuity in the extending the essential climate records for long term climate change studies.

Each spacecraft was designed to meet all on-orbit performance requirements for a minimum period of two years.

NASA played an important role in the design and build out of each satellite. Upon successful achievement of orbit, NASA conducted engineering evaluation and checkout of each satellite. Upon completion of testing, each satellite was turned over to NOAA for routine operational control. During the NOAA operational period, the POES Project's responsibility was limited to investigation of spacecraft on-orbit anomalies upon NOAA's request. Figure 1.2-1 provides a NOAA KLM System Functional Diagram.

1.2.1 SPACECRAFT STRUCTURE

The NOAA KLM spacecraft structure, based on the NOAA-H, I, J integrated structure, is designed to support a complete meteorological payload plus the necessary support subsystems to meet all interface and system requirements. The structure comprises four major assemblies: the Instrument Mounting Platform (IMP), the Equipment Support Module (ESM), the Reaction Control Equipment (RCE), Reaction Support Structure (RSS), and the Solar Array (SA) assembly. Figure 1.2.1-1 provides a line drawing of the NOAA KLM spacecraft and Table 1.2.1-1 summarizes the primary physical characteristics.

Figure 1.2-1. NOAA KLM System Functional Design

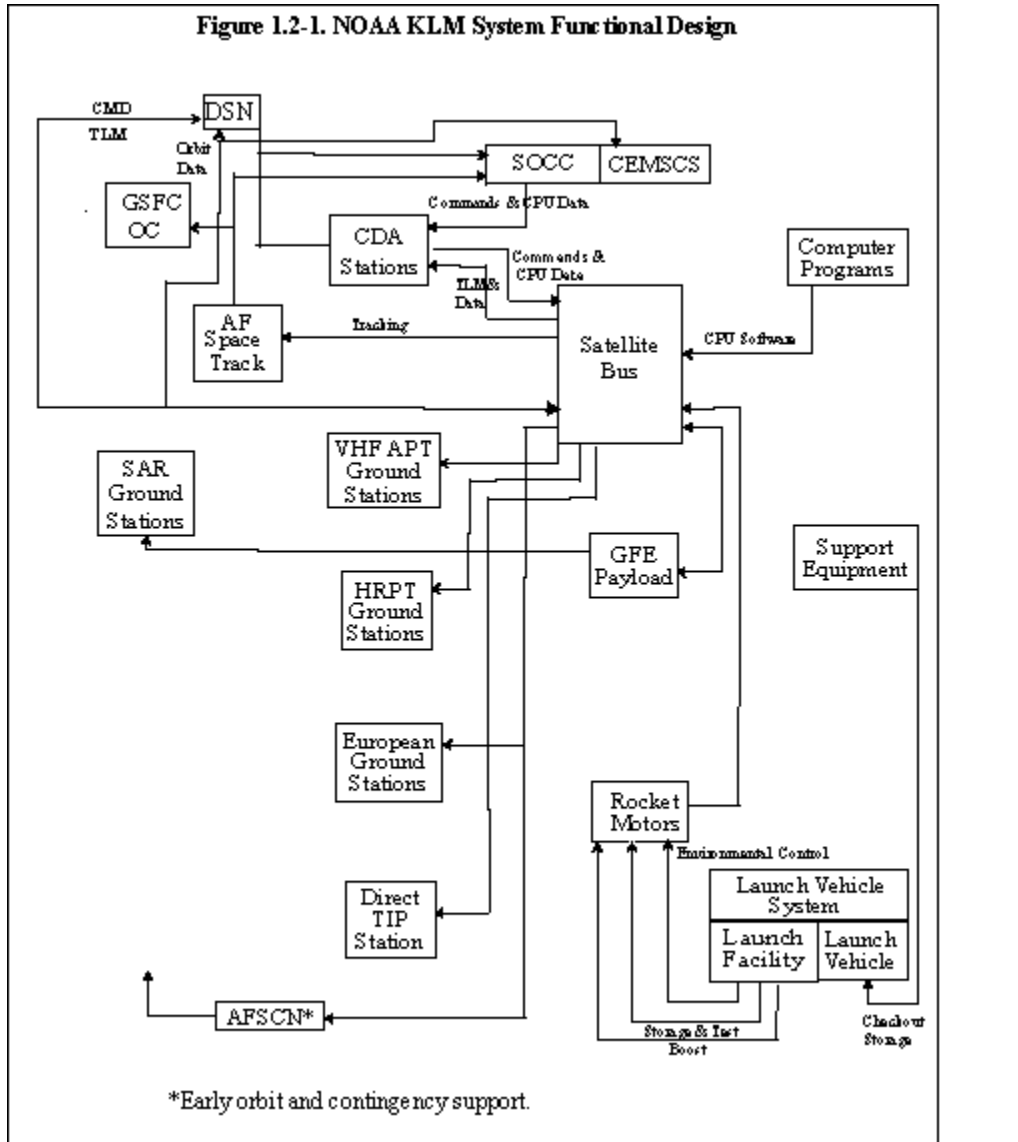

Figure 1.2.1-1 NOAA KLM Spacecraft Configuration.

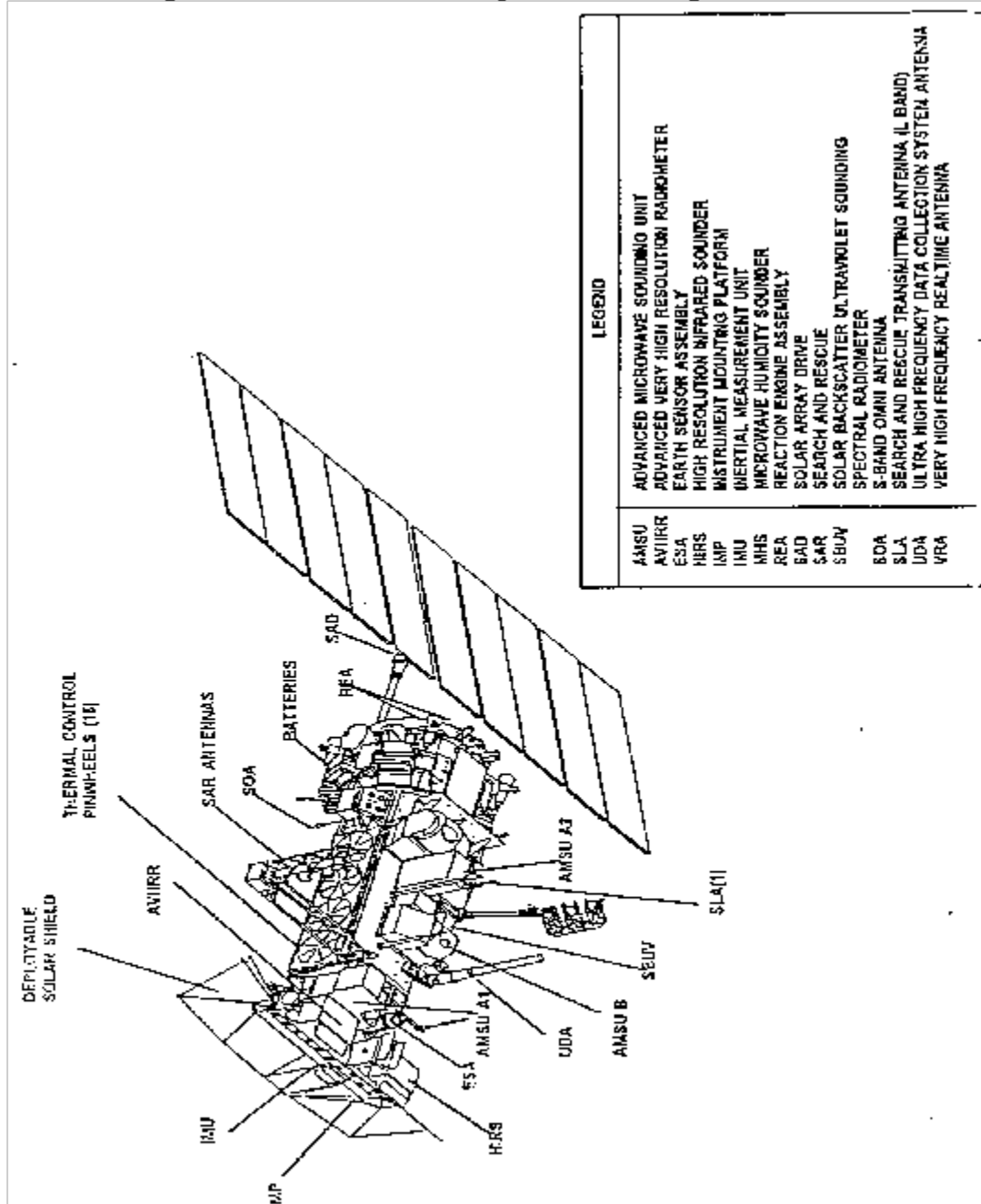

Table 1.2.1-1. NOAA KLM Physical Characteristics.	
Parameter	NOAA KLM Characteristics
General	
Configuration	3-axis body stabilized
Mission	2-years
Launch Vehicle	Titan II
Spacecraft Size	
Launch Configuration Envelope Expendable Launch Vehicle Static Envelope	2540 mm (100 in)
Fairing Diameter	3048 mm (120 in)
On-Orbit Configuration	
Main Body Length	4.2 m (13.75 ft)
Main Body Diameter	1.88 m (6.2 ft)
Array to Body	3.2 m (10.5 ft)
Overall Length	7.4 m (24.2 ft)
Spacecraft Mass (Titan II)	
Dry Satellite	1478.9 kg (3260.3 lb)
Propellant and pressurant	752.8 kg (1659.7 lb)
Total Deployment Weight	2231.7 kg (4920 lb)

1.2.1.1 Instrument Mounting Platform

The HIRS and AVHRR instruments are mounted on the Instrument Mounting Platform (IMP) because of stringent pointing requirements and/or the need for an uninterrupted view of space for detector-cooling purposes. The IMP also supports the primary attitude-sensing equipment: namely, an Earth horizon sensor, an inertial measurement unit and a Sun sensor. Overall, the approach achieves an instrument optical-axis pointing accuracy of better than 0.2 degrees relative to the local vertical. The surface of the IMP is the primary thermal control surface for the instruments. It houses an array of thermal control louvers, protected from solar illumination in mission orbit by a sunshade.

1.2.1.2 Equipment Support Module

The ESM contains the majority of the satellite electronic support equipment. It is pentagonal in cross section but asymmetric to provide a large Earth-viewing face upon which lower pointing accuracy instruments and antennas are mounted. Internal of the ESM are mounted most of the components contained in the data handling, attitude determination and control, communications, and command and control subsystems, as well as the SARR, SARP, and DCS instruments. External to the ESM, on the Earth facing surface, are mounted the AMSU-A1, AMSU-A2, AMSU-B, SBUV, as well as the communication system antennas. One segment of the mounting area, at the lower end of the module, is primarily dedicated to SAR equipment. Thermal control of the ESM itself is provided by thermal blankets and pinwheel louver assemblies integral to the side panels.

1.2.1.3 Reaction Control Equipment Support Structure

The RSS is a circular cylinder, which primarily supports a solid rocket AKM plus the Reaction Control Equipment (RCE) components consisting of two nitrogen tanks, two hydrazine tanks, four hydrazine thrusters, and eight nitrogen thrusters along with the valves and manifolding required to inter-connect the system. In addition to the propulsion equipment, the RSS supports the satellite batteries, battery charge controllers (for thermal reasons these items are outside the

Table 1.2.1.3-1. Government-furnished Satellite Equipment List.			
Item	NOAA-K	NOAA-L	NOAA-M
AVHRR/3	X	X	X
HIRS/3	X	X	X
DCS/2	X	X	X

ESM) and certain antennas. It also furnishes support for the solar array assembly. Table 1.2.1.3-1 lists the satellite equipment furnished by the government.

SEM/2	X	X	X
SARP/2	X	X	X
SARR	X	X	X
SBUV/2		X	
AMSU-A1	X	X	X
AMSU-A2	X	X	X
AMSU-B	X	X	X

1.2.1.4 Solar Array

The SA consists of ten reinforced honeycomb panels, which are hinged to each other along their long edges. When deployed, the array is approximately 6.15 m (242 in) long by 2.73 m (107.5 in) wide. During launch, solar array panels are stowed on the ESM back apex panels. During mission mode, the array is supported from the RSS through the long boom, the solar array drive, the short boom and the mast. The array is canted 22 or 36 degrees from the short boom via the cant-deployment mechanism, located between the short boom and the mast.

1.2.1.5 Spacecraft/Launch Vehicle Interface

The NOAA KLM spacecraft used modified, standardized Titan II launch vehicles. A two-piece conical ring (the payload adapter), furnished by the spacecraft contractor, provided the mechanical interface between the spacecraft and the launch vehicle.

1.2.2 INSTRUMENT PAYLOAD (GENERAL DESCRIPTIONS)

1.2.2.1 Earth Imaging

The AVHRR/3, a six-channel scanning radiometer, views the same Earth area with each channel. The data acquired during each scan allows, after ground processing, multispectral analysis of hydrologic, oceanographic, land use and meteorological parameters. Data from channels 1, 2, and 3A are used to monitor reflected energy in the visible and near-IR portions of the electromagnetic spectrum. These data provide means to observe vegetation, clouds, lakes, shorelines, snow, aerosols and ice. Data from channels 3B, 4 and 5 are used to determine the radiative energy from the temperature of the land, water, and sea surface as well as the clouds above them. Only five channels can be transmitted simultaneously, channels 3A and 3B being respectively switched for day/night operation and as determined by operational requirements for the afternoon satellite, while 3B will be on continuously for the morning satellite mission. For the first time, Channels 1, 2 and 3A on these spacecraft have incorporated the low light split-gain provision, providing better resolution in a portion of the radiance range. The Automatic Picture Transmission (APT) mode, using two selected channels, produces a more geometrically linear scan line but at the reduced resolution of 4 km. Table 1.2.2.1-1 lists the six channels and their required spectral, spatial and thermal resolution (where appropriate). For more information on the AVHRR/3 instrument, see

Section 3.1.

Table 1.2.2.1-1. AVHRR/3 Channels			
Channel	Spectral Bandpass (micrometers)	Spatial Resolution at nadir (km)	Signal to Noise (S/N) or Noise Equivalent Delta Temperatures (NEAT)
1 (Visible)	0.580 - 0.68	1.1	9:1 at 0.5% Albedo
2 (Near IR)	0.725 - 1.00	1.1	9:1 at 0.5% Albedo
3A (Near IR)	1.580 - 1.64	1.1	20:1 at 0.5% Albedo
3B (IR-Window)	3.550 - 3.93	1.1	0.12 K at 300 K
4 (IR-Window)	10.300 - 11.3	1.1	0.12 K at 300 K
5 (IR-Window)	11.500 - 12.5	1.1	0.12 K at 300 K

1.2.2.2 Atmospheric Sounding Instruments

Three instruments are used to determine radiance needed to calculate the atmospheric temperature and humidity profiles from the earth's surface to the stratosphere. These instruments are the High-Resolution Infrared Sounder/3 (HIRS/3), the Advanced Microwave Sounding Unit-A (AMSU-A) and the Advanced Microwave Sounding Unit-B (AMSU-B) for NOAA KLM.

The HIRS/3 has twenty spectral bands, nineteen in the IR band and one in the visible band. This instrument is basically the same as the instrument flown on earlier spacecraft, except for five spectral band changes to improve sounding parameter accuracy. The instrument measures scene radiance in nineteen channels to permit calculation of the vertical temperature profile from the Earth's surface to about 40 km. The instrument scans ± 49.5 degrees, having a ground resolution (nadir) of 17.4 km, 56 instantaneous fields of view (IFOV) for each 2250-km scan line at 6.4 seconds per scan line and 42 km between IFOV's along-track (nadir). See Section 3.2 for the required wavelength, half-power bandwidth and noise power requirements for the HIRS/3.

The AMSU-A is a total power radiometer and a line scan instrument designed to permit the calculation of the vertical temperature profile from the Earth's surface to about a 2-millibar pressure height 45 km (28.0 mi). Vertical profiles are obtained through the measurements of scene radiance in fifteen channels, ranging from 23.8 to 89 GHz. The instrument has an instantaneous field-of-view of 3.3 degrees at the half-power points. The antenna provides a cross-track scan, scanning ± 50 degrees from nadir with a total of 30 Earth fields of view per scan line. Each Earth field of view is separated from the adjacent cell along the scan direction by $3\frac{1}{3}$ degrees. Spatial resolution at nadir is nominally 50 km (31.0 mi). See Section 3.3 for more details on AMSU-A.

The AMSU-B is a line scan instrument designed to allow the calculation of the vertical water vapor profiles from the Earth's surface to about a 20-millibar pressure 12 km (7.5 mi). Vertical profiles are obtained through the measurements of scene radiance in five channels, ranging from 89 to 183 GHz. AMSU-B, like the AMSU-A, is a total power radiometer and uses two target temperatures to provide for accurate radiance calibration with each scan. The instrument has an

instantaneous field-of-view of 1.1 degrees at the half-power points. The antenna provides a cross-track scan, scanning of ± 49.5 degrees from nadir with a total of 90 Earth fields of view per scan line. Each Earth field of view is separated from the adjacent cell along the scan direction by 1.1 degrees. Spatial resolution at nadir is nominally 16.7 km (10.4 mi). AMSU-B contains four water vapor channels (channels 17 through 20 inclusive) and one window channel (channel 16). AMSU-A channel 15 and AMSU-B channel 16 share the same atmospheric window band. See Section 3.4 for more details on AMSU-B.

1.2.2.3 Solar Backscatter Ultraviolet Radiometer (SBUV)

The SBUV/2 is a non-spatially scanning, spectrally scanning sounding radiometer. It is designed to measure scene radiance and solar spectral irradiance in the spectral range from 160 to 406 nanometers (nm). In the discrete mode, measurements are made in 12 spectral bands from which the total ozone and vertical distribution of the ozone are deduced. The sweep mode provides a continuous spectral scan from 406 to 160 nm that is used primarily for solar spectral irradiance measurements. The half power FOV is 11.33 degrees or 172 km (106.9 mi). Spectral characteristics are described in Table 1.2.2.3-1.

Table 1.2.2.3-1. SBUV/2 Spectral Characteristics (Discrete Mode)		
Step Number	Central Wavelength (nm)	Bandwidth (nm)
1	252.00 ± 0.05	1 + 0.2, -0
2	273.61 ± 0.05	1 + 0.2, -0
3	283.10 ± 0.05	1 + 0.2, -0
4	287.70 ± 0.05	1 + 0.2, -0
5	292.29 ± 0.05	1 + 0.2, -0
6	297.59 ± 0.05	1 + 0.2, -0
7	301.97 ± 0.05	1 + 0.2, -0
8	305.87 ± 0.05	1 + 0.2, -0
9	312.57 ± 0.05	1 + 0.2, -0
10	317.56 ± 0.05	1 + 0.2, -0
11	331.26 ± 0.05	1 + 0.2, -0
12	339.89 ± 0.05	1 + 0.2, -0

Cloud Cover Radiometrics	379.00 ±1	3 + 0.3
--------------------------	-----------	---------

1.2.2.4 Space Environment Monitor (SEM)

The SEM-2 provides measurements to determine the intensity of the Earth's radiation belts and data on charged particle precipitation phenomena in the upper atmosphere resulting from solar activity. It provides warnings of solar occurrences that may impair long-range radio communication or high-altitude manned operations.

The SEM-2 consists of two separate sensor units and a common Data Processing Unit (DPU). The sensor units are the Total Energy Detector (TED) and the Medium Energy Proton and Electron Detector (MEPED). Performance characteristics are given in Table 1.2.2.4-1.

The TED uses eight programmed swept electrostatic curved-plate analyzers to select particle type and energy and Channeltron detectors to sense and quantify the intensity in the sequentially selected energy bands. The particles of interest have energies ranging from 50 electron volts (eV) to 20 KeV.

The MEPED senses protons, electrons and ions with energies from 30 KeV to several tens of MeV. The MEPED is a collection of four directional solid-state detector telescopes and four "generally omnidirectional" sensors.

Accumulators are located in the DPU to sort and count the events. The processed data are multiplexed and fed to the satellite telemetry system.

The SEM-2 data are separated from the other data by NOAA/NESDIS and, along with orbital element data, are sent to the Space Environment Center (SEC) in Boulder, Colorado for processing.

Table 1.2.2.4-1. SEM-2 Characteristics.			
SEM-2 Units	Performance Requirements	Energy Levels	Field of View
TED	Determine heat energy input into upper atmosphere from absorption of electrons, protons and positive ions.	Electrons: 0.05 KeV to 20 KeV Protons: 0.05 KeV to 20 KeV	Two at 15 degrees full angle, -x, -x + 30 degrees

MPED	Same as TED	Electrons: 30 keV V to 700 keV V Protons: 30 keV V to 6900 keV V Above ?16, >35, >70, >140 MeV	15 degrees full angle -x, -x +90 degrees 15 degrees full angle -x, X + 90 degrees 120 degrees full angle, -x
DPU	Combine outputs into a 2-second, 40 word format. Provide command, calibrate and timing interfaces.		
Summary (Maximums)	Mass: 5 kg Power: 10 watts Volume: 0.0186 m ³ Telemetry: Two (8-bit) words/TIP minor frame		

1.2.2.5 Search and Rescue Satellite Aided Tracking System

The SARSAT system is designed to detect and locate Emergency Locator Transmitters (ELTs) and Emergency Position-Indicating Radio Beacons (EPIRBs) operating at 121.5, 243, and 406.05 MHz. Figure 1.2.2.5-1 illustrates the SARSAT concept.

The SAR instrumentation on the NOAA KLM satellites comprises two elements, the SARR and the SARP-2. Table 1.2.2.5-1 summarizes the SARSAT instrumentation characteristics.

Table 1.2.2.5-1. SARSAT Subsystem Characteristics.	
Spacecraft Repeater (121.5, 243 and 406 MHz):	
Parameter	Specification
Bandwidths (Doppler shift + drift + tolerance + guard band)	
121.5 MHz	25 kHz
243 MHz	46 kHz
406.050 MHz	100 kHz
Transmitter Power (1,544 MHz)	8 W decibels referenced to a watt (dBW)
Physical Characteristics:	

Weight	24 kg
Size	0.034 m ³
Power	53 W
Spacecraft 406 MHz Processor:	
Maximum Bandwidth	80 kHz
Storage Capacity	324 kb
Output Data Rate (via Telemetry)	2.4 kbps
Physical Characteristics:	
Weight	27.5 kg
Size	0.034 m ³
Power	33 W

Figure 1.2.2.5-1. SARSAT Concept.

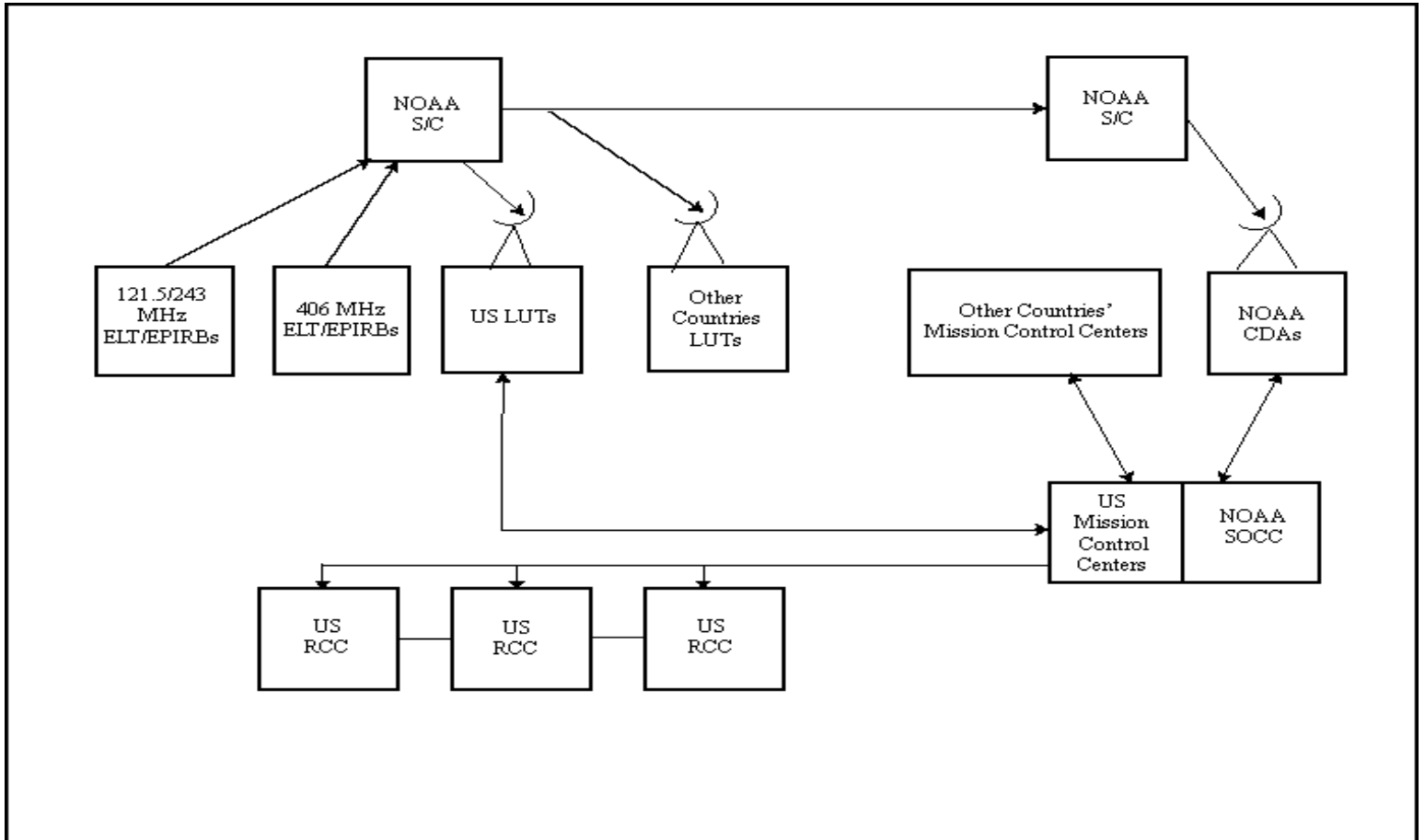

1.2.2.6 Data Collection System

The DCS-2 collects global telemetry data using a one-way radio frequency (RF) link 401.65 MHz from data collection platforms in the form of buoys, free-floating balloons, and remote weather stations and processes these inputs for on-board storage and subsequent transmission from the satellite. For free-floating telemetry transmitters, the system determines the location within 5 km to 8 km root mean square (rms) and velocity to an accuracy of 1 meter per second (mps) to 1.6 mps rms. Other characteristics are shown in Table 1.2.2.6-1. Measurements of environmental data are telemetered to the satellite for collection. The DCS-2 supplements the GOES data collection system in collecting both the information from the more-northern and more-southern latitudes and the location data on free-floating transmitters.

Table 1.2.2.6-1. DCS-2 System Characteristics.	
Parameter	Characteristic
Minimum satellite elevation angle from platform	5 degrees
Number of platforms requiring location/velocity measurements visible in a 5 degree -visibility circle	Capacity: 230
Total number of such platforms over the globe	Capacity: 4100
Percentage of platforms with six good Doppler measurements per day	85%
Platform transmission repetition period	Approx. 60 sec
Message length	0.3 to 0.9 sec
Expected location accuracy	5 km to 8 km rms
Expected velocity accuracy	1 to 1.6 mps

For the incoming signals, the DCS-2 measures frequency and relative time. The formatted data are stored in the satellite for transmission to the CDA station. The DCS-2 data are stripped from the GAC data by NOAA/NESDIS and transmitted to the ARGOS center at the Centre National d'Etudes Spatiales (CNES) in Toulouse, France, for processing, distribution to users and storage for archival purposes. Alternatively, there is an operational feature that allows the stored data to be acquired directly by a European ground station.

1.2.3 PROPULSION AND REACTION CONTROL SUBSYSTEM

The Propulsion and Reaction Control Subsystem is a hybrid solid/ liquid/cold-gas system consisting of a solid propellant for orbit (apogee) injection and a dual Reaction Control Equipment (RCE) system using both pressure-regulated cold-gas nitrogen thrusters and hydrazine monopropellant thrusters. This subsystem primarily provides separation from the Titan II booster, ascent-phase attitude control (three-axis stabilized) and orbital velocity trim for

the satellite. Figure 1.2.3-1 provides a functional schematic of the RCE.

The hydrazine RCE consists of four thrusters and two spherical storage tanks. The hydrazine thrusters are used for maneuvers requiring large control torques and for all velocity change maneuvers, i.e., spacecraft separation from the booster and orbit circulation trim, as well as pitch and yaw control during the AKM burn. After completion of the orbital velocity trim burn, pyrotechnic valves at the outlet of each hydrazine propellant tank may be fired to isolate the hydrazine thrusters from the propellant tanks and render the system inoperative.

The cold-gas nitrogen RCE consists of eight thrusters and two spherical storage tanks of usable nitrogen. The nitrogen thrusters are used for three-axis control during ascent (except during AKM burn), Earth acquisition after handover and as a backup for momentum unloading in normal orbit mode control. Four of the thrusters provide roll control through Ascent Guidance Software (AGS), and are operated, under software control, in coupled pairs. The remaining four thrusters are operated individually to provide AGS pitch and AGS yaw control.

Figure 1.2.3-1. RCE Functional Schematic.

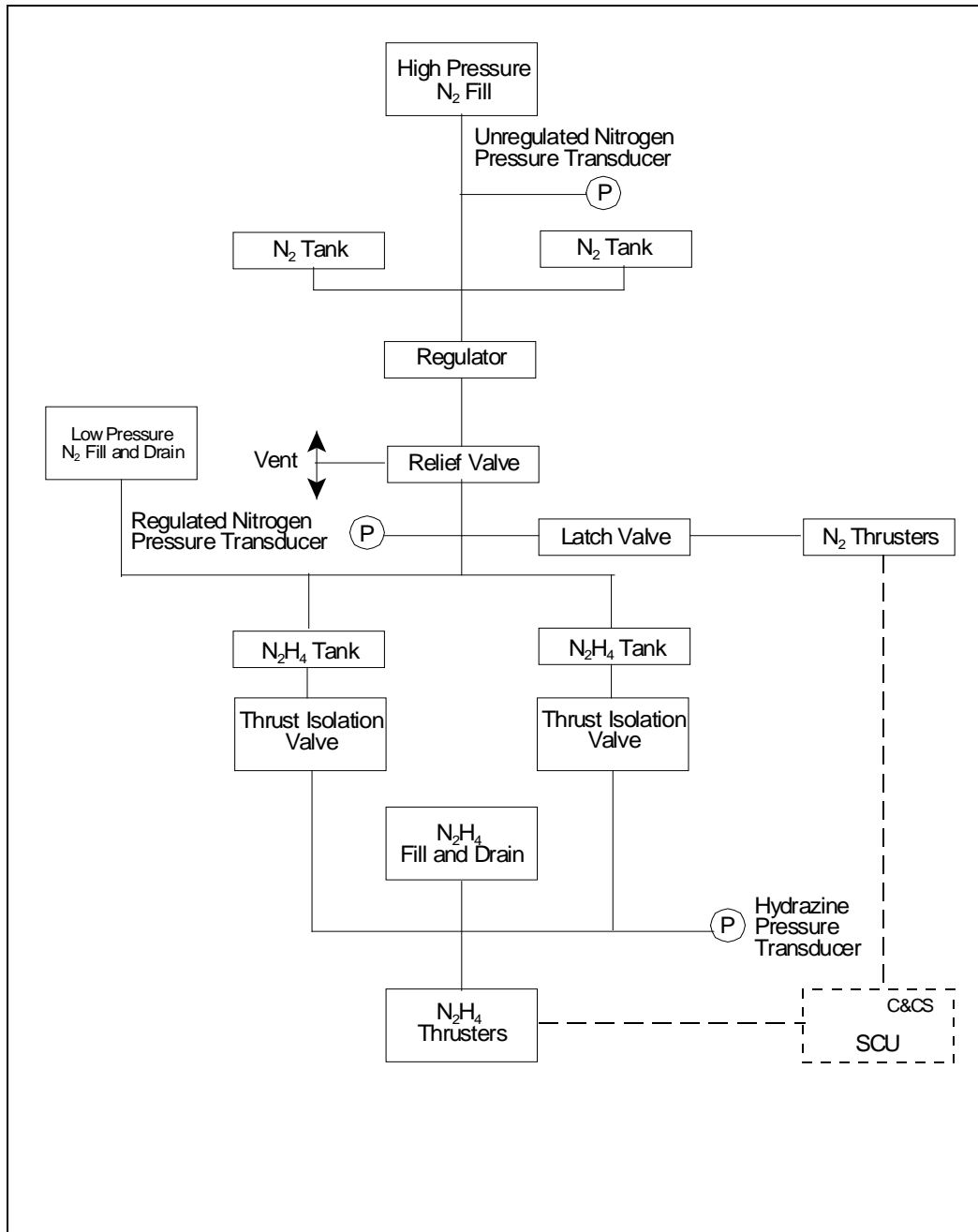

1.2.4 ATTITUDE DETERMINATION AND CONTROL SUBSYSTEM

The Attitude Determination and Control Subsystem (ADACS) provides, in conjunction with the RCS and Command and Control Subsystems (CCS), the functions of the on-orbit attitude control and ascent guidance. It is a zero-momentum system consisting of reaction wheels and Earth,

Sun, and inertial reference sensors. Figure 1.2.4-1 provides a simplified block diagram of the subsystem.

Figure 1.2.4.1. ADACS Simplified Block Diagram

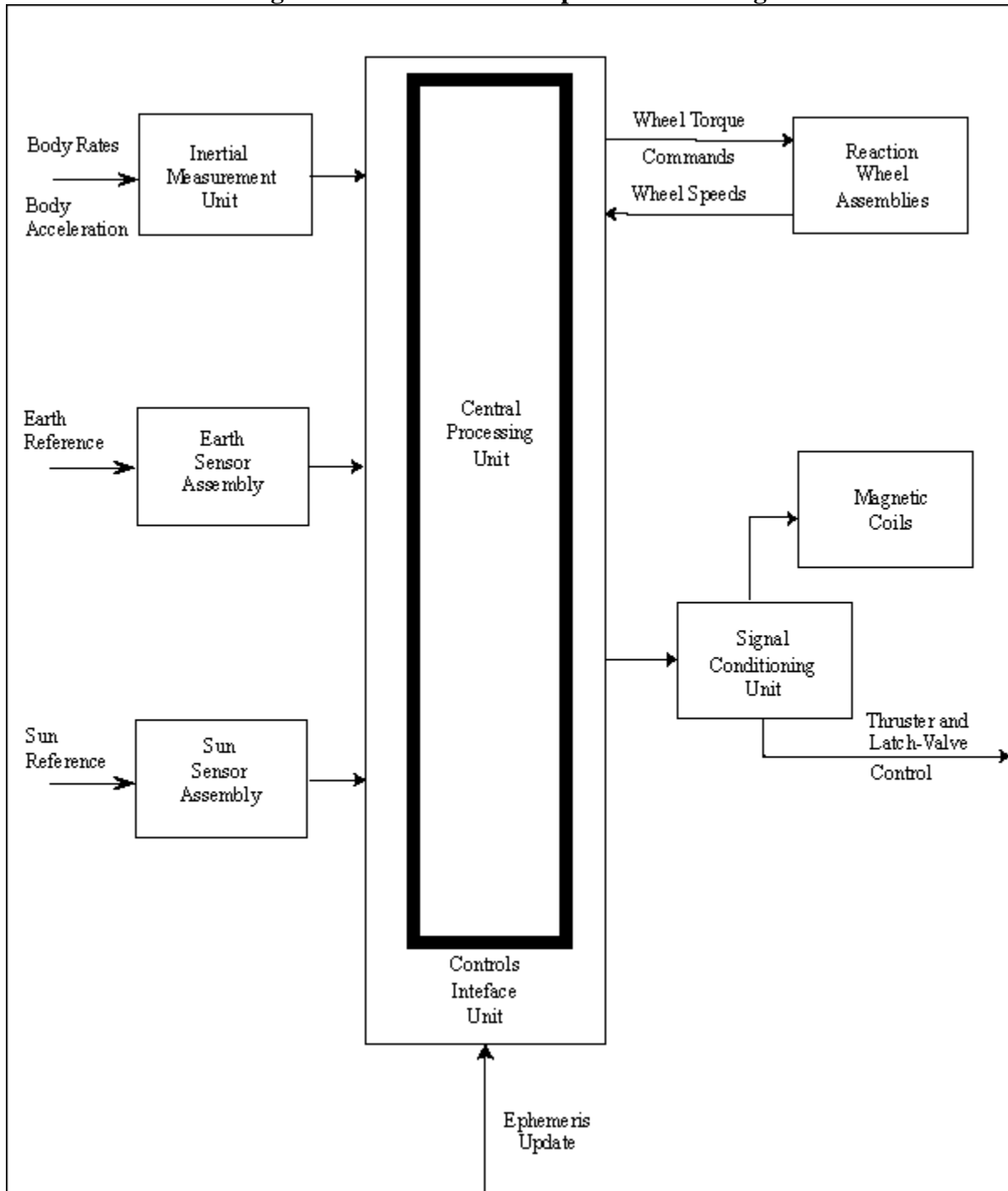

In the subsystem's attitude-control mode, the Earth Sensor Assembly (ESA) and the Sun sensor, together with rates derived from the Inertial Measurement Unit (IMU), furnish the primary attitude reference. Control torquing is accomplished by an orthogonal set of Reaction Wheel Assemblies (RWA's) backed up by a fourth skewed reaction wheel. The momentum accumulation in the wheels is unloaded by means of magnetic coils, which, in turn, are backed up by the RCS cold-gas thrusters. The subsystem requires ephemeris data for orbital operation, and this typically can be satisfied with a ground update once per week. In all other respects, the subsystem is autonomous, including the capability for Earth acquisition and reacquisition.

The IMU, which provides yaw, pitch, and roll rate information in orbital mode, is the key component in the ascent guidance phase. The same closed-loop guidance scheme previously used on TIROS-N and ATN missions will be retained. The IMU will furnish a navigation reference from liftoff until orbit insertion and closed-loop guidance for all satellite maneuvers following separation from the launch vehicle.

Satellite attitude-control accuracy in mission orbit is +0.2 degrees with respect to the local geodetic reference frame; knowledge of attitude is obtainable through on-ground processing to an accuracy of ± 0.10 degrees in all axes. Attitude rates do not exceed 0.035 degrees per sec in pitch and yaw and 0.015 degrees per sec in roll. Attitude determination with a maximum 3-sigma variation better than 0.14 degrees is provided onboard the satellite.

1.2.5 MISSION DATA ACQUISITION AND FORMATS

1.2.5.1 Environmental Data Formats

No significant changes were proposed in the method of mission data handling and acquisition from that developed for previous satellites in the TIROS-N/ATN series, but a sixth data format was added for AMSU data handling. These six basic data formats are generated onboard the satellite, each associated with one or more of the acquisition modes (stored or real-time, very high frequency (VHF) or S-band transmission). These formats are as follows:

- TIROS Information Processor (TIP) Data

Under routine mission-orbit operations, the TIP output contains low-rate instrument data multiplexed with satellite housekeeping data. It contains all environmental instrument information except that from the AVHRR and the AMSU. It is available in real-time and as stored data.

Low rate instrument data are included every minor frame. Real-time TIP data are normally available through the VHF beacon link. See Section 4 for more information.

For early orbit support and maintenance operations, the TIP has three other operating modes: boost, dwell and satellite computer memory dump.

- High Resolution Picture Transmission (HRPT) Data

HRPT comprises full-resolution data from the AVHRR multiplexed with TIP and AMSU data. HRPT is dedicated to real-time transmissions and is available to local users in split-phase format via either of two S-band communications links with the option of transmission from a third with left circular polarization rather than right circular polarization, which the other two provide. An HRPT major frame comprises three minor frames. One minor frame will contain TIP data, one will contain AMSU data and one will contain backfill data. See Section 4 for more information.

- Local Area Coverage (LAC) Data

The LAC data are essentially the stored version of HRPT, played back at either two or four times the real-time rate, and are made available for centralized processing. They are not intended for local users. LAC data storage is scheduled via the stored command table to provide up to 10 minutes of coverage per tape transport. See Section 4 for more information.

- Global Area Coverage (GAC) Data

GAC data contains TIP, AMSU and reduced resolution AVHRR data. The overall data rate is one-tenth of the LAC data rate, allowing over 100 minutes of data to be stored on one tape transport. Record-to-playback ratio is either 20:1 or 40:1. The GAC stream is for stored data only and is used to develop global data sets for centralized processing and analysis. It is not intended for local users. The reduced resolution of this format allows 100% recovery of the data even under worst-case blind-orbit conditions. See Section 4 for more information.

- Automatic Picture Transmission (APT) Data

APT data are specifically tailored for low-cost VHF local-user ground stations. Again, it is derived from AVHRR video data but at medium resolution. Any two of the five AVHRR channels provided to the MIRP can be selected and processed as "Video A" and "Video B."

One APT line, consisting of one line of Video A and one line of Video B, is output every third AVHRR scan. Ancillary AVHRR data appear at one edge of each line and their 64-second repetition period defines the APT frame length. The resulting line rate is two per second.

APT data are transmitted continuously over a dedicated VHF link as an analog signal consisting of an amplitude-modulated 2400 Hz subcarrier frequency modulating the RF carrier. Table 1.2.5-1 gives the APT line characteristics.

- AMSU Information Processor (AIP) Data

AMSU data is available as part of a low-rate data format. This format contains both standard TIP data and AMSU sensor data. The primary use of this 16 kbps format will be for global recording and playback to CDA stations. It is anticipated that AMSU AIP data will normally be extracted from HRPT, LAC and GAC data. See Section 4 for more information.

Table 1.2.5-1. APT Line Characteristics NOAA KLM Satellites.	
Frequency Band	136 to 139 MHz band
Carrier Frequencies	137.50 to 137.62 MHz
Frequency Stability	±0.002%
Out-of-band Emissions	-60 dB at ± 170 KHz and greater from carrier frequency
Transmitted Bandwidth	-3 dB at ± 25 KHz from carrier frequency
Modulated Rate and Type	±17 KHz FM with a 2.4 KHz subcarrier
EIRP	±33.5 dBm

1.2.6 DATA HANDLING SUBSYSTEM

The functions of the Data Handling Subsystem (DHS) are to collect, format, average, and store baseband data from other satellite subsystems; to output baseband data to other satellite subsystems; and to provide synchronous signals and clocks to other satellite subsystems. Tables 1.2.6-1 and 1.2.6-2 list the subsystem data inputs and data outputs, respectively.

Table 1.2.6-1. NOAA KLM Data Handling Subsystem Data Inputs.			
Name of Data	Source of Data	First Component Receiving the data	Data Characteristics
Analog Telemetry	All active electronic components on the satellite - 512 separate channels	TIP	Analog health-monitor voltage on a dedicated wire per quantity.
Digital-B Telemetry	Same as above, but 352 separate channels.	TIP	Bi-level status voltage on a dedicated wire per quantity.

Central Processing Unit (CPU) Telemetry-Boost Mode	Same as above, but 352 separate channels.	TIP	NRZ-L data per a specified hand-shake. 8000 bps.
CPU Telemetry - Orbit Mode	CIU	TIP	Same as above, but at 960 bps.
Command Verification Data	CIU	TIP	NRZ-L data per a specified hand-shake. One 16-word per 0.05 second (Boost Mode) or 0.1 second (Orbit Mode).
Digital-A Data	All Government-furnished instruments except AVHRR, SARR, SARP and AMSU. (16 channels, 4 used).	TIP	NRZ-L data per a specified hand-shake. In multiples of 8 bits per 0.1 second: not accepted in TIP Boost or Dwell Modes.
AVHRR Data	AVHRR	MIRP	NRZ-L data per a specified hand-shake. In bursts at 1.9968 Mbps, averaging to 0.6213 Mbps.
AMSU Data	AMSU-A1, A2, B and MHS	AIP	NRZ-L data per a specified hand-shake. 25 8-bit words from AMSU-A1, 13 8-bit words from AMSU-A2, and 50 8-bit words from AMSU-B per 0.1 second. Not intended for TIP Boost or Dwell Modes.

Table 1.2.6-2. NOAA KLM Data Handling Subsystem Data Outputs

Name of Data	Real-Time or Playback	Destination	Conditions	Data Characteristics
TIP Orbit	Real-Time	Both Beacon Transmitters (BTX's)	TIP in Orbit Mode	8320 bps split phase

TIP Orbit	Real-Time	STX-2 STX-4	TIP in Orbit Mode Command to XSU Command to AIP	8320 bps split phase
TIP Boost	Real-Time	STX-2 STX-4 (PRIMARY)	TIP in Boost Mode Command to XSU Command to AIP	16640 bps split phase
HRPT	Real-Time	STX-1, -2, or -3	MIRP On Command to XSU	665.4 kbps split phase
APT	Real-Time	Both VHF Real- time Transmitters (VTX's)	MIRP On	Amplitude- modulated 2400- Hz subcarrier
TIP Orbit	Playback	STX-1, -2, or -3	Command to XSU	332.7 kbps split phase
TIP Boost	Playback	STX-1, -2, or -3	Command to XSU	332.7 kbps split phase
GAC	Playback	STX-1, -2, or -3 and STX-4	MIRP on Command to XSU	2.6616 Mbps NRZ or 1.3308 Mbps split phase
LAC	Playback	STX-1, -2, or -3 and STX-4	MIRP on Command to XSU	2.6616 Mbps NRZ or 1.3308 Mbps split phase
TIP Subcom Data	Real-Time	CIU	CIU responds to handshake	64 bits per TIP minor frame-in bursts
AIP	Playback	STX-1, -2, or -3 and STX-4	AIP in Data Mode TIP in Orbit Mode Command to XSU	332.7 kbps split phase

AIP	Real-Time	STX-1, -2 or -3	AIP in Data Mode TIP in Orbit Mode Command to XSU	16640 bps split phase
		STX-4	Command to AIP	

The MIRP generates the four formats (GAC, LAC, HRPT and APT) described earlier. It incorporates algorithms for data processing and data compression and contains large multi-access buffer stores, which time-average the intermittent AVHRR Earth-scan input (thereby achieving a bandwidth reduction) and manipulates the AVHRR signals together with TIP and AIP data into the desired digital formats.

Data storage is provided by five identical DTRs. Each DTR consists of one Electronic Unit (EU) and two tape Transport Units (TU's) with the EU switchable to either of the TU's. Each TU has a record capacity of 225 min of TIP data, 113 min of GAC data or 11.3 min of LAC data. Normal operational playback time for GAC or LAC data is 3 min, but a one-half speed (6 min) GAC or LAC playback can also be commanded. The DTRs are identical to provide flexibility and redundancy at a minimum cost. The spacecraft XSU during record provides the selected record mode command (TIP, GAC, or LAC) clock, and record input data to any of the five DTRs. During playback, the XSU provides the selected playback mode command (TIP, GAC, or LAC) and clock to any of the five DTRs, as well as playback output data from any of the five DTRs to any of four S-band transmitters.

1.2.7 COMMUNICATIONS SUBSYSTEMS

The functional requirements of the Communications subsystem are separated into three distinct phases: prelaunch, liftoff to handover and the mission phase where the solar array and all antennas are deployed. During the mission phase, the subsystem provides the following function:

- Mission Phase

- Reception and demodulation of S-band commands.
- Continuous transmission of TIP data via the VHF Beacon.
- Continuous transmission of APT data at VHF.
- Continuous transmission of HRPT data at S-band.
- Transmission of stored LAC, GAC, TIP, and AIP data upon command at S-band.
- Reception and filtering of DCS signals.
- Reception, processing and retransmission of SAR signals.

The subsystem comprises 14 antennas, 9 transmitters, and redundant receivers, together with associated filters and other RF feed components. Three 7-watt STX's (STX-1, -2, and -3) and three directional S-band antennas (SBA's) (SBA-1, -2, and -3) mounted on the satellite Earth-facing (+X) surface provide the three principal S-band data links. VHF Omni coverage for real-time TIP telemetry is provided by two 1-watt beacon transmitters (BTX-1 and -2) operating through an omni antenna also mounted on the +X side of the spacecraft. Launch and emergency coverage is provided by a fourth 7-watt (STX-4) and a set of omni antennas mounted on the +X and -X sides of the spacecraft. The two APT 5-watt VTX's (VTX-1 and -2) use a separate dedicated helical antenna; this, like the instrument dedicated antennas, is also directional, Earth-face mounted, and used only in mission mode. The SAR Receiver Antenna (SRA) developed on the ATN program is a unique design incorporating two nested helices: the outer element serving the 121.5 MHz and 243 MHz link, the inner one the 406.05 MHz link.

The fourth SAR uplink (406.025 MHz) is combined with the DCS uplink and is received via the UDA.

The subsystem has two sets of communications links (ascent and operational), which are summarized in Tables 1.2.7-1 and 1.2.7-2. The following summary describes the relationship of subsystem equipment to the communications links:

- S-Band Transmitting Equipment - Three directional SBA's (SBA-1, -2, and -3), and three STX's (STX-1, -2, and -3) provide the routine S-Band downlink services in operational orbit. These downlink services consist of HRPT, GAC playback, TIP playback and LAC playback data. SBA-1 and STX-1 transmit the lowest of the three frequencies, while SBA-3 and STX-3 transmit the highest.

The S-Band omni antennas (SOA's) (SOA-3, -4) and STX-4 provide launch real-time telemetry to the NASA tracking station at VAFB/WR and to the Advanced Range Instrumented Aircraft (ARIA) aircraft.

- Command Receiving Equipment - The command signal is Phase Modulated (PM) on a carrier at 2026.0 MHz. The modulating signal is a 16 kHz subcarrier modulated by 2 kbps split-phase-level data.

The Command Antennas, RF Filters, and Dual Command Receiver recover the signal. Both command receivers operate simultaneously and continuously. The outputs of both receivers are cross-strapped externally to the two Command Demodulators. The Command Receiver-Demodulator provides two isolated sets of outputs. Each set of separate output lines are provided to the Control Interface Unit (CIU) and Decryption/Authentication Unit (DAU) for uplink processing.

The receivers are permanently connected to a set of S-band omni-directional antennas via a hybrid network.

- VHF Telemetry Equipment - The beacon antenna, RF filter, RF switch and BTX (BTX-1 or BTX-2) provide the TIP real-time data listed in Tables 1.2.7-1

and 1.2.7-2.

The directional VHF real-time antenna (VRA), RF filter, and VHF real-time transmitter (VTX-1 or -2) provide the APT data in Table 1.2.7-1.

- Antennas and RF Filters for Payload Instruments - The directional UDA, Data Collection System/Search and Rescue Processor Diplexer (DPD), and RF filter provide the antenna and electromagnetic interference isolation for the DCS listed in Table 1.2.7-1.

The UDA, DPD and RF filter provide the corresponding service for the SARP.

The directional SRA, the directional Search and Rescue L-Band Antenna (SLA) and RF filters provide the corresponding services for the SARR.

Table 1.2.7-1. Ascent, Early-Orbit and Contingency RF Communications Link Characteristics Summary.				
Link	Ground Facility	Frequency	Modulation	Bit Rate
S-Band Command	NAGE (pre-launch), CDA, GN	2026 MHz	BPSK/NRZ-M	2 kbps
S-Band TIP Real-Time	WSMC, ARIA Aircraft, AFSCN, DSN, CDA	2247.5 MHz and 1702.5 MHz	Split-Phase Level Data	8,320 bps or 16,640 bps
S-Band TIP Playback	WTR, CDA, Lannion	1702.5 MHz 1707.0 MHz	Same as above	332.7 kbps
VHF TIP Real-Time	CDA, Lannion	137.35 or 137.77 MHz	Same as above	8,320 bps

Table 1.2.7-2. NOAA KLM Operational Link Summary

Link	Data Contents	Ground Facility	Frequency
S-Band Command	Satellite commands (clear mode or encrypted)	CDA	2026 MHz
VHF TIP Real-Time	Housekeeping telemetry and payload data from all meteorological instruments except AVHRR and AMSU	CDA, TIP Stations	137.35 or 137.77 MHz
HRPT	Full-resolution AVHRR data plus concurrent TIP AMSU and TIP data	CDA, HRPT Stations	1698 or 1707 MHz
GAC Playback	Global reduced-resolution AVHRR data plus TIP data stored on satellite tape recorders	CDA	1702.5 MHz and either 1698 or 1707 MHz
LAC Playback	Tape-recorded-replica of HRPT data		Same as above.
TIP/AIP Playback	Tape-recorded-replica of TIP/AIP real-time data	Lannion TIP Playback Station	1698 or 1702.5 or 1707 MHz
APT	Reduced resolution, geometrically-corrected analog video from two of the five AVHRR channels, selected by command	CDA, APT Stations	137.50 or 137.62 MHz
DCS Uplink Messages	Environmental measurements, identification, and a frequency reference for Doppler navigation; from unattended platforms	DCS Platforms	401.65 MHz
SAR 121.5 MHz Uplink Signals, 243 MHz Uplink Signals	Emergency transmissions from downed aircraft and ships. Aircraft transmitters are ELT's; ship transmitters are EPIRB's	121.5/243-MHz ELT's EPIRB's	121.5 MHz 243 MHz

SAR 406 MHz Uplink Messages Received Separately by SARR 406 MHz Channel and by SARP	Same as above, but with improved frequency stability and modulation containing identification of the aircraft or ship	406-MHz ELT's and EPIRB's	406.05 MHz
SARR Downlink	Transponder frequency-multiplexed SAR uplink signals and messages from all three uplink frequencies, preserving uplink phase for Doppler tracking by ground stations; also 406-MHz messages reformatted and tagged with time and Doppler measurements by the SARP; the SARP data transmitted in near-real-time and also cyclically from SARM.	SAR LUT's	1544.5 MHz

1.2.8 THERMAL CONTROL SYSTEMS (TCS)

The TCS consist of active and passive thermal control equipment. The TCS maintains unit temperatures within the specified operating range, generally within limits of 0 to 35 degrees Centigrade (C). A combination of onboard and nonflight thermal control is required during test or prelaunch phase.

Passive thermal control is affected by the appropriate use of multilayer insulation blankets, aluminized Teflon thermal shielding, special finishes, and thermal-conduction-control materials. The major active elements of the TCS are heaters and louver-controlled cooling radiators. There are two types of louvers: vane louvers and pinwheel louvers, both controlled by Thermal Control Electronics (TCE) units. The satellite incorporates a safe-state mode of operation where, in the event of a major anomaly such as loss of proper attitude, a powered-down state is automatically entered. Under this condition, TCS heaters maintain critical equipment, including instruments, at a safe temperature until mission operations can be re-established.

The thermal control system is designed to achieve satellite thermal control for all Sun angles between 0 degrees to 80 degrees. The TCS functions include the following:

- Maintain spacecraft subsystem and instrument temperatures within spacecraft allowable limits;
- Minimize temperature excursions within the specified limits (T<5 degrees C/hour);

- Minimize thermal impact of AKM burn during mission ascent phase;
- Prevent on-orbit low temperatures within the RCE hydrazine system;
- Maintain instrument interface temperatures, operational mode only, between 0 and 30 degrees C and internal satellite/equipment between 5 and 35 degrees C;
- Prelaunch thermal conditioning of equipment before and during mission ascent phase.

1.2.9 POWER SYSTEM

Electrical power is provided by a direct energy transfer regulated bus power system. The primary energy converter is a single-axis-sun tracking solar array, and the energy storage system consists of a set of three nickel-cadmium batteries. The major components are the Solar Array (SA), batteries, Power Supply Electronics (PSE), Battery Charge Assembly (BCA), Solar Array Drive (SAD), Array Drive Electronics (ADE), Battery Reconditioning Unit (BRU) and the Controls Power Converter (CPC).

In the mission mode, the SAD rotates the SA once per orbit so that it continually faces the Sun. The SA is canted to either 22 or 36 degrees to the orbit normal, depending on whether the spacecraft is in a morning or afternoon orbit. The three batteries supply power through the boost regulator during the dark portions of each orbit and augment the solar array for peak-load conditions during orbital daylight.

2.0 NOAA POLAR SATELLITE NAVIGATION AND EARTH LOCATION

In this document, when reference is made to satellite navigation, the emphasis is on information representing the satellite orbital position, velocity and orientation. Our goal is to present information that will enhance the user's ability to receive and process polar instrument data.

2.1 NAVIGATING THE POLAR SATELLITE

Any object in orbit about a more massive body will follow Kepler's three laws of motion:

1. The path of the object will be an ellipse, with the massive body at one focus.
2. A straight line joining the central body and the orbiting body will sweep out equal areas in equal times.
3. The square of the sidereal (relative to the stars) period of the orbiting body is directly proportional to the cube of the semi-major axis of the orbit.

These relations are true for any orbit; a planet orbiting a star, a moon orbiting a planet, or an artificial satellite orbiting the Earth. Discussion here will be confined to the last case.

If the Earth was a perfect sphere and there were no nearby bodies, the orbit into which the satellite was placed initially would remain unchanged. However, the presence of the Sun and Moon will cause the orbit to vary. Since the orbits which are being considered here are close to the Earth, the most important cause of variation in the orbit is the non-sphericity of the Earth; the flattening of the poles and the bulging of the equator resulting from the adjustment of the Earth to its rotation. The equatorial bulge is small, the equatorial radius exceeding the polar radius by only about a third of a percent. Nevertheless, this is sufficient to have a major effect on the behavior of a satellite orbit.

Since a satellite is a rotating body, a torque applied perpendicular to the axis of rotation will result in a precession of the rotation axis. Such a torque is supplied by the attraction of the equatorial bulges. The amount of torque, and hence the amount of precession, is governed by two quantities: the mean distance of the satellite from the Earth center, (a - the semi-major axis of the orbit ellipse), and the inclination of the orbital plane to the Earth's equatorial plane, I , measured through 180 degrees from the east direction (the direction of the Earth's rotation).

This situation permits certain characteristics of the orbit to be controlled. The satellite height is usually specified initially in order to achieve the desired Earth coverage with particular instruments. For NOAA satellites, the inclination is then chosen such that the orbit will precess in the same direction and at the same rate as the Earth revolves about the Sun. This situation is termed Sun synchronous, and means that the satellite will preserve its angular relationship with the Sun over time. This causes the satellite to view each latitude at the same Local Solar Time (LST) on each orbit.

The NOAA series of satellites have been placed in orbits with a mean height of about 850 kilometers (semi-major axis about 7228 kilometers). In order to be Sun synchronous, the inclination must then be about 99 degrees. This means that the satellite moves in a westward direction, termed a retrograde orbit, since the satellite motion is opposite to the Earth rotation direction. Since, by Kepler's third law, the period is related to the semi-major axis, the period must be about 102 minutes. The period usually specified for NOAA series satellites is the *nodal* period - the time from one ascending node to the next. Since the orbit is precessing, this will be slightly different from the sidereal period - relative to a fixed point on the celestial sphere. A third period which is often given is the anomalistic period - the time from perigee to perigee. Perigee is the point in the orbit which is closest to the Earth center; this also changes with time.

The LST of the ascending node is not constrained by any of these considerations, and is chosen for other reasons, mainly coverage. Power and thermal constraints preclude normal operation within two hours of noon LST. The times usually chosen are either an ascending (northbound) node around 1430 LST or a descending (southbound) node around 0730 LST.

Thus far only the characteristics of the orbit in space have been considered, with no reference to the physical Earth around which the satellite travels (except for the effects of the equatorial bulges). Although the orbital plane is precessing with a period of one year, the Earth is rotating beneath it once per day, causing the satellite to pass over different geographical areas on each pass. The movement is just the amount that the Earth has rotated in one orbital period, and is 25.5 degrees of longitude (in 102 minutes). Since the Earth rotates from west to east, this displacement is westward.

2.2 EARTH LOCATING THE POLAR SATELLITE DATA

The Earth viewing instruments on the NOAA satellites (with one exception) are cross-track scanners; i.e., they scan perpendicular to the direction of movement of the satellite. For each instrument several quantities are important for Earth viewing:

1. The angular field of view for a single observation - instantaneous field of view (IFOV) - not needed to compute Earth locations.
2. The step angle between consecutive observations.
3. The step time.
4. The number of steps.

These values are all measured at the satellite position. A scan angle of zero corresponds to the midpoint of the scan. It may not correspond to an actual IFOV. Values for the scan data for each instrument can be found in Appendix J.

The actual area on the Earth observed in an IFOV or encompassed within the width of a scan swath depends on the height of the satellite above the Earth surface. This height is not constant for two reasons. Even if the satellite were in a perfectly circular orbit, the Earth is approximately an ellipsoid, the radius of which varies by 21.4 kilometers from equator to pole. Additionally, the satellite orbit, while very close to circular, is not exactly so. Since the Earth center is at one

focus of the elliptic orbit, it is displaced to one side of the ellipse. While the combined effects of these two factors must be considered for correct Earth location, for generalized approximations they may be neglected, and the orbit considered to be perfectly circular about a spherical Earth.

Within a single scan, the area on the Earth within an IFOV will increase with the angle from nadir, due to the combined effects of an oblique viewing angle and the curvature of the Earth. The nadir direction is defined by a line through the satellite which is perpendicular to the surface of the Earth ellipsoid. This point of intersection of this line with the ellipsoid is defined as the sub-satellite point (SSP).

Using the satellite position, the scan angle, and any pertinent attitude angles (in Section 2.3), the direction in inertial space in which a given instrument is looking - the Line of Sight (LOS) - is found. The intersection of the LOS with the ellipsoid may then be found. In order to determine the longitude of the intersection, the Greenwich Hour Angle (GHA) must be found for the time of the observation. This is the longitude difference between the Greenwich meridian and the zero longitude of the inertial coordinate system - the Vernal Equinox. Once this is done the exact Earth location which the instrument is viewing (geodetic latitude and longitude) may be found. See Appendix I for the Earth location algorithm.

2.3 NAVIGATION AND EARTH LOCATION PROCESSING WITHIN NOAA

To provide accurate satellite navigation data, the Engineering Branch of the Mission Operations Division (MOD), which is part of the Office of Satellite and Product Operations (OSPO), receives a daily set of Inertial Osculating Cartesian orbit parameters for each polar satellite from the Air Force or Navy. This orbit vector is used to generate a predicted User Ephemeris File (UEF) of orbit vectors spaced one minute apart that cover a 10 day time span. This file is created using a COWELL numerical integrator (using Störmer-Cowell formulas) which maintains the one kilometer accuracy of the initial orbit vector (Maury and Brodsky, 1969 and Moore and Beandet, 1973). The UEF is the foundation for all the navigation data produced in MOD. It is utilized to create the TBUS bulletins, the equator crossing information files, the Search and Rescue (SAR) orbit ephemeris files and Level 1b instrument data files. The SAR ephemeris data is provided for use by the U.S. Mission Control Center for Search and Rescue. The level 1B process uses the orbital information in the UEF files to provide Earth located data for the NOAA polar satellite instruments.

The Earth location data provided in the Level 1b process is produced by the Advanced Earth Location Data System (AELDS). This system was initially implemented on September 8, 1992 in the AVHRR Level 1b process and on September 7, 1994 in the TOVS Level 1b process. It is an on-line Earth location process utilizing the scan line time codes to produce Earth location. With the introduction of AELDS the accuracy of the Earth location data in the Level 1b file was improved by 50%.

The Earth location algorithm used to produce the latitude and longitude parameters within the AELDS process are available in Appendix I. The AELDS process provides more than just latitude and longitude information. Given the satellite position and velocity vector and the Greenwich Hour Angle (GHA), AELDS will provide the satellite height and

northbound/southbound flags. Also, given the scan time, stepping time, stepping angle, and number of positions desired; AELDS can also provide the following for each scan point of a specific instrument:

- Solar zenith angle
- Satellite zenith angle
- Solar azimuth angle
- Satellite azimuth angle
- Relative azimuth angle

In order to insure that the Earth location and navigation information provided by MOD lies within acceptable accuracy limits, quality control (QC) operations are performed during and after generation of the data. At present, three types of checks are used:

- 1) Navigation: When the UEF containing predicted satellite position and velocity data is generated; the radius vector is compared to that generated using the elements for the previous seven days of data (delta-R). Generally, these differences remain less than one kilometer for at least 7 to 10 days.
- 2) On-line Earth location: An Earth location tolerance check of the satellite subpoint (nadir) location has been integrated into the AELDS process. The subpoint position is calculated by an independent method and compared with the position generated by AELDS. The acceptable value of the difference can be reset and the actual option can be turned on or off. This tolerance check gives the reassurance that the Earth location algorithm is behaving correctly.
- 3) Post processing Earth location: An image QC system is used to verify the accuracy of the Earth location data generated using the UEF and appended to the AVHRR instrument raw data in the level 1B files.

Utilization of the above image QC techniques has provided greater insight into the magnitude of Earth location errors as well as the source of some of the errors. To increase the data accuracy, MOD has enhanced the on-line Earth location process (AELDS) to include fixed attitude corrections and TIP clock corrections.

Fixed attitude corrections include corrections for errors such as instrument mounting errors and constant observed errors. An algorithm has been integrated into the Earth location process that accounts for these errors.

The Satellite Operations Control Center (SOCC) maintains the on-board clocks for the NOAA POES satellites. They monitor the accuracy of the clocks and make adjustments whenever needed. The SOCC clock adjustments are made for two reasons:

- 1) The clock has drifted outside the tolerance level and is reset or corrected to over compensate for the error. The clock error is then allowed to drift back through zero until it again exceeds the tolerance.

- 2) When a leap second is needed at the end of December or June, the TIP clock is adjusted depending on the resultant error when combined with the existing clock error.

MOD maintains clock drift files containing all SOCC corrections. These files are utilized to correct the Earth location data using the instrument scan times and are available to the user community in the following URL: <http://www.ospo.noaa.gov/Products/ppp/navpage.html>.

Generally, after the fixed attitude corrections and TIP clock corrections, the Earth location error seen in the image data around the satellite subpoint remains within 1 kilometer (specifications for AVHRR are 4-5 kilometers). The error near the limb is expected to be larger, and is often less than 3 kilometers. At any time during the process, these attitude corrections may be turned on or off.

2.3.1 UPDATES TO THE TBUS BULLETIN

The TBUS bulletin is a major source of orbital data for direct readout users. Although, the UEF is used in creating all four parts of the TBUS bulletin, MOD's focus is on Part IV of the bulletin. More information on the TBUS bulletin can be obtained from section 5.1 and Appendix A. MOD, in conjunction with SOCC, has outlined steps to make Part IV more user-friendly and to increase the accuracy of the data (the Brouwer Mean elements). Action has been taken in the following areas:

- The clock correction information found in the comments section of the TBUS bulletin, was provided in a format similar to that in Part IV. The objective is to maintain consistency in the location of the clock correction information so that users can automate their process.
- The equator crossing longitude was added in the spare fields at the end of Part IV.
- Methods for improving the accuracy of the Brouwer Mean elements are under investigation.
- The BROLYD orbit prediction software package currently available to the user community will be implemented on a personal computer. Test runs of the software will be analyzed to determine modifications to the procedure, software, or algorithm that will improve the performance or accuracy. Other propagation packages that could be made available to the users will be examined to determine their usefulness.

2.3.2 NAVIGATION DATA ON THE INTERNET

The MOD Polar Navigation information can be obtained from <http://www.ospo.noaa.gov/Products/ppp/navpage.html>

- TBUS messages - Both current and limited historical TBUS bulletins are available for each of the operational NOAA polar satellites.

- Brouwer/Lyddane Software Package - This package exists on the network as part of the NOAA Polar Orbiter Data Users Guide and also as Appendix B in this document.

The following entries are a part of the navigation page:

- Graphical orbit locator - This locator can be used to plot the orbit subtrack for NOAA polar orbiters either on a map of the Northern Hemisphere, Southern Hemisphere, or Equatorial Equal Spaced projection. Directions for the use of the locator are included in the page. An example of the plots available through this software are shown in Figures 2.3.2-1 and 2.3.2-2.
- Equator crossing data - Files for each of the operational polar satellites are presented on this page. Current data and limited historical data are available. Each file contains entries for one hundred orbits showing the equator crossing time in the form of a modified Julian day number (Julian day minus 2400000.5) and Gregorian calendar date with time in hours/minutes/seconds. The equator crossing longitude (East) and orbit number are also provided for each entry. An example of the equator crossing data for NOAA-14 is shown in Figure 2.3.2-3 (note that the column and row separators in this figure do not appear in the data itself).
- Earth location algorithm - The Earth location algorithm used in the AELDS software is provided in Appendix I and as a link in the overview from the navigation page.
- TIP Clock Error Database - The file used by the AELDS process to correct Level 1b data for TIP clock errors is available on the navigation page. There are files for each of the operational polar satellites. The files contain entries in chronologically ascending order (newest update first). An example of the contents of the file is given in Figure 2.3.2-4.

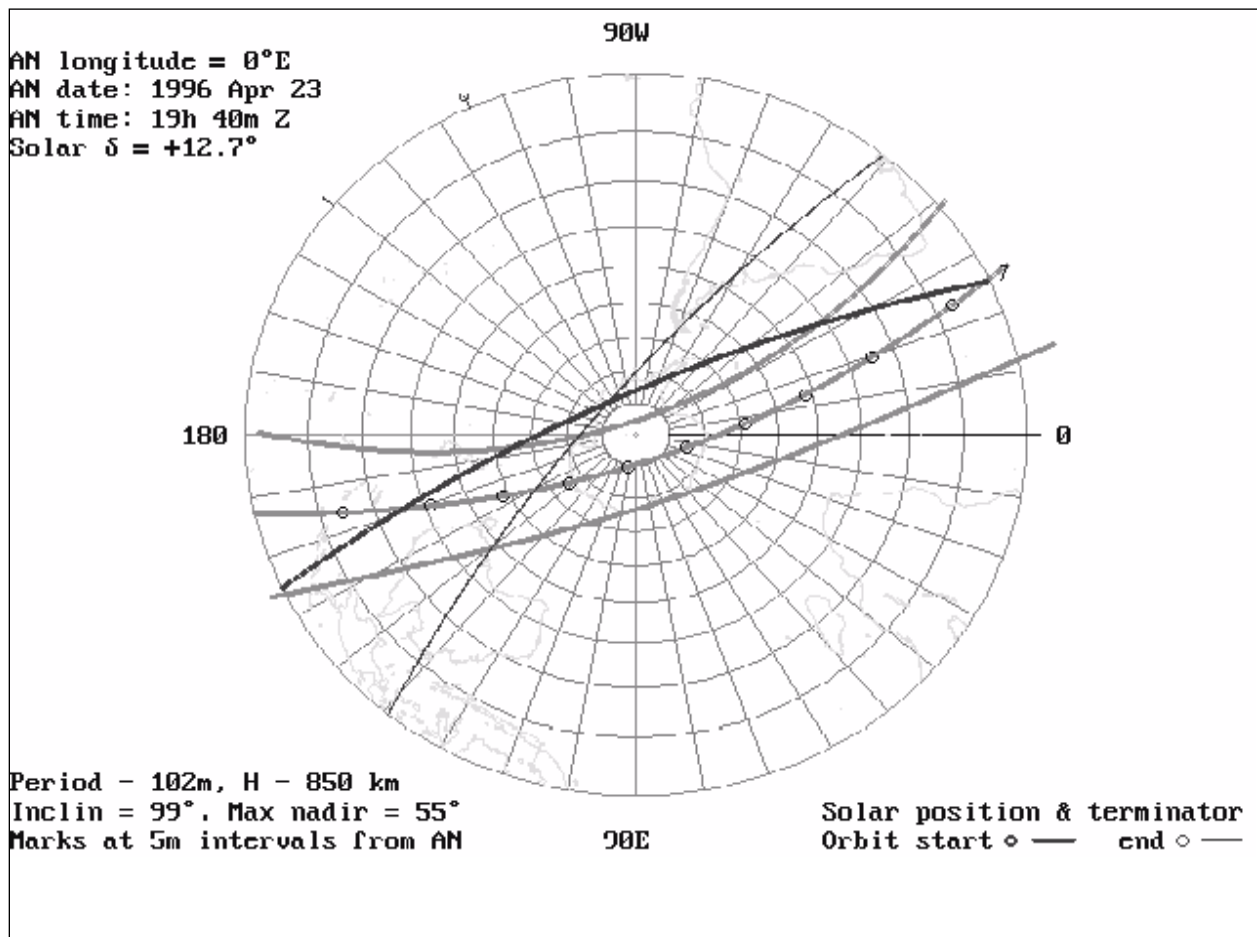

Figure 2.3.2-1. Sample plot available from Graphical orbit locator.

The MOD updates or enhancements to the navigation and Earth location process are on going. For example, an Earth location error database is planned for Level 1b data users. This database will contain Earth location error information based on actual error measurements taken from AVHRR imagery. Every attempt was made to keep the current systems compatible with the prior satellite series.

Figure 2.3.2-2. Sample plot available from Graphical Orbit Locator.

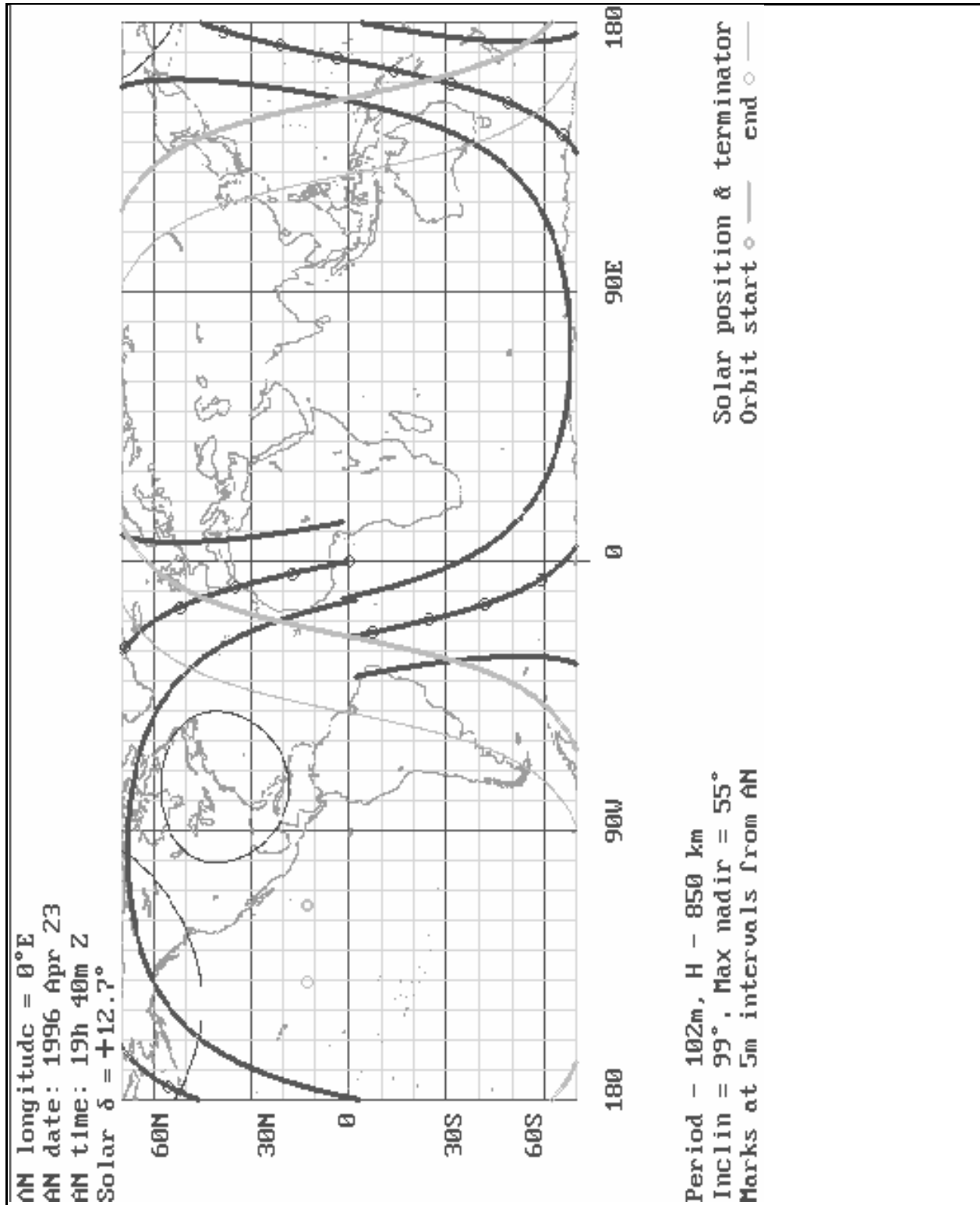

Table 2.3.2-1. Sample NOAA-14 Equator Crossing Data.

N	REV NUM	EQ.XING.TIME (MJD)	Year	Month	Day	Hour	Min	Second	EQ.XING LONGITUDE
1	6893	0.502049988306D+05	1996	5	1	23	58	18.961	208.8628
2	6894	0.502050697122D+05	1996	5	2	1	40	23.132	183.3453
3	6895	0.502051405938D+05	1996	5	2	3	22	27.303	157.8277
4	6896	0.502052114754D+05	1996	5	2	5	4	31.474	132.3106
5	6897	0.502052823570D+05	1996	5	2	6	46	35.646	106.7937
6	6898	0.502053532386D+05	1996	5	2	8	28	39.817	81.2773
7	6899	0.502054241202D+05	1996	5	2	10	10	43.988	55.7614
8	6900	0.502054950018D+05	1996	5	2	11	52	48.159	30.2455
9	6901	0.502055658835D+05	1996	5	2	13	34	52.331	4.7292
10	6902	0.502056367651D+05	1996	5	2	15	16	56.502	339.2124
11	6903	0.502057076467D+05	1996	5	2	16	59	0.673	313.6947
12	6904	0.502057785283D+05	1996	5	2	18	41	4.844	288.1778
13	6905	0.502058494099D+05	1996	5	2	20	23	9.015	262.6632
14	6906	0.502059202915D+05	1996	5	2	22	5	13.187	237.1478
15	6907	0.502059911731D+05	1996	5	2	23	47	17.358	211.6310
16	6908	0.502060620547D+05	1996	5	3	1	29	21.529	186.1136
17	6909	0.502061329363D+05	1996	5	3	3	11	25.700	160.5959
18	6910	0.502062038180D+05	1996	5	3	4	53	29.872	135.0787
19	6911	0.502062746996D+05	1996	5	3	6	35	34.043	109.5618
20	6912	0.502063455812D+05	1996	5	3	8	17	38.214	84.0453
21	6913	0.502064164628D+05	1996	5	3	9	59	42.385	58.5293

Table 2.3.2-2. Sample NOAA-14 TIP Clock Error Database.

Spacecraft ID# (NOAA-14)	Effective Time		Clock Error Millisec I5	Drift Rate Millisec/Day F7.3	Comments (Optional)
	Year/MM/DD	HH:MM:SS.SSS			
23455	1996/03/19	23:59:00.000	-035	+7.000	
23455	1995/12/31	23:59:59.000	-200	+5.000	-1.0 Leap second Adjustment
23455	1995/08/01	23:59:00.000	-560	+5.000	
23455	1995/01/01	23:59:00.000	-560	+5.000	
23455	1994/01/01	00:01:00.000	000	0.000	

2.4 INTERPOLATING THE LEVEL 1b EARTH LOCATION DATA

The geographic location of AVHRR LAC/HRPT viewed areas presents a problem, since one scan line contains 2048 viewed spots, but only 51 of these are located in the Level 1b data; point 25 being the first located point, and then every fortieth point. The scan is from right to left, when facing in the direction of satellite motion. GAC data are less of a problem, since every eighth

point is located. **It should be noted, however, that the Earth locations given for GAC areas are not in the center of the area;** see Section 2.4.4. All other instruments currently on NOAA satellites have all observed areas located. Since investigators often require the location of all observed points, the locations for points intermediate between those given in the Level 1b data must be obtained by interpolation. The common method is to interpolate linearly separately in latitude and longitude between given points. This study was undertaken to determine the accuracy of such linear interpolation, and if this method should prove insufficiently accurate, to determine an interpolation method which would yield acceptable accuracy.

2.4.1 METHOD

In order to ascertain the accuracy of an interpolation method, it is necessary to know the true location of every point. In order to simplify the computations, a spherical earth was assumed, permitting the use of spherical trigonometry. The radius was taken to be 6371 km, the approximate mean radius of the actual Earth.

The satellite altitude was assumed to be 850 km with an inclination, β , of 99 degrees, and assumed to be in the first quarter orbit (northbound, in the Northern Hemisphere), and only the right (first) half of the scan was considered. These assumptions will have no effect on the results, since the configuration is completely symmetrical. The trace of the scan line on the earth may be assumed to be a great circle, especially since only the portion of a scan which includes at most five Level 1b located points will be examined at one time. The time for this to occur is about 5 milliseconds, during which the sub-satellite point will have moved about 35 meters. The satellite position was therefore taken as fixed, and the 1024 true scan locations calculated, using a scan step of 0.0541 degrees. It should be noted that this scan step, combined with the field of view of the sensor, results in an over sampling of 1.362 samples per field of view; in other words, the LAC data overlap (see Figures 2.4.4-1 and 2.4.4-2). No attempt was made to do any calculations which involved using points on both sides of the nadir point. This is of little consequence, since interpolated positions are most accurate near nadir.

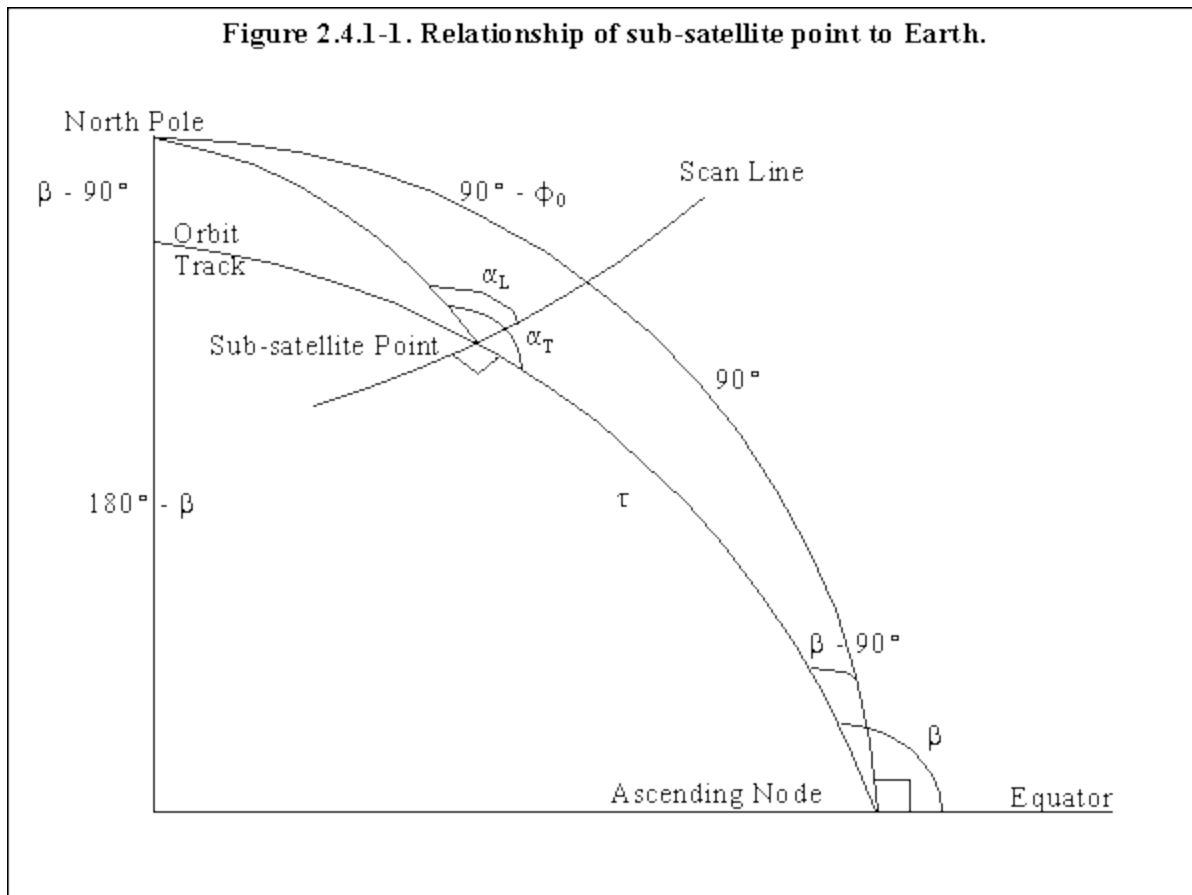

Figure 2.4.1-1. Relationship of sub-satellite point to Earth.

Since all calculations assume instantaneous conditions, it is not necessary to consider Earth rotation. ϕ_0 is the satellite latitude and zero longitude was taken to coincide with the sub-satellite point. From Figure 2.4.1-1, the angle at the sub-point from north to the sub-track is:

$$\alpha_T = \sin^{-1} \left(\frac{-\cos \beta}{\cos \phi_0} \right)$$

and the angle to the scan line is:

$$\alpha_L = \alpha_T - 90^\circ$$

For a viewing nadir angle (scan angle) σ , the corresponding geocentric arc distance is given by:

$$\theta = \sin^{-1} \left(\frac{R+H}{R} \sin \sigma \right) - \sigma$$

where R is the Earth radius and H is the satellite height (see Figure 2.4.1-2). From the spherical

$$\sin \phi = \sin \phi_0 \cos \theta + \cos \phi_0 \sin \theta \cos \alpha_L$$

triangle shown in Figure 2.4.1-3, the latitude of the viewed point, ϕ , may be found to be:

and the longitude relative to the sub point by:

$$\cos \Delta\lambda = \frac{\cos \phi_0 \cos \theta - \sin \phi_0 \sin \theta \cos \alpha_L}{\cos \phi}$$

Performing these computations for each scan step, starting at an angle from nadir of half a scan step, defines the true Earth locations to which the interpolated locations will be compared.

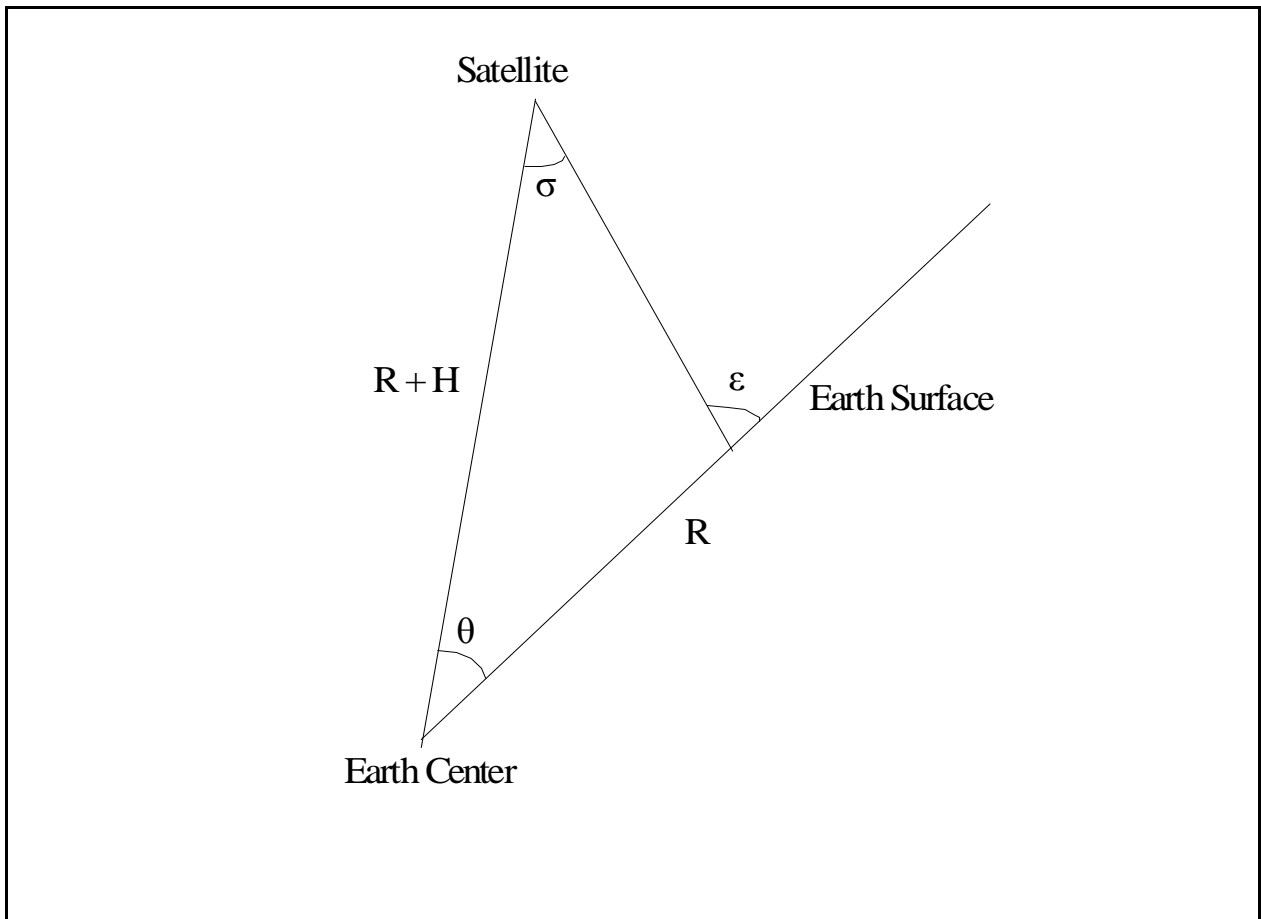

Figure 2.4.1-2. Angular relationship between satellite, surface and Earth Center

2.4.2 RESULTS

The results for linear interpolation are shown in Table 2.4.2-1. The point numbers are those of located points, and the range of scan angles are shown for each group. In each group of 39 interpolated points, the mean error and the maximum error are shown, converted to linear distance in kilometers on the surface of the Earth. For all interpolation methods, the variation with sub-point latitude is small, as would be expected as a result of the spherical assumption. For an ellipsoidal Earth, the variation may be somewhat larger. Near nadir the errors are small, but become completely unacceptable by the time the most limbward pair of points are reached.

Table 2.4.2-1. Errors for Linear Interpolation Between Adjacent Located AVHRR Points for Latitude = 40⁰.				
Point Number	Scan Angle Range (degrees)		Mean Distance (km)	Maximum Distance (km)
	From	To		
1 - 2	-54.073	-51.909	2.5082	3.8583
2 - 3	-51.909	-49.745	1.7198	2.6449
3 - 4	-49.745	-47.581	1.2518	1.9248
4 - 5	-47.581	-45.417	0.9497	1.4604
5 - 6	-45.417	-43.253	0.7427	1.1422
6 - 7	-43.253	-41.089	0.5944	0.9142
7 - 8	-41.089	-38.925	0.4844	0.7450
8 - 9	-38.925	-36.761	0.4004	0.6159
9 - 10	-36.761	-34.597	0.3348	0.5150
10 - 11	-34.597	-32.433	0.2825	0.4346
11 - 12	-32.433	-30.269	0.2401	0.3694
12 - 13	-30.269	-28.105	0.2052	0.3157
13 - 14	-28.105	-25.941	0.1760	0.2708
14 - 15	-25.941	-23.777	0.1513	0.2327
15 - 16	-23.777	-21.613	0.1301	0.2002
16 - 17	-21.613	-19.449	0.1118	0.1719
17 - 18	-19.449	-17.285	0.0957	0.1471
18 - 19	-17.285	-15.121	0.0814	0.1252
19 - 20	-15.121	-12.957	0.0685	0.1054
20 - 21	-12.957	-10.793	0.0569	0.0876
21 - 22	-10.793	-8.629	0.0463	0.0712
22 - 23	-8.629	-6.465	0.0365	0.0561
23 - 24	-6.465	-4.301	0.0274	0.0422
24 - 25	-4.301	-2.137	0.0193	0.0297

The accuracy is improved by a three point interpolation in latitude and in longitude, using the Lagrangian interpolation algorithm (see Section 2.4.3 for a discussion of this algorithm). The use of the Lagrangian method does not seem to be critical, and any three point interpolation seems to be equally good. As shown in Table 2.4.2-2, the accuracy near nadir becomes even better, while the limbward interval improves markedly, the maximum error being only 2/3 km.

Point Number	Scan Angle Range (degrees)		Mean Distance (km)	Maximum Distance (km)
	From	To		
1 - 2	-54.073	-51.909	0.4251	0.6758
2 - 3	-51.909	-49.745	0.2495	0.3961
3 - 4	-49.745	-47.581	0.1598	0.2534
4 - 5	-47.581	-45.417	0.1088	0.1724
5 - 6	-45.417	-43.253	0.0776	0.1229
6 - 7	-43.253	-41.089	0.0574	0.0908
7 - 8	-41.089	-38.925	0.0436	0.0691
8 - 9	-38.925	-36.761	0.0340	0.0538
9 - 10	-36.761	-34.597	0.0270	0.0428
10 - 11	-34.597	-32.433	0.0219	0.0346
11 - 12	-32.433	-30.269	0.0180	0.0285
12 - 13	-30.269	-28.105	0.0150	0.0237
13 - 14	-28.105	-25.941	0.0127	0.0201
14 - 15	-25.941	-23.777	0.0109	0.0172
15 - 16	-23.777	-21.613	0.0094	0.0149
16 - 17	-21.613	-19.449	0.0082	0.0130
17 - 18	-19.449	-17.285	0.0073	0.0116
18 - 19	-17.285	-15.121	0.0066	0.0104
19 - 20	-15.121	-12.957	0.0060	0.0094
20 - 21	-12.957	-10.793	0.0055	0.0087
21 - 22	-10.793	-8.629	0.0051	0.0081
22 - 23	-8.629	-6.465	0.0048	0.0076
23 - 24	-6.465	-4.301	0.0046	0.0073

There remain the 24 scan points before the first located point (23 points after the last located point) the locations of which cannot be interpolated, but must be extrapolated. Table 2.4.2-3 presents the values extrapolated from the first three located points. Since the errors change rapidly, values are given for each point. In addition to the total error in kilometers, the individual errors in latitude and longitude are also presented. The error for point 25 is exactly zero, since this is a located point. The location errors grow rapidly, being over 5 km for the limbward point

Table 2.4.2-3. Errors for Lagrangian Interpolation From Three Limbward Located AVHRR Points at Latitude = 40°.				
LAC Point	Scan Angle (degrees)	Latitude Error (degrees)	Longitude Error (degrees)	Distance Error (km)
1	55.425	0.0056	-.0633	5.3122
2	55.371	0.0052	-.0588	4.9389
3	55.317	0.0048	-.0546	4.5818
4	55.263	0.0045	-.0505	4.2403
5	55.209	0.0041	-.0466	3.9140
6	55.155	0.0038	-.0429	3.6026
7	55.101	0.0035	-.0394	3.3055
8	55.047	0.0032	-.0360	3.0225
9	54.993	0.0029	-.0328	2.7531
10	54.939	0.0026	-.0297	2.4969
11	54.884	0.0024	-.0268	2.2535
12	54.830	0.0021	-.0241	2.0226
13	54.776	0.0019	-.0215	1.8038
14	54.722	0.0017	-.0190	1.5968
15	54.668	0.0015	-.0167	1.4012
16	54.614	0.0013	-.0145	1.2166
17	54.560	0.0011	-.0124	1.0428
18	54.506	0.0009	-.0105	0.8794
19	54.452	0.0008	-.0086	0.7260
20	54.398	0.0006	-.0069	0.5824
21	54.343	0.0005	-.0053	0.4483
22	54.289	0.0003	-.0039	0.3232
23	54.235	0.0002	-.0025	0.2070
24	54.181	0.0001	-.0012	0.0994
25	54.127	0.0000	0.0000	0.0000

Table 2.4.2-4 shows the same information except with the extrapolation done with a five point Lagrangian algorithm. This shows a marked improvement, with the maximum error being only slightly greater than 1 km. This would probably be sufficiently accurate for almost all purposes. It should be noted that while the nominal Earth field of view of AVHRR is 1.1 km, this is true only at nadir. The limbwardmost coverage is 6.5 x 2.3 km. A 1 km location error is thus much less than the size of a field of view.

Table 2.4.2-4. Errors for Lagrangian Interpolation From Five Limbward Located AVHRR Points at Latitude = 40⁰.				
LAC Point	Scan Angle (degrees)	Latitude Error (degrees)	Longitude Error (degrees)	Distance Error (km)
1	55.425	0.0014	-.0121	1.0231
2	55.371	0.0013	-.0111	0.9388
3	55.317	0.0012	-.0102	0.8595
4	55.263	0.0011	-.0093	0.7850
5	55.209	0.0010	-.0085	0.7150
6	55.155	0.0009	-.0077	0.6493
7	55.101	0.0008	-.0070	0.5878
8	55.047	0.0007	-.0063	0.5302
9	54.993	0.0007	-.0056	0.4764
10	54.939	0.0006	-.0050	0.4261
11	54.884	0.0005	-.0045	0.3793
12	54.830	0.0005	-.0040	0.3358
13	54.776	0.0004	-.0035	0.2953
14	54.722	0.0004	-.0031	0.2577
15	54.668	0.0003	-.0026	0.2230
16	54.614	0.0003	-.0023	0.1909
17	54.560	0.0002	-.0019	0.1613
18	54.506	0.0002	-.0016	0.1341
19	54.452	0.0002	-.0013	0.1091
20	54.398	0.0001	-.0010	0.0862
21	54.343	0.0001	-.0008	0.0654
22	54.289	0.0001	-.0006	0.0465
23	54.235	0.0000	-.0003	0.0293
24	54.181	0.0000	-.0002	0.0139
25	54.127	0.0000	0.0000	0.0000

2.4.3 LAGRANGIAN INTERPOLATION

Given a set of n coordinates, x_i, y_i , where $i = 1$ to n , a general value of y is given by

$$y = \sum_{i=1}^n y_i L_i$$

Where

$$L_i = \prod_{j=1, j \neq i}^n \frac{(x - x_j)}{(x_i - x_j)}$$

x being the value corresponding to the y which is being sought (the symbol \mathcal{Q} indicates a product). It should be noted that the given x points must all be different. However, the points need not be equally spaced, and it is not necessary that they be in order (Meeus, 1991).

A schematic computer program for performing Lagrangian interpolation follows:

n	Number of input points
x(1),y(1) x(2),y(2), ... x(n),y(n)	Input points
x0	X for which Y is to be interpolated
y0=0	Interpolated value of Y
for i=1 to n	
L=1	
for j=1 to n	
if j \neq i then L=L*(x0-x(j))/(x(i)-x(j))	
next j	
y0=y0+L*y(i)	
next i	

2.4.4 LOCATION OF GAC SPOTS

GAC values are calculated on board the satellite by the following procedure (paraphrased from the Advanced TIROS-N Program, Programming and Control Handbooks for NOAA-KLM and NOAA-N, Section 5.5.3.2.3):

Processed GAC earth data is derived from the earth view portion of every third AVHRR scan line. The starting AVHRR scan is not specified, but the GAC lines are tagged with the times of the AVHRR scans from which they are derived.

The data for each of the five AVHRR channels is processed in accordance with the following five sample-averaging algorithms:

- (1) Select only every third AVHRR scan line for data processing. Start with the first AVHRR data sample in the selected scan line.
- (2) From the selected scan line, obtain 5 contiguous AVHRR data samples.
- (3) Retain the data from the first four samples, and discard the data from the fifth sample.
- (4) Form a sum by adding together the data from samples 1, 2, 3 and 4. Form the sum in 12-bit precision.

(5) Divide the sum by four to obtain an “averaged” GAC data word. Round the quotient to 10 bits.

(6) Repeat steps (2) through (5), starting with the next AVHRR data sample, for a total of 409 times to generate the required GAC data words for one scan line. Since each AVHRR line includes 2048 data samples, the final 4 samples of the scan line will be skipped.

(7) Repeat steps (1) through (6) for all the AVHRR scan lines.

Thus, the first AVHRR data sample of each selected scan line is averaged into the first GAC sample of its line, but the last four AVHRR samples of the line are skipped.

The earth location of the centers of 51 selected AVHRR data samples out of 4028 from each scan line are calculated by the Advanced Earth Location Data System during the preprocessing of the data on the ground, and they are included in the level 1B AVHRR data sets. The 25th data sample of a scan and every 40th thereafter are selected. These same earth locations are included in GAC level 1B data sets for certain GAC samples. For an earth located GAC spot, the earth location matches the missing AVHRR sample from the 5 used in generating that GAC spot. The 5th GAC data sample of each GAC line and every 8th sample thereafter are earth located in level 1B.

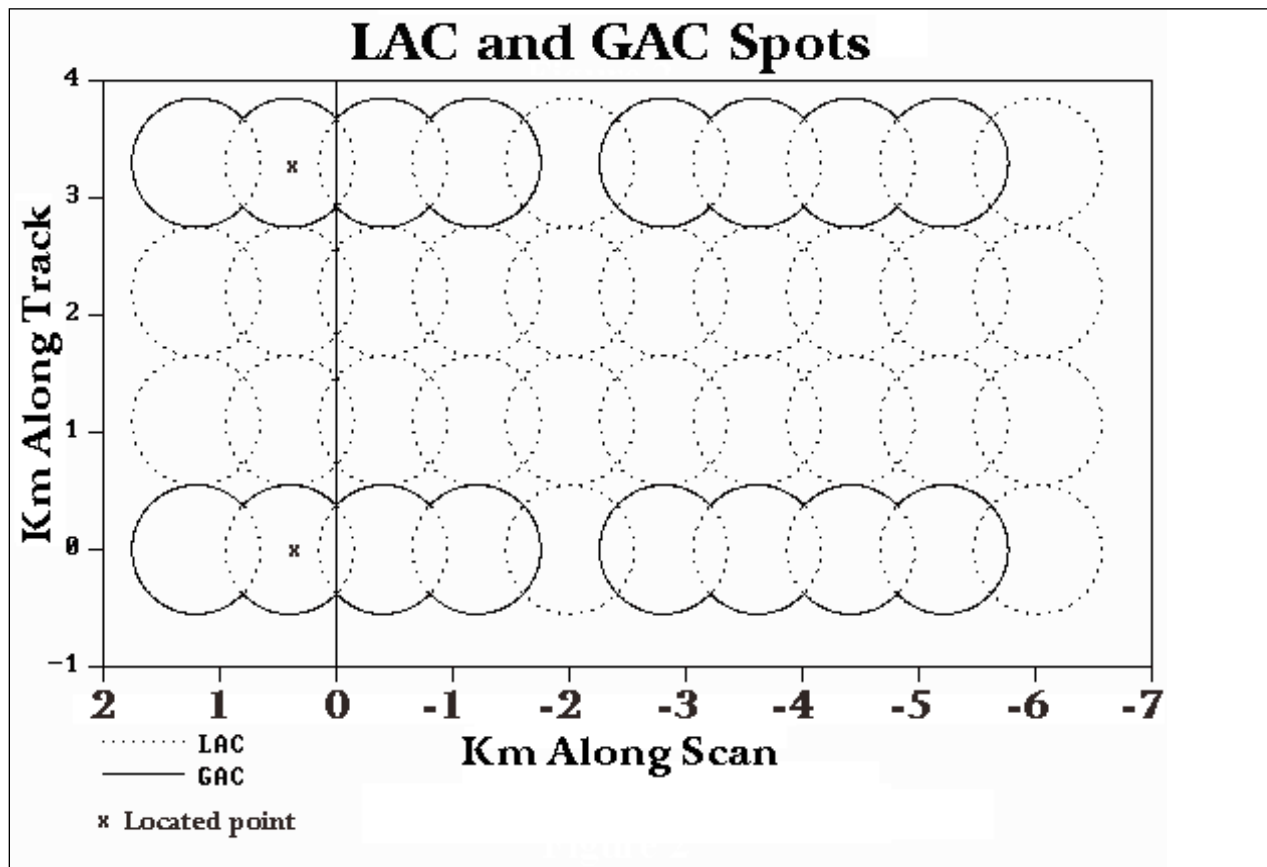

Figure 2.4.4-1. Earth Location of LAC and GAC spots near nadir.

As shown in figure 2.4.4-1, the earth location given for a located GAC spot is NOT that of the center of the spot, the location of the center of the skipped fifth AVHRR spot of the five which constitute a GAC.

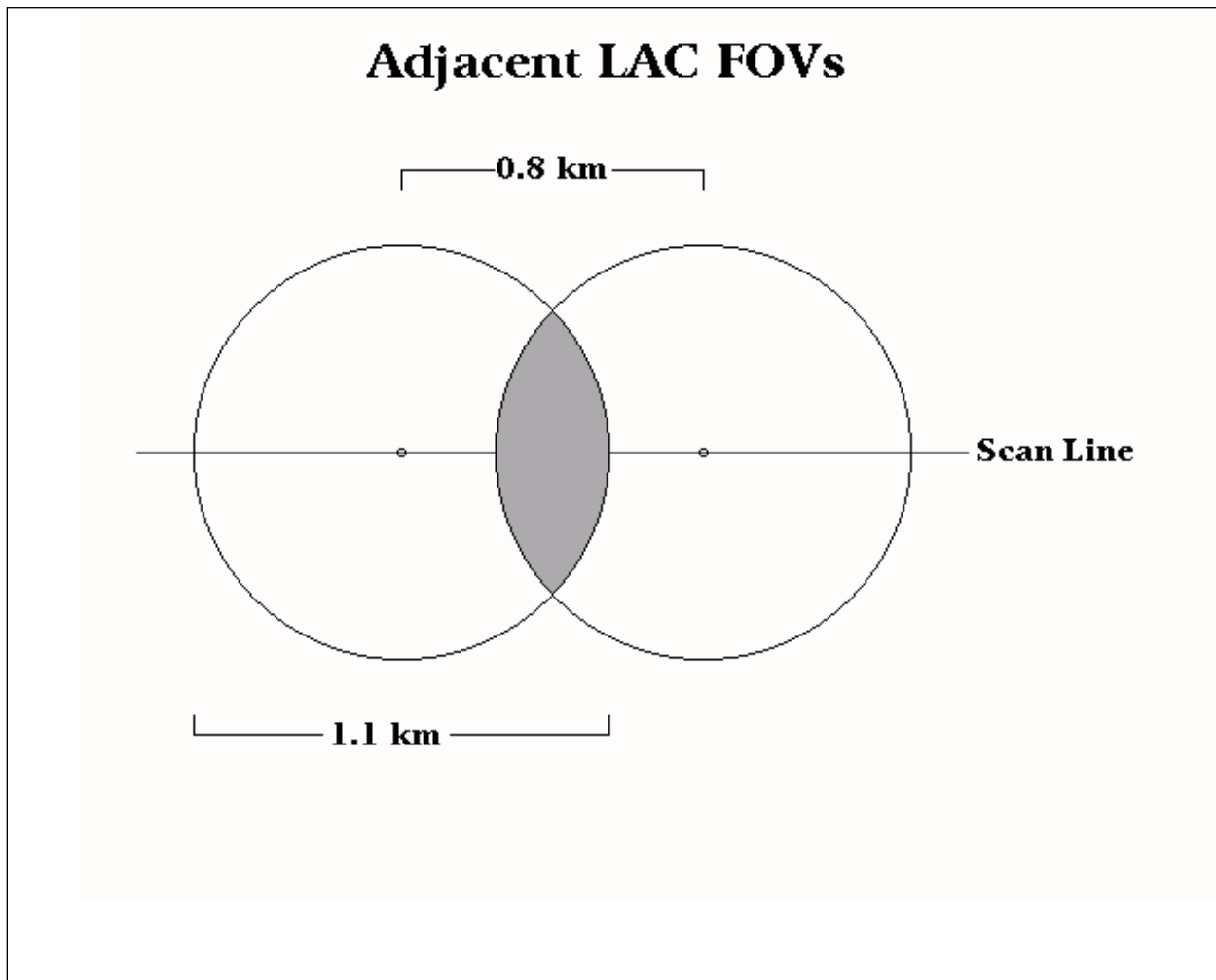

Figure 2.4.4-2. Position of the two LAC spots that straddle nadir.

Figure 2.4.4-2 shows the two AVHRR spots which straddle the nadir. At this position, the Earth location is displaced 2 kilometers from the center of the corresponding GAC spot (see figure 2.4.4-1). At large angles from nadir, the displacement will be larger, but since the Earth field of view will also be stretched in the scan direction (to 6.5 km for the limbmost AVHRR position), the proportional difference will remain the same.

Figure 2.4.4-2 shows the two LAC spots which straddle nadir. At this position, the Earth location given is displaced 0.4 km from the center of the corresponding GAC spot. At large

nadir angles, the displacement will be larger, but since the Earth field of view will also be stretched in the scan direction (to 6.5 km for the limbwardmost LAC position), the proportional difference will remain the same.

3.0 DESCRIPTION OF THE NOAA KLM SENSOR PACKAGE

This section describes the characteristics of the NOAA KLM series instruments. The normal suite of instruments onboard the NOAA KLM series includes the following instruments: AVHRR/3, HIRS/3, AMSU-A and -B, SEM-2, DCS/2, SARSAT and sometimes SBUV/2. A detailed description of each instrument is provided in the respective subsections shown below. The instrument descriptions contain information such as spectral channel characteristics, system performance characteristics and additional information on the modules or subsystems that comprise the instrument. Table 1.2.1.3-1 provides a list of sensors flown onboard on each NOAA KLM spacecraft.

3.1 ADVANCED VERY HIGH RESOLUTION RADIOMETER/3 (AVHRR/3)

3.1.1 INSTRUMENT OPERATION

This section describes the six channel Advanced Very High Resolution Radiometer (AVHRR/3) developed by ITT-A/CD. The AVHRR/3 is used as the meteorological imaging system of the NOAA KLM spacecraft.

The AVHRR/3 is an imaging system in which a small field of view (1.3 milliradians by 1.3 milliradians) is scanned across the earth from one horizon to the other by continuous 360 degree rotation of a flat scanning mirror. The orientation of the scan lines is perpendicular to the spacecraft orbit track and the speed of rotation of the scan mirror is selected so that adjacent scan lines are contiguous at the subsatellite (nadir) position. Complete strip maps of the earth from pole to pole are thus obtained as the spacecraft travels in orbit at an altitude of approximately 833 km (450 n. miles). The analog data output from the sensors is digitized on board the satellite at a rate of 39,936 samples per second per channel. Each sample step corresponds to an angle of scanner rotation of 0.95 milliradians. At this sampling rate, there are 1.362 samples per IFOV. A total of 2048 samples is obtained per channel per Earth scan, which spans an angle of ± 55.4 degrees from the nadir (subpoint view). All six spectral channels of the AVHRR/3 are registered so that they all measure energy from the same spot on the earth at the same time. All six channels are also calibrated so that the signal amplitude in each channel is a measure of the scene radiance. Although the AVHRR/3 has six channels, only five are transmitted to the ground at any one time. The radiometers are designed to operate within specification for a period of three years in orbit.

3.1.2 SYSTEM DESCRIPTION

3.1.2.1 General

The AVHRR/3 is a six channel scanning radiometer providing three solar channels in the visible-near infrared region and three thermal infrared channels. The AVHRR/3 has two one-micrometer wide channels between 10.3 and 12.5 micrometers. The instrument utilizes a 20.32 cm (8 inch) diameter collecting telescope of the reflective Cassegrain type. Cross-track scanning is accomplished by a continuously rotating mirror directly driven by a motor. The three thermal

infrared detectors are cooled to 105 Kelvin (K) by a two-stage passive radiant cooler. A line synchronization signal from the scanner is sent to the spacecraft MIRP which in turn sends data sample pulses back to the AVHRR. Although AVHRR/3 is a six channel radiometer, only five channels are transmitted to the ground at any given time. Channels 3A and 3B cannot operate simultaneously. The data from the six channels are simultaneously sampled at a 40 kHz rate and converted to 10-bit binary form within the instrument. The data samples from each channel are output in a non-continuous burst of 10 space samples, 2048 Earth samples, and 10 internal calibration target samples per scan.

A summary of the AVHRR/3 spectral characteristics and system performance characteristics are given in Tables 3.1.2.1-1 and 3.1.2.1-2, respectively.

Table 3.1.2.1-1. Summary of AVHRR/3 Spectral Channel Characteristics.						
Parameter	Ch. 1	Ch. 2	Ch. 3A	Ch. 3B	Ch. 4	Ch. 5
Spectral Range (micrometers)	0.58-0.68	.725-1.0	1.58-1.64	3.55-3.93	10.3-11.3	11.5-12.5
Detector type	Silicon	Silicon	InGaAs	InSb	HgCdTe	HgCdTe
Resolution (km)	1.09	1.09	1.09	1.09	1.09	1.09
IFOV* (milliradian)	1.3 sq.	1.3 sq.	1.3 sq.	1.3 sq.	1.3 sq.	1.3 sq.
S/N @ 0.5% albedo	≥9:1	≥9:1	≥20:1	-	-	-
NEdT @ 300K	-	-	-	≤.12K	≤.12K	≤.12K
MTF @ 1.09 km	>.30	>.30	>.30	>.30	>.30	>.30
Temperature Range (K)	-	-	-	180 - 335	180 - 335	180 - 335
* Tolerance on IFOV values are ±0.2 mr with a ±0.1 mr design goal.						

Table 3.1.2.1-2. AVHRR/3 System Performance Characteristics.	
Parameter/Characteristic	Value
Telescope	8 in. diameter afocal Cassegrain
Scan Motor	360 rpm hysteresis - synchronous

Scan Mirror	8.25 in. x 11.6 in. Elliptical ribbed beryllium
Cooler	Two stage radiant cooler controlled @ 105 K
Data Output	10 bit parallel words
Video Sample Rate	40 kHz simultaneous sample of all channels
Output Data Rate	200 k word/sec max
Line Sync Pulse Out	100 microseconds @ 6 pps
Input Clock	0.9984 MHz
Overall Dimensions	31.33 in. x 14.35 in. x 11.5 in.
Weight	73 lbs.
Line to Line Scan Jitter	± 17 microseconds
Scan Sync Drift/24 hours	<3.0 microseconds
Calibration Accuracy	
- relative	1 NEdT
- absolute	Traceable to NIST
ICT monitor accuracy	0.1 degree C
Power	
Orbital Average	27W
Main Supply Bus Voltage	Nominal 28±0.56V (16-38V range)
Interface Bus Voltage	Nominal 10±0.5V (9-15V range)
Radiated EMI	
SAR Bands	-150 dBm
Instrument Temperature Range	
Operating	+10 to +30 degrees C
Storage	+5 to +30 degrees C
Survivable	-5 to +30 degrees C
Number of Telemetry channels	

Analog	22 channels (+0.2V to +5V)
Digital	15 channels (0V = "1", 5V = "0")
Commands	
Quantity	30
Amplitude	10 ± 0.7V
Duration	0.5 to 2.0 seconds
A/D Conversion	
Quantizing Level	10 bits
Accuracy (15 degrees C)	±1/2 LSB
Differential non-linearity (15 degrees C)	±1/2 LSB
Maximum Error (10 - 30 degrees C)	±1 LSB
Uncompensated Momentum	
Yaw Axis	0
Roll Axis	38 in-oz-sec, CCW, (+Y axis)
Pitch Axis	0
Maximum Angular Momentum	<0.268 Newton-m-sec
Data Sample Pulse from MIRP	
Duration	1.0 microsecond
Rate	39.936 kpps
Amplitude	5.0V
Electronic Calibration	
Ramp-Cal (during space view)	1024 levels
Volt-Cal (during earth scene)	3 levels

AVHRR/3 data is sampled only at specified times during the Earth scene and backscan regions of each scan period and not on a continuous basis.

Visible Channels 1, 2 and 3A have dual slope gain characteristics with slope intercepts as shown in Table 3.1.2.1-3.

Table 3.1.2.1-3. AVHRR/3 Visible Channel Gain and Intercept Characteristics.		
Channel	% Albedo	Counts
1, 2	0-25% 26-100%	0-500 501-1023
3A	12.5% 12.6-100%	0-500 501-1023

The data from each of the five active channels is digitized in the radiometer to a 10-bit word and brought out of the instrument as a 10-bit parallel digital output to the spacecraft MIRP. In addition to these digital signals, the line synchronization signal is also routed to the MIRP on a separate buffer isolated line.

Some differences exist when switching between Channels 3A and 3B. The Channel 3A Select and Channel 3B Select commands are received and stored in a latching relay. A set of contacts in this relay is used to indicate the relay status virtually instantaneously through the digital telemetry. The second set of contacts in the relay switches a logic level on the A/D logic board, which, in turn, is used by the A/D sample and hold board to switch the A/D input between Channel 3A and Channel 3B. This same logic level is also used by the 3A/3B select flag circuitry. Since the command relay is asynchronous, the data output will switch instantaneously between 3A and 3B, even if the scan is in the middle of a line. The select flag circuitry, however, operates differently.

When Channel 3B is selected, the patch temperature data is output every scan line (during the backscan), and every other scan line when 3A is selected. When switching from 3B to 3A, the zero volt marker between lines 5 and 6 indicates that they switched sometime during line 4. Therefore, there is one scan line of uncertainty when switching from 3B to 3A. When switching from 3A to 3B, the presence of patch temperature data between lines 11 and 12 indicates that the switch occurred sometime between lines 9 and 12. Therefore, there are two scan lines of uncertainty when switching from 3A to 3B.

The AVHRR/3 is comprised of five modules which are assembled together into a single unit instrument. These modules are:

- Scanner Module
- Electronics Module
- Radiant Cooler Module
- Optical Subsystem
- Baseplate Unit

An exploded view of the AVHRR/3 is shown in Figure 3.1.2.1-1.

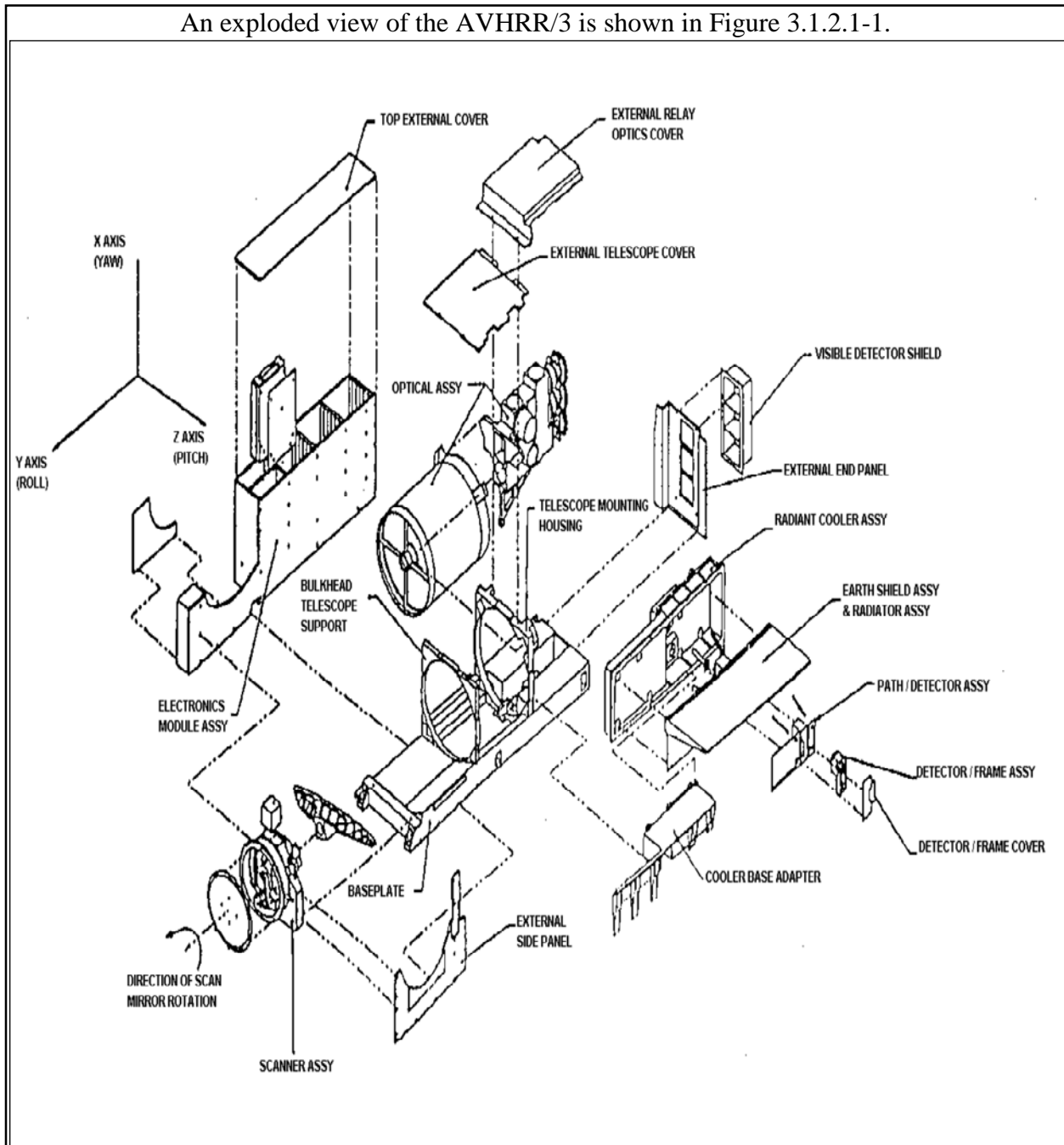

3.1.2.2 Scanner Module

This module includes the scan motor, the mirror, and the scan motor housing. The scan motor is an 80 pole hysteresis synchronous motor. The motor has two power modes of operation and is normally operated in the high-power mode (~4.5 watts) in orbit in order to minimize scan line jitter. The scanner housing is an integral part of the motor and is made of beryllium. The scan mirror is also made of beryllium and is ~29.5 cm (11.6 inches) across the major axis and 20.96

cm (8.25 inches) across the minor axis. The scan motor rotates the mirror at 360 rpm to produce a contiguous scan of the Earth scene. The line-to-line jitter is less than ± 17 microseconds. See Appendix J.1 for specific scan parameters and patterns of the AVHRR/3 instrument.

3.1.2.3 Electronics Module

The electronics module is in two sections, both of which bolt onto the instruments' inboard side panel. The curved box (Reference Figure 3.1.2.1-1) is the motor power supply. Thirty electronic circuit assemblies are used to make up the electrical system of the AVHRR/3. Twenty-two of these are located in the electronics box. The preamplifiers for Channels 1, 2, and 3A are located on the relay optics assembly. The IR Channel 4 and Channel 5 preamplifiers are located on the optics side of the electronics box. Channel 3B preamplifier is located near the 3B detector on the radiant cooler. Channels 4 and 5 preamplifier modules are accessible without the removal of the instrument from the spacecraft.

3.1.2.4 Radiant Cooler Module

The radiant cooler module is made up of four basic assemblies. These are (1) the cooler housing, (2) the first stage radiator, (3) the patch or second stage radiator and (4) the cooler cover. The first stage radiator is configured in such a manner as to shade most of its radiating area from the Earth by the cooler cover when the cover is deployed. A solenoid is used to deploy the cover. Once deployed, the cover cannot be closed. Mounted on the cold (105K) patch are the three thermal infrared detectors. The patch has a 144.5 cm^2 (22.4 in^2) radiating area.

Multi layer insulation thermally separates the first stage radiator from the housing, and the first stage optical window is thermally isolated and heated several degrees warmer than the 171 K radiator temperature to prevent condensation on it. During nominal operation the patch temperature is temperature controlled to 105 K.

3.1.2.5 Optical Subsystem

The optical subsystem consists of two subassemblies, a collecting telescope and a relay optics unit. The telescope is a 20.3 cm (8.0 inch) diameter aperture, reflective Cassegrain of a focal design (collimated output). The relay optics split the telescope exit beam into six discrete spectral bands and focus them onto their respective field stops. The spectral bands are:

- Channel 1: 0.58 to 0.68 micrometers
- Channel 2: 0.725 to 1.00 micrometers
- Channel 3A: 1.58 to 1.64 micrometers
- Channel 3B: 3.55 to 3.93 micrometers

- Channel 4: 10.3 to 11.3 micrometers
- Channel 5: 11.5 to 12.5 micrometers

The instantaneous field of view is 1.3 by 1.3 milliradians in all channels and is defined by an aperture plate in Channels 1, 2, and 3A and by the detector active areas in Channels 3B, 4, and 5. In addition, the optical subsystem has been designed to meet the total system MTF requirements with the detectors laterally displaced for channel-to-channel registration.

Polarization effects have been minimized in Channels 1, 2, and 3A by passing the optical beam transmitted by the first visible/infrared beamsplitter through a second beamsplitter of the same type which is oriented so as to compensate for polarization introduced by the first beamsplitter.

3.1.2.6 Baseplate Unit

The baseplate unit is the common structure to which all other modules are secured. Dowel pins are used to establish and maintain alignment of the scanner and optics modules. Alignment of the cooler to the optics is established by shims.

3.1.3 MIRP PROCESSING

This section is provided as an overview of the AVHRR/3 data processing that takes place in the Spacecraft Manipulated Information Rate Processor (MIRP). The MIRP sends a data sample pulse to the AVHRR/3 digital output timing logic which results in the sequential transfer of a data word for each radiometric channel. The MIRP processes these data into the following four outputs.

3.1.3.1 Automatic Picture Transmission (APT)

Any two of the six AVHRR/3 channels can be command-selected for processing. This data undergoes the following:

- (a) Resolution reduction by using every third scan line of AVHRR data.
- (b) Geometric correction to reduce the perspective effect due to the Earth's curvature and the satellite altitude. Details are contained in Section 4.2.
- (c) Digital to Analog - The digitally processed APT data are converted to a 2080 Hz bandwidth analog signal, amplitude modulated onto a 2.4 kHz carrier, and bandwidth limited to 4160 Hz in preparation for transmission by the VHF transmitters.

3.1.3.2 Global Area Coverage (GAC)

MIRP produces the GAC output by combining processed AVHRR/3 data with the TIP data. The GAC frame rate is 2 frames per sec; that is, it is one third of the AVHRR/3 frame rate. The GAC processing of the AVHRR/3 data makes the frame rates directly compatible by only using the data from every third AVHRR/3 scan. The MIRP further reduces the data by averaging the value of four adjacent samples and skipping one sample of each channel of AVHRR data across each scan line used. The TIP word and frame rate is directly compatible with the GAC word and frame rate; five TIP minor frames are inserted (at 0.1 seconds per frame) into the GAC frame each 0.5 seconds. Two parity bits are added to the 8-bit TIP word to form the 10-bit GAC word. The GAC output is supplied only to the spacecraft DTR Input Selector Unit of the XSU, and it is, therefore, not available for direct readout users.

3.1.3.3 High Resolution Picture Transmission (HRPT)

MIRP produces the HRPT and the LAC outputs by combining unprocessed AVHRR/3 data with TIP data. The basic frame rate and data rate of the HRPT is compatible with the AVHRR/3. Therefore, only buffering is required to construct the HRPT frame from the AVHRR/3 data. However, since the TIP frame rate is only one third that required to fill the HRPT frame, the TIP data must be repeated three times. This is accomplished by repeating the five TIP minor frames (104 words each) in each of three HRPT frames. As in GAC, two parity bits are added to the 8-bit TIP word to form the 10-bit MIRP word. The HRPT output is supplied to the S-band transmitter input control for real-time transmission.

3.1.3.4 Local Area Cover (LAC)

LAC is, by definition, recorded HRPT; thus, the LAC output is supplied only to the spacecraft DTR input selector for recording.

3.2 HIGH RESOLUTION INFRARED RADIATION SOUNDER (HIRS)

The first High Resolution Infrared Radiation Sounder (HIRS) instrument was developed and flown in 1975 on the Nimbus 6 satellite. Results from the Nimbus 6 orbital data and system studies showed promise of obtaining data from which improved atmospheric soundings could be derived. The basic design for the Nimbus HIRS system was modified to accommodate the TIROS-N series of spacecraft with TIROS-N orbital requirements, to improve the sensor performance, and to increase the reliability of the filter wheel drive assembly. This HIRS/2 design was used in the protoflight and seven flight models and further improved to become HIRS/2I. Three HIRS/2I units were built. Additional improvements and operational changes were made for the HIRS/3. Three HIRS/3 instruments were built for use on the NOAA KLM spacecraft.

The HIRS/4 design is a modification of the HIRS/3 design, built to fly on the NOAA-N, -N' spacecraft. The design changes for the HIRS/4 consist of: 1) radiant cooler operation at 95 K; 2) IFOV size reduced to 10 km; 3) inclusion of a fifth Internal Warm Target (IWT) temperature sensor; and 4) addition of a tertiary telescope temperature sensor. Section 3.2.1 specifically

discusses the HIRS/3 instrument (flown on NOAA KLM), while Section 3.2.2 contains descriptions of the HIRS/4 instrument (flown on NOAA-N and -N’).

3.2.1 HIRS/3

3.2.1.1 Instrument Operation

The High Resolution Infrared Radiation Sounder (HIRS/3) is a discrete stepping, line-scan instrument designed to measure scene radiance in 20 spectral bands to permit the calculation of the vertical temperature profile from Earth's surface to about 40 km.

Multispectral data from one visible channel (0.69 micrometers), seven shortwave channels (3.7 to 4.6 micrometers) and twelve longwave channels (6.5 to 15 micrometers) are obtained from a single telescope and a rotating filter wheel containing twenty individual filters. An elliptical scan mirror provides cross-track scanning of 56 increments of 1.8 degrees. The mirror steps rapidly (<35 msec), then holds at each position while the 20 filter segments are sampled. This action takes place each 100 msec. The instantaneous FOV for each channel is approximately 1.4 degrees in the visible and shortwave IR and 1.3 degrees in the longwave IR band which, from an altitude of 833 kilometers, encompasses an area of 20.3 kilometers and 18.9 kilometers in diameter, respectively, at nadir on the Earth.

Three detectors are used to sense the radiation. A silicon photodiode at the instrument temperature (nominally 15 degrees C) detects the visible energy. An Indium Antimonide detector and a Mercury Cadmium Telluride detector (mounted on a passive radiator and operating at 100 K) sense the shortwave and longwave IR energy. The shortwave and visible optical paths have a common field stop, while the longwave path has an identical but separate field stop. Registration of the fields of view in all channels is largely determined by these stops with secondary effects from detector position.

IR Calibration of the HIRS/3 is provided by programmed views of two radiometric targets: a warm target mounted to the instrument base and a view of space. Data from these views provides sensitivity calibrations for each channel every 40 lines (256 seconds), if commanded. Internally generated electronic signals provide calibration and stability monitoring of the amplifier and readout electronics.

Data from the instrument is multiplexed into a single data stream controlled by the TIP system of the spacecraft. Information from the radiometric channels and voltage telemetry are converted to 13-bit binary data. Radiometric information is processed to produce the maximum dynamic range such that instrument and digitizing noises are a small portion of the signal output. Each channel is characterized by a noise equivalent radiance (NE Δ N) and a set of calibration data that may be used to derive atmospheric temperatures and probable errors.

The HIRS/3 instrument is a single package mounted on the Instrument Mounting Platform (IMP) of the NOAA KLM spacecraft. Thermal blankets cover most outer surfaces other than that of the radiating panel and door area. The cooler radiating surface views space, emitting its heat to

provide passive radiant cooling of the shortwave and longwave detectors to the stabilized 100K operating temperature. An Earth shield on the cooler door assembly insulates the door from Earth direction thermal input. The door is closed during launch and through the initial orbital outgas period (at least 14 days). After this outgas period, the door is opened permanently for cooling of the radiator. If there are indications of contaminate accumulation subsequently, a door-open outgas procedure can be performed by applying power to the heaters located on both stages of the radiant cooler. During this procedure, the cooler temperature rises to approximately 300 K.

Table 3.2.1.1-1 lists the system characteristics of the HIRS/3 Instrument. Table 3.2.1.1-2 lists the spectral channel and sensitivity requirements for the HIRS/3. See Appendix J.2 for specific scan parameters and patterns of the HIRS/3 instrument.

Table 3.2.1.1-1. HIRS/3 System Characteristics.	
Characteristic	Value
Optical Field of View	1.4 degrees VIS/SW IR 1.3 degrees LW IR
Included Energy	98% within 1.80 degrees
Channel to channel registration	LW: <1.5% of 1.8 degrees Step size SW: <1% of Ch. 19 FOV FWHM
Earth Scan Angle	±49.5 degrees from nadir
Earth Scan Steps	56 increments of 1.8 degrees
Step and Dwell Time	100 msec total
Retrace Steps	8
Total Scan plus Retrace Time	6.4 seconds
Earth Swath coverage	1127 km
Earth Field Coverage: (SW IR) + VIS (LW IR)	20.3 km (1.4 degrees IFOV) at nadir 18.9 km (1.3 degrees IFOV) at nadir
Radiometric Calibration	290 K IWT Blackbody and Space Look
Frequency of Radiometric Calibration	256 seconds, typical
Dwell Time at Calibration Position	5.6 seconds at IWT, 4.8 seconds at space
Longwave Channels	12 (6.5 to 15 micrometers)

Longwave Detector	Mercury Cadmium Telluride
Shortwave Channels	7 (3.7 to 4.6 micrometers)
Shortwave Detector	Indium Antimonide
IR Detectors Temperature	100 K
Visible Channel	1 (0.69 micrometers)
Visible Detector	Silicon
Visible Detector Temperature	Ambient
Signal Quantizing Levels	8192 (13 bit coding)
Electronic Calibration	32 equal levels each polarity
Frequency of Electronic Calibration	One level each scan line
Telescope Aperture	15.0 cm (5.9 in)
Filter Housing Temperature	290 K (with baseplate at 283 K)

Table 3.2.1.1-2. HIRS/3 Spectral Characteristics.				
Channel Number	Central Wavenumber (cm⁻¹)	Wavelength (micrometers)	Half Power Bandwidth (cm⁻¹)	Noise Equivalent Delta Radiance (NEΔN) mW/(m²-sr-cm⁻¹)
1	669	14.95	3	3.00
2	680	14.71	10	0.67
3	690	14.49	12	0.50
4	703	14.22	16	0.31
5	716	13.97	16	0.21
6	733	13.64	16	0.24
7	749	13.35	16	0.20
8	900	11.11	35	0.10
9	1,030	9.71	25	0.15

10	802	12.47	16	0.15
11	1,365	7.33	40	0.20
12	1,533	6.52	55	0.20
13	2,188	4.57	23	0.006
14	2,210	4.52	23	0.003
15	2,235	4.47	23	0.004
16	2,245	4.45	23	0.004
17	2,420	4.13	28	0.002
18	2,515	4.00	35	0.002
19	2,660	3.76	100	0.001
20*	14,500	0.690	1,000	0.10% albedo
*Visible Channel				

3.2.1.2 System Description

3.2.1.2.1 Introduction

The HIRS/3 is a 20-channel scanning radiometric sounder utilizing a stepping mirror to accomplish cross-track scanning, directing the radiant energy from the Earth to a single, 15.24 cm (6-inch) diameter telescope assembly every tenth of a second. Collected energy is separated by a beamsplitter into longwave (above 6.5 micrometers) and shortwave (visible to 4.6 micrometers), passed through field stops and through a rotating filter wheel to cooled detectors. In the shortwave path, a second beamsplitter separates the visible channel to a silicon detector.

The scan logic and control set the sequence of Earth viewing steps to provide a rapid scan mirror step motion to 56 fixed positions for spectral sampling of each respective air column. The filter wheel rotation is synchronized to this step and hold sequence, with approximately one-third of the wheel blank to accommodate each step interval and with the filters positioned for sampling only after the mirror has reached the hold position. Registration of the optical fields for each channel to a given column of air is dependent to some degree on spacecraft motion and on the alignment of two field stops, which can be adjusted to reduce registration error to less than 1 percent of the field diameter.

The characteristics of the instrument temperature sensors are shown in Table 3.2.1.2.1-1, where it may be noted that calibration sources are measured very precisely.

Table 3.2.1.2.1-1. HIRS/3 Sensor Temperature Ranges.				
Channel Sensor Location	Subcomm Analog (K)	Digital “A” (K)	Approx. Digital “A” Sensitivity (Counts/K)	Nominal @ Operating Temperature
Patch - full range	90-320	90-320	53	@100K
Patch - expanded range		90-150	141	@100K
Radiator	150-320	150-320	60	@170K
Filter Wheel (F/W) Motor	260-320	260-320	71	@300K
Scan Motor	260-320*	260-320	78	@295K
Baseplate	260-320*	260-320	78	@290K
Electronics	260-320	260-320	78	@290K
Primary Mirror		260-320	78	@290K
Secondary Mirror		260-320	78	@290K
Scan Mirror		260-320	78	@290K
F/W Housing (HSG) - 1		273.15K-333.15K	152	@295K
F/W Housing (HSG) - 2		273.15K-333.15K	152	@303K
F/W Housing (HSG) - 3		273.15K-333.15K	152	@295K
F/W Housing (HSG) - 4		273.15K-333.15K	152	@295K
Internal Warm Target (IWT) – 1		273.15K-333.15K	152	@290K
Internal Warm Target (IWT) – 2		273.15K-333.15K	152	@290K
Internal Warm Target (IWT) – 3		273.15K-333.15K	152	@290K
Internal Warm Target (IWT) – 4		273.15K-333.15K	152	@290K
Internal Cold Target (ICT) – 1		243.15K-303.15K	152	@273K

Internal Cold Target (ICT) – 2		243.15K-303.15K	152	@273K
Internal Cold Target (ICT) – 3		243.15K-303.15K	152	@273K
Internal Cold Target (ICT) – 4		243.15K-303.15K	152	@273K
* Housekeeping TLM (full time temperature monitoring on switched +28 VDC BUS)				

Radiant energy is focused on cooled detectors operating at a near optimum temperature of 100K. A Mercury Cadmium Telluride detector and an Indium Antimonide detector are mounted on a two-stage radiant cooler. This assembly is large enough to have reserve cooling capacity, permitting active thermal control to maintain the detectors fixed at 100K. A system of heating the patch and first stage is provided for initial outgassing and for decontamination later if it should be required.

Electronic circuits provide the functions of power conversion, command, telemetry, and signal processing. Amplification of the inherently weak signals from the detectors is done by low noise amplifiers. Radiant signals are fed through a base reference and memory processor, multiplexed, and A/D converted by a 13-bit range system. Once converted to a digital format, the data are again multiplexed with HIRS/3 "housekeeping" data and provided as a serial data stream at the digital A output. Data from HIRS/3 are held in memory until called by the TIP request signals and clocked out of the instrument by the TIP clock.

Repetitive inclusion of electronic calibration signals and the periodic command to scan to space and one internal blackbody provides the system with a complete set of data collection, calibration, and control that permits reliable operation in orbit.

3.2.1.2.2 Scan System Description

The heart of the scan system is a stepper motor with 200 steps per rotation. Assembled to the shaft of the stepper motor are (1) a scan mirror mounted with the mirror surface plane at 45 degrees with respect to the axis of the motor shaft, (2) a DC torque motor, (3) a DC tachometer, (4) a shaft position encoder, and (5) a two contact slip ring assembly. The DC tachometer is used to derive rate information which is used to control a DC torque motor to aid stopping of the scan rotation as the scan settles into a track position or into a step position.

The drive control signals for the stepper motor are generated by a step generator which has input control features for retrotorque control, step/slew control and rotational direction control (up/down). Output from a scan regulator with power level control is applied to the motor driver to provide stepping torque levels as required.

The Scan Control logic utilizes timing signals and position commands in conjunction with position information derived from a position encoder to monitor and control performance of the system. Connections to a thermal sensor on the scan mirror are provided via two leads from the mirror through the hollow motor shaft to a slip ring assembly at the opposite end of the shaft.

3.2.1.3 Calibration Requirements

The Calibration Enable command enables the radiometric calibration control logic. Calibration is activated by the calibration start pulse (CSP) which occurs every 256 seconds. The CSP initiates a sequence of scans that provide radiometric calibration of the instrument. When the Calibration Disable command is in effect, the CSP will be ignored and the instrument will continue its normal scan sequence.

3.2.1.4 HIRS/3 Digital “A” Data

Digital “A” data is clocked into the spacecraft TIP whenever the “A₁” Data Enable Pulse is presented to the instrument. A full set of HIRS/3 operational data, including command status monitors, housekeeping information and radiance data of the 20 channels, is contained in the Digital “A” output. The HIRS/3 data repeats every 6.4 seconds as described below. The 6.4 second period contains 64 elements.

Digital “A” output is divided into “Elements” of 288 bits. One element is phased to fit into a TIP minor frame. The TIP allocates 36 8-bit words to accommodate the HIRS/3 element. These TIP words are then grouped by two in fixed locations throughout the 100 millisecond minor frame.

Sixty-four elements make up each scan. The formats for the elements repeat every 6.4 seconds and correspond to the particular parts of the scan. Elements number 0 through 55 are earth scan data (target data during the calibration sequence). Elements 56 through 63 are associated with retrace or when the mirror is slewing between positions. The elements are divided as follows:

Bits 1-26

Two 13 bit words have the same function in all 64 elements. The function assembled in these words is described in Table 3.2.1.4-1.

Table 3.2.1.4-1. Functions of Bits 1-26 in the HIRS/3 Elements.			
Word #	Bits	Function	Range (Decimal)
1	1-8	Scan Encoder Position	0 to 199
	9-13	Electronic Cal Level Indicator	0 to 31
2	1 - 6	Channel 1 Period Monitor	0 to 63

	7-12	Element Number	0 to 63
	13	Filter Sync Designator	n/a

Bits 27-286

This group of bits is divided into 20 13-bit words. The word functions are dependent on element number. These functions are given in Table 3.2.4-2. Except for the two status words in Element 63, all words are quantity where bit 1 is the sign bit and bits 2 through 13 are amplitude (0 to 4095). Bit 2 is the most significant bit (MSB) of quantity. The sign bit is: logic "1" is + and logic "0" is -.

Bits 287 and 288

In the same manner as for bits 1 through 26, these two bits have the same function in all 64 elements as shown in Table 3.2.1.4-2.

Table 3.2.1.4-2. Functions of Bits 287-288 in the HIRS/3 Elements.		
Bits	Function	Remarks
287	Valid Data Bit	logic "1" Valid Data logic "0" Ignore Radiometric Data
288	Odd Bit Parity	n/a

One HIRS/3 word is contained in two contiguous 8-bit TIP words. These two words occur in 1.899 msec. Eighteen pairs, each consisting of two Minor Frames TIP words, are required per minor frame. These eighteen words make up one HIRS/3 Element. The Digital "A" output is a serial output of 288 bits per element. The first bit (Bit 1) occurs in the MSB of TIP word 14.

Tables 3.2.4-3 and 3.2.4-4 contain the HIRS/3 Digital "A" Radiometric and housekeeping functions, and the Digital "A" Status Telemetry, respectively.

Table 3.2.1.4-3. HIRS/3 Digital “A” Radiometric and Housekeeping Functions.

Element #	Bit #	Function	Remarks
0 – 55	27-39	Radiometric Channel No. 1 (668.5 cm ⁻¹)	0 counts radiance from scene equal radiance from Filter Wheel (FW). Minus (-) values are colder than FW. Plus (+) values are warmer than FW.
	40-52	Radiometric Channel No. 17 (2,420 cm ⁻¹)	0 counts offset from FW radiance. Plus and minus are hotter and cooler than offset.
	53-65	Radiometric Channel No. 2 (680 cm ⁻¹)	No offset.
	66-78	Radiometric Channel No. 3 (690 cm ⁻¹)	No offset.
	79-91	Radiometric Channel No. 13 (2,188 cm ⁻¹)	Offset.
	92-104	Radiometric Channel No. 4 (703 cm ⁻¹)	No offset.
	105-117	Radiometric Channel No. 18 (2515 cm ⁻¹)	Offset.
	118-130	Radiometric Channel No. 11 (1365 cm ⁻¹)	No offset.
	131-143	Radiometric Channel No. 19 (2,660 cm ⁻¹)	Offset.
	144-156	Radiometric Channel No. 17 (749 cm ⁻¹)	No offset.
	157-169	Radiometric Channel No. 8 (900 cm ⁻¹)	No offset.
	170-182	Radiometric Channel No. 20 Visible (14,500 cm ⁻¹)	Black is minus. White is plus.
	183-195	Radiometric Channel No. 10 (802 cm ⁻¹)	No offset.

	196-208	Radiometric Channel No. 14 (2,210 cm ⁻¹)	Offset.
	209-221	Radiometric Channel No. 6 (749 cm ⁻¹)	No offset.
	222-234	Radiometric Channel No. 5 (716 cm ⁻¹)	No offset.
	235-247	Radiometric Channel No. 15 (2,235 cm ⁻¹)	Offset.
	248-260	Radiometric Channel No. 12 (1,533 cm ⁻¹)	No offset.
	261-273	Radiometric Channel No. 16 (2,245 cm ⁻¹)	Offset.
	274-286	Radiometric Channel No. 9 (1,030 cm ⁻¹)	Offset.
56	27-286	Positive Electronics Calibration applied to 20 radiometric channels.	Calibration level advances one of the 32 equal level steps on successive scans. The offset and gain of each channel will influence the amplitude of the signal. The calibration level applied to the (continued) electronic channels is indicated by bits 9 through 13 of the Element.
57	27-286	Negative Electronics Calibration applied to 20 radiometric channels.	Calibration level advances one of the 32 equal level steps on successive scans. The offset and gain of each channel will influence the amplitude of the signal. The calibration level applied to the (continued) electronic channels is indicated by bits 9 through 13 of the Element.
58	27-91	Internal Warm Target Temperature Sensor #1	Value repeated 5 times. Range 273 to 333 K.

	92-156	Temperature Sensor #2	Value repeated 5 times. Range 273 to 333 K.
	157-221	Temperature Sensor #3	Value repeated 5 times. Range 273 to 333 K.
	222-286	Temperature Sensor #4	Value repeated 5 times. Range 273 to 333 K.
59	27-91	Internal Cold Target Temperature Sensor #1	Value repeated 5 times. Range 243 to 303 K.
	92-156	Temperature Sensor #2	Value repeated 5 times. Range 243 to 303 K.
	157-221	Temperature Sensor #3	Value repeated 5 times. Range 243 to 303 K.
	222-286	Temperature Sensor #4	Value repeated 5 times. Range 243 to 303 K.
60	27-91	Filter Wheel Housing Temperature Sensor #1	Value repeated 5 times. Range 273 to 333K.
	92-156	Temperature Sensor #2	Value repeated 5 times. Range 243 to 303 K.
	157-221	Temperature Sensor #3	Value repeated 5 times. Range 243 to 303 K.
	221-286	Temperature Sensor #4	Value repeated 5 times. Range 243 to 303 K.
61	27-91	Patch Temperature Expanded Scale	Value repeated 5 times. Range 90 to 150 K.
	92-156	First Stage Radiator Temperature Sensor	Value repeated 5 times. Range 150 to 320 K.
	157-221	Filter Wheel Housing Heater Current	Value repeated 5 times. Range 0 to 500 ma.
	222-286	Electronic Calibration Digital to Analog Converter	Value repeated 5 times. Range 0 to 4 V.
62	27-39	Scan Mirror Temperature	Range 260 to 320 K
	40-52	Primary Telescope Temperature	Range 260 to 320 K

	53-65	Secondary Telescope Temperature	Range 260 to 320 K
	66-78	HIRS/3 Baseplate Temperature	Range 260 to 320 K
	79-91	HIRS/3 Electronics Temperature	Range 260 to 320 K
	92-104	Patch Temperature - Full Range	Range 90 to 320 K
	105-117	Scan Motor Temperature	Range 260 to 320 K
	118-130	Filter Wheel Motor Temperature	Range 260 to 320 K
	131-143	Cooler Housing Temperature	Range 260 to 320 K
	144-156	Patch Control Power	Range 0 to 80 mW
	157-169	Scan Motor Current	Range 0.65 to 1.0 ma
	170-182	Filter Motor Current	Range 100 to 300 ma
	183-195	+15 VDC	Range 15 ± 0.2 V
	196-208	-15 VDC	Range -15 ± 0.2 V
	209-221	+7.5 VDC	Range $+7.5 \pm 0.05$ V
	222-234	-7.5 VDC	Range -7.5 ± 0.05 V
	235-247	+10 VDC	Range 10 ± 0.2 V
	248-260	+5 VDC	Range 5 ± 0.2 V
	261-273	Analog Ground	Range 1 count
	274-286	Analog Ground	Range ± 1 count
63	27-39	Line Counter (Gives the number of lines from the last auto calibration sequence)	0 to 8191 (There is no sign bit used in the line counter). Reset to 0 counts is only when counter overflows.
	40-52	First Status Word	First 5 bits are instrument serial number (no sign bit). The remaining bits indicate status as shown in Table 3.2.1.4-4.

	53-65	Second Status Word	First 5 bits are zero fill. The remaining bits indicate status as shown in Table 3.2.1.4-4.
	66-78	Data Verification Binary Code	Binary code is: (1 1 1 1 0 0 1 0 0 0 1 1) Equivalent base10 value: +3875
	79-91		Base 10 value: +1443
	92-104		Base 10 value: -1522
	105-117		Base 10 value: -1882
	118-130		Base 10 value: -1631
	131-143		Base 10 value: -1141
	144-156		Base 10 value: +1125
	157-169		Base 10 value: +3655
	170-182		Base 10 value: -2886
	183-195		Base 10 value: -3044
	196-208		Base 10 value: -3764
	209-221		Base 10 value: -3262
	222-234		Base 10 value: -2283
	235-247		Base 10 value: -2251
	248-260		Base 10 value: +3214
	261-273		Base 10 value: +1676
	274-286	Base 10 value: +1992	

Table 3.2.1.4-4. HIRS/3 Digital “A” Status Telemetry.			
Element #	Bit #	Function	Logic State
First Status Word			
63	45	Instrument ON/OFF	ON=1

	46	Scan Motor ON/OFF	ON=0
	47	Filter Wheel ON/OFF	ON=0
	48	Electronics ON/OFF	ON=1
	49	Cooler Heat ON/OFF	ON=0
	50	Internal Warm Target Position	True=0
	51	Internal Cold Target Position	True=0
	52	Space Position	True=0
Second Status Word			
63	58	Nadir position	True=0
	59	Calibration Enable/Disable	Enabled=0
	60	Cooler Door Release Enable/Disable	Enabled=0
	61	Cooler Door Open	Yes=1
	62	Cooler Door Closed	Yes=1
	63	Filter Housing Heat ON/OFF	ON=0
	64	Patch Temperature Control ON/OFF	ON=0
	65	Filter Motor Power HIGH	Normal=1

3.2.2 HIRS/4

3.2.2.1 Instrument Operation

The HIRS/4 instrument provides multispectral data from one visible channel (0.69 μm), seven shortwave channels (3.7 to 4.6 μm) and twelve longwave channels (6.7 to 15 μm) using a single telescope and a rotating filter wheel containing twenty individual spectral filters. An elliptical scan mirror provides cross-track scanning of 56 steps in increments of 1.8 degrees. The mirror steps rapidly (<35 msec), then holds at each position while the optical radiation, passing through the 20 spectral filters, is sampled. This action takes place each 0.1 second. The instantaneous field of view for each channel is approximately 0.7 degrees which, from a spacecraft altitude of 833 km, encompasses a circular area of 10 km at nadir on the earth.

Three detectors are used to sense the optical radiation. A silicon photodiode, at nominal instrument temperature (15 C), detects the visible radiation. An Indium Antimonide detector and Mercury Cadmium Telluride detector (mounted on a passive radiator and operating at 95 K) sense the shortwave and longwave IR radiation, respectively. The shortwave and visible optical paths have a common field stop, while the longwave path has an identical but separate field stop. Size and registration of the optical fields of view in all channels is determined by these stops.

IR calibration of the HIRS/4 is provided by programmed views of two radiometric targets: the warm target mounted on the instrument baseplate, and a view of space. Data from these views provides sensitivity calibrations for each channel at 256 second intervals if commanded. Internally generated electronic signals provide calibration and stability monitoring of the detector amplifier and signal processing electronics.

Data from the instrument (including radiometric and telemetry information) is multiplexed into a single data stream which is controlled by the TIROS Information Processor (TIP) system in the NOAA-N, -N' spacecraft. Information from the radiometric channels and voltage telemetry are converted into 13 bit binary data. Radiometric information is processed to utilize the maximum dynamic range of the A/D Converter, such that instrument generated digitizing noise is a small portion of the output signal. Each spectral channel is characterized by a noise equivalent radiance and radiance vs. output counts calibration data that may be used to derive atmospheric temperatures and probable errors.

The HIRS/4 instrument is contained within a single package which is mounted on the Instrument Mounting Platform (IMP) of the NOAA-N, -N' spacecraft. The cooler radiating surface views space, thereby emitting its heat to provide passive radiant cooling of the shortwave and longwave detectors to the controlled operating temperature of 95 K. The cooler door includes an earth shield which insulates the radiating surfaces of the radiant cooler from earth's thermal radiation. The cooler door is closed during launch and through the initial orbital outgas period. During this procedure, the cooler temperature rises to approximately 300 K. After this outgas period, the door is opened permanently for cooling of the radiator. A door-open outgas procedure can be performed, if indications of contamination become apparent, by applying power to the heaters on both stages of the radiant cooler.

Table 3.2.2.1-1 lists the general characteristics of the HIRS/4 instrument. Table 3.2.2.1-2 lists the spectral channel and sensitivity requirements for the HIRS/4.

Table 3.2.2.1-1. HIRS/4 System Characteristics.	
Optical Field of View (FOV)	0.7 degrees all channels
Included Energy	98% within 1.80 degrees
Channel to channel registration	LW: <1.5% of Ch. 8 FOV FWHM SW: <1 % of Ch. 19 FOV FWHM

Earth Scan Angle	±49.5 degrees from nadir
Earth Scan Steps	56 increments of 1.8 degrees
Scan Step and Dwell Time	100 msec total
Scan, Slew and Retrace Intervals	0.8 seconds
Total Scan Line Time	6.4 seconds
Earth Swath Coverage	1127 km
Radiometric Calibration	286 K Internal Blackbody and Space Look
Frequency of Calibration	256 seconds
Dwell Time at Calibration Positions	5.6 seconds at IWT, 4.8 seconds at space
Longwave Channels	12 (6.5 to 15 μm)
Longwave Detector	Mercury Cadmium Telluride
Shortwave Channels	7 (3.7 to 4.6 μm)
Shortwave Detector	Indium Antimonide
IR Detectors Temperature	95 K
Visible Channel	1 (0.69 μm)
Visible Detector	Silicon
Visible Detector Temperature	Instrument Ambient
Signal Quantizing Levels	8192 (13 bit coding)
Electronic Calibration	32 equal levels (bipolar)
Frequency of Electronic Calibration	One level each scan line
Telescope Aperture	15.0 cm (5.9 inches)
Filters Temperature	290 K (with baseplate at 283 K)

Table 3.2.2.1-2. HIRS/4 Spectral Requirements.

Channel #	Channel Frequency		Half Power Bandwidth (cm ⁻¹)	Maximum Anticipated Scene Temp (K)	Specified NedN (mW/m ² -sr-cm ⁻¹)	Design Goal
	(cm ⁻¹)	(μm)				
LW 1	6685	14.95	3	280	3.00	0.75
2	680	14.71	10	265	0.67	0.25
3	690	14.49	12	240	0.50	0.25
4	703	14.22	16	250	0.31	0.20
5	716	13.97	16	265	0.21	0.20
6	733	13.64	16	280	0.24	0.20
7	749	13.35	16	290	0.20	0.20
8	900	11.11	35	330	0.10	0.10
9	1,030	9.71	25	270	0.15	0.15
10	802	12.47	16	300	0.15	0.10
11	1,365	7.33	40	275	0.20	0.20
12	1,533	6.52	55	255	0.20	0.07
SW 13	2,188	4.57	23	300	0.006	0.002
14	2,210	4.52	23	290	0.003	0.002
15	2,235	4.47	23	280	0.004	0.002
16	2,245	4.45	23	270	0.004	0.002
17	2,420	4.13	28	330	0.002	0.002
18	2,515	4.00	35	340	0.002	0.002
19	2,660	3.76	100	340	0.001	0.001
VIS 20	14,500	0.69	1000	100% A (albedo)	0.10% A	----

3.2.2.2 System Description

3.2.2.2.1 Introduction

The HIRS/4 is a 20-channel scanning radiometric sounder. It utilizes a stepping mirror to accomplish crosstrack scanning to direct the radiant energy from a 10 km nominal diameter area on the Earth into a 15 cm diameter telescope every tenth of a second. Collected energy is separated by a dichroic beamsplitter into longwave (above 6.5 μm) and shortwave (visible to 4.6 μm) components. The IR energy then passes through field stops, a rotating filter wheel and onto two cooled IR detectors. In the shortwave path, a second beamsplitter separates and directs the visible energy to a silicon detector which is at instrument ambient temperature.

The scan control and logic circuitry sets the sequence of Earth viewing steps to provide a rapid scan mirror step motion to each of 56 fixed positions for spectral sampling of each respective atmospheric column. The filter wheel rotation is synchronized to this step and hold sequence. Approximately one fourth of the wheel is blank to provide for the time required for each step interval. The filters are thus in position for sampling only after the mirror has reached the hold position. Registration of the optical fields for each channel to a given column of the atmosphere is dependent largely on the alignment of two field stops which are adjusted to reduce residual registration error to less than two percent of the field diameter and to a lesser degree, on spacecraft motion.

Radiant energy is focused onto cooled IR detectors operating at a temperature of 95 K. A longwave (LW) Mercury Cadmium Telluride (HgCdTe) detector and shortwave (SW) Indium Antimonide (InSb) detector are mounted on a two stage passive radiant cooler. This cooler has sufficient reserve cooling capacity to permit active thermal control to maintain the detectors at 95 K. The cooler and its housing are designed to minimize condensation of contaminants on critical components. Windows on the housing and first stage control external thermal input and prevent transport of contaminants to the detectors. Baffles and traps capture condensable contaminants in other areas. A system for heating the patch and first stage provides for initial orbital outgassing and for decontamination later, should it be necessary. The cold first stage windows are heated several degrees above the surrounding area, reducing contaminant condensation on their surfaces.

The HIRS/4 radiant cooler is an improved version of that used in the HIRS/3 instruments. Changes include mounting of the SW Preamplifier on the cooled patch, and adding an aperture of the vacuum housing windows to reduce thermal inputs. The cooler has an operating point of 95 K versus 100K for the HIRS/3 and a control margin of at least 5 K at 95K.

Electronic circuits provide the functions of power conversion, command, telemetry and signal processing. Initial amplification of the signals from the IR detectors is done in two low noise preamplifiers. The visible detector signal uses a separate preamplifier but joins the shortwave just after the shortwave preamplifier. Radiant signals are fed through a base reference, a memory processor, analog multiplexer, and an A/D converter with a 13-bit range. Once converted to digital format, the data are again multiplexed with “housekeeping” telemetry data

and provided as a serial data stream at the Digital “A” Output. Data from one scan element, or minor frame are held in one side of a dual path ping-pong memory until called by the TIROS Information Processor (TIP). While one side of the ping-pong memory is transferring data to the TIP, the other side is being loaded real-time with data for the next scan element. The data is sequenced out of the instrument by the TIP data clock.

Table 3.2.2.2.1-1 shows the sensor temperature ranges for the HIRS/4 instrument.

Table 3.2.2.2.1-1. HIRS/4 Sensor Temperature Ranges.					
Channel Sensor Location	Subcomm Analog (K)	Digital “A” (K)	Approx. Digital “A” Sensitivity (Counts/K)	Nominal @ Operating Temperatures	Notes
Patch - full range	90-320	90-320	53	@95K	2
Patch - expanded range		90-150	141	@95K	
Radiator	150-320	150-320	60	@167K	2
Filter Chopper (F/C) Motor	260-320	260-320	71	@300K	
Scan Motor	260-320	260-320	78	@295K	1
Baseplate	260-320	260-320	78	@290K	1
Electronics	260-320	260-320	78	@290K	
Primary Mirror		260-320	78	@290K	
Secondary Mirror		260-320	78	@290K	
Tertiary Telescope		260-320	78	@290K	
Scan Mirror		260-320	78	@290K	
F/C Housing	-1	273.15K-333.15K	152	@295K	
	-2	273.15K-333.15K	152	@303K	
	-3	273.15K-333.15K	152	@295K	
	-4	273.15K-333.15K	152	@295K	

Internal Warm Target (IWT)	- 1	273.15K-333.15K	152	@290K	
	- 2	273.15K-333.15K	152	@290K	
	- 3	273.15K-333.15K	152	@290K	
	- 4	273.15K-333.15K	152	@290K	
	-5	273.15K-333.15K	152	@290K	
Internal Cold Target (ICT)	- 1	243.15K-303.15K	152	@273K	
Notes: 1. Housekeeping TLM (full time temperature monitoring on switched +28 vDC TLM BUS) 2. PRT, all others are thermistors.					

3.2.2.2.2 Scan System Description

An elliptical scan mirror provides cross-track scanning of 56 steps in increments of 1.8°. The mirror steps rapidly (<35 msec), then holds at each position while the optical radiation, passing through the 20 spectral filters, is sampled. This action takes place each 0.1 second. The instantaneous field of view for each channel is approximately 0.7° which, from a spacecraft altitude of 833 km, encompasses a circular area of 10 km in diameter at nadir on the Earth.

3.2.2.3 Calibration Requirements

IR calibration of the HIRS/4 is provided by programmed views of two radiometric targets: the warm target mounted on the instrument baseplate, and a view of space. Data from these views provides sensitivity calibrations for each channel at 256 second intervals if commanded. Internally generated electronic signals provide calibration and stability monitoring of the detector amplifier and signal processing electronics.

3.2.2.4 HIRS/4 Digital “A” Data

Digital “A” data from the instrument is described in Table 3.2.2.4-1. The TIP clock pulse (C₁) and Data Enable pulses determine the time at which this data is called out. The TIP formatter calls out groups of 8-bit words in a sequence that multiplexes HIRS/4 data with that of other instruments on the NOAA-N, N’ spacecraft. Along with this requirement, the large quantity of instrument data to be transmitted and the use of 13-bit encoding for radiometric data, it was not possible to format the data into 8-bit segments. The HIRS/4 data is therefore provided as a continuous stream composed of 13-bit word lengths but clocked out in 8-bit words by the TIP. During any Minor Frame there are 288 bits of HIRS data which are extracted at an equivalent 8,320 bps rate.

The data format remains the same during the 56 Earth scan element time periods. During retrace, which is an interval of eight Earth scan element time periods, the data format is changed to provide for measurement of the internal electronic calibration and to sample all of the Housekeeping telemetry data.

Scan Element 0 contains the data which describes the scene at the time of viewing the first scan position. The scan positions are described later, but it should be noted that encoder position "1" occurs at the first Earth scan position and hence will be the encoder position noted during element "0". Scan element 55 designates the last Earth scan position. Scan Elements 56-63 occur during the scan mirror retrace during normal Earth scanning. These same element number designations apply also when the scan is commanded to a calibration target during the automatic calibration (Autocal) sequence. Normally, the mirror slewing motion between calibration targets takes place during the normal retrace interval except for the case of slew to the space look position where the motion occurs during scan elements 0 to 7. Therefore, space look during Autocal is only for 48 elements (8 through 55).

In order to determine when radiometric data should not be used, a Valid Data Bit is included in the data stream. This bit is a "1" when all conditions are normal and the radiometric data may be considered good. It will be "0" when the scan system is in a slew mode.

The electronic calibration level advances one level per scan line from 0 to 31, defining the step level measured in each radiometric channel during elements 56 and 57. Since both a positive and negative calibration is made during a scan line, the same level values apply for both.

The Channel 1 Period Monitor measures the time interval of the travel from the Channel 1 to the Channel 2 segments of the filter wheel on each rotation. The reading measures 1.248 MHz clock intervals during that segment, hence defines filter wheel rotation time with a resolution variation of 0.8 microseconds. This is not used in normal system data processing or evaluation but is a powerful diagnostic tool to aid in assessing the filter wheel subsystem health.

With every filter wheel revolution, a block of data is generated. This block, called an element, is 288 bits long. A scan line consists of 56 scene views and 8 retrace elements. Thus, there are 64 (56 + 8) filter wheel revolutions per line and 64 elements per scan line. Each element is numbered 0 through 63 and this 6-bit binary number is included in each element as bit location 20-25.

Filter Sync Designator is a "1" when the filter wheel is in synchronism with the data control timing system. This is diagnostic data not normally used in data collection or processing. If the Filter Sync Designator is "0" the radiometric data is not valid.

Radiant Signal Output is the 13-bit binary level measurement of the signals coming from the various detectors. The first bit is a sign bit ("1" positive, "0" is negative). The remaining twelve data bits are straight binary code in order from the most significant to least significant bit.

Minor Word Parity Check is the last bit of each minor Frame or data element and is inserted to make the total number of “ones” in that data element odd. This permits checking for loss of data integrity between transmission from the instrument and reconstruction on the ground.

Elements 58-61 contain the outputs of the temperature sensors and the ECAL DAC, sampled five times during each element. This approach provides a more accurate measurement of the more critical sensor temperatures.

In Element 62, the data multiplexer connects other voltage and temperature sensors outputs into the A/D converter for one sample each, thereby allowing monitoring of all the major test points in the system.

Element 63 contains the command status, the instrument serial number, the total line number since the last radiometric calibration (in 13-bit natural binary), and a fixed word pattern and fill bits.

Instrument Serial Number is unique for each instrument. The HIRS/4 instruments are designated 015 and 016.

Command Status is a tabulation of the state of the command relays and its complete format is contained in Table 3.2.2.4-1.

Table 3.2.2.4-1. HIRS/4 Digital “A” Data Output Format.			
Element #	Bit #	Function	Range Counts
0 - 55 (Earth Scan Elements)	1-8	Encoder Position	0 to 200
	9-13	Electronic Cal Level	0 to 31
	14-19	Channel 1 Period Monitor	0 to 63
	20-25	Element Number	0 to 63
	26	Filter Sync Designator	0 or 1
	27-286	Radiant Signal Output (20 channels x 13 bits)	0 to ±4095
	287	Valid Data Bit	0 or 1
	288	Minor Word Parity Check	0 or 1
56-63	1-26	Same as above.	
	287, 288	Same as above.	

56	27-286	Positive Electronic Calibration 13 bits for each channel (Calib. level advances one of 32 equal levels on succeeding scans)	
57	27-286	Negative Electronic Calibration 13 bits for each channel (Calib. level advances one of 32 equal levels on succeeding scans)	
58	27-91	Internal Warm Target #1, 13 bits x 5 times	
	92-156	Internal Warm Target #2, 13 bits x 5 times	
	157-221	Internal Warm Target #3, 13 bits x 5 times	
	222-286	Internal Warm Target #4, 13 bits x 5 times	
59	27-91	Internal Cold Target #1, 13 bits x 5 times	
	92-156	Ground	
	157-221	Internal Warm Target #5, 13 bits x 5 times	
	222-286	Tertiary Telescope Temp, 13 bits x 5 times	
60	27-91	Filter Housing Temp. #1, 13 bits x 5 times	
	92-156	Filter Housing Temp. #2, 13 bits x 5 times	
	157-221	Filter Housing Temp. #3, 13 bits x 5 times	
	222-286	Filter Housing Temp. #4, 13 bits x 5 times	
61	27-91	Patch Temp Expanded, 13 bits x 5 times	

	92-156	First Stage Temp, 13 bits x 5 times	
	157-221	Filter Housing Control Power/Temp, 13 bits x 5 times	
	222-286	Electronic Calibration DAC, 13 bits x 5 times	
62	27-39	Scan Mirror Temp	
	40-52	Primary Telescope Temp	
	53-65	Secondary Telescope Temp	
	66-78	Baseplate Temp	
	79-91	Electronics Temp	
	92-104	Patch Temp - Full Range	
	105-117	Scan Motor Temp	
	118-130	Filter Motor Temp	
	131-143	Radiant Cooler Housing Temp	
	144-156	Patch Control Power	
	157-169	Scan Motor Current	
	170-182	Filter Motor Current	
	183-195	+15 V DC	
	196-208	-15 V DC	
	209-221	+7.5 V DC	
	222-234	-7.5 V DC	
	235-247	+10 V DC	
	248-260	+5 VDC	
	261-273	Analog Ground	
274-286	Analog Ground		
63	27-39	Line Count	

	40	Fill Zero		
	41-44	Instrument Serial Number		
	45-52	Command Status	Command Status Bits	
	53-57	Fill Zeroes		
	58-65	Command Status	Command Status Bits	
	66-78	Binary Code (1,1,1,1,1,0,0,1,0,0,0,1,1) +3875 (base 10)	Fixed word pattern used to establish data stream synchronism with TIP	
	79-91	+1443		
	92-104	-1522		
	105-117	-1882		
	118-130	-1631		
	131-143	-1141		
	144-156	+1125		
	157-169	+3655		
	170-182	-2886		
	183-195	-3044		
	196-208	-3764		
	209-221	-3262		
	222-234	-2283		
	235-247	-2251		
	248-260	+3214		
	261-273	+1676		
	274-286	+1992		
Command Status Bits (from Element 63)	45	Instrument On/Off		On=1
	46	Scan Motor On/Off		On=0
	47	Filter Wheel On/Off	On=0	

	48	Electronics On/Off	On=1
	49	Cooler Heat On/Off	On=0
	50	Internal Warm Target Position	True=0
	51	Internal Cold Target Position	True=0
	52	Space Position	True=0
	58	Nadir Position	True=0
	59	Calibration Enable/Disable	Enabled=0
	60	Cover Release Enable/Disable	Enabled=0
	61	Cooler Cover Open	Yes=1
	62	Cooler Cover Closed	Yes=1
	63	Filter Housing Heat On/Off	On=0
	64	Patch Temp Control On/Off	On=0
	65	Filter Motor Power High	Normal=1

3.3 ADVANCED MICROWAVE SOUNDING UNIT-A (AMSU-A)

3.3.1 INSTRUMENT OPERATION

The Advanced Microwave Sounding Unit-A (AMSU-A) system is implemented in two separate modules: the AMSU-A1 and AMSU-A2. The AMSU-A is a multi-channel microwave radiometer that is used for measuring global atmospheric temperature profiles and provides information on atmospheric water in all of its forms (with the exception of small ice particles, which are transparent at microwave frequencies) from the NOAA KLM spacecraft.

AMSU-A is a cross-track, line-scanned instrument designed to measure scene radiances in 15 discrete frequency channels which permit the calculation of the vertical temperature profile from about 3 millibars (45 km) pressure height to the Earth's surface. At each channel frequency, the antenna beamwidth is a constant 3.3 degrees (at the half power point). Thirty contiguous scene resolution cells are sampled in a stepped-scan fashion every eight seconds, each scan covering 50 degrees on each side of the subsatellite path. These scan patterns and geometric resolution translate to a 50 km diameter cell at nadir and a 2,343 km swath width from the 833 km nominal orbital altitude.

3.3.2 SYSTEM DESCRIPTION

3.3.2.1 General

Hardware for the two lowest frequencies is located in one module (AMSU-A2) and that for the remaining thirteen frequencies in the second module (AMSU-A1). This arrangement puts the two lower atmospheric moisture viewing channels into one module and the oxygen absorption channels into a second common module to ensure commonality of viewing angle independent of any module and/or spacecraft misalignment due to structural or thermal distortions. The AMSU-A1's concept of multiplexing thirteen frequencies in this second module is provided by a two-antenna system. This multiplexing approach provides minimum front-end RF loss and a constant 3.3 degree antenna beamwidth with greater than 95 percent beam efficiency. The radiometer characteristics of the AMSU-A channels are summarized in Table 3.3.2.1-1.

Table 3.3.2.1-1. Channel Characteristics and Specifications of AMSU-A

Channel #	Channel Frequency (MHz)	# bands	Nominal Bandwidth (MHz)	Nominal Beamwidth (MHz)	NE Δ T (K) (Spec.)	Polarization at nadir¹	Instrument Component
1	23,800	1	270	3.3	0.30	V	A2
2	31,400	1	180	3.3	0.30	V	A2
3	50,300	1	180	3.3	0.40	V	A1-2
4	52,800	1	400	3.3	0.25	V	A1-2
5	53596 \pm 115	2	170	3.3	0.25	H	A1-2
6	54,400	1	400	3.3	0.25	H	A1-1
7	54,940	1	400	3.3	0.25	V	A1-1
8	55,500	1	330	3.3	0.25	H	A1-2
9	$f_0=57,290.344$	1	330	3.3	0.25	H	A1-1
10	$f_0 \pm 217$	2	78	3.3	0.40	H	A1-1
11	$f_0 \pm 322.2 \pm 48$	4	36	3.3	0.40	H	A1-1
12	$f_0 \pm 322.2 \pm 22$	4	16	3.3	0.60	H	A1-1
13	$f_0 \pm 322.2 \pm 10$	4	8	3.3	0.80	H	A1-1
14	$f_0 \pm 322.2 \pm 4.5$	4	3	3.3	1.20	H	A1-1
15	89,000	1	<6,000	3.3	0.50	V	A1-1

¹H indicates horizontal and V indicates vertical polarization

AMSU-A1 consists of 12 V-band channels (3 through 14) and one W-band channel (15) and associated circuitry. This module provides a complete and accurate vertical temperature profile of the atmosphere from the Earth's surface to a height of approximately 45 km.

AMSU-A2 contains the two lower frequencies (K-band channel 1 and Ka-band channel 2), and the associated scanning, calibration, processing, and power control hardware and circuitry. This module is used to study atmospheric water in all of its forms with the exception of small ice particles.

AMSU-A is configured in the following major subsystems: Antenna/Drive/Calibration Subsystem; Receiver Subsystem; Signal Processor Subsystem and Structural/Thermal Subsystem.

The AMSU microwave radiometers are heterodyne receivers, where the received radio frequency (RF) is downconverted to a lower intermediate frequency (IF). The relationship between the RF and IF signals is shown in Figure 3.3.2.1-1.

Given the IF filter band edge frequencies, f_1 and f_2 , and the central frequency, f_0 , the frequency response of a channel can be fully characterized (assuming unity response for all channels).

For the AMSU instruments, there are three types of channels:

1. Single passband channels (AMSU-A 1-4, 6-9, 15; and AMSU-B 16 and 17),
2. Double sideband channels (AMSU-A 5, 10; and AMSU-B 18-20), and
3. Quadruple sideband channels (AMSU-A 11-14).

Single passband channels can be defined as those whose bandwidth span the channel central frequency, as shown in Figure 3.3.2.1-2. Typically for these channels, stopbands are specified to reduce the effects of local oscillator noise (source of the central frequency signal). The frequency range for these channels can be expressed as:

$$f_0 - SHW - HW \rightarrow f_0 - SHW \tag{3.3.2.1-1}$$

and

$$f_0 + SHW \rightarrow f_0 + SHW + HW \tag{3.3.2.1-2}$$

Figure 3.3.2.1-1. Frequency translation of a broadband signal in heterodyne reception. Adapted from Figure 1.9b in "Atmospheric Remote Sensing by Microwave Radiometry," M. Janssen ed., John Wiley, 1993.

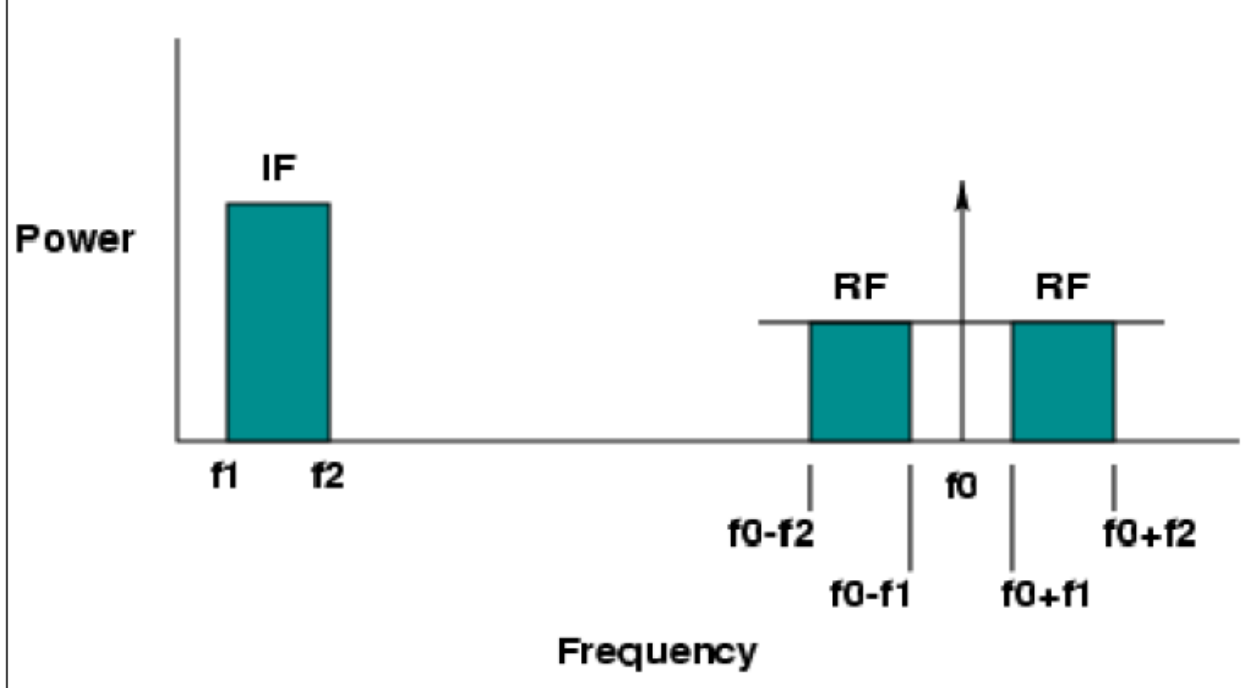

Figure 3.3.2.1-1 Frequency translation of a broadband signal in heterodyne reception.

to exclude the stopband frequencies. Comparison to Figure 3.3.2.1-1 would give:

$$f_1 \approx SHW \text{ and } f_2 \approx SHW + HW \quad (3.2.2.1-3)$$

For those AMSU channels that have relatively narrow stopbands (channels 1-4, 6-9; around 18MHz) the difference between calculating Planck radiances using the frequency response shown in equations 3.3.2.1-1 and 3.3.2.1-2 and a simple $f_0 - HW \rightarrow f_0 + HW$ is a fraction of a thousandth of a degree. Note for AMSU channels 15-17, the stopband widths are about 800-1000 MHz and should always be considered.

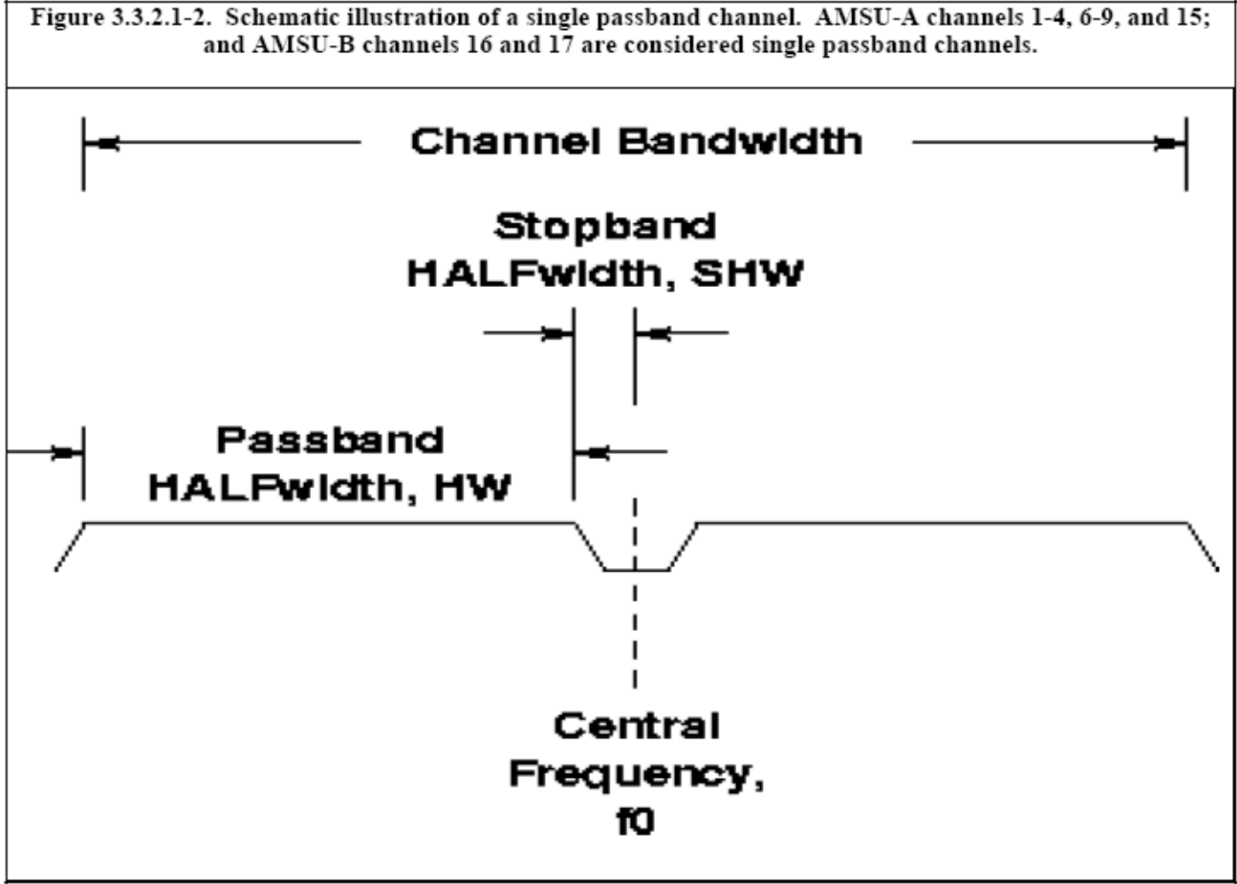

Figure 3.3.2.1-2. Schematic illustration of a single passband channel.

Double sideband channels are shown schematically in Figure 3.3.2.1-3. These channels are also referred to as folded passbands with the lower frequency sideband referred to as the lower sideband and the higher frequency sideband being the upper sideband. For these channels the frequency response of the lower sideband can be expressed as:

$$f_0 - df - HW \rightarrow f_0 - df + HW \quad (3.3.2.1-4)$$

For the upper sideband, it can be expressed as:

$$f_0 + df - HW \rightarrow f_0 + df + HW \quad (3.3.2.1-5)$$

Comparison to Figure 3.3.2.1-1 would give,

$$f_1 \equiv df - HW \quad \text{and} \quad f_2 \equiv df + HW \quad (3.3.2.1-6)$$

where df is the offset to the *center* of the sideband.

Quadruple sideband channels are shown schematically in figure 3.3.2.1-4. They resemble two double sideband “subchannels” on either side of the channel central frequency (Note: “subchannels” is not a common or rigorous term and is used here for explanation only).

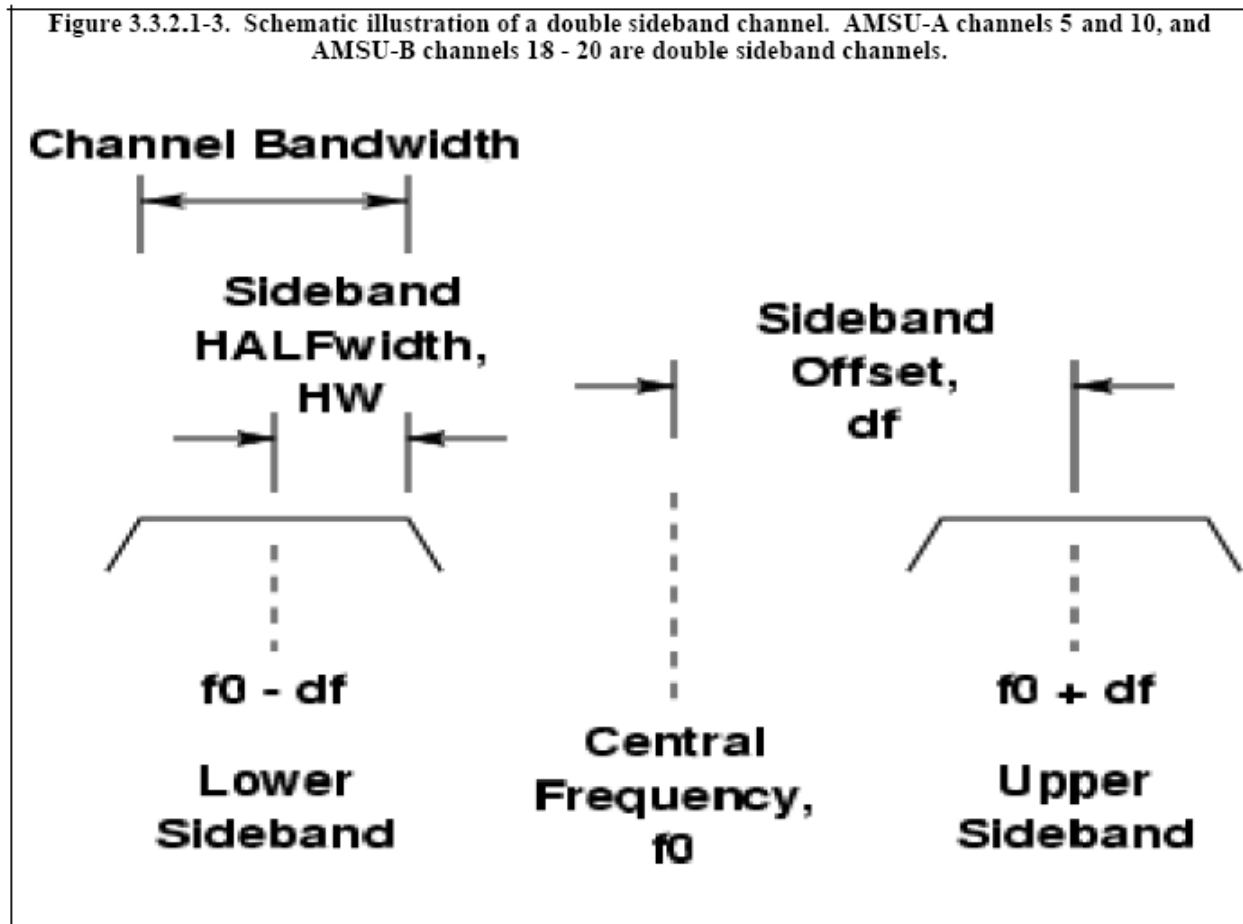

Figure 3.3.2.1-3. Schematic illustration of a double sideband channel.

For the lower “subchannels,” the frequency response can be expressed as:

$$f_0 - df_1 - df_2 - UHW \rightarrow f_0 - df_1 - df_2 + UWH \quad (3.3.2.1-7)$$

and

$$f_0 - df_1 + df_2 - LHW \rightarrow f_0 - df_1 + df_2 + LHW$$

and for the upper “subchannels” the frequency response can be expressed as:

$$f_0 + df_1 - df_2 - LHW \rightarrow f_0 + df_1 - df_2 + LWH \quad (3.3.2.1-8)$$

and

$$f_0 + df_1 + df_2 - UHW \rightarrow f_0 + df_1 + df_2 + UHW$$

Comparison to Figure 3.3.2.1-1 gives four IF values. Two for the lower sideband:

$$f_1 \equiv df_1 - df_2 - LHW \text{ and } f_2 \equiv df_1 - df_2 + LHW \quad (3.3.2.1-9)$$

and two for the upper sideband:

$$f_3 \equiv df_1 + df_2 - UHW \text{ and } f_4 \equiv df_1 + df_2 + UHW \quad (3.3.2.1-10)$$

where df_1 and df_2 are the offsets to the center of the sidebands.

Figure 3.3.2.1-4. Schematic illustration of a quadruple sideband channel.

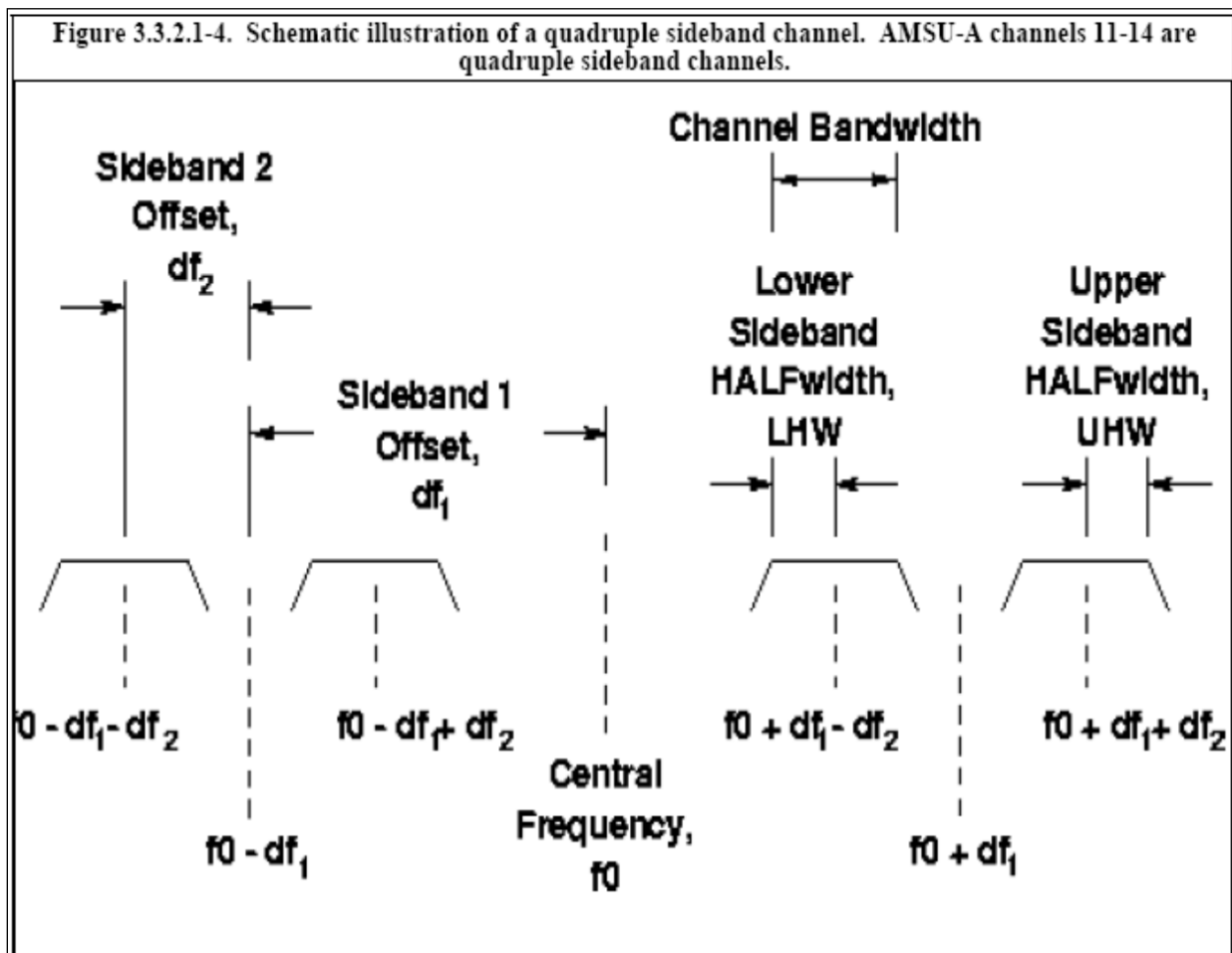

3.3.2.2 Antenna/Drive/Calibration System

The Antenna/Drive/Calibration subsystem consists of a conical corrugated horn-fed shrouded reflector, multiplexer, closed-loop antenna scan drive assembly and closed path calibration assembly. The shrouded reflector is rotated once every scan line (8 sec) for:

- each of 30 earth viewing scene observations,

The Antenna/Drive/Calibration subsystem consists of a conical corrugated horn-fed shrouded reflector, multiplexer, closed-loop antenna scan drive assembly and closed path calibration assembly. The shrouded reflector is rotated once every scan line (8 sec) for:

- each of 30 earth viewing scene observations,
- a view of the cosmic background (~2.73 K), and
- a view of a warm calibration load (~300 K).

During the rotation cycle, the shroud prevents solar reflections from interacting with the warm load and also ensures maximum coupling of the source radiation to the antenna feed. A complete end-to-end in-flight calibration is achieved in a through-the-antenna method, which provides maximum in-flight calibration accuracy. The accuracy of the warm calibration load brightness temperature is better than ± 0.2 K. The closed loop antenna scan drive provides beam pointing accuracy within ± 0.2 degrees. A resolver in the antenna drive assembly provides antenna beam position information.

The AMSU-A1 modules contain two antenna assemblies: designated A1-1 and A1-2. Antenna A1-1 is located the farthest from Earth in-flight and provides inputs to channels 6 and 7 and channels 9 through 15. A1-2 is located closest to Earth in-flight and provides input to channels 3 through 5 and 8. Table 3.3.2.2-1 shows the number of PRTs contained in each of the AMSU-A modules. Figures 3.3.2.2-1 and 3.3.2.2-2 show actual photos from NASA for AMSU-A1 and AMSU-A2.

Table 3.3.2.2-1. The number of PRTs in each AMSU-A module.		
Instrument		Number of PRTs
AMSU-A1	A1-1	5*
	A1-2	5*
AMSU-A2		7*

*The number of PRTs specified for each calibration target in the AMSU-A instrument is four: Five were provided for AMSU-A1 and seven for AMSU-A2. The NOAA-K AMSU-A1 has one of the five PRTs inoperable.

The antenna beam width of all AMSU-A channels is 3.3 degrees. The beamwidth is defined as the half-power points beamwidth (HPBW). The beamwidth in any plane containing the main

beam axis (electrical boresight axis) is within $\pm 10\%$ of the 3.3 degree value. Beamwidth variation from channel to channel is smaller than 10% of the specified beamwidth value.

The polarization angle changes as a function of the scan angle. The polarization angle is defined as the magnitude of the angle between the electric field vector of the incoming radiation and a line which is the intersection of a plane perpendicular to the propagation direction of the incoming radiation and a plane tangent to the earth surface. Scan angle is defined as the angle between nadir and the antenna electrical boresight direction. Vertical polarization is defined as having the polarized vector in the sun-nadir plane when the beam is pointing at nadir. Horizontal polarization is defined as having the polarization vector in the velocity-nadir plane when the beam is pointing at nadir.

Each channel of the AMSU-A is considered to form a beam. All main beam axes of the AMSU-A are coincidental, i.e., they are pointing in the same direction at the same time for any given beam position. The AMSU-A beams have cross-track scanning. All beams scan in a plane perpendicular to the spacecraft orbital velocity vector. The sense of the scan is counter clockwise as one looks along the spacecraft orbital velocity direction, namely, the antenna scans from the sun direction through nadir to the cold space direction.

The scanning profile of AMSU-A is a “step” scan type. The instrument’s FOV rotates to a data collection position, stops, collects data, and then moves to the next collection position, stops, collects data, etc. The instrument starts at each earth position 1, then goes sequentially to earth position 30, then to the cold calibration view position, and then to the warm load view position. After the warm load view, the instrument goes back to earth position 1 and the cycle begins again. See Appendix J.3 for specific scan parameters and patterns of the AMSU-A instrument.

The AMSU-A beams scan the earth viewing sector a total of 96.66 degrees (± 48.33 degrees from nadir) on beam centers. There is a total of 30 beam positions (30 resolution cells on the earth’s surface), which are called cell numbers 1 through 30, from sun to anti-sun. There are 15 cells on either side of nadir. The beam center position of each cell is separated from the adjacent cell along the scan direction by 3.33 degrees (there is a noncumulative step tolerance of ± 0.04 degrees).

3.3.3 CALIBRATION REQUIREMENTS

There are no specific on-orbit calibration procedures for AMSU-A. The instrument is automatically calibrated each data cycle by measuring both warm and cold calibration targets.

Figure 3.3.2.2-1. AMSU-A1 Instrument.

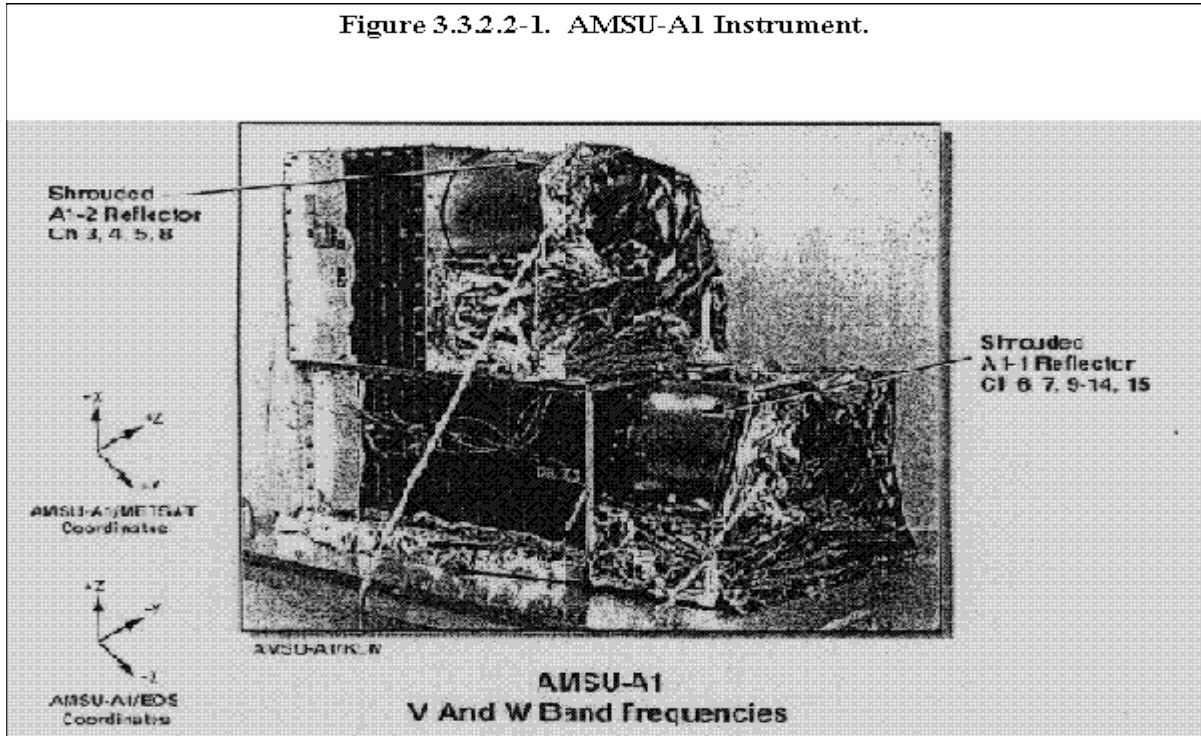

Figure 3.3.2.2-2. AMSU-A2 Instrument.

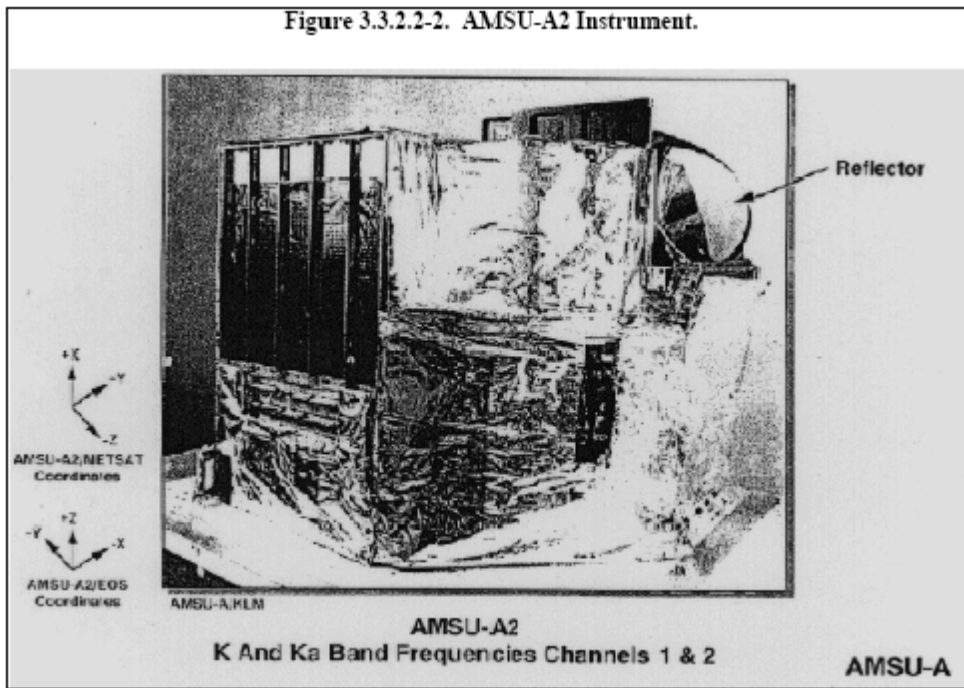

Figure 3.3.2.2-2 AMSU-A2 Instrument

3.4 ADVANCED MICROWAVE SOUNDING UNIT-B (AMSU-B)

3.4.1 INSTRUMENT OPERATION

The Advanced Microwave Sounding Unit-B (AMSU-B) is a 5 channel microwave radiometer. The purpose of the instrument is to receive and measure radiation from a number of different layers of the atmosphere in order to obtain global data on humidity profiles. It works in conjunction with the AMSU-A instruments to provide a 20 channel microwave radiometer.

The microwave characteristics of the atmosphere are provided in Figure 3.4.1-1. AMSU-B covers channels 16 through 20. The highest channels: 18, 19 and 20, span the strongly opaque water vapor absorption line at 183 GHz and provide data on the atmosphere's humidity level.

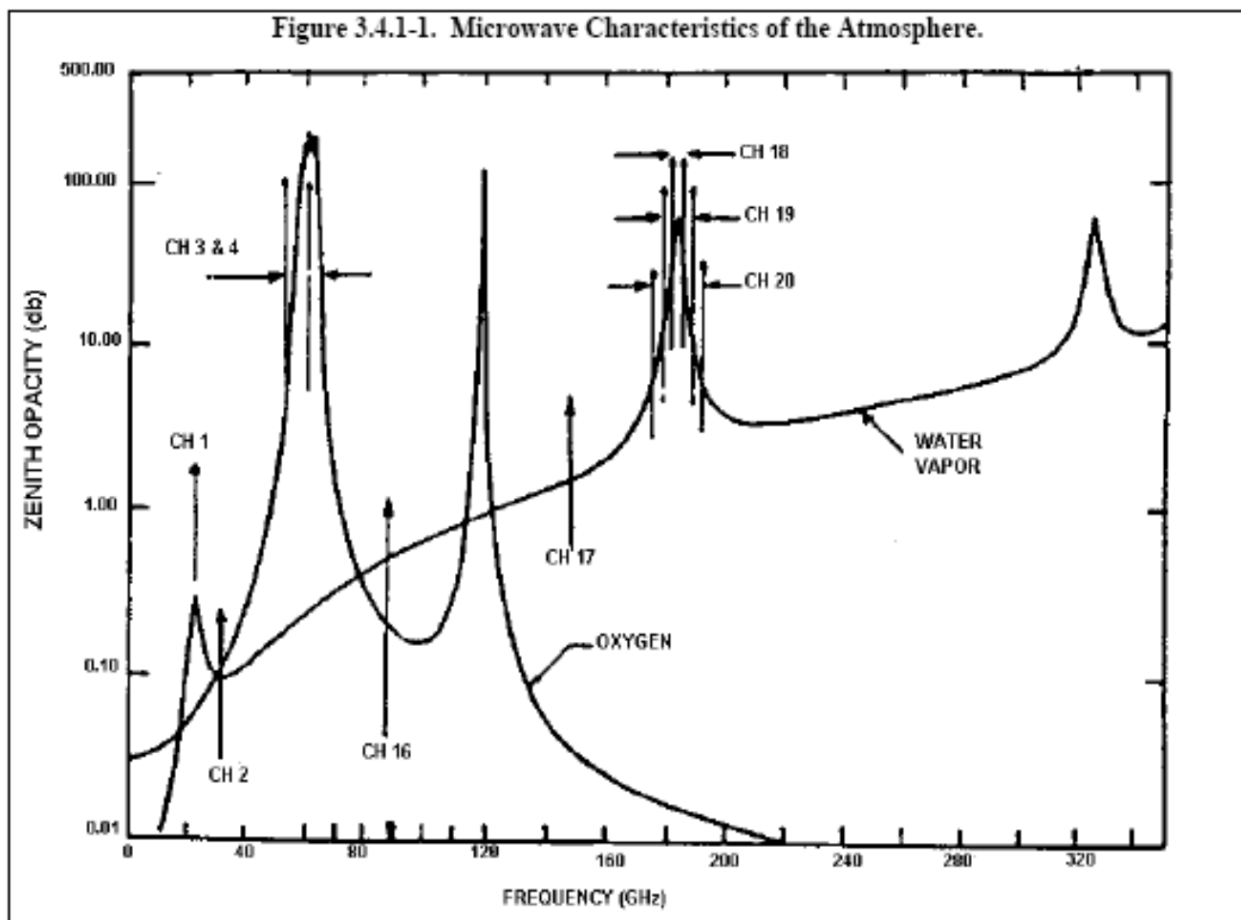

Figure 3.4.1-1 Microwave Characteristics of the Atmosphere.

Channels 16 and 17, at 89 GHz and 150 GHz, respectively, enable deeper penetration through the atmosphere to the Earth's surface.

AMSU-B is a cross-track, line scanned instrument designed to measure scene radiances in 5 channels. At each channel frequency, the antenna beamwidth is a constant 1.1 degrees (at the half power point). Ninety contiguous scene resolution cells are sampled in a continuous fashion, each scan covering 50 degrees on each side of the subsatellite path. These scan patterns and geometric resolution translate to a 16.3 km diameter cell at nadir at a nominal altitude of 850 km. See Appendix J.3 for specific scan parameters and patterns for AMSU-B.

The AMSU-B instrument consists of a scanning parabolic reflector antenna which is rotated once every 8/3 seconds and focuses incoming radiation into a quasi-optic system which then separates the frequencies of interest into three separate feed horns of the receiver assembly. The receiver subsystem provides further demultiplexing of the 183 GHz signal in order to selectively acquire three defined double sided bands around the 183 GHz signal. The passbands for all five channels are shown in Table 3.4.1-1. The center frequencies for channels 18, 19, and 20 are 183.31 ± 1.00 GHz, 183.31 ± 3.00 GHz, and 183.31 ± 7.00 GHz, respectively. Further information regarding the AMSU-B channels can be found in Section 3.3.2.1

Table 3.4.1-1. AMSU-B Channel Characteristics (based on actual instrument build and measured NE)T from thermal vacuum data).					
Channel Number	Center freq of channel (GHz)	No. of pass bands	Bandwidth per passband (MHz)	NE ΔT^1(K)	Polarization angle²
16		2	1000	.37	90-2
17		2	1000	.84	90-2
18		2	500	1.06	902-
19		2	1000	0.70	90-2
20		2	2000	0.60	90-2
¹ Values from first flight model					
² The polarization angle is defined as the angle from the horizontal polarization (i.e., electric field vector parallel to satellite track) where 0 is the scan angle from nadir. In this table, the polarization angle is horizontal when the angle indicated is 0 and vertical is 90-2					

The reflector is rotated in a profiled scan span, in order to provide a constant velocity Earth scan, a low speed scan across an internal calibration source, a low speed scan towards deep space and a scan repeat cycle time that does not allow for constant velocity rotation. The direction of the scan motion is from the sunside (+Z) to nadir (+X) to the antisunside (-Z). During earthscan, motion is continuous with an angular velocity constant to within $\pm 2\%$. The deep space and internal blackbody reference views permit a two-point, in-flight calibration. The entire scan profile is achieved through microprocessor control.

Three different data streams are processed and delivered by the instrument to either the spacecraft's AMSU Instrument Processor (AIP) or the TIROS Information Processor (TIP).

Digital data, which consist of earth view pixel data, housekeeping data, and space and blackbody view data, is clocked into the AIP. The TIP samples both digital "B" and analog telemetry. The digital "B" telemetry contains instrument status monitors used to verify commands, and the analog telemetry provides health and safety monitoring of AMSU-B.

3.4.2 SYSTEM DESCRIPTION

3.4.2.1 General

The overall purpose of AMSU-B is to receive and measure radiation from a number of different layers within the atmosphere in order to obtain global data on humidity profiles.

The radiation from the atmosphere is viewed by an offset parabolic reflector inclined to the axis of rotation. The antenna is rotated by means of a scanning mechanism which is capable of slewing the antenna between hot and cold calibration references and scanning the antenna to view a swath across the atmosphere. Radiation from the antenna is propagated via a fixed sub-reflector to a quasi-optic feed where it is divided into 89, 150 and 183.3 GHz bands and then to a Microwave Receiver where it is down-converted, amplified and detected. The detected signals are amplified, sampled and averaged under processor control to provide an integration time of 18 msec in each channel. The digital signals are then buffered before being relayed to the satellite bus.

The AMSU-B consists of the following:

- Microwave and Antenna Subsystem (MASS) comprising:
 - Main Reflector/Shroud
 - Subreflector
 - Quasi-Optic Feed
 - Microwave Receiver
 - Calibration Target
- Scanning Mechanism
- Electrical Subsystem comprising:
 - Processing Electronics Unit (PEU)
 - Motor Drive Electronics (MDE) and Inductosyn Control Electronics (ICE)
 - Power Supply Unit (PSU)
 - Electrical Harness
- Structure Subsystem
- Thermal Control Subsystem
- Software

A general configuration view of AMSU-B is shown in Figure 3.4.2.1-1.

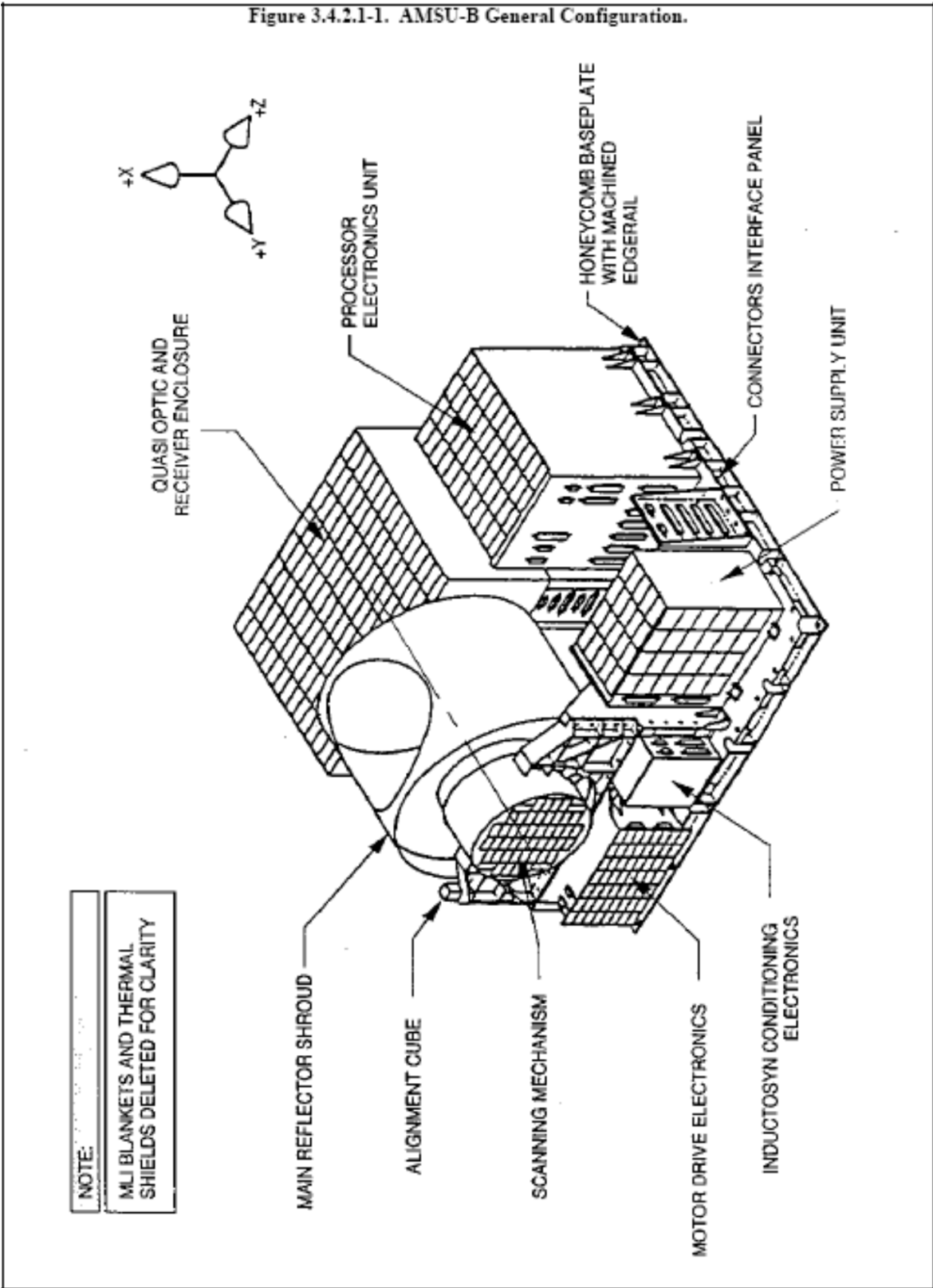

Figure 3.4.2.1-1. AMSU-B General Configuration

3.4.2.2 Microwave Receiver

The function of the Receiver Subsystem is to down-convert and detect the radiation from the Quasi-Optics to produce output voltages proportional to the detected RF power. The Receiver has three input channels and five output channels. Channel 16 uses a fundamental mixer with a center frequency of 89 GHz. Channel 17 uses a sub-harmonic mixer with a center frequency of 150 GHz. Channels 18, 19 and 20 are down-converted in one sub-harmonic mixer with a center frequency of 183.3 GHz. The IF output of the mixer is split and detected to produce the three channel outputs. The AMSU-B channel characteristics are shown in Figure 3.4.1-1. The receiver utilizes Gunn diode oscillators which are cavity stabilized and are of the reflection type. The diodes are Germanium mesa construction especially developed for AMSU frequencies. The temperatures of certain critical components of the Receiver Sub-system are sensed by AD590 temperature/current transducers for Analog Telemetry or by Platinum Resistance Thermistors (PRTs) for Digital Housekeeping Data.

3.4.2.3 Calibration Target

The radiometer is continually calibrated in flight with the aid of a cold reference view to space and a "warm" reference consisting of an ambient temperature Calibration Target. The "warm" reference is internal to the instrument. It consists of the following:

- microwave absorber providing quasi-blackbody radiation at microwave frequencies,
- a magnesium structured core,
- platinum resistance sensors to measure the temperature of the magnesium core accurately,
- an outer containment shroud of aluminum.

The Calibration Target presents a stable, high absorptivity, or quasi-blackbody load at approximately 290K (at nominal instrument temperature) into the instrument Main Reflector and is sized to fill the aperture in the Main Reflector/Shroud. The Calibration Target is viewed once during each scan of the instrument to provide a warm calibration reference. Gain is then computed from FOV counts taken at each of the two views and used to determine a radiance value for each channel. Apparent scene temperatures are finally calculated from the radiance values.

An integral shroud is fitted to match the main reflector/shroud, so that, as the Main Reflector is rotated, extraneous radiation impinging on the target is minimized.

Temperature control of the Calibration Target is passive and is designed to minimize temperature gradients within the target. Target temperature is sensed by seven Platinum Resistance Thermistors (PRTs) whose outputs are conditioned and digitized by the PEU and form part of the digital data telemetry.

3.4.2.4 Systems Requirements

A summary of the AMSU-B systems requirements is given in Table 3.4.2.4-1

Table 3.4.2.4-1. AMSU-B Systems Requirements Summary.					
Channel	16	17	18	19	20
Frequency (GHz)	89	150	183.3 ∇ 1	183.3 ∇ 3	183.3 ∇ 7
RF Bandwidth (GHz)	2 x 1	2 x 1	2 x.0.5	2 x 1	2 x 2
)T Temperature	1.0 K	1.0 K	1.1 K	1.0 K	1.2 K
Calibration Accuracy	1.0 K(\pm 0.2 K random)	1.0 K(\pm 0.2 K random)	1.0 K(\pm 0.2 K random)	1.0 K(\pm 0.2 K random)	1.0 K(\pm 0.2 K random)
Linearity	0.3 K	0.3 K	0.33 K	0.3 K	0.36 K
Interchannel Calibration Accuracy	0.5 K	0.5 K	0.5 K	0.5 K	0.5 K
Beam Efficiency	>95%	>95%	>95%	>95%	>95%
Beamwidth	1.1 degrees \pm 10%	1.1 degrees \pm 10%	1.1 degrees \pm 10%	1.1 degrees \pm 10%	1.1 degrees \pm 10%
Beam Pointing Accuracy	\pm 0.10 degrees	\pm 0.10 degrees	\pm 0.10 degrees	\pm 0.10 degrees	\pm 0.10 degrees
Cross Polarization	2%	2%	N/S	N/S	10%
Passband Sensitivity	<1.5 dB over 75% of passband				
Mass	60 kg				
Power	90 W				
Accommodation	526 mm x 700 mm x650 mm				
Life & Storage	3 years & 4 years				
Scan Motion	See Appendix J.3 for more information				
Scan Profile	See Appendix J.3 for more information				
Scan Angle	\pm 48.95 degrees				
Scan Period	8/3 seconds				
Calibration Views	\leq 4 degrees				
Scan Modes	Normal, Park, Step, Investigation				

3.5 SPACE ENVIRONMENT MONITOR (SEM-2)

3.5.1 INSTRUMENT OPERATION

The SEM-2 Space Environment Monitor is a multichannel charged-particle spectrometer which senses the flux of charged particles at the satellite altitude, and thus contributes to knowledge of the solar-terrestrial environment. SEM-1 units have been in orbit on the TIROS-N series since 1978. SEM-2 is a new design produced by Panametrics, Inc. of Waltham, Massachusetts to specifications written by the Space Environment Center of NOAA.

Solar particle emissions travel to Earth in the form of the solar wind, which consists of streams of charged particles moving at hundreds of kilometers per second. It is a source of particles for the Earth's trapped radiation belts. In addition to the solar wind, there occur times of intense fluxes of energetic electrons, protons and alpha particles (energies up to 1,000 MeV). As a consequence of both the solar wind particle stream and the occurrences of very energetic particle emissions from the Sun, there can be large changes to the energy input to the magnetosphere, ionosphere and high altitude atmosphere. Some of this energy is deposited into the ionosphere to produce the aurora visible around both magnetic poles.

Large, abrupt changes occur in the solar wind. These changes produce changes in the magnetosphere and the ionosphere. This can result in hazards among which are:

1. Radiation hazard to people in space and the potential of increased radiation exposure to people in high flying aircraft;
2. Disruption of radio navigation;
3. Absorption, even blackout, of radio waves so that radio communication is disrupted;
4. Induced voltages and currents in electric power circuits leading to circuit breaker trip, damage to equipment, and failure of transformers;
5. Induced currents in buried pipe lines causing accelerated corrosion;
6. Change in density of the high altitude atmosphere causing change in drag on satellites;
7. Change in magnetic torque on satellites; and
8. Damage by electrons and protons to satellite circuits and solar panels.

For these reasons, SEM-2 is specified to sense particles over a broad range of energies. SEM-2 consists of two detectors: the total energy detector (TED) and the medium energy proton and electron detector (MEPED) along with a data processing unit (DPU).

3.5.1.1 Total Energy Detector

The Total Energy Detector (TED) measures electron and proton energy fluxes in the 0.05 to 20 keV energy range.

Two independent measurements of the particle energy flux are made at zero and 30 degrees from the local vertical. The total energy measurement is divided into two ranges: 0.05 to 1 keV and 1 to 20 keV and each measurement is made independently for electrons and protons. The TED also

measures the maximum differential energy flux density and the energy at which it occurs for each direction and particle type (electron and proton).

TED operation is verified by a commandable In-Flight Calibration system to track changes in the TED electronics.

3.5.1.2 Medium Energy Proton Electron Detector

The Medium Energy Proton Electron Detector (MEPED) provides both directional and omni-directional measurements. The directional sensors, called telescopes, make independent measurements of the particle types in the energy intervals shown in Table 3.5.1.2-1. Directional measurements are made near the local vertical and near 90 degrees to the local vertical. The particle channels are designated by direction of view (0 or 9), particle type (E or P), and sequential energy range (1-6 for protons, 1-3 for electrons). Table 3.5.1.2-1 contains the particle types and energy intervals measured by the MEPED directional sensors.

Table 3.5.1.2-1. Particle types and energy intervals measured by the MEPED directional sensors.		
Particle type	Channel Designations	Energy Interval (keV)
Protons	0P1 and 9P1	30-80
	0P2 and 9P2	80-250
	0P3 and 9P3	250-800
	0P4 and 9P4	800-2500
	0P5 and 9P5	2500-6900
	0P6 and 9P6	>6900 integral
Electrons	0E1 and 9E1	>30 integral
	0E2 and 9E2	100 integral
	0E3 and 9E3	>300 integral

The omni-directional sensors measure proton energy in the following ranges: >16 MeV, >35 MeV, >70 MeV and >140 MeV. Each sensor consists of a dome of moderating material which absorbs energy from the particle (and so sets the detection energy threshold), a silicon solid state detector (SSD), a preamplifier, and a level comparator which responds to particles with enough energy to go through the moderator and produce a pulse from the detector large enough to exceed the level in the comparator.

The MEPED has an In-Flight Calibration (IFC) circuit started by command from the ground. Using pulses of increasing size, the calibration provides data for calculating the energy of each threshold and the noise (FWHM) of each directional channel.

3.5.1.3 Data Processing Unit

The Data Processing Unit (DPU) is the interface between the sensors and the spacecraft. It converts spacecraft power to the voltages required by the SEM-2. It counts pulses, scales them, combines some, and formats a data stream for Digital A telemetry. It digitizes analog monitors of TED, MEPED, and DPU circuits. Independent of whether SEM-2 power is on or off, some temperatures are monitored by the spacecraft.

The DPU provides bi-level monitors, via Digital B telemetry, of SEM-2 status. The DPU receives and processes commands from the ground through the spacecraft to operate SEM-2.

3.5.2 SYSTEM DESCRIPTION

3.5.2.1 Total Energy Detector

The Total Energy Detector (TED) consists of eight Electrostatic Analyzers (ESA), pulse height discriminators (PHD), an In-Flight Calibrator (IFC), two high voltage (HV) supplies, a sweep voltage supply and housekeeping circuits.

The ESA selects particles according to their charge and energy using curved plates which apply an electric field to the particles as they pass through the ESA. Only particles of the selected charge and energy can pass entirely through the ESA. At the outlet of the ESA is a continuous dynode electron multiplier (CDEM). The CDEM produces a pulse for each particle passed by the ESA.

The voltage applied to the ESA curved plates steps up through a series of exponential values to allow particles of increasing energy to pass through. Timing by the DPU determines the energy counter in which the CDEM pulses are accumulated.

There are commandable HV supplies for the electron CDEMs (up to 3,700 V) and for the proton CDEMs (up to 2,700 V) that compensate for gain degradation of the CDEMs with use.

3.5.2.2 Medium Energy Proton Electron Detector (MEPED)

The MEPED consists of two proton telescopes, (each containing two solid state detectors (SSDs)), two electron telescopes (each containing a single solid state detector) and four Omni-directional sensors (each containing a single solid state detector), Charge Sensitive Preamplifiers, Analog Signal Processors, Proton and Electron Coincidence Logic, In-Flight Calibrator, Low Voltage Regulators, SSD Bias Supply and Analog Housekeeping.

The two proton telescope sensors are located at 0 and near 90 degrees to the local vertical. Each sensor has logic circuits which select six energy ranges from 30 keV to greater than 6900 keV. The energy intervals detected are shown in Table 3.5.2.2-1.

Table 3.5.2.2-1. Proton telescope detection energy levels.	
Energy Interval Designation	Ep Range (keV)
0P1 and 9P1	30-80
0P2 and 9P2	80-250
0P3 and 9P3	250-800
0P4 and 9P4	800-2500
0P5 and 9P5	2500-6900
0P6 and 9P6	>6900

The two electron telescopes sensors are located at 0 and near 90 degrees to the local vertical. Each sensor has logic circuits which select three energy thresholds from 30 keV to 300 keV. Each energy channel has a veto for particle energy deposits of >2500 keV, which reduces the contamination from high energy proton fluxes. The energy intervals are shown in Table 3.5.2.2-2.

Table 3.5.2.2-2. Electron telescope detection energy intervals.	
Energy Interval Designation	Ep Range (keV)
0E1 and 9E1	>30
0E2 and 9E2	>100
0E3 and 9E3	>300

The four Omni-directional Proton Sensors, D4, D5, D6 and D7 have energy thresholds at 16, 35, 70 and 140 MeV, respectively.

A charged particle enters a SSD where it releases charges from the crystal until its energy is gone or it exits the crystal. The amount of charge released is proportional to the energy deposited in the crystal. The charge is collected by a charge sensitive preamplifier which converts the charge to a voltage pulse. After passing through an analog signal processor circuit, which shapes the pulse by pole-zero cancellation, single differentiation, double integration and baseline restoration, coincidence logic separates the pulses into the various channels for counting by the DPU.

Regulated voltage for the SSDs is provided by an SSD bias supply. An in-flight calibrator (IFC) puts pulses into the charge sensitive preamplifier inputs to check the complete analog signal processor and coincidence logic circuitry. The IFC data are telemetered the same as the normal particle data. Thresholds and noise values are calculated on the ground.

3.5.2.3 Data Processing Unit

The Data Processing Unit (DPU) is the sole electrical interface between the detectors and the spacecraft except for the TED and MEPED heaters. It converts spacecraft power to the voltages required by the SEM. It counts pulses, scales the counts, combines some, and formats a data stream for Digital A. It digitizes analog monitors of TED, MEPED and DPU voltages and temperatures. Independent of whether SEM-2 power is on or off, some temperatures are monitored by the spacecraft. The DPU provides bi-level monitors via Digital B of SEM-2 status. The DPU receives and processes commands from the ground through the spacecraft to control SEM-2.

- Converts +28 V Main Bus power to SEM-2 voltages;
- Receives commands from the spacecraft and controls the TED and MEPED accordingly;
- Counts high speed pulse data from the MEPED and TED;
- Provides Digital A, Digital B bi-level and spacecraft analog output to the spacecraft telemetry;
- Controls the In-Flight Calibration.

The DPU contains four "active" Printed Circuit Boards (daughter boards) and one "passive" PCB (mother board). The DC/DC converter is contained in a Faraday cage to reduce radio frequency interference (RFI) which might be caused by "high power" switching. SEM-2 operation is controlled by two redundant microprocessors, one of which is selected by ground command to be active.

3.5.2.3.1 Telemetry

Within the DPU three types of telemetry are generated: Digital A, Digital B and Analog.

3.5.2.3.2 Digital A

Digital A contains most of the telemetered data and consists of two 8-bit serial words made available to the spacecraft every 0.1 second, i.e., every minor frame.

3.5.2.3.3 Digital B

Digital B (DIGB) consists of 9 bits always available to the spacecraft. DIGB is updated by the DPU each 2.0 seconds. The spacecraft samples these each 3.2 seconds.

3.5.2.3.4 Spacecraft Analog Telemetry

A third type of data, analog telemetry, goes to the spacecraft. In this type, thirteen analog monitors are provided. Nine of these monitors verify command execution and indicate general state of health. These nine are also digitized and included in Digital A. The remaining four are temperature monitors powered by the +28 V Analog Telemetry Bus, which allows the DPU, MEPED and TED housing temperatures, as well as one MEPED proton telescope temperature, to

be monitored regardless of whether the instrument is on or off. These temperature monitors are not digitized by the DPU, but are processed directly by the TIP.

3.5.2.3.5 Timing

All timing is controlled by the microprocessor and is synchronous with the spacecraft 1.248 MHZ clock. Various data acquisition timing signals are spawned from a single timing chain to ensure proper signal phase. DPU timing has the following parts:

- Data acquisition Timing for TED and the MEPED
- Digital A Timing
- Microprocessor and Data Bus Timing
- Watchdog Timing

3.5.3 CALIBRATION REQUIREMENTS

The SEM-2 provides an In-Flight Calibration (IFC) for the MEPED and TED.

3.6 DATA COLLECTION SYSTEM/2 (DCS/2)

The Data Collection System (DCS), also known as ARGOS, DCS, collects data from platform transmitters located on continents and oceans in UHF frequency. The ARGOS program is administered under a joint agreement between NOAA and the French space agency, Centre National d'Etudes Spatiale (CNES). The system consists of in-situ data collection platforms equipped with sensors and transmitters and the ARGOS instrument (DCS) aboard the NOAA KLM and NOAA-N,-N' satellites. The global environmental data sets are collected at telemetry ground stations in Fairbanks, Alaska; and Wallops Island, Virginia; and pre-processed by NOAA/NESDIS in Suitland, Maryland. Two CNES subsidiary companies, Collecte Localisation Satellites (CLS) in Toulouse, France and Service ARGOS in Largo, Maryland process the data and deliver it to the end user.

Flying the ARGOS system aboard NOAA polar-orbiting satellites provides worldwide coverage. Additionally, incorporating the ARGOS instrument on a moving satellite allows for locating an in-situ platform using Doppler shift calculations. This positioning capability permits applications such as monitoring drifting ocean buoys and studying wildlife migration paths. ARGOS can track platforms anywhere in the world, supplying positions to users around the globe. Platforms can be attached to practically any type of physical object, for example: an ocean buoy, a stream gauge, a bear, a bird, or a fishing vessel.

ARGOS platforms are located by using the Doppler Effect, which gives an accuracy of up to 150 meters. Doppler locations are good for compact, low-power transmitters and in difficult radio environments. The satellites receive the signals sent even in extreme conditions such as a platform transmitting from a dense rainforest or from transmitters on the polar ice caps.

The ARGOS system is comprised of:

A set of user platforms, fixed or mobile, deployed at sea, on land or in the air and transmitting independently. The platform is the carrier complete with its sensors and ARGOS Platform Transmitter Terminal (PTT) or Platform Messaging Transceiver (PMT),

- A desired complement of two operational NOAA spacecraft and two in backup in simultaneous orbit, with instrument packages that receive PTT/PMT messages on a random access basis, then separate, time-code, format and retransmit the data to ground stations,
- The ground stations and two Global Processing Centers (GPCs) in Toulouse, France and Landover, Maryland, where data are retrieved, processed, and distributed to users. Each center can take on the full operational workload if the other fails. CLS also operates Master Beacons in Fairbanks (Alaska), Svalbard (Norway), and Toulouse (France) to provide two way messaging from the A-DCS instrument.

Section 3.6.1 describes the DCS/2 instrument flown onboard the NOAA KLM and NOAA-N satellites and Section 3.6.2 provides details on the Advanced Data Collection System (A-DCS) instrument flown on the NOAA-N' spacecraft.

3.6.1 DATA COLLECTION SYSTEM/2 (DCS/2)

3.6.1.1 Instrument Operation

The Data Collection System/2 (DCS/2) is one of the environmental monitoring systems flown on the NOAA KLM and NOAA-N spacecraft. The DCS/2 assists NOAA in its overall environmental mission and in support of the Global Atmospheric Research Program (GARP). It has approximately 2000 environmental platforms located around the Earth to measure such environmental factors as temperature, pressure, and currents. Some of these platforms are immersed in a moving fluid, such as the ocean and the atmosphere. These moving platforms, buoys and balloons, provide additional environmental information on velocity and direction of the ocean and wind currents.

The DCS/2 receives information from these fixed and moving environmental platforms and processes and transfers the data for storage by the spacecraft tape recorders. These stored data are transmitted to a NOAA ground station during station contact. The ground station records and transmits the DCS/2 data to CNES and to Service ARGOS in Landover, Maryland. CNES is the responsible manufacturing, system engineering and data distribution agency for the DCS/2.

3.6.1.2 System Description

The DCS/2 is comprised of three units: the Receiving and Power Unit (RPU) and two Signal Processor Units (SPU-A and SPU-B). The platforms transmit data to the DCS/2 at a carrier frequency of 401.650 MHz, digital biphase format at 400 bps. The DCS/2 demodulates this signal and determines the carrier frequency and relative time of each transmission. This data is processed, formatted, and transferred to the TIROS Information Processor (TIP). The following paragraphs describe how the processing occurs in each of the DCS/2 units.

3.6.1.2.1 Receiver Power Unit

The receiver linearly converts the incoming signal by means of two translations to an intermediate frequency which is applied to the input of the search unit and to the Data Recovery

Units (DRUs). The search unit is basically a spectrum analyzer which uses a Fast Fourier Transform to cover the 80 kHz operating frequency range.

3.6.1.2.2 Control Unit

The control unit sequentially scans the eight search unit channels. It makes a binary estimate of both the signal level and frequency. These two digital words are stored in the CU and are used for the assignment of a DRU to a particular receiver output signal.

3.6.1.2.3 Data Recovery Unit

The DRU is comprised of three sections: (1) phase-lock loop, (2) bit synchronizer, and (3) Doppler counter and formatter. The eight DRUs perform the following signal functions: acquisition of the carrier, signal demodulation, bit synchronization, frame synchronization, Doppler counting, decommutation and formatting of the data.

3.6.1.2.4 Telemetry Encoder and Memory

The telemetry formatter interrogates the buffer in the DRUs. When the buffer is full, the encoder sends a command to shift the 24 bits into memory. When the data transfer signal from the TIP is received by the encoder, it will transfer the data out of memory to the TIP.

3.6.1.2.5 Power and Command Unit

Power for the DCS/2 is supplied by the spacecraft +28 V main power bus. This voltage is converted by the power unit to four levels; +5.0, +12, -12, and -15 V. Regulation and current limitation is provided for each of these DCS buses. The command unit consists of seven relays which perform the ON/OFF functions for the DCS/2. The Control Interface Unit (CIU) sends pulse commands which control these relays. The command unit sends back to the TIP 14 status bits and six analogs.

3.6.1.2.6 Calibration Requirements

The DCS/2 has no on-orbit calibration requirements.

3.6.2 ADVANCED DATA COLLECTION SYSTEM (A-DCS)

3.6.2.1 General

NOAA-N' contains an Advanced Data Collection System (A-DCS) instrument. Platforms (buoys, free-floating balloons and remote weather stations) collect relevant data and transmit them to the spacecraft via a PTT and Platform Messaging Transceiver (PMT) in UHF frequency.

A-DCS uses Doppler information to enable the location of PTTs. The data are stored onboard the satellite for later transmission to the ground. A-DCS also includes a transmitter function to send stored messages to the PMTs, which have been uplinked via the Master Beacon.

3.6.2.2 Scientific Objectives

The Argos A-DCS is a space-based, data telemetry system that provides a global means to locate and collect environmental data from fixed and moving, low-power transmitters; i.e., polar ice flows, ocean buoys, birds, mammals, etc. in near-real time (15 minutes to 3 hours). The Argos A-DCS transmits data for operational and research related environmental applications, e.g., meteorology, oceanography and protection of the environment, with the majority of users being government/non-profit agencies and researchers. Argos A-DCS customers are engaged in over 1,000 programs operating approximately 15,000 data collection platforms in 72 countries.

3.6.2.3 Functional Description

The environmental platforms transmit data to the A-DCS at a carrier frequency around 401.635 MHz, digital modulation format at 400 bps and a high data rate of 4800 bps. The A-DCS demodulates this signal and determines the carrier frequency and relative time of each transmission. This data is processed, formatted, and transferred directly to the ground and to the satellite for real-time or later transmission to the ground.

3.6.2.4 Receiver Processing Unit

The receiver linearly converts the incoming signal to an intermediate frequency that is applied to the input of the search unit and to the equivalent of Data Recovery Units (DRUs). The search unit is basically a spectrum analyzer, which uses a Fast Fourier Transform to cover the 110 kHz operating frequency range. The receiver has a center frequency of 401.635 MHz and antenna polarization of RHCP.

3.6.2.5 Control Unit

The control unit sequentially scans the search unit channels. It makes a binary estimate of both the signal level and frequency. These two digital words are stored in the Control Unit and are used for the assignment of a DRU to a particular receiver output signal.

3.6.2.6 Data Recovery Unit

Processing software performs the following signal functions: acquisition of the carrier, signal demodulation, bit synchronization, frame synchronization, Doppler counting, decommutation; and management software performs the formatting of the data.

3.6.2.7 Telemetry Encoder and Memory

The telemetry formatter interrogates the buffer in the equivalent DRUs. When the buffer is full, the encoder sends a command to shift the bits into memory. When the data transfer signal from the satellite is received by the encoder, it transfers the data out of the memory to the satellite.

3.6.2.8 Transceiver

The A-DCS instrument sends messages to the user's mobile terminals through its UHF transmitter (465.9875 MHz bi-phase PM 200 or 400 bps). The user requests are received at the Toulouse, France facilities of CLS, the CNES subsidiary in charge of the operations of the ARGOS system. These requests will indicate the identification of the destination terminal, the message to be transmitted at 400 bps (or 200 bps) and the time constraints (if any).

Taking into account the above and the status of the ARGOS system, the Downlink Message Management Center (DMMC) will prepare the uploading of the request to the instrument through one of the Master Beacons of the ARGOS system.

The best situated Master Beacon is selected by the DMMC and the message to be uplinked is sent to this Master Beacon through a terrestrial public network. This uplink message contains the information necessary to prepare the downlink message to be sent to the user terminal.

The uplink message is an ARGOS message, the content of which is analyzed upon reception by the instrument which in turn prepares the downlink message to be included in the downlink High-level Data Link Control bit stream transmitted by the UHF transmitter.

3.7 SEARCH AND RESCUE SATELLITE (SARSAT) INSTRUMENT PACKAGE

General aviation aircraft are required to carry Emergency Locator Transmitters (ELTs), which are triggered by the impact of a crash and broadcast a signal at 121.5 and 243 MHz. These transmissions can be heard as siren like sounds on receivers of aircraft which may be flying over the transmitter. In addition, certain large ships are also required to carry 121.5 MHz Emergency Position Indicating Radio Beacons (EPIRBs) which also transmit the siren like sound. Some ocean going vessels voluntarily carry the EPIRBs.

It has been recognized for many years that receipt of ground transmissions by overflying satellites includes a Doppler shift of the transmitted frequency due to the velocity of the satellite relative to the transmitter. This Doppler shift information can be used to locate the transmitter. The Search and Rescue (SAR) Instrument Package first flown on NOAA-E and subsequent NOAA satellites carries a repeater for receiving and rebroadcasting the 121.5 and 243 MHz signals to a ground station where they can be detected and located by measuring their Doppler shift. However, these ELTs and EPIRBs were conceived prior to the satellite system and lack specifications which assure reliable detection through the satellite. Even so, by the launch of

NOAA-H, over 1,000 people had been saved by SAR forces making use of satellite-derived alerts and locations.

A 406 MHz SAR system has been designed specifically to work with the satellites. The NOAA satellite SAR Instrument Package carries a 406 MHz processor which receives transmissions from 406 MHz ELTs and EPIRBs, recovers their digital message, measures the Doppler shift, and both stores the data for later transmission and also transmits it in real time. A receiver for the 406 MHz band is also included in the repeater. This new system utilizes distress transmitters (ELTs and EPIRBs) designed to be compatible with the satellite and the system provides full global coverage. The 406 MHz system was demonstrated, evaluated and declared ready for operational use by the time of the NOAA-H launch. Beginning with NOAA-H, the 406 MHz processor began utilizing a solid state memory for storage of the global data. Prior to NOAA-H, the processors used the spacecraft tape recorder for global storage.

The NOAA KLM satellites carry an improved 406 MHz processor, designated SARP-2. This unit has improved performance in system capacity, bandwidth, and protection against interference.

3.7.1 INSTRUMENT OPERATION

The SARSAT Instrument Package for the NOAA-K spacecraft consists of antennas/ diplexer/ filters, a search and rescue repeater (SARR) and a search and rescue processor (SARP-2) as shown in Figure 3.7-1.

- SARSAT Antennas
 - SRA receive antennas
 - 121.5/243 MHz
 - 406 MHz
 - UDA receive antenna
 - 401.65/406.050 MHz
 - SLA transmitter antenna
 - 1544.5 MHz
- SARR
- SARP-2

The SARR operates as a "bent-pipe" repeater for the 121.5 MHz, 243 MHz, and 406.05 MHz bands and relays these transmissions from the ground-based emergency transmitters to Local User Terminals (LUTs) in real time. The SARR also transmits the SARP-2 digital data stream. The 406.05 MHz band of the SARR is for test and interference monitoring purposes, the normal processing is performed by the SARP-2.

After frequency translation, the base band spectra of the three signals phase modulate a 1544.5 MHz L-band transmitter for data relay to the ground. This technique maintains the Doppler information contained in the received signal from the three repeated bands. By processing the Doppler information at the LUT, the location of the emergency transmitter can be determined.

SARP-2 406.05-MHz signal data are both relayed in real time to the LUTs (if in sight) and stored for later transmission over a LUT when it comes in view of the satellite. SARP-2 signals are received on the Ultra High Frequency (UHF) Data Collection System Antenna (UDA), which the SARP-2 shares with the DCS-2. A frequency diplexer is used to separate the SARP-2 signals from DCS-2 signals. The SARP-2 measures the frequency and level of the incoming signal. In its data stream are a time tag, frequency and level information, a synchronization code indicating the start of each received message and the original message contained in the incoming signal. The data are stored in the SARP-2 last-in-and first-out circular memory, which continuously transmits its contents via the SARR L-band link at 2.4 kbps. When the memory is full, new data overwrites the oldest message. The memory readout pauses at the conclusion of a message block to allow transmission of new data and then continues its cyclic transmission with the new message, having erased and replaced the oldest message.

The SARP-2 and SARR data are received by the CDA stations via either the HRPT downlink or the TIP beacons.

The SARP-2, which is flown on NOAA KLM, provides the stored data interleaved with the real-time data in the 2.4 kbps data stream sent through the 1544.5 MHz downlink transmitter. The output of the SARR Instrument Package is four frequency multiplexed signals on the 1544.5 MHz downlink transmitter.

- (a) 2.4 kbps data
- (b) 121.5 MHz band translated
- (c) 243 MHz band translated
- (d) 406 MHz band translated

The SARR instrument outputs SARP-2 data and data stored in the SARP memory. The SARP-2 2.4 kbps data output consists of a Doppler frequency measurement (appropriately time-tagged) which includes the SAR data message from the ELT/EPIRB.

For the regional coverage mode, 2.4 kbps real-time data are transmitted to a Local User Terminal (LUT) via the SAR Repeater downlink. Global area coverage is provided by storing global 2.4 kbps data in a 406 Processor memory; these data are also transmitted to a LUT via the SAR Repeater downlink, but only during times when there is no regional coverage 2.4 kbps data to be transmitted.

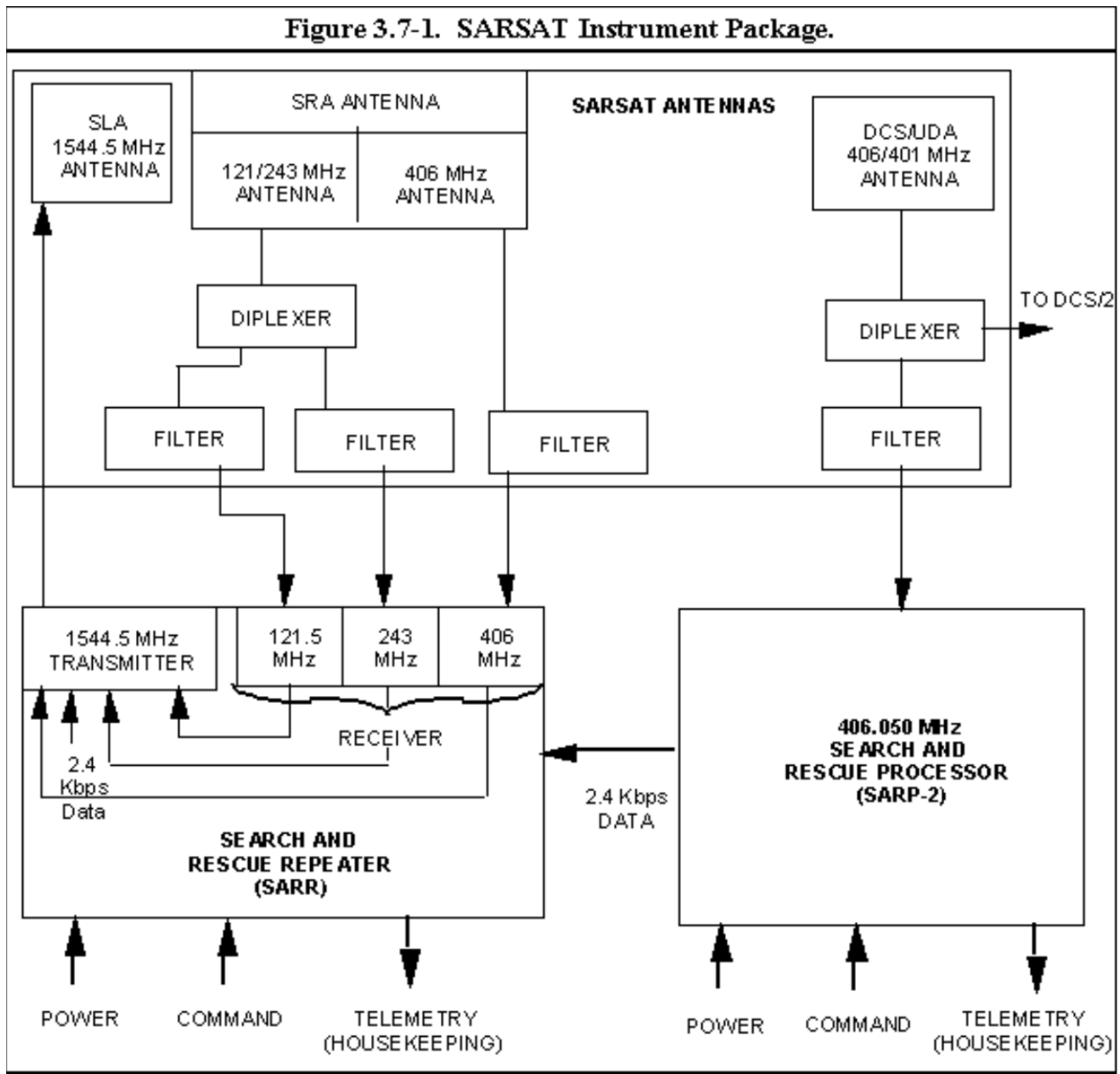

3.7.2 SYSTEM DESCRIPTION

The orbiting SARSAT Instrument Package receives signals from ground-based ELTs/EPIRBs and returns them to both raw form and preprocessed form (406 MHz Experimental Units only) to one or more ground stations. Table 3.7-1 shows the SARSAT Subsystem Characteristics, while Figure 3.7-1 shows the SARSAT Instrument Package which consist of three elements:

- (a) SARSAT Antennas;
- (b) SAR Repeater (SARR) and
- (c) SAR Processor (SARP-2).

3.7.2.1 SARSAT Antennas

The antenna subsystem consists of the:

- (a) SAR Receiver Antenna (SRA);
- (b) Data Collection System Ultra High Frequency (UHF) Antenna referred to as DCS/UDA and
- (c) SAR L-Band Transmitter Antenna (SLA).

3.7.2.1.1 SARSAT Receiver Antennas

The SRA feeding the SARR consists of two coaxial Quadrifilar designs. The outer quadrifilar operates at two frequencies: 121.5 MHz and 243.0 MHz. The inner quadrifilar operates at 406.05 MHz. The DCS/UDA is a quadrifilar design and operates at 406.050 MHz for SARP-2 and also 401.650 MHz for the Data Collection System/2 (which is not part of the SARSAT instrument package).

The Search and Rescue Receiver antennas are mounted on a boom which is deployed clear of the other spacecraft instruments, antennas and solar array. There are four receive antenna ports for the SARSAT instruments: three for the SARR, and one for the SARP-2.

The 243 MHz and 406 MHz for both SRA and UDA receiving antenna patterns are shaped partially to compensate for increased signal path losses for ELTs at increasing distances from the subsatellite point.

3.7.2.1.2 L-Band Transmitter Antenna

The L-Band transmitter antenna is a small 1544.5 MHz quadrifilar helix located on the Earth-facing side of the spacecraft which has a single lobe pattern for full Earth coverage. There is one transmit antenna port for connection to the SLA of the SARR.

3.7.2.2 SAR Repeater (SARR)

As shown in Figure 3.7-1, the SARR subsystem receives the ELT/EPIRB signals on 121.5, 243.0, and 406.05 MHz, down converts to selected intermediate frequencies, remodulates this data, and retransmits on 1544.5 MHz (repeater data mode). The baseline concept is that each receiver is a dual conversion unit with automatic gain control (AGC) which converts the received bandwidth down to a frequency range between 35 kHz and 210 kHz. These bands are then summed with 2.4 k-bit data from the SAR 406 MHz processor and phase modulated on the 1544.5 MHz downlink carrier frequency. The modulation level of each band is independently adjustable to account for any long-term changes either in the operational procedure or the system noise environment.

Each channel includes a commandable attenuator that allows the modulation index to be varied independently, subject to the constraint that the composite rms modulation index shall not exceed 0.74 radians.

The 2.4 kHz channel is controllable in 5 dB steps, whereas the 121.5, 243 and 406 MHz channels are controllable in 1 dB steps.

3.7.2.3 SAR Processor (SARP-2)

The 406.050 MHz on-board processor (see Figure 3.7.2.3-1) receives the 406 MHz transmissions from distress beacons and translates to an Intermediate Frequency (IF) using a double conversion. The IF signal is demodulated in a phase-lock loop to recover the data; the carrier frequency is measured and the data time tagged. For the regional coverage mode, real-time data are transmitted to a LUT via the SARR downlink. Global area coverage is provided by storing global data in a 406 Processor memory; these data are also transmitted to a LUT via the SARR downlink, but only during times when there is no regional coverage data to be transmitted.

The received signal is fed first to the receiver power unit (RPU) which utilizes a double conversion process to translate the signal to a lower frequency. The receiver is a constant gain type, linear over a 23 dB dynamic range.

The signal processing unit (SPU) is a Fast-Fourier Transform which searches the full 80 kHz bandwidth. When a signal is detected, the control unit assigns the signal to a Data Recovery Unit (DRU) on the basis of an algorithm designed to optimize the multiple-access performance. The algorithm for assignment is based on the frequency and level of input to the receiver as well as the current assignment state of the DRUs.

When a signal is assigned to a DRU, the voltage controlled oscillator (VCO) is pre-steered to within the lock-in range by a voltage which is proportional to the signal frequency as determined by the search unit. After VCO lock-up, the signal is demodulated and fed to a bit synchronizer which supplies the clock for subsequent digital processing. When the clock is available, the sync word contained in the message is detected and the remaining digital message processed. Doppler frequency is determined by counting the VCO signal for a specified time base referenced to the processor ultra stable oscillator (USO).

The processor formatter outputs a composite message made up of eight 24-bit words. Messages are organized into either long or short messages depending on the total number of data bits to be transmitted. The expected message length is determined by the processor by detecting a single bit flag indicating message length contained in the received message from the experimental ELT/EPIRB. The formatted message output is sent to the main memory and to the interface unit where it is transferred to the SARR 2.4 kbps input port. The processor is implemented physically into two units with a total weight of 24.5 kg, and a total volume of 37 liters. Power consumption is 19.9 Watts.

Figure 3.7.2.3-1. SARP-2 Block Diagram

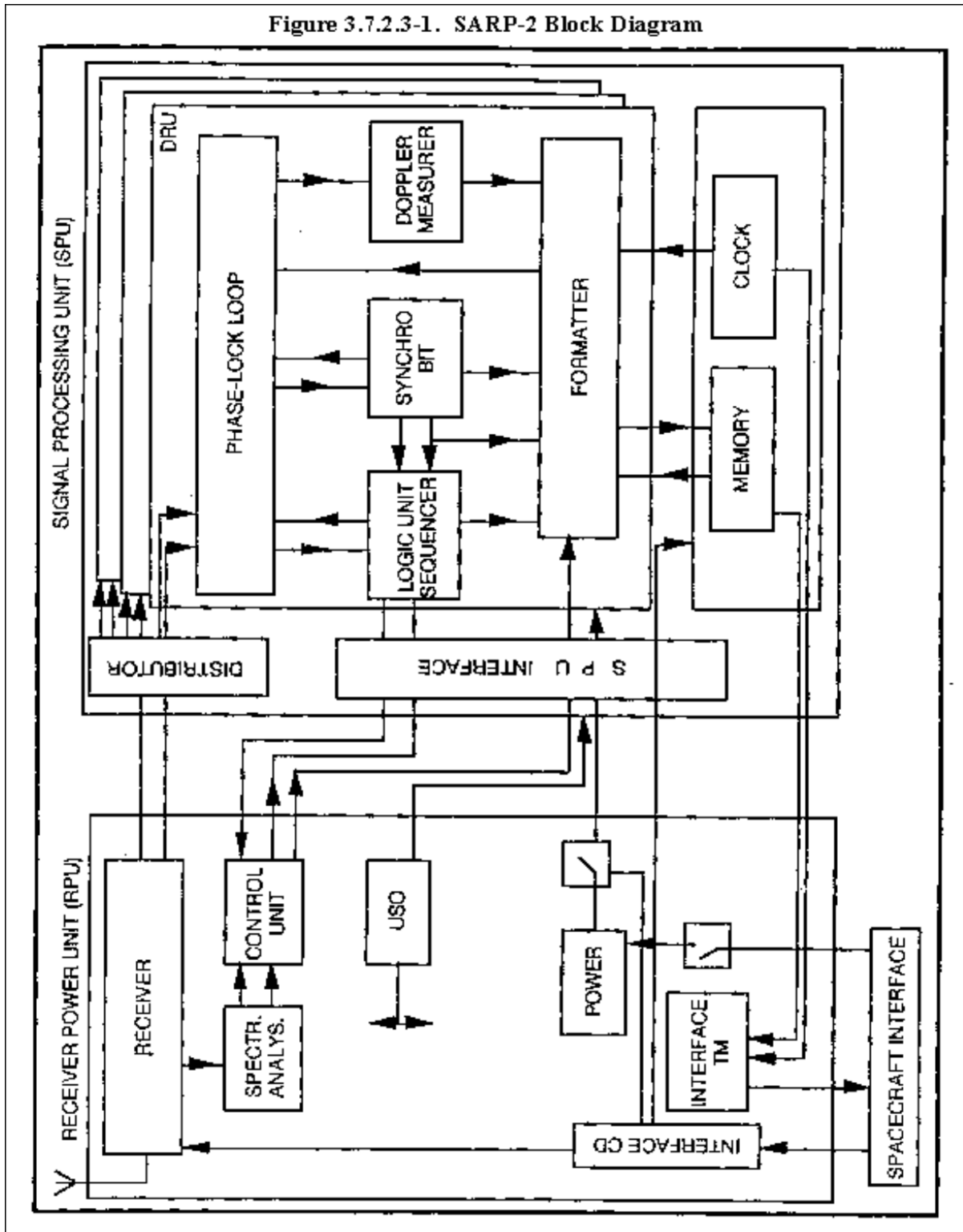

3.7.3 CALIBRATION REQUIREMENTS

The SARR and SARP-2 have no on-orbit calibration requirements.

3.8 SOLAR BACKSCATTER ULTRAVIOLET SPECTRAL RADIOMETER (SBUV/2)

3.8.1 INSTRUMENT OPERATION

3.8.1.1 Purpose of the SBUV Instrument

The purpose of the SBUV instrument is to measure the solar irradiance and Earth radiance in the near ultraviolet spectrum. From these data, the following atmospheric properties can be deduced:

1. The global and vertical distribution of stratospheric ozone
2. The structure and dynamics of stratospheric ozone
3. Photochemical processes and the influence of "trace" constituents on the ozone layer.
4. Long-term solar activity in the Ultraviolet spectrum.

Usable data can only be collected by the SBUV when it is integrated onto an afternoon spacecraft due to solar angle requirements.

3.8.1.2 Instrument Description

Two optical radiometers form the heart of the SBUV instrument: a monochromator and a small but very important Cloud Cover Radiometer (CCR). The instrument contains four mechanisms: a movable grating for wavelength selection in the monochromator, a deployable diffuser which selects solar or Earth radiation measurements, a deployable Mercury lamp for wavelength calibration and an optical chopper mechanism which converts the steady incoming radiation to pulses of UV light which can be readily processed by the SBUV detectors and electronics.

The optical detectors consist of a photo multiplier tube (PMT) in the monochromator and a vacuum photo diode (VPD) in the CCR. The PMT operates from a high voltage supply of about -700 volts DC; the VPD in the CCR operates from a bias of about -10 volts derived from the instrument's low voltage power supply (LVPS).

3.8.2 SYSTEM DESCRIPTION

The SBUV/2 is a nadir pointing no spatial scanning instrument sensitive to radiation in the 160 nm to 400 nm ultraviolet spectrum. The overall radiometric resolution is approximately 1 nm in this spectral band.

The SBUV instrument optical hardware and main electronics are carried in two modules. The Sensor Module (SM) contains the optical elements and detectors while the Electronics Module (ELM) houses the main electronics and power supplies.

The use of a deployable diffuser in the SM gives the instrument the versatility of selecting between Solar and Earth measurements. With the diffuser "stowed", the instrument views the Earth directly. The data from this configuration corresponds to Earth radiance. With the diffuser deployed into the "Sun" position, the detector output measurements correspond to solar irradiation data. Ground and in flight calibration data are used to convert the detector data and diffuser mode data to solar irradiation or Earth Radiance units.

The SM houses the monochromator optical hardware which uses a movable grating to select the wavelength where measurements are made. The grating mechanism can be commanded to any one of 8,192 positions giving the monochromator approximately 0.1 nm wavelength resolution. Commands which correspond to grating positions come from a Read Only Memory (ROM). Data read from the ROM correspond to 12 discrete wavelength positions in the "DISCRETE" mode. In the "SWEEP" mode, the ROM data is simply a grating position corresponding to the wavelength where the sweep will start.

The PMT has a very large dynamic range (greater than 120 dB). This range is transmitted in three ranges requiring a total of 0.75 seconds for stepping and settling of the grating to a new position and 1.25 seconds of integration time before transmission, when the instrument is in this "discrete" grating mode.

In the "sweep" mode, the grating is stepped every 50 ms and the PMT signal is integrated (while the stepping continues) for 100 ms before transmission.

The CCR has a fixed 379 nm filter for wavelength selection and is co-aligned to the monochromator; therefore, it views the same scene as the monochromator. The output of the CCR represents the amount of cloud cover in a scene, as the name implies, and is used to remove the effects of clouds in the monochromator data. CCR data is transmitted once per second in both discrete and sweep modes.

The ELM houses the low voltage power supplies and the electrical (Command and Data) interface to and from the spacecraft.

The SBUV/2 mechanical configuration is shown in Figure 3.8.2-1.

Figure 3.8.2-1. SBUV/2 Instrument.

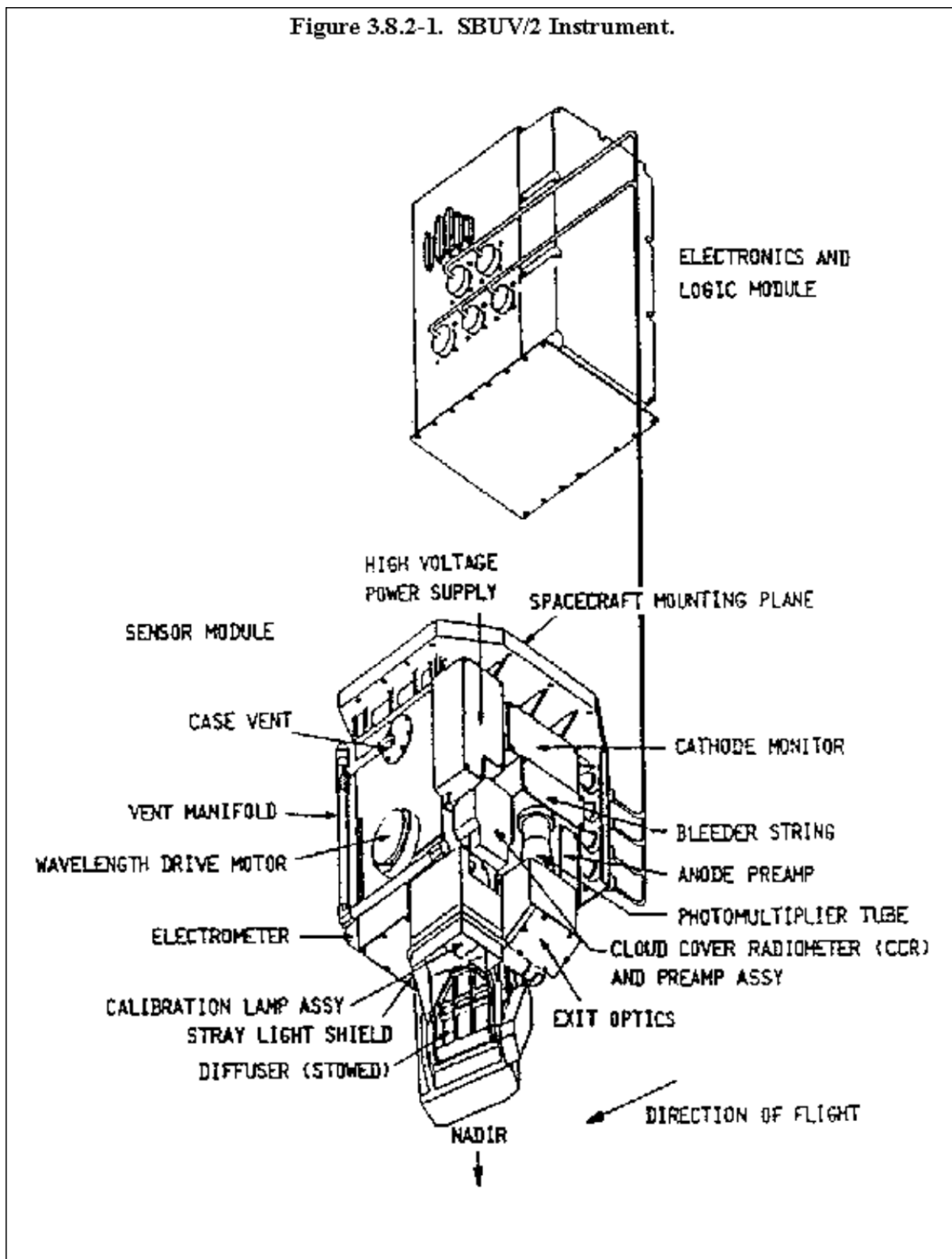

3.8.3 CALIBRATION REQUIREMENTS

3.8.3.1 In-Flight Measurement of Detector Gain

The SBUV/2 provides in-flight measurement of changes in gain of the detector(s), including the preamplifier stage. The measurements are sensitive enough to determine a gain change of 0.5% or less in the spectral range 300 to 340 nm. Averaging 100 measurements is permissible.

3.8.3.2 In-Flight Wavelength Calibration

The SBUV/2 provides the means of in-flight wavelength calibration. The onboard calibration is sensitive enough to detect 0.1 nm shift in the indicated wavelength with a measurement precision of 0.01 nm.

3.8.3.3 Pre-flight Calibration: Ratio of Radiance to Irradiance Accuracy

The ratio of the radiance calibration to irradiance calibration at the same wavelength is determined to an accuracy of 2.35% in the spectral range 200 nm to 250 nm and to an accuracy of 1.53% at 250 nm; 1.57% at 300 nm and 1.82% in the spectral range 340 nm to 400 nm. The ratio is determined from radiance and irradiance measurements made with a minimum time separation; i.e., at each Discrete Mode wavelength, the spectral drive is stopped and both measurements made before continuing. During the time of ratio measurement, the instrument

The ratio of the radiance calibration to irradiance calibration at the same wavelength is determined to an accuracy of 2.35% in the spectral range 200 nm to 250 nm and to an accuracy of 1.53% at 250 nm; 1.57% at 300 nm and 1.82% in the spectral range 340 nm to 400 nm. The ratio is determined from radiance and irradiance measurements made with a minimum time separation; i.e., at each Discrete Mode wavelength, the spectral drive is stopped and both measurements made before continuing. During the time of ratio measurement, the response does not vary by more than 0.5%.

3.9 MICROWAVE HUMIDITY SOUNDER (MHS)

3.9.1 INSTRUMENT OPERATION

The Microwave Humidity Sounder (MHS) is a self-calibrating microwave radiometer, observing the Earth with a field of view of $\pm 50^\circ$ across nadir, in five frequency channels of the millimeter-wave band (89-190 GHz). MHS, together with the complementary AMSU-A instruments, provides the operational microwave sounding capability for the NOAA-N, -N' meteorological satellites.

Channels at 157 GHz and around the 183 GHz water vapor absorption line provide a humidity profile sounding capability, while the 89 GHz channel provides information on surface temperature and emissivity (in conjunction with AMSU-A channels) and detects cloud and

Figure 3.9.1-1. MHS Channels and Passband Arrangement

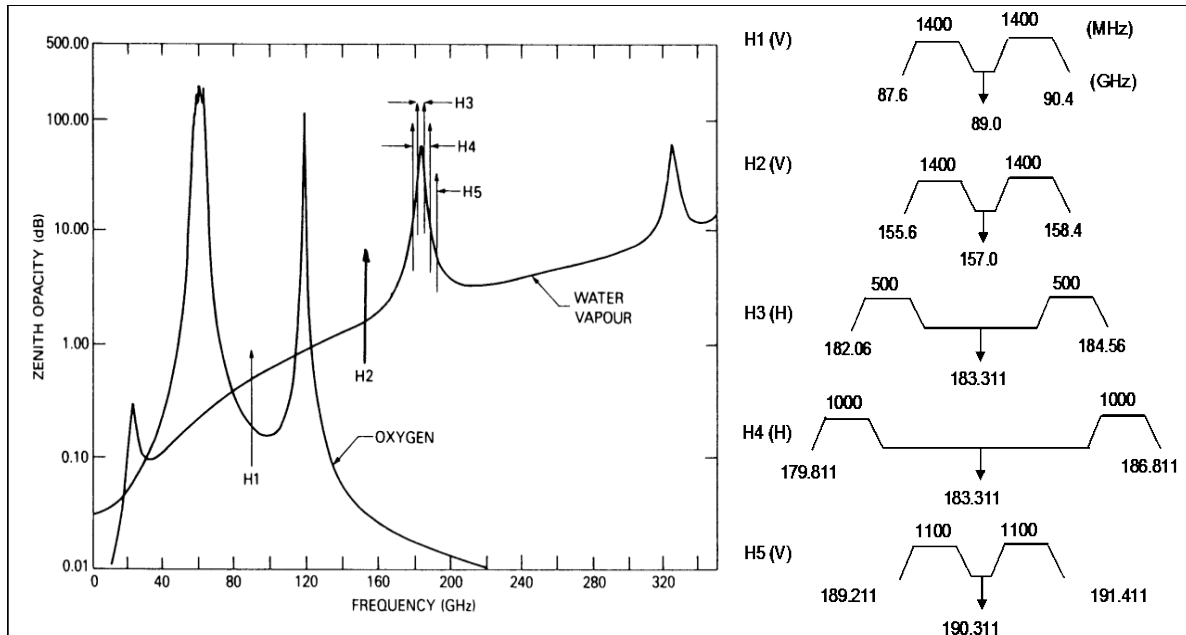

precipitation contaminated pixels. The MHS instrument represents an improvement to the AMSU-B radiometer on board previous NOAA satellites, while providing continuity to its data. Two MHS instruments are planned to fly on NOAA-N and -N' satellites, and three on the METOP satellite series of the European Polar System (EPS). MHS is a cross-track, line-scanned instrument. Ninety contiguous scene resolution cells are sampled in a continuous scan, covering 50 degrees on each side of the sub-satellite path, with an antenna beam width of 1.11 degrees at half power point. These scan patterns and geometric resolution translate to a 17-km diameter cell at nadir from the 870 km nominal orbital altitude.

A parabolic mirror is rotated to sample the Earth scene at 90 equidistant angular positions, at a rate of three scans every eight seconds, and at the same time to provide reference measurements against two calibration sources, i.e. an on-board blackbody target and a view on free space. The radiation is then conveyed on four feeds at 89, 157, 183 and 190 GHz via a “quasi-optical” arrangement of lenses, dichroic plates and a polarizing beam splitter. The instrument channels and pass-band characteristics are as shown in Table 3.9.1-1 and Figure 3.9.1-1.

Table 3.9.1-1. MHS Channels and Passband Characteristics.					
Channel (Note 1)	Central Frequency (GHz)	No of Passbands	RF Bandwidth (MHz) (Note 2)	NEΔT (K) (Note 3)	Polarization (Note 4)
H1	89.0	1	2800	0.22	V

H2	157.0	1	2800	0.34	V
H3	183.311 ± 1.0	2	2 x 500	0.51	H
H4	183.311 ± 3.0	2	2 x 1000	0.40	H
H5	190.311	1	2200	0.46	V

The microwave signal at the output of each of the four feeds is down-converted to Intermediate Frequency (IF) using a super-heterodyne receiver. Each receiver consists of a mixer with its associated local oscillator, an amplifier, and an IF filtering and video detection chain. The channels H3 and H4, sharing the same receiver, are separated by a diplexer and dedicated filters at IF level. Thus, five baseband signals are generated.

These signals, after low-pass filtering and removal of the DC component, are digitized and then further averaged over each pixel integration period. The final pixel result is formatted into a packet along with the calibration data, to constitute the scientific data to be used on the ground.

Radiance for the Earth views is derived from the measured counts and the calibration coefficients inferred from the internal black body and space view data. The black body temperature is accurately measured by a set of Platinum Resistance Thermometers (PRT). Moreover, the direction of the space view for cold reference can be adjusted after launch to optimize calibration with respect to spurious radiation sources.

The scientific data generated by MHS are sent to the spacecraft via the MHS Interface Unit (MIU) on the Science Data (SD) bus using Consultative Committee for Space Data Systems (CCSDS) packet formats. Instrument command, control and telemetry functions are also achieved through the MIU, using a separate Command/Telemetry (CT) bus, also using CCSDS packet formats.

The MHS instrument has a high degree of internal redundancy, which is managed by external commands underground control.

3.9.2 SYSTEM DESCRIPTION

3.9.2.1 General Configuration

The MHS instrument mechanical configuration is shown in Figure 3.9.2.1-1. The instrument consists of three major assemblies:

- 1) Receiver assembly, including the Quasi-Optics and Front-End Assembly (QOFEA) with its quasi-optical components, feeds, local oscillators or Q-band Sources (QBS), mixers, low-noise amplifiers and down-converters, and the Intermediate Frequency Back-End (IFBE), consisting of IF filters, detector diodes and baseband amplifiers.

- 2) Scan Mechanism, comprising the Reflector Drive Module (RDM) carrying the rotating reflector and motor, and the Flywheel Drive Module (FDM) with the counter-rotating momentum compensation flywheel and associated motor.
- 3) Electronics Equipment (EE), consisting of circuit modules providing the following functions:

- Processor and Interface Electronics (PIE)
- Signal Processing Electronics (SPE)
- Scan Control Electronics (SCE)
- Power Supply Electronics (PSE)

All three major assemblies are mounted on a common structural baseplate, assuring the mechanical interface to the satellite. The instrument baseplate also hosts the following minor assemblies:

- On-Board Calibration Target (OBCT)
- Motor Bracket and sunshield
- Thermal hardware (thermistors, thermostats and heaters)

Electrical interface connectors are on the outer envelope of the Electronics Equipment.

The MHS instrument operates at ambient temperature and does not require cooling systems. Thermal control is operated passively, using a combination of thermal insulation and radiative surfaces, the latter specifically used for dissipating the power of the receiver and the electronics equipment. Heaters are provided to speed up the warm-up time of the instrument from switch-on. A thermostat-driven survival heater network is also provided to maintain safe temperatures when the instrument is switched off.

Figure 3.9.2.1-1. MHS General Assembly

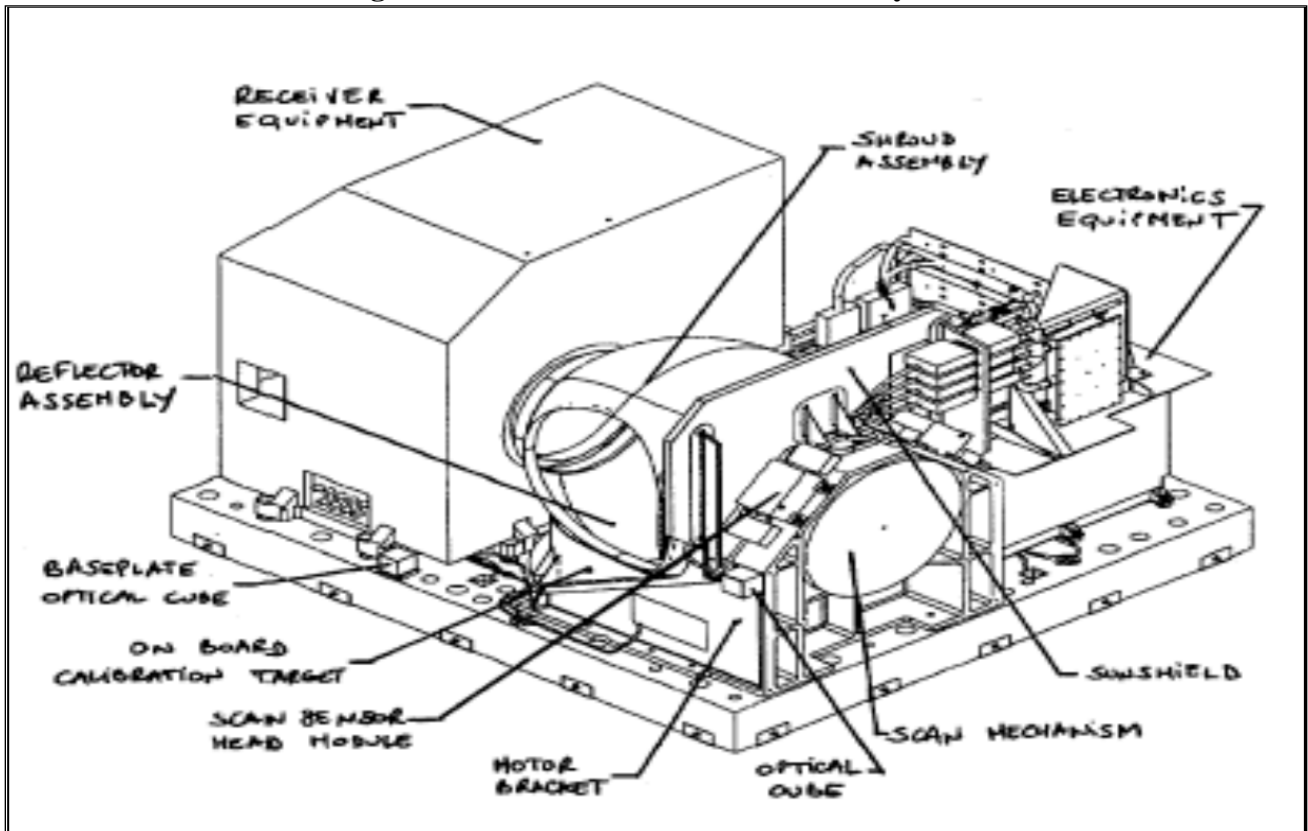

3.9.2.2 Scanning Concept

A closed-loop mechanism, based on brushless motors and contactless position sensors, is used to rotate the parabolic mirror every 2.67 seconds, to provide the Earth scanning and calibration functions. Figure 3.9.2.2-1 shows the scanning concept.

At each rotation the Earth field of view is scanned at constant speed, then the mirror is directed towards cold space and the internal target before starting the following scan. The scan velocity profile is optimized for maximum radiometric sensitivity. A counter-rotating flywheel is used to compensate momentum induced on the satellite by variations of the scan velocity. The reflector is provided with a co-rotating shroud, to minimize unwanted thermal radiation.

The scanning system is also capable of keeping the reflector indefinitely fixed to a desired position, on ground command, for special calibration purposes during the on-orbit verification phase, and return on command to nominal scan mode.

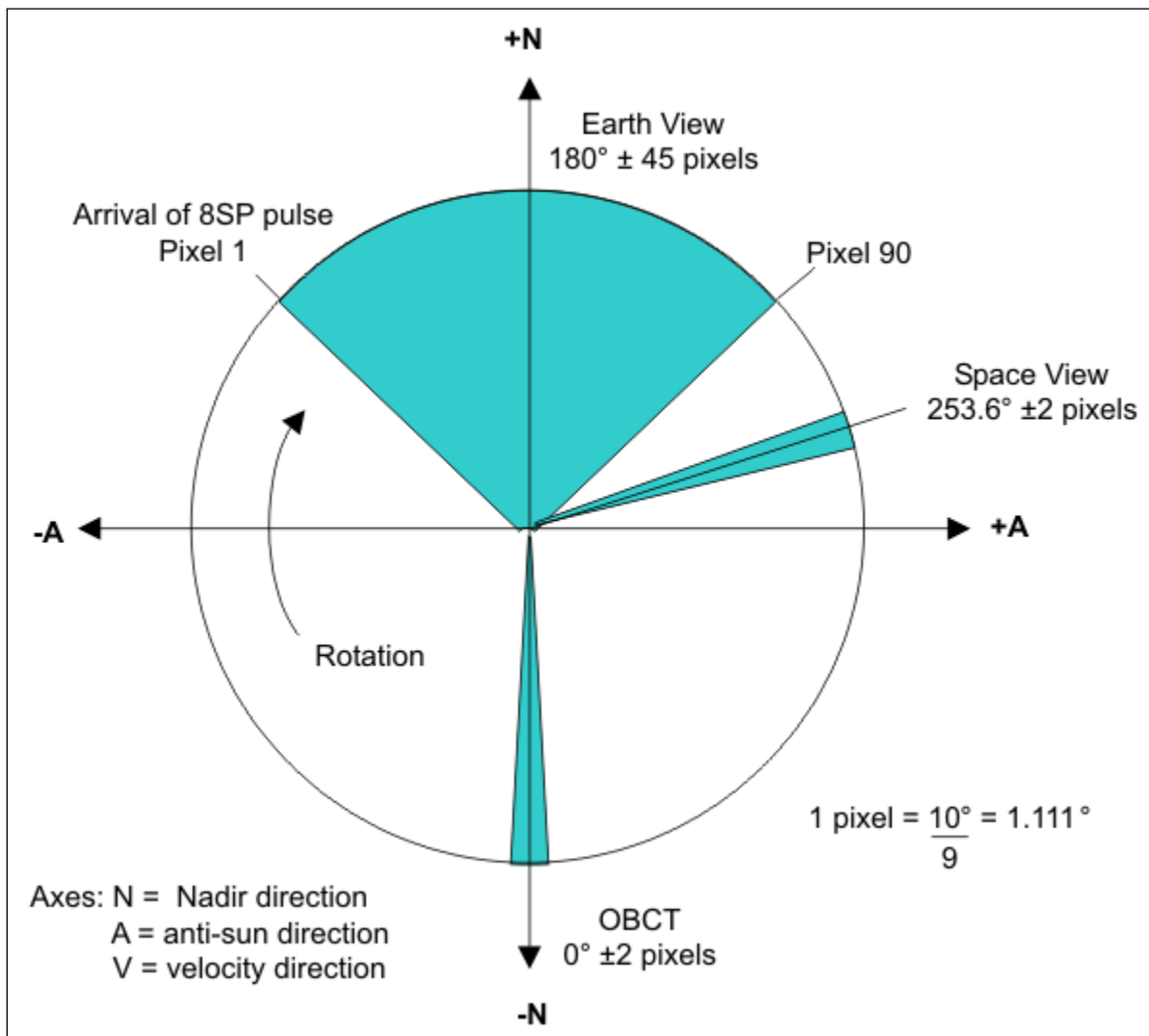

Figure 3.9.2.2-1. MHS Scanning Principle

3.9.2.3 Calibration Concept

MHS data calibration is based on measurements of two reference targets, namely the instrument cold space view (cold reference) and the On Board Calibration Target (OBCT) which is the hot reference. Both targets are sampled at every scan rotation. In order to reduce measurement noise on calibration data, four samples at each position are taken during each scan and averaged over several scans.

The OBCT is a black body whose temperature is left floating in thermal equilibrium with its environment. It consists of an array of pyramids coated with radio frequency absorbing material, having a uniform temperature over its surface. This temperature is accurately measured by a set

of Platinum Resistance Thermometers (PRT) located in various regions of the OBCT and used for on-ground processing of the radiometric data.

The accuracy of calibration mainly relies on the precision of PRTs and on the knowledge of unwanted thermal radiation sources affecting the measurement on the cold space view. In order to improve this knowledge, a special scanning mode is activated (during the on-orbit verification phase, shortly after launch) to characterize the in-flight radiative contributions. The position of the cold space view can be adjusted after launch to optimize the calibration process with respect to those disturbances.

The calibration coefficients in terms of gain and offset are calculated, appended to the raw data and used for further processing on ground (i.e. radiance, brightness temperature, etc). Non-linearity of the instrument transfer function is only measured on ground.

3.9.2.4 Modes of Operation

The MHS Instrument operation modes are as shown in Fig. 3.9.2.4-1.

In the Launch mode the instrument is totally unpowered and its temperatures are not controlled. Transition to Off Mode occurs when the Survival Power is applied. The Survival Heaters controlled by a thermostat network are used to maintain equipment temperatures within their non-operating safe limits. In all other modes, the instrument temperatures are maintained by the thermal dissipation occurring in the electrical equipment, with the aid of operational heaters under control of the instrument. The application of Survival Power, and thus the transition from Launch to Off mode, is expected on NOAA-N and NOAA-N' just a few hours after launch, so that dangerously low temperatures are not reached because of thermal inertia of the instrument. For safety reasons, it has been recommended never to switch off the Survival Power Bus, although no current is drawn from it during nominal operation.

The Power-On mode is entered when power is applied to both the Main and Pulse Load busses. The Electronics Equipment (EE) is switched on, initializing the on-board processing software (MINOS) and establishing command and telemetry links between the MHS and the satellite. The health and status of MHS will then be provided in the form of Housekeeping data. The unpowered equipment (Receiver and Scan Mechanism) is warmed, through the use of operational heaters, to reach their minimum switch-on temperatures.

In the Warm-up mode the instrument equipment is fully powered and thermal transition to the nominal operating temperature occurs thanks to the internal power dissipation, with the help of operational heaters for the Scan Mechanism. The Stand-by mode is achieved when the MHS Instrument is ready to perform its nominal scan operations. All equipment are at full performance temperatures and the circuits are powered. The Reflector, after an initialization cycle, is set stationary and pointing at the OBCT, under closed loop control.

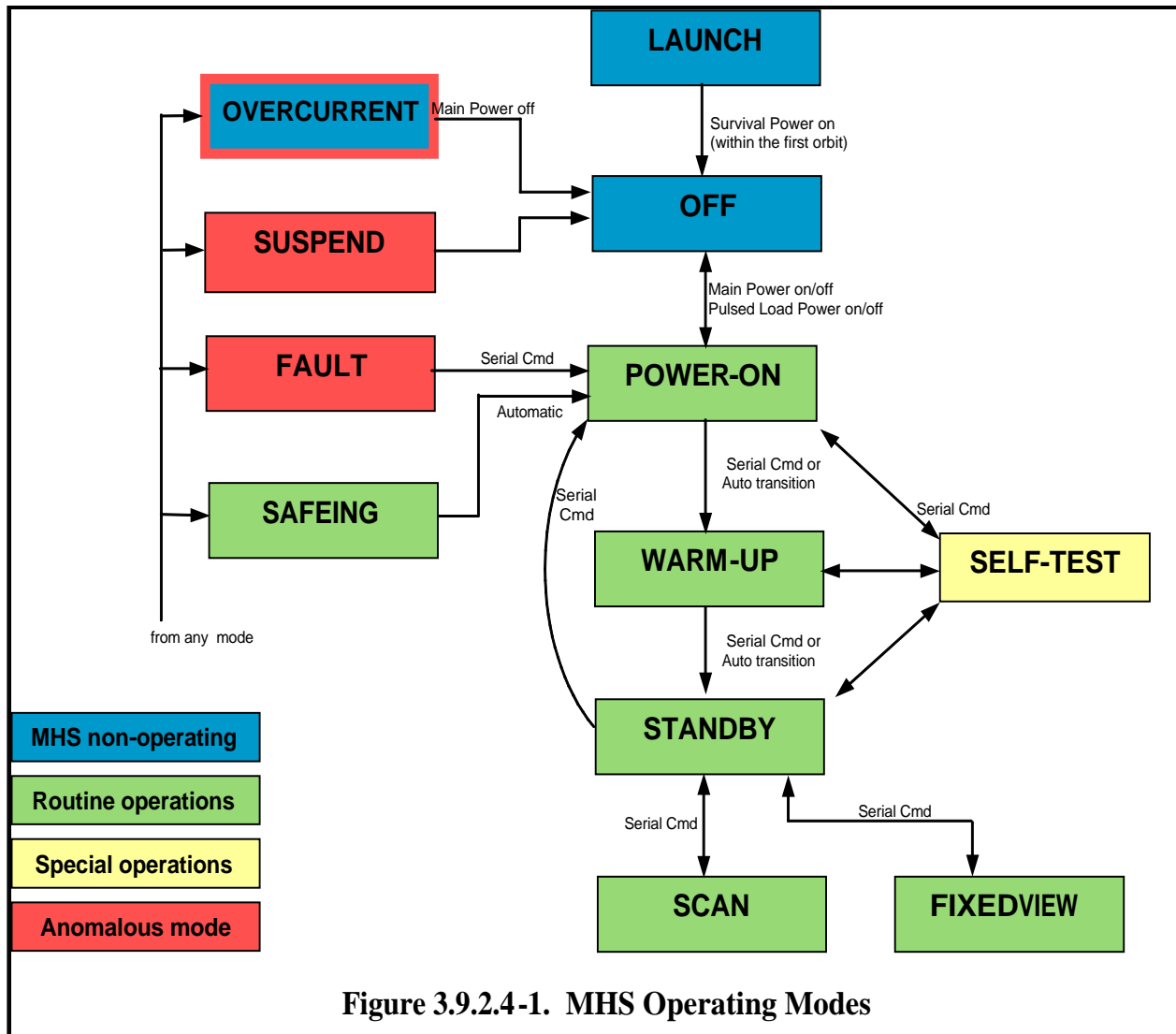

The Scan Mode is the normal operating mode of the MHS Instrument. All equipment is active and science data are produced as output. The Fixed View mode is nominally operated only during the initial on-orbit verification. The same activities as Scan Mode are taking place except that the Reflector is not performing the nominal scan but is pointing at a fixed position. Radiometric data are collected at pixel times equivalent to the Earth, Space and OBCT view periods of Scan Mode and placed in the corresponding positions of the Science Data Package.

The Safeing mode is entered on specific external command. The instrument is placed in a safe configuration in readiness for the removal of power. The Reflector is parked at the OBCT to prevent sun illumination in case of a change in the platform attitude.

The Fault mode, Overcurrent mode and Suspend mode are automatically entered whenever the MHS electronics detects an anomaly in the instrument behavior. The configuration is changed to

minimize the chance of permanent damage to any part of the MHS Instrument. A Self-Test mode is provided to allow specific functions of the MHS Instrument to be exercised and tested for the purposes of detailed MHS Instrument health monitoring and diagnostics in case of anomaly.

4.0 REAL TIME DATA SYSTEMS FOR LOCAL USERS

This section describes the real-time systems which are available for NOAA KLM direct readout users. These systems include the High Resolution Picture Transmission (HRPT), the Automatic Picture Transmission (APT), Direct Sounder Broadcast (DSB) and the Data Collection System (DCS). Transmission characteristics, data frame formats and synchronization details are given for each of the above mentioned systems.

4.1 HRPT SYSTEM

4.1.1 GENERAL

The High Resolution Picture Transmission (HRPT) system provides data from all spacecraft instruments at a rate of 665,400 bps. The S-band realtime transmission consists of the digitized unprocessed output of five AVHRR/3 channels, plus the TIP (HIRS/3, SBUV/2, SEM, and DCS/2) data and AMSU data. All information necessary to calibrate the instrument outputs is included in the data stream.

During NOAA-K activation and evaluation, it was determined that AMSU-A channels 7 and 15 were switched. This switch should be transparent to Level 1b users as the channels were corrected (switched back) by the ingest software, however, direct readout users should be aware of this problem. Only the radiometric data was affected, the housekeeping temperatures of channels 15 and 7 oscillators are correct as they are now. The antenna patterns, beam efficiency and beam widths are correct as they were not affected by the switch. Band pass for channels 7 and 15 was not affected due to extremely broad rf-detectors.

4.1.2 TRANSMISSION CHARACTERISTICS

The S-band transmission of time multiplexed, digital data is in a split phase format. For NOAA KLM, split phase data "0" is defined as being +68 degrees phase during the first half of the bit period and -68 degrees during the second half of the bit period. The split phase data "1" is defined as being -68 degrees phase during the first half of the bit period and +68 degrees phase during the second half of the bit period, for NOAA KLM. Note, the NOAA-N,-N satellites have a slightly different phase angle (see Table 4.1.2-2). Table 4.1.2-1 shows the general characteristics of the HRPT transmission system, while the general HRPT parameters for both NOAA KLM and NOAA-N,-N are shown in Table 4.1.2-2.

Table 4.1.2-1. HRPT Transmission Characteristics.	
Line Rate	360 lines/minute
Data Channels	5 transmitted, 6 available
Data Resolution	1.1 km
Carrier Modulation	Digital split phase, phase modulated

Transmitter Frequency (MHz)	1698.0 or 1707.0 MHz primary, 1702.5 MHz secondary For the latest information on individual POES spacecraft , refer to NOAA/NESDIS/OSO's website: http://www.oso.noaa.gov/poesstatus/index.asp
Transmitter Power (EOL)	6.35 W (38.03 dBm)
Radiated Power (dBm, @ 63 degrees)	40.13
Polarization: STX1 STX2 STX3	RCP LCP* RCP
* Except when STX2 is connected to the emergency omni antenna which is also RCP.	

Table 4.1.2-2. HRPT Parameters for NOAA KLM and NOAA-N,-N'.		
Parameter	NOAA KLM	NOAA-N,-N'
Major Frame		
Rate	2 major frames/sec	2 major frames/sec
Minor Frames/Major Frame	3	3
Minor Frame		
Rate	6 minor frames/sec	6 minor frames/sec
Number of words	11,090	11,090
Format	See Table 4.1.3.1-1	See Table 4.1.3.2-1
Word Parameters		
Rate	66,540 words/sec	66,540 words/sec
Number of bits/word	10	10
Order	Bit 1=MSB, Bit 10=LSB	Bit 1=MSB, Bit 10=LSB
Bit Parameters		
Rate	665,400 bits/sec	665,400 bits/sec
Format	Split phase	Split phase
Data "0"	+68/-68 degrees	+67/-67 degrees
Data "1"	-68/+68 degrees	-67/+67 degrees

4.1.3 HRPT MINOR FRAME FORMAT

The MIRP outputs the HRPT format simultaneously with the Automatic Picture Transmission (APT), Global Area Coverage (GAC) and Local Area Coverage (LAC) formats. GAC and LAC data are not considered real time, as these data are stored on the spacecraft digital recorders for readout by the CDA stations. The HRPT data format consists of a major frame which is subdivided into three minor frames.

Of special note is the flag in the telemetry (Word 7, Bit 10) which will indicate which of AVHRR/3 channel 3 sensors (3A or 3B) is operating. When channel 3B is selected, the patch temperature data is output every scan line (during the backscan), and every other scan line when channel 3A is selected. The data output will switch instantaneously between 3A and 3B upon

command, even if the scan is in the middle of a line. However, the way the flag operates there is one scan line of uncertainty when switching from 3B to 3A, and two lines of uncertainty when switching from 3A to 3B.

4.1.3.1 HRPT Minor Frame Format for NOAA KLM

On NOAA KLM, TIP and AMSU data are updated at the major frame rate. That is, the three minor frames which make up the major frame will contain TIP data in the first minor frame, backfill in the second minor frame, and AMSU data from the AIP, in the third minor frame. In the previous series of satellites (NOAA E-J), the major frame consisted of three minor frames of only the TIP data. The details of the HRPT, AIP, and TIP minor frame formats for NOAA KLM are shown in Tables 4.1.3.1-1, 4.1.5.1-1 and 4.3.3.1-1, respectively.

Of special note here is the flag in the telemetry (Word 7, Bit 10) which will indicate which of AVHRR/3 channel 3 sensors (3A or 3B) is operating. When channel 3B is selected, the patch temperature data is output every scan line (during the backscan), and every other scan line when channel 3A is selected. The data output will switch instantaneously between 3A and 3B upon command, even if the scan is in the middle of a line. However, the way the flag operates there is one scan line of uncertainty when switching from 3B to 3A, and two lines of uncertainty when switching from 3A to 3B.

Table 4.1.3.1-1 describes the minor frame format for HRPT on the NOAA KLM satellites.

Table 4.1.3.1-1. HRPT Minor Frame Format for NOAA KLM.					
Function	No. of Words	Word Position	Bit No. 1 2 3 4 5 6 7 8 9 10	Plus Word Code & Meaning	Notes
Frame Sync	6	1	1 0 1 0 0 0 0 1 0 0		
		2	0 1 0 1 1 0 1 1 1 1		
		3	1 1 0 1 0 1 1 1 0 0		1
		4	0 1 1 0 0 1 1 1 0 1		
		5	1 0 0 0 0 0 1 1 1 1		
		6	0 0 1 0 0 1 0 1 0 1		
ID	2	7	Bit 1; 0=Internal Sync; 1=AVHRR Sync Bits 2 & 3; 00=Not an HRPT frame but a GAC frame; 01=Minor Frame #1; 10=Minor Frame #2; 11=Minor Frame #3 Bits 4-7; Spacecraft Addresses; Bit 4=MSB, BIT 7=LSB Bit 8; 0=Frame Stable; 1=Frame Resync Occurred Bit 9; 1=Normal AVHRR input, 0=PN AVHRR Input Bit 10; 0=AVHRR Ch3B, 1=AVHRR Ch3A		
		8	Bits 1-10; undefined Spare		

Time Code	4	9	Bits 1-9; Binary day count; Bit 1 = MSB; Bit 9 = LSB Bit 10; 0; spare	
		10	Bit 1-3; 101, spare Bits 4-10; Part of Binary msec of day count; Bit 4=MSB	
		11	Bit 1-10; Part of Binary msec of day count;	
		12	Bit 1-10; Remainder of Binary msec of day count; Bit 10=LSB	
Telemetry	10	13	Ramp Calibration AVHRR Channel #1	
		14	Ramp Calibration AVHRR Channel #2	
		15	Ramp Calibration AVHRR Channel #3	
		16	Ramp Calibration AVHRR Channel #4	
		17	Ramp Calibration AVHRR Channel #5	
		18	PRT Reading 1	
		19	PRT Reading 2	
		20	PRT Reading 3	2
		21	Channel 3 patch Temp.	
22	Spare - Undefined			
Calibration Target View	30	23 thru 52	10 words of calibration target view data from each AVHRR channel 3, 4, and 5. These data are time multiplexed as chan 3 (word 1), chan 4 (word 1), chan 5 (word 1), chan 3 (word 2), chan 4 (word 2), chan 5 (word 2), etc.	
Space Data	50	53 thru 102	10 words of space scan data from each AVHRR channel 1, 2, 3, 4, and 5. These data are time multiplexed as chan 1 (word 1), chan 2 (word 1), chan 3 (word 1), chan 4 (word 1) chan 5 (word 1), chan 1 (word 2), chan 2 (word 2), chan 3 (word 2), chan 4 (word 2), chan 5 (word 2), etc.	
Sync Data	1	103	Bit 1; 0 = AVHRR sync early; 1 = AVHRR sync late, Bits 2-10; 9 bit binary count of 0.9984 MHz periods; Bit 2 = MSB, Bit 10=LSB	
Data Words	520	104 thru 623	3 sets of data corresponding to three HRPT minor frames per HRPT major frame. First HRPT minor frame: The 520 words contain 5 TIP minor frames of TIP data (104 TIP data words per TIP minor frame) Bits 1-8: Exact format as generated by TIP. Bit 9: Even parity check over Bits 1-8. Bit 10: Inverted Bit 1.	3

			<p>Second HRPT minor frame: The 520 words shall consist of five frames (104 words per frame) of spare data in the same form as spare words 624-750.</p> <p>Third HRPT minor frame: The 520 words shall consist of five frames (104 words per frame) of AMSU data from the AIP. Bits 1-8: Exact format as generated by AIP. Bit 9: Even parity check over Bits 1-8. Bit 10: Inverted Bit 1.</p>	
Spare Words	127	624	1 0 1 0 0 0 1 1 1 0	
		625	1 1 1 0 0 0 1 0 1 1	
		626	0 0 0 0 1 0 1 1 1 1	
		627	1 0 1 1 0 0 0 1 1 1	
		628	1 1 0 1 0 1 0 0 1 0	
		4
		748	1 0 0 1 0 1 1 0 1 0	
		749	1 1 0 0 1 0 0 0 1 0	
		750	1 0 0 0 0 0 0 0 0 0	
Earth Data	10,240	751	Chan 1 - Sample 1	
		752	Chan 2 - Sample 1	
		753	Chan 3 - Sample 1	
		754	Chan 4 - Sample 1	
		755	Chan 5 - Sample 1	
		756	Chan 1 - Sample 2	
		5
		10,985	Chan 5 - Sample 2047	
		10,986	Chan 1 - Sample 2048	
		10,987	Chan 2 - Sample 2048	
		10,988	Chan 3 - Sample 2048	
		10,989	Chan 4 - Sample 2048	
10,990	Chan 5 - Sample 2048			
Auxiliary Sync	100	10,991	1 1 1 1 1 0 0 0 1 0	
		10,992	1 1 1 1 1 1 0 0 1 1	
		10,993	0 1 1 0 1 1 0 1 0 1	
		10,994	1 0 1 0 1 1 1 1 0 1	
		6
		11,089		
		11,090		

Notes:

- 1) First 60 bits from 63 bit PN generator started in the all 1's state. The generator polynomial is $X^6+X^5+X^2+X+1$
- 2) AVHRR Internal Target Temperature Data. Three readings from one of the four platinum resistance thermometers (PRT). A different PRT is sampled for each scan; every fifth scan will contain a reference value of 0 in place of each reading.
- 3) 104 words includes 103 words of the AMSU frame plus the first word of TIP
- 4) Derived by inverting the output of a 1023 bit PN sequence provided by a feedback shift register generating the polynomial: $X^{10}+X^5+X^2+X+1$. The generator is started in all 1's state at the beginning of word 7 of each minor frame.
- 5) Each minor frame contains the data obtained during one Earth scan of the AVHRR sensor. The data from the five sensor channels of the AVHRR are time multiplexed as indicated.
- 6) Derived from the non-inverted output of a 1023 bit PN sequence provided by a feedback shift register generating the polynomial: $X^{10}+X^5+X^2+X+1$. The generator is started in the all 1's state at the beginning of word 10,991.

4.1.3.2 HRPT Minor Frame Format for NOAA-N,-N'

On NOAA-N,-N', the HRPT format provides a major frame, which is made up of three minor frames. TIP and AMSU/MHS data are updated at the major frame rate. That is, the three minor frames, which make up a major frame, will contain TIP data in the first minor frame, backfill in the second minor frame, and AMSU/MHS data in the third minor frame. The HRPT is provided in a split phase format to the S-Band Transmitter. The S-band transmission of time multiplexed, digital data is in a split phase format. The split phase data 0" is defined as being +67° phase during the first half of the bit period and -67° phase during the second half of the bit period. The split phase data 1" is defined as being -67° phase during the first half of the bit period and +67° during the second half of the bit period. The time code contained in each minor frame indicates the spacecraft time 1.13 ± 0.5 milliseconds before the beginning of bit 1 of word 1. The HRPT minor frame format for NOAA-N,-N' is shown in Table 4.1.3.2-1.

Table 4.1.3.2-1. HRPT Minor Frame Format for NOAA-N, -N'.					
Function	No. of Words	Word Position	Bit No. 1 2 3 4 5 6 7 8 9 10	Plus Word Code & Meaning	Notes
Frame Sync	6	1	1 0 1 0 0 0 0 1 0 0		
		2	0 1 0 1 1 0 1 1 1 1		
		3	1 1 0 1 0 1 1 1 0 0		1
		4	0 1 1 0 0 1 1 1 0 1		
		5	1 0 0 0 0 0 1 1 1 1		
		6	0 0 1 0 0 1 0 1 0 1		
ID	2	7	Bit 1; 0=Internal Sync; 1=AVHRR Sync Bits 2 & 3; 00=Not an HRPT frame but a GAC frame; 01=Minor Frame #1; 10=Minor Frame #2; 11=Minor Frame #3 Bits 4-7; Spacecraft Addresses; Bit 4=MSB, BIT 7=LSB		

			Bit 8; 0=Frame Stable; 1=Frame Resync Occurred Bit 9; 1=Normal AVHRR input, 0=PN AVHRR Input Bit 10; 0=AVHRR Ch3A, 1=AVHRR Ch3B	
		8	Bits 1-10; undefined Spare	
Time Code	4	9	Bits 1-9; Binary day count; Bit 1 = MSB; Bit 9 = LSB Bit 10; 0; spare	
		10	Bit 1-3; 101, spare Bits 4-10; Part of Binary msec of day count; Bit 4=MSB	
		11	Bit 1-10; Part of Binary msec of day count;	
		12	Bit 1-10; Remainder of Binary msec of day count; Bit 10=LSB	
Telemetry	10	13	Ramp Calibration AVHRR Channel #1	
		14	Ramp Calibration AVHRR Channel #2	
		15	Ramp Calibration AVHRR Channel #3	
		16	Ramp Calibration AVHRR Channel #4	
		17	Ramp Calibration AVHRR Channel #5	
		18	AVHRR Channel #3 Target Temperature	
		19	AVHRR Channel #4 Target Temperature	
		20	AVHRR Channel #5 Target Temperature	2
		21	Channel 3 patch Temp.	
22	Spare - Undefined			
Back Scan	30	23 thru 52	10 words of back scan data from each AVHRR channel 3, 4, and 5. These data are time multiplexed as chan 3 (word 1), chan 4 (word 1), chan 5 (word 1), chan 3 (word 2), chan 4 (word 2), chan 5 (word 2), etc.	
Space Data	50	53 thru 102	10 words of space scan data from each AVHRR channel 1, 2, 3, 4, and 5. These data are time multiplexed as chan 1 (word 1), chan 2 (word 1), chan 3 (word 1), chan 4 (word 1) chan 5 (word 1), chan 1 (word 2), chan 2 (word 2), chan 3 (word 2), chan 4 (word 2), chan 5 (word 2), etc.	
Sync Data	1	103	Bit 1; 0 = AVHRR sync early; 1 = AVHRR sync late, Bits 2-10; 9 bit binary count of 0.9984 MHz periods; Bit 2 = MSB, Bit 10=LSB	

Data Words	520	104 thru 623	<p>3 sets of data corresponding to three HRPT minor frames per HRPT major frame.</p> <p>First HRPT minor frame: The 520 words contain 5 TIP minor frames of TIP data (104 TIP data words per TIP minor frame) Bits 1-8: Exact format as generated by TIP. Bit 9: Even parity check over Bits 1-8. Bit 10: Inverted Bit 1.</p> <p>Second HRPT minor frame: The 520 words shall consist of five frames (104 words per frame) of spare data in the same form as spare words 624-750.</p> <p>Third HRPT minor frame: The 520 words shall consist of five frames (104 words per frame) of AMSU/MHS data from the AIP. Bits 1-8: Exact format as generated by AIP. Bit 9: Even parity check over Bits 1-8. Bit 10: Inverted Bit 1.</p>	3
Spare Words	127	624	0 1 0 0 0 0 1 0 0 1	
		625	0 1 1 1 1 0 1 1 1 0	
		626	1 1 1 0 1 0 1 0 1 0	
		627	0 0 1 1 1 0 1 1 1 0	
		628	0 0 1 0 1 1 0 0 0 0	
		4
		748	1 0 1 1 0 1 1 1 0 1	
		749	0 0 0 1 0 0 1 1 1 0	
		750	1 1 1 1 0 0 1 0 0 1	
Earth Data	10,240	751	Chan 1 - Sample 1	
		752	Chan 2 - Sample 1	
		753	Chan 3 - Sample 1	
		754	Chan 4 - Sample 1	
		755	Chan 5 - Sample 1	
		756	Chan 1 - Sample 2	
		5
		10,985	Chan 5 - Sample 2047	
		10,986	Chan 1 - Sample 2048	
		10,987	Chan 2 - Sample 2048	
		10,988	Chan 3 - Sample 2048	
10,989	Chan 4 - Sample 2048			
10,990	Chan 5 - Sample 2048			
Auxiliary Sync	100	10,991	1 1 1 1 1 0 0 0 1 0	

		10,992	1 1 1 1 1 1 0 0 1 1	
		10,993	0 1 1 0 1 1 0 1 0 1	
		10,994	1 0 1 0 1 1 1 1 0 1	
		6
		11,089	0 1 1 1 1 1 0 0 0 0	
		11,090	1 1 1 1 0 0 1 1 0 0	

NOTES:

1. First 60 bits from 63 bit PN generator started in the all 1's state. The generator polynomial is $X^6+X^5+X^2+X+1$
2. Each of these words is a 5 channel subcom; 4 words of IR data plus subcom sync (10 A0"s)
3. The 104th word of each AMSU/MHS data frame of the MIRP contains 1110110100.
4. Derived by inverting the output of a 1023 bit PN sequence provided by a feedback shift register generating the polynomial: $X^{10}+X^5+X^2+X+1$. The generator is started in all 1's state at the beginning of word 7 of each minor frame.
5. Each minor frame contains the data obtained during one Earth scan of the AVHRR sensor. The data from the five sensor channels of the AVHRR are time multiplexed as indicated.
6. Derived from the non-inverted output of a 1023 bit PN sequence provided by a feedback shift register generating the polynomial: $X^{10}+X^5+X^2+X+1$. The generator is started in the all 1's state at the beginning of word 10,991.

4.1.4 DIGITAL "A" TELEMETRY

The output data signals supplied by the instrument to the spacecraft can be assigned to three categories: 1) instrument Digital "A" (scientific) data; 2) Digital "B" Telemetry; and 3) Analog Telemetry. For purposes of this document, Digital "A" data are described in this section

4.1.4.1 AMSU-A1 for NOAA KLM

The AMSU-A1 Digital "A" telemetry incorporates all of the radiometric data taken during one scan. It also includes the data from the on-orbit calibrations. In the Full Scan Mode, the AMSU-A1 for NOAA KLM and NOAA-N, N' has 1,244 Digital "A" telemetry points, as identified in Table 4.1.4.1-1.

A1 Frame Byte Number	Parameter
1-3	Sync. Sequence (FF Hex)
4	Unit Identification and Serial Number
5	Digital Housekeeping Data 1
6	Digital Housekeeping Data 2
7	Digital Housekeeping Data 3
8	Digital Housekeeping Data 4
9	Reflector 1, Position 1, MSP, First reading
10	Reflector 1, Position 1, LSP, First reading
11	Reflector 2, Position 1, MSP, First reading

12	Reflector 2, Position 1, LSP, First reading
13	Reflector 1, Position 1, MSP, Second reading
14	Reflector 1, Position 1, LSP, Second reading
15	Reflector 2, Position 1, MSP, Second reading
16	Reflector 2, Position 1, LSP, Second reading
17	Scene Position 1, Channel 3, MSP
18	Scene Position 1, Channel 3, LSP
19	Scene Position 1, Channel 4, MSP
20	Scene Position 1, Channel 4, LSP
...	...
41	Scene Position 1, Channel 15, MSP
42	Scene Position 1, Channel 15, LSP
43	Reflector 1, Position 2, MSP, First reading
44	Reflector 1, Position 2, LSP, First reading
45	Reflector 2, Position 2, MSP, First reading
46	Reflector 2, Position 2, LSP, First reading
47	Reflector 1, Position 2, MSP, Second reading
48	Reflector 1, Position 2, LSP, Second reading
49	Reflector 2, Position 2, MSP, Second reading
50	Reflector 2, Position 2, LSP, Second reading
51	Scene Position 2, Channel 3, MSP
52	Scene Position 2, Channel 3, LSP
...	...
75	Scene Position 2, Channel 15, MSP
76	Scene Position 2, Channel 15, LSP
77	Reflector 1, Position 3, MSP, First reading
78	Reflector 1, Position 3, LSP, First reading
79	Reflector 2, Position 3, MSP, First reading
80	Reflector 2, Position 3, LSP, First reading
81	Reflector 1, Position 3, MSP, Second reading
82	Reflector 1, Position 3, LSP, Second reading
83	Reflector 2, Position 3, MSP, Second reading
84	Reflector 2, Position 3, LSP, Second reading
85	Scene Position 3, Channel 3, MSP
86	Scene Position 3, Channel 3, LSP
...	...
1027	Scene Position 30, Channel 15, MSP
1028	Scene Position 30, Channel 15, LSP
1029	Reflector 1, Cold Cal. Position, MSP, First reading
1030	Reflector 1, Cold Cal. Position, LSP, First reading
1031	Reflector 2, Cold Cal. Position, MSP, First reading
1032	Reflector 2, Cold Cal. Position, LSP, First reading
1033	Reflector 1, Cold Cal. Position, MSP, Second reading

1034	Reflector 1, Cold Cal. Position, LSP, Second reading
1035	Reflector 2, Cold Cal. Position, MSP, Second reading
1036	Reflector 2, Cold Cal. Position, LSP, Second reading
1037	Cold Calibration 1, Channel 3, MSP
1038	Cold Calibration 1, Channel 3, LSP
1039	Cold Calibration 1, Channel 4, MSP
1040	Cold Calibration 1, Channel 4, LSP
...	...
1061	Cold Calibration 1, Channel 15, MSP
1062	Cold Calibration 1, Channel 15, LSP
1063	Cold Calibration 2, Channel 3, MSP
1064	Cold Calibration 2, Channel 3, LSP
1065	Cold Calibration 2, Channel 4, MSP
1066	Cold Calibration 2, Channel 4, LSP
...	...
1087	Cold Calibration 2, Channel 15, MSP
1088	Cold Calibration 2, Channel 15, LSP
1089	Temp Sensor 1, MSP
1090	Temp Sensor 1, LSP
1091	Temp Sensor 2, MSP
1092	Temp Sensor 2, LSP
...	...
1177	Temp Sensor 45, MSP
1178	Temp Sensor 45, LSP
1179	Temp Sensor Reference Voltage, MSP
1180	Temp Sensor Reference Voltage, LSP
1181	Reflector 1 Warm Cal. Position, MSP, First reading
1182	Reflector 1 Warm Cal. Position, LSP, First reading
1183	Reflector 2 Warm Cal. Position, MSP, First reading
1184	Reflector 2 Warm Cal. Position, LSP, First reading
1185	Reflector 1 Warm Cal. Position, MSP, Second reading
1186	Reflector 1 Warm Cal. Position, LSP, Second reading
1187	Reflector 2 Warm Cal. Position, MSP, Second reading
1188	Reflector 2 Warm Cal. Position, LSP, Second reading
1189	Warm Calibration 1, Channel 3, MSP
1190	Warm Calibration 1, Channel 3, LSP
...	...
1213	Warm Calibration 1, Channel 15, MSP
1214	Warm Calibration 1, Channel 15, LSP
1215	Warm Calibration 2, Channel 3, MSP
1216	Warm Calibration 2, Channel 3, LSP
...	...
1239	Warm Calibration 2, Channel 15, MSP

1240	Warm Calibration 2, Channel 15, LSP
...	...
1241-1243	Sync. Sequence (FF Hex)
1244	nit Identification and Serial Number
<p>Notes:</p> <ol style="list-style-type: none"> 1. The MSP is the most significant portion of a particular measurement; the LSP is the least significant portion of the particular measurement. 2. The first set of readings for a particular reflector position are made prior to the integration interval; the second set of readings are made approximately halfway through the integration period. 3. Digital “A” data as read by the spacecraft shall contain an undetermined number of “fill words”. These fill words shall be 0001H and will be intermingled with valid data. The Digital “A” data as sent by the instrument shall be such that no valid data of 0001H shall be included. 4. Format of Position data is: DDDDDDDDDDDDDDE0, where: D = Data E = Error bit: 0=not in spec, 1=spec. 0 = Zero 5. Format of Radiometer data is: DDDDDDDDDDDDDDD0, where: D = Data 0 = Zero 6. Temperature Sensor Reference Voltage utilized for temperature sensors 36-45 only. 	

Table 4.1.4.1-2. AMSU-A1 Data Word Description	
Housekeeping Data, Byte Number 1	
Bit #	Description
0	0
1	Full Scan Mode: 0 = Not Full Scan Mode; 1 = Full Scan.
2	Warm Cal Mode: 0 = Not in Warm Cal; 1 = Warm Cal.
3	Cold Cal Mode: 0 = Not in Cold Cal; 1 = Cold Cal.
4	Nadir Mode: 0 = Not in Nadir; 1 = Nadir
5	Cold Cal Position, LSB
6	Cold Cal Position, MSB
7	0
Housekeeping Data, Byte Number 2	
0	0
1	Scanner A1-1 Power:

	0 = Off; 1 = On.
2	Scanner A1-2: 0 = Off 1 = On.
3	PLL Power: 0 = Redundant (PLO #2) 1 = Primary (PLO #1).
4	Survival Heater Power: 0 = Off; 1 = On.
5	0
6	0
7	0
Housekeeping Data, Byte 3	
0	0
1	0
2	0
3	0
4	0
5	0
6	0
7	0
Housekeeping Data, Byte 4	
0	0
1	0
2	0
3	0
4	0
5	0
6	0
7	0
Temperature Sensor Assignments	
Number	Location
1	Scan Motor A1-1
2	Scan Motor A1-2
3	Feedhorn A1-1
4	Feedhorn A1-2
5	RF Mux A1-1
6	RF Mux A1-2
7	Local Oscillator Channel 3
8	Local Oscillator Channel 4
9	Local Oscillator Channel 5
10	Local Oscillator Channel 6

11	Local Oscillator Channel 7
12	Local Oscillator Channel 8
13	Local Oscillator Channel 15
14	PLL LO #2 Channels 9 through 14 (See Note 1)
15	PLL LO#1 Channels 9 through 14
16	PLLO (Reference Oscillator) for S/N 101-104, Not Used for S/N 105-109
17	Mixer/IF Amplifier Channel 3
18	Mixer/IF Amplifier Channel 4
19	Mixer/IF Amplifier Channel 5
20	Mixer/IF Amplifier Channel 6
21	Mixer/IF Amplifier Channel 7
22	Mixer/IF Amplifier Channel 8
23	Mixer/IF Amplifier Channel 9/14
24	Mixer/IF Amplifier Channel 15
25	IF Amplifier Channel 11/14
26	IF Amplifier Channel 9
27	IF Amplifier Channel 10
28	IF Amplifier Channel 11
29	DC/DC Converter
30	IF Amplifier Channel 13
31	IF Amplifier Channel 14
32	IF Amplifier Channel 15
33	RF Shelf A1-1
34	RF Shelf A1-2
35	Detector/Preamplifier Assembly
36	A1-1 Warm Load 1 – Not Valid for S/N 103
37	A1-1 Warm Load 2
38	A1-1 Warm Load 3
39	A1-1 Warm Load 4
40	A1-1 Warm Load Center
41	A1-2 Warm Load 1
42	A1-1 Warm Load 2
43	A1-1 Warm Load 3
44	A1-1 Warm Load 4
45	A1-1 Warm Load Center

AMSU A-1 Identification Words

Unit Number	Identification No. (Binary)	S/N
Engineering Model Module A1	00000001	101
Proto Flight Model Module A1	00000101	102
Flight Model 1 Module A1	00001001	103
Flight Model 2 Module A1	00001101	104

Flight Model 3 Module A1	00010001	105
Flight Model 4 Module A1	00010101	106
Flight Model 5 Module A1	00011001	107
Flight Model 6 Module A1	00011101	108
Flight Model 7 Module A1	00100001	109

Note:

1) For S/N 102: Read PRT temperature. Read voltage of lock detect signal and convert to temperature using the following formula: $t = (8.73 \times V) - 23.5$ where t is the temperature (in C) and V is the measured lock detect voltage signal. If the temperature given by the PRT reading and the formula are in agreement within $\pm 5C$, then use the PRT reading as it was intended. If the temperature difference is greater than $\pm 5C$, then use the temperature interpreted from lock detect signal. At initial power on of PLLO#2 before PLLO#2 is fully self heated and stabilized, use within $\pm 5C$ rule with reference A1-1 (PRT #33) RF -shelf temperature. The within $\pm 5C$ rule does not apply right after PLLO was operational and was switched off and then back on. In this case, wait half an hour for PLLO#2 to cool down before temperature extraction method can be selected correctly. The formula $t = (8.75 \times V) - 23.5$ is usable only between 2.5V to +8.4V or -1.6 to 50 C.

4.1.4.2 AMSU-A2 for NOAA KLM

The AMSU-A2 Digital "A" telemetry incorporates all of the radiometric data taken during one scan. It also includes the data from the on-orbit calibrations. The AMSU-A2 has 316 Digital "A" telemetry points, as described in Table 4.1.4.2-1, in the Full Scan Mode.

Table 4.1.4.2-1. AMSU-A2 Digital "A" Format - Full Scan Mode for NOAA KLM.	
A2 Frame Byte Number	Parameter
1-3	Sync. Sequence (FF Hex)
4	Unit Identification and Serial Number
5	Digital Housekeeping Data 1
6	Digital Housekeeping Data 2
7	Digital Housekeeping Data 3
8	Digital Housekeeping Data 4
9	Reflector, Position 1, MSP, First reading
10	Reflector, Position 1, LSP, First reading
11	Reflector, Position 1, MSP, Second reading
12	Reflector, Position 1, LSP, Second reading
13	Scene Position 1, Channel 1, MSP
14	Scene Position 1, Channel 1, LSP
15	Scene Position 1, Channel 2, MSP
16	Scene Position 1, Channel 2, LSP
17	Reflector, Position 2, MSP, First reading
18	Reflector, Position 2, LSP, First reading
19	Reflector, Position 2, MSP, Second reading
20	Reflector, Position 2, LSP, Second reading

21	Scene Position 2, Channel 1, MSP
22	Scene Position 2, Channel 1, LSP
23	Scene Position 2, Channel 2, MSP
24	Scene Position 2, Channel 2, LSP
25	Reflector, Position 3, MSP, First reading
26	Reflector, Position 3, LSP, First reading
27	Reflector, Position 3, MSP, Second reading
28	Reflector, Position 3, LSP, Second reading
29	Scene Position 3, Channel 1, MSP
30	Scene Position 3, Channel 1, LSP
...	...
247	Scene Position 30, Channel 2, MSP
248	Scene Position 30, Channel 2, LSP
249	Reflector, Cold Calibration Position, MSP, First reading
250	Reflector, Cold Calibration Position, LSP, First reading
251	Reflector, Cold Calibration Position, MSP, Second reading
252	Reflector, Cold Calibration Position, LSP, Second reading
253	Cold Calibration 1, Channel 1, MSP
254	Cold Calibration 1, Channel 1, LSP
255	Cold Calibration 1, Channel 2, MSP
256	Cold Calibration 1, Channel 2, LSP
257	Cold Calibration 2, Channel 1, MSP
258	Cold Calibration 2, Channel 1, LSP
259	Cold Calibration 2, Channel 2, MSP
260	Cold Calibration 2, Channel 2, LSP
261	Temperature Sensor 1, MSP
262	Temperature Sensor 1, LSP
263	Temperature Sensor 2, MSP
264	Temperature Sensor 2, LSP
...	...
297	Temperature Sensor 19, MSP
298	Temperature Sensor 19, LSP
299	Temperature Sensor Reference Voltage, MSP
300	Temperature Sensor Reference Voltage, LSP
301	Reflector Warm Calibration Position, MSP, First reading
302	Reflector Warm Calibration Position, LSP, First reading
303	Reflector Warm Calibration Position, MSP, Second reading
304	Reflector Warm Calibration Position, LSP, Second reading
305	Warm Calibration 1, Channel 1, MSP

306	Warm Calibration 1, Channel 1, LSP
307	Warm Calibration 1, Channel 2, MSP
308	Warm Calibration 1, Channel 2, LSP
309	Warm Calibration 2, Channel 1, MSP
310	Warm Calibration 2, Channel 1, LSP
311	Warm Calibration 2, Channel 2, MSP
312	Warm Calibration 2, Channel 2, LSP
313-315	Synchronization Sequence (FF Hex)
316	Unit Identification and Serial Number

Notes:

1. MSP is the most significant portion of a particular measurement while the LSP is the least significant portion of the particular measurement.
- 2) The first set of readings for a particular reflector position are made prior to the integration interval; the second set of readings are made approximately half way through the integration period.
- 3) Digital “A” data as read by the spacecraft shall contain an undetermined number of “fill words”. These fill words shall be 0001H and will be intermingled with valid data. The Digital “A” data as sent by the instrument shall be such that no valid data of 0001H shall be included.
- 4) Format of Position data is DDDDDDDDDDDDDDE0, where:
D=Data
E=Error bit: 0=not in spec, 1=spec.
0=Zero
- 5) Format of Radiometer data is DDDDDDDDDDDDDDD0, where:
D=Data
0=Zero
- 6) Temperature sensor reference voltage is utilized for temperature sensors 13 through 19 only.

Table 4.1.4.2-2. AMSU-A1 Data Word Description

Housekeeping Data, Byte Number 1	
Bit #	Description
0	0
1	Full Scan Mode: 0 = Not Full Scan Mode; 1 = Full Scan.
2	Warm Cal Mode: 0 = Not in Warm Cal; 1 = Warm Cal.
3	Cold Cal Mode: 0 = Not in Cold Cal; 1 = Cold Cal.
4	Nadir Mode: 0 = Not in Nadir; 1 = Nadir

5	Cold Cal Position, LSB
6	Cold Cal Position, MSB
7	0
Housekeeping Data, Byte Number 2	
0	0
1	Scanner A2: 0 = Off 1 = On.
2	Scanner Compensator Power: 0 = Off; 1 = On.
3	0
4	Survival Heater Power: 0 = Off; 1 = On.
5	0
6	0
7	0
Housekeeping Data, Byte 3	
0	0
1	0
2	0
3	0
4	0
5	0
6	0
7	0
Housekeeping Data, Byte 4	
0	0
1	0
2	0
3	0
4	0
5	0
6	0
7	0
Temperature Sensor Assignments	
Number	Location
1	Scan Motor
2	Feed Horn
3	RF Mux
4	Mixer IF Amplifier Channel 1
5	Mixer IF Amplifier Channel 2
6	Local Oscillator Channel 1

7	Local Oscillator Channel 2	
8	Compensation Motor	
9	Subreflector	
10	DC/DC Converter	
11	RF Shelf	
12	Detector/Preamplifier Assembly	
13	Warm Load Center	
14	Warm Load 1	
15	Warm Load 2	
16	Warm Load 3	
17	Warm Load 4	
18	Warm Load 5	
19	Warm Load 6	
AMSU A-1 Identification Words		
Unit Number	Identification No. (Binary)	S/N
Engineering Model Module A2	00000010	101
Proto Flight Model Module A2	00000110	102
Flight Model 1 Module A2	00001010	103
Flight Model 2 Module A2	00001110	104
Flight Model 3 Module A2	00010010	105
Flight Model 4 Module A2	00010110	106
Flight Model 5 Module A2	00011010	107
Flight Model 6 Module A2	00011110	108
Flight Model 7 Module A2	00100010	109

4.1.4.3 AMSU-B for NOAA KLM

Digital "A" Data is clocked into the spacecraft AIP at a 16.64 kbps rate by the shift pulse whenever the Data Enable Pulse is presented to the instrument. The AMSU-B data is in the AIP minor frame words 48 through 97. The AIP reads the digital data output from the AMSU-B in 16 bit words.

The AMSU-B telemetry format consists of 78 minor frames of data. Minor frames 1 and 80 in each 8 second cycle are blank: i.e. no data is available in the PEU digital data FIFO during the first and last minor frames of each 8 second format. The 78 minor frames are organized as three blocks of 650 words as follows (representing one scan of the instrument):

36 spare words

540 words of Earth view pixel data
(90 x (5 channels + shaft position at mid-pixel))

26 words of housekeeping data

48 words of space view and target view data
(2 x 4 x (5 channels + shaft position))

This structure is maintained for all modes. In static modes, all pixel data locations contain the pixel data for the current antenna position.

The AMSU-B digital format is synchronized to the 8 second synchronization pulse. During each minor frame, 25 words of data are available in the PEU O/P FIFO within 16.7 milliseconds of the start of the minor frame (except in frames 1 and 80). Table 4.1.4.3-1 shows the AMSU-B digital A data format.

Word Length: 16 bits

Serial Output: 25 - 16 bit words per 100 sec (MSB first)

Table 4.1.4.3-1. AMSU-B Digital “A” Data Format for NOAA KLM.

Word Number	Minor Frame									
	1	2	3	4	5	6	7	8	9	10
01	Blank	SP1	SP26	17/03	18/07	19/11	20/15	P/20	16/24	17/28
02		SP2	SP27	18/03	19/07	20/11	P/16	16/20	17/24	18/28
03		SP3	SP28	19/03	20/07	P/12	16/16	17/20	18/24	19/28
04		SP4	SP29	20/03	P/08	16/12	17/16	18/20	19/24	20/28
05		SP5	SP30	P/04	16/08	17/12	18/16	19/20	20/24	P/29
06		SP6	SP31	16/04	17/08	18/12	19/16	20/20	P/25	16/29
07		P7	SP32	17/04	18/08	19/12	20/16	P/21	16/25	17/29
08		SP8	SP33	18/04	19/08	20/12	P/17	16/21	17/25	18/29
09		SP9	SP34	19/04	20/08	P/13	16/17	17/21	18/25	19/29
10		SP10	SP35	20/04	P/09	16/13	17/17	18/21	19/25	20/29
11		SP11	SP36	P/05	16/09	17/13	18/17	19/21	20/25	P/30
12		SP12	P/01	16/05	17/09	18/13	19/17	20/21	P/26	16/30
13		SP13	16/01	17/05	18/09	19/13	20/17	P/22	16/26	17/30
14		SP14	17/01	18/05	19/09	20/13	P/18	16/22	17/26	18/30
15		SP15	18/01	19/05	20/09	P/14	16/18	17/22	18/26	19/30
16		SP16	19/01	20/05	P/10	16/14	17/18	18/22	19/26	20/30
17		SP17	20/01	P/06	16/10	17/14	18/18	19/22	20/26	P/31
18		SP18	P/02	16/06	17/10	18/14	19/18	20/22	P/27	16/31
19		SP19	16/02	17/06	18/10	19/14	20/18	P/23	16/27	17/31
20		SP20	17/02	18/06	19/10	20/14	P/19	16/23	17/27	18/31
21		SP21	18/02	19/06	20/10	P/15	16/19	17/23	18/27	19/31
22		SP22	19/02	20/06	P/11	16/15	17/19	18/23	19/27	20/31
23		SP23	20/02	P/07	16/11	17/15	18/19	19/23	20/27	P/32

24		SP24	P/03	16/07	17/11	18/15	19/19	20/23	P/28	16/32
25		SP25	16/03	17/07	18/11	19/15	20/19	P/24	16/28	17/32
Word Number	Minor Frame									
	11	12	13	14	15	16	17	18	19	20
01	18/32	9/36	20/40	P/45	16/49	17/53	18/57	19/61	20/65	P/70
02	19/32	20/36	P/41	16/45	17/49	18/53	19/57	20/61	P/66	16/70
03	20/32	P/37	16/41	17/45	18/49	19/53	20/57	P/62	16/66	17/70
04	P/33	16/37	17/41	18/45	19/49	20/53	P/58	16/62	17/66	18/70
05	16/33	17/37	18/41	19/45	20/49	P/54	16/58	17/62	18/66	19/70
06	17/33	18/37	19/41	20/45	P/50	16/54	17/58	18/62	19/66	20/70
07	18/33	19/37	20/41	P/46	16/50	17/54	18/58	19/62	20/66	P/71
08	19/33	20/37	P/42	16/46	17/50	18/54	19/58	20/62	P/67	16/71
09	20/33	P/38	16/42	17/46	18/50	19/54	20/58	P/63	16/67	17/71
10	P/34	16/38	17/42	18/46	19/50	20/54	P/59	16/63	17/67	18/71
11	16/34	17/38	18/42	19/46	20/50	P/55	16/59	17/63	18/67	19/71
12	17/34	18/38	19/42	20/46	P/51	16/55	17/59	18/63	19/67	20/71
13	18/34	19/38	20/42	P/47	16/51	17/55	18/59	19/63	20/67	P/72
14	19/34	0/38	/43	16/47	17/51	8/55	19/59	20/63	P/68	16/72
15	20/34	P/39	16/43	17/47	18/51	19/55	20/59	P/64	16/68	17/72
16	P/35	16/39	17/43	18/47	19/51	20/55	P/60	16/64	17/68	18/72
17	16/35	17/39	18/43	19/47	20/51	P/56	16/60	17/64	18/68	19/72
18	17/35	18/39	19/43	20/47	P/52	16/56	17/60	18/64	19/68	20/72
19	18/35	19/39	20/43	P/48	16/52	17/56	18/60	19/64	20/68	P/73
20	19/35	20/39	P/44	16/48	17/52	18/56	19/60	20/64	P/69	16/73
21	20/35	P/40	16/44	17/48	18/52	19/56	20/60	P/65	16/69	17/73
22	/36	16/40	17/44	18/48	19/52	20/56	P/61	16/65	17/69	18/73
23	16/36	17/40	18/44	19/48	20/52	P/57	16/61	17/65	18/69	19/73
24	17/36	18/40	19/44	20/48	P/53	16/57	17/61	18/65	19/69	20/73
25	18/36	19/40	20/44	P/49	16/53	17/57	18/61	19/65	20/69	P/74
Word Number	Minor Frame									
	21	22	23	24	25	26	27	28	29	30
01	16/74	17/78	18/82	19/86	20/90	A25	20/S4	SP1	TST09	17/03
02	17/74	18/78	19/82	20/86	A01	A26	P/T1	SP2	TST10	18/03
03	18/74	19/78	20/82	P/87	A02	P/S1	16/T1	SP3	TST11	19/03
04	19/74	20/78	P/83	16/87	A03	16/S1	17/T1	SP4	TST12	20/03
05	20/74	P/79	16/83	17/87	A04	17/S1	18/T1	SP5	TST13	P/04
06	P/75	16/79	17/83	18/87	A05	18/S1	19/T1	SP6	TST14	16/04
07	16/75	17/79	18/83	19/87	A06	19/S1	20/T1	SP7	TST15	17/04
08	17/75	18/79	19/83	20/87	A07	20/S1	P/T2	SP8	TST16	18/04
09	18/75	19/79	20/83	P/88	A08	P/S2	16/T2	SP9	TST17	19/04
10	19/75	20/79	P/84	16/88	A09	16/S2	17/T2	SP10	TST18	20/04
11	20/75	P/80	16/84	17/88	A10	17/S2	18/T2	SP11	TST19	P/05
12	P/76	16/80	17/84	18/88	A11	18/S2	19/T2	SP12	P/01	16/05

13	16/76	17/80	18/84	19/88	A12	19/S2	20/T2	SP13	16/01	17/05
14	17/76	18/80	19/84	20/88	A13	20/S2	P/T3	SP14	17/01	18/05
15	18/76	19/80	20/84	P/89	A14	P/S3	16/T3	SP15	18/01	19/05
16	19/76	20/80	P/85	16/89	A15	16/S3	17/T3	SP16	19/01	20/05
17	20/76	P/81	16/85	17/89	A16	17/S3	18/T3	SP17	20/01	P/06
18	P/77	16/81	17/85	18/89	A17	18/S3	19/T3	TST01	P/02	16/06
19	16/77	17/81	18/85	19/89	A18	19/S3	20/T3	TST02	16/02	17/06
20	17/77	18/81	19/85	20/89	A19	20/S3	P/T4	TST03	17/02	18/06
21	18/77	19/81	20/85	P/90	A20	P/S4	16/T4	TST04	18/02	19/06
22	19/77	20/81	P/86	16/90	A21	16/S4	17/T4	TST05	19/02	20/06
23	20/77	P/82	16/86	17/90	A22	17/S4	18/T4	TST06	20/02	P/07
24	P/78	16/82	17/86	18/90	A23	18/S4	19/T4	TST07	P/03	16/07
25	16/78	17/82	18/86	19/90	A24	19/S4	20/T4	TST08	16/03	17/07
Word Number	Minor Frame									
	31	32	33	34	35	36	37	38	39	40
01	18/07	19/11	20/15	P/20	16/24	17/28	18/32	19/36	20/40	P/45
02	19/07	20/11	P/16	16/20	17/24	18/28	19/32	20/36	P/41	16/45
03	20/07	P/12	16/16	17/20	18/24	19/28	20/32	P/37	16/41	17/45
04	P/08	16/12	17/16	18/20	19/24	20/28	P/33	16/37	17/41	18/45
05	16/08	17/12	18/16	19/20	20/24	P/29	16/33	17/37	18/41	19/45
06	17/08	18/12	19/16	20/20	P/25	16/29	17/33	18/37	19/41	20/45
07	8/08	19/12	20/16	P/21	16/25	17/29	18/33	19/37	20/41	P/46
08	19/08	20/12	P/17	16/21	17/25	18/29	19/33	20/37	P/42	16/46
09	20/08	P/13	16/17	17/21	18/25	19/29	20/33	P/38	16/42	17/46
10	P/09	16/13	17/17	18/21	19/25	20/29	P/34	16/38	17/42	18/46
11	16/09	17/13	18/17	19/21	20/25	P/30	16/34	17/38	18/42	19/46
12	17/09	18/13	19/17	20/21	P/26	16/30	17/34	18/38	19/42	20/46
13	18/09	19/13	20/17	P/22	16/26	17/30	18/34	19/38	20/42	P/47
14	19/09	20/13	P/18	16/22	17/26	18/30	19/34	20/38	P/43	16/47
15	20/09	P/14	16/18	17/22	18/26	19/30	20/34	P/39	16/43	17/47
16	P/10	16/14	17/18	18/22	19/26	20/30	P/35	16/39	17/43	18/47
17	16/10	17/14	18/18	19/22	20/26	P/31	16/35	17/39	18/43	19/47
18	17/10	18/14	19/18	20/22	P/27	16/31	17/35	18/39	19/43	20/47
19	18/10	19/14	20/18	P/23	16/27	17/31	18/35	19/39	20/43	P/48
20	19/10	20/14	P/19	16/23	17/27	18/31	19/35	20/39	P/44	16/48
21	20/10	P/15	16/19	17/23	18/27	19/31	20/35	P/40	16/44	17/48
22	P/11	16/15	17/19	18/23	19/27	20/31	P/36	16/40	17/44	18/48
23	16/11	17/15	18/19	19/23	20/27	P/32	16/36	17/40	18/44	19/48
24	17/11	18/15	19/19	20/23	P/28	16/32	17/36	18/40	19/44	20/48
25	18/11	19/15	20/19	P/24	16/28	17/32	18/36	19/40	20/44	P/49
Word Number	Minor Frame									
	41	42	43	44	45	46	47	48	49	50
1	16/49	17/53	18/57	19/61	20/65	P/70	16/74	17/78	18/82	19/86

02	17/49	18/53	19/57	20/61	P/66	16/70	17/74	18/78	19/82	20/86
03	18/49	19/53	20/57	P/62	16/66	17/70	18/74	19/78	20/82	P/87
04	19/49	20/53	P/58	16/62	17/66	18/70	19/74	20/78	P/83	16/87
05	20/49	P/54	16/58	17/62	18/66	19/70	20/74	P/79	16/83	17/87
06	P/50	16/54	17/58	18/62	19/66	20/70	P/75	16/79	17/83	18/87
07	16/50	17/54	18/58	19/62	20/66	P/71	16/75	17/79	18/83	19/87
08	17/50	18/54	19/58	20/62	P/67	16/71	17/75	18/79	19/83	20/87
09	18/50	19/54	20/58	P/63	16/67	17/71	18/75	19/79	20/83	P/88
10	19/50	20/54	P/59	16/63	17/67	18/71	19/75	20/79	P/84	16/88
11	20/50	P/55	16/59	17/63	18/67	19/71	20/75	P/80	16/84	17/88
12	P/51	16/55	17/59	18/63	19/67	20/71	P/76	16/80	17/84	18/88
13	16/51	17/55	18/59	19/63	20/67	P/72	16/76	17/80	18/84	19/88
14	17/51	18/55	19/59	20/63	P/68	16/72	17/76	18/80	19/84	20/88
15	18/51	19/55	20/59	P/64	16/68	17/72	18/76	19/80	20/84	P/89
16	19/51	20/55	P/60	16/64	17/68	18/72	19/76	20/80	P/85	16/89
17	20/51	P/56	16/60	17/64	18/68	19/72	20/76	P/81	16/85	17/89
18	P/52	16/56	17/60	18/64	19/68	20/72	P/77	16/81	17/85	18/89
19	16/52	17/56	18/60	19/64	20/68	P/73	16/77	17/81	18/85	19/89
20	17/52	18/56	19/60	20/64	P/69	16/73	17/77	18/81	19/85	20/89
21	18/52	19/56	20/60	P/65	16/69	17/73	18/77	19/81	20/85	P/90
22	19/52	20/56	P/61	16/65	17/69	18/73	19/77	20/81	P/86	16/90
23	20/52	P/57	16/61	17/65	18/69	19/73	20/77	P/82	16/86	17/90
24	P/53	16/57	17/61	18/65	19/69	20/73	P/78	16/82	17/86	18/90
25	16/53	17/57	18/61	19/65	20/69	P/74	16/78	17/82	18/86	19/90
Word Number	Minor Frame									
	51	52	53	54	55	56	57	58	59	60
01	20/90	A25	20/S4	SP1	TST09	17/03	18/07	19/11	20/15	P/20
02	A01	A26	P/T1	SP2	TST10	18/03	19/07	20/11	P/16	16/20
03	A02	P/S1	16/T1	SP3	TST11	19/03	20/07	P/12	16/16	17/20
04	A03	16/S1	17/T1	SP4	TST12	20/03	P/08	16/12	17/16	18/20
05	A04	17/S1	18/T1	SP5	TST13	P/04	16/08	17/12	18/16	19/20
06	A05	18/S1	19/T1	SP6	TST14	16/04	17/08	18/12	19/16	20/20
07	A06	19/S1	20/T1	SP7	TST15	17/04	18/08	19/12	20/16	P/21
08	A07	20/S1	P/T2	SP8	TST16	18/04	19/08	20/12	P/17	16/21
09	A08	P/S2	16/T2	SP9	TST17	19/04	20/08	P/13	16/17	17/21
10	A09	16/S2	17/T2	SP10	TST18	20/04	P/09	16/13	17/17	18/21
11	A10	17/S2	18/T2	SP11	TST19	P/05	16/09	17/13	18/17	19/21
12	A11	18/S2	19/T2	SP12	P/01	16/05	17/09	18/13	19/17	20/21
13	A12	19/S2	20/T2	SP13	16/01	17/05	18/09	19/13	20/17	P/22
14	A13	20/S2	P/T3	SP14	17/01	18/05	19/09	20/13	P/18	16/22
15	A14	P/S3	16/T3	SP15	18/01	19/05	20/09	P/14	16/18	17/22
16	A15	16/S3	17/T3	SP16	19/01	20/05	P/10	16/14	17/18	18/22
17	A16	17/S3	18/T3	SP17	20/01	P/06	16/10	17/14	18/18	19/22

18	A17	18/S3	19/T3	TST01	P/02	16/06	17/10	18/14	19/18	20/22
19	A18	19/S3	20/T3	TST02	16/02	17/06	18/10	19/14	20/18	P/23
20	A19	20/S3	P/T4	TST03	17/02	18/06	19/10	20/14	P/19	16/23
21	A20	P/S4	16/T4	TST04	18/02	19/06	20/10	P/15	16/19	17/23
22	A21	16/S4	17/T4	TST05	19/02	20/06	P/11	16/15	17/19	18/23
23	A22	17/S4	18/T4	TST06	20/02	P/07	16/11	17/15	18/19	19/23
24	A23	18/S4	19/T4	TST07	P/03	16/07	17/11	18/15	19/19	20/23
25	A24	19/S4	20/T4	TST08	16/03	17/07	18/11	19/15	20/19	P/24
Word Number	Minor Frame									
	61	62	63	64	65	66	67	68	69	70
01	16/24	17/28	18/32	19/36	20/40	P/45	16/49	17/53	18/57	19/61
02	17/24	18/28	19/32	20/36	P/41	16/45	17/49	18/53	19/57	20/61
03	18/24	19/28	20/32	P/37	16/41	17/45	18/49	19/53	20/57	P/62
04	19/24	20/28	P/33	16/37	17/41	18/45	19/49	20/53	P/58	16/62
05	20/24	P/29	16/33	17/37	18/41	19/45	20/49	P/54	16/58	17/62
06	P/25	16/29	17/33	18/37	19/41	20/45	P/50	16/54	17/58	18/62
07	16/25	17/29	18/33	19/37	20/41	P/46	16/50	17/54	18/58	19/62
08	17/25	18/29	19/33	20/37	P/42	16/46	17/50	18/54	19/58	20/62
09	18/25	19/29	20/33	P/38	16/42	17/46	18/50	19/54	20/58	P/63
10	19/25	20/29	P/34	16/38	17/42	18/46	19/50	20/54	P/59	16/63
11	20/25	P/30	16/34	17/38	18/42	19/46	20/50	P/55	16/59	17/63
12	P/26	16/30	17/34	18/38	19/42	20/46	P/51	16/55	17/59	18/63
13	16/26	17/30	18/34	19/38	20/42	P/47	16/51	17/55	18/59	19/63
14	17/26	18/30	19/34	20/38	P/43	16/47	17/51	18/55	19/59	20/63
15	18/26	19/30	20/34	P/39	16/43	17/47	18/51	19/55	20/59	P/64
16	19/26	20/30	P/35	16/39	17/43	18/47	19/51	20/55	P/60	16/64
17	20/26	P/31	16/35	17/39	18/43	19/47	20/51	P/56	16/60	17/64
18	P/27	16/31	17/35	18/39	19/43	20/47	P/52	16/56	17/60	18/64
19	16/27	17/31	18/35	19/39	20/43	P/48	16/52	17/56	18/60	19/64
20	17/27	18/31	19/35	20/39	P/44	16/48	17/52	18/56	19/60	20/64
21	18/27	19/31	20/35	P/40	16/44	17/48	18/52	19/56	20/60	P/65
22	19/27	20/31	P/36	16/40	17/44	18/48	19/52	20/56	P/61	16/65
23	20/27	P/32	16/36	17/40	18/44	19/48	20/52	P/57	16/61	17/65
24	P/28	16/32	17/36	18/40	19/44	20/48	P/53	16/57	17/61	18/65
25	16/28	17/32	18/36	19/40	20/44	P/49	16/53	17/57	18/61	19/65
Word Number	Minor Frame									
	71	72	73	74	75	76	77	78	79	80
01	20/65	P/70	16/74	17/78	18/82	19/86	20/90	A25	20/S4	Blank
02	P/66	16/70	17/74	18/78	19/82	20/86	A01	A26	P/T1	
03	16/66	17/70	18/74	19/78	20/82	P/87	A02	P/S1	16/T1	
04	17/66	18/70	19/74	20/78	P/83	16/87	A03	16/S1	17/T1	
05	18/66	19/70	20/74	P/79	16/83	17/87	A04	17/S1	18/T1	
06	19/66	20/70	P/75	16/79	17/83	18/87	A05	18/S1	19/T1	

07	20/66	P/71	16/75	17/79	18/83	19/87	A06	19/S1	20/T1
08	P/67	16/71	17/75	18/79	19/83	20/87	A07	20/S1	P/T2
09	16/67	17/71	18/75	19/79	20/83	P/88	A08	P/S2	16/T2
10	17/67	18/71	19/75	20/79	P/84	16/88	A09	16/S2	17/T2
11	18/67	19/71	20/75	P/80	16/84	17/88	A10	17/S2	18/T2
12	19/67	20/71	P/76	16/80	17/84	18/88	A11	18/S2	19/T2
13	20/67	P/72	16/76	17/80	18/84	19/88	A12	19/S2	20/T2
14	P/68	16/72	17/76	18/80	19/84	20/88	A13	20/S2	P/T3
15	6/68	17/72	18/76	19/80	20/84	P/89	A14	P/S3	16/T3
16	17/68	18/72	19/76	20/80	P/85	16/89	A15	16/S3	17/T3
17	18/68	19/72	20/76	P/81	16/85	17/89	A16	17/S3	18/T3
18	19/68	20/72	P/77	16/81	17/85	18/89	A17	18/S3	19/T3
19	20/68	P/73	16/77	17/81	18/85	19/89	A18	19/S3	20/T3
20	P/69	16/73	17/77	18/81	19/85	20/89	A19	20/S3	P/T4
21	16/69	17/73	18/77	19/81	20/85	P/90	A20	P/S4	16/T4
22	17/69	18/73	19/77	20/81	P/86	16/90	A21	16/S4	17/T4
23	18/69	19/73	20/77	P/82	16/86	17/90	A22	17/S4	18/T4
24	19/69	20/73	P/78	16/82	17/86	18/90	A23	18/S4	19/T4
25	20/69	P/74	16/78	17/82	18/86	19/90	A24	19/S4	20/T4

NOTES ON THE PREVIOUS TABLES:

The format consists of minor frames (1 to 80). Minor frames 1 and 80 are blank. This means that no data is available in the PEU output FIFO for reading by the AIP and therefore the AIP should not send any sample pulses to AMSU-B during these minor frame periods.

Table 4.1.4.3-2 indicates the meanings for the variables used in Table 4.1.4.3-1:

Table 4.1.4.3-2. Meaning of Variables in Table 4.1.4.3-1.	
Key	Meaning
SP	Spare word (Data is 5555H except for spare words 34 to 36)
TSTxx	Test Data
P/n	Shaft position at mid-integration time for FOV n.
16/n	Integrated output for channel 16 for FOV n.
17/n	Integrated output for channel 17 for FOV n.
18/n	Integrated output for channel 18 for FOV n.
19/n	Integrated output for channel 19 for FOV n.
20/n	Integrated output for channel 20 for FOV n.
/Sn	Space view FOV n.
/Tn	Internal Target view FOV n.
AXX	Multiplexed Housekeeping data.

Table 4.1.3-3. AMSU-B Data Word Description	
Digital Sub-multiplexed Channels	
A01	Unit ID + Flags
A02	Digital b Telemetry
A03	Mixer 16 Temperature
A04	Mixer 17 Temperature
A05	Mixer 18/19/20 Temperature
A06	FET Amplifier 16 Temperature
A07	FET Amplifier 17 Temperature
A08	FET Amplifier 18 Temperature
A09	FET Amplifier 19 Temperature
A10	FET Amplifier 20 Temperature
A11	Calibration Target Temperature 1
A12	Calibration Target Temperature 2
A13	Calibration Target Temperature 3
A14	Calibration Target Temperature 4
A15	Calibration Target Temperature 5
A16	Calibration Target Temperature 6
A17	Calibration Target Temperature 7
A18	Sub-reflector Temperature 1
A19	Local Oscillator Monitor Current 16
A20	Local Oscillator Monitor Current 17

A21	Local Oscillator Monitor Current 18/19/20
A22	Local Oscillator 16 Temperature
A23	Local Oscillator 17 Temperature
A24	Local Oscillator 18/19/20 Temperature
A25	PRT Bridge Voltage
A26	PRT Board Temperature
Bit	A01
00	Module ID (LSB)
01	Module ID
02	Module ID
03	Module ID
04	Module ID
05	Module ID
06	Module ID
07	Module ID (MSB)
08	Mode Transition Flag
09	Scan Synchronization
10	Pixel Data Invalid Flag
11	Scan Control Status
12	Processor Check Flag
13	Not Defined
14	Not Defined
15 (MSB)	Not Defined
Module Identification (Bits 00 to 07)	
Unit Number	Identification Number (MSB) (LSB)
EM	0000 0000
PFM	0000 0100
FM2	0000 1000
FM3	0000 1100
Mode Transition (Bit 08)	
0	Transition complete
1	Transition in progress
Scan Synchronization (Bit 09)	
0	Error <0.1 degrees at 8 second sync pulse
1	Error 0.1 degrees at 8 second sync pulse
Pixel Data Invalid (Bit 10)	
0	Valid
1	Invalid
Scan Control Status (Bit 11)	
0	Running
1	Aborted
Processor Check (Bit 12)	
0	Built-In-Test passed
1	Built-In-Test failed

Bit	A02 (See Note 1)
00 (LSB)	Power On/Off (Relay 1 status)
01	Survival heater On/Off (Relay 2 status)
02	Scan normal mode
03	Parked in target view mode
04	Parked in nadir view mode
05	Parked in space view mode
06	Investigation mode
07	Stepped Mode
08	Channel 16 On/Off (Relay 3 status)
09	Channel 17 On/Off (Relay 4 Status)
10	Channel 18/19/20 On/Off (Relay 5 status)
11	Space View Select (MSB)
12	Space View Select (LSB)
13	Memory checks status
14	ROM check flag
15 (MSB)	RAM check flag
Note:	
1. A "1" status indicates "ON" and a "0" (zero) status indicates "OFF."	

The format structure and definition is identical for all modes. In scanning modes, n, Sn and Tn represent pixel identification. In static modes, n, Sn and Tn have no meaning; all data values relate to the IFOV.

4.1.4.4 MHS for NOAA-N,-N'

The Microwave Humidity Sounder (MHS) instrument replaced the AMSU-B instrument on NOAA-N and -N'. Scientifically, the MHS is very similar to the AMSU-B instrument, but the manner in which the data are output is quite different. The equivalent of "Digital" data on AMSU-B is referred to as "science data telemetry" or just "science data" for the MHS instrument, and comes packaged in a "science data telemetry packet" or "Science Packet" (SCI PKT) for short.

The NOAA-N, N' MHS instrument science data is delayed by two scan lines (or 5 2/3 seconds). The operational Level 1b data accounts for the delay and provides correct geo-location information. The delay, however, is not accounted for in the HRPT broadcast. The two scan line delay is caused by data buffering within the MHS instrument and the spacecraft data handling subsystem.

Consultative Committee for Space Data Systems (CCSDS) is composed of space agencies and industrial associates worldwide, working together to provide well-engineered, standardized solutions for common space data handling needs. The benefits of using CCSDS include: reduced cost, risk and development time, as well as enhanced interoperability and cross-support. For more information on CCSDS, refer to their website at: <http://www.ccsds.org/>. The data packets for MHS are in CCSDS format (i.e., a primary header, secondary header and checksum).

The MHS instrument and its associated interface unit (the MIU) on the NOAA satellites can operate in a variety of different modes and output several different packets, or formats, of data. There are nine different modes for the MHS (see Table 4.1.4.4-1 for details). In addition, all the MHS output must be funneled through a new processor, the MHS Interface Unit (MIU), which may ignore the MHS data completely and output its own telemetry instead. Depending on what mode the MIU is in, different information will be output. For purposes of this Users Guide, only the modes in which MHS data are output will be documented.

The MHS instrument, and its associated interface unit (the MIU) on the NOAA satellites, can operate in a variety of different modes and output several different packets, or formats, of data. There are nine different modes for the MHS (see Table 4.1.4.4-1 for details). In addition, all the MHS output must be funneled through a new processor, the MHS Interface Unit (MIU), which may ignore the MHS data completely and output its own telemetry instead. Depending on what mode the MIU is in, different information will be output. For purposes of this Users Guide, only the modes in which MHS data are output will be documented.

Table 4.1.4.4-1. MHS modes.	
MHS Mode	MHS Output
Power-on	Empty Science Data Packet
Warm-up	Empty Science Data Packet
Standby	Empty Science Data Packet
Scan	Science Data Packet
Fixed View	Science Data Packet
Self-test	Extended Test Data Packet
Safeing	Empty Science Data Packet
Fault	Empty Science Data Packet
Memory Dump	Extended Memory Data Packet

The MHS instrument only interfaces to the MIU box. The MIU interfaces to the rest of the NOAA-N, N spacecraft through the TIROS Command and Control Subsystem (CCS), the TIROS Data Handling Subsystem (DHS) and the TIROS Electrical Power Subsystem (EPS). The EPS portion interfacing to the MIU is the Power Subsystem Electronics (PSE) consisting of the 28 v Bus Main, Pulse Load, and Survival Buses. All power is distributed to the MHS through the MIU. The AMSU Information Processor (AIP), the Cross-Strapping Unit (XSU) and the TIROS Information Processor (TIP) boxes comprise the DHS part, while the Control Interface Unit (CIU) is the CCS interface portion of the MIU unit. All of these boxes utilize legacy bus architecture interfaces to the MIU while the MIU implements a Military Standard (MIL-STD) 1553B redundant interface to the MHS instrument. A single 1553 bus is used for commanding (CMD), housekeeping (HK) telemetry and for science (SCI) data telemetry packets between the MHS and the MIU. However, the MIU, being the bus controller, determines whether the primary or redundant 1553 bus is utilized. Other than the 1553 bus, there is no redundancy in the MIU. The MHS is redundant internally, having both A and B sides to its

electronics. The MIU supplies telemetry (MHS and MIU) to the ground during all operational modes. It also provides MHS survival temperature telemetry to the TIP even when the MHS and MIU are not powered.

The AIP provides a serial data stream from the spacecraft, which may be transmitted to the ground or embedded into other composite data streams. Within the AIP data, information is collected from the TIP, AMSU-A1, AMSU-A2, and the MIU. The TIP controls the basic data frame timing, generating a minor frame every tenth of a second (in Orbit Mode) and repeating the entire sequence every 32 seconds, called a major frame. The AIP is synchronized to the TIP timing using the 32-second major frame synchronization, and the harmonically related one-tenth second (10 Hz) pulse. The AIP itself has an 8-second major frame, which means it repeats its sequence four times during a TIP major frame.

Since the TIP and AIP minor frames are both 10 Hz, they are locked together, using the TIP synch timing. The TIP 32-second major frame pulse synchronizes the AIP. AIP generates its own 8-second timing, but since that period is harmonically related, it will not drift significantly from the 32-second pulse. AIP keeps the data from the AMSU's and MIU synchronized by passing on the timing pulses as appropriate.

The AIP stores the data from all four inputs in serial buffers during one minor frame, and sequences it into the data stream in the subsequent frame. This is mechanized using two sets of alternate buffers. AIP will initiate the data transfer with the 10 Hz sync, followed by the appropriate number of word strobes, 56 in the case of the MIU. The sync serves only to define the start of the transfer. The actual timing of the strobes will differ for each data source, and in the case of the MIU may not even be continuous, but it will always follow the sync.

The MIU provides a total of 80 sets of 56 8-bit words, called minor cycles, each of which will be inserted into an AIP minor frame. A minor cycle counter within the MIU keeps track of the frame sequence, and its content is included in the 56-word data sequence. Because of the double buffer arrangement, the MIU minor cycle count may not agree exactly with the AIP minor frame. However, the 8-second sync pulse will ensure that they are sequencing together uniformly, counting the same 80 frames.

The 56-word count is synchronized using the 10 Hz pulse, so that the first word will be transferred by the strobe following the synch. The data from the MHS is partially synchronized to the TIP timing, but the MIL-STD-1553 interface bus and MHS scanning mechanics prevent an exact match. Therefore, the MIU receives the MHS data packets, and packages them along with housekeeping telemetry, to produce the 56-word AIP data.

The 10 Hz and the 8-second sync pulses are received at the MIU and applied to the software using two discrete interrupts. Although both signals are intended to be continuous over long periods, a change in system clocking may result in a jump in either one, which causes it to be early or late with respect to previous pulse timing. The MIU is expected to resynchronize itself to the new sequence.

All AIP telemetry includes the Telemetry Frame Header data in words 6-7 of every minor frame.

This is the same data and format as in the TIP Telemetry described in Table 4.1.4.4-5. Table 4.1.4.4-2 contains the format of the MIU AIP data for bytes 6-7.

Table 4.1.4.4-2. MIU AIP Bytes 6 and 7.					
MIU Minor Cycle	Bytes	Bits	Description/Definition	State	MIU Subsystem
All	6	0-1	RESERVED		TLM
		2-4	Telemetry Mode: Normal (NORM)	000	
			Fast Dump (FADU)	001	
			Slow Dump (SLDU)	010	
	Very Slow Dump (VSDU)		011		
Bus Eng Mode (BEM)	100				
Undefined (UNDF)	101				
Undefined	110				
Undefined	111				
5	TIP ENGR Frame Enabled; 1=ENAB, 0=DISABLE	0/1			
6-7	MIU ID:				
	MIU1	00			
	MIU 2	01			
	Single MIU	11			
7	0-7	MIU Minor Cycle (Integer)	Hex	TIME	

MIU Normal Mode telemetry is included in AIP bytes 48-97. Science Data is organized by minor frame as depicted in Table 4.1.4.4-4.

Table 4.1.4.4-3. AIP Normal Mode Telemetry Data.		
MIU Minor Cycle	Data Description	Notes
0	1553B Bus Data / MHS CCSDS Data (PKT 2)	1,3
1-25	25 words MHS CCSDS Data (PKT 2)	1
26	Last 17 words MHS CCSDS Data / 1553B Data	1, 2
27	1553B Bus Data / MHS CCSDS Data (PKT 0)	1, 2,3
28-52	25 words MHS CCSDS Data (PKT 0)	1
53	Last 17 words MHS CCSDS Data / 1553B Data	1, 2
54	1553B Bus Data / MHS CCSDS Data (PKT 1)	1,3
55-79	25 words MHS CCSDS Data (PKT 1)	1
Notes:		
1. CCSDS is the Consultative Committee for Space Data Systems		
2. 1553B is the military standard for a multiplexed data bus.		
3. OBT is On-Board Time, a six-byte time tag associated with each MHS SCI PKT and composed of a 4-byte coarse time (resolution: seconds) and a 2-byte fine time (resolution: 2 ⁻¹⁶ seconds).		

Table 4.1.4.4-4 contains the MIU AIP data for bytes 48-97 (the normal telemetry mode).

Table 4.1.4.4-4 MIU AIP Bytes 48-97 (Normal Telemetry Mode).						
MIU Minor Cycle	Bytes	Bits	Description	State	MIU Sub-system	Note
0	48-49	0	NIL BUS Trans Enable, 0=Disable	0/1	1553 Bus BCRT	
		1	MISC BUS Trans Enable, 0=Disable	0/1		
		2	HK BUS Trans Enable, 0=Disable	0/1		
		3	SCI BUS Trans Enable, 0=Disable	0/1		
		4	CMD BUS Trans Enable, 0=Disable	0/1		
		5-15	RESERVED			
	50-51	0-15	HK BUS Fail Periods Count	Hex		
	52-53	0-15	HK BUS Error Table Index	Hex		
	54-55	0-15	SCI BUS Fail Periods Count	Hex		
	56-57	0-15	SCI BUS Error Table Index	Hex		
	58-59	0-15	BUS SKIPPED CMD Count	Hex		
	60-61	0-15	BUS CMD Error Table Index	Hex		
	62-63	0-15	MISC BUS Fail Periods Count	Hex		
	64-65	0-15	MISC BUS Error Table Index	Hex		
	66	0-7	WRAP TEST Failure Count	Hex		
	67	0-7	BIT TEST Failure Count	Hex		
	68-69	0-14	RESERVED			
		15	WRAP TEST Pattern Mod Enable, 0=Disable	0/1		
	70-71	0-15	BIT Timeouts Count	Hex		
	72-73	0-15	BIT Timeouts Count	Hex		
	74-75	0-15	BUS RESET Timeouts Count	Hex		
	76-77	0-14	RESERVED			
		15	BUS Overrun Occurred, 0=no; 1=yes	0/1		
	78-79	0-15	Last Cmd During Bus Overrun	Hex		
	80-81	0-12	RESERVED			
		13	LAST BUS USED, Bus A=1; B=0	0/1		
		14	GROUND PREFERRED BUS, Bus A=1; B=0	0/1		
		15	MIU PREFERRED BUS, Bus A=1; B=0	0/1		
	82-83	0-15	BIT ITERATIONS	Hex		
	84-85	0-15	HK BUS REQUEST RETRY LIMIT	Hex		
	86-87	0-15	HK TVW RETRY LIMIT	Hex		
88-89	0-15	HK RES RETRY LIMIT	Hex			
90-95	0-47	CCSDS TIME TAG SCI PKT 2, LSB= 2^{-16}	Hex	MHS	1	

	96-97	0-15	FIRST WORD OF SCI PKT 2			1
1-25	48-97		NEXT 25 WORDS OF SCI PKT 2			1
26	48-81		LAST 17 WORDS of SCI PKT 2			1
	82-83	0	NIL BUS TRNS ENABLED, 0=Disable	0/1	Second iteration 1553 Bus BCRT	
		1	MISC BUS TRNS ENABLED, 0=Disable	0/1		
		2	HK BUS TRNS ENABLED, 0=Disable	0/1		
		3	SCI BUS TRNS ENABLED, 0=Disable	0/1		
		4	CMD BUS TRNS ENABLED, 0=Disable	0/1		
		5-15	RESERVED			
	84-85	0-15	HK BUS FAILED PERIODS COUNT	Hex		
	86-87	0-15	HK BUS ERROR TABLE INDEX	Hex		
	88-89	0-15	SCI BUS FAILED PERIODS COUNT	Hex		
	90-91	0-15	SCI BUS ERROR TABLE INDEX	Hex		
	92-93	0-15	BUS SKIPPED COMMAND COUNT	Hex		
	94-95	0-15	BUS CMND ERROR TABLE INDEX	Hex		
	96-97	0-15	MISC BUS FAIL PERIODS COUNT	Hex		
	27	48-49	0-15	MISC BUS ERROR TABLE INDEX		Hex
50		0-7	WRAP TEST FAILURE COUNT	Hex		
51		0-7	BIT TEST FAILURE COUNT	Hex		
52-53		0-14	RESERVED			
		15	WRAP TEST PATTERN MOD ENABLED, 0=Disable	0/1		
54-55		0-15	BIT TIMEOUTS CONT	Hex		
56-57		0-15	BIT RESULTS	Hex		
58-59		0-15	BUS RESET TIMEOUTS CONT	Hex		
60-61		0-14	RESERVED			
		15	BUS OVERRUN OCCURRED, 0=no; 1=yes	0/1		
62-63		0-15	LAST COMMAND During BUS Overrun	Hex		
64-65		0-12	RESERVED			
		13	LAST BUS USED, Bus A=1; B=0	0/1		
		14	GROUND PREFERRED BUS, Bus A=1; B=0	0/1		
		15	MIU PREFERRED BUS, Bus A=1; B=0	0/1		
66-67	0-15	RESET ITERATIONS	Hex			
68-69	0-15	SCI BUS REQUEST RETRY LIMIT	Hex			
70-71	0-15	SCI TVW RETRY LIMIT	Hex			
72-73	0-15	SCI RES RETRY LIMIT	Hex			
74-79	0-47	CCSDS TIMETAG SCI PKT 0, LSB= - 16	Hex	MHS		

	80-97		FIRST 9 WORDS OF SCI PKT 0			
28-52	48-97		NEXT 25 WORDS OF SCI PKT 0			
53	48-65		LAST 9 WORDS OF SCI PKT 0			
	66-67	0	NIL BUS TRNS ENABLED, 0=Disable	0/1	Third iteration 1553 Bus BCRT	
		1	MISC BUS TRNS ENABLED, 0=Disable	0/1		
		2	HK BUS TRNS ENABLED, 0=Disable	0/1		
		3	SCI BUS TRNS ENABLED, 0=Disable	0/1		
		4	CMD BUS TRNS ENABLED, 0=Disable	0/1		
		5-15	RESERVED			
	68-69	0-15	HK BUS Failed Periods Count	Hex		
	70-71	0-15	HK BUS Error Table Index	Hex		
	72-73	0-15	SCI BUS Failed Periods Count	Hex		
	74-75	0-15	SCI BUS Error Table Index	Hex		
	76-77	0-15	BUS Skipped Command Count	Hex		
	78-79	0-15	BUS CMD Error Table Index	Hex		
	80-81	0-15	MISC BUS Failed Periods Count	Hex		
	82-83	0-15	MISC BUS Error Table Index	Hex		
	84	0-7	WRAP TEST Failure Count	Hex		
	85	0-7	BIT TEST FAILURE COUNT	Hex		
	86-87	0-14	RESERVED			
		15	WRAP TEST Pattern Mod Enabled, 0=Disable	0/1		
	88-89	0-15	BIT TIMEOUTS COUNT	Hex		
	90-91	0-15	BIT RESULTS	Hex		
	92-93	0-15	BUS RESET Timeouts Count	Hex		
	94-95	0-14	RESERVED			
15		BUS OVERRUN OCCURRED, 0=no; 1=yes	0/1			
96-97	0-15	LAST CMD During BUS Overrun	Hex			
54	48-49	0-12	RESERVED			
		13	LAST BUS USED, Bus A=1; B=0	0/1		
		14	GROUND PREFERRED BUS, Bus A=1; B=0	0/1		
		15	MIU PREFERRED BUS, Bus A=1; B=0	0/1		
	50-51	0-15	BCRTM Last INTR LOG List PNTR	Hex		
	52-53	0-15	CMD RETRY LIMIT	Hex		
	54-55	0-15	MISC RETRY LIMIT	Hex		
	56-61	0-47	CCSDS TIMETAG SCI PKT 1, SB=2- 16	Hex	MHS	
62-97		FIRST 18 WORDS OF SCI PKT 1				
55-79	48-97		NEXT 25 WORDS OF SCI PKT 1			

Note:

1. Packet 2 (PKT 2) reports the prior 8-second period (n-1).

Some of the terms used in the above table are explained here. There are five transaction types: NIL, MISC (Miscellaneous), HK (Housekeeping), SCI (Science) and CMD (Command). The NIL cycle is described as a placeholder (No Operation) mode. Its purpose is to kill time until time to perform another operation. MISC cycle outputs test results from WRAP and BIT for the housekeeping and Science RT channels. Housekeeping Cycle sends failed and re-try counters on Housekeeping issues from bytes 48-73. Science Cycle sends various failed and re-try counters on SCI issues from bytes 48-73. Command Cycle sends various failed and re-try counters on CMD issues from bytes 48-73.

Table 4.1.4.4-5 depicts the data sent in bytes 98-101 during AIP Normal Telemetry mode. This data repeats four times per major frame beginning with major and minor cycle counts in minor frames 0, 20, 40 and 60. Telemetry data I/O Reads are sent in bytes 98-99 during minor frames 2, 22, 42 and 62. Some of the key telemetry data from these AIP bytes 98-101 include TIP and AIP First In First Out (FIFO) status, Bus Controller state, CIU State, Uplink queue, CMD VERIF word, Error counts, Memory dump stats, Time and Error Log Indices.

MIU Minor Cycle				Byte	Bits	Description	State
0	20	40	60	98-101	0-31	Major Cycle Count: MSW LSW	Hex Hex
1	21	41	61	98-99	0-15	Minor Cycle Error Count	Hex
				100-101	0-14	RESERVED	
					15	MIU in Sync with Major Cycle: 1=yes, 0=no	0/1
2	22	42	62	98-99	0-15	Results of I/O Read	
				100	0	TIP FIFO was reset; 1=yes, 0=no	0/1
					1	TIP FIFO was full; 1=yes, 0=no	0/1
					2	TIP FIFO was empty; 1=yes, 0=no	0/1
					3	AIP FIFO was reset; 1=yes, 0=no	0/1
					4	AIP FIFO was full; 1=yes, 0=no	0/1
					5	AIP FIFO was empty; 1=yes, 0=no	0/1
					6	Minor Cycle Sync Received; 1=yes, 0=no	0/1
				7	Major Cycle Sync Received; 1=yes, 0=no	0/1	
				101	0	FIFO Reset Under S/W Control; 1=yes, 0=no	0/1
1	Reset AIP FIFO Commanded; 1=yes, 0=no	0/1					
2	Reset TIP FIFO Commanded; 1=yes, 0=no	0/1					

					3	TIP FIFO Data inverted; 1=yes, 0=no	0/1				
					4	AIP FIFO Data inverted; 1=yes, 0=no	0/1				
					5	TIP FIFO Enabled; 1=yes, 0=no	0/1				
					6	AIP FIFO Enabled; 1=yes, 0=no	0/1				
					7	INT Reset Under S/W Control; 1=yes, 0=no	0/1				
3	23	43	63	98-99	0-13	Reserved					
					14-	BUS Controller State: Off Enabling On Disabling	00 01 10 11				
				100-101	0-13	Reserved					
					14-	Bus Controller MODE: TLM HK Dump SCI Dump Undefined	00 01 10 11				
				4	24	44	64	98-99	0-14	Reserved	
									15	Housekeeping Bus Process: 0=TLM; 1=Dump	0/1
100-101	0-14	Reserved									
	15	Science Bus Processing Mode: 0=TLM; 1=DUMP	0/1								
5	25	45	65	98-99	0-15	BC Unexplained Exceptions CNT	Hex				
				100-101	0-15	MHS CMD Queue Count	Hex				
6	26	46	66	98	0-1	CIU ISR STATE: Waiting for next CMD Collecting CMD hdr Collecting CMD hdr Collecting datawords	00 01 10 11				
					2	Uplink Queue is full; 0=no, 1=yes	0/1				
					3	Uplink Queue was reset; 0=no, 1=yes	0/1				
					4-7	Reserved					
				99	0-7	Number of data words transferred (8 bits)	Hex				
				100-101	0-15	CMD Verification Word	Hex				
				7	27	47	67	98-99	0-15	Exception Occurred Count	Hex
100-101	0-15	Unhandled Interrupt Count	Hex								
8	28	48	68	98-99	0-14	Reserved					
					15	Memory Scrub Enabled; 0=no, 1=yes	0/1				
				100-101	0-15	Single Bit Error Count	Hex				
9	29	49	69	98-101	0-31	Last Ram Address Scrubbed: MSW LSW	Hex Hex				

10	30	50	70	98-99	0-15	Machine Error Count	Hex
				100-101	0-14	Reserved	
					15	Stuck Bit Detected; 0=yes, 1=no	0/1
11	31	41	71		0-31	Address of Stuck Bit: MSW LSW	Hex Hex
12	32	52	72	98-99	0-14	Reserved	
					15	Memory Checksum Enabled; 0=yes, 1=no	0/1
				100-101	0-15	Memory Checksum Error Count	Hex
13	33	53	73	98-101	0-31	Ram Dump Start Address: MSW LSW	Hex Hex
14	34	54	74	98-101	0-31	HK Bus Memory Dump Start Address: MSW LSW	Hex Hex
15	35	55	75	98-101	0-31	SCI Bus Memory Dump Start Address: MSW LSW	Hex Hex
16	36	56	76	98-101	0-31	Ram Dump Requested Word Count: MSW LSW	Hex Hex
17	37	57	77	98-99	0-15	HK Dump Requested Word Count	Hex
				100-101	0-15	SCI Dump Requested Word Count	Hex
18	38	58	78	98-99	0-15	Main Cycle Count	Hex
				100-101	0-15	Minor Frame Reception Tolerance	Hex
19	39	59	79	98-99	0-15	Exception Log Save Index	Hex
				100-101	0-15	Interrupt Log Save Index	Hex

TIROS Information Processor (TIP) telemetry from the MIU is supplied as 8-bits in Byte 102 of each TIP minor frame (this corresponds to AIP minor frame byte 205). The content of an MHS telemetry packet is essentially a subset of the science data packet. It contains telemetry data, except not as much as is found in a science data packet, but no science data (i.e., no views of earth and the warm and cold targets). The format of the MIU TIP Telemetry Frame (normal) is given in Table 4.1.4.4-6.

TIP Minor Frame Count	Bits	Description/Definition	State	MIU Subsystem	Notes
1	0-1	Reserved			
	2-4	Telemetry Mode: Normal Fast Dump	000 001	TLM	

		Slow Dump Very Slow Dump Bus Engr Mode Undefined Undefined Undefined	010 011 100 101 110 111		
	5	TIP Engineering Frame Enabled; 0=Disabled	0/1		2
	6-7	MIU ID: MIU 1 MIU 2 Single MIU	00 01 11	MIU H/W	
2	0-7	MIU Minor Cycle Number (Integer)	Hex	Time	
3-4	0-15	Command Verification Word (Refer to CV Word Definition)	Hex	CMD	
5-6	0-13	Reserved			
	14-15	BUS Controller Mode: TLM HK Dump SCI Dump Undefined	00 01 10 11	BUS Control	
7-10	0-31	Scan Period 2 Coarse Time; LSB=1 second	Sec	MHS HK	1
11-12	0-15	Scan Period 2 Fine Time; LSB=216 seconds	Sec		1
13-28	0-127	Scan Period 2 Housekeeping Packet, 16 bytes HK/packet			1
29-30	0-15	Command Verification Word	Hex	CMD	
31-32	0-15	HK Failed Collection Count (Integer)	Hex	BUS	
33-36	0-31	Scan Period 0 Whole Time, LSB=1 sec	Sec	MHS HK	
37-38	0-15	Scan Period 0 Fractional Time; LSB- 216 seconds	Sec		
39-54	0-127	Scan Period 0 Housekeeping Packet; 16 bytes HK/packet			
55-56	0-15	Command Verification Word	Hex	CMD	
57-58	0-15	HK Valid Packets Count	Hex	BUS	
59-62	0-31	Scan Period 2 Whole Time; LSB=1 second	Sec	MHS HK	
63-64	0-15	Scan Period 1 Fractional Time; LSB- 216 seconds	Sec		
65-79, 0	0-128	Scan Period 1 Housekeeping Packet; 16 bytes HK/packet			

Notes:

1. Scan Period 2 is reporting prior 8-second frame (n-1).
2. When TIP ENGR Frame is enabled, disregard MIU 1 indications of Normal in this mode.

Table 4.1.4.4-7 lists the telemetry packet types that are generated on the Science Data Bus:

Table 4.1.4.4-7. Science Data Bus telemetry packet types.	
Packet Type	Total Packet Length (octets)
Science Data Packet	1300
Extended Memory Data Packet (EMDP)	1042
Extended Test Data Packet (ETDP)	1300

The Packets are in Consultative Committee for Space Data Systems (CCSDS) format (i.e., a primary header, secondary header and checksum). The detailed structure of the Source Data field is given in the following sections.

Table 4.1.4.4-8 shows the fields that the Science Data Packets contain.

Table 4.1.4.4-8. Science Data Packet Fields.	
Field Name	Size (Octets)
Full Housekeeping Data	39
Status Word	1
Signal Processing Status	9
Pixel Data	1176
OBCT Temperature Data	16
Spares	45

The format of the Full Housekeeping Data field is described at the end of this section. In modes which do not generate Science Data (i.e. all modes except Scan Mode and Fixed View Mode), an Empty Science Data Packet is generated, in which the remaining fields of the Science Data Packet are undefined.

The format of the spares field is unallocated at present. All octets will be set to "00". Table 4.1.4.4-9 shows the format of the Status Word.

Table 4.1.4.4-9. Format of the Status Word Field.							
MSB							LSB
DC Offset Valid	Scan Control Valid	Profile		Unused			

The DC Offset Valid bit is set to a 1" when all channels calibration targets readings lie within acceptable limits, as determined by the DC Offset Algorithm. This bit will be set only in Scan Mode when the calibration targets are sampled.

The Scan Control Valid bit is set to a 1" if all mid-pixel positions of the reflector during Earth, Space and On-Board Calibration Target (OBCT) views are within the limits for the Scan Mode

profile, or within the limits of the requested position in Fixed View Mode. This bit will be set only in Scan Mode or Fixed View Mode.

The Profile code is set to:

00 : Profile 0

01 : Profile 1

10 : Profile 2

11 : No Profile calculated (profile will be manually loaded/modified)

It is intended that Profile 0 will define the Nominal Scan Mode Profile with nominal Space View position. Profiles 1 and 2 will nominally be used for the alternate Space view positions. However, any profile can be reprogrammed to another position versus time profile by reloading the Scan Control Table profile parameters.

The format of the Signal Processing Status field is shown in Table 4.1.4.4-10.

Table 4.1.4.4-10. Format of Signal Processing Status Field.					
MSB					LSB
Channel H1 DC Offset Word					
Channel H2 DC Offset Word					
Channel H3 DC Offset Word					
Channel H4 DC Offset Word					
Channel H5 DC Offset Word					
H1 VALID	H2 VALID	H3 VALID	H4 VALID	H5 VALID	SPE MUX CODE
H1 GAIN			H2 GAIN		UNUSED
H3 GAIN			H4 GAIN		UNUSED
H5 GAIN			UNUSED		UNUSED

The Valid bit is set to a "1" when all samples of this channel for this scan revolution lie within the ADC dynamic range. H1..H5 are the five input channels from the Receiver. The Electronics Equipment (EE) has six signal processing channels, SPE1..SPE6. In the nominal configuration, the Receiver channel is connected to the corresponding EE channel, e.g., H1 to SPE1, and SPE6 is unused.

The SPE Mux Code is used to identify which Receiver channel, if any, is connected to the EE redundant channel, as shown in Table 4.1.4.4-11.

Table 4.1.4.4-11. SPE MUX Code Subfield format.	
SPE MUX Code	Configuration
000	H1 to SPE 6
001	H2 to SPE 6
010	H3 to SPE 6
011	SPE 6 not used
100	H4 to SPE 6
101	H5 to SPE6

110	SPE6 not used
111	SPE6 not used

The H1...H5 Gain Fields identify the gain settings of the Receiver video output channels as in Table 4.1.4.4-12.

Table 4.1.4.4-12. Receiver Gains Sub Field.	
Gain Code	Gain
000	0 dB
001	1 dB
010	2 dB
011	3 dB
1xx	not used

The Science Data field can be separated into Earth, Space and OBCT View Data fields, which all follow a common format. They are differentiated only by the source of the data that is written to them. The fields are arranged as shown in Table 4.1.4.4-13.

Table 4.1.4.4-13. Science Data Field Format.	
Field name	Number of Pixel subfields
Earth	90
Space	4
OBCT	4

In Fixed View Mode, the Science Data Packet is the same format as Scan Mode, but the concept of Earth, Space and OBCT pixels does not apply. All 98 pixels are for the fixed view position. The (90 + 4 + 4) pixels are however collected with the same timing as though Scan Mode were performed.

Each of the Pixel sub-fields contain a position and five pixel values. The format of a Pixel Subfield is shown in Table 4.1.4.4-14.

Table 4.1.4.4-14. Pixel Subfield Format.							
MSB							LSB
Mid-pixel Position MS Byte							
Mid-pixel Position LS Byte							
Channel H1 Data MS Byte							
Channel H1 Data LS Byte							
Channel H2 Data MS Byte							
Channel H2 Data LS Byte							
Channel H3 Data MS Byte							
Channel H3 Data LS Byte							
Channel H4 Data MS Byte							
Channel H4 Data LS Byte							

Channel H5 Data MS Byte
Channel H5 Data LS Byte

The Mid-pixel position data is the angular position of the Reflector at the mid-point of the pixel integration period defined by.

The OBCT Temperature Data field contains the On-Board Calibration Target high precision temperature parameters. The format of this block is given in Table 4.1.4.4-15.

Table 4.1.4.4-15. OBCT Subfield Format.							
MSB							LSB
Unused				On-Board Target Temperature 1			
On-Board Target Temperature 1 (PRT1)							
Unused				On-Board Target Temperature 2			
On-Board Target Temperature 2 (PRT 2)							
Unused				On-Board Target Temperature 3			
On-Board Target Temperature 3 (PRT 3)							
Unused				On-Board Target Temperature 4			
On-Board Target Temperature 4 (PRT 4)							
Unused				On-Board Target Temperature 5			
On-Board Target Temperature 5 (PRT 5)							
Unused				Calibration Channel 1			
Calibration Channel 1 (PRT CAL 1: 118 Ω)							
Unused				Calibration Channel 2			
Calibration Channel 2 (PRT CAL 2: 95.3 Ω)							
Unused				Calibration Channel 3			
Calibration Channel 3 (PRT CAL 3: 80.6 Ω)							

The full Housekeeping Telemetry Data blocks contain the following fields as shown in Table 4.1.4.4-16.

Table 4.1.4.4-16. Full Housekeeping Telemetry Data Block.	
Field Name	Size (Octets)
Mode and Subcommutation Code	1
Telecommand Acknowledgement and Fault Code	5
Switch Status	3
Temperature Data	24
Raw Current Consumption Data	6

The Sub-Commutation code is not significant for the Science Data packet as all telemetry is returned.

As with other packets, the Mode Code identifies the packet as either a Science Data Packet (Scan and Fixed View Modes), an Extended Test Packet (self-test mode), an Extended Memory Data

Packet (Mode Code = "1111") or an Empty Science Data Packet (all other Modes). Note that the Telecommand Acknowledgement field of Science Data packets provides acknowledgement of commands received on the Science Data Bus. (Commands on the Command/telemetry Bus are acknowledged in HK Telemetry Packets.)

The Temperature Data Field of each packet will contain all twenty-four thermistor telemetry channel parameters, instead of the multiplexed four of the Housekeeping telemetry packet. The OBCT temperatures are not contained here, as all such values are allocated a separate field in the Science Data Bus.

The Raw Current Consumption Data Field is the internal PSU Current analog telemetry as defined in Table 4.1.4.4-17.

Table 4.1.4.4-17. Raw Current Consumption Data Field Format.							
MSB							LSB
+5V Secondary Current							
+8V Receiver Current							
+15V Receiver Current							
-15V Receiver Current							
RDM Motor Current							
FDM Motor Current							

4.1.5 AIP MINOR FRAME FORMATS

The spacecraft's AMSU Instrument Processor (AIP) collects digital data from the AMSU-A and AMSU-B sensors. This data consists of earth view pixel data, housekeeping data and space and blackbody view data.

4.1.5.1 AIP Minor Frame Format for NOAA KLM

Figure 4.1.5.1-1 shows the AIP telemetry word location in the frame format, and Table 4.1.5.1-1 contains AIP telemetry word titles, locations within the frame, and word descriptions in tabular form.

Figure 4.1.5.1-1. AIP Output Format for NOAA KLM.							
0	1	3	4	5	6	7	8
2		///	MFC	1)	///		20
22-bit sync							-----AMSU-A1 (Words 8 through 33)----- ----->
21			34			40	
33			-----AMSU-A2 (Words 34 through 47)---->				
<-----AMSU-A1-----							
41			48				

47 -----AMSU-A2----- -----					60 -----AMSU-B (Words 48 through 97)----- ----->											
61 80 -----AMSU-B----- ----->																
81 97 -----AMSU-B----- ----->													98 ///		100	
101 ///	102 2)	103 105 20-bit sync SC ID		106 1), 3)	107 3), 4)	108 4)	109 110 CMMD VER		111 5)	112 114 Anal og subc om 32/1 6/1 seco nds	115 5)	116 6)	117 DA U-1	118 DA U-2	119 HIR S/3	120 HIR S/3
121 122 DCS-2		12 3 12 4 S E M	125 126 HIRS/3		127 128 DCS-2		129 130 HIRS/3		131 132 DC S-2	133 134 HIR S/3	135 136 DCS-2		137 138 HIRS/3		139 140 SBUV/2	
141 142 HIRS/3		14 3 14 4 D C S- 2	145 146 HIRS/3		147 148 DCS-2		149 -----CPU-A Telemetry----->				154 155 156 DCS-2		157 158 HIRS/3		159 160 DCS-2	
161 162 HIRS/3/		16 3 16 4 D C S- 2	165 166 HIRS/3		167 168 HIRS/3		169 170 HIRS/3		171 172 DC S-2	173 174 HIR S/3	175 176 DCS-2		177 178 HIRS/3		179 180 DCS-2	
181 182 HIRS/3		18 3 18 4 S B U V/ 2	185 186 HIRS/3		187 188 HIRS/3		189 190 DCS-2		191 192 HI RS/ 3	193 194 DCS -2	195 196 HIRS/3		197 198 DCS-2		199 200 ----CPU-B >	

201 204 < Telemetry----- -----	205 ///	206 207 7)	
---	------------	---------------	--

NOTES: /// indicates spare bits and reads 010101, etc.
1) Words 5 and 106: Bit 1-Command Verification Status, Bits 2 & 3- TIP status, Bits 4, 5 & 6- Major Frame Counter
2) Word 102: Bits 1 & 2 spare, followed by 6 bits AMSU parity
3) Words 106 and 107: 9 Bit Dwell address
4) Words 107 and 108: 9 Bit Subcommutation counter
5) Digital-B Subcommutation (32 second)
6) Analog Subcommutation
7) Word 206: 2 bits CPU data status followed by 6 bits TIP parity; word 207: 2 bits spare followed by 6 bits TIP parity calculated by AIP

Table 4.1.5.1-1. AIP Minor Frame Format for NOAA KLM.

Function	No. of Words	Word Position	Bit No. 1 2 3 4 5 6 7 8 Plus Word Code & Meaning
Frame Sync	3	0	1 1 1 1 0 0 1 1 Frame sync is first 22 bits. Last 2 bits of word 2 are: 00
		1	0 1 1 0 1 0 1 1
		2	0 0 0 0 0 0 0 0
Spare	1	3	0 1 0 1 0 1 0 1
Minor Frame Counter	1	4	0 0 0 0 0 0 0 0 Represents minor frame 0
			0 1 0 0 1 1 1 1 Represents minor frame 79
			MSB is first.
Major frame Counter	1	5	First six bits are 000000. Last 2 bits are major (8 sec) frame counter. The major frame counter is incremented every 80 minor frames. Bits 7 and 8 of minor frame 5 will count 8-second intervals, the count overflowing to 0 synchronous with the TIP 32-second major frame pulse.
Spare	2	6	0 1 0 1 0 1 0 1
		7	0 1 0 1 0 1 0 1
AMSU-A1	26	8 thru 33	8 Bit words are formed by the AMSU-A1 experiment and are read out by the AMSU Information Processor at an average rate of 260 words per second.
AMSU-A2	14	34 thru 47	8 Bit words are formed by the AMSU-A2 experiment and are read out by the AMSU Information Processor at an average rate of 140 words per second.
AMSU-B	50	48 thru 97	8 Bit words are formed by the AMSU-B experiment and are read out by the AMSU Information Processor at an average rate of 500 words per second.
Spare	4	98 thru 101	0 1 0 1 0 1 0 1 0 1 0 1 0 1 0 1
AMSU Parity	1	102	Bit 1: 0

			Bit 2: 1
			Bit 3: Even parity check words 2 thru 18
			Bit 4: Even parity check words 19 thru 35
			Bit 5: Even parity check words 36 thru 52
			Bit 6: Even parity check words 53 thru 69
			Bit 7: Even parity check words 70 thru 86
			Bit 8: Even parity check words 87 thru Bit 7 of word 102
TIP Data	104	103 thru 206	Identical to TIP minor frame format in Table 4.3.3.1-1.
TIP Parity	1	207	Bit 1: 0
			Bit 2: 1
			Bit 3: Even parity check words 105 thru 121
			Bit 4: Even parity check words 122 thru 138
			Bit 5: Even parity check words 139 thru 155
			Bit 6: Even parity check words 156 thru 172
			Bit 7: Even parity check words 173 thru 189
			Bit 8: Even parity check words 190 thru Bit 7 of word 206
			This parity word amounts to an AIP recalculation of the TIP parity which was calculated by the TIP in TIP word 103 (AIP word 206).

4.1.5.2 AIP Minor Frame Format for NOAA-N,-N'

Figure 4.1.5.2-1 and Table 4.1.5.2-1 contain AIP telemetry word titles, locations within the frame, and word descriptions in tabular form for NOAA-N,-N'.

0	1	2	3	4	5	6	7	8												23			
22 BIT SYNC				MAJOR FRAME COUNT	SEE NOTE	MIU/MHS STATUS		AMSU-A1 (WORDS 8 THROUGH 33)															
24								33	34											47			
AMSU-A1								AMSU-A2 (WORDS 34 THOUGH 47)															
48																						71	
MHS (WORDS 48 THOUGH 101)																							
72																						95	
MHS (WORDS 48 THOUGH 101)																							
96	97	98 99 100 101			102	103	104	105	106	107	108	109	110	111	112	113	114	115	116	117	118	119	
MHS		MHS Status Words			See Note	See Note	See Note	See Note	See Note	See Note	See Note	Command Verification	DIG B 3.2 SEC	ANA SUB 32 SEC	ANA SUB 16 SEC	ANA SUB 1 SEC	DIG B SUB	ANA SUB 2	DAU 1	DAU 2	HIRS/ 4		
120	121	122	123	124	125	126	127	128	129	130	131	132	133	134	135	136	137	138	139	140	141	142	143
HIRS 4	DCS-2		SEM		HIRS/4		DCS-2		HIRS/4		DCS-2		HIRS/4		DCS-2		HIRS/4		SBUV/2		HIRS/4		DCS 2
144	145	146	147	148	149				154	155	156	157	158	159	160	161	162	163	164	165	166	167	
DCS 2	HIRS/4		DCS-2		CPU A TELEMETRY				DCS-2	HIRS/4		HIRS/4		DCS-2		HIRS/4		DCS-2		HIRS/4		DCS 2	
168	169	170	171	172	173	174	175	176	177	178	179	180	181	182	183	184	185	186	187	188	189	190	191
DCS 2	HIRS/4		DCS-2		HIRS/4		DCS-2		HIRS/4		DCS-2		HIRS/4		SBUV/2		HIRS/4		HIRS/4		DCS-2		HIRS 4
192	193	194	195	196	197	198	199				204	205	206	207									
HIRS 4	DCS-2		HIRS/4		DCS-2		CPU B TELEMETRY				MIU	See Note	See Note										

Notes:

Number in upper line indicates minor frame word number

Frame sync is first 22 bits, the last two bits of word 2 are: 00

/// Word locations are spare and contain code 01010101

First six bits of word 6 are 000000. Last two bits are 8-second frame counter

Words 103 through 206 are identical to a TIP orbital mode minor frame words 0 through 103

Minor frame period= 0.1 sec

Output data rate =16.54 kbps

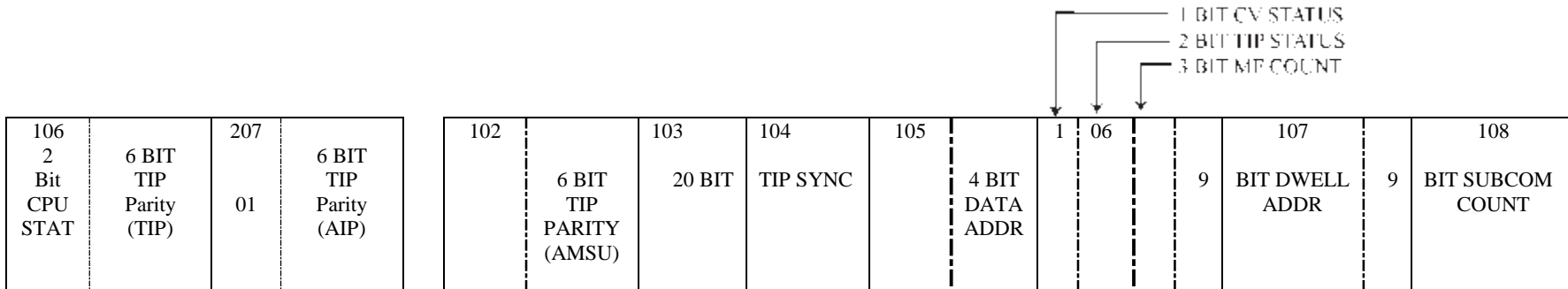

Figure 4.1.5.2-1. AIP Output Format for NOAA-N, N'

Table 4.1.5.2-1. AIP Minor Frame Format for NOAA-N, -N'.

Function	No. of Words	Word Position	Bit No.	Notes
			1 2 3 4 5 6 7 8 plus word code and meaning	
22-bit Frame Sync	3	0-2	22-bit Frame Sync	1
Spare	1	3	0 1 0 1 0 1 0 1	
Minor Frame Counter	1	4	0 0 0 0 0 0 0 0 represents Minor Frame 0; 0 1 0 0 1 1 1 1 represents Minor Frame 79; MSB is first.	2
8 Second Frame Counter	1	5	First six bits are 0 0 0 0 0 0. Last two bits are major (8-sec) frame counter. The major frame counter is incremented every 80 minor frames. Bits 7 and 8 of minor frame 5 will count 8-second intervals, the count overflowing to 0 synchronous with the TIP 32-second major frame pulse.	
MIU/MHS Status	2	6 7	8-bit words formed by the MIU to record status of the MHS and the MIU and read by the AMSU Information Processor at an average rate of 20 words per second.	
AMSU-A1	26	8 thru 33	8-bit words are formed by the AMSU-A1 experiment and are read out by the AMSU Information Processor (AIP) at an average rate of 260 words per second.	
AMSU-A2	14	34 thru 47	8-bit words are formed by the AMSU-A2 experiment and are read out by the AIP at an average rate of 140 words per second.	
MHS	50	48 thru 97	8-bit words are formed by the MHS experiment and are read out by the AIP through the MHS Interface Unit at an average rate of 540 words per second.	
	4	98 thru 101	MIU/MHS Status Words	
6-bit TIP Parity (AMSU)	1	102	Bit 1: 0	
			Bit 2: 1	
			Bits 3-8: 6-bit TIP Parity (AMSU)	
20-bit TIP sync	2-	103	Bits 1-8: 20-bit TIP sync	4
		104	Bits 1-8	
		105	Bits 1-4	
4-bit DATA ADDR	1-	105	Bits 5-8: 4-bit Data Address	4
Status Bits	1-	106	Bit 1: 1-bit CV Status Bits 2-3: 2-bit TIP Status	4

			Bits 4-6: 3-bit MF Count	
9-bit Dwell ADDR	1+	106 107	Bits 7-8: 9-bit Dwell Address Bits 1-7	4
9-bit SUBCOM COUNT	1+	107 108	Bit 8: 9-bit SUBCOM Count Bits 1-8	4
CV	2	109-110	Command Verification	4
DIG B SUBCOM	1	111	Digital B SUBCOM (3.2 sec)	4
ANALOG SUBCOM	1	112	Analog SUBCOM (32 sec)	4
ANALOG SUBCOM	1	113	Analog SUBCOM (16 sec)	4
ANALOG SUBCOM	1	114	Analog SUBCOM (1 sec)	4
DIG B SUBCOM2	1	115	Digital B SUBCOM2 (3.2 sec)	4
ANALOG SUBCOM2	1	116	Analog SUBCOM2 (16 sec)	4
DAU1	1	117	Decryption Authentication Unit 1	4
DAU2	1	118	Decryption Authentication Unit 2	4
HIRS/4	2	119-120	HIRS/4	4
DCS-2	2	121-122	DCS-2	4
SEM	2	123-124	SEM	4
HIRS/4	2	125-126	HIRS/4	4
DCS-2	2	127-128	DCS-2	4
HIRS/4	2	129-130	HIRS/4	4
DCS-2	2	131-132	DCS-2	4
HIRS/4	2	133-134	HIRS/4	4
DCS-2	2	135-136	DCS-2	4
HIRS/4	2	137-138	HIRS/4	4
SBUV/2	2	139-140	SBUV/2	4
HIRS/4	2	141-142	HIRS/4	4
DCS-2	2	143-144	DCS-2	4
HIRS/4	2	145-146	HIRS/4	4
DCS-2	2	147-148	DCS-2	4
CPU A Telemetry	2	149-154	CPU A Telemetry	4
DCS-2	2	155-156	DCS-2	4
HIRS/4	2	157-158	HIRS/4	4
DCS-2	2	159-160	DCS-2	4
HIRS/4	2	161-162	HIRS/4	4
DCS-2	2	163-164	DCS-2	4
HIRS/4	2	165-166	HIRS/4	4
DCS-2	2	167-168	DCS-2	4
HIRS/4	2	169-170	HIRS/4	4

DCS-2	2	171-172	DCS-2	4
HIRS/4	2	173-174	HIRS/4	4
DCS-2	2	175-176	DCS-2	4
HIRS/4	2	177-178	HIRS/4	4
DCS-2	2	179-180	DCS-2	4
HIRS/4	2	181-182	HIRS/4	4
SBUV	2	183-184	SBUV	4
HIRS/4	2	185-186	HIRS/4	4
HIRS/4	2	187-188	HIRS/4	4
DCS-2	2	189-190	DCS-2	4
HIRS/4	2	191-192	HIRS/4	4
DCS-2	2	193-194	DCS-2	4
HIRS/4	2	195-196	HIRS/4	4
DCS-2	2	197-198	DCS-2	4
CPU B TELEMETRY	6	199-204	CPU B Telemetry	4
MIU	1	205	Bits 1-8: MIU	4
2-bit CPU STAT	1-	206	Bits 1-2: 2-bit CPU Status	4
6-bit TIP Parity (TIP)	1-	206	Bits 3-8: 6-bit TIP Parity (TIP)	4
6-bit TIP Parity (AIP)	1	207	Bit 1: 0 Bit 2: 1 Bits 3-8: 6-bit TIP Parity (AIP)	
NOTES:				
1. Frame sync is first 22 bits, last two bits of word 2 are: 0 0.				
2. Minor Frame Period = 0.1 sec				
3. Output Data Rate = 16.64 kbps				
4. Words 103 through 206 are identical to a TIP Orbital Mode Minor Frame's words 0 through 103.				

4.2 APT SYSTEM

4.2.1 GENERAL

The Automatic Picture Transmission (APT) system provides a reduced resolution data stream from the AVHRR/3 instrument. Any two of the AVHRR channels can be chosen by ground command for processing and ultimate output to the APT transmitter. A visible channel is used to provide visible APT imagery during daylight, and one IR channel is used constantly (day and night). A second IR channel can be scheduled to replace the visible channel during the nighttime portion of the orbit. The analog APT signal is transmitted continuously and can be received in real time by relatively unsophisticated, inexpensive ground station equipment (a list of equipment manufacturers is available on the NOAAASIS Internet site. See Internet resources in Appendix E) while the satellite is within radio range. The characteristics of the transmitted signal remain unchanged in the NOAA KLM and NOAA-N,-N' satellite series from those in the TIROS-N series

(NOAA-8 through NOAA-14), while there is a minor change in the data format to account for the modified channel 3 on the AVHRR instrument.

4.2.2 APT TRANSMISSION CHARACTERISTICS

The processed AVHRR instrument data AM modulates a 2400 Hz subcarrier. The maximum subcarrier modulation is defined as the amplitude of the gray scale wedge number 8 (see Figure 4.2.2-1), producing a modulation index of 87% \pm 5% (not exceeding 92%). The AM modulated subcarrier is subsequently used to FM modulate the VTX transmitter operating in the 137 - 138 MHz band. Table 4.2.2-1 summarizes the pertinent APT transmission characteristics.

Table 4.2.2-1. APT Transmission Characteristics.	
Line Rate	120 lines/min
Data Channels	2 transmitted 6 available
Data Resolution	4.0 km
Carrier Modulation	2.4 KHz AM subcarrier on FM carrier
Transmitter Frequency (MHz)	137.50 or 137.62
Transmitter Power (EOL)	5 W (37dBm)
Radiated Power (dBm, @ 63 degrees)	36.7
Polarization	RCP

Figure 4.2.2-1. APT Frame Format.

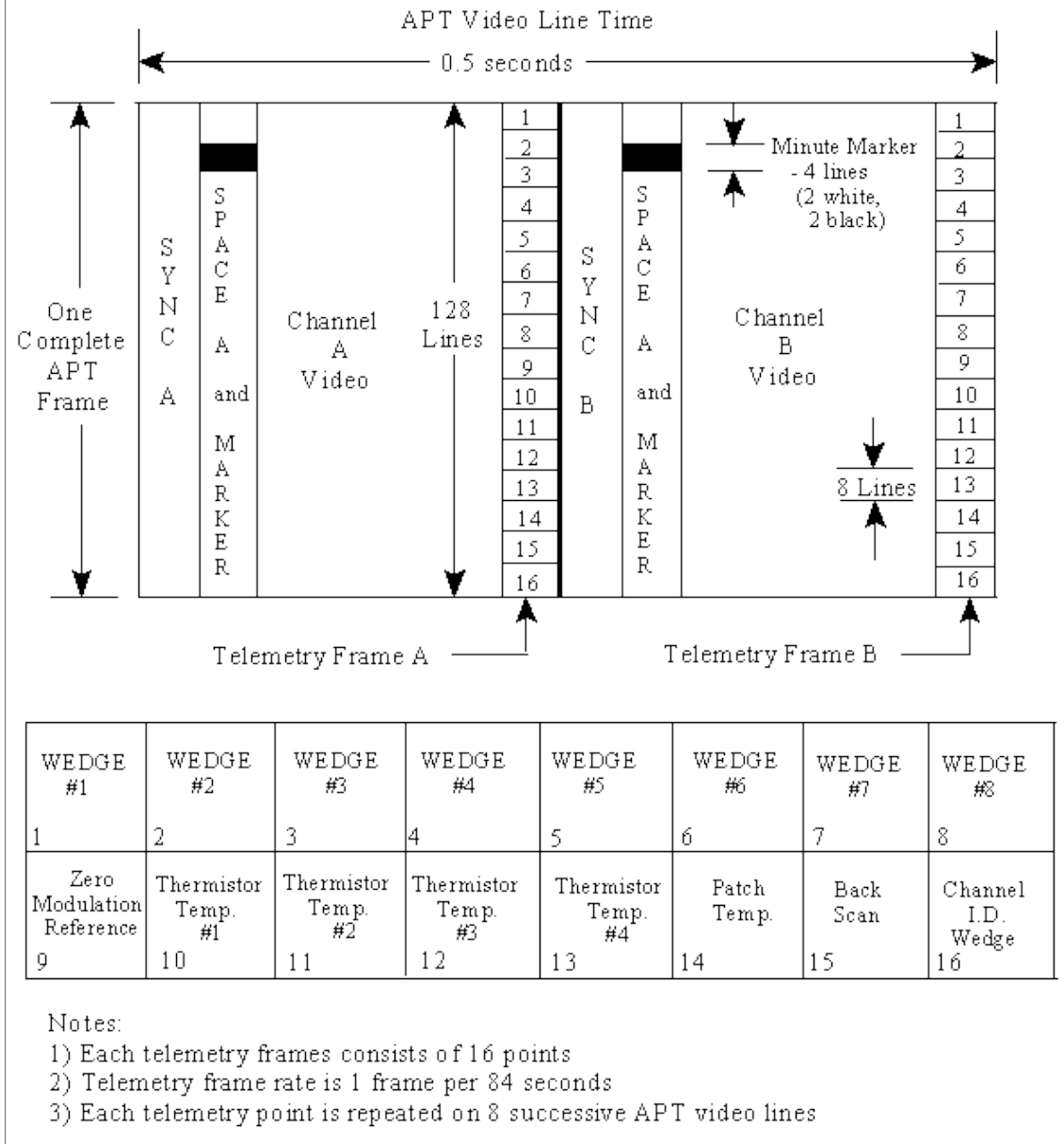

Figure 4.2.2-1. APT Frame Format

4.2.3 APT Data Frame Format

The MIRP processes the AVHRR data and outputs the APT format (simultaneously with the HRPT, LAC and GAC formats). All the processing in the MIRP is done in the digital realm. The digitized AVHRR input consists of 10-bit words. The MIRP inserts calibration and telemetry data for each of the selected APT channels being transmitted, and AM modulates the 2400 Hz subcarrier, corresponding to the light and dark areas seen by the instrument, with the 8 Most Significant Bits (MSB) of the 10-bit data. The formatted data passes through the MIRP digital-to-analog converter, is filtered and modulated onto the 2400 Hz carrier.

On the NOAA KLM and NOAA-N,N' series, two of the six possible AVHRR spectral channels are multiplexed so that channel A APT data is obtained from one spectral channel of the first AVHRR scan line, and channel B from another spectral channel contained in the second AVHRR scan line. The third AVHRR scan line is omitted from the APT, and the process is repeated. It can be seen that the data processing algorithm is designed so that data from every third line from each of the two selected channels of the original high resolution AVHRR output are formatted for each of the two APT channels. The algorithm also maintains nearly equal geometric resolution of 4 km along the scan line. This is accomplished by using a separate resolution reduction in each of five regions or zones either side of the nadir. The details of this algorithm are shown Table 4.2.3-1 and Figure 4.2.3-1. The two AVHRR channels used are identified in the daily TBUS message, and are further classified by the daytime and nighttime portion of the orbit. Channel identification is also included as part of the telemetry frame.

Table 4.2.3-2 enumerates the APT format parameters. Figures 4.2.2-1, 4.2.3-2 and 4.2.3-3 illustrate the APT frame format, the video line format and signal synchronization details. Examining the frame format shown in Figure 4.2.2-1, it can be seen that both channel A and B have a series of 16 “wedges” used in calibrating the APT image. Each of the wedges is composed of 8 successive video lines. Only the wedges of one frame from an entire, received pass, are needed for calibration. Also note that wedges 1 through 14 are identical on the images from both channels A and B. Only wedges 15 (the back scan value when one of the IR radiometers “looks” at a blackbody radiator) and 16 (channel identification) vary between channel A and B.

The channel identification wedge has changed in the NOAA KLM and NOAA-N,-N' series now that there are six possible channels 1, 2, 3A, 3B, 4 and 5. The modulation index of wedge 16 will equal one of the first six grey scale wedges. Wedge 3 will correspond to channel 3A being in use, while wedge 6 will correspond to channel 3B being in use. All other channel numbers will be the same as the number of the corresponding grey scale wedge.

Table 4.2.3-1 APT Linearization Algorithm			
Zone 1 0-16.98 degrees from nadir	Average 4 contiguous samples	628 AVHRR data samples per channel	157 processed APT words output to D/A converter
Zone 2 16.98-34.83 degrees	Average 3 contiguous samples, skip 1,	330 AVHRR data samples per channel	110 processed APT words output to D/A

either side of nadir	repeat		converter
Zone 3 34.83-43.83 degrees either side of nadir	Average 2 contiguous samples	166 AVHRR data samples per channel	83 processed APT words to output D/A converter
Zone 4 43.83-48.84 degrees either side of nadir	Average 1.5 samples (A+B/2 and B+C/2)	93 AVHRR data samples per channel	62 processed APT words output to D/A converter
Zone 5 48.84-55.4 degrees either side of nadir	Retain original resolution	121 AVHRR data samples per channel	121 processed APT words output to D/A converter.

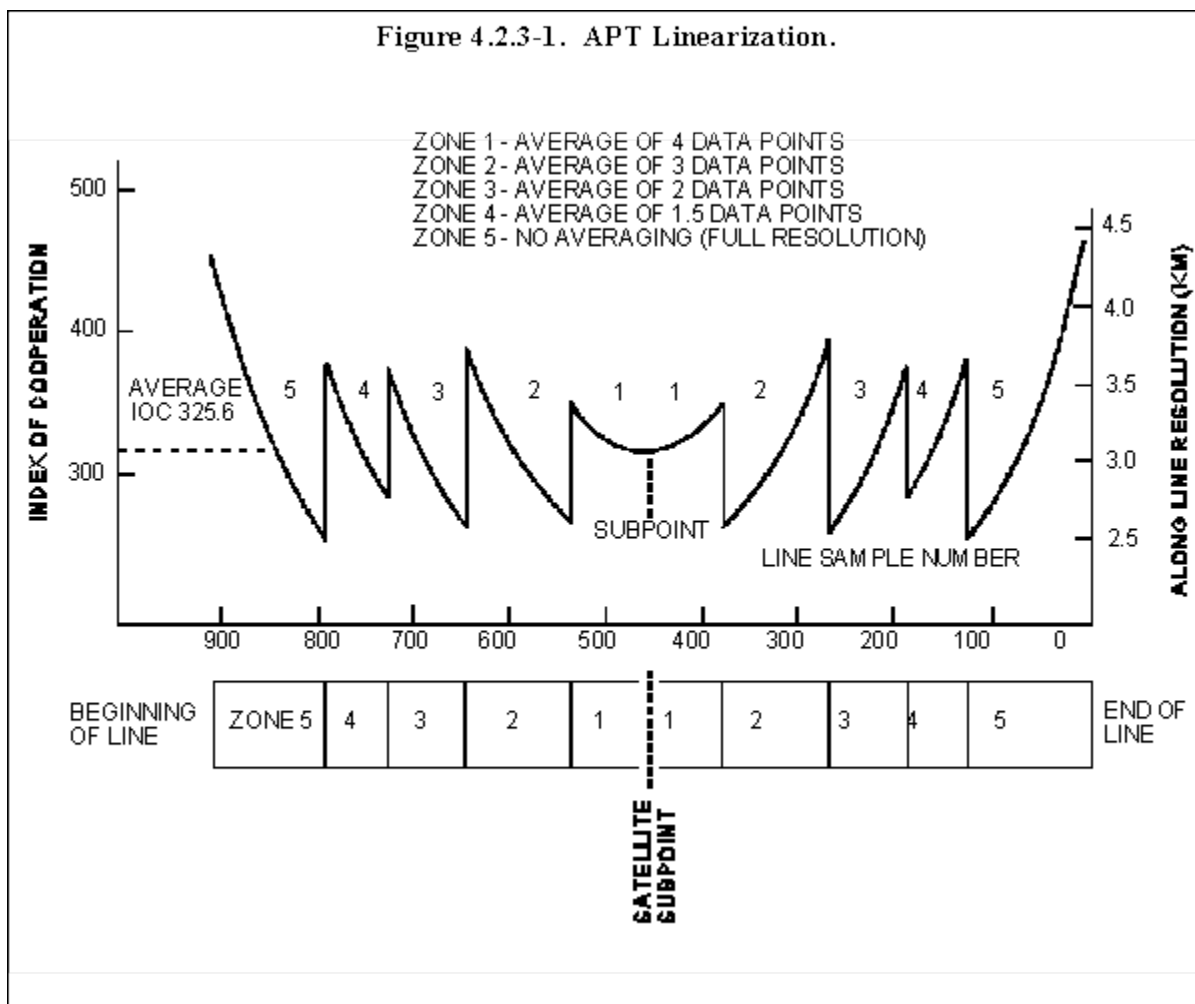

Figure 4.2.3-1. APT Linearization

Table 4.2.3-2. APT Parameters	
Frame	
Rate	1 frame/64 sec
Length	128 lines
Format	See Table 4.2.3-1

Line Parameters	
Rate	2 lines/sec
Number of words	2080
Number of sensor channels	2
Number of words/sensor channel	909
Format	See Figure 4.2.3-1
Line sync format	See Figures 4.2.3-2 and 4.2.3-3
Word Parameters	
Rate	4160 words/sec
D/A conversion accuracy	8 MSB's each 10 bit word

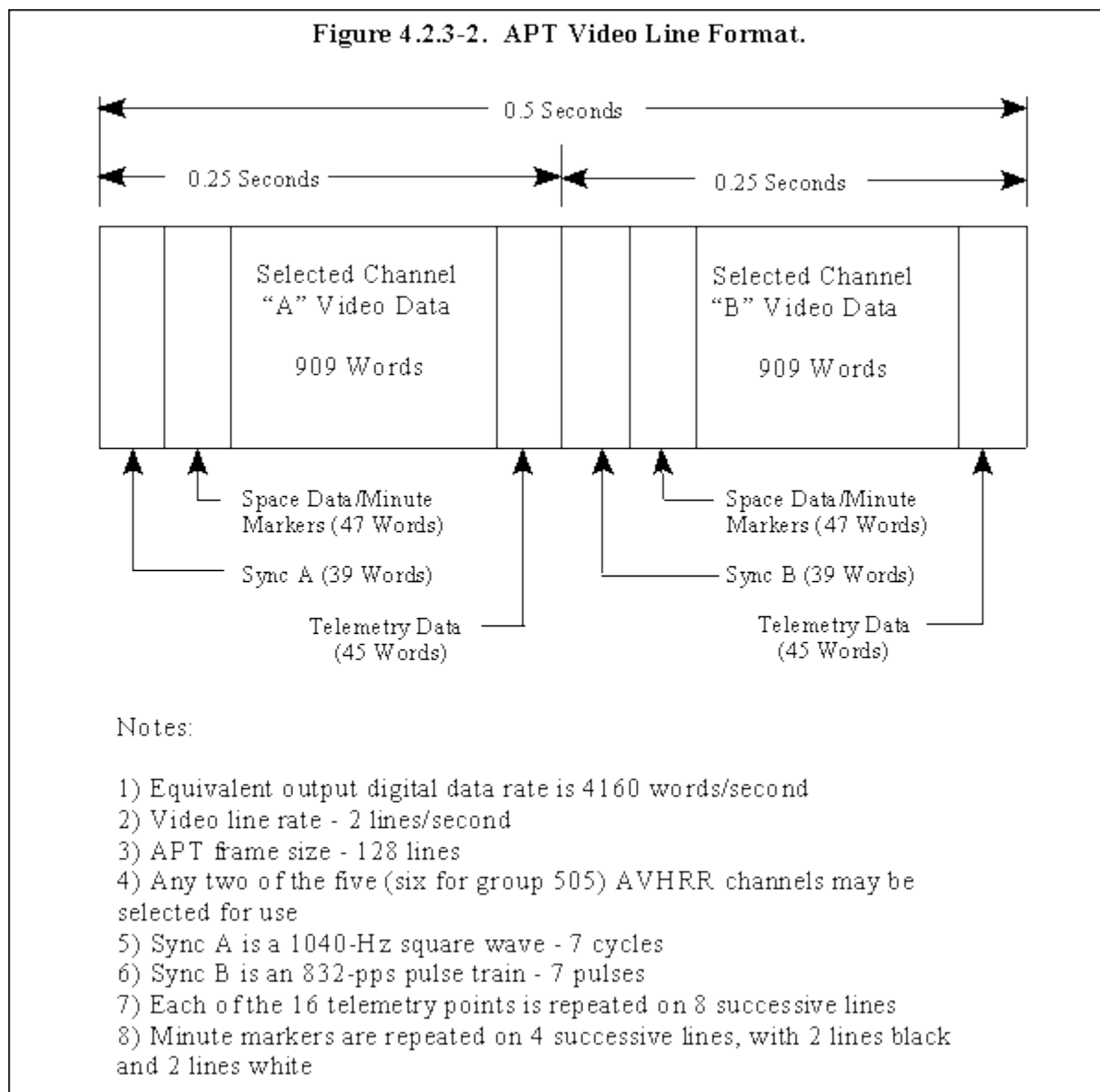

Figure 4.2.3-2. APT Video Line Format

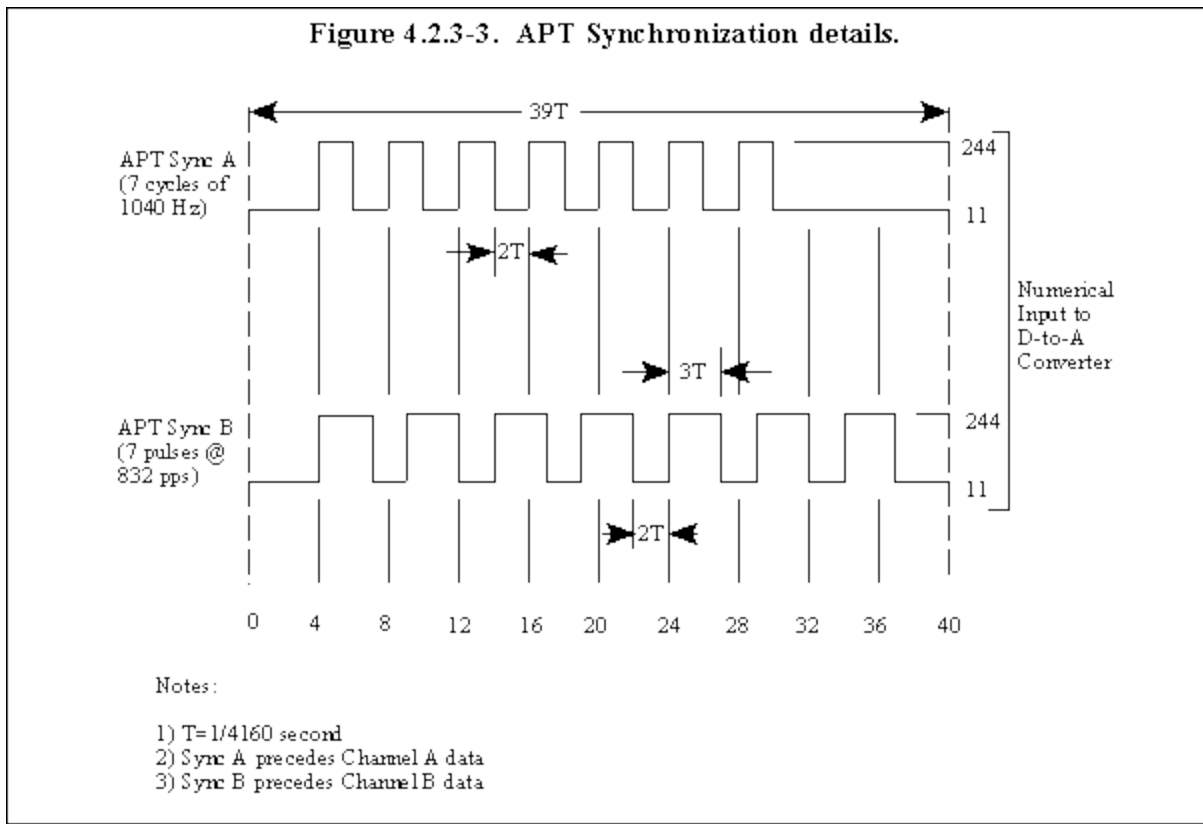

Figure 4.2.3-3. APT Synchronization Details

4.3 DIRECT SOUNDER BROADCAST (DSB)

4.3.1 GENERAL

The Direct Sounder Broadcast (DSB, also referred to as the beacon transmission) contains the low bit rate instrument (HIRS/3, HIRS/4 on NOAA-N, -N', SBUV/2, SEM, and DCS/2, but not AMSU) digital data, identical to that within the HRPT transmission. Data are therefore available in both the VHF and S-band links. Those users receiving the high resolution HRPT transmission would likely find it most desirable to extract the low rate data from this data stream. The VHF beacon transmission is available to users who do not intend to install the more complex equipment necessary to receive high data rate S-band service. The lower data rates permit the user to install less complex, less costly equipment to receive the data without degrading its quality.

4.3.2 DSB Transmission Characteristics

On board the satellite, output from the low data rate instruments is collected and formatted by the TIROS Information Processor (TIP). Parallel outputs are provided for the real-time VHF beacon transmission (DSB) and the MIRP (for the HRPT service). The instrument data is multiplexed with analog and digital housekeeping data. The TIP output directly modulates the beacon transmission. The data is transmitted as an 8.32 Kbps split phase signal (similar to the HRPT

transmission, above) over one of the beacon transmitters (BTX). Detailed transmission characteristics and TIP parameters are shown in Tables 4.3.2-1 and 4.3.2-2.

Table 4.3.2-1 DSB Transmission Characteristics	
Carrier Modulation	Digital split phase, phase modulated
Transmitter Frequency (Mhz)	137.35 or 137.77
Transmitter Power (EOL)	1.0 watts (30dBm)
Radiated Power (dBm)	.5 (over 90% of sphere)
Polarization	RCP

Table 4.3.2-2 TIP Parameters	
Major Frame	
Rate Minor Frames/Major Frame	1 major frame/32 sec 320
Minor Frame	
Rate Number of words Format	10 minor frames/sec 11090 See Table 4.3.2-3
Word Parameters	
Rate Number of bits/word Order	1040 words/sec 8 Bit 1=MSB Bit 8=LSB
Bit Parameters	
Rate Format Data "0" Data "1"	8320 Bits/sec Split phase -67/+67degrees +67/-67degrees

4.3.3 TIP FRAME FORMAT

The TIP format is based on a major frame which contains 320 minor frames.

4.3.3.1 TIP Minor Frame Format for NOAA-KLM

About one-quarter of the 104 telemetry word locations in the TIP minor frame have been changed for NOAA KLM. This is due to the removal of the Stratospheric Sounding Unit (SSU) and Earth Radiation Budget Experiment (ERBE) from the new series of spacecraft. Word locations previously assigned to the SSU have been allocated to the HIRS/3 and Data Collection System (DCS). The ERBE word locations have been reassigned to DCS, as well. In addition, two words have been allocated to the Decryption Authentication Unit (DAU). Table 4.3.3.1-1 shows the TIP telemetry word location in the frame format. Table 4.3.3.1-2 contains telemetry word titles, locations within the frame, and word descriptions in tabular form

Table 4.3.3.1-1. TIP Minor Frame Format for NOAA KLM.												
0 4-BIT ----- 20-BIT SYNCH ---- - S/C 11101101 1110001 0000 ID			3 STATUS, DWELL MODE ADDRESS, MINOR FRAME COUNTER			6 CMD VERIFICATION DATA		8 DIG-B SUBCO M-1	9 ANALO G SUB COM (32 SEC)	10 ANALO G SUB COM (16 SEC)	11 ANALO G SUB COM (1 SEC)	
12 DIG-B SUB COM-2	13 ANALO G SUB COM (16 SEC)	14 DAU-1	15 DAU-2	16 HIRS/3	17 HIRS/3	18 DCS-2	19 DCS-2	20 SEM	21 SEM	22 HIRS/3	23 HIRS/3	
24 DCS-2	25 DCS-2	26 HIRS/3	27 HIRS/3	28 DCS-2	29 DCS-2	30 HIRS/3	31 HIRS/3	32 DCS-2	33 DCS-2	34 HIRS/3	35 HIRS/3	
36 SBUV/2	37 SBUV/2	38 HIRS/3	39 HIRS/3	40 DCS-2	41 DCS-2	42 HIRS/3	43 HIRS/3	44 DCS-2	45 DCS-2	46 CPU-A TELEMETRY 47		
48 ----- CPU-A TELEMETRY -----				51 DCS-2	52 DCS-2	53 HIRS/3	54 HIRS/3	55 DCS-2	56 DCS-2	57 HIRS/3	58 HIRS/3	59 HIRS/3
60 DCS-2	61 DCS-2	62 HIRS/3	63 HIRS/3	64 DCS-2	65 DCS-2	66 HIRS/3	67 HIRS/3	68 DCS-2	69 DCS-2	70 HIRS/3	71 HIRS/3	
72 DCS-2	73 DCS-2	74 HIRS/3	75 HIRS/3	76 DCS-2	77 DCS-2	78 HIRS/3	79 HIRS/3	80 SBUV/2	81 SBUV/2	82 HIRS/3	83 HIRS/3	
84 HIRS/3	85 HIRS/3	86 DCS-2	87 DCS-2	88 HIRS/3	89 HIRS/3	90 DCS-2	91 DCS-2	92 HIRS/3	93 HIRS/3	94 DCS-2	95 DCS-2	
96 101 ----- CPU-B TELEMETRY ----- -----						102 SPARE 0101010 1	103 6- BITS EVEN PARITY	MINOR FRAME PERIOD - 0.1 SEC MAJOR FRAME PERIOD - 32 SEC OUTPUT DATA RATE - 8.320 KBPS				

(NUMBER IN UPPER LEFT CORNER INDICATES MINOR FRAME WORD NUMBER)

Table 4.3.3.1-2. TIP Minor Frame Format for NOAA KLM			
Function	No. of Words	Word Position	Bit No. 1 2 3 4 5 6 7 8 Plus Word Code & Meaning
Frame Sync & SC ID	3	0	11101101 (MSB) is first)
		1	11100010
		2	0000AAAA (Last 4 bits are spacecraft ID)
Status	1-	3	Bit 1: CMD verification (cv) status; 1=cv update word present in frame; 0=no cv update id frame Bits 2&3: TIP status; 00=orbital mode; 10=CPU Memory Dump Mode; 01=Dwell Mode; 11=Boost Mode Bits 4-6: Major Frame Count; 000 Major Frame 0; 111=Major Frame 7; MSB first; Counter incremented every 320 minor frames
Dwell Mode Address	1+		Bits 7&8: 9 bit dwell mode address of analog channel that is being monitored continuously
		3	000000000-Analog channel 0
		4	111111111-Analog channel 511
Minor Frame Counter	1+	4	Bit 8, bits 1-8: 000000000=Minor Frame 0
		5	100111111-Minor frame 319
Command Verification	2	6	Bits 9 thru 24 of each valid received or stored command word are placed in the 16 bit slots of telemetry words 6 and 7 on a one-for-one basis.
		7	
Time Code	5	8,9	9 bits of binary Cay Count, MSB first
		9	Bits 2-5: 0101, Spare Bits
		9,10	27 bits of Binary millisec of Day Count, MSB first
		11	Time code is inserted on word location 8-12 only in minor frame 0 of every major frame. The data inserted is referenced to the beginning of the first bit or the minor frame sync word of minor frame 0 within ∇ millisecond.
		12	
Digital "B" Subcom-1	1	8	A Subcommutation of Discrete Inputs collected to form 8 bit words. 256 Discrete Inputs (32 words) can be accommodated. It takes 32 frames to sample all inputs once (sampling rate=once/3.2 sec). A Major Frame contains 10 complete Digital "B" subcommutated frames.
Analog Subcom (32 sec)	1	9	A subcommutation of up to 191 analog points sampled once every 32 seconds plus 64 analog points sampled twice every 32 seconds (once every 16 seconds). Bit 1 of each word represents 2560 mV, while Bit 8 represents 20 mV.

Analog Subcom (16 sec)	1	10	This subcommutation is controlled by a PROM located in the TIP and contains 160 word locations with 128 analog channels sampled once every 16 seconds.
Analog Subcom (1 sec)	1	11	This subcommutation is controlled by a PROM in the TIP and contains 10 analog channels sampled once every 1 second. Word 0 of this subcom is filled with data from an analog point selected by command. The selected analog point may be one of the 512 analog points available to the TIP. Bit 0 of each word represents 2560 mV while Bit 8 represents 20 mV.
Digital "B" Subcom-2	1	12	The subcommutation of discrete inputs collected to form 8 Bit words. 256 discrete inputs (32 words) can be accommodated. It takes 32 minor frames to sample all inputs once (sampling rate=once/3.2 sec). A Major Frame contains 10 complete Digital "B" subcommutated frames. 64 of these bit locations corresponding to TIP minor frames 24-31 form the XSU Digital "A" data. The XSU generates an 8 word subcom which is read out at the rate of one word per minor frame. The XSU subcom is synchronized with its word 1 in minor frame 24.
Analog Subcom- 2 (16 sec)	1	13	This subcommutation is controlled by a PROM located in the TIP and contains 160 words locations with 128 analog channels sampled once every 16 seconds. The remaining 32 word locations contain data from the Solar Array Telemetry Commutator Unit (SATCU). The SATCU receives inputs from 16 sources on the solar array, commutates them and presents this stream and presents it in the last 32 word locations. The 32 words represent two successive passes through the SATCU subcom.
DAU-1	1	14	8 Bit Housekeeping Telemetry words are formed by the DAU-1 and read out by the telemetry system at an average of 10 words per second.
DAU-2	1	15	8 Bit Housekeeping Telemetry words are formed by the DAU-2 and read out by the telemetry system at an average of 10 words per second.

HIRS/3	36	16,17, 22,23, 26,27, 30,31, 34,35, 38,39, 42,43, 54,55, 58,59, 62,63, 66,67, 70,71, 74,75, 78,79, 82,83, 84,85, 88,89, 92,93	8 Bit words are formed by the HIRS/3 experiment and are read out by the telemetry system at an average rate of 360 words per second.
SEM	2	20,21	8 Bit words are formed by the SEM sensor and ready out by the telemetry system at an average rate of 20 words per second.
DCS-2	32	18,19, 24,25, 28,29, 32,33, 40,41, 44,45, 52,53, 56,57, 60,61, 64,65, 68,69, 72,73, 76,77, 86,87, 90,91, 94,95	8 Bit words are formed by the DCS experiment and are read out by the telemetry system at an average rate of 320 words per second
SBUV/2	4	36,37, 80,81	8 Bit words are formed by the SBUV/2 experiment and read out by the telemetry system at an average rate of 40 words per second.
CPU A Telemetry	6	46,47, 48,49, 50,51	A second block of 16 Bit CPU words is ready out by the telemetry system every minor frame.

CPU B Telemetry	6	96,97, 98,99, 100,101	A second block of 16 Bit CPU words is ready out by the telemetry system every minor frame.
CPU Data Status	1-	103	Bits 1 And 2: 00=All CPU data received 01=All CPU A data received; CPU B data incomplete 10= All CPU B data received; CPU A data incomplete 11=CPU A and CPU B data incomplete
Parity	1-	103	Bit 3: Even parity check in words 2 through 18 Bit 4: Even parity check in words 19 thru 35 Bit 5: Even parity check in words 36 thru 52 Bit 6: Even parity check in words 53 thru 69 Bit 7: Even parity check in words 70 thru 86 Bit 8: Even parity check in words 87 thru bit 7 of word 103

4.3.3.2 TIP Minor Frame Format for NOAA-N, -N'

For NOAA-N, -N', Table 4.3.3.2-1 shows the TIP telemetry word location in the frame format. Table 4.3.3.2-2 shows the TIP telemetry word location in the frame format. Other than HIRS/4 data in place of HIRS/3 data, the only real difference between a NOAA KLM TIP minor frame and a NOAA-N, -N' TIP minor frame is byte 102, which contains MIU data.

Table 4.3.3.2-1. TIP Minor Frame Format for NOAA-N, N'.											
0 4-BIT ----- 20-BIT SYNCH --- - S/C 11101101 1110001 0000 ID			3 STATUS, DWELL MODE ADDRESS, MINOR FRAME COUNTER See Note 2			6 CMD VERIFICATION DATA		8 DIG-B SUBCO M-1	9 ANALO G SUB COM (32 SEC)	10 ANALO G SUB COM (16 SEC)	11 ANALO G SUB COM (1 SEC)
12 DIG-B SUB COM-2	13 ANALO G SUB COM (16 SEC)	14 DAU-1	15 DAU-2	16 HIRS/3	17 HIRS/3	18 DCS-2	19 DCS-2	20 SEM	21 SEM	22 HIRS/4	23 HIRS/4
24 DCS-2	25 DCS-2	26 HIRS/4	27 HIRS/4	28 DCS-2	29 DCS-2	30 HIRS/4	31 HIRS/4	32 DCS-2	33 DCS-2	34 HIRS/4	35 HIRS/4
36 SBUV/2	37 SBUV/2	38 HIRS/4	39 HIRS/4	40 DCS-2	41 DCS-2	42 HIRS/4	43 HIRS/4	44 DCS-2	45 DCS-2	46 CPU-A TELEMETRY	47

48 ----- CPU-A TELEMETRY -----	49	50	51	52 DCS-2	53 DCS-2	54 HIRS/4	55 HIRS/4	56 DCS-2	57 DCS-2	58 HIRS/4	59 HIRS/4
60 DCS-2	61 DCS-2	62 HIRS/4	63 HIRS/4	64 DCS-2	65 DCS-2	66 HIRS/4	67 HIRS/4	68 DCS-2	69 DCS-2	70 HIRS/4	71 HIRS/4
72 DCS-2	73 DCS-2	74 HIRS/4	75 HIRS/4	76 DCS-2	77 DCS-2	78 HIRS/4	79 HIRS/4	80 SBUV/2	81 SBUV/2	82 HIRS/4	83 HIRS/4
84 HIRS/4	85 HIRS/4	86 DCS-2	87 DCS-2	88 HIRS/4	89 HIRS/4	90 DCS-2	91 DCS-2	92 HIRS/4	93 HIRS/4	94 DCS-2	95 DCS-2
96 101 ----- CPU-B TELEMETRY ----- -----	97	98	99	100	102 MIU	103 6- See Note 3	MINOR FRAME PERIOD - 0.1 SEC MAJOR FRAME PERIOD - 32 SEC OUTPUT DATA RATE - 8.320 KBPS				

Notes:

1. NUMBER IN UPPER LEFT CORNER INDICATES MINOR FRAME WORD NUMBER
2. Minor Frames 3,4 and 5 consist of 1-bit command verification status in MSB of Word 3, follow frame counter, followed by 9-bit dwell address and 9-bit subcom counter to fill out minor frames
3. Minor Frame 103 consists of 2-bit CPU status in MSB, followed by 6-bit TIP parity.

Table 4.3.3.2-2. TIP Minor Frame format for NOAA-N, -N'

Function	No. of Words	Word Position	Bit No. 1 2 3 4 5 6 7 8 Plus Word Code & Meaning
Frame Sync & SC ID	3	0	11101101 (MSB) is first)
		1	11100010
		2	0000AAAA (Last 4 bits are spacecraft ID)
Status	1-	3	Bit 1: CMD verification (cv) status; 1=cv update word present in frame; 0=no cv update id frame Bits 2&3: TIP status; 00=orbital mode; 10=CPU Memory Dump Mode; 01=Dwell Mode; 11=Boost Mode Bits 4-6: Major Frame Count; 000 Major Frame 0; 111=Major Frame 7; MSB first; Counter incremented every 320 minor frames
Dwell Mode Address	1+		Bits 7&8: 9 bit dwell mode address of analog channel that is being monitored continuously
		3	000000000-Analog channel 0
		4	111111111-Analog channel 511
Minor Frame Counter	1+	4	Bit 8, bits 1-8: 000000000=Minor Frame 0
		5	100111111-Minor frame 319
Command Verification	2	6	Bits 9 thru 24 of each valid received or stored command word are placed in the 16 bit slots of telemetry words 6 and 7 on a one-for-one basis.
		7	
Time Code	5	8,9	9 bits of binary Cay Count, MSB first
		9	Bits 2-5: 0101, Spare Bits
		9,10	27 bits of Binary millisec of Day Count, MSB first

		11	Time code is inserted on word location 8-12 only in minor frame 0 of every major frame. The data inserted is referenced to the beginning of the first bit or the minor frame sync word of minor frame 0 within \forall millisecond.
		12	
Digital "B" Subcom-1	1	8	A Subcommutation of Discrete Inputs collected to form 8 bit words. 256 Discrete Inputs (32 words) can be accommodated. It takes 32 frames to sample all inputs once (sampling rate=once/3.2 sec). A Major Frame contains 10 complete Digital "B" subcommutated frames.
Analog Subcom (32 sec)	1	9	A subcommutation of up to 191 analog points sampled once every 32 seconds plus 64 analog points sampled twice every 32 seconds (once every 16 seconds). Bit 1 of each word represents 2560 mV, while Bit 8 represents 20 mV.
Analog Subcom (16 sec)	1	10	This subcommutation is controlled by a PROM located in the TIP and contains 160 word locations with 128 analog channels sampled once every 16 seconds.
Analog Subcom (1 sec)	1	11	This subcommutation is controlled by a PROM in the TIP and contains 10 analog channels sampled once every 1 second. Word 0 of this subcom is filled with data from an analog point selected by command. The selected analog point may be one of the 512 analog points available to the TIP. Bit 0 of each word represents 2560 mV while Bit 8 represents 20 mV.
Digital "B" Subcom-2	1	12	<p>The subcommutation of discrete inputs collected to form 8 Bit words. 256 discrete inputs (32 words) can be accommodated. It takes 32 minor frames to sample all inputs once (sampling rate=once/3.2 sec). A Major Frame contains 10 complete Digital "B" subcommutated frames.</p> <p>64 of these bit locations corresponding to TIP minor frames 24-31 form the XSU Digital "A" data. The XSU generates an 8 word subcom which is read out at the rate of one word per minor frame. The XSU subcom is synchronized with its word 1 in minor frame 24.</p>

Analog Subcom-2 (16 sec)	1	13	<p>This subcommutation is controlled by a PROM located in the TIP and contains 160 words locations with 128 analog channels sampled once every 16 seconds.</p> <p>The remaining 32 word locations contain data from the Solar Array Telemetry Commutator Unit (SATCU). The SATCU receives inputs from 16 sources on the solar array, commutates them and presents this stream and presents it in the last 32 word locations. The 32 words represent two successive passes through the SATCU subcom.</p>
DAU-1	1	14	8 Bit Housekeeping Telemetry words are formed by the DAU-1 and read out by the telemetry system at an average of 10 words per second.
DAU-2	1	15	8 Bit Housekeeping Telemetry words are formed by the DAU-2 and read out by the telemetry system at an average of 10 words per second.
HIRS/4	36	16,17, 22,23, 26,27, 30,31, 34,35, 38,39, 42,43, 54,55, 58,59, 62,63, 66,67, 70,71, 74,75, 78,79, 82,83, 84,85, 88,89, 92,93	8 Bit words are formed by the HIRS/3 experiment and are read out by the telemetry system at an average rate of 360 words per second.
SEM	2	20,21	8 Bit words are formed by the SEM sensor and ready out by the telemetry system at an average rate of 20 words per second.

DCS-2	32	18,19, 24,25, 28,29, 32,33, 40,41, 44,45, 52,53, 56,57, 60,61, 64,65, 68,69, 72,73, 76,77, 86,87, 90,91, 94,95	8 Bit words are formed by the DCS experiment and are read out by the telemetry system at an average rate of 320 words per second
SBUV/2	4	36,37, 80,81	8 Bit words are formed by the SBUV/2 experiment and read out by the telemetry system at an average rate of 40 words per second.
CPU A Telemetry	6	46,47, 48,49, 50,51	A second block of 16 Bit CPU words is ready out by the telemetry system every minor frame.
CPU B Telemetry	6	96,97, 98,99, 100,101	A second block of 16 Bit CPU words is ready out by the telemetry system every minor frame.
CPU Data Status	1-	103	Bits 1 And 2: 00=All CPU data received 01=All CPU A data received; CPU B data incomplete 10= All CPU B data received; CPU A data incomplete 11=CPU A and CPU B data incomplete
Parity	1-	103	Bit 3: Even parity check in words 2 through 18 Bit 4: Even parity check in words 19 thru 35 Bit 5: Even parity check in words 36 thru 52 Bit 6: Even parity check in words 53 thru 69 Bit 7: Even parity check in words 70 thru 86 Bit 8: Even parity check in words 87 thru bit 7 of word 103

4.3.4 Digital "A" Telemetry

4.3.4.1 HIRS

4.3.4.1.1 HIRS/3

The data from the HIRS/3 are provided to the TIP system from a storage register. The TIP clock pulse (C_1) and Data Select pulses determine the time at which data are called out. The TIP formatter calls out groups of 8-bit words in a sequence that multiplexes HIRS/3 data with that of other instruments. Because of the large quantity of HIRS/3 data to be transmitted and the use of 13-bit decoding of radiometric data, it was not possible to format the HIRS/3 data into neat 8-bit segments. The HIRS/3 data are therefore provided as a continuous stream with 13-bit word lengths. During any minor frame, there are 288 bits of data; each bit is identified as to its purpose.

A full set of HIRS/3 operational data, including command status monitors, housekeeping information and radiance data of the 20 channels, is contained in the Digital "A" output. The HIRS/3 data repeats every 6.4 seconds as described below. The 6.4 second period contains 64 elements.

1) Element Definition

Digital A output is divided into "elements" of 288 bits. An element is phased to fit into a TIP minor frame as described above.

2) Element Formats

Sixty-four elements make up each scan. The formats for the elements repeat every 6.4 seconds and correspond to the particular parts of the scan. Element numbers 0-55 are Earth scan data. Scan element 0 describes the data at the time of viewing the first Earth scan position. Scan element 55 designates the last Earth scan position. Scan elements 56-63 occur during retrace during normal Earth scanning. The same element number designations continue when the scan is commanded to a calibration target. Normally the mirror motion to the warm calibration target takes place during the normal retrace interval. In the case of slew to the space look position, the motion occurs during scan elements 0 to 7.

Data reduction must take this into account as required. The elements are divided as follows:

(a) Bits 1-26

Two 13 bit words have the same function in all 64 elements. The function assembled in these words are as follows:

<u>Word 1</u>	<u>Function</u>	<u>Range (Decimal)</u>
1 - 8	Scan Encoder Position	0 to 199
9 - 13	Electronic Cal Level Indicator	0 to 331

<u>Word 2</u>	<u>Function</u>	<u>Range (Decimal)</u>
1 - 6	Channel 1 Period Monitor	0 to 63
7 - 12	Element Number	0 to 63
13	Filter Sync Designator	n/a

(b) Bits 27-286

This group of bits is divided into 20 13-bit words (20 Ch x 13 Bits). For elements 0-55, these are the Radiant Signal Output. The word functions are dependent on element number. Except for the two status words in element 63, all words are quantity where bit 1 is the sign bit and bits 2 through 13 are amplitude (0 to 4095). Bit 2 is the most significant bit (MSB) and bit 13 is the least significant bit (LSB) of the quantity. The sign bit is:

logic "1"	+ (positive)
logic "0"	- (negative)

The HIRS/3 instrument serial number is preset for each instrument in element 63, bits 42-44. The protoflight has the designation 001; the flight models will be designated 002 on up.

(c) Bits 287 & 288

In the same manner as for bits 1 through 26, these two bits have the same function in all 64 elements. In order to aid determination of times when data should not be used, we have included a Valid Data Bit into the data stream. This bit is a "1" when all conditions are normal and data may be considered good. It will be a "0" when the scan system is in a slew mode or when the filter wheel is not synchronized to the timing system.

Bit 287 Valid Data Bit

logic "1"	Valid Data
logic "0"	Ignore Radiometric Data

Minor Word Parity Check is a bit inserted to make the total word odd. This permits automatic checking for data losses in the transmission of the data from the HIRS/3.

Bit 288 Odd bit parity

3) Function Descriptions

Scan Encoder Position - Encoder position is the sensed position of the scan mirror in 1.8 degree increments. The scan positions are described later, but it may be noted that encoder position "1" occurs at the first Earth scan position, hence will be the encoder position noted during element "0".

Electronic Cal Level Indicator - Electronic calibration level advances from 0 to 31, defining the step level measured in each radiometric channel during elements 56 and 57. Since both a positive and negative calibration is made at the end of each scan line, the level applies to both. The step level starts at 0 on the first scan after a calibration start pulse and continues repetitively after that and even when calibration is disabled.

Channel 1 Period Monitor - Measures the variation in time interval of a segment of the filter wheel on each rotation. The reading measures 1.248 MHZ clock intervals of that segment; hence, it defines velocity variations to a granularity of 0.8 microseconds. This is a diagnostic output and is not used in system data processing or evaluation.

Element Number - The number of this data group. It advances from 0 to 63 with element 0 related to the first Earth scan position. The element number repeats regardless of scan position or mode.

Filter Sync Designator - Filter Sync is a "1" when the filter wheel is in synchronism with the timing system. This is diagnostic data not normally used in data collection or processing.

Table 4.3.4.1.1-1 Digital "A" Status Telemetry

Element Number	Bit Number	Function	Remarks
0-55	27-39	Radiometric Channel No.1 (669 cm ⁻¹)	0 counts radiance from scene equal radiance from filter wheel (FW). Plus (+) values are warmer than FW.
	40-52	Radiometric Channel No.17 (2360 cm ⁻¹)	0 counts offset from FW radiance. Plus and minus are warmer and cooler than offset.
	53-65	Radiometric Channel No. 2 (680 cm ⁻¹)	No offset.
	66-78	Radiometric Channel No. 3 (690 cm ⁻¹)	No offset.
	79-91	Radiometric Channel No.13 (2190 cm ⁻¹)	Offset.
	92-104	Radiometric Channel No.4 (703 cm ⁻¹)	No offset.
	105-117	Radiometric Channel No.18 (2515 cm ⁻¹)	Offset.
	118-130	Radiometric Channel No.11 (1365 cm ⁻¹)	No offset.

	131-145	Radiometric Channel No.19 (2660 cm ⁻¹)	Offset.
	146-156	Radiometric Channel No. 7 (749 cm ⁻¹)	No offset.
	157-169	Radiometric Channel No. 8 (900 cm ⁻¹)	No offset.
	170-182	Radiometric Channel No.20 (14,500 cm ⁻¹)	Black is minus. White is plus.
	183-195	Radiometric Channel No.10(1225 cm ⁻¹)	No offset.
	196-208	Radiometric Channel No.14 (2210 cm ⁻¹)	Offset.
	209-221	Radiometric Channel No.6 (733 cm ⁻¹)	No offset.
	222-234	Radiometric Channel No.5 (716 cm ⁻¹)	No offset.
	235-247	Radiometric Channel No.15 (2240 cm ⁻¹)	Offset.
	248-260	Radiometric Channel No.12(1488cm ⁻¹)	No offset.
	261-273	Radiometric Channel No.16 (2270 cm ⁻¹)	Offset.
	274-286	Radiometric Channel No.9 (1030 cm ⁻¹)	Offset
56	27-286	Positive Electronics Calibration. Applied to 20 radiometric channels.	Calibration level advances one of the 32 equal level steps on successive scans. The offset and gain of each channel will influence the amplitude of the signal. The calibration level applied to the electronics channels is indicated
57	27-286	Negative Electronics Calibration Applied to 20 radiometric channels	n/a
58	27-91	Internal Warm Target Temperature Sensor #1	Value repeated 5 times. Range 273 to 333 K.
	92-156	Temperature Sensor #2	Value repeated 5 times. Range 273 to 333 K.
	157-221	Temperature Sensor #3	Value repeated 5 times. Range 273 to 333 K.
	222-286	Temperature Sensor #4	Value repeated 5 times. Range 273 to 333 K.
59	27-91	Internal Cold Target Temperature Sensor #1	n/a
	92-156	Internal Cold Target Temperature Sensor #2	n/a
	157-221	Internal Cold Target Temperature Sensor #3	n/a
	222-286	Internal Cold Target Temperature Sensor #4	n/a
60	27-90	Filter Wheel Housing Temperature Sensor #1	Value repeated 5 times. Range 273 to 333 K.
	92-156	Temperature Sensor #1	Value repeated 5 times. Range 273 to 333 K.
	157-221	Temperature Sensor #1	Value repeated 5 times. Range 273 to 333 K.
	222-286	Temperature Sensor #1	Value repeated 5 times. Range

			273 to 333 K.
61	27-90	Patch Temperature Expanded Scale	Value repeated 5 times. Range 90 to 150 K.
	92-156	First Stage Radiator Temperature Sensor	Value repeated 5 times. Range 150 to 320 K.
	157-221	Filter Wheel Housing Current	Value repeated 5 times. Range 0 to 500 mA,
	222-286	Electronic Calibration Digital to Analog	Value repeated 5 times. Range volts 0 to 4 V.
62	27-39	Scan Mirror Temperature	Range 260 to 320 K.
	40-52	Primary Telescope Temperature	Range 260 to 320 K.
	53-65	Secondary Telescope Temperature	Range 260 to 320 K.
	66-78	HIRS/3 Baseplate Temperature	Range 260 to 320 K.
	79-91	HIRS/3 Electronics Temperature	Range 260 to 320 K.
	92-104	Patch Temperature-Full Range	Range 90 to 320 K.
	105-117	Scan Motor Temperature	Range 260 to 320 K.
	118-130	Filter Wheel Motor Temperature	Range 260 to 320 K.
	131-143	Cooler Housing Temperature	Range 260 to 320 K.
	144-156	Patch Control Power	Range 0 to 80 mW
	157-169	Scan Motor Current	Range 0.65 to 1.0 mA
	170-182	Filter Motor Current	Range 100 to 300 mA
	183-195	+15 Vdc	Range 15 ± 0.2 V
	196-208	-15 Vdc	Range -15 ± 0.2 V
	209-221	+7.5 Vdc	Range 7.5 ± 0.05 V
	222-234	-7.5 Vdc	Range -7.5 ± 0.02 V
	235-247	+10 Vdc	Range 10 ± 0.2 V
	248-260	+5 Vdc	Range 5 ± 0.2 V
261-273	Analog Ground	Range ± 1 count	
274-286	Analog Ground	Range ± 1 count	
63	27-39	Line Counter (gives the number of lines from the last auto calibration sequence)	0 to 8191 (There is no sign bit used in the line counter). Reset to 0 count is only when counter overflows.
	40-52	First Status Word	First 5 bits are instrument serial number (no sign bit). The remaining bits indicate status as shown in Table 4.3.4.1.1-2.
	53-65	Second Status Word	First 5 bits are zero filled. The remaining bits indicate status as shown in Table 4.3.1.1-2.
	66-78	Data Verification Binary Code	Binary code is: (1,1,1,1,1,0,0,1,0,0,0,1,1) Equivalent to Base 10 value +3,875

79-91	Base 10 value +1,443
92-104	Base 10 value -1,522
105-117	Base 10 value -1,882
118-130	Base 10 value -1,631
131-143	Base 10 value -1,141
144-156	Base 10 value 1,125
157-169	Base 10 value 3,655
170-182	Base 10 value -2,886
183-195	Base 10 value -3,044
196-208	Base 10 value -3,764
209-221	Base 10 value -3,262
222-234	Base 10 value -2,283
235-247	Base 10 value -2,251
248-260	Base 10 value 3,214
261-273	Base 10 value 1,676
274-286	Base 10 value 1,992

4) Digital “A” Status Telemetry

The last element of each scan, element 63, contains two status words. Bits 45-52 and 58-65 of element 63 are command status bits. Logic state definition is shown in Table 4.3.4.1-2.

Table 4.3.4.1.1-2. Digital “A” Status Telemetry (Element 63, Status Words).		
Bit Number	Function	Remarks
First Status Word		
45	Instrument ON/OFF	ON = 1
46	Scan Motor ON/OFF	ON = 0
47	Filter Wheel ON/OFF	ON = 0
48	Electronics ON/OFF	ON = 1
49	Cooler Heat ON/OFF	ON = 0
50	Internal Warm Target Position	True = 0
51	Internal Cold Target Position	True = 0
52	Space Position	True = 0
Second Status Word		
58	Nadir Position	True = 0
59	Calibration Enable/Disable	Enabled = 0
60	Cooler Door Release Enable/Disable	Enabled = 0
61	Cooler Door Open	YES = 1
62	Cooler Door Closed	YES = 1
63	Filter Housing Heat ON/OFF	ON = 0
64	Patch Temperature Control ON/OFF	ON = 0
65	Filter Motor Power High	Normal = 1

4.3.4.1.2 HIRS/4

Digital “A” data from the instrument is described in Table 4.3.4.1.2-1. The TIP clock pulse (C_1) and Data enable pulses determine the time at which the data is called out. The TIP formatter calls out groups of 8-bit words in a sequence that multiplexes HIRS/4 data with that of other instruments on the NOAA-N, -N’ spacecraft. Along with this requirement, the large quantity of instrument data to be transmitted and the use of 13-bit encoding of radiometric data, it was not possible to format the data into 8-bit segments. The HIRS/4 data is therefore provided as a continuous stream composed of 13-bit word lengths but clocked out in 8-bit words by the TIP. During any Minor Frame there are 288 bits of HIRS data which are extracted at an equivalent 8,320 bps rate.

The data format remains the same during the 56 earth scan element time periods. During retrace, which is an interval of eight earth scan element time periods, the data format is changed to provide for measurement of the internal electronic calibration and to sample all of the Housekeeping telemetry data.

Scan Element 0 contains the data which describes the scene at the time of viewing the first scan position. The scan positions are described later, but it should be noted that encoder position “1” occurs at the first earth scan position and hence will encoder position noted during element “0”. Scan element 55 designates the last scan position. Scan Elements 56-63 occur during the scan mirror retrace during normal earth scanning. These same element number designations apply also when the scan is commanded to a calibration target during the Auto Calibration (Autocal) sequence. Normally the mirror slewing motion between calibration targets takes place during the normal retrace interval except for the case of slew to the space look position where the motion occurs during scan elements 0 to 7. Therefore, space look during Autocal is only for 48 elements (8 through 55).

IN order to determine when radiometric data should not be used, a Valid Data bit is included in the data stream. This bit is a “1” when all conditions are normal and the radiometric data may be considered good. It will be a “0” when the scan system is in a slew mode.

The electronic calibration level advances on level per scan line from 0 to 31, defining the step level measured in each radiometric channel during elements 56 and 57. Since both a positive and negative calibration is made during a scan line, the same level value applies for both.

The Channel 1 Period Monitor measures the time interval of the travel from the Channel 1 to the Channel 2 segments of the filter wheel on each rotation. The reading measures 1,248 MHz clock intervals during that segment, hence defines filter rotation time with a resolution of 0.8 microseconds. This is not used in normal system data processing or evaluation but is a powerful diagnostic tool to aid in assessing the filter wheel subsystem health.

With every filter wheel revolution, a block of data is generated. This block, called an element is 288 bits long. A scan line consists of 56 scene views and eight retrace elements. Thus, there are 64 (56 + 8) filter wheel revolutions per line and 64 elements per scan line. Each element is numbered 0 to 63 and this 6-bit binary number is included in each element at bit location 20-25.

Filter Sync Designator is a “1” when the filter wheel is in synchronized with the data control timing system. This is diagnostic data not normally used in data collection or processing. If the Filter Sync Designator is “0” the radiometric data is not valid.

Radiant Signal Output is the 13-bit binary level measurement of the signals coming from the various detectors. The first bit is a sign bit (“1” positive, “0” is negative). The remaining twelve data bits are straight binary code in order from the most significant to least significant bit.

Mirror Word Parity Check is the last bit of each Minor Frame or data element and is inserted to make the total number of “ones” in that data element odd. This permits checking for loss of data integrity between transmission from the instrument and the reconstruction on the ground. Elements 58-61 contain the outputs of the temperature and the ECAL DAC, sampled five times during each element. This approach provides a more accurate measurement of the more critical sensor temperatures.

In element 62, the data multiplexer connects other voltage and temperature sensors outputs into the A/D converter for one sample each, thereby allowing monitoring of all the major test points in the system.

Element 63 contains the command status, the instrument serial number, the total line number since the last radiometric calibration (in 13-bit natural binary), and a fixed word pattern and fill bits.

The Instrument Serial Number is unique for each instrument. The HIRS/4 instruments will be designated as 015, 016, 017 and 018.

Command Status is a tabulation of the state of the command relays.

Table 4.3.4.2-1 shows the HIRS/4 Digital “A” output. The only content difference between HIRS/3 data and HIRS/4 data is in element 59.

Table 4.3.4.1.2-1 HIRS/4 Digital “A” Data Output Format.

Element #	Bit #	Description	Range Counts	Notes
0-55 (Earth Scan Elements)	1-8	Encoder Position	0 to 200	
	9-13	Electronic Cal Level	0 to 31	
	14-19	Channel 1 Period Monitor	0 to 63	
	20-25	Element Number	0 to 63	
	26	Filter Sync Designator	0 or 1	
	27-286	Radiant Signal Output (20 Channels x 13 bits)	0 to ± 4095	
	287			
56-63	1-26	Same as Above		
	287,288	Same as Above		
56	27-286	Positive Electronic Calibration. 13 bits for each channel(Cal. Level advances on of 32 equal levels on succeeding scans)		
57	27-286	Negative Electronic Calibration. 13 bits for each channel (Cal. Level advances one of 32 equal levels on succeeding scans)		
58	27-91	Internal Warm Target #1, 13 bits x 5 Times		
	92-156	Internal Warm Target #2, 13 bits x 5 Times		
	157-221	Internal Warm Target #3, 13 bits x 5 Times		
	222-286	Internal Warm Target #4, 13 bits x 5 Times		
59	27-91	Internal Cold Target # 1, 13 bits x 5 Times		
	92-156	Ground		
	157-221	Internal Warm Target #5, 13 bits x 5 Times		
	222-286	Tertiary Telescope Temp, 13 bits x 5 Times		
60	27-91	Filter Housing Temp #1, 13 bits x 5 Times		
	92-156	Filter Housing Temp #2, 13 bits x 5 Times		
	157-221	Filter Housing Temp #3, 13 bits x 5 Times		
	222-286	Filter Housing Temp #4, 13 bits x 5 Times		
61	27-91	Patch Temp Expanded, 13 bits x 5 Times		
	92-156	First Stage Temp, 13 bits x 5 Times		
	157-221	Filter Housing Control Power/Temp, 13 bits x 5 Times		
	222-286	Electronic Calibration DAC, 13 bits x 5 times		
62	27-39	Scan Mirror Temperature		
	40-52	Primary Telescope Temperature		
	53-65	Secondary Telescope Temperature		
	66-78	Baseplate Temperature		
	79-91	Electronics Temperature		
	92-104	Patch Temperature – Full Range		
	105-117	Scan Motor Temperature		
	118-130	Filter Motor Temperature		

	131-143	Radiant Cooler Housing Temperature		
	144-156	Patch Control Power		
	157-169	Scan Motor Current		
	170-182	Filter Motor Current		
	183-195	+15 V dc		
	196-208	-15 V dc		
	209-221	+7.5 V dc		
	222-234	-7.5 V dc		
	235-247	+10 V dc		
	248-260	+5 V dc		
	261-273	Analog Ground		
	274-286	Analog Ground		
	63	27-39	Line Count	
40		Fill Zero		
41-44		Instrument Serial Number		
45-52		Command Status		1
53-57		Fill Zeroes		
58-65		Command Status		1
66-78		Binary code (1,1,1,1,110,0,1,0,0,0,1,1,) +3875 (base 10)		2
79-91		+1443		2
92-104		-1522		2
105-117		-1882		2
118-130		-1631		2
131-143		-1141		2
144-156		+1125		2
157-169		+3655		2
170-182		-2886		2
183-195		-3044		2
196-208		-3764		2
209-221		-3262		2
222-234		-2283		2
235-247		-2251		2
248-260	+3214		2	
261-273	+1676		2	
274-286	+1992		2	
Command Status bits				
63	45	Instrument ON/OFF	ON=1	1
	46	Scan Motor ON/OFF	ON=0	1
	47	Filter Wheel ON/OFF	ON=0	1
	48	Electronics ON/OFF	ON=1	1
	49	Cooler Heat ON/OFF	ON=0	1
	50	Internal Warm Target Position	True=0	1
	51	Internal Cold Target Position	True=0	1

	52	Space Position	True =0	1
	58	Nadir Position	True=0	1
	59	Calibration Enable/Disable	Enable=0	1
	60	Cover Release Enable/Disable	Enable=0	1
	61	Cooler Cover Open	Yes=1	1
	62	Cooler Cover Closed	Yes=1	1
	63	Filter Housing Hear ON/OFF	ON=0	1
	64	Patch Temp Control ON/OFF	ON-0	1
	65	Filter Motor Power HIGH	Normal=1	1

Notes:

1. Command Status Bits
2. Fixed word pattern used to establish data stream synchronization with TIP.

4.3.4.2 SEM-2

SEM-2 data accumulation and transfer are synchronized to the spacecraft's 32 second Major Frame. The Major Frame consists of 320 0.1 second Minor Frames, and SEM-2 is assigned two Digital A data words (20 and 21) per Minor Frame.

The Digital A telemetry format is shown in Table 4.3.4.2-1 which identifies the data assignments for each of the two SEM data words in the 320 Minor Frames constituting one Major Frame.

MEPED Digital A data consists of six directional proton measurements and three directional electron measurements for each of two directions of incidence (0 and 90 degrees) and four omnidirectional proton measurements. All but the two highest energy omnidirectional proton measurements are read out every two seconds. The two highest energy omnidirectional proton measurements are read out every four seconds. The MEPED Digital A data and readout rates are summarized in Table 4.3.4.2-2.

TED Digital A data consists of a 0.05 to 1 keV partial energy flux measurement, a 1 to 20 keV partial energy flux measurement, maximum differential energy fluxes, four-point differential energy spectra and background measurements for electrons and protons, each at two angles of incidence (0 and 30 degrees). The TED Digital A output data and readout rates are summarized in Table 4.3.4.2-3. Note that the four differential energy flux maximum channel identifiers (OEM, OPM, 3EM and 3PM) are each four bits long (each identifies 1 of 16 channels) and are combined into two 8 bit words (OEM/OPM and 3EM/3PM). Note also that two (0 and 30 degrees) proton four-point differential energy spectra are read out only three times every 32 seconds, while the two (0 and 30 degrees) electron four-point differential energy spectra are read out four times every 32 seconds (every 8 seconds). Sensor background data and synchronization words are read out in place of the fourth proton four-point differential energy spectral data.

Table 4.3.4.2-1. SEM Digital “A” Telemetry Data Assignments

Minor Frame # Data in Word 20 Data in Word 21	0 CKSM 0P1	20 TED SWP VAN SUB5	40 TED E CEM HV	60 TED P CEM HV	80 MEP OMN I BV	100 AN SUB 1	120 AN SUB 2	140 AN SUB 3	160 AN SUB 4	180 TED IPC V	200 MEP IFC V	220 BL 1	240 BL 2	260 BL SUB	280 0E BK H	300 3EB KH	House Keeping
.1 sec	1 0P2 0P3	21	41	61	81	101	121	141	161	181	201	221	241	261	281	301	MEPED 0 degree Temper ature
	2 0P4 0P5	2	42	62	82	102	122	142	162	182	202	222	242	262	282	302	
	3 0P6 0E1	23	43	63	83	103	123	143	163	183	203	223	243	263	283	303	
	4 0E2 0E3	24	44	64	84	104	124	144	164	184	204	224	244	264	284	304	
	5 9P1 9P2	25	45	65	85	105	125	145	165	185	205	225	245	265	285	305	MEPED 90 degree Temper ature
	6 9P3 9P4	26	46	66	86	106	126	146	166	186	206	226	246	266	286	306	
	7 9P5 9P6	27	47	67	87	107	127	147	167	187	207	227	247	267	287	307	
	8 9E1 9E2	28	48	68	88	108	128	148	168	188	208	228	248	268	288	308	
	9 9E3 P6	29	49	69	89	109	129	149	169	189	209	229	249	269	289	309	MEPED OMNI
.1 sec	10 P7 98	30	50	70	90	110	130	150	170	190	210	230	250	270	290	310	
	11 ODE1 ODE2	31 3DE1 3DE2	51 0DP1 3DP2	71 3DP1 3DP2	91 ODE1 ODE2	111 3DE1 3DE2	131 0DP1 0DP2	151 3DP1 3DP2	171 ODE1 ODE2	191 3DE1 3DE2	211 0DP1 0DP2	231 3DP1 3DP2	251 ODE1 ODE2	271 3DE1 3DE2	291 OEBKL 2EBKL	311 Sync F3 3PBKL	TED Differen ces

	12 ODE3 ODE4	32 3DE3 3DE4	52 0DP3 0DP4	72 0DP3 0DP4	92 0DE3 0DE4	112 3DE3 3DE4	132 0DP3 0DP4	152 3DP3 3DP4	172 0DE3 0DE4	192 0DE3 0DE4	212 0DP3 0DP4	232 3DP3 3DP4	252 0DE3 0DE4	272 3DE3 3DE4	292 0PBKL 0PBLH	312 Sync 50 3pbkh	
	13 OEFL 3EFL	33	53	73	93	113	133	153	173	193	213	233	253	273	293	313	TED Low Differ ences
	14 0PFL 3PFL	34	54	74	94	114	134	154	174	194	214	234	254	274	294	314	
	15 0EFH 3EFH	35	55	75	95	115	135	155	175	195	215	235	255	275	295	315	TED High Differ ences
	16 03FH EPFH	36	56	76	96	116	136	156	176	196	216	236	256	276	296	316	
	17 0EM/0 PM/ 0DEM	37	57	77	97	117	137	157	177	197	217	237	257	277	297	317	TED PERK FLUX
	18 0DPM 3EM/ 3PM	38	58	78	98	118	138	158	178	198	218	238	258	278	298	318	
	19 3DEM 3DPM	39	59	79	99	119	139	159	179	199	219	239	259	279	299	319	
		2 sec	4 sec		8 sec				16 sec				24 sec				32 sec
Note: Dash indicates data is the same as in previous column																	

Particle Type	Sensor	Detected Energy Range	Readout Time(s)	Mnemonics
Proton	Telescope 0/90 Degrees	30-80 keV	2	0P1,9P1
		80-250 keV	2	0P2,9P2
		250-800 keV	2	0P3,9P3
		800-2500 keV	2	0P4,9P4
		2500-7000 keV	2	0P5,9P5
		> 7000 keV	2	0P6,9P6
Electron	Telescope 0/90 Degrees	≥ 30 keV	2	0E1, 9E1
		≥ 100 keV	2	0E2,9E2
		≥ 300 keV	2	0E3, 9E3
Proton	Omni- directional	≥ 16 MeV	2	P6
		≥ 35 MeV	2	P7
		≥ 70 MeV	2	P8
		≥ 140 MeV	2	P9

Definition(See Note 1)	Readout Time(s)	Mnemonics	Notes
0.05-1 keV Partial Energy Flux	2	0EFL,0PFL,3EFL,3PFL	
2-10 keV Partial Energy Flux	2	0EFH,0PFH,3EFH,3PFH	
Maximum Differential Energy Flux	2	0DEM,0EPM,3DEM,3DPM	
Energy of Maximum Differential Energy Flux	2	0EM,0PM,3EM,3PM	2
Four Point Energy/Flux Spectrum	8	0DE1,0DE2,0DE3,0DE4, 3DE1,3DE2,3DE3,3DE4, 0PD1,0PD2,0PD3,0PD4, 3PD1,3PD2,3PD4,3PD4	3,4
Background	32	0EBKH,0EBKL,0PBKH,0PBKL	
Notes:			
1. Four sets of measurements are made: electrons at 0 degrees, protons at 0 degrees, electrons at 90 degrees and protons at 90 degrees.			
2. Four bits each, combined into two data words (0EM/0PM and 3EM/3PM).			
3. Differential energy channels 4, 8, 11 and 14 (based on 1-16).			
4. The four-point proton spectra are read three times every 32 seconds.			

4.3.4.3 SBUV/2

Digital "A" data is clocked into the spacecraft TIP whenever the "A₁" Data Enable Pulse is presented to the instrument. Digital "A" data include both instrument data and any housekeeping telemetry required for reduction of observation data. The data format differs with the various SBUV/2 operating modes as described below.

4.3.4.3.1 Discrete Mode

The instrument views the earth's atmosphere or the sun if the diffuser is so deployed. In this mode, radiometric data is taken at twelve discrete wavelengths. The data format for this mode is shown in Table 4.3.4.3.1-1. Further details of the data format are provided in Tables 4.3.4.3.1-2, 4.3.4.3.1-3, 4.3.4.3.1-4, 4.3.4.3.1-5 and 4.3.4.3.1-6.

4.3.4.3.2 Sweep Mode

The instrument grating sweeps from approximately 400 nm to 160 nm, and data is taken in 0.15 nm increments. If SBUV/2 is viewing the earth, the scene spectral radiance is being measured. If the diffuser is deployed, the instrument is measuring the solar irradiance.

4.3.4.3.3 Wavelength Calibration Mode

The instrument views an on-board Hg lamp source at 12 discrete grating positions bracketing a particular source line. The data format for this mode is the same as that for the Discrete Mode, as shown in Table 4.3.4.3.1-1.

Line (See Note 3)	TIP Minor Frames (See Note 2)	Function		Sample Time		Integration Interval	
		Word 1 (See Note 4)	Word 2 (See Note 4)	Word 1(See Note 7)	Word 2	Word 1	Word 2
L0	0, 10, 20,..., 310	Status Word 1	Range 1 Data	End of L0, Channel N-1	End of L9, Channel N-1	n/a	1 ¼ sec and ¼ sec (See Note 8)
L1	1, 11, 21,..., 311	Status Word 2	Range 2 Data	Channel N-1	End of L9, Channel N-1	n/a	1 ¼ sec and ¼ sec (See Note 8)

L2	2, 12, 21,..., 312	Analog Sub Mux	Range 3 Data	End Of L0/L1, Channel N	End of L9, Channel N-1	0.1 sec	1 ¼ sec and ¼ sec (See Note 8)
L3	3, 13, 23,..., 313	Memory Verify	0000	End of L1, Channel N	n/a	n/a	n/a
L4	4, 14, 24,..., 314	Status Word 3	0000	Start of L0, Channel N	n/a	n/a	n/a
L5	5, 15, 25,..., 315	Status Word 4	0000	Start of L0, Channel N	n/a	n/a	n/a
L6	6, 16, 26,..., 316	Grating Position	0000	½ into L7 Alternates End of L9, Chan N-1	n/a	n/a	n/a
L7	7, 17, 27,..., 317	CCR Data	0000	End of L9, Channel N-1	n/a	1 ¼ sec (See Note 8) and ¼ sec	n/a
L8	8, 18, 28,..., 318	RDCL/GP E (See Note 6)	0000	End of L6/L7, Channel N	n/a	0.1 sec	n/a
L9	9, 19, 29,..., 319	Frame Code Sync	0000	Start of L0, Channel N	n/a	n/a	n/a

Notes:

- 1) Include discrete, calibration and position modes.
- 2) Format is the same for all major frames.
- 3) The basic SBUV/2 data frame is a 20-block repeating a one second intervals.
- 4) Word 1 corresponds to the 16 bits in TIP words 36 and 37, MSB sent first. Word 2 corresponds to the 16 bits in TIP words 80 and 81, MSB sent first.
- 5) Analog sub-mux is 16 channels deep.
- 6) Radiometric DC level/grating position error.
- 7) Channel N is the present 1 second time interval. Channel N-1 is the previous 1 second time interval.
- 8) In every two second interval, signal integration occurs between ¾ and 2 sec; signal is sampled and readout at the end of 1 sec and two sec.

Table 4.3.4.3.1-2. SBUV/2 Data Format Discrete Mode Detailed Description

Name of Function	Format Location		Bit Numbers																
	Word	Line	MSB LSB																
			1	2	3	4	5	6	7	8	9	10	11	12	13	14	15	16	
Frame Sync Code and Sub-multiplexer Channel Number	1	9	2 ³	2 ²	2 ¹	2 ⁰	1	1	0	1	0	1	1	0	0	0	0	0	
Frame Sync Sub-multiplexer Cannel Numbers (Full Scale Counts 255 = 5.1 V, all analog channels)																			
Analog Sub-Mux (see Table 4.3.4.3.1-7 for commutation scheme)	1	2	Channel A								Channel B								
			2 ⁷	2 ⁶	2 ⁵	2 ⁴	2 ³	2 ²	2 ¹	2 ⁰	2 ⁷	2 ⁶	2 ⁵	2 ⁴	2 ³	2 ²	2 ¹	2 ⁰	
Radiometric DC Level/Grating Position Error (See Note 3)	1	8	Full Scale Counts 255 = 5.1 Volts, Note: RDCL F.S. Current 91.5 pa																
Monochromator Range Data	2		2 ¹⁵ -----2 ⁰																
			Maximum Count = 65,535 (See Note 1), Full Scale Counts = 65,536																
			Full Scale Current																
				Disc								Sweep							
		0	Range 1 (see Note 2)	100 pa								1.25 na							
		1	Range 2 (see Note 2)	10 na								125 na							
2	Range 3 (see Note 2)	1 :a								12.5 :a									
Cloud Cover Radiometer Data	1	7	CCR								2.4 na				30 na				
Memory Verification Repeats every 128 sec Reads memory as indicated by memory bits shown to right Memory location readout in order starting with Word 0 segment 0 of fixed memory at TIP major frame pulse	1	3	2 ¹² position data in Memory								2 ⁰ S ¹ S ² F								
			Segment								S ¹		S ⁰		Program		F		
			0								0		0		Fixed		1		
			1								0		0		Flex		0		
			2								1		0						
3								1		1									
Grating Position Number greater than 0 = CW of Index	1	6	2 ¹² 2 ⁰ S ₁ S ₂ L																
			Segment Being Read								S ₁				S ₀				
			0								0				0				

Index = all zeroes 1 bit CW = 0 1 bit CCW = all ones			1	0	1	
			2	1	0	
			3	1	1	
			This is the actual position number. Code is in 2's complement. Digital Lock L=1 (locked).			
Range Identification	Status Words 1 and 2	Range Selected	Bit A	Bit B		
		R ₁	0	1		
		R ₂	1	0		
		R ₃	1	v1		
Sweep Mode Major Frame Counter	Status Word 1 Bits 3,4 & 5	Frame	Count	Bit No.		
		None	0	3	4	5
		(First)	1	0	0	0
		2	2	0	0	1
		3	3	0	1	0
		4	4	0	1	1
		5	5	1	0	1
		6(Last)	6	1	1	0
Notes:						
1) Overflow flags (status 3 bits 1, 2, 3 and 4).						
2) Current referred to the PMT anode.						
3) Grating Motor Current, Grating Position Error and Grating Coarse Error are expected to always read 0 to 10 counts (telemetry points are grounded) and data should be disregarded.						

Table 4.3.4.3.1-3. SBUV/2 Data Discrete Mode Temperature Monitor Description.						
Temperature Monitors:						
1. Differential Monitors $T_D = T_A - T_R$; $N_A = N_R + 0.1075 N_D - 13.7$ (See Note 1)						
2. Single Point Monitors:						
Temperature (Degrees C)	Thermistor (Ohms)	Output volts/Counts (N)				
		Shroud -30 to 80	Differential A to B Reference	0 to 80 degrees	-15 to 45 degrees	-5 to 35 degrees
-30	135.2 K	4.74/237				
-20	78.91 K	4.57/228			5.15	
-15	61.02 K	4.45/222	3.58/179		5.01/250	
-10	47.54 K	4.32/216	3.41/170	5.513	284.242	5.17
-5	37.31 K	4.16/208	3.22/161			4.95/247
0	29.49 K	3.99/199	3.01/150	4.98/249	4.42/221	4.70/235
5	23.46 K	3.79/189	2.79/140			
10	18.79 K	3.57/178	2.57/128	4.35/217	3.92/196	4.13/206
15	15.13 K	3.34/167	2.33/117			
20	12.26 K	3.10/155	2.11/105	3.67/183	3.36/166	3.52/176
25	10.00 K	2.86/143	1.89/94	3.33/167	3.08/154	
30	8.194 K	2.61/130	1.68/84	3.00/150	2.79/139	2.90/145
35	6.752 K	2.37/118	1.48/74			2.60/130
40	5.592 K	2.14/107	1.30/65	3.29/119	2.25/112	2.32/116
45	4.655 K	1.91/95	1.14/57		2.01/100	
50	3.893 K	1.71/85		1.86/93	1.78/89	1.82/91
60	2.76 K	1.35/67		1.44/72	1.39/69	1.41/70
70	1.99 K	1.05/52		1.1/55	1.08/54	1.09/54
80	1.458 K	0.81/41		0.85/42	0.831/41	
Note:						
1. N_A = Thermistor "A" temperature in counts, N_D = Differential Temperature in counts and N_R = Reference Temperature in counts.						

Table 4.3.4.3.1-4. SBUV/2 Data Format Discrete Mode Voltage and Current Monitors Description.	
Voltage Monitors	
Function	Conversion Factor
HVPS Volts	6 V/N (See Note 1)
E Cal Ref	0.04 V/N, 6.4 V/160 Counts Nominal, \forall 0.6 V limits
15 V Sensors	0.1 V/N, 15V/150 Counts Nominal, \forall 3.0 V limit
-15 V Sensors	$V = 0.6083 N_5 - 0.5059 N_{15}$ (See Note 2)
24 V Motor	0.198 V/N, 24 V/121 Counts Nominal, \forall 5 V limits
5 V LED	0.0333 V/N, 5V/150 Counts Nominal, \forall 1 V limits

10 V Logic	0.0667 V/N, 10 V/150 Counts Nominal, ± 1 V limits
28 V (See Note 1)	9.912 V/N, 28 V/2.82 V Nominal, ± 4 V limits
25 V	0.198 V/N, 25 V/126 Counts Nominal, ± 2.5 V limits
15 V Servo	0.1 V/N, 15 V/150 Counts Nominal, ± 1.5 V limits
-15 V Servo	$V = 0.6083 N_5 - .05059 N_{15}$ (See Note 2)
Thermistor Bias (10V)	0.0667 V/N, 10 V/150 Counts Nominal, ± 1 V limits
Current Monitors	
Chop Motor	0.002 A/N
Diffuser Motor	0.004 A/N
Cal Lamp Current	5.22 :A/N
Lamp Motor	0.004 A/N
Cal Lamp Heater	0.1 A/Current .017 A nominal
Miscellaneous	
Chopper Phase Error	0.0985 V/N
Notes:	
1. Analog Telemetry	
2. N = counts, N ₅ counts from 5V LED, N ₁₅ counts from 15 V LED	

Table 4.3.4.3.1-5. SBUV/2 Description of Command Sequence State Monitors.					
Command (CMD) Sequence State					
		2 ²	2 ¹	2 ⁰	
Discrete Sun Command Sequence	1-0	0	0	0	Discrete Sun Enable ON
	1-1	0	0	1	
	1-2	0	1	0	
		All other states not valid			
Sweep Sun Command Sequence Step No.	2-0	0	0	0	Sweep Sun Enable ON
	2-1	0	0	1	
	2-2	0	1	0	
	2-3	0	1	1	
		All other states not valid			
W/L (See Note 1) Calibration Command Sequence Step No.	3-0	0	0	0	W/L Calibration ON
	3-1	0	0	1	
	3-2	0	1	0	
	3-3	0	1	1	
	3-4	1	0	0	
	3-5	1	0	1	
	3-6	1	1	0	
	3-7	1	1	1	

		All other states not valid	
Note: 1. W/L = wavelength			

Table 4.3.4.3.1-6. Data Description of the Electronic Calibration Step Decoding using Timing Monitors and the Retrace Monitor.				
Timing Monitors				
E Cal Step No.	16 sec	8 sec	4 sec	Retrace
A	1	0	0	ON
B	1	0	1	
C	1	1	0	
D	1	1	1	
E	0	0	0	
A	0	0	1	
A	0	1	0	
A	0	1	1	
E Cal OFF				OFF
Note: Timing monitors are sampled at Channel N-1 (I sec prior to readout).				

Table 4.3.4.3.1-7. SBUV/2 Data Format Discrete Mode Analog Sub-Multiplexer Data Assignment			
Bits 1 through 8 Channel 8		Bits 9 through 16 Channel B	
Channel #	Function	Channel #	Function
1A	Chop Motor Current	1B	Spare
2A	Differential Motor Current	2B	Diffuser Plate Temperature (See Note 1)
3A	HVPS volts	3B	SM Baseplate Temperature (See Note 2)
4A	Thermistor Bias (10 V Reference)	4B	25 V Power Volts
5A	Calibration Lamp Temperature (See Note 1)	5B	15 V Servo Volts
6A	Electronic Calibration Reverence Volts	6B	-15 V Servo Volts
7A	15 V Sensors Volt	7B	CCR Diode Temperature (See Note 3)
8A	-15 V Sensors Volts	8B	SM Differential Temperature Y-Axis (See Note 4)
9A	24 V Motor Volts	9B	SM Differential Temperature Z-Axis (See Note 4)

10A	5 V LED Volts	10B	Differential Reference Temperature Z-Axis
11A	10 V Logic Volts	11B	Differential Reference Temperature Y-Axis
12A	Calibration Lamp Current	12B	PMT Cathode Temperature (See Note 3)
13A	Spare	13B	Spare
14A	Signal Return	14B	Chopper Phase Error
15A	Signal Return	15B	Spare
16A	Lamp Motor Current	16B	Spare
Notes: 1. 0 to 80 degrees C 2. -15 to 45 degrees C 3. -5 to 35 degrees C 4. ∇ 5 degrees C			

4.4 DATA COLLECTION AND LOCATION SYSTEM

4.4.1 GENERAL

The Data Collection System (DCS) on the NOAA KLM spacecraft is provided by CNES of France. This system provides a means to collect data and/or locate fixed and mobile buoy and balloon platforms. A complete description of the system is contained in Section 3.6.

If the data platforms and receive site are simultaneously in the view of the satellite, the Data Collection System provides the immediate rebroadcast of data from the platform, received by the satellite via an UHF uplink. These data are included as 32 8-bit words in the TIP minor frame. As such, it is available in both the low data rate DSB and high data rate HRPT services. Since the data rate on the new DCS/2 instrument has been increased from 1200 to 2560 bps, the number of TIP words allocated to DCS has been increased to 32 from the previous spacecraft series. However, interpretation of the telemetry remains unchanged. The DCS data in the direct broadcast services will only permit platform location computations with the proper computer software. More details can be obtained from Service ARGOS, as noted in Appendix E.

5.0 TRACKING PROCEDURES FOR DIRECTIONAL ANTENNAS USED TO ACQUIRE DATA FROM REAL TIME TRANS-MISSIONS SYSTEM SENSORS

All operators of satellite stations designed to receive any type of direct readout transmission from polar orbiting satellites need to know the satellite's position in time and space in order to know when to operate their equipment and to permit them to geographically locate the received data. Operators of stations using directional antennas also need this information to determine antenna pointing angles, although this is not required of stations using fixed, omnidirectional antennas.

One of the primary sources of information concerning a satellite's position in time and space is the TBUS predict bulletin. These bulletins are issued daily for all NOAA satellites, both polar orbiting and geostationary. The information in the bulletin can be used in a variety of computer programs (or hand plotted, using graphical techniques) to determine the antenna azimuth and elevation angles necessary to follow a polar orbiting satellite passing within receiving range of a given station. In advanced satellite receiving systems, the output can provide commands to directly drive the antenna aiming hardware. The content and primary sources of the TBUS bulletin are described in Sections 5.1 and 5.2. Alternate sources and forms of satellite prediction information are identified in Section 5.2.

The code form of the TBUS bulletin, an example of an actual bulletin, and a decoding exercise are given in Appendix A.

5.1 TBUS BULLETIN

The TBUS bulletin contains information on satellite equator crossing times and longitudes, orbit numbers, orbital period, longitudinal time, and longitudinal increments between successive orbits; also, satellite positions at two-minute intervals (for a reference orbit), transmission frequencies, and other information related to satellite tracking and performance. The orbital information is valid for the third day **after** the date on which the bulletin is prepared and transmitted.

The bulletins are prepared by NESDIS and transmitted through the National Weather Service Telecommunications Gateway (KWBC) to major meteorological centers and relay points around the world, which comprise the Global Telecommunications Service (GTS). The GTS primarily serves the international meteorological community. However, the TBUS bulletin receives further distribution via the Internet, electronic mail, high frequency radio broadcasts and commercial data services.

There are two forms of the TBUS bulletin. One form, identified as TBUS-1, is used to convey information about satellites that are descending in daylight (traveling north-to-south on the sunlit portion of the orbit). The second form, TBUS-2, provides data for satellites that are ascending in daylight (northbound on the sunlit portion of the orbit).

A schematic representation of the TBUS-1 and TBUS-2 bulletins is shown in Figure 5.1-1.

Both bulletins consist of four parts. Part 1 is quite short. It identifies a reference orbit on a given day (three days after the date of the bulletin) and gives the equator crossing time and longitude for this reference orbit. This is followed by an orbital nodal period and a longitudinal increment—the separation between successive equator crossings, measured in degrees. The orbit number of the fourth and eighth orbits following the reference orbit are then listed along with the equator crossing times and longitude of these orbits.

By itself, Part 1 contains sufficient information to permit the user to calculate future equator crossing times and longitudes several days in advance with considerable accuracy. During periods of maximum solar activity, however, the accuracy extrapolated from Part 1 information diminishes if the extrapolations are carried much more than a week ahead.

Parts II and III of the bulletins are quite lengthy. Part II (Day) contains predicted subpoint and height data at two-minute intervals for the portion of the orbit that is sunlit north of the equator. Part III (Day) contains predicted subpoint and height data at two-minute intervals for the portion of the orbit in darkness north of the equator. Part III (night) contains predicted subpoint and height data at two-minute intervals for the portion of the orbit in darkness south of the equator. All times are referenced to the ascending node (northbound equator crossing) and are given as minutes after or before this time (refer to Figure 5.1-1).

Part IV is relatively short, and usually consists of four items: a code group, transmission frequencies of each operating direct readout sensor system, the on-board clock variations and remarks. The code group consists of orbital parameters used to generate parts I through III. It is intended for use by those station operators needing more precision in satellite tracking and having appropriate computer programs to ingest such data and produce both equator crossings and antenna pointing angles.

The remarks in Part IV are in plain language and advise of problems or changes in the mode of operating the satellite, including the AVHRR/3 channels selected for the APT transmissions. Direct readout transmission frequencies are discussed elsewhere; in summary, the APT service for NOAA KLM will utilize 137.50 or 137.62 MHz; the HRPT will transmit on 1698.0 or 1707.0 MHz (1702.5 MHz is available for standby); the DSB beacon will operate on 137.35 or 137.77 MHz.

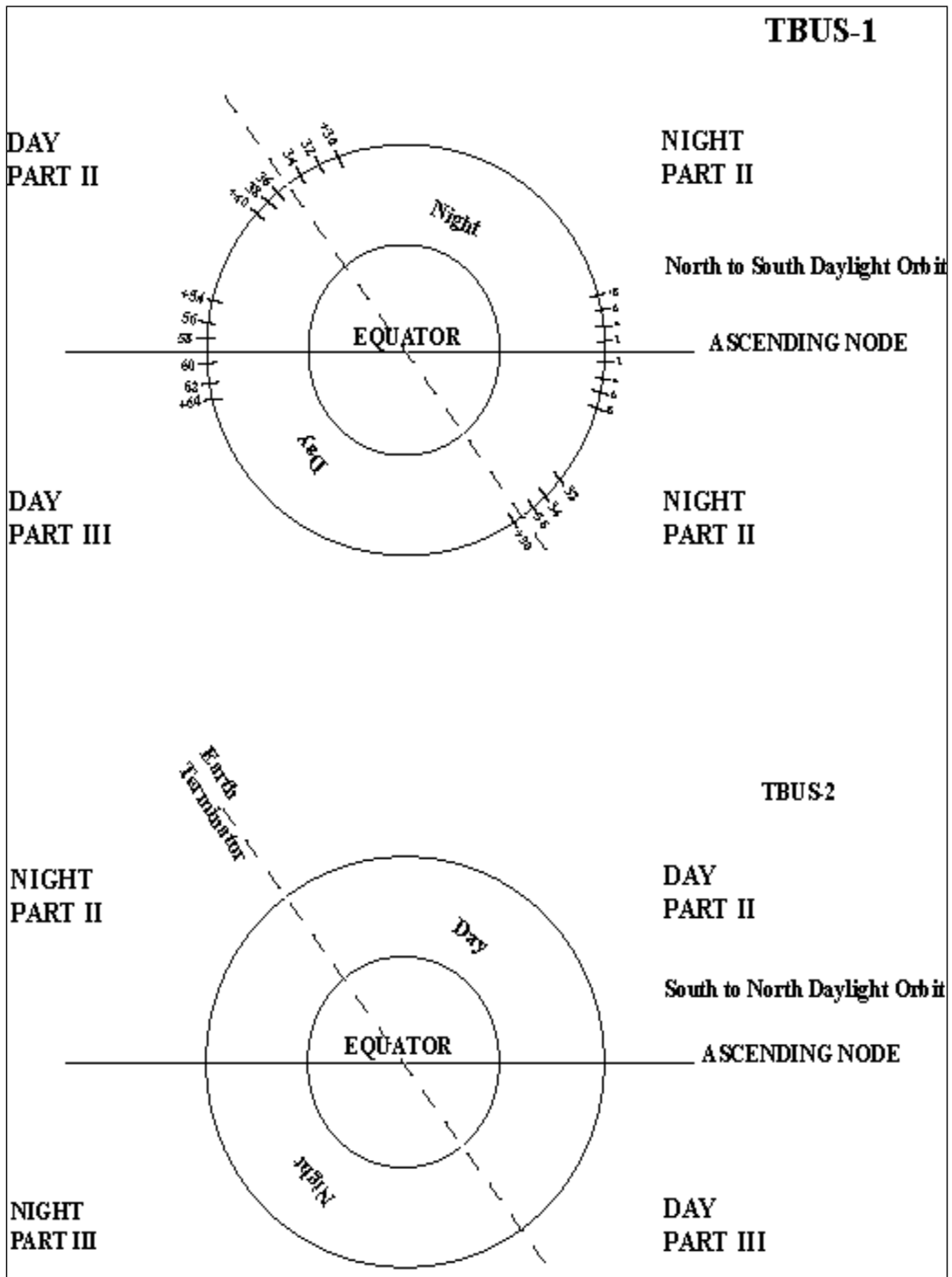

Figure 5.1-1. Schematic representation of TBUS-1/TBUS-2 information.

5.2 ALTERNATE SOURCES AND FORMS OF SATELLITE PREDICTION POSITION INFORMATION

The primary source for orbital prediction information for NOAA operated satellites is directly from NOAA via the Global Telecommunications System (GTS) and the Internet, and the main form of this information is the TBUS bulletin. .

These alternate sources include, but are not limited to, WEFAX broadcasts from U.S. geostationary satellites, electronic mail, telephone bulletin board systems, high frequency radio broadcasts, commercial environmental data providers, and the Aeronautical Fixed Telecommunications Network (AFTN).

NOAA maintains an Internet site (the NOAASIS) that always has the current TBUS bulletins. The TBUS bulletin is also broadcast once daily as part of the WEFAX transmission from U.S. geostationary satellites, for stations within range and with the proper receiving equipment.

With the proper receiving equipment r, some station operators are able to intercept the GTS radio-teletype (RTTY) meteorological transmissions containing the TBUS message. A number of major communications centers on the GTS relay this information via radio-teletype, especially for the use of ships on the high seas. Potential users would have to contact the nearest major center for frequencies and schedules.

In Africa and parts of the Middle East, a number of government meteorological services receive the TBUS bulletin as part of the Meteorological Data Distribution (MDD) broadcast via the METEOSAT geostationary satellite. Satellite readout station operators without other sources of orbital information are urged to contact an office of their national meteorological service to see if arrangements can be made to obtain copies of these messages.

The nonprofit, Radio Amateur Satellite Corporation (AMSAT) and its affiliates around the world serving the amateur radio community, broadcast the two line element messages daily via packet radio teletype. These broadcasts can be received in many parts of the world.

As of mid-1995, the U.S. Coast Guard included the TBUS message in high frequency, radio teletype broadcasts directed at the eastern and central North Pacific Ocean.

A more complete list of satellite navigation sources and points of contact is included in Appendix E.

Apart from the TBUS messages, the other most common form for transmitting orbital information is the two-line element (TLE) messages. These have the advantage of being very compact, and can be incorporated into many computer programs which will produce accurate satellite tracking and gridding information. The two-line, mean Keplerian orbital elements are derived from the NORAD SGP4 (Simplified General Perturbation) model. While similarly named elements appear in both the two-line and TBUS messages, the values are not

interchangeable between systems to compute satellite tracks using the TBUS or NORAD two-line elements. Doing so will result in large errors. Details on decoding the two-line element messages appear in Appendix A.

5.2.1 SOURCES OF ORBITAL INFORMATION FOR NOAA POLAR ORBITING SATELLITES

5.2.1.1 Internet

The NOAA Satellite Information System (NOAASIS) web site is a central location for finding information about NOAA environmental satellites (GOES and POES). Information is provided by various contributors within the National Environmental Satellite, Data, and Information Service (NESDIS) and the external satellite community. This site provides information of particular interest to users who operate their own direct readout receiving stations.

The NOAASIS is operated by the Satellite Product and Services Division, Direct Services Branch, within the Office of Satellite and Product Operations (OSPO). In addition to providing assistance to the global direct readout community, the Data Services Branch has responsibilities for Search and Rescue Satellite-Aided Tracking (SARSAT) and the GOES and Polar Data Collection Systems (LRIT, GOES DCS, Argos DCS).

URL: <http://noaasis.noaa.gov/NOAASIS/>

For further information, contact NESDIS via email at SPSD.Userservices@noaa.gov, or
Phone: 301-817-4521/4523
Fax: 301-817-3904
Mail:

Direct Readout Services Coordinator
Satellite Products and Services Division

NSOF (E/SPO53)
1315 East-West Hwy
Silver Spring, MD 20910-3282 USA

Celestial World Wide Web site

Operated by T. S. Kelso and has two-line elements only for all NOAA satellites, and many other satellites.

URL: <http://www.celestrak.com>

5.2.1.2 Telephone Bulletin Board Systems (BBS)

This service is obsolete.

5.2.1.3 Amateur Radio Transmissions

The content of the information is obsolete and has been removed.

5.2.1.4 Commercial On-Line Services

The content of the information is obsolete and has been removed.

6.0 INGEST AND PRE-PROCESSING

Operation of the various satellite data processing systems is principally the responsibility of NOAA/NESDIS' Office of Satellite and Products Operations (OSPO). Data were ingested into the former Information Processing Division's Central Environmental Satellite Computer System (CEMSCS) until October 6, 2006. After October 6, 2006 data were ingested into the Data Distribution Server (DDS) from the Satellite Operations and Control Center (SOCC) and from the Shared Processing Network (SPN). The DDS has ingest and preprocessing systems for Polar, Geostationary and Shared Processing. The system described in this document is most relevant to the DDS Polar Data Processing System (PDPS). The PDPS operation consists of components such as pre-launch activities, ingest, pre-processing, calibration, navigation, product generation and archive. Figure 6.0-1 shows the general flow of the polar data through the PDPS system.

NOAA's data levels are defined as follows:

Level 0 - Unprocessed telemetry data as received from the observing platform excluding communications artifacts introduced by the ground system.

Level 1a - Telemetry data that have been extracted but not decommutated from Level 0 and formatted into time-sequenced data sets for easier processing. The Level 1a formats are NOAA's internal formats and are only used for NOAA processing. They only exist briefly for the purpose of creating the Level 1b datasets.

Level 1b - Discrete, instrument-specific data sets derived from Level 1a containing unprocessed data at full resolution, time-referenced, and annotated with ancillary information including data quality indicators, calibration coefficients and georeferencing parameters.

The software systems that are implemented, operated and maintained, are in the following functional categories: Ingest (Level 1a), satellite dataset processing (Pre-Processing Level 1b), product processing, archiving, QC-monitoring, navigation and earth-location, data communications, calibration (pre- and post-launch) and Shared Processing.

Figure 6.0-1. Polar Data Processing Flow

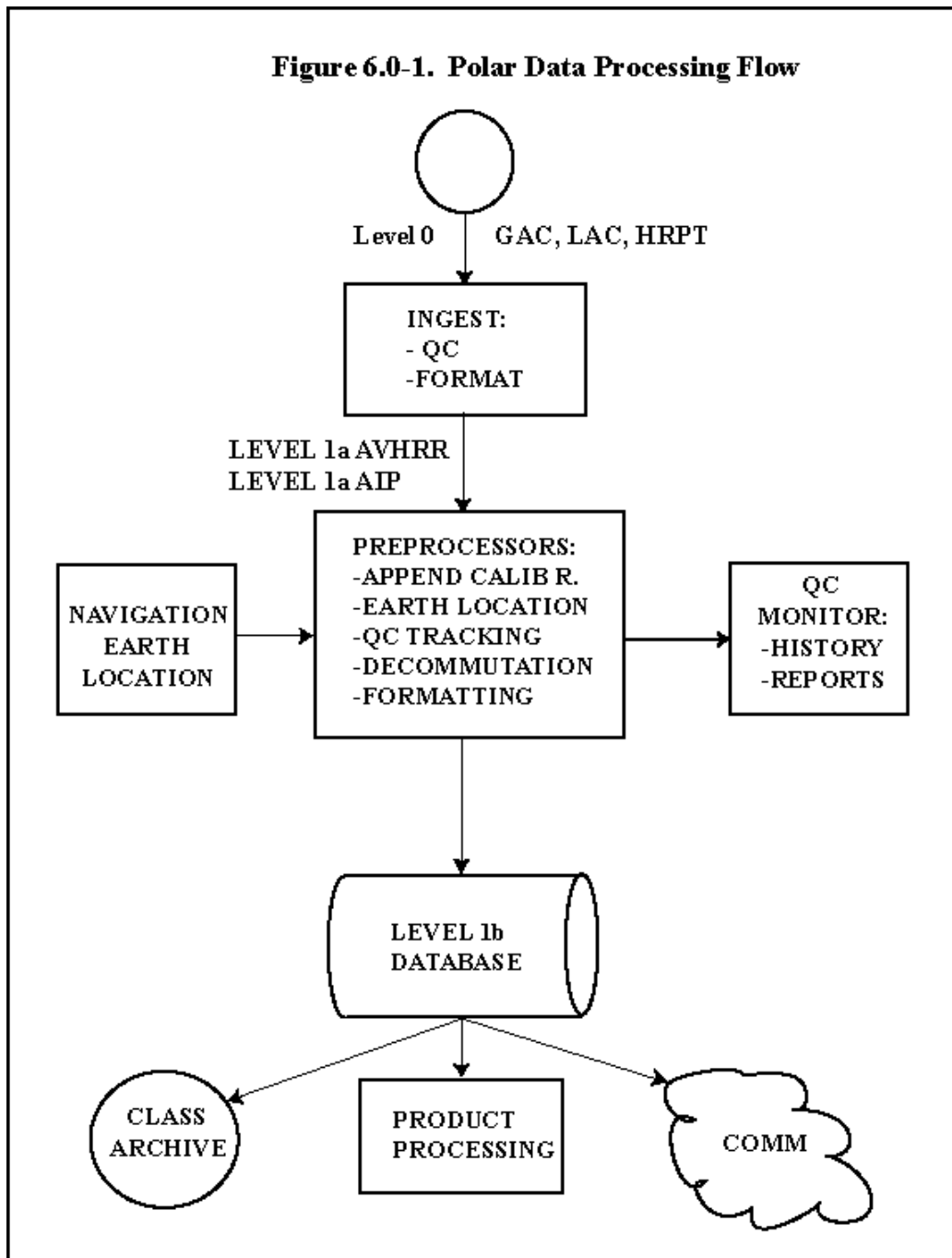

Figure 6.0-1. Polar Data Processing Flow

6.1 INGEST

Special purpose hardware/software is used to receive (ingest) data into the DDS. This software includes polar satellite data, geostationary (GOES) satellite data, and Shared Processing data as received from, or transmitted between, the NESDIS and either the Air Force Global Weather Central (AFGWC) or the Navy Fleet Numerical Meteorological and Oceanographic Center (FNMOC).

Basically, the ingester accomplishes the function of transforming the satellite Level 0 to a more processing friendly Level 1a data set as follows:

1. Accepts and synchronizes frames of Level 0 satellite data.
2. First level quality control of data stream, filling data gaps as necessary. Generation and forward of a data quality/status file.
3. Extracting AVHRR and AIP data from Level 0 data and formatting to a Level 1a. These two data sets are made available for the process of Level 1b transformation.
4. Generation of a unique data set name which includes an orbit number and time duration of the pass.

6.2 PRE-PROCESSING

Data pre-processing is a set of functions which combine to create the Level 1b databases. The software formats, error checks, calibrates, and appends earth locations and otherwise manages the ingested data. Raw spacecraft data are processed via Polar Acquisition and Control Subsystems (PACS) and made available to the Pre-Processing operation via the Ingest System as Level 1a data sets. The transformation of ingested data of Level 1a format into one or more data sets of Level 1b format primarily consists of the addition of instrument calibration coefficients and earth location information to the raw data stream. The transformation also provides supplemental data about the calibration process and thus indirectly about the instruments onboard the satellite. Data in the Level 1b format are made accessible for products, archival, file transfer and are used by the meteorological and Climatological communities.

6.2.1 SYSTEM IMPROVEMENTS

The pre-NOAA KLM series of TIROS polar spacecraft have retained the same basic format of raw data streams for over 20 years. The NOAA KLMNN' series have undergone several format changes and somewhat larger volumes of data. The NOAA KLM Pre-Processing system has processed both old and new spacecraft data. The software is modular and structured to allow platform independence. Program structures have been designed to take advantage of modern operating systems with distributed processing providing faster availability of data products.

6.2.2 LEVEL 1b DATABASE IMPROVEMENTS

Enhancements have been made to the methods of access and storage of the Level 1b data. With the old system (pre-NOAA KLM), a change made in spacecraft or instrument configuration, would result in a change in the format of the encapsulation of the Level 1b data. When such a change was made in the up-front systems, the change had to ripple to the end user. A new Level 1b generating system (Level 1b*) provides a centralized database which contains the basic elements of the Level 1b and the associated supporting ancillary data. The database provides end-to-end accountability for data and data products to managers and users. The new system (Level 1b*) provides a universal access to the component elements of the dataset, thus providing transparency to the Level 1b format. Access to the Level 1b* database is facilitated by a library of utilities layered in a tree structure.

The facilities and services provided by the Level 1b* offers a means of simplifying and improving the interfaces of the Calibration Monitoring System. Specifically, these interfaces are between the Pre-processing input to the monitoring and monitoring output of status reporting to the users. The calibration process performed by the Pre-Processor passes resulting parameters to the offline monitoring system. The parameters transit an interface referred to as History Files. The Level 1b* database library has structures and utilities defined specifically to contain and access the information sent to the History File. This provides for a modifiable and maintainable system that is much more flexible than the old version.

6.3 CALIBRATION

Calibration and Data Monitoring consist of three software systems residing on the DDS:

- Pre-launch calibrations,
- Online instrument data calibration and monitoring
- Engineering evaluation.

6.3.1 PRE-LAUNCH CALIBRATION

The pre-launch calibration is the process which prepares the operational data pre-processing systems for new satellites and their instruments. This includes validation of instrument supplier's success in meeting instrument performance requirements. Each instrument manufacturer is required to supply parameters related to the characteristic performance of the instrument. Instrument Specifications are then validated with the accomplishment of: calculating the calibration accuracy; the instrument sensitivity; in-flight warm load; calibration correction factors; the calibration repeatability; and nonlinearity parameter for each channel. A report is generated which contains the plots of all thermal vacuum data derived quantities for each flight model, as well as a narrative description of how each quantity is computed.

6.3.2 ON LINE CALIBRATION

As part of normal operations, the data preprocessing software performs online instrument data calibration and monitors instrument telemetry to detect anomalies. When anomalies are detected, the data is flagged as suspect for the product systems.

6.3.3 CALIBRATION EVALUATION

Engineering evaluation is carried out as part of off-line support. The data calibration process is evaluated to provide evidence of instrument performance problems. This includes extracting selected data words, computing statistics and displaying/printing the information for analysis.

6.4 MONITORING AND QUALITY ASSURANCE

Monitoring software examines the real-time operation of the software system or performance of an instrument and generates operator error messages, statistics and reports. Comparison with appropriate "truth" data is also required in the monitoring system. Printouts and/or interactive data displays are examined for credibility.

7.0 CALIBRATION OF NOAA KLM INSTRUMENTS

The calibration of a satellite radiometer involves finding the transfer function between digital counts from the instrument and the scene input spectral radiance for all the instrument's spectral channels.

In the infrared region of the spectrum, calibration is accomplished by using accurate blackbodies in a thermal/vacuum (T/V) environment. A T/V chamber is used to avoid atmospheric effects and to better simulate the space environment in which the instrument must ultimately operate. The T/V chamber contains accurate extended area blackbody cavities which are used as infrared sources. Calibration traceability to the National Institute for Standards and Technology (NIST) is via the temperature of the blackbody.

In the visible region, calibration is performed on a test bench. No significant errors are introduced by performing the calibration in this manner. The laboratory source most used to calibrate visible channels is an integrating sphere. The integrating sphere is the device used to create a visible radiance which is traceable to the NIST. Calibration of the AVHRR and HIRS visible channels uses one 102 cm (40-in) sphere exclusively in order to aid inter-instrument calibration consistency.

In the ultraviolet region, calibration is performed using several calibrated standard lamps; a quartz-halogen lamp for use in the 250-400 nm range, an argon mini-arc for the 160-280 nm range and a deuterium (D₂) lamp covering the total spectral range. In the microwave region, calibration is performed in a T/V environment using calibrated blackbody radiometric sources.

Calibration updates to characterize the in-orbit performance of the visible and near-infrared channels of the AVHRR are introduced in the Level 1b data when necessary by NESDIS. The historical visible calibration notices are available under the NESDIS Special Bulletins section at <http://www.ssd.noaa.gov/PS/SATS/bulletins.html>.

The SEM-2 TED and MEPED responses are calibrated with particle (proton and electron) beams, with the results summarized in a Calibration Report for each instrument. The TED calibrated responses vary slightly from unit to unit, since the Continuous Dynode Electron Multiplier (CDEM) detectors have slightly varying detection efficiencies. The MEPED particle responses are essentially identical for all units. The TED and MEPED also have In-Flight Calibration cycles which verify the stability of the electronic gains, thresholds, channel logic, and detector noise.

7.1 AVHRR

The NOAA KLM Advanced Very High Resolution Radiometer, Version 3 (AVHRR/3), differs from AVHRR Versions 1 and 2 flown on the earlier POES satellites. The AVHRR/3 is a six channel instrument, with three of the channels located in the visible and near-infrared regions of the spectrum, having effective wavelengths around 0.63 micrometers (channel 1), 0.86 micrometers (channel 2) and 1.6 micrometers (channel 3A), while the remaining three are located in the atmospheric window regions in the infrared with effective wavelengths centered around 3.7 micrometers (channel 3B), 10.8 micrometers (channel 4) and 11.5 micrometers (channel 5). Since quantitative radiometric applications of the AVHRR radiance measurements have become increasingly important both in research and operational environments, it has been

necessary to accurately calibrate the sensors in order that the AVHRR radiance measurements meet the stringent performance requirements necessitated by the accuracy requirements of the products derived from these radiances. For example, accuracies on the order of less than 2% are desired in the AVHRR radiances measured in channels 1, 2 and 3A. These radiances are used for improving the accuracy of atmospheric aerosol retrievals over the oceans in order that they may be used with confidence in atmospheric energy studies. Similarly, the well established need that sea surface temperatures determined using the brightness temperatures measured in channels 3B, 4 and 5 should be accurate to within a few tenths of a degree Kelvin for use in climate and global change studies. This need necessitated development of user friendly correction procedures for the non-linearities associated with the AVHRR thermal infrared channels and also imposes stringent requirements on the allowable noise-equivalent temperatures associated with the same.

Against this background, the procedures for the pre- and post-launch calibration of the different AVHRR channels are described. This description is based on the work performed at the NOAA/NESDIS Center for Satellite Applications and Research (STAR) and on the material furnished by ITT Aerospace/Communications Division, Fort Wayne, Indiana (the instrument manufacturer).

7.1.1 Visible and Near-Infrared Channels

7.1.1.1 Pre-launch Calibration

The visible and near-infrared channels of the AVHRR/3 were calibrated prior to launch at the facilities of ITT, following a protocol which has evolved over the past two decades. A 102 cm (40 in) diameter integrating sphere is used as the source of illumination. The integrating sphere is equipped with seventeen 45-W lamps and three 150-W lamps mounted in a ring pattern. The radiance emerging from the integrating sphere port which has a diameter of 35.6 cm (14 in), can be varied over three orders of magnitude by illuminating the sphere with a suitable combination of the various lamps. A separate 11.4 cm (4.5 in) diameter integrating sphere, equipped with a 45-W lamp and an aperture wheel, is used as the source when lower levels of illumination are desired. The level of illumination is varied in twenty-five steps for channel 1; sixteen steps for channel 2; and 11 steps for channel 3A. At each level of illumination of the integrating sphere, 3600 measurements of the signal issuing from the AVHRR when it views the sphere and the space clamp target are made, and the mean and standard deviation recorded, and converted to digital counts on a 10-bit scale. Generally, the AVHRR signals when it views the integrating sphere with all of the lamps turned off, and when it views the space clamp target (essentially a blackbody) are very close to each other.

The integrating sphere is periodically calibrated for its spectral output and linearity with an Optronic Laboratories Model OL750S Automated Spectroradiometer System and an Optronic Laboratories Model OL410 Integrating Sphere Standard; the Integrating Sphere Standard is traceable to radiance standards maintained at NIST. The uncertainty in the calibration of the 102 cm (40 in) integrating sphere source is estimated to be of the order of 5%.

It should be noted that the AVHRRs were calibrated at intervals not to exceed one year, until

they were launched. The last calibration was performed as close to the launch as practicable. Greater details of the pre-launch calibration of the AVHRR are found in Rao (1987).

It is the usual practice in NOAA to give the pre-launch calibration results in the form of a simple linear regression relationship between the measured AVHRR signal, C_{10} , expressed in ten-bit counts, and the albedo, A , of the integrating sphere source at different levels of illumination.

Thus,

$$A \equiv SC_{10} + I \quad (7.1.1.1-1)$$

Where S is the slope (percent albedo/count) and I is the intercept (percent albedo) listed in the Level 1b data under the heading “pre-launch”. **It should therefore be noted that the use of these slope and intercept values with the measured AVHRR will yield the albedo in percent under the assumption that the pre-launch calibration is valid in orbit.**

The albedo A (or the reflectance factored or scaled radiance) of the Earth scene is given by:

$$A(\text{percent}) = \frac{100\pi I}{F} \quad (7.1.1.1-2)$$

Where I and F are, respectively, the in-band radiance ($\text{W m}^{-2} \text{sr}^{-1}$) of the Earth scene and the extraterrestrial solar irradiance (W m^{-2}) at normal incidence at the top of the atmosphere at mean Earth-Sun distance, I and F are given by:

$$I = \int_{\lambda_1}^{\lambda_2} I_{\lambda} \tau_{\lambda} d\lambda \quad ((7.1.1.1-3)$$

And

$$F = \int_{\lambda_1}^{\lambda_2} F_{0\lambda} \tau_{\lambda} d\lambda \quad (7.1.1.1-4)$$

where τ_{λ} is the normalized response of the instrument at the wavelength λ , I_{λ} is the radiance ($\text{W m}^{-2} \text{sr}^{-1} \text{:m}^{-1}$) and $F_{0\lambda}$ is the extraterrestrial solar irradiance ($\text{W m}^{-2} \text{:m}^{-1}$) at the wavelength λ ; where λ_1 and λ_2 are the lower and upper cut-off wavelengths of the channel. Other quantities are the equivalent width ω (:m) and the effective wavelength λ_e given by:

$$\omega = \int_{\lambda_1}^{\lambda_2} \tau_{\lambda} d\lambda \quad (7.1.1.1-5)$$

And

$$\lambda_e = \frac{\int_{\lambda_1}^{\lambda_2} \lambda F_{0\lambda} \tau_{\lambda} d\lambda}{F} \quad (7.1.1.1-6)$$

It should be noted that the albedo calculated using Equation 7.1.1.1-2 shows a small but finite

variation with the extraterrestrial solar irradiance spectra used in the calculation of F. It is thus preferable to work with the in-band radiance I or the radiance I_8 ; however, these quantities are not included in the Level 1b data stream.

A salient feature of the AVHRR/3 is the use of dual gain detection circuitry in the visible and near-infrared channels to enhanced radiometric resolution at the lower end of the dynamic range of the albedo; this results in minor losses in resolution at the higher values of albedo. The dual gain settings for channels 1, 2 and 3A are given in Table 7.1.1.1-1 below.

Table 7.1.1.1-1. Dual Gain Ranges for the Visible and Near-Infrared Channels of the AVHRR/3 (Nominal Specifications)		
Channel	Albedo range (percent)	Counts
1 and 2	1-25	0-500
	26-100	501-1000
3A	1-12.5	0-500
	12.6-100	501-1000

The dual gain feature necessitates the use of two sets of slope and intercept values for channels 1, 2 and 3A to accommodate the two gain ranges. Thus, the Level1b data has, in addition to the prelaunch calibration coefficients, two sets of slope and intercept values for each of the three channels based on post-launch calibration (see next section). These are listed under the heading “operational” in the Level 1b data stream.. As mentioned earlier, since these slope and intercept values are in the albedo (or reflectance factor or scaled radiance) representation, use of the same with the AVHRR Earth scene signal will yield the albedo (in percent). The dual gain cross-over point is defined as the count value at which both the high and low range regression equations for the albedo A will yield the same value of the albedo. The cross-over point was determined using the pre-launch integrating sphere and the electronic calibration ramp. The user can find the slope and intercept values, and the values of F, ρ_0 , and δ_e in Appendix D.

7.1.1.2 Post Launch Calibration

The visible and near-infrared channels of the TIROS-N series of AVHRRs were known to degrade in orbit and similar degradations were observed in Channels 1, 23a of the NOAA KLM AVHRR/3.

The absence of on board calibration devices for these channels necessitated the development of vicarious techniques for post-launch calibration. Accordingly, vicarious calibration techniques that have been developed (e.g. Rao and Chen 1995) to characterize the post-launch performance of Channels 1 and 2 of the TIROS-N AVHRRs, were adapted to the AVHRR/3. These techniques use radiometrically stable terrestrial calibration target sites and congruent path aircraft/satellite measurements to monitor the calibration of the instrument as a function of time. These techniques have been modified to account for the split-gain feature of the instrument.

7.1.2 Thermal Infrared Channels (channels 3B, 4 and 5)

7.1.2.1 Pre-launch Calibration

Pre-launch calibration of the infrared channels was carried out in a thermal vacuum chamber to simulate conditions in space. The radiometer sequentially views three blackbody targets, a cold target ($\approx 95K$) representing cold space, an external laboratory blackbody representing “Earth”, and its own warm blackbody, the internal calibration target (ICT). The sequence is the same as show in Figure 7.1.2.2-1. All blackbody sources have calibrations traceable to NIST. The internal and external blackbody temperatures are measured by Platinum Resistance Thermometers (PRTs). From these temperatures, AVHRR radiances for each thermal channel are computed. The AVHRR outputs 10-bit count values, integers in the 0-1023 range. The detection circuits for these channels are such that count output increases when incoming radiance decreases.

The entire pre-launch calibration test cycle was repeated on three, four or five separate days. Each day, the instrument operating temperature (measured by the PRTs) was fixed at a different value in the 10, 15, 20, 25 and 30C range for the entire cycle. This range brackets the range of operating temperatures encountered in orbit. For each calibration run, temperature (radiance) and count data were collected as the laboratory blackbody cycled through 15-17 temperature plateaus between 180 K and 335 K, which spans the entire range of Earth target temperatures.

7.1.2.2 In-orbit Calibration Overview

During each in-orbit scan line, the AVHRR views three different types of targets, as shown in Figure 7.1.2.2-1. It first outputs 10 counts when it views cold space, then a single count for each of the 2,048 Earth targets (pixels), and finally 10 counts when it views the internal blackbody target. (Only the AVHRR scan mirror actually rotates). The cold space and internal blackbody target views are used to calibrate the AVHRR, because a radiance value can be independently assigned to each target.

Figure 7.1.2.2-1. AVHRR Thermal Channel Calibration Sequence.

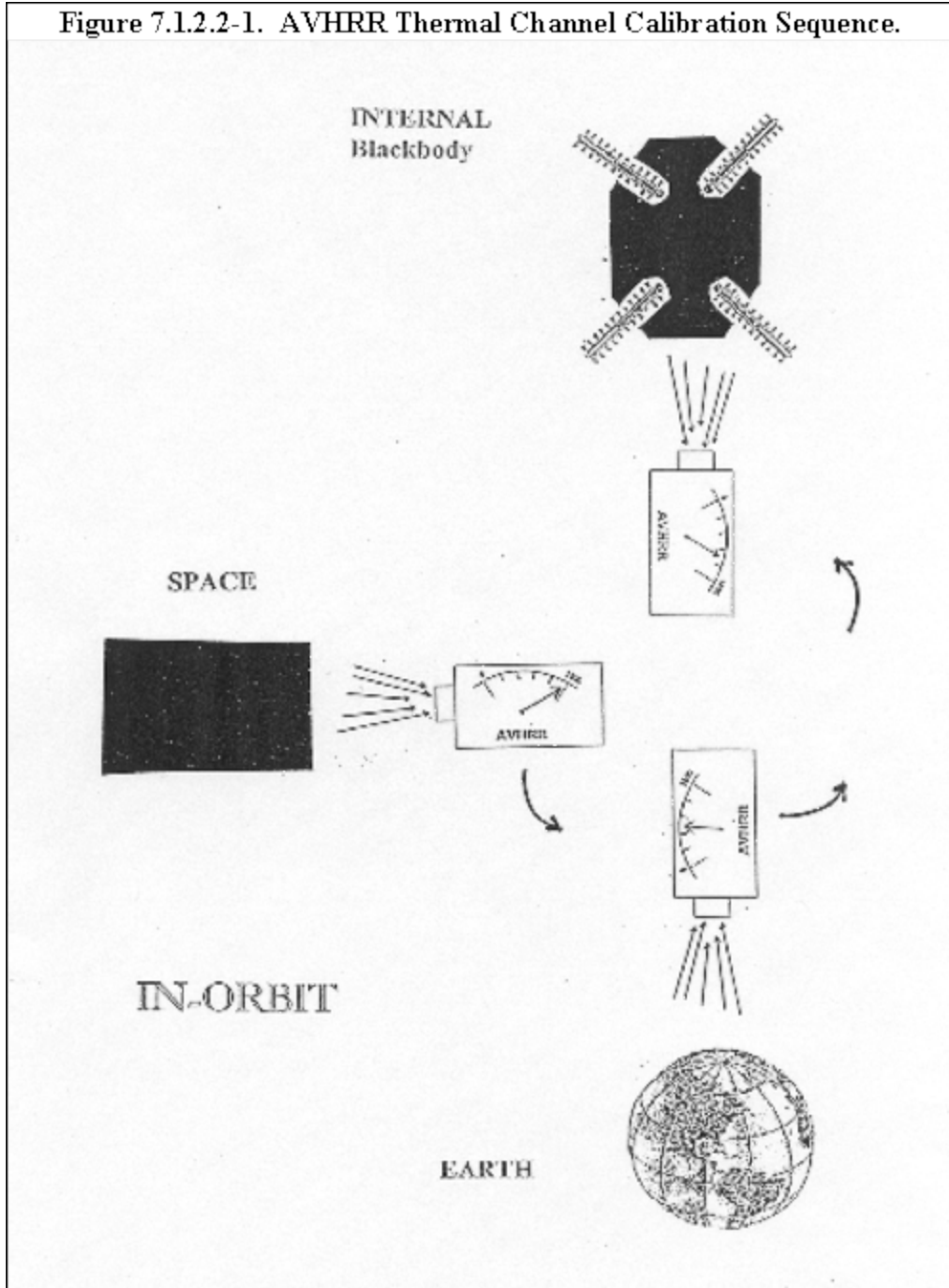

Figure 7.1.2.2-1. AVHRR Thermal Channel Calibration Sequence

The internal blackbody temperature T_{BB} is measured by four Platinum Resistance Thermometers (PRTs) embedded in the AVHRR instrument. The radiance N_{BB} received by the AVHRR from the internal blackbody in each thermal channel is computed from T_{BB} the spectral response (filter) function of each channel. The radiance of space value N_S , designed to accurately account for pre-launch information, and is computed from pre-launch data. These radiances, together with the average space count C_S and average blackbody count C_{BB} provide two points (C_{BB} , N_S) on the radiance versus count graph. A straight line drawn between the two points generates the

linear radiance versus count estimate. The AVHRR count output C_E from viewing an Earth target is substituted into the linear equation and produces linear radiance N_{LIN} . Pre-launch measurements indicate that the actual radiance versus count graph is quadratic so N_{LIN} is input into a quadratic equation, defined by pre-launch measurements, to give the nonlinear radiance correction N_{COR} . The incoming radiance N_E from the Earth target that causes AVHRR output count value C_E is found by adding N_{COR} to N_{LIN} . An equivalent blackbody temperature T_E can be computed from Earth radiance value N_E .

7.1.2.3 Steps to Calibrate the AVHRR Thermal Channels (Level 1b Data Users)

Starting with the NOAA-15 (NOAA-K) satellite, NESDIS incorporated the nonlinear radiance corrections for AVHRR thermal channels 4 and 5 into the Level 1b data stream. The corrections are in the GAC and LAC datasets, and also in the HRPT datasets produced operationally by NESDIS. Users compute the scene radiance, N_E in units of $mW/(m^2-sr-cm^{-1})$ from the 10-bit earth-scene count, C_E , by the formula:

$$N_E = a_0 + a_1 C_E + a_2 C_E^2 \quad (7.1.2.3-1)$$

There is one set of coefficients for each thermal channel 3B, 4 and 5 in the NOAA KLM Level 1b dataset. The channel 3B detector responds linearly to incoming radiance so for channel 3B the coefficient a_2 will always be 0. Section 8 contains format information about how the Level 1b data are stored. The coefficient a_0 for AVHRR channel 4 is specified as "IR Operational Cal Ch4 Coefficient 1"; etc

As a numerical example, suppose $C_E = 410$ for Channel 4, and $a_0 = 155.58$, $a_1 = -0.1668$ and $a_2 = 0.000010$, then,

$$N_E = 155.58 - 0.1668 \times 410 + 0.000010 \times (410)^2 = 88.9 \text{ mW}/(m^2-sr-cm^{-1})$$

To convert the computed Earth scene radiance value N_E into an equivalent black body temperature value T_E , use the two-step process defined by Equations 7.1.2.4-8 and 7.1.2.4-9 in section 7.1.2.4.

The constants for converting radiance to black body temperature are also found in the Level 1b LAC and GAC Header Records, but in a slightly different form. In Tables 8.3.1.3.2-1 and 8.3.1.4.2-1 (for LAC and GAC data, respectively), under the heading radiance conversion (octets 281-328), channels 3B, 4 and 5 each have three sets of constants; these constants are called central wavenumber, constant1 and constant2. The central wavenumber value Λ_c is used in Equation 7.1.2.4-8 to calculate T_E^* , and the blackbody temperature T_E is computed by the formula:

$$T_E = \text{constant1} + (\text{constant2}) T_E^*$$

7.1.2.4 Steps to Calibrate the AVHRR Thermal Channels (HRPT Receiving Station Data Users)

Step 1. The temperature of the internal blackbody target is measured by for PRTs. In each scanline, data words 18, 19 and 20 in the HRPT minor frame format contain three readings from one of the four PRTs. (See Section 4.1.3) A different PRT is sampled each scanline; every fifth scanline all three PRT values are set equal to 0 to indicate that a set of four PRTs has just been sampled. The count value C_{PRT} of each PRT is converted to temperature T_{PRT} by the formula

$$T_{PRT} = d_0 + d_1 C_{PRT} + d_2 C_{PRT}^2 + d_3 C_{PRT}^3 + d_4 C_{PRT}^4 \quad (7.1.2.4-1)$$

The coefficients d_0 , d_1 , d_2 , d_3 and d_4 vary slightly for each PRT. Values for the coefficients are found in Appendix D, in Table D.1-8 for NOAA-15 (coefficients d_3 and d_4 are 0 for NOAA-15), Table D.2-9 for NOAA-16, Table D.3-3 for NOAA-17 and Table D.4-3 for NOAA-18. To calculate the internal blackbody temperature T_{BB} , NESDIS uses the simple average

$$T_{BB} = \frac{(T_{PRT1} + T_{PRT2} + T_{PRT3} + T_{PRT4})}{4} \quad (7.1.2.4-2)$$

Step 2. The radiance N_{BB} sensed in each thermal AVHRR channel from the internal blackbody at temperature T_{BB} is the weighted mean of the Planck function over the spectral response of the channel. The spectral response function for each channel is measured in approximately 200 wavelength intervals and provided to NESDIS by the instrument manufacturer. In practice, a look-up table relating radiance to temperature is generated for each channel. Each table specifies the radiance for every tenth of a degree (K) between 180 and 340K. The tables are referred to as “Energy Tables”. It has been found that the following two-step equation accurately reproduces Energy Table equivalent blackbody temperatures to within $\forall 0.01K$ in the 180 to 340K range. Each thermal channel has one equation, which uses a centroid wavenumber Λ_c and an “effective” blackbody temperature T_{BB}^* . The two steps are:

$$T_{BB}^* = A + BT_{BB} \quad (7.1.2.4-3)$$

$$N_{BB} = \frac{c_1 \nu_e^3}{\frac{c_2 \nu_c}{e^{T_{BB}^*}} - 1} \quad (7.1.2.4-4)$$

Where the first and second radiation constants are:

$$c_1 = 1.1910427 \times 10^{-5} \text{ mW}/(\text{m}^2\text{-sr-cm}^{-4})$$

$$c_2 = 1.4387752 \text{ cm-K.}$$

The values for Λ_c and the coefficients A and B for channels 3B, 4 and 5 are unique for each spacecraft and are found in Appendix D; Table D.1-11 for NOAA-15, Table D.2-12 for NOAA-16, Table D.3-7 for NOAA-17 and Table D.4-7 for NOAA-18. The single centroid wavenumber for each channel replaces the method for previous AVHRRs, which used a different central wavenumber in each of four temperature ranges. In the previous version of this documentation,

the A coefficients in Tables D.1-11 and D.2-12 were minus numbers and the B coefficients were slightly greater than one. They were used to convert radiance into equivalent blackbody temperature, and converted “effective” temperature T_{BB}^* into T_{BB} , instead of the reverse way as shown in Equation 7.1.2.4-3.

Step 3. Output from the two in-orbit calibration targets is used to compute a linear estimate of the Earth scene radiance N_E . Each scanline, the AVHRR views the internal blackbody target and outputs 10 count values for each of the three thermal channel detectors; these are found in words 23 to 52 in the HRPT data stream. When the AVHRR views cold space, 10 counts from each of the five channel sensors are output and placed into words 52 to 102. (Table 4.1.3-1 describes how these data are multiplexed.) Count values for each channel are averaged together to smooth our random noise; often counts from five consecutive scanlines are averaged because it takes five lines to obtain a set of all four PRT measurements. The average blackbody count C_{BB} and the average space count C_S , together with blackbody radiance N_{BB} and space radiance N_S , explained in the next paragraph, are used to compute the linear radiance estimate N_{LIN} ,

$$N_{LIN} = N_S + (N_{BB} - N_S) \frac{(C_S - C_E)}{(C_S - C_{BB})} \quad (7.1.2.4-5)$$

where C_E is the AVHRR count output when it views one of the 2,048 Earth targets.

The detector in thermal channel 3B has a linear response to incoming radiance so the linear radiance computed from Equation 7.1.2.4-5 is the correct value for channel 3B. For this channel, the radiance of space value N_S is actually = 0; no nonlinear corrections need to be made.

The Mercury-Cadmium-Telluride detectors used for channels 4 and 5 have a nonlinear response to incoming radiance. Pre-launch laboratory measurements show that:

- a. scene radiance is a slightly nonlinear (quadratic) function of AVHRR output count,
- b. the nonlinearity depends on the AVHRR operating temperature.

It is assumed that the nonlinear response will persist in orbit. For the NOAA KLM series of satellites, NESDIS uses a radiance-based nonlinear correction method. IN this method, the linear radiance estimate is first computed using a non-zero radiance of space, the N_S term in Equation 7.1.2.4-5. Then, the linear radiance value is input into a quadratic equation to generate the nonlinear radiance correction N_{COR} :

$$N_{COR} = b_0 + b_1 N_{LIN} + b_2 N_{LIN}^2 \quad (7.1.2.4-6)$$

Finally, the Earth scene radiance is obtained by adding N_{COR} to N_{LIN} ,

$$N_E = N_{LIN} + N_{COR}$$

Introducing the non-zero radiance of space value is a mathematical device which has two primary advantages. First, only one quadratic correction equation per channel is necessary; the

quadratic coefficients are independent of AVHRR operating temperature. Second, the method reproduces pre-launch measurements very well; RMS differences between the fitted data and the measured data are approximately 0.1K for both channels 4 and 5. Values for N_S and the quadratic coefficients b_0 , b_1 and b_2 are found in Appendix D, Table D.1-14 for NOAA-15, and Table D.2-15 for NOAA-16, Table D.3-2 for NOAA-17 and Table D.4-2 for NOAA-18.

Step 4. Data users often convert the computed Earth scene radiance value N_E into an equivalent blackbody temperature T_E . This temperature is defined by simple inverting the steps used to calculate the radiance N_E sensed by an AVHRR channel from an emitting blackbody at a temperature T_E . The two-step process is:

$$T_E^* = \frac{c_2 \nu_c}{\ln \left[1 + \left(\frac{c_1 \nu_c^3}{N_E} \right) \right]} \quad (7.1.2.4-8)$$

$$T_E = \frac{T_E^* - A}{B} \quad (7.1.2.4-9)$$

The values for Λ_c and the coefficients A and B are again found in appendix D; Table D.1-11 for NOAA-15, Table D.2-12 for NOAA-16, Table D.3-7 for NOAA-17 and Table D.4-7 for NOAA-18.

7.1.2.5 Summary of Calibration Equations for HRPT Users

Compute the blackbody temperature:

$$\begin{aligned} T_{PRT1} &= d_0 + d_1 C_{PRT1} + d_2 C_{PRT1}^2 + d_3 C_{PRT1}^3 + d_4 C_{PRT1}^4 \\ T_{PRT2} &= d_0 + d_1 C_{PRT2} + d_2 C_{PRT2}^2 + d_3 C_{PRT2}^3 + d_4 C_{PRT2}^4 \\ T_{PRT3} &= d_0 + d_1 C_{PRT3} + d_2 C_{PRT3}^2 + d_3 C_{PRT3}^3 + d_4 C_{PRT3}^4 \\ T_{PRT4} &= d_0 + d_1 C_{PRT4} + d_2 C_{PRT4}^2 + d_3 C_{PRT4}^3 + d_4 C_{PRT4}^4 \end{aligned}$$

$$T_{BB} = \frac{(T_{PRT1} + T_{PRT2} + T_{PRT3} + T_{PRT4})}{4}$$

Compute the blackbody radiance:

$$T_{BB}^* = A + BT_{BB}$$

$$N_{BB} = \frac{c_1 \nu_e^3}{\frac{c_2 \nu_e}{e^{T_{BB}^*}} - 1}$$

Compute the Earth view radiance using the nonlinearity correction:

$$N_{LIN} = N_S + (N_{BB} - N_S) \frac{(C_S - C_E)}{(C_S - C_{BB})}$$

$$N_{COR} = b_0 + b_1 N_{LIN} + b_2 N_{LIN}^2$$

$$\begin{aligned} N_E \\ = N_{LIN} + N_{COR} \end{aligned}$$

Convert Earth view radiance to equivalent blackbody temperature:

$$T_E^* = \frac{c_2 \nu_e}{\ln \left[1 + \left(\frac{c_1 \nu_e^3}{N_E} \right) \right]}$$

$$T_E = \frac{T_E^* - A}{B}$$

7.2 HIRS/3

For each internal target PRT, the averaged counts are transformed to temperatures by a quadratic relation. The four temperatures, or those that are deemed to be operating properly, are averaged.

For each thermal channel (1-19, or all telemetry channels except number 12) the blackbody radiance can be computed from the Planck relation,

$$r = \frac{c_1 \nu^3}{\left[\exp \left(\frac{c_2 \nu}{T^*} \right) - 1 \right]}$$

using central wavenumbers, Λ , computed prior to the launch of the satellite, and an "apparent" temperature defined by

$$T^* = b + c T$$

where b and c are channel dependent coefficients (the so-called band-correction coefficients) computed before the launch of the satellite, and T is the averaged temperature of the internal target. The two constant terms in the Planck relation is $c_1 = 1.1910659 \times 10^{-5} \text{ mW}/(\text{m}^2\text{-sr-cm}^{-4})$ and $c_2 = 1.438833 \text{ cm-K}$.

During the calibration cycle, the counts for the space and internal target views are each averaged, using a 3σ throw out criterion, over the range of the 56 measurements deemed to be free from scan mirror movement and other unsatisfactory conditions. If any positions are systematically deleted from one, they will also be deleted from the other.

Assuming that radiance can be related to counts through the quadratic:

$$r = a_0 + a_1 C_\Lambda + a_2 C_\Lambda^2$$

where r is radiance, C_v is the output in counts from the view, and a_0 , a_1 and a_2 are constants. Before launch, a_2 is computed and the assumption is made that this is an unchanging characteristic of the channel.

Now the coefficients a_0 and a_1 can be determined. Equation 7.2-3 is applied to the views of space and the internal target, yielding:

$$0 = a_0 + a_1 C_\Lambda + a_2 C_\Lambda^2 \tag{7.2-3}$$

and

$$r_b = a_0 + a_1 C_b + a_2 C_b^2 \tag{7.2-5}$$

where C_s and C_b are the mean counts from the views of space and the internal target, respectively, and r_b is the radiance of the internal target. Or, since a_2 is known,

$$-a_2 C_s^2 = a_0 + a_1 C_s \tag{7.2-6}$$

$$r_b - a_2 C_b^2 = a_0 + a_1 C_b \tag{7.2-7}$$

Then the slope and intercept become:

$$a_1 = \frac{[r_b - a_2(C_b^2 - C_s^2)]}{(C_b - C_s)} \tag{7.2-8}$$

$$a_0 = -a_2 C_s^2 - a_1 C_s \tag{7.2-9}$$

Nominally, the slope and the intercept can be determined from simultaneous views of space and the internal blackbody source. As discussed below, only the intercept varies appreciably

throughout an orbit, the linear and quadratic terms being essentially constant.

The HIRS/3 instrument measures all radiation falling on the detector. That is, it is a total radiometer. To minimize false fluctuations in the signals, the instrument temperature is carefully controlled, so that most optical components experience temperature changes very slowly with respect to the times between calibration cycles (256 seconds). However, the baffle (identified as the secondary mirror) is a blackened light material which is subject to short-term temperature changes from emission or blackbody radiation and absorption of incident radiation from the internal blackbody source (about 280 K), space (2.73 K), and the variable earth views (about 200-275 K plus reflected sunlight). The result is that the contribution by the baffle affects all measurements on a time scale of seconds and this must be accounted for.

At every line, the secondary mirror temperature is linearly interpolated to the midpoint of the radiometric data (beam position 28.5) according to:

$$T_{snn}' = T_{snn-01} + 0.4609(T_{snn} - T_{snn-01}) \quad (7.2-10)$$

where nn is the line number in the superswath (00 to 39), nn-01 is the previous line, and T_s is the measurement of the secondary mirror temperature. In the first line of an orbit the value

$$T_{snn}' = T_{snn} - 0.5391(T_{snn+1} - T_{snn})$$

is used. The interpolated values are preserved during the processing of a superswath (40 values plus the value from the last line of the previous superswath).

It is assumed that the slopes do not change appreciably over a 24-hour period, varying only about one part in 8000 throughout an orbit. During each 24 hours, the slopes are saved (about 19 times 350 values) and are averaged,

$$\overline{a_{100}}'' = \frac{1}{N} \sum_{i=1}^{i=N} a_{li} \quad (7.2-12)$$

where N is the number of slopes, i is an index, and a_1 is a slope defined in Eq. 7.2-8. A 3σ throw-out criterion is used. After the average is computed, the accumulated slopes are purged. The averaged values are used during the next 24 hours, during which a new group of slopes is accumulated (a rotating file is undesirable).

To account for variations in the temperature of the telescope baffle, the intercepts at the time of the calibration are related to the baffle temperature through the relation:

$$a_{000} = b_0 + b_1 T_{s00}' \quad (7.2-13)$$

where T_{s00}' is the interpolated secondary mirror (baffle) temperature in line 00 (space view). The constants b_0 and b_1 are evaluated when this equation is solved by least squares from intercepts and interpolated secondary mirror temperature accumulated during 24 hours (about 350 values of each), using a 3σ throw-out criterion. Only the term b_1 is used hereafter. It is applied during the following 24 hours.

At each calibration cycle, intercepts are recomputed from the mean space counts and the averaged slopes,

$$a_{000}'' = -\overline{a_{100}}'' C_{s00} - a_2 C_{s00}^2 \quad (7.2-14)$$

where the value a_{000}'' is used at the time of the space view, $\overline{a_{100}}''$ is the mean slope, and C_{s00} is the mean of the space counts in line 00.

Only the averaged slopes are applied to the earth-viewing data. The intercepts must be interpolated between calibration cycles by using the secondary mirror temperature:

$$a_{0nn}'' = a_{000}'' + nn \frac{(a_{040}'' - a_{000}'')}{40} + b_1 \left[(T_{snn}' - T_{s00}') - \frac{nn (T_{s40}' - T_{s00}')}{40} \right] \quad (7.2-15)$$

where nn is a scan line number in a superswath numbered 00-39; $nn = 40$ refers to $nn = 00$ of the next superswath.

For partial superswaths at the start and end of an orbit the intercepts are computed according to

$$a_{0nn}'' = a_{0xx}'' + b_1 (T_{snn}' - T_{sxx}') \quad (7.2-16)$$

where the subscript xx refers to the nearest calibration cycle ($xx = 40$ or 00 , respectively).

The initial values of b_1 immediately after launch will be derived from current data from another satellite or will be zeroes (optional). The initial values of the mean slopes immediately after launch will be from another satellite or from data for a single orbit (optional). Data in the Level 1b files derived from use of these initial data will be excluded from the archive; that is, they will be excluded for at least 24 hours after processing begins.

The HgCdTe detector used in the HIRS/3 instrument operates in the photoconductive mode and is slightly nonlinear in its response to radiative flux. Adjustments for nonlinear response are made in Eqs. 7.2-8, 7.2-9, and 7.2-14. The coefficients a_2 are computed from test data taken by the fabricator of the instrument, and will not change throughout the lifetime of the instrument. The combined coefficients will be saved in the Level 1b data and will be applied to earth

measurements.

In summary, for the thermal channels:

a. During an orbit, accumulate

(1) The Channel 1-19 radiances for the blackbody temperatures at the time of the internal target views,

(2) The means and standard deviations of the space counts and the blackbody counts (in scan lines 00 and 01) for each channel, and

(3) The interpolated secondary mirror temperatures (Eqs. 7.2-10 and 7.2-11).

b. Compute the slopes and intercepts from the radiances and counts in according to Eqs. 7.2-8 and 7.2-9. Save both coefficients in temporary 24-hour files, along with the interpolated secondary mirror temperatures.

c. Once per day, compute the relation between intercepts and secondary mirror temperatures from a least-squares solution to Eq. 7.2-13, using a 3σ throw-out criterion.

d. Once per day, compute the average slopes over the previous 24-hour period, using a 3σ throw-out criterion. These are the slopes to be used during the subsequent 24 hours. After steps c. and d., the accumulated slopes will be purged.

e. Recompute the intercepts according to Eq. 7.2-14 at the time of the space views, $n = 00$.

f. Return to the start of the orbit or superswath and interpolate (which requires the recomputed intercept at the next space view) or extrapolate the intercepts for the times of the earth views (lines 02-39) according to Eqs. 7.2-15 or 7.2-16. Note that the starting point for all coefficients is line 00. For an incomplete superswath at the start of an orbit, the reference is line 40 (line 00 of the second superswath).

g. Compute earth-viewed radiances according to Eq. 7.2-3.

The calibration coefficients for Channel 20 (telemetry Channel 12) will be furnished by the fabricator of the instrument and will not change during the lifetime of the satellite.

The mean slopes, the interpolated intercepts, and the quadratic term will be the calibration coefficients appended to scan lines 02-39 of the Level 1b data; the 00 line will have zeroes; and line 01 will have the slope and intercept computed at the time of the calibration, a_{000} " (Eq. 7.2-14). Data encompassing a flagged calibration cycle (the preceding and current superswaths) are considered to be unusable, the calibration coefficients in lines 02-39 will be set to zero, and the Level 1b data will be properly flagged as unusable.

Logical records of Level 1b data will contain an even number of 8-bit bytes, and all logical records in the archive, regardless of purpose, will be the same length.

7.3 AMSU-A and AMSU-B

The Advanced Microwave Sounding Unit-A (AMSU-A) is a fifteen-channel total power microwave radiometer in two separate units: A1 and A2. The AMSU-A2, which has its own antenna system, contains Channels 1 and 2 at 23.8 and 31.4 GHz, respectively. The AMSU-A1, which consists of the two antenna systems A1-1 and A1-2, contains Channels 3-14 in the range of 50.3 - 57.29 GHz and Channel 15 at 89.0 GHz. Between the two antenna systems, A1-2 provides Channels 3, 4, 5, and 8 whereas A1-1 furnishes Channels 6, 7, and 9-15. Each of the AMSU-A antenna systems is required to have a nominal field-of-view (FOV) of 3.3 degrees $\pm 10\%$ at the half-power points and covers a crosstrack scan of ± 48 degrees 20 minutes (to beam centers) from the nadir direction with 30 Earth FOVs per scan line. The data received from the spacecraft will contain separate telemetry for each antenna system. Once every 8 seconds, the AMSU-A measures 30 Earth views, the space view twice and the internal blackbody target twice. Combination of Gunn diode cavity-stabilized and phase-locked loop oscillators (PLLO) are used to provide channel frequency stability. Channels 9-14 have both primary and secondary phase-locked loop oscillators (called PLLO#1 and PLLO#2, respectively) built-in. The PLLO#2 will be used for backup if the PLLO#1 fails. Gunn diode oscillators are used in other channels without backups. The output signals of these radiometric samples are digitized by 15-bit analog-to-digital converters.

The AMSU-B is a five-channel total power microwave radiometer with two channels centered nominally at 89 GHz and 150 GHz, and the other three centered around the 183.31 GHz water vapor line with double-sideband centers located at 183.31 ± 1 , ± 3 , and ± 7 GHz, respectively. AMSU-B has a FOV of 1.1 degrees $\pm 10\%$, and once every 8/3 seconds it measures 90 Earth views, four space views and four internal blackbody target views.

The calibration procedures for the AMSU-A and AMSU-B are the same, except a few minor differences to allow for the separate antenna systems. Table 7.3-1 lists the main differences between the AMSU-A and AMSU-B procedures. Radiances for both AMSU-A and -B Earth views are derived from the measured counts and the calibration coefficients inferred from the internal blackbody and space view data. Both AMSU-A and AMSU-B were tested and calibrated in T/V chambers before launch and the scanings of both instruments are synchronized to an 8-second pulse. Each instrument has four options for the viewing direction of the space view which can be selected by ground command, and one will be chosen immediately after launch. Note: The Calibration Parameters Input Data Sets (CPIDS) are included in the Header Records of Level 1b data according to the Header Record Format.

Table 7.3-1. Differences between the AMSU-A and AMSU-B procedures			
Items	AMSU-A	AMSU-B	Remarks

	A1-1	A1-2	A2		
Number of PRTs in each warm target	5	5	7	7	Internal black body targets
Number of Earth views per scan line	30	30	30	90	In-orbit
Blackbody and space samples	2	2	2	4	Per scan line
Definition of instrument temperature	RF Shelf A1-1	RF Shelf A1-2	RF Shelf A2	Mixer temp. of Ch. 18-20	Available in housekeeping
Backup of instrument temperature	RF Mux A1-1	RF Mux A1-2	RF Mux A2	Mixer temp of Ch. 16	See Note 1.
Secondary PLLO	Ch. 9-14	NO	NO	NO	Backup PLLO

Note 1: These temperatures (available in the housekeeping data) will be used as backups if the primary ones fail.

7.3.1 BLACKBODY TEMPERATURE

The physical temperatures of the internal blackbody targets are measured by Platinum Resistance Thermometers (PRTs). The number of PRTs used to measure the physical temperatures of the internal blackbody targets in each antenna system is given in Table 7.3-1. These PRTs, which were calibrated by individual manufacturers against ‘standard’ ones traceable to NIST, measure temperatures of the internal blackbody targets with an accuracy of $\pm 0.1\text{K}$. The outputs to the telemetry are PRT counts, which must be converted to PRT temperatures. The normal approach for deriving the PRT temperatures from counts is a two-step process, in which the resistance of each PRT (in ohms) is computed by a count-to-resistance look-up table provided by its manufacturer. Then, the individual PRT temperature (in degrees) is obtained from an analytic PRT equation. However, this can be compressed to a single step with negligible errors.

This single step process, which will be used with the NOAA KLM satellites, computes the PRT temperatures directly from the PRT counts, using a polynomial of the form

$$T_k = \sum_{j=0}^3 f_{kj} C_k^j \quad (7.3.1-1)$$

where T_k and C_k represent the temperature and count of the PRT. The coefficients, f_{kj} , will be provided for each PRT. Equation 7.3.1-1 is also used for other housekeeping temperature sensors, such as the mixers, the IF amplifiers and the local oscillators.

The mean blackbody temperature, T_w is a weighted average of all PRT temperatures:

$$T_w = \frac{\sum_{k=1}^m w_k T_k}{\sum_{k=1}^m w_k} + \Delta T_w \quad (7.3.1-2)$$

where m represents the number of PRTs for each antenna system as listed in Table 7.3-1. The w_k is the weight assigned to each PRT and ΔT_w is the warm load correction factor for each channel derived from the T/V test data for three instrument temperatures (low, nominal, and high). Values for ΔT_w will be provided for each instrument. For AMSU-A1-1, ΔT_w values for both PLLO#1 and PLLO#2 will be provided. The w_k value, which equals 1 (0) if the PRT is determined good (bad) before launch, will be provided for each flight model. If any of the PRT temperatures, T_k , differs by more than 0.2K from its value in the previous scan line, then the T_k should be omitted from the average in Equation 7.3.1-2.

Similarly, a cold space temperature correction, ΔT_c , is also provided for processing the in-orbit data. This is due to the fact that the space view is contaminated by radiation which originates from the spacecraft platform and the Earth's limb. Thus, the effective cold space temperature is given by,

$$T_c = 2.73 + \Delta T_c \quad (7.3.1-3)$$

where 2.73K is the cosmic background brightness temperature. The ΔT_c , which represents the contribution from the antenna side lobe interference with the Earth limb and spacecraft, is estimated initially for individual channels, but its optimal value will be determined from post-launch data analysis.

7.3.2 CALIBRATION COUNTS

For each scan, the blackbody counts C_w are the averages of two (four) samples of the internal black body in AMSU-A (AMSU-B). If any two samples differ by more than a preset limit of blackbody count variation ΔC_w (the initial limit is set to 3σ , where the standard deviation, σ , is calculated from the pre-launch calibration data C_w for each channel), the data in the scan should not be used.

Similarly, the space counts C_c are the average of two (four) samples of the space view for AMSU-A (AMSU-B). If any two space view samples differ by more than the preset limit, the data in the scan should be excluded.

To reduce noise in the calibrations, the C_x (where $x = w$ or c) for each scan line will be convoluted over several neighboring scan lines according to a weighting function:

$$\overline{C_x} = \frac{1}{n+1} \left[\sum_{i=-n}^n \left(1 - \frac{|i|}{n+1} \right) C_x(t_i) \right], \text{ counts} \quad (7.3.2-1)$$

the time of the current scan line, one can write $t_i = t_0 + i\Delta t$, where $\Delta t = 8$ seconds for AMSU-A and $8/3$ seconds for AMSU-B. The $2n+1$ values are equally distributed about the scan line to be where t_i (when $i \neq 0$) is the time of the scan line just before or after the current scan line. If t_0 is calibrated. For both AMSU-A and AMSU-B, the value of $n=3$ is recommended.

For the first and the last three scan lines in a file, the convolution of C_x should be omitted and the counts C_x from the individual scan line will replace $\overline{C_x}$. In the case of missing scan lines in the $2n+1$ interval, any one of the remaining scan lines can be selected to replace the missing one(s) in the convolution of C_x . If the gap of missing scans is larger than $2n+1$ (i.e., 7), the convolution process must be terminated at the beginning of the gap and starts anew at the end of the gap.

7.3.3 EARTH VIEW RADIANCES

The following calibration algorithm, which takes into account any nonlinear contribution due to an imperfect square law detector, is employed to convert observed Earth-viewing counts to radiances:

$$R_s = R_w + \frac{C_s - \overline{C_w}}{G} + Q, \frac{mW}{m^2 - sr - cm^{-1}} \quad (7.3.3-1)$$

where R_s is the scene radiance and R_w and R_c are the Planck radiances corresponding to the blackbody temperature T_w and the effective cold space temperature T_c defined in Equations 7.3.1-2 and 7.3.1-3, respectively. The C_s is the radiometric count from the scene (Earth) target. The averaged blackbody and space counts, $\overline{C_w}$ and $\overline{C_c}$, are defined by Equation 7.3.2-1. The channel gain G and the quantity Q , which contains the quadratic contributions, are given by:

$$G = \frac{\overline{C_w} - \overline{C_c}}{R_w - R_c}, \frac{\text{counts}}{mW / (m^2 - sr - cm^{-1})}$$

and

$$Q = u \frac{(C_s - \overline{C_w})(C_s - \overline{C_c})}{G^2}, \frac{mW}{m^2 - sr - cm^{-1}} \quad (7.3.3-3)$$

where u is a predetermined parameter which will be provided at three principal (or backup) instrument temperatures. The u values at other instrument temperatures will be interpolated from these three principal (or backup) values. For channels 9 through 14 (AMSU-A1-1) two sets of the u parameters are provided; one set is for the primary PLL0#1 and the other one for the secondary PLL0#2. The quantity G varies with instrument temperature, which is defined in Table 7.3-1.

For channels 19 and 20 of AMSU-B, the monochromatic assumption breaks down (e.g. channel 20 spans 16 GHz) and a band correction with two coefficients (b and c) has to be applied. These coefficients modify T_w to give an effective temperature T_w'

$$T_w' = b + cT_w$$

which is then used in the Planck function $B(T_w')$ to calculate the radiances for channels 19 and 20. Radiances for all other channels (in both AMSU-A and -B) are computed from $B(T_w)$. The application of Equation 7.3.3-4 is not necessary for the space temperature since the errors in the monochromatic assumption are negligible for such low radiances. For simplification of application, Equation 7.3.3-1 can be rewritten as,

$$R_s = a_0 + a_1 C_s + a_2 C_s^2, \frac{mW}{m^2 - sr - cm^{-1}} \quad (7.3.3-5)$$

The coefficients a_i (where $i=0, 1$ and 2) can be expressed in terms of R_w , G , $\overline{C_w}$ and $\overline{C_c}$. This can be accomplished by rewriting the right-hand side of Equation 7.3.3-1 in powers of C_s and equates the a_i 's to the coefficients of same powers of C_s . The results are:

$$a_0 = R_w - \frac{\overline{C_w}}{G} + u \frac{\overline{C_w C_c}}{G^2}, \frac{mW}{m^2 - sr - cm^{-1}} \quad (7.3.3-6)$$

$$a_1 = \frac{1}{G} - u \frac{\overline{C_c} + \overline{C_w}}{G^2}, \frac{mW}{(m^2 - sr - cm^{-1})count} \quad (7.3.3-7)$$

and

$$a_2 = u \frac{1}{G^2}, \frac{mW}{(m^2 - sr - cm^{-1})count} \quad (7.3.3-8)$$

These calibration coefficients will be calculated for every scan line at each channel and appended to the Level 1b data. With these coefficients, Equation 7.3.3-5 can be used to obtain the scene radiance R_s . It should be noted that the coefficients defined in Equations 7.3.3-6 to 7.3.3-8 are functions of instrument temperature. Therefore, they are, in general, not constant and should be recalculated for each scan. Users who prefer brightness temperature instead of radiance, can make the simple conversion,

$$T_s = B^{-1}(R_s) \quad (7.3.3-9)$$

where $B^{-1}(R_s)$ is the inverse of the Planck function for a radiance R_s . The T_s is the corresponding brightness temperature (or radiometric temperature). However, the conversion (Equation 7.3.3-9) is not performed in the NOAA Level 1b data. Note that for AMSU-B channels 19 and 20 the band correction coefficients must also be applied as follows:

$$T'_s = \frac{T_s - b}{c} \quad (7.3.3-10)$$

where T'_s corresponds to the brightness temperature of channel 19 or 20.

7.3.4 POST LAUNCH EVALUATION AND CALIBRATION

The procedures and formulas described in the above sections were primarily derived from the pre-launch analysis of the AMSU-A and -B calibration data from T/V chambers. Post launch evaluation and calibration have been extensively carried out with overall favorable results. In one report published by Tsan Mo (1999), the findings showed that the radiometric counts and channel gains correlate linearly with the instrument temperature. The NE(Delta) T values calculated from the AMSU- A 1B data compare favorably to those obtained from the pre- launch test data. All channels on the NOAA-15 AMSU-A have functioned well since its powering up after launch, except Channel 14 which has shown an anomalous behavior since early January 1999. The full report can be accessed from the SPIE Digital Library at <http://proceedings.spiedigitallibrary.org/proceeding.aspx?articleid=994440>.

Numerous products have been created over the years reflecting the success of the AMSU instrument.

7.4 SBUV/2

The objective of the calibration program is to achieve a state-of-the-art calibration of the SBUV/2 instrument including response to spectral radiance, response to spectral irradiance, ratio of radiance-to-irradiance responses, and the temperature dependence of response. Continuity of this calibration has been maintained throughout the series.

7.4.1 SBUV/2 CALIBRATION OVERVIEW

Each SBUV/2 instrument consists of a nadir-viewing double monochromator of the Eber-Fastie type, and a cloud cover radiometer (CCR, a filter photometer). A photomultiplier tube detects light exiting the monochromator. They are designed to measure the ratio of backscattered ultraviolet solar radiance to solar irradiance. The SBUV/2 instruments can measure from 152.71 to 443.35 nm in steps of 0.07 nm with a bandpass of 1.1 nm. During normal operation, the backscattered radiance from the nadir is measured at 12 near-UV wavelengths from 252 to 340 nm about 100 times per orbit on the sunlight portion. Light coming into the instrument is first depolarized to remove instrument sensitivity to the polarized backscattered radiances. The CCR makes measurements at 379 nm with a bandpass of 3 nm, and is used to detect scene reflectivity changes during a scan. A diffuser plate is periodically deployed to measure the solar irradiance at the same 12 wavelengths. The instrument is also equipped with a Mercury calibration lamp to monitor both the wavelength scale of the monochromator grating and any degradation of the diffuser.

SBUV/2 instruments use three overlapping gain ranges to measure the solar and Earth radiation which varies over six orders of magnitude. Gain ranges 1 and 2 originate from the photomultiplier anode, while gain range 3 originates from the cathode which allows direct measurement of the instrument's gain. This design differs from SBUV where the anode was the source of all output ranges. For SBUV/2, measurements from the Earth and sun are output on different electronic gain ranges at shorter wavelengths and high solar zenith angles; therefore the instrument's electronic gain is not always canceled in the albedo ratio. The photomultiplier gain (called the interrange ratio, IRR) must be monitored and carefully evaluated over time for accurate long term measurements.

The objective of the calibration program has been to achieve a state-of-the-art calibration of the SBUV/2 instrument including response to spectral radiance, response to spectral irradiance, ratio of radiance to irradiance responses, and the temperature dependence and linearity of the response. Continuity of this calibration has been maintained throughout the series of the operational instruments. Ozone profiles and total amounts are derived from the ratio of the observed backscattered Earth spectral radiance to the incoming solar spectral irradiance. This ratio is proportional to the Earth's geometrical albedo. The only difference in the radiance and irradiance observations is the instrument diffuser used to make the solar irradiance measurement; the remaining optical components are identical. Therefore, the principle changes in the instrument that result in a change in the measured albedo over time are the diffuser reflectivity and the gain range ratios.

7.4.2 COMPONENT CALIBRATION

The spectral efficiency of each optical component of the SBUV/2 instrument is measured by the suppliers in the course of their acceptance testing. This demonstrates that specifications have been met. Also, it allows prediction of the eventual spectral transmittance of the system. If there is a need, the component efficiency tests can be repeated. Monitor (witness sample) mirrors accompany the instrument optics throughout the program and will be periodically tested for spectral reflectivity.

At the subsystem level of assembly, additional procedures and tests are carried out that support

the final calibration. The depolarizer is tested by measuring the residual polarization of initially polarized light after it has passed through the depolarizer. System linearity and dynamic range tests are done before the calibration lamp and diffuser assemblies are installed. Wavelength calibration, bandpass, instrument profile and spectral resolution tests are done with the calibration lamp installed, but before the diffuser assembly is installed. After integration of the complete instrument, but before the formal verification testing begins, a series of checks are run during which final adjustments are made. During this process, the optical alignment is measured and adjusted if necessary, and all field-of-view (FOV) related tests performed, since the same fixture is used for all FOV related tests. FOV test include: size, shape and uniformity of both monochromator and CCR (cloud cover radiometer or photometer) fields and their coincidence. Out-of-band rejection and stray light tests are conducted at this stage. Finally, the first radiance/irradiance response tests are run in air, establishing a baseline to which subsequent tests can be compared.

During environmental testing, after the vibration sequence, the radiance/irradiance response in air is measured and the alignment and FOV checks are made. The definitive radiometric calibration is done just prior to T/V testing. During T/V, the spectral radiometric calibration is extended to the required temperature plateaus and down to 160nm using the Vacuum Test fixture (VTF). The calibration transfer standard sources are returned to NIST for recalibration as necessary to allow the closest possible interpolation between standardizations. During T/V testing, the monochromator wavelength scale change with temperature, if any, is measured.

7.4.3 RADIANCE AND IRRADANCE CALIBRATION

In calibrating the Earth Viewing (radiance) mode of operation, the target seen by the instrument is a calibrated reflectance diffuser illuminated by collimated light from a NIST calibrated source of spectral irradiance. The absolute value of the radiance of the test diffuser is a function of the same source irradiance, the efficiencies of the intervening components and their geometries.

In calibrating the radiance-to-irradiance ratio, the set-up is fixed and the test diffuser and the instrument diffuser are alternately placed in the light path. The filter detector monitor measures relative irradiance I the incoming beam in three broad wavelength bands centered around 180, 250 and 300 nm. If the filter detector monitor and the instrument indicate a decrease in signal from all light sources, the windows and collimating mirrors are checked for efficiency. By swinging the filter detector monitor so that it views the diffuser, a relative efficiency measurement of either diffuser can be obtained. In this way, any changes in the diffusers can be detected during testing. The filter detector monitor uses a quartz windowed bi-alkali photodiode, the type used for the detectors. It is used for relative monitoring measurements only.

The instrument is designed to respond in proportion to the spectral radiance, ($\text{mW}\cdot\text{m}^{-2}\cdot\text{sr}^{-1}\cdot\Delta^{-1}$) incident upon its entrance slit. The area of the entrance slit, the FOV is defined by the field stop, and the bandpass of the monochromator determine the radiant flux, $M(W)$, which enters the system. The system transmission efficiency determines the radiance flux at the photocathode. The quantum efficiency and gain of the detector system determine the final response to a given input. To calibrate this system, standard sources of spectral irradiance that will produce a certain

spectral irradiance ($\text{mW}\cdot\text{m}^{-2}\cdot\text{sr}^{-1}\cdot\Delta^{-1}$) at a given distance under carefully controlled conditions are available.

The approach taken is to use a standard (NIST secondary) spectral irradiance to illuminate a diffuser whose bidirectional reflectance distribution function (BDRF) is accurately known. A collimating mirror is used to achieve a uniformity of irradiance and of angle of illumination at the diffuser. Thus, at given angles of view, the spectral radiance of the diffuser is known, and the instrument response to this radiance is measured. The problem is that all three elements (window, collimating mirror and diffuser) have been interposed between the standard source and each introduces changes into the transfer process. The window and collimating mirror can be measured for spectral transmission and reflectance to within 3% to 1 % errors. This is done before and after each major calibration sequence. In addition, the filter detector monitor will indicate any general change in collimator or diffuser efficiency. Extensive experiments and analysis have demonstrated that radiometric calibration are precise to better than 1% (2Φ). The absolute accuracy of the BDRF values is 3%. Non-linearities, wavelength errors and other instrument factors have uncertainties that are less than 1%.

The test diffuser efficiency is measured by direct comparison to a NIST calibrated standard. This is done in the calibration test fixture using the instrument as the detector. A mask in the collimated beam with a 2.5 cm (1 in) aperture will restrict illumination to a small area of the test diffuser. The NIST standard diffuser is moved in from of the test diffuser so that its efficiency is mapped over it surface.

With the standards of irradiance, the collimator and the test diffuser, the instrument is presented with a diffuse source of known radiance against which its response can be calibrated. To calibrate the irradiance mode of operation, the test diffuser is moved out of the way as the instrument diffuser is deployed. In effect, this compares to the efficiencies of the two diffusers, since their interchange is the only difference in the two measurements.

The result of the radiometric calibration is a function that assigns a calibration constant, K_E , for irradiance to each instrument wavelength, λ , given by:

$$K_E(\lambda) = \frac{E_{dk}(\lambda)}{CC_E(\lambda)} \quad (7.4.3-1)$$

where E_{dk} is the test fixture irradiance, and CC_E is the corrected count rate or instrument signal. Similarly, the calibration constant for radiance, K_L , is given by:

$$K_L(\lambda) = \frac{L_{dk}(\lambda)}{CC_L(\lambda)} \quad (7.4.3-2)$$

where E_{dk} is the test fixture radiance and CC_L is the corrected count rate or instrument signal.

Integrating spheres are also used to calibrate the SBUV/2 instruments. Comparison of integrating sphere and diffuser calibrations has shown agreement of about 1% for Space Shuttle SBUV (SSBUV) and SBUV/2.

The SBUV/2 instrument has four viewing modes (nadir Earth, solar diffuser, lamp diffuser, and lamp direct), but only two are used for radiometric calibration. In orbit, the instrument has a nadir view of the Earth in radiance mode. During ground testing, the sensor module views an illuminated target. In the irradiance mode, the sensor module deploys a reflective diffuser, which is illuminated by the Sun during a portion of the orbit. In ground tests, the diffuser is illuminated by a collimated source. The instrument has two major grating modes for collecting radiance and irradiance data. The first is the step scan mode when 12 channels are scanned from 252 to 340 nm in 32 seconds. The second is the continuous scan (160 nm to 405 nm) mode used for solar irradiance and wavelength calibration. So, there are 4 sets of calibration constants, namely: radiance discrete mode, irradiance discrete mode, radiance continuous mode and irradiance continuous mode.

7.4.4 ADDITIONAL INSTRUMENT CALIBRATION

The spectrometric testing and calibration of the monochromator is done as a subsystem in that the diffuser and depolarizer at the front end are installed. The instrument entrance slit is illuminated via an integrating sphere by various intense line sources and the line positions versus grating positions are recorded. One of the sources is the in-flight Mercury calibration lamp. The integrating sphere fills the optical extent of the monochromator for these tests.

Further calibration information is obtained on the diffuser and gain ranges. The brightness of the diffuser varies with wavelength and illumination angle of the source. A series of measurements of FEL lamp and Mercury Pen Ray lamp are made over the range of expected solar illumination and viewing angles to characterize the diffuser goniometry. The interrange ratios are determined by the ratio of counts in two gain ranges when both ranges have valid data. They are observed to vary as a function of wavelength.

Out-of-band errors are measured pre-flight by viewing the diffuse sky or a diffuser illuminated by the sun at the earth's surface. Tests of current instruments resulted in larger responses in the region below 290 nm than the expected signals would produce. Additional measurements to estimate signal to noise, stray light, out-of-field response, alignment, and stability have been made and are presented in various papers since the launch of NOAA-K.

Full details of each instrument's calibrations are presented in the Specifications and Compliance Calibration Data Books (see Ball 1991) prepared by the instrument contractor.

7.4.5 IN ORBIT CALIBRATION

Once in orbit, the SBUV/2 responses are carefully monitored over time. Hilsenrath et al.(1995) have shown that measured albedo relative to the "day 1" albedo over time is a function

of true change in Earth radiance, diffuser degradation, and interrange ratio (PMT gain). Since the primary measurements are ratios, changes in many of the components will cancel. The diffuser plate is used only for the solar irradiance measurements. Accurate characterization of its degradation is required to maintain calibration. This is accomplished by using an on-board Hg calibration lamp. The lamp is alternately viewed directly and indirectly by illuminating the diffuser. Diffuser degradation is monitored at six mercury lines spanning 185 to 405 nm.

The wavelengths associated with the grating positions have been observed to drift. Measurements of the calibration lamp at the six mercury lines, and continuous scans of the solar spectrum (via the diffuser) are used to estimate this drift. Absolute wavelength accuracy can be determined to about 0.02 nm.

The three gain ranges evolve differently over time, and must be periodically renormalized to each other. This can be accomplished by using measurements for which two ranges are valid. The magnitude of the interrange ratios (gain range 2 versus gain range 3) for the SBUV/2 on NOAA-11 decreased by about 15% over its 5 years of operation.

7.5 SEM-2

The SEM-2 TED and MEPED are calibrated with proton and electron beams to provide the direct channel responses. Proper instrument operation in-orbit is verified by In-Flight (IFC) cycles, which verify electronic gains, thresholds, channel logic and detector noise levels. The TED particle calibration and IFC operation is described in Section 7.5.1, while the MEPED particle calibration and IFC is described in Section 7.5.2.

7.5.1 TED CALIBRATION

7.5.1.1 TED Particle Calibration

The TED ESAs are all calibrated with electron and ion beams to provide measured values for the geometric factors. This corrects for the variations in absolute CDEM detection efficiency, and requires that a unique set of calibration constants for each TED be used in processing the telemetered data. Each TED has a Calibration Report which provides all of the necessary calibration constants.

The primary TED measurements are the electron and proton (ion) energy fluxes measured at 0 and 30 degrees to the local vertical. The energy fluxes are measured for 0.05 to 1 keV and for 1 to 20 keV, so there are 8 primary energy flux values and calibration constants. Approximate values for the conversion of telemetered energy flux counts into energy are listed in Table 7.5.1.1-1. Note that the 8-bit telemetry count is a compressed count, and must first be converted into an uncompressed count. The actual calibrated constants for a given TED may differ by as much as 50% from the values listed in Table 7.5.1.1-1.

Table 7.4.1.1-1. Nominal Values for TED Energy Flux Calibration Factors.				
Channel Designation	Particle Type	Direction Measured	Energy Range (keV)	Calibration Factor (erg/(cm²-s-sr-count))

0EFL	Electrons	0	0.05 - 1	2×10^{-6}
0EFH	Electrons	0	1 - 20	5×10^{-5}
3EFL	Electrons	30	0.05 - 1	2×10^{-6}
3EFH	Electrons	30	1 - 20	5×10^{-5}
0PFL	Protons (Ions)	0	0.05 - 1	1×10^{-6}
0PFH	Protons(Ions)	0	1 - 20	4×10^{-5}
3PFL	Protons (Ions)	30	0.05 - 1	1×10^{-6}
3PFH	Protons(Ions)	30	1 - 20	4×10^{-5}

The TED also provides four point energy spectra and a measurement of the peak flux point in the spectrum for each particle type/measurement direction. The four point spectra require a total of 16 calibration constants to convert the telemetered counts, after decompression, into particle energy fluxes. The peak flux channel can be any of the 16 channels measured for a given particle type/measurement direction, and requires the full set of channel calibration factors, a total of 64 constants. These calibration constants are obtained from the Calibration Report for the TED, and may vary by 50% from the nominal values.

7.5.1.2 TED In-Flight Calibration

Each of the eight CDEMs has a threshold set to one of four values with each design value twice the previous one, as shown in Table 7.5.1.2-1.

Level	Binary Level	Designed Value Voltage
0	00	0.2375 V
1	01	0.475 V
2	10	0.950 V
3	11	1.900 V

The threshold rejects low level noise which appears in the signal processing circuitry. Natural signal pulses from the CDEN are normally larger than the highest threshold so any threshold can be used. At the beginning of life, the lowest threshold is used. If noise appears, it can be rejected by choosing a higher threshold. In addition, CDEM gain may down with age. This is expected to show up with the highest threshold where weaker pulses may not be counted. This effect can be corrected by used a higher CDEM operating voltage, selected by ground command.

TED In-Flight Calibration (IFC) starts on command from the ground. Because the IFC changes settings, the settings in use before the IFC starts are remembered and are restored when the TED IFC terminates. Settings commanded from the ground during TED IFC are remembered and are the ones “restored” on termination. TED IFC has two phases, phase 0 and phase 1, both controlled by the DPU.

Phase 0 measures the thresholds using one major frame (32 seconds). This is done with increasing pulses in at the CDEM with the Electrostatic Analyzers (ESAs) turned off so no natural pulses occur. In eight seconds, the calibration pulses rise in a linear series of steps to

2.50 V at the discriminator, exceeding the highest of the four thresholds. This is done four times, once for each of the four thresholds, taking a total of 32 seconds.

Phase1, which starts at the end of Phase 0, measures CDEM detection efficiency. Phase 1 has no calibration pulses but the ESAs are turned back on so that operation is normal except that the thresholds are cycled through their four levels (0,1,2,3,0,...). It runs for about one spacecraft orbit (189 x 32 second major frames = 100.8 minutes). This allows natural pulses to exercise all thresholds thereby testing the CDEMs as well as the signal processing circuitry. A full revolution is used to assure that there will be pulses, most of which appear in the auroral region. Data from this phase of the IFC is used to determine if any CDEMs have degraded, and if any CDEM operating voltage adjustments are required.

7.5.2 MEPED CALIBRATION

7.5.2.1 MEPED Particle Calibration

The MEPED telescopes are calibrated with proton and electron beams at a number of accelerators, covering the energy range from 20 keV to several MeV. The omnidirectional sensors were calibrated with proton beams over the range of 13 MeV to 153 MeV. The calibrated particle response geometric factors for the telescopes are listed in Table 7.5.2.1-1. Note that the electron channels have a secondary response to protons which has the same geometric factor. The listed geometric factors for particles in the appropriate energy range. The proton channels also have a small response to high energy electrons, which is primarily in the 0P1 and 9P1 channels. The electron geometric factor of the 0P1 and 9P1 channels varies from about 10^{-7} cm²-sr at 30 keV to 10^{-6} cm²-sr at 100 keV at 300 keV to 10^{-4} cm²-sr at 2MeV.

Table 7.5.2.1-1. MEPED Telescope Calibrated Geometric Factors.			
Channel Designation	Particle Type	Detected Energy Range (keV)	Geometric Factor G(cm²-sr)
0E1 and 9E1	Electrons	>30	0.0100
0E2 and 9E2	Electrons	>100	0.0100
0E3 and 9E3	Electrons	>300	0.0100
0E1 and 9E1	Protons	210-2700	0.0100
0E2 and 9E2	Protons	280-2700	0.0100
0E3 and 9E3	Protons	440-2700	0.0100
0P1 and 9P1	Protons	30-80	0.0100
0P2 and 9P2	Protons	80-250	0.0100
0P3 and 9P3	Protons	250-800	0.0100
0P4 and 9P4	Protons	800-2500	0.0100
0P5 and 9P5	Protons	2500-6900	0.0100
0P6 and 9P6	Protons	>6900	0.0100

The calibrated proton geometric factors for the four omnidirectional sensor channels are given in Table 7.5.2.1-2, which lists the measured angular responses integrated over the angular range of 0 to 105. This corresponds to the approximate loss + reflected particle cone over the polar caps,

where the omnidirectional sensor measurements of solar proton fluxes are expected to be most important. The omnidirectional sensors have detector energy loss thresholds of 2.5 MeV, which effectively eliminates any response to electrons and electron bremsstrahlung. This produces a nominal upper limit of about 500 MeV for detected protons, which is moderately broad because of energy loss straggling and variations of particle path in the detector with angle position.

Table 7.5.2.1-2. MEPED Omnidirectional Sensor Calibrated Geometric Factors.			
Channel Designation	Particle Type	Detected Energy Range (MeV)	Geometric Factor G(cm²-sr)
P6	Protons	16 - > 500	1.50 (See Note 1.)
P7	Protons	35 - > 500	1.50 (See Note 1.)
P8	Protons	70 - > 500	1.50 (See Note 1.)
P9	Protons	140 - > 500	1.50 (See Note 1.)
Note:			
1. Geometric factors integrated over the angle range of 0 to 105, which includes most of the particle-filled cone over the Polar caps.			

The thresholds and combinatorial logic with determine the various particle energy channels are calibrated for each MEPED using radioactive sources with precise x-ray energies. The telescope detectors are calibrated against the 59.54 keV x-ray from ²⁴¹Am, which produces a strong photo-peak in the measured spectrum. This is used to calibrate a precision Pulse Generator, which is then used to calibrate all the threshold levels. The omnidirectional sensor detectors and thresholds are calibrated using the 661.6 keV gamma-ray from ¹³⁷Cs, which produces a strong Compton edge at 477.3 keV. This Compton edge is used to calibrate the precision Pulse Generator, which in turn is used to calibrate detector gain and threshold level values. All MEPED detectors are selected to have the same sensitive thickness and detection area, so the calibrated particle responses for all MEPEDs should be identical.

7.5.2.2 MEPED In-Flight Calibration

The MEPED In-Flight Calibration (IFC) is an automatic calibration verification started by command from the ground. Processing the telemetered data gives the energy of each threshold and the full width at half maximum (FWHM) noise for the telescope detectors. After the command, the IFC starts at the next Major Frame sync pulse from the spacecraft. The IFC terminates automatically, but may also be terminated by command. The DPU controls the IFC cycle, which is used to verify all of the electronic gains, threshold values, and coincidence logic for the MEPED.

During the IFC negative pulses at a frequency of 2080 Hz are applied to the front end of each charge-sensitive amplifier. The amplitude (voltage) of the pulses is stepped up in a linear staircase of 0 to 191 steps. Groups of four pulse amplitudes are counted and telemetered, making 48 values received on the ground. The MEPED IFC has two phases, 0 and 1. The pulses are scaled for each detector and IFC phase. Phase 0 measures low energy thresholds and telescope detector noise widths, and phase 1 measures high energy thresholds. The fraction of the maximum count (account of all pulses if the pulse height is well above the threshold) for a given

IFC output is called F. For Phase 0 the variation of F with IFC pulse amplitude is fit with a Gaussian distribution to determine both the threshold value and the detector FWHM noise. For Phase 1 there is generally only one value of F which is between 0 and 1, and this value is used to measure the threshold.

The threshold values used in the MEPED are listed in Table 7.5.2.2-1, which shows which threshold is used for the lower energy determination of the listed particle channels. The IFC Phase used for each threshold measurement is also listed. Note that all telescope thresholds are actually two separate values, one for the 0 telescope and one for the 90 telescope. Thresholds for the “E” channels are for the electron telescopes, while thresholds for the “P” channels are for the proton telescopes.

The actual thresholds are derived from the IFC count data using calibration factors obtained from the calibrated threshold values for each MEPED. The MEPED IFC calibration factors are provided in a Calibration Report for each instrument.

Threshold Designation	Threshold Values (keV)	Particle Channels	IFC Phase	FWHM Noise Measurement
LS1(2 levels)	25.6	0E1 and 9E1	0	Yes
LS2(2 levels)	98.1	0E2 and 9E2	0	Yes
LS3(2 levels)	299.	0E3 and 9E3	1	No
LS4(2levels)	2500.	0E3 and 9E3	1	No
LS1(2 levels)	21.4	0P1 and 9P1	0	Yes
LS2(2 levels)	70.7	0P2 and 9P2	0	Yes
LS3(2 levels)	243.	0P3 and 9P3	1	No
LS4(2 Levels)	796.	0P4 and 9P4	1	No
LS5(2 levels)	2498.	0P5 and 9P5	1	No
LS6(2 levels)	50.	0P6 and 9P6	0	Yes
LS1(omni)	2500	P6	1	No
LS2(omni)	2500	P7	1	No
LS3(omni)	2500	P8	1	No
LS4(omni)	2500	P9	1	No

7.6 MICROWAVE HUMIDITY SOUNDER (MHS)

The launch of NOAA-18 (NOAA-N) on May 20, 2005 presented a new challenge to product production due to a new instrument, the Microwave Humidity Sounder (MHS), which replaced the AMSU-B flown on NOAA-15, -16, and -17 satellites. A major difference between MHS and AMSU-B (both five channel radiometers) is the measurement frequency at channel 2 and channel 5. MHS has 157 GHz and 190 GHz while AMSU-B operates at 150 GHz and 183, +/- 7 GHz.

The MHS has nominal and redundant Platinum Resistance Thermometers (PRTs) built into the

instrument. One set each of five PRTs and three calibration resistors is routed to the telemetry acquisition circuit of the Processor and Interface Electronics A (PIE-A) and PIE-B, respectively. MHS also has nominal and redundant local oscillators, Side-A and Side-B. One of the sets is used for nominal and the other set will serve as backup. A more thorough description of the MHS instrument can be found in Section 3.9.

7.6.1 COMPUTATION OF PRT TEMPERATURES

The PRT temperatures are derived in a two-step process. First the PRT counts in the MHS data packets are converted to resistance R (in ohms) using three reference resistor values which are in the data packets (in counts). Subsequent conversion of PRT resistance R into PRT temperature is accomplished using a cubic polynomial of the form,

$$T_k = \sum_{j=0}^3 f_{kj} R_k^j \quad (7.6-1)$$

where T_k and R_k represent the temperature and resistance of the PRT k , respectively. The coefficients f_{kj} will be provided for each PRT. MHS has five PRTs (per PIE) mounted on the underside of the onboard calibration target (OBCT). Each PRT is sampled once per scan and these PRT counts are output in the science data packet. The PRT count must be converted into resistance R_k which appears in Equation 7.6.1-1. The process of converting the PRT counts into resistance is described in the next section.

7.6.2 THREE PRT CALIBRATION CHANNELS

MHS has three PRT calibration channels which provide data for a linear count-to-resistance conversion that is updated in each scan. These are precision resistors whose values are known to high precision over their operating temperatures and life. Their values are chosen to lie at the upper, middle, and lower resistance ranges expected of the OBCT PRTs throughout mission life. These three resistors are referred to as the PRT Calibration channels 1, 2, and 3 (PRT CAL n , where $n=1, 2,$ and 3), respectively. Their values in counts are measured once per scan and are output in the science data packet. The resistance of the PRT CAL n is assumed to be a linear function of the PRT CAL n counts,

$$R_{CALn} = \alpha + \beta C_{CALn} \quad (7.6.2-1)$$

where R_{CALn} and C_{CALn} represent the resistance and count of the PRT CAL n , (with $n=1, 2,$ and 3) respectively. The α and β are the offset and slope. For each scan, the C_{CALn} values are measured and the R_{CALn} values, which remain constant, are provided for each MHS flight model. Therefore, the α and β can be obtained by a least-square fit from Equation 7.6.2-1. The results are,

$$\alpha = \frac{\left(\sum_{n=1}^3 R_{CALn} \right) \left(\sum_{n=1}^3 C_{CALn}^2 \right) - \left(\sum_{n=1}^3 C_{CALn} \right) \left(\sum_{n=1}^3 C_{CALn} R_{CALn} \right)}{3 \left(\sum_{n=1}^3 C_{CALn}^2 \right) - \left(\sum_{n=1}^3 C_{CALn} \right)} \quad (7.6.2-2)$$

$$\beta = \frac{3 \left(\sum_{n=1}^3 C_{CALn} R_{CALn} \right) - \left(\sum_{n=1}^3 R_{CALn} \right) \left(\sum_{n=1}^3 C_{CALn} \right)}{3 \left(\sum_{n=1}^3 C_{CALn}^2 \right) - \left(\sum_{n=1}^3 C_{CALn} \right)} \quad (7.6.2-3)$$

7.6.3 CONVERSION OF PRT COUNTS INTO RESISTANCE

For each scan, these α and β values are computed and then applied to each OBCT PRT to convert the OBCT PRT count C_k into resistance R_k as follows,

$$R_k = \alpha + \beta C_k \quad (7.6.3-1)$$

where R_k and C_k are the resistance and count, respectively, of the PRT k with $k=1$ to 5. The R_k will be used in Equation 7.6.1-1 for calculation of the OBCT PRT temperatures, T_k , values of which are output to the MHS Level 1b data.

7.6.4 BLACKBODY TEMPERATURE

The mean OBCT temperature, T_w , is calculated from the individual PRT temperatures,

$$T_w = \frac{\sum_{k=1}^m W_k T_k}{\sum_{k=1}^m W_k} + \Delta T_w \quad (7.6.4-1)$$

where $m=5$ represents the number of OBCT PRTs (as listed in Table 3.9.2.1-2) and W_k is a weight assigned to each PRT k . The quantity T_w represents a warm load correction factor, which is derived for each channel from the pre-launch test data at three instrument temperatures (low, nominal, and high). The procedure for determining the T_w values is described in Mo (1996). The W_k value, which equals 1 (0) if the PRT k is determined good (bad) before or after launch. For the central PRT, $W_k=2$ will be assigned.

Similarly, a cold space temperature correction, ΔT_c , may be required. This is due to the fact that the space view may be contaminated by radiation which originates from the spacecraft and the Earth's limb. Thus, the effective cold space temperature is given by:

$$T_c = 2.73 + \Delta T_c \quad (7.6.4-2)$$

where 2.73K is the cosmic background brightness temperature and ΔT_c will be determined from pre- or post-launch data analysis. The ΔT_c values of individual channels and each of the possible space viewing directions will be provided for each MHS flight model in Appendix D.

7.6.5 MHS HOUSEKEEPING THERMISTORS AND CURRENT MONITORS

7.6.5.1 Standard Thermistors

There are 24 Housekeeping (HK) thermistors which monitor the temperatures at various MHS telemetry points, such as amplifiers, and local oscillators. These data, which are primarily for instrument health and safety monitoring, are not used in the radiometric retrieval algorithm of science data. The accuracy of these HK temperatures is less rigorous than that of the PRT temperatures. The 24 HK thermistors use a common set of conversion coefficients. The two-step process of converting counts to resistance and resistance to temperature can be compressed into a single step with negligible errors. This single step process computes the thermistor temperatures directly from the thermistor counts, using a polynomial of the form,

$$T_{th} = \sum_{n=0}^4 g_n C_{th}^n \quad (7.6.5.1-1)$$

where T_{th} and C_{th} represent the temperature and count of the thermistors, respectively. The C_{th} is also referred to as the 8-bit code from the Thermistor Telemetry. The coefficients g_n , which are valid for -40°C to 60°C (i.e., 243 K to 333 K), will be provided for each MHS flight model in Appendix D.

7.6.5.2 Current Monitors

There are six current monitors that measure the current consumption of various power lines in the MHS instrument. The measured output in count C_I is converted to current, I (in amperes) by a linear relationship as follows,

$$I = I_0 + mC_I \quad (7.6.5.2-1)$$

where I_0 is the intercept and m denotes the slope, respectively. Values of I_0 and m will be provided for each monitor in Appendix D.

7.6.5.3 Survival Thermistors

In the MHS analog telemetry, there are three survival thermistors which monitor the temperatures of the Receiver, Electronics Equipment, and Scan Mechanism. These survival

thermistors are powered to provide measurements even when the instrument power is off.

The conversion of the survival thermistor counts into temperatures is accomplished by a polynomial of the form,

$$T_{SUR} = \sum_{m=0}^5 h_m V^m \quad (7.6.5.3-1)$$

where $V = 0.02 \times \text{Count}$ represents the measured output in volts. One set of coefficients h_m applies to all three survival thermistors.

7.6.6 CALIBRATION ALGORITHM

The calibration algorithm from Mo (1996) that converts the Earth scene counts C_s to radiance, R_s , is given as follows,

$$R_s = R_w + (R_w - R_c) \left(\frac{C_s - \overline{C_w}}{\overline{C_w} - \overline{C_c}} \right) + Q \quad (7.6.6-1)$$

where R_w and R_c are the radiance computed from the OBCT temperature T_w and the effective cold space temperature T_c , respectively, using the Planck function. The C_s is the radiometric count from the Earth scenes. The $\overline{C_w}$ and $\overline{C_c}$ are the convoluted blackbody count and space counts, respectively, as defined in Equation 7.6.6-3 below. The quantity Q , which represents the nonlinear contribution, is given by,

$$Q = u(R_w - R_c)^2 \frac{(C_s - \overline{C_w})(C_s - \overline{C_c})}{(\overline{C_w} - \overline{C_c})^2} \quad (7.6.6-2)$$

where u is a free parameter, values of which are determined at three instrument temperatures (low, nominal, and high) from the pre-launch calibration data. After the launch of MHS, the u value at an actual on-orbit instrument temperature will be interpolated from these three pre-launch values.

For each scan, C_w represents the mean blackbody radiometric count of the four samples of the blackbody target. Similarly, C_c represents the mean space radiometric count of the four samples of space viewing. To reduce noise in the calibrations, the CX (where $X=W$ or C) for each scan line were convoluted over several neighboring scan lines according to a weight function,

$$\overline{C}_x = \frac{\sum_{i=-n}^n w_i C_x(t_i)}{\sum_{i=-n}^n w_i} \quad (7.6.6-3)$$

where t_i (when $i \neq 0$) represents the time of the scan lines just before or after the current scan line and t_0 is the time of the current scan line. The variable t_i can be written as: $t_i = t_0 + i\Delta t$, where $\Delta t = 8/3$ seconds for MHS. The $2n+1$ values are equally distributed about the scan line to be calibrated. Following the NOAA KLM operational preprocessor software, the value of $n=3$ is chosen for MHS. A set of triangular weights, 1, 2, 3, 4, 3, 2, and 1 are chosen for the weight factor w_i that appears in Equation 7.6.6-3 for the seven scans at $i = -3, -2, -1, 0, 1, 2, \text{ and } 3$, respectively.

For MHS channel 19, the monochromatic assumption breaks down and a band correction with two coefficients has to be applied. These coefficients modify T_w to give an effective temperature T_w' :

$$T_w' = b + cT_w \quad (7.6.6-4)$$

which is then used in the Planck function to give an accurate radiance. The application of Equation 7.6.6-4 is not necessary for the space temperature since the errors in the monochromatic assumption are negligible for such low radiance.

7.6.7 CALIBRATION QUALITY CONTROL

Quality control (QC) in the MHS calibration is very important for producing accurate calibration coefficients in the NESDIS operational calibration process. A scan-by-scan QC process can detect bad data which are flagged in the Level 1b data sets. All of the QC processes that have been built into the NESDIS operational AMSU-B preprocessor are to be included in this MHS algorithm. These and additional QC items are listed as follows,

Intra-scan test of blackbody counts C_w : If any two samples differ more than a preset limit of the blackbody count variation ΔC_w , the $C_w(t_i)$ should be excluded in Equation 7.6.6-3 by setting $w_i=0$.

Intra-scan test of the space counts C_c : If any two samples differ more than a preset limit of the space count variation ΔC_c , the $C_c(t_i)$ should be excluded in Equation 7.6.6-3 by setting $w_i=0$.

Inter-scan test of PRT temperatures T_k : If a T_k differs by more than 0.2K from its value in the previous (good) scan line, the T_k should be omitted from the average in Equation 7.6.4-1 by setting $w_k=0$.

Test of antenna pointing accuracy: If an antenna position reading is out of a preset limit, then an error flag will be set in the Level 1b data.

Radio frequency interference (RFI) correction: It was observed that the transmitters on the NOAA KLM spacecraft can produce serious RFI to the AMSU-B data. A corrective algorithm was developed for correction of the RFI in the AMSU-B. The same algorithm will also be used in the MHS calibration algorithm. Detailed description of the AMSU-B RFI corrective algorithm is online in Appendix M.

Detection and exclusion of the Lunar contaminated space samples from the calibration: Calculate the angular separation between the Moon and each viewing direction of the four space samples. Reject those samples that are within a pre-defined angular threshold (default = 1.5°). In the worst case, three samples may be rejected in this process (keep the sample that has the largest separation angle if all four samples fall within the pre-defined angular threshold). Description of how to calculate the angular separation between the Moon and the space viewing direction is given in Kigawa and Mo (2002). Store the calculated separation angles.

Inter-scan test of sudden jump (or drop) of C_w and C_c : Such sudden change in C_w and C_c has been observed in the NOAA-17 AMSU-A data. A corrective algorithm from Mo (2002) was developed for correction of the effect of such sudden change in the calibration counts on the calibration coefficients.

7.6.8 NOAA LEVEL 1b DATA

The NOAA Polar Orbiter Level 1b data are raw data that have been quality controlled and assembled into discrete data sets, to which Earth location and calibration information are appended but not applied. For simplification of application, Equation 7.6.6-1 can be rewritten as,

$$R_s = a_0 + a_1 C_s + a_2 C_s^2 \quad (7.6.8-1)$$

where the calibration coefficients a_i (where $i = 0, 1, \text{ and } 2$) can be expressed in terms of R_w , G , $\overline{C_w}$ and $\overline{C_c}$. This is accomplished by rewriting the right-hand side of Equation 7.6.6-1 in powers of C_s and equating the a_i 's to the coefficients of same powers of C_s . The results are,

$$a_0 = R_w - \frac{\overline{C_w}}{G} + u \frac{\overline{C_w} \overline{C_c}}{G^2} \quad (7.6.8-2)$$

$$a_1 = \frac{1}{G} - u \frac{\overline{C_c} + \overline{C_w}}{G^2} \quad (7.6.8-3)$$

and

$$a_2 = u \frac{1}{G^2} \quad (7.6.8-4)$$

where G represents the channel gain and is defined as

$$G = \frac{\overline{C_w} - \overline{C_c}}{R_w - R_c} \quad (7.6.8-5)$$

These calibration coefficients will be calculated at each scan line for all channels and appended to the Level 1b data. With these coefficients, one can simply apply Equation 7.6.8-1 to obtain the scene radiance R_s . Users, who prefer brightness temperature instead of radiance, can make the simple conversion,

$$T_s = B^{-1}(R_s) \quad (7.6.5-6)$$

where $B^{-1}(R_s)$ is the inverse of the Planck function for radiance R_s . The T_s is the converted brightness temperature.

For MHS channel 19, the band correction must be taken into consideration in the inverse process as follows,

$$T_s = \frac{B^{-1}(R_s) - b}{c} \quad (7.6.8-7)$$

8.0 NOAA LEVEL 1B DATABASE

This section describes the NOAA-KLMNN' and Metop Polar Orbiter Level 1b NOAA datasets archived by NOAA. Also described are the formats in which NOAA distributes raw data to the users.

NOAA Level 1b (following FGGE terminology) is raw data that have been quality controlled, assembled into discrete data sets, and to which Earth location and calibration information have been appended (but not applied). Please note that NASA and EUMETSAT use a different definition for Level 1b, so the following information may not apply to data sets produced by other organizations.

Currently, the NOAA Level 1b data are ingested into the Comprehensive Large Array-data Stewardship System (CLASS) from NSOF and made available to the general public within 4 hours after ingest. Each data set contains data of one type for a discrete time period. Thus, there are separate data sets for HRPT, LAC, GAC, FRAC, HIRS/3, HIRS/4, AMSU-A, AMSU-B, MHS and SEM-2.SBUV/2 data sets do not meet the NOAA Level 1b definition, and are described under Section 9.7, NESDIS Operational Products. Time periods are arbitrary subsets of orbits, and may cross orbits (i.e., may contain data along a portion of an orbital track that includes the ascending node, the reference point for counting orbits). Generally, GAC, FRAC, HIRS/3, HIRS/4, MHS, AMSU-A, and AMSU-B data sets will be available for corresponding time periods and usually have a three to five minute overlap between consecutive data sets.

8.1 DATA REPRESENTATION AND STORAGE

This section describes the bit and byte numbering conventions used in this document, and the storage methods for integers and floating point numbers. This information is especially critical when transporting data from one computer architecture to another. Without special handling, data produced on one system may be unusable on another due to differences in internal data storage.

Within this section, a byte is defined as containing 8 bits (i.e., an octet), and a word can be either 8, 16 or 32 bits in length. In all cases, the least significant bit (lsb) is designated as bit 0 and has a base10 value of $2^0 = 1$. Therefore, in a 8-bit word, the most significant bit (msb) is designated as bit 7, and has a base-10 value of $2^7 = 128$. In a 16-bit word, the msb is designated as bit 15, and has a base-10 value of $2^{15} = 32,768$. In a 32-bit word, the msb is designated as bit 31, and has a base10 value of $2^{31} = 2,147,483,648$.

- For signed binary integers, the msb represents the sign of the number. The remaining bits (bits 7 through 0 for 8-bit words, 15 through 0 for 16-bit words and 31 through 0 for 32-bit words) are used to designate the magnitude of the number. Therefore, the range of signed binary integers is based on word size as follows:
 - 1 byte -128 to 127
 - 2 bytes -32,768 to 32,767
 - 4 bytes -2,147,483,648 to 2,147,483,647

Positive binary integers are in true binary notation with the sign bit set to zero. Negative binary integers are in two's-complement notation with sign bit set to one. Negative binary integers are formed in two's-complement notation by inverting each bit of the positive binary integer and adding one.

Unsigned binary integers use all bits including the msb to represent the magnitude of the number. Therefore, their range is as follows, again, based on word size:

- 1 byte 0 to 255
- 2 bytes 0 to 65,535
- 4 bytes 0 to 4,294,967,295

A field containing a binary integer is give the data type of unsigned integer if its content will never be a negative or if a negative value just does not make sense for that field. For example, the idea of a negative scan line number or negative date or time is nonsensical. Therefore, fields containing scan line numbers, dates and times are labeled as unsigned integers.

Unfortunately, this data type is not supported by all computer languages (e.g., FORTRAN), so additional data manipulation may be necessary. In the case of reading a 16-bit unsigned integer (DATA), a FORTRAN user could use the following code snippet to extract the actual value (VALUE):

```
...  
INTEGER*2 DATA  
INTEGER*4 VALUE  
...  
READ DATA  
IF (DATA .LT. 0) THEN  
    VALUE = 65536 + DATA  
ELSE  
    VALUE = DATA  
ENDIF  
...
```

But note that nearly all unsigned integer fields can be safely read into signed integer data types of the same word sizes. This is because they were originally written to the Level 1b using signed integer data types, and thus will be within the positive range of the corresponding signed integer data type. The Level 1b format specifications will clearly indicate, by providing ranges, those unsigned integer fields that must be strictly treated as unsigned integer data types - using the data manipulation described above, if necessary - to ensure that correct values are retrieved.

However, not all fields of an unsigned integer data type contain unsigned binary integers. Fields containing packed data are also identified as unsigned integers. While its msb is not a sign bit, a field containing packed data does not represent an unsigned binary integer. Such a field requires

the user to perform some type of special unpacking technique in order to extract the information of interest from the field in order for correct interpretation. Packed data may be bit fields, packed integers, or both. A bit field is one or more consecutive bits used to indicate one of two or more possible conditions or states. (A bit flag is a specialized instance of a bit field. It is a single bit indicating one of only two possible conditions.) For example, a three-bit field may indicate which of seven different modes that an instrument is operating in (i.e., 0 implies “power on mode”, 1 implies “warm up mode”, 2 implies “standby mode”, etc.). A packed integer is simply a binary number that is stored in just a subset of an unsigned integer field’s bits. Although similar to a bit field, a packed integer is not an indicator of a condition, but an actual numeric value having magnitude, that once unpacked, could be used in arithmetic computations.

To provide maximum portability of the Level 1b data sets across different computer platforms, floating point data is represented by scaled integers. Scaled integers can be either signed or unsigned, and are simply floating point numbers multiplied by a fixed scaling factor so that a sufficiently precise representation of the original number can be stored in integer form. For example, the floating point value 1.2313 might be multiplied by 10^2 to achieve an integer value of 123. To achieve better precision, the floating point value might be multiplied by 10^3 or 10^4 to achieve an integer value of 1231 or 12313, respectively. In the Level 1b data sets, the scaling factors are powers of ten, and only the exponents (2, 3 and 4 in the previous examples) are documented within the data set. To recover an approximation of the original floating point value, divide the integer value by ten raised to the given exponent.

A major problem impeding the free transport of binary data from one computer system to another is the “Big Endian - Little Endian” dichotomy. “Big Endian” systems (e.g. IBM 370, Macintosh, SGI, Sun SPARC) store bytes of binary numeric data in reverse order relative to “Little Endian” systems (e.g. IBM PC, DEC Alpha). For example, a 32-bit hexadecimal value of x01020304 (decimal value 16,909,060) written to a binary file by a Big Endian system would be read from the file as x04030201 (decimal value 67,305,985) by a Little Endian system. Level 1b data sets generated and archived by NOAA are in Big Endian order; users with Little Endian systems must include an additional byte-swapping step when reading binary numeric data from Level 1b data sets produced by NOAA. Some processors support byte swapping in their instruction sets, but others must use compiler dependent functions.

8.2 NOAA LEVEL 1B DATA SET NAMES

This section describes the data set naming convention which is used for all NOAA Level 1b data sets. Each data set has a unique data set name which is generated when the data set is created. This 42-character name will be used to reference the data sets. The data set name is composed of a set of alphanumeric qualifiers separated by periods (.). The complete data set name with all of its qualifiers will be as follows:

PROCESSING-CENTER.DATA-TYPE.SPACECRAFT-UNIQUE-ID.YEAR-DAY.START-TIME.STOP-TIME.PROCESSING-BLOCK-ID.SOURCE

The qualifiers of the data set name are defined in Table 8.2-1:

Table 8.2-1. NOAA Level 1b Data Set Names.	
Qualifier	Example
PROCESSING CENTER	<p>Three characters identifying where the data set was created. Recognized character groups are:</p> <p>CMS = Centre de Meteorologie Spatiale - Lannion, France DSS = Dundee Satellite Receiving Station - Dundee, Scotland, UK NSS = NOAA/NESDIS - Suitland, Maryland, USA UKM =United Kingdom Meteorological Office - Bracknell, England, UK</p>
DATA TYPE	<p>Four characters identifying the data type and transmission method. Recognized character groups are:</p> <p>HRPT= HRPT (direct readout full resolution AVHRR) GHRR= GAC (recorded reduced resolution AVHRR) LHRR= LAC (recorded HRPT AVHRR) FRAC=FRAC (recorded full resolution, full orbit data from Metop) HIRX= HIRS/3 or HIRS/4 data set derived from GAC embedded TIP AMAX= AMSU-A data set derived from GAC embedded TIP AMBX= AMSU-B data set derived from GAC embedded TIP MHSX=MHS data set derived from AIP MHSS=MHS data derived from stored AIP MHSH=MHS data derived from HRPT HIRS= HIRS/3 or HIRS/4 data set derived from stored TIP AMAS= AMSU-A data set derived from stored TIP AMBS= AMSU-B data set derived from stored TIP</p>
SPACECRAFT UNIQUE ID	<p>Two characters identifying the spacecraft platform from which the data was received. Recognized character groups are:</p> <p>NK = NOAA-15 (formerly NOAA-K, launched 13 May 1998) NL = NOAA-16 (formerly NOAA-L, launched 21 September 2000) NM = NOAA-17 (formerly NOAA-M, launched 24 June 2002) NN = NOAA-18 (formerly NOAA-N, launched 20 May 2005) NP = NOAA-19 (formerly NOAA-N', launched 6 February 2009) M2 = Metop-A (European satellite launched 19 October 2006) M1 = Metop-B (European satellite launched 17 September 2012)</p>
YEAR DAY	<p>Six character date identification field in the form XYYDDD, where "X" is a delimiter, "YY" identifies the year of century and "DDD" identifies the day of the year on which the spacecraft began recording the data set. Example: D14100 for day 100 of year 2014</p>

START TIME	S1355, where "S" identifies this group as a start time delimiter. "1355" denotes 13 hours 55 minutes UTC (to the nearest minute) and represents the time at which spacecraft recording began.
STOP TIME	E1456, where "E" identifies this group as an end time delimiter. "1456" denotes 14 hours 56 minutes UTC (to the nearest minute) and denotes the time of spacecraft recording of the last usable data in the data set.
PROCESSING BLOCK ID	B0016465, where "B" identifies this group as a processing block ID delimiter. "0016465" is a seven digit number identifying the spacecraft revolution in which recording of this data set began and the revolution in which the data ended (the first five digits identifying the beginning revolution and last two being the two least significant digits of the orbit number identifying the ending revolution).
SOURCE	Two characters identifying data acquisition source. Valid character groups are: CF - Cape Ferguson, Queensland, Australia DU = Dundee, Scotland, UK EB - Ewa Beach, Oahu, Hawaii GC = Fairbanks, Alaska, USA (formerly Gilmore Creek) HO = Honolulu, Hawaii, USA MI = Miami, Florida, USA MM = McMurdo, Antarctica MO = Monterey, California, USA SF = Sioux Falls, South Dakota, USA SN = Svalbard NOAA, Norway SO = Satellite Operations Control Center, Suitland, Maryland, USA SV= Svalbard, Norway WE = Western Europe, Lannion, France WI = Wallops Island, Virginia, USA

8.3 DATA DISTRIBUTION FORMATS

This section describes the digital data formats which NOAA/NESDIS uses to distribute data from the NOAA Level 1b database.

8.3.1 NOAA LEVEL 1B (NATIVE) FORMAT AND SELECTIVE EXTRACTS

This section describes the NOAA Level 1b digital data format. This includes the data formats archived by NOAA/NESDIS and distributed to near-realtime users, and the formats produced by NESDIS archive retrieval systems for customers of retrospective data (data older than 4 hours).

The archive format versions have changed several times over the lifetime of the NOAA KLMNN” series satellites. These changes were applied across all datatypes and across all operational satellites at the same time. The change dates are summarized below.

- Version two (v2) formats were in effect from the launch of NOAA-15 on May 13, 1998, to April 27, 2005.
- Version three (v3) formats were in effect from April 28, 2005, just prior to launch of NOAA-18, through January 24, 2006.
- Version four (v4) formats were in effect from January 25, 2006 to end-of-life.

Version two was applied to NOAA-15, NOAA-16, and NOAA-17. Version three was applied to all POES satellites from NOAA-15 through NOAA-18 to improve HIRS calibration. Version four was applied to all POES satellites from NOAA-15 through NOAA-19 and, also, to Metop-A and Metop-B to include pixel level cloud information from the **CL**ouds from **AVHRR** Extended (**CLAVR-x**) program. A flag was added to the header record (utilizing spares) that indicated when the CLAVR-x processing is actually turned on or off. The CLAVR-x cloud mask is stored as a 2-bit value for each pixel.

On November 14, 2006, at 1531 UTC the HRPT/LAC 1B version number was inadvertently changed to 5. This occurred when a problem fix was implemented to correct a zero scan line number that was in the Metop-2/A FRAC data. There were no format changes associated with this fix.

8.3.1.1 Data Set Structure

The record structure of each data set (file) as archived by NOAA and provided directly to near-realtime users is shown below:

Record 1:	Data Set Header Record
Record 2 - EOF:	Data Records

The Data Set Header Record contains information which applies to the following data records, such as data set and time identification, overall data set quality, orbital parameters, and conversion factors for calibration and telemetry data.

The Data Records contain information specific to one scan or time segment of data including time, quality, calibration, navigation, telemetry, and sensor data.

When retrospective data sets are retrieved by users from NOAA archive systems, supplementary records are added by default to the data set to provide archive processing information. These data sets have the following record structure:

Record 1:	Archive Retrieval System (ARS) Header Record
Record 2:	Data Set Header Record
Record 3 - n:	Supplementary Header Records (optional)
Record (n+1) - EOF:	Data Records

The format of the ARS Header Record is the same for all data types. Although the fundamental structure of the NOAA Level 1b data set header records and data records is consistent across data types, the differences are significant and will be addressed separately for each data type.

All the tables in this section share a common legend, which is as follows:

Legend:

Field Name:

The name or brief description of the field.

Start Octet:

Offset location of first octet (8-bit byte) in the defined field from beginning of record. Starting with octet 1. (Note that the terms “octet” and “byte” are used interchangeably and mean the same thing.)

End Octet:

Offset location of last octet in the defined field from beginning of record.

DT:

Data Type (i - integer, u - unsigned integer, c - character). Character data is stored as ASCII.

Word Size:

Number of octets per data word.

Number of Words:

Number of words of indicated size and type contained in the defined field.

Scale Factor:

Scaling Factor: $x=y/10^n$, where x is the desired floating point value, y is the stored integer value for the defined field, and n is the number indicated in the scale factor column for that field.

Units:

The field’s unit of measurement (e.g., octets, counts, Kelvin, volts), if applicable.

Notes:

References to notes that follow the format specifications.

8.3.1.2 Archive Retrieval System (ARS) Header Record

The ARS Header Record is created by default when data are ordered from the NOAA archive, and

includes information on the data request and how the data was processed from the archive. A detailed description of the contents of this record is presented in Table 8.3.1.2-1.

Table 8.3.1.2-1. Format of ARS Header Record.						
Start Octet	End Octet	DT	Word Size	SF	Number of Words	Order ID
1	6	c	6	0	1	NeS Number
7	14	c	8	0	1	CLASS Number (if applicable)
15	18	c	4	0	1	Order Creation Year (e.g., '1998')
19	21	c	3	0	1	Order Creation Day of Year (e.g., '365')
22	22	c	1	0	1	Processing Site Code A = CLASS S = NCDC/Suitland N = NCDC/Asheville
23	30	c	8	0	1	Processing Software ID (e.g., 'Extract2')
DATA SELECTION CRITERIA						
31	72	c	42	0	1	Data Set Name
73	74	c	2	0	1	<ASCII blank = 0x20>
75	75	c	1	0	1	Select Flag T = total data set copy S = selective data set copy (subset)
76	78	c	3	0	1	Beginning Latitude
79	81	c	3	0	1	Ending Latitude
82	85	c	4	0	1	Beginning Longitude
86	89	c	4	0	1	Ending Longitude
90	91	c	2	0	1	Start Hour (UTC)
92	93	c	2	0	1	Start Minute
94	96	c	3	0	1	Number of Minutes
97	97	c	1	0	1	Appended Data Flag

98	117	c	1	0	20	Channel Select Flags Y = channel selected N = channel not selected
DATASET SUMMARY						
118	119	c	2	0	1	Sensor Data Word Size in bits 08 = 8 bits per word (reduced and packed) 10 = 10 bits per word (packed) 16 = 16 bits per word (unpacked)
120	144	c	27	0	1	<ASCII blank = 0x20>
145	145	c	1	0	1	Ascend/Descend Flag A = ascending only D = descending only B = both ascending and descending
146	148	c	3	0	1	First Latitude first latitude value in the first data record
149	151	c	3	0	1	Last Latitude last latitude value in the last data record
152	155	c	4	0	1	First Longitude first longitude value in the first data record
156	159	c	4	0	1	Last Longitude last longitude value in the last data record
160	179	c	20	0	1	Data Format (e.g., 'NOAA Level 1b v4')
180	185	c	6	0	1	Size of Records (in octets)
186	191	c	6	0	1	Number of Records (total, including ARS and Data Set Header Records)
FILLER						
192	510	c	1	0	319	<ASCII blank = 0x20>

8.3.1.3 LAC and HRPT Data Sets

This section describes the characteristics and format of Local Area Coverage (LAC) and High Resolution Picture Transmission (HRPT) data sets for both NOAA KLM and NOAA-N, -N' satellites.

8.3.1.3.1 Data Characteristics

The AVHRR data are digitized to 10-bit precision. The digitized data are both transmitted from the satellite in real-time as High Resolution Picture Transmission (HRPT) data, and selectively recorded on board the satellite for subsequent playback as Local Area Coverage (LAC) data. A maximum of ten minutes of LAC data may be recorded per orbit. In all other respects, HRPT and LAC are identical. Table 8.3.1.3.1-1 summarizes fundamental characteristics of the data.

Table 8.3.1.3.1-1. LAC/HRPT Data Characteristics.	
Parameter	Value
Sample word size	10 bits
Number of sampled channels/available channels	5/6
Number of Earth samples per scan	2,048 per channel
Scan rate	360 scans per minute
Scan direction	East to West (northbound)
Instantaneous Field of View (IFOV)	0.07449 degrees (all channels)
Spatial resolution at nadir	1.09 km at 833 km altitude
Cross track distance between sample centers at nadir	1.09 km at 833 km altitude
Along track distance between sample centers at nadir	1.09 km at 833 km altitude
Cross-track scan coverage	± 55.4 degrees from nadir
Swath width	2,399 km at 833 km altitude

8.3.1.3.2 Header Records

The Data Set Header Record contains quality, navigation, calibration, and conversion coefficient information which applies to the LAC/HRPT data records which follow. This section describes the header records for NOAA KLM (version 2) and NOAA-N, -N' (version 4/5) satellites. See section 8.3.1 for the version dates. (On November 14, 2006, version 5 was implemented for the LAC/HRPT only. The GAC continues to remain at 4).

8.3.1.3.2.1 Version 2 Format, pre-April 28, 2005

The content of the LAC/HRPT Data Set Header Record for Version 2, is documented in Table 8.3.1.3.2.1-1. See the legend in Section 8.3.1.1 for further explanation of the headings on this table.

Table 8.3.1.3.2.1-1. Format of LAC/HRPT Data Set Header Record (Version 2, pre-April 28, 2005)							
Field Name	Start Octet	End Octet	Data Type	Word Size	Number of Words	Scale Factor	Units
GENERAL INFORMATION							
Data Set Creation Site ID CMS = Centre de Meteorologie Spatiale/France; DSS = Dundee Satellite Receiving Station/UK; NSS = National Environmental Satellite, Data and Information Service/USA; UKM = United Kingdom Meteorological Office/UK	1	3	c	3	1	0	
<ASCII blank = x20>	4	4	c	1	1	0	
NOAA Level 1b Format Version Number: 1=TIROS-N,NOAA-6 through NOAA-14; 2=NOAA-15, -16, -17 (pre-April 28, 2005); 3=all satellites post April 28, 2005; 4=cloud mask flag (CLAVRx) – January 25, 2006 5=no format change (LAC/HRPT only) – November 14, 2006	5	6	u	2	1	0	
NOAA Level 1b Format Version Year (e.g. 1999)	7	8	u	2	1	0	
NOAA Level 1b Format Version Day of Year (e.g. 365)	9	10	u	2	1	0	
<Reserved for Logical Record Length> For Creation Site use only. Logical Record Length of NOAA Level 1b data set prior to processing.	11	12	u	2	1	0	
<Reserved for Block Size> For Creation Site use only. Block Size of NOAA Level 1b data set prior to processing.	13	14	u	2	1	0	
Count of Header Records in this Data Set	15	16	u	2	1	0	
<Zero fill>	17	22	i	2	3	0	

Data Set Name	23	64	c	42	1	0	
Processing Block Identification	65	72	c	8	1	0	
NOAA Spacecraft Identification Code: 2 = NOAA-16; 4 = NOAA-15; 6 = NOAA-17; 7 = NOAA-18; 8 = NOAA-19 11 = MetOp-B 12 = MetOp-A	73	74	u	2	1	0	
Instrument ID 301 = s/n A301 (NOAA-L); 302 = s/n A302 (NOAA-K); 304 = s/n A304 (NOAA-M); 308 = s/n A308 (NOAA-N'); 306 = s/n A306 (NOAA-N); 307 = s/n A307 (MetOp-1); 305 = s/n A305 (MetOp-2)	75	76	u	2	1	0	
Data Type Code 1 = LAC; 2 = GAC 3 = HRPT; 4 = TIP; 5 = HIRS; 6 = MSU; 7 = SSU; 8 = DCS; 9 = SEM; 10 = AMSU-A; 11 = AMSU-B.	77	78	u	2	1	0	
TIP Source Code 0 = unused, GAC/HRPT/LAC data; 1 = GAC embedded AMSU and TIP; 2 = stored TIP; 3 = HRPT/LAC embedded AMSU and TIP; 4 = stored AIP.	79	80	u	2	1	0	
Start of Data Set Day Count starting from 0 at 00h, 1 Jan 1950	81	84	u	4	1	0	
Start of Data Set Year (e.g., 1999)	85	86	u	2	1	0	
Start of Data Set Day of Year (e.g., 365)	87	88	u	2	1	0	

Start of Data Set UTC Time of Day	89	92	u	4	1	0	ms
End of Data Set Day Count starting from 0 at 00h, 1 Jan 1950	93	96	u	4	1	0	
End of Data Set Year (e.g., 1999)	97	98	u	2	1	0	
End of Data Set Day of Year (e.g., 365)	99	100	u	2	1	0	
End of Data Set UTC Time of Day	101	104	u	4	1	0	ms
Year of Last CPIDS Update (e.g., 1999)	105	106	u	2	1	0	
Day of Year of Last CPIDS Update (e.g., 365)	107	108	u	2	1	0	
<Zero fill>	109	116	i	2	4	0	
DATA SET QUALITY INDICATORS							

Instrument Status bits 31-16: <Zero fill> bit 15: motor/telemetry (0 = off; 1 = on) bit 14: electronics/telemetry (0 = off; 1 = on) bit 13: channel 1 status (0 = disable; 1 = enable) bit 12: channel 2 status (0 = disable; 1 = enable) bit 11: channel 3a status (0 = disable; 1 = enable) bit 10: channel 3b status (0 = disable; 1 = enable) bit 9: channel 4 status (0 = disable; 1 = enable) bit 8: channel 5 status (0 = disable; 1 = enable) bit 7: channel 3a/3b select status bit 6: voltage calibrate status (0 = off; 1 = on) bit 5: cooler heat (0 = off; 1 = on) bit 4: scan motor (0 = low; 1 = high) bit 3: telemetry lock (0 = off; 1 = lock) bit 2: earth shield (0 = disable; 1 = deploy) bit 1: patch control (0 = off; 1 = on) bit 0: <Zero fill>	117	120	u	4	1	0	
--	-----	-----	---	---	---	---	--

<Zero fill>	121	122	i	2	1	0	
Record Number of Status Change (if 0, none occurred; range: 0 - 65,535)	123	124	u	2	1	0	
Second Instrument Status (if previous word is 0, no change)	125	128	u	4	1	0	
Count of Data Records in this Data Set (range: 0 - 65,535)	129	130	u	2	1	0	
Count of Calibrated, Earth Located Scan Lines in this Data Set (range: 0 - 65,535)	131	132	u	2	1	0	
Count of Missing Scan Lines (range: 0 - 65,535)	133	134	u	2	1	0	
Count of Data Gaps in this Data Set	135	136	u	2	1	0	
Count of Data Frames Without Frame Sync Word Errors	137	138	u	2	1	0	
Count of PACS Detected TIP Parity Errors	139	140	u	2	1	0	

Sum of All Auxiliary Sync Errors Detected in the Input Data	141	142	u	2	1	0	
Time Sequence Error (<i>range: 0 - 65,535</i>) (0 = none; otherwise the record number of the first occurrence)	143	144	u	2	1	0	
Time Sequence Error Code These are bit flags taken from Scan Line Quality Flags Time Problem Code on data record reported in Time Sequence Error field above. If a bit is on (=1) then the statement is true. bits 15 - 8: <Zero fill> bit 7: time field is bad but can probably be inferred from the previous good time. bit 6: time field is bad and can't be inferred from the previous good time. bit 5: this record starts a sequence that is inconsistent with previous times (i.e., there is a time discontinuity). This may or may not be associated with a spacecraft clock update. bit 4: start of a sequence that apparently repeats scan times that have been previously accepted. bits 3 - 0: <Zero fill>	145	146	u	2	1	0	
SOCC Clock Update Indicator (0 = none during this orbit; otherwise the record number of the first occurrence)	147	148	u	2	1	0	
Earth Location Error Indicator (0 = none during this orbit; otherwise the record number of the first occurrence)	149	150	u	2	1	0	
Earth Location Error Code These are bit flags taken from Scan Line Quality Flags Earth Location Problem Code on data record reported in Earth Location Error Indicator field above. If a bit is on (=1) then the statement is true.	151	152	u	2	1	0	

bits 15 - 8: <Zero fill> bit 7: not earth located because of bad time; earth location fields Zero filled. bit 6: earth location questionable because of questionable time code. (See time problem flags above.) bit 5: earth location questionable - only marginal agreement with reasonableness check. bit 4: earth location questionable - fails reasonableness check. bits 3-0: <Zero fill>							
PACS Status Bit Field bit15-3: <zero fill> bit 2: pseudo noise (0 = normal data; 1 = P/N data) bit 1: tape direction (0 = reverse playback, time decrementing) bit 0: data mode (0 = test data; 1 = flight data)	153	154	u	2	1	0	
PACS Data Source 0 = unused; 1 = Fairbanks; 2 = Wallops; 3 = SOCC; 4 = Svalbard, Norway; 5 = Monterey, CA	155	156	u	2	1	0	
<zero fill>	157	160	i	4	1	0	
<Reserved for the Ingester>	161	168	c	8	1	0	
<Reserved for Decommutation>	169	176	c	8	1	0	
<zero fill>	177	186	i	2	5	0	
CALIBRATION							

<p>Ramp/Auto Calibration Indicators Bit Field</p> <p>The ramp calibration signal consists of the output of a D/A generator that increases one step per revolution of the radiometer scanning system. The nominal ramp calibration in the A/D output skips a step approximately once every 62 scan revolutions, and once every 62 steps of the D/A ramp generation.</p> <p>Channels 1, 2, and 3A increment linearly with the scan count, except as previously noted, until the dual gain break point to 500 counts is reached. Channels 3B, 4, and 5 ramp values increment linearly with scan line count, except as previously noted.</p> <p>The following bit fields indicate non-linearity in the ramp calibration signal:</p> <p>bits 15-6: <zero fill> bit 5: ramp non-linearity for GAC, LAC, and HRPT ch 5 bit 4: ramp non-linearity for GAC, LAC, and HRPT ch 4 bit 3: ramp non-linearity for GAC, LAC, and HRPT ch 3b bit 2: ramp non-linearity for GAC, LAC, and HRPT ch 3a bit 1: ramp non-linearity for GAC, LAC, and HRPT ch 2 bit 0: ramp non-linearity for GAC, LAC, and HRPT ch 1</p>	187	188	u	2	1	0	
Year of Most Recent Solar Channel Calibration (e.g., 1999)	189	190	u	2	1	0	
Day of Year of Most Recent Solar Channel Calibration (e.g., 365)	191	192	u	2	1	0	
Primary Calibration Algorithm ID	193	194	u	2	1	0	
<p>Primary Calibration Algorithm Selected Options</p> bit 15: <zero fill> bit 14: Ch 5 resolution (0 = high; 1 = low) bit 13: Ch 5 substitution coefficients (0 = no; 1 = yes) bits 12-10: <zero fill> bit 9: Ch 4 resolution (0 = high; 1 = low) bit 8: Ch 4 substitution coefficients (0 = no; 1 = yes) bits 7-5: <zero fill> bit 4: Ch 3b resolution (0 = high; 1 = low) bit 3: Ch 3b substitution coefficients (0 = no; 1 = yes) bits 2-0: <zero fill>	195	196	u	2	1	0	
Secondary Calibration Algorithm ID	197	198	u	2	1	0	
<p>Secondary Calibration Algorithm Selected Options</p> bit 15: <zero fill> bit 14: Ch 5 resolution (0 = high; 1 = low) bit 13: Ch 5 substitution coefficients (0 = no; 1 = yes)	199	200	u	2	1	0	

bits 12-10: <zero fill> bit 9: Ch 4 resolution (0 = high; 1 = low) bit 8: Ch 4 substitution coefficients (0 = no; 1 = yes) bits 7-5: <zero fill> bit 4: Ch 3b resolution (0 = high; 1 = low) bit 3: Ch 3b substitution coefficients (0 = no; 1 = yes) bits 2-0: <zero fill>							
IR Target Temperature 1 Conversion Coefficient 1	201	202	i	2	1	2	
IR Target Temperature 1 Conversion Coefficient 2	203	204	i	2	1	5	
IR Target Temperature 1 Conversion Coefficient 3	205	206	i	2	1	8	
IR Target Temperature 1 Conversion Coefficient 4	207	208	i	2	1	11	
IR Target Temperature 1 Conversion Coefficient 5	209	210	i	2	1	14	
IR Target Temperature 1 Conversion Coefficient 6	211	212	i	2	1	17	
IR Target Temperature 2 Conversion Coefficient 1	213	214	i	2	1	2	
IR Target Temperature 2 Conversion Coefficient 2	215	216	i	2	1	5	
IR Target Temperature 2 Conversion Coefficient 3	217	218	i	2	1	8	
IR Target Temperature 2 Conversion Coefficient 4	219	220	i	2	1	11	
IR Target Temperature 2 Conversion Coefficient 5	221	222	i	2	1	14	
IR Target Temperature 2 Conversion Coefficient 6	223	224	i	2	1	17	
IR Target Temperature 3 Conversion Coefficient 1	225	226	i	2	1	2	
IR Target Temperature 3 Conversion Coefficient 2	227	228	i	2	1	5	

IR Target Temperature 3 Conversion Coefficient 3	229	230	i	2	1	8	
IR Target Temperature 3 Conversion Coefficient 4	231	232	i	2	1	11	
IR Target Temperature 3 Conversion Coefficient 5	233	234	i	2	1	14	
IR Target Temperature 3 Conversion Coefficient 6	235	236	i	2	1	17	
IR Target Temperature 4 Conversion Coefficient 1	237	238	i	2	1	2	
IR Target Temperature 4 Conversion Coefficient 2	239	240	i	2	1	5	
IR Target Temperature 4 Conversion Coefficient 3	241	242	i	2	1	8	
IR Target Temperature 4 Conversion Coefficient 4	243	244	i	2	1	11	
IR Target Temperature 4 Conversion Coefficient 5	245	246	i	2	1	14	
IR Target Temperature 4 Conversion Coefficient 6	247	248	i	2	1	17	
<zero fill>	249	256	i	4	2	0	
RADIANCE CONVERSION							
Ch 1 Solar Filtered Irradiance in Wavelength	257	260	i	4	1	1	
Ch 1 Equivalent Filter Width in Wavelength	261	264	i	4	1	3	
Ch 2 Solar Filtered Irradiance in Wavelength	265	268	i	4	1	1	
Ch 2 Equivalent Filter Width in Wavelength	269	272	i	4	1	3	
Ch 3a Solar Filtered Irradiance in Wavelength	273	276	i	4	1	1	

Ch 3a Equivalent Filter Width in Wavelength	277	280	i	4	1	3	
Ch 3b Central Wavenumber	281	284	i	4	1	2	
Ch 3b Constant 1	285	288	i	4	1	5	
Ch 3b Constant 2	289	292	i	4	1	6	
Ch 4 Central Wavenumber	293	296	i	4	1	3	
Ch 4 Constant 1	297	300	i	4	1	5	
Ch 4 Constant 2	301	304	i	4	1	6	
Ch 5 Central Wavenumber	305	308	i	4	1	3	
Ch 5 Constant 1	309	312	i	4	1	5	
Ch 5 Constant 2	313	316	i	4	1	6	
<zero fill>	317	328	i	4	3	0	
NAVIGATION							
Reference Ellipsoid Model ID The ellipsoid is a mathematically tractable approximation of the geoid, which is an equipotential surface at mean sea level. The maximum departure of the ellipsoid from the geoid is approximately ± 65 meters. (WGS-72 = World Geodetic Survey 1972)	329	336	c	8	1	0	
Nadir Earth Location Tolerance	337	338	u	2	1	1	km
Earth Location Bit Field bits 15 - 2: <zero fill> bit 1: reasonableness test active (0 = inactive) bit 0: attitude error correction (0 = not corrected)	339	340	u	2	1	0	

<zero fill>	341	342	i	2	1	0	
Constant Roll Attitude Error in Degrees	343	344	i	2	1	3	deg
Constant Pitch Attitude Error in Degrees	345	346	i	2	1	3	deg
Constant Yaw Attitude Error in Degrees	347	348	i	2	1	3	deg
Epoch Year for Orbit Vector	349	350	u	2	1	0	
Day of Epoch Year for Orbit Vector	351	352	u	2	1	0	
Epoch UTC Time of Day for Orbit Vector	353	356	u	4	1	0	ms
Semi-major Axis (<i>at the orbit vector epoch time</i>)	357	360	i	4	1	5	Km
Eccentricity (<i>at the orbit vector epoch time</i>)	361	364	i	4	1	8	
Inclination (<i>at the orbit vector epoch time</i>)	365	368	i	4	1	5	deg
Argument of Perigee (<i>at the orbit vector epoch time</i>)	369	372	i	4	1	5	deg
Right Ascension of the Ascending Node (<i>at the orbit vector epoch time</i>)	373	376	i	4	1	5	deg
Mean Anomaly (<i>at the orbit vector epoch time</i>)	377	380	i	4	1	5	deg
Position Vector X Component (<i>at the orbit vector epoch time</i>)	381	384	i	4	1	5	Km
Position Vector Y Component (<i>at the orbit vector epoch time</i>)	385	388	i	4	1	5	km
Position Vector Z Component (<i>at the orbit vector epoch time</i>)	389	392	i	4	1	5	km
Velocity Vector X-dot Component (<i>at the orbit vector epoch time</i>)	393	396	i	4	1	8	km/sec

Velocity Vector Y-dot Component <i>(at the orbit vector epoch time)</i>	397	400	i	4	1	8	km/sec
Velocity Vector Z-dot Component <i>(at the orbit vector epoch time)</i>	401	404	i	4	1	8	km/sec
Earth/Sun Distance Ratio <i>(at the orbit vector epoch time; relative to the mean distance of 1 AU)</i>	405	408	u	4	1	6	
<zero fill>	409	424	i	4	4	0	
ANALOG TELEMETRY CONVERSION <i>Volts-to-engineering units conversion coefficients for the analog telemetry items.</i>							
Patch Temperature Conversion Coefficient 1	425	426	i	2	1	2	
Patch Temperature Conversion Coefficient 2	427	428	i	2	1	2	
Patch Temperature Conversion Coefficient 3	429	430	i	2	1	2	
Patch Temperature Conversion Coefficient 4	431	432	i	2	1	2	
Patch Temperature Conversion Coefficient 5	433	434	i	2	1	2	
<Reserved>	435	436	i	2	1	2	
Patch Temperature Extended Conversion Coefficient 1	437	438	i	2	1	2	
Patch Temperature Extended Conversion Coefficient 2	439	440	i	2	1	2	
Patch Temperature Extended Conversion Coefficient 3	441	442	i	2	1	2	
Patch Temperature Extended Conversion Coefficient 4	443	444	i	2	1	2	
Patch Temperature Extended Conversion Coefficient 5	445	446	i	2	1	2	
<Reserved>	447	448	i	2	1	2	

Patch Power Conversion Coefficient 1	449	450	i	2	1	2	
Patch Power Conversion Coefficient 2	451	452	i	2	1	2	
Patch Power Conversion Coefficient 3	453	454	i	2	1	2	
Patch Power Conversion Coefficient 4	455	456	i	2	1	2	
Patch Power Conversion Coefficient 5	457	458	i	2	1	2	
<Reserved>	459	460	i	2	1	2	
Radiator Temperature Conversion Coefficient 1	461	462	i	2	1	2	
Radiator Temperature Conversion Coefficient 2	463	464	i	2	1	2	
Radiator Temperature Conversion Coefficient 3	465	466	i	2	1	2	
Radiator Temperature Conversion Coefficient 4	467	468	i	2	1	2	
Radiator Temperature Conversion Coefficient 5	469	470	i	2	1	2	
<Reserved>	471	472	i	2	1	2	
Blackbody Temperature 1 Conversion Coefficient 1	473	474	i	2	1	2	
Blackbody Temperature 1 Conversion Coefficient 2	475	476	i	2	1	2	
Blackbody Temperature 1 Conversion Coefficient 3	477	478	i	2	1	2	
Blackbody Temperature 1 Conversion Coefficient 4	479	480	i	2	1	2	
Blackbody Temperature 1 Conversion Coefficient 5	481	482	i	2	1	2	

<Reserved>	483	484	i	2	1	2	
Blackbody Temperature 2 Conversion Coefficient 1	485	486	i	2	1	2	
Blackbody Temperature 2 Conversion Coefficient 2	487	488	i	2	1	2	
Blackbody Temperature 2 Conversion Coefficient 3	489	490	i	2	1	2	
Blackbody Temperature 2 Conversion Coefficient 4	491	492	i	2	1	2	
Blackbody Temperature 2 Conversion Coefficient 5	493	494	i	2	1	2	
<Reserved>	495	496	i	2	1	2	
Blackbody Temperature 3 Conversion Coefficient 1	497	498	i	2	1	2	
Blackbody Temperature 3 Conversion Coefficient 2	499	500	i	2	1	2	
Blackbody Temperature 3 Conversion Coefficient 3	501	502	i	2	1	2	
Blackbody Temperature 3 Conversion Coefficient 4	503	504	i	2	1	2	
Blackbody Temperature 3 Conversion Coefficient 5	505	506	i	2	1	2	
<Reserved>	507	508	i	2	1	2	
Blackbody Temperature 4 Conversion Coefficient 1	509	510	i	2	1	2	
Blackbody Temperature 4 Conversion Coefficient 2	511	512	i	2	1	2	
Blackbody Temperature 4 Conversion Coefficient 3	513	514	i	2	1	2	
Blackbody Temperature 4 Conversion Coefficient 4	515	516	i	2	1	2	

Blackbody Temperature 4 Conversion Coefficient 5	517	518	i	2	1	2	
<Reserved>	519	520	i	2	1	2	
Electronics Current Conversion Coefficient 1	521	522	i	2	1	2	
Electronics Current Conversion Coefficient 2	523	524	i	2	1	2	
Electronics Current Conversion Coefficient 3	525	526	i	2	1	2	
Electronics Current Conversion Coefficient 4	527	528	i	2	1	2	
Electronics Current Conversion Coefficient 5	529	530	i	2	1	2	
<Reserved>	531	532	i	2	1	2	
Motor Current Conversion Coefficient 1	533	534	i	2	1	2	
Motor Current Conversion Coefficient 2	535	536	i	2	1	2	
Motor Current Conversion Coefficient 3	537	538	i	2	1	2	
Motor Current Conversion Coefficient 4	539	540	i	2	1	2	
Motor Current Conversion Coefficient 5	541	542	i	2	1	2	
<Reserved>	543	544	i	2	1	2	
Earth Shield Position Conversion Coefficient 1	545	546	i	2	1	2	
Earth Shield Position Conversion Coefficient 2	547	548	i	2	1	2	
Earth Shield Position Conversion Coefficient 3	549	550	i	2	1	2	

Earth Shield Position Conversion Coefficient 4	551	552	i	2	1	2	
Earth Shield Position Conversion Coefficient 5	553	554	i	2	1	2	
<Reserved>	555	556	i	2	1	2	
Electronics Temperature Conversion Coefficient 1	557	558	i	2	1	2	
Electronics Temperature Conversion Coefficient 2	559	560	i	2	1	2	
Electronics Temperature Conversion Coefficient 3	561	562	i	2	1	2	
Electronics Temperature Conversion Coefficient 4	563	564	i	2	1	2	
Electronics Temperature Conversion Coefficient 5	565	566	i	2	1	2	
<Reserved>	567	568	i	2	1	2	
Cooler Housing Temperature Conversion Coefficient 1	569	570	i	2	1	2	
Cooler Housing Temperature Conversion Coefficient 2	571	572	i	2	1	2	
Cooler Housing Temperature Conversion Coefficient 3	573	574	i	2	1	2	
Cooler Housing Temperature Conversion Coefficient 4	575	576	i	2	1	2	
Cooler Housing Temperature Conversion Coefficient 5	577	578	i	2	1	2	
<Reserved>	579	580	i	2	1	2	
Baseplate Temperature Conversion Coefficient 1	581	582	i	2	1	2	
Baseplate Temperature Conversion Coefficient 2	583	584	i	2	1	2	

Baseplate Temperature Conversion Coefficient 3	585	586	i	2	1	2	
Baseplate Temperature Conversion Coefficient 4	587	588	i	2	1	2	
Baseplate Temperature Conversion Coefficient 5	589	590	i	2	1	2	
<Reserved>	591	592	i	2	1	2	
Motor Housing Temperature Conversion Coefficient 1	593	594	i	2	1	2	
Motor Housing Temperature Conversion Coefficient 2	595	596	i	2	1	2	
Motor Housing Temperature Conversion Coefficient 3	597	598	i	2	1	2	
Motor Housing Temperature Conversion Coefficient 4	599	600	i	2	1	2	
Motor Housing Temperature Conversion Coefficient 5	601	602	i	2	1	2	
<Reserved>	603	604	i	2	1	2	
A/D Converter Temperature Conversion Coefficient 1	605	606	i	2	1	2	
A/D Converter Temperature Conversion Coefficient 2	607	608	i	2	1	2	
A/D Converter Temperature Conversion Coefficient 3	609	610	i	2	1	2	
A/D Converter Temperature Conversion Coefficient 4	611	612	i	2	1	2	
A/D Converter Temperature Conversion Coefficient 5	613	614	i	2	1	2	
<Reserved>	615	616	i	2	1	2	
Detector #4 Bias Voltage Conversion Coefficient 1	617	618	i	2	1	2	

Detector #4 Bias Voltage Conversion Coefficient 2	619	620	i	2	1	2	
Detector #4 Bias Voltage Conversion Coefficient 3	621	622	i	2	1	2	
Detector #4 Bias Voltage Conversion Coefficient 4	623	624	i	2	1	2	
Detector #4 Bias Voltage Conversion Coefficient 5	625	626	i	2	1	2	
<Reserved>	627	628	i	2	1	2	
Detector #5 Bias Voltage Conversion Coefficient 1	629	630	i	2	1	2	
Detector #5 Bias Voltage Conversion Coefficient 2	631	632	i	2	1	2	
Detector #5 Bias Voltage Conversion Coefficient 3	633	634	i	2	1	2	
Detector #5 Bias Voltage Conversion Coefficient 4	635	636	i	2	1	2	
Detector #5 Bias Voltage Conversion Coefficient 5	637	638	i	2	1	2	
<Reserved>	639	640	i	2	1	2	
Channel 3b Blackbody View Conversion Coefficient 1	641	642	i	2	1	0	
Channel 3b Blackbody View Conversion Coefficient 2	643	644	i	2	1	0	
Channel 3b Blackbody View Conversion Coefficient 3	645	646	i	2	1	0	
Channel 3b Blackbody View Conversion Coefficient 4	647	648	i	2	1	0	
Channel 3b Blackbody View Conversion Coefficient 5	649	650	i	2	1	0	
<Reserved>	651	652	i	2	1	0	

Channel 4 Blackbody View Conversion Coefficient 1	653	654	i	2	1	2	
Channel 4 Blackbody View Conversion Coefficient 2	655	656	i	2	1	2	
Channel 4 Blackbody View Conversion Coefficient 3	657	658	i	2	1	2	
Channel 4 Blackbody View Conversion Coefficient 4	659	660	i	2	1	2	
Channel 4 Blackbody View Conversion Coefficient 5	661	662	i	2	1	2	
<Reserved>	663	664	i	2	1	2	
Channel 5 Blackbody View Conversion Coefficient 1	665	666	i	2	1	0	
Channel 5 Blackbody View Conversion Coefficient 2	667	668	i	2	1	0	
Channel 5 Blackbody View Conversion Coefficient 3	669	670	i	2	1	0	
Channel 5 Blackbody View Conversion Coefficient 4	671	672	i	2	1	0	
Channel 5 Blackbody View Conversion Coefficient 5	673	674	i	2	1	0	
<Reserved>	675	676	i	2	1	0	
Reference Voltage Conversion Coefficient 1	677	678	i	2	1	2	
Reference Voltage Conversion Coefficient 2	679	680	i	2	1	2	
Reference Voltage Conversion Coefficient 3	681	682	i	2	1	2	
Reference Voltage Conversion Coefficient 4	683	684	i	2	1	2	
Reference Voltage Conversion Coefficient 5	685	686	i	2	1	2	

<Reserved>	687	688	i	2	1	2	
FILLER							
<zero fill> <EOR> = 15872 for packed datasets <EOR> = 22528 for unpacked datasets	689	<EOR>	i	4	??	0	

8.3.1.3.2.2 NOAA-N Format (Version 5, post-November 14, 2006, all spacecraft)

The format specifications for the AVHRR Level 1b header record for NOAA-N satellite is given in this section. Please note that as part of the updates to the Level 1b formats for NOAA-N there is the inclusion of additional or secondary header records. Applications that will access Level 1b data sets should use the “Count of Header Records in this Data Set” field, located in the first, or primary, header record to calculate the position of the first data record and skip the secondary header records.

Except for the zero-fill padding, the primary header record specification is identical no matter the type of AVHRR data (LAC, GAC, FRAC or HRPT). Table 8.3.3.2.2-1 gives the format for the AVHRR Level 1b primary header record for NOAA-N (Version 4/5), post November 14, 2006 (all spacecraft). The GAC data was version 4 (v4) and the LAC/HRPT was version 5 (v5).

Table 8.3.1.3.2.2-1. Format of LAC/HRPT Data Set Header Record (Version 5, post-November 14, 2006, all spacecraft).							
Field Name	Start Octet	End Octet	Data Type	Word Size	Number of Words	Scale Factor	Units
Field Name							
Data Set Creation Site ID CMS=Centre de Meteorologie Spatiale/France DSS=Dundee Satellite Receiving Station/UK NSS=National Environmental Satellite, Data and Information Service/USA UKM=United Kingdom Meteorological Office/UK	1	3	c	3	1	0	
<ASCII blank = x20>	4	4	c	1	1	0	
Level 1b Format Version Number: 1=TIROS-N, NOAA-6 through NOAA-14; 2=NOAA-15, -16, -17 (pre-April 28, 2005); 3=all satellites post-April 28, 2005; 4=cloud mask flag (CLAVRx)-Jan 25, 2006. 5=no format change (LAC/HRPT only) - Nov 14, 2006.	5	6	u	2	1	0	

Level 1b Format Version Year (e.g., 1999)	7	8	u	2	1	0	
Level 1b Format Version Day of Year (e.g., 365)	9	10	u	2	1	0	
<Reserved for Logical Record Length> (For Creation Site use only. Logical Record Length of source Level 1b data set prior to processing.)	11	12	u	2	1	0	octets
<Reserved for Block Size> (For Creation Site use only. Block Size of source Level 1b data set prior to processing.)	13	14	u	2	1	0	octets
Count of Header Records in this Data Set	15	16	u	2	1	0	
<zero fill>	17	22	i	2	3	0	
Data Set Name	23	64	c	42	1	0	
Processing Block Identification	65	72	c	8	1	0	
NOAA Spacecraft Identification Code 2=NOAA-15 4=NOAA-16 6=NOAA-17 7=NOAA-18 8=NOAA-19 11=MetOp-B 12=MetOp-A 13=MetOp-3	73	74	u	2	1	0	
Instrument ID 301=s/n A301 (NOAA-16) 302=s/n A302 (NOAA-15) 304=s/n A304 (NOAA-17) 308=s/n A308 (NOAA-N') 306=s/n A306 (NOAA-18) 307=s/n A307 (Met Op 1) 305=s/n A305 (Met Op 2)	75	76	u	2	1	0	
Data Type Code 1=LAC 2=GAC (includes NOAA GAC and "GACized" Metop AVHRR) 3=NOAA HRPT 13=FRAC (MetOp only)	77	78	u	2	1	0	
TIP Source Code 0=unused, i.e., GAC/HRPT/LAC data 1=GAC-embedded AMSU and TIP 2=stored TIP (STIP) 3=HRPT/LAC-embedded AMSU and TIP 4=stored AIP (SAIP)	79	80	u	2	1	0	
Start of Data Set Day Count starting from 0 at 00h, 1	81	84	u	4	1	0	

Jan 1950							
Start of Data Set Year (e.g., 1999)	85	86	u	2	1	0	
Start of Data Set Day of Year (e.g., 365)	87	88	u	2	1	0	
Start of Data Set UTC Time of Day	89	92	u	4	1	0	ms
End of Data Set Day Count starting from 0 at 00h, 1 Jan 1950	93	96	u	4	1	0	
End of Data Set Year (e.g., 1999)	97	98	u	2	1	0	
End of Data Set Day of Year (e.g., 365)	99	100	u	2	1	0	
End of Data Set UTC Time of Day	101	104	u	4	1	0	ms
Year of Last CPIDS Update (e.g., 1999)	105	106	u	2	1	0	
Day of Year of Last CPIDS Update (e.g., 365)	107	108	u	2	1	0	
<zero fill>	109	116	i	2	4	0	
Instrument Status (<i>These are bit flags taken from the AVHRR Digital B Data field on first data record for which all of the individual status flags have been reported at least once.</i>) bits 31-16: <zero fill> bit 15: scan motor/telemetry status (0=off; 1=on) bit 14: electronics/telemetry status (0=off; 1=on) bit 13: channel 1 status (0=disable; 1=enable) bit 12: channel 2 status (0=disable; 1=enable) bit 11: channel 3A status (0=disable; 1=enable) bit 10: channel 3B status (0=disable; 1=enable) bit 9: channel 4 status (0=disable; 1=enable) bit 8: channel 5 status (0=disable; 1=enable) bit 7: channel 3A/3B select status (0=3B; 1=3A) bit 6: voltage calibration status (0=off; 1=on) bit 5: cooler heat status (0=off; 1=on) bit 4: scan motor mode status (0=low; 1=high) bit 3: telemetry lock status (0=not locked on; 1=locked on) bit 2: earth shield status (0=disable; 1=deploy) bit 1: patch control status (0=off; 1=on) bit 0: <zero fill>	117	120	u	4	1	0	
<zero fill>	121	122	i	2	1	0	
Record Number of Status Change (<i>if 0, none occurred; range: 0 - 65,535</i>)	123	124	u	2	1	0	
Second Instrument Status (<i>if previous word is 0, no change</i>)	125	128	u	4	1	0	

Count of Data Records in this Data Set (<i>range: 0 - 65,535</i>)	129	130	u	2	1	0	
Count of Calibrated, Earth Located Scan Lines in this Data Set (<i>range: 0 - 65,535</i>)	131	132	u	2	1	0	
Count of Missing Scan Lines (<i>range: 0 - 65,535</i>)	133	134	u	2	1	0	
Count of Data Gaps in this Data Set	135	136	u	2	1	0	
Count of Data Frames Without Frame Sync Word Errors (NOAA) or <zero fill> MetOp	137	138	u	2	1	0	
Count of PACS Detected TIP Parity Errors (NOAA) or <zero fill> MetOp	139	140	u	2	1	0	
Sum of All Auxiliary Sync Errors Detected in the Input Data (NOAA) or <zero fill> MetOp	141	142	u	2	1	0	
Time Sequence Error (<i>range: 0 - 65,535</i>) 0=none; otherwise, the record number of the first occurrence	143	144	u	2	1	0	
Time Sequence Error Code (<i>These are bit flags taken from Scan Line Quality Flags [Time Problem Code] on data record reported in Time Sequence Error field above. If a bit is on (=1) then the statement is true.</i>) bits 15-8: <zero fill> bit 7: time field is bad but can probably be inferred from the previous good time bit 6: time field is bad and can't be inferred from the previous good time bit 5: this record starts a sequence that is inconsistent with previous times (i.e., there is a time discontinuity); may be associated with a spacecraft clock update bit 4: start of a sequence that apparently repeats scan times that have been previously accepted bits 3-0: <zero fill>	145	146	u	2	1	0	
SOCC Clock Update Indicator (<i>range: 0 - 65,535</i>) 0=none during this orbit; otherwise, the record number of the first occurrence	147	148	u	2	1	0	
Earth Location Error Indicator (<i>range: 0 - 65,535</i>) 0=none during this orbit; otherwise, the record number of the first occurrence	149	150	u	2	1	0	
Earth Location Error Code (<i>These are bit flags taken from Scan Line Quality Flags [Earth Location Problem Code] on data record reported in Earth Location Error Indicator field above. If a bit is on (=1) then the statement is true.</i>)	151	152	u	2	1	0	

bits 15-8: <zero fill> bit 7: not earth located because of bad time; earth location fields zero-filled bit 6: earth location questionable: questionable time code bit 5: earth location questionable: marginal agreement with reasonableness check bit 4: earth location questionable: fails reasonableness check bits 3-2: <zero fill> (NOAA) bit 1: not earth located because of satellite in-plane maneuver (MetOp) or <zero fill> (NOAA) bit 0: not earth located because of satellite out-of-plane maneuver (MetOp) or <zero fill> (NOAA)							
PACS Status Bit Field bits 15-3: <zero fill> bit 2: pseudonoise (0=normal data; 1=pseudonoise data) bit 1: tape direction (0=reverse playback, time decrementing) bit 0: data mode (0=test data; 1=flight data)	153	154	u	2	1	0	
Data Source 0=unused 1=Fairbanks, AK 2=Wallops Is., VA 3=SOCC 4=Svalbard, Norway 5=Monterey, CA	155	156	u	2	1	0	
<zero fill>	157	160	i	4	1	0	
<Reserved for the Ingester>	161	168	c	8	1	0	
<Reserved for Decommutation>	169	176	c	8	1	0	
<zero fill>	177	186	i	2	5	0	
CALIBRATION							
Ramp Calibration Indicators Bit Field (<i>The ramp calibration signal consists of the output of a D/A generator that increases one step per revolution of the radiometer scanning system. The nominal ramp calibration in the A/D output skips a step approximately once every 62 scan revolutions, and once every 62 steps of the D/A ramp generation. Channels 1, 2, and 3A increment linearly with the scan count, except as previously noted, until the dual gain break point to 500 counts is reached. Channels 3B, 4,</i>	187	188	u	2	1	0	

and 5 ramp values increment linearly with scan line count, except as previously noted. The following bit fields indicate non-linearity in the ramp calibration signal.) bits 15-6: <zero fill> bit 5: ramp non-linearity for channel 5 bit 4: ramp non-linearity for channel 4 bit 3: ramp non-linearity for channel 3B bit 2: ramp non-linearity for channel 3A bit 1: ramp non-linearity for channel 2 bit 0: ramp non-linearity for channel 1							
Year of Most Recent Solar Channel Calibration (four digit year)	189	190	u	2	1	0	
Day of Year of Most Recent Solar Channel Calibration (three digit day)	191	192	u	2	1	0	
Primary Calibration Algorithm ID	193	194	u	2	1	0	
Primary Calibration Algorithm Selected Options bit 15: <zero fill> bit 14: Ch 5 resolution (0=high; 1=low) bit 13: Ch 5 substitution coefficients (0=no; 1=yes) bits 12-10: <zero fill> bit 9: Ch 4 resolution (0=high; 1=low) bit 8: Ch 4 substitution coefficients (0=no; 1=yes) bits 7-5: <zero fill> bit 4: Ch 3B resolution (0=high; 1=low) bit 3: Ch 3B substitution coefficients (0=no; 1=yes) bits 2-0: <zero fill>	195	196	u	2	1	0	
Secondary Calibration Algorithm ID	197	198	u	2	1	0	
Secondary Calibration Algorithm Selected Options bit 15: <zero fill> bit 14: Ch 5 resolution (0=high; 1=low) bit 13: Ch 5 substitution coefficients (0=no; 1=yes) bits 12-10: <zero fill> bit 9: Ch 4 resolution (0=high; 1=low) bit 8: Ch 4 substitution coefficients (0=no; 1=yes) bits 7-5: <zero fill> bit 4: Ch 3B resolution (0=high; 1=low) bit 3: Ch 3B substitution coefficients (0=no; 1=yes) bits 2-0: <zero fill>	199	200	u	2	1	0	
IR Target Temperature 1 Conversion Coefficient 1	201	202	i	2	1	2	K
IR Target Temperature 1 Conversion Coefficient 2	203	204	i	2	1	5	K/counts
IR Target Temperature 1 Conversion Coefficient 3	205	206	i	2	1	8	K/counts ²
IR Target Temperature 1 Conversion Coefficient 4	207	208	i	2	1	11	K/counts ³

IR Target Temperature 1 Conversion Coefficient 5	209	210	i	2	1	14	K/counts ⁴
IR Target Temperature 1 Conversion Coefficient 6	211	212	i	2	1	17	K/counts ⁵
IR Target Temperature 2 Conversion Coefficient 1	213	214	i	2	1	2	K
IR Target Temperature 2 Conversion Coefficient 2	215	216	i	2	1	5	K/counts
IR Target Temperature 2 Conversion Coefficient 3	217	218	i	2	1	8	K/counts ²
IR Target Temperature 2 Conversion Coefficient 4	219	220	i	2	1	11	K/counts ³
IR Target Temperature 2 Conversion Coefficient 5	221	222	i	2	1	14	K/counts ⁴
IR Target Temperature 2 Conversion Coefficient 6	223	224	i	2	1	17	K/counts ⁵
IR Target Temperature 3 Conversion Coefficient 1	225	226	i	2	1	2	K
IR Target Temperature 3 Conversion Coefficient 2	227	228	i	2	1	5	K/counts
IR Target Temperature 3 Conversion Coefficient 3	229	230	i	2	1	8	K/counts ²
IR Target Temperature 3 Conversion Coefficient 4	231	232	i	2	1	11	K/counts ³
IR Target Temperature 3 Conversion Coefficient 5	233	234	i	2	1	14	K/counts ⁴
IR Target Temperature 3 Conversion Coefficient 6	235	236	i	2	1	17	K/counts ⁵
IR Target Temperature 4 Conversion Coefficient 1	237	238	i	2	1	2	K
IR Target Temperature 4 Conversion Coefficient 2	239	240	i	2	1	5	K/counts
IR Target Temperature 4 Conversion Coefficient 3	241	242	i	2	1	8	K/counts ²
IR Target Temperature 4 Conversion Coefficient 4	243	244	i	2	1	11	K/counts ³
IR Target Temperature 4 Conversion Coefficient 5	245	246	i	2	1	14	K/counts ⁴
IR Target Temperature 4 Conversion Coefficient 6	247	248	i	2	1	17	K/counts ⁵
<zero fill>	249	256	i	4	2	0	
Ch 1 Solar filtered Irradiance in Wavelength	257	260	i	4	1	1	
Ch 1 Equivalent Filter Width in Wavelength	261	264	i	4	1	1	
Ch 2 Solar Filtered Irradiance in Wavelength	265	268	i	4	1	1	
Ch 2 Equivalent Filter Width in Wavelength	269	272	i	4	1	1	
Ch 3A Solar Filtered Irradiance in Wavelength	273	276	i	4	1	1	
Ch 3A Equivalent Filter Width in Wavelength	277	280	i	4	1	3	
Ch 3B Central Wavenumber	281	284	i	4	1	2	cm ⁻¹
Ch 3B Constant 1	285	288	i	4	1	5	

Ch 3B Constant 2	289	292	i	4	1	6	
Ch 4 Central Wavenumber	293	296	i	4	1	3	cm ⁻¹
Ch 4 Constant 1	297	300	i	4	1	5	
Ch 4 Constant 2	301	304	i	4	1	6	
Ch 5 Central Wavenumber	305	308	i	4	1	3	cm ⁻¹
Ch 5 Constant 1	309	312	i	4	1	5	
Ch 5 Constant 2	313	316	i	4	1	6	
<zero fill>	317	328	i	4	3	0	
NAVIGATION							
Reference Ellipsoid Model ID (<i>The ellipsoid is a mathematically tractable approximation of the geoid, which is an equipotential surface at mean sea level. The maximum departure of the ellipsoid from the geoid is approximately ± 65 meters.</i>) WGS-72=World Geodetic Survey 1972 JGM3 =Joint Gravity Model 3	329	336	c	8	1	0	
Nadir Earth Location Tolerance	337	338	u	2	1	1	km
Earth Location Bit Field bits 15-3: <zero fill> bit 2: dynamic attitude error correction (0=not performed; 1=performed) bit 1: reasonableness test (0=inactive; 1=active) bit 0: constant attitude error correction (0=not performed; 1=performed)	339	340	u	2	1	0	
<zero fill>	341	342	i	2	1	0	
Constant Roll Attitude Error	343	344	i	2	1	3	degrees
Constant Pitch Attitude Error	345	346	i	2	1	3	degrees
Constant Yaw Attitude Error	347	348	i	2	1	3	degrees
Epoch Year for Orbit Vector	349	350	u	2	1	0	
Day of Epoch Year for Orbit Vector	351	352	u	2	1	0	
Epoch UTC Time of Day for Orbit Vector	353	356	u	4	1	0	millisec
Semi-major Axis (<i>at the orbit vector epoch time</i>)	357	360	i	4	1	5	km
Eccentricity (<i>at the orbit vector epoch time</i>)	361	364	i	4	1	8	
Inclination (<i>at the orbit vector epoch time</i>)	365	368	i	4	1	5	degrees

Argument of Perigee (<i>at the orbit vector epoch time</i>)	369	372	i	4	1	5	degrees
Right Ascension of the Ascending Node (<i>at the orbit vector epoch time</i>)	373	376	i	4	1	5	degrees
Mean Anomaly (<i>at the orbit vector epoch time</i>)	377	380	i	4	1	5	degrees
Position Vector X Component (<i>at the orbit vector epoch time</i>)	381	384	i	4	1	5	km
Position Vector Y Component (<i>at the orbit vector epoch time</i>)	385	388	i	4	1	5	km
Position Vector Z Component (<i>at the orbit vector epoch time</i>)	389	392	i	4	1	5	km
Velocity Vector X-dot Component (<i>at the orbit vector epoch time</i>)	393	396	i	4	1	8	km/sec
Velocity Vector Y-dot Component (<i>at the orbit vector epoch time</i>)	397	400	i	4	1	8	km/sec
Velocity Vector Z-dot Component (<i>at the orbit vector epoch time</i>)	401	404	i	4	1	8	km/sec
Earth/Sun Distance Ratio (<i>at the orbit vector epoch time; relative to the mean distance of 1 AU</i>)	405	408	u	4	1	6	
<zero fill>	409	424	i	4	4	0	
ANALOG TELEMETRY CONVERSION							
<i>Volts-to-engineering units conversion coefficients for the analog telemetry items. (1 count = .02 volts)</i>							
Patch Temperature Conversion Coefficient 1	425	428	i	4	1	6	K
Patch Temperature Conversion Coefficient 2	429	432	i	4	1	6	K/volts
Patch Temperature Conversion Coefficient 3	433	436	i	4	1	7	K/volts ²
Patch Temperature Conversion Coefficient 4	437	440	i	4	1	8	K/volts ³
Patch Temperature Conversion Coefficient 5	441	444	i	4	1	9	K/volts ⁴
Patch Temperature Conversion Coefficient 6	445	448	i	4	1	10	K/volts ⁵
Patch Temperature Extended Conversion Coefficient 1	449	452	i	4	1	6	K
Patch Temperature Extended Conversion Coefficient 2	453	456	i	4	1	6	K/volts
Patch Temperature Extended Conversion Coefficient 3	457	460	i	4	1	7	K/volts ²
Patch Temperature Extended Conversion Coefficient 4	461	464	i	4	1	8	K/volts ³
Patch Temperature Extended Conversion Coefficient 5	465	468	i	4	1	9	K/volts ⁴
Patch Temperature Extended Conversion Coefficient 6	469	472	i	4	1	10	K/volts ⁵

Patch Power Conversion Coefficient 1	473	476	i	4	1	6	mW
Patch Power Conversion Coefficient 2	477	480	i	4	1	6	mW/volts
Patch Power Conversion Coefficient 3	481	484	i	4	1	7	mW/volts ²
Patch Power Conversion Coefficient 4	485	488	i	4	1	8	mW/volts ³
Patch Power Conversion Coefficient 5	489	492	i	4	1	9	mW/volts ⁴
Patch Power Conversion Coefficient 6	493	496	i	4	1	10	mW/volts ⁵
Radiator Temperature Conversion Coefficient 1	497	500	i	4	1	6	K
Radiator Temperature Conversion Coefficient 2	501	504	i	4	1	6	K/volts
Radiator Temperature Conversion Coefficient 3	505	508	i	4	1	7	K/volts ²
Radiator Temperature Conversion Coefficient 4	509	512	i	4	1	8	K/volts ³
Radiator Temperature Conversion Coefficient 5	513	516	i	4	1	9	K/volts ⁴
Radiator Temperature Conversion Coefficient 6	517	520	i	4	1	10	C/volts ⁵
Blackbody Temperature 1 Conversion Coefficient 1	521	524	i	4	1	6	C
Blackbody Temperature 1 Conversion Coefficient 2	525	528	i	4	1	6	C/volts
Blackbody Temperature 1 Conversion Coefficient 3	529	532	i	4	1	7	C/volts ²
Blackbody Temperature 1 Conversion Coefficient 4	533	536	i	4	1	8	C/volts ³
Blackbody Temperature 1 Conversion Coefficient 5	537	540	i	4	1	9	C/volts ⁴
Blackbody Temperature 1 Conversion Coefficient 6	541	544	i	4	1	10	C/volts ⁵
Blackbody Temperature 2 Conversion Coefficient 1	545	548	i	4	1	6	C
Blackbody Temperature 2 Conversion Coefficient 2	549	552	i	4	1	6	C/volts
Blackbody Temperature 2 Conversion Coefficient 3	553	556	i	4	1	7	C/volts ²
Blackbody Temperature 2 Conversion Coefficient 4	557	560	i	4	1	8	C/volts ³
Blackbody Temperature 2 Conversion Coefficient 5	561	564	i	4	1	9	C/volts ⁴
Blackbody Temperature 2 Conversion Coefficient 6	565	568	i	4	1	10	C/volts ⁵
Blackbody Temperature 3 Conversion Coefficient 1	569	572	i	4	1	6	C
Blackbody Temperature 3 Conversion Coefficient 2	573	576	i	4	1	6	C/volts
Blackbody Temperature 3 Conversion Coefficient 3	577	580	i	4	1	7	C/volts ²
Blackbody Temperature 3 Conversion Coefficient 4	581	584	i	4	1	8	C/volts ³
Blackbody Temperature 3 Conversion Coefficient 5	585	588	i	4	1	9	C/volts ⁴

Blackbody Temperature 3 Conversion Coefficient 6	589	592	i	4	1	10	C/volts ⁵
Blackbody Temperature 4 Conversion Coefficient 1	593	596	i	4	1	6	C
Blackbody Temperature 4 Conversion Coefficient 2	597	600	i	4	1	6	C/volts
Blackbody Temperature 4 Conversion Coefficient 3	601	604	i	4	1	7	C/volts ²
Blackbody Temperature 4 Conversion Coefficient 4	605	608	i	4	1	8	C/volts ³
Blackbody Temperature 4 Conversion Coefficient 5	609	612	i	4	1	9	C/volts ⁴
Blackbody Temperature 4 Conversion Coefficient 6	613	616	i	4	1	10	C/volts ⁵
Electronics Current Conversion Coefficient 1	617	620	i	4	1	6	mA
Electronics Current Conversion Coefficient 2	621	624	i	4	1	6	mA/volts
Electronics Current Conversion Coefficient 3	625	628	i	4	1	7	mA/volts ²
Electronics Current Conversion Coefficient 4	629	632	i	4	1	8	mA/volts ³
Electronics Current Conversion Coefficient 5	633	636	i	4	1	9	mA/volts ⁴
Electronics Current Conversion Coefficient 6	637	640	i	4	1	10	mA/volts ⁵
Motor Current Conversion Coefficient 1	641	644	i	4	1	6	mA
Motor Current Conversion Coefficient 2	645	648	i	4	1	6	mA/volts
Motor Current Conversion Coefficient 3	649	652	i	4	1	7	mA/volts ²
Motor Current Conversion Coefficient 4	653	656	i	4	1	8	mA/volts ³
Motor Current Conversion Coefficient 5	657	660	i	4	1	9	mA/volts ⁴
Motor Current Conversion Coefficient 6	661	664	i	4	1	10	mA/volts ⁵
Earth Shield Position Conversion Coefficient 1	665	668	i	4	1	6	
Earth Shield Position Conversion Coefficient 2	669	672	i	4	1	6	
Earth Shield Position Conversion Coefficient 3	673	676	i	4	1	7	
Earth Shield Position Conversion Coefficient 4	677	680	i	4	1	8	
Earth Shield Position Conversion Coefficient 5	681	684	i	4	1	9	
Earth Shield Position Conversion Coefficient 6	685	688	i	4	1	10	
Electronics Temperature Conversion Coefficient 1	689	692	i	4	1	6	C
Electronics Temperature Conversion Coefficient 2	693	696	i	4	1	6	C/volts
Electronics Temperature Conversion Coefficient 3	697	700	i	4	1	7	C/volts ²
Electronics Temperature Conversion Coefficient 4	701	704	i	4	1	8	C/volts ³

Electronics Temperature Conversion Coefficient 5	705	708	i	4	1	9	C/volts ⁴
Electronics Temperature Conversion Coefficient 6	709	712	i	4	1	10	C/volts ⁵
Cooler Housing Temperature Conversion Coefficient 1	713	716	i	4	1	6	C
Cooler Housing Temperature Conversion Coefficient 2	717	720	i	4	1	6	C/volts
Cooler Housing Temperature Conversion Coefficient 3	721	724	i	4	1	7	C/volts ²
Cooler Housing Temperature Conversion Coefficient 4	725	728	i	4	1	8	C/volts ³
Cooler Housing Temperature Conversion Coefficient 5	729	732	i	4	1	9	C/volts ⁴
Cooler Housing Temperature Conversion Coefficient 6	733	736	i	4	1	10	C/volts ⁵
Baseplate Temperature Conversion Coefficient 1	737	740	i	4	1	6	C
Baseplate Temperature Conversion Coefficient 2	741	744	i	4	1	6	C/volts
Baseplate Temperature Conversion Coefficient 3	745	748	i	4	1	7	C/volts ²
Baseplate Temperature Conversion Coefficient 4	749	752	i	4	1	8	C/volts ³
Baseplate Temperature Conversion Coefficient 5	753	756	i	4	1	9	C/volts ⁴
Baseplate Temperature Conversion Coefficient 6	757	760	i	4	1	10	C/volts ⁵
Motor Housing Temperature Conversion Coefficient 1	761	764	i	4	1	6	C
Motor Housing Temperature Conversion Coefficient 2	765	768	i	4	1	6	C/volts
Motor Housing Temperature Conversion Coefficient 3	769	772	i	4	1	7	C/volts ²
Motor Housing Temperature Conversion Coefficient 4	773	776	i	4	1	8	C/volts ³
Motor Housing Temperature Conversion Coefficient 5	777	780	i	4	1	9	C/volts ⁴
Motor Housing Temperature Conversion Coefficient 6	781	784	i	4	1	10	C/volts ⁵
A/D Converter Temperature Conversion Coefficient 1	785	788	i	4	1	6	C
A/D Converter Temperature Conversion Coefficient 2	789	792	i	4	1	6	C/volts
A/D Converter Temperature Conversion Coefficient 3	793	796	i	4	1	7	C/volts ²
A/D Converter Temperature Conversion Coefficient 4	797	800	i	4	1	8	C/volts ³
A/D Converter Temperature Conversion Coefficient 5	801	804	i	4	1	9	C/volts ⁴
A/D Converter Temperature Conversion Coefficient 6	805	808	i	4	1	10	C/volts ⁵
Detector #4 Bias Voltage Conversion Coefficient 1	809	812	i	4	1	6	
Detector #4 Bias Voltage Conversion Coefficient 2	813	816	i	4	1	6	
Detector #4 Bias Voltage Conversion Coefficient 3	817	820	i	4	1	7	

Detector #4 Bias Voltage Conversion Coefficient 4	821	824	i	4	1	8	
Detector #4 Bias Voltage Conversion Coefficient 5	825	828	i	4	1	9	
Detector #4 Bias Voltage Conversion Coefficient 6	829	832	i	4	1	10	
Detector #5 Bias Voltage Conversion Coefficient 1	833	836	i	4	1	6	
Detector #5 Bias Voltage Conversion Coefficient 2	837	840	i	4	1	6	
Detector #5 Bias Voltage Conversion Coefficient 3	841	844	i	4	1	7	
Detector #5 Bias Voltage Conversion Coefficient 4	845	848	i	4	1	8	
Detector #5 Bias Voltage Conversion Coefficient 5	849	852	i	4	1	9	
Detector #5 Bias Voltage Conversion Coefficient 6	853	856	i	4	1	10	
Blackbody Temperature, Channel 3B, Conversion Coefficient 1	857	860	i	4	1	6	C
Blackbody Temperature, Channel 3B, Conversion Coefficient 2	861	864	i	4	1	6	C/volts
Blackbody Temperature, Channel 3B, Conversion Coefficient 3	865	868	i	4	1	7	C/volts ²
Blackbody Temperature, Channel 3B, Conversion Coefficient 4	869	872	i	4	1	8	C/volts ³
Blackbody Temperature, Channel 3B, Conversion Coefficient 5	873	876	i	4	1	9	C/volts ⁴
Blackbody Temperature, Channel 3B, Conversion Coefficient 6	877	880	i	4	1	10	C/volts ⁵
Blackbody Temperature, Channel 4, Conversion Coefficient 1	881	884	i	4	1	6	C
Blackbody Temperature, Channel 4, Conversion Coefficient 2	885	888	i	4	1	6	C/volts
Blackbody Temperature, Channel 4, Conversion Coefficient 3	889	892	i	4	1	7	C/volts ²
Blackbody Temperature, Channel 4, Conversion Coefficient 4	893	896	i	4	1	8	C/volts ³
Blackbody Temperature, Channel 4, Conversion Coefficient 5	897	900	i	4	1	9	C/volts ⁴
Blackbody Temperature, Channel 4, Conversion Coefficient 6	901	904	i	4	1	10	C/volts ⁵
Blackbody Temperature, Channel 5, Conversion Coefficient 1	905	908	i	4	1	6	C

Blackbody Temperature, Channel 5, Conversion Coefficient 2	909	912	i	4	1	6	C/volts
Blackbody Temperature, Channel 5, Conversion Coefficient 3	913	916	i	4	1	7	C/volts ²
Blackbody Temperature, Channel 5, Conversion Coefficient 4	917	920	i	4	1	8	C/volts ³
Blackbody Temperature, Channel 5, Conversion Coefficient 5	921	924	i	4	1	9	C/volts ⁴
Blackbody Temperature, Channel 5, Conversion Coefficient 6	925	928	i	4	1	10	C/volts ⁵
Reference Voltage Conversion Coefficient 1	929	932	i	4	1	6	
Reference Voltage Conversion Coefficient 2	933	936	i	4	1	6	
Reference Voltage Conversion Coefficient 3	937	940	i	4	1	7	
Reference Voltage Conversion Coefficient 4	941	944	i	4	1	8	
Reference Voltage Conversion Coefficient 5	945	948	i	4	1	9	
Reference Voltage Conversion Coefficient 6	949	952	i	4	1	10	
METOP MANEUVERS IDENTIFICATION							
<i>The fields in this section are MetOP specific. No NOAA originated AVHRR data. These fields are spare (zero fill).</i>							
Start of Maneuver Year (e.g., 2000)	953	954	u	2	1	0	
Start of Maneuver Day (e.g., 365)	955	956	u	2	1	0	
Start of Maneuver UTC time of day	957	960	u	4	1	0	millisec
End of Maneuver Year (e.g., 2000)	961	962	u	2	1	0	
End of Maneuver Day (e.g., 365)	963	964	u	2	1	0	
End of Maneuver UTC time of day	965	968	u	4	1	0	millisec
Zero fill	969	980	i	4	2	0	
Change in Spacecraft Mass Word 1: Mass before maneuver Word 2: Mass after maneuver	981	988	i	4	2	kg	kg
CLOUDS FROM AVHRR (CLAVR)							
Clavr Status Bit Field Bits 15-1: < zero fill > Bit 0: CLAVR processing (0=off; 1=on)	989	990	u	2	1	0	
<zero fill>	991	992	i	2	1	0	

<zero fill>(size depends on type of AVHRR data, as devined below) Reduced resolution: <eor> = 4608; words = 904 Full resolution: <eor> =15872; <words> =3720	993	<eor>	i	4	<words>	0	
--	-----	-------	---	---	---------	---	--

8.3.1.3.3 Data Records

This section describes the format of Local Area Coverage (LAC) and High Resolution Picture Transmission (HRPT) data sets for both NOAA KLM (version 2) and NOAA-N (version 3) satellites.

8.3.1.3.3.1 NOAA KLM Format (Version 2, pre-April 28, 2005)

The Data Records for LAC and HRPT data sets are archived in packed format to reduce storage requirements. Three 10-bit sensor samples are stored in a 32-bit word using the Band Interleaved by Pixel (BIP) method. The format for packed data sets is documented in Table 8.3.1.3.3.1-1. However, this format is inconvenient for data processing.

Table 8.3.1.3.3.1-1. Format of packed LAC/HRPT Data Sets (Version 2, pre-April 28, 2005).								
Field Name	Start Octet	End Octet	Data Type	Word Size	Number of Words	Scale Factor	Units	Notes
SCAN LINE INFORMATION								
Scan Line Number (cumulative, starting with 1)	1	2	u	2	1	0		
Scan Line Year (e.g., 1999)	3	4	u	2	1	0		
Scan Line Day of Year (e.g., 365)	5	6	u	2	1	0		
Satellite Clock Drift Delta	7	8	i	2	1	0	millisec	
Scan Line UTC Time of Day	9	12	u	4	1	0	millisec	
Scan Line Bit Field bit 15: 0 = northbound data; 1 = southbound data bit 14: 1 = scan time corrected for clock drift bits 13-2: <zero fill> bits 1-0: channel 3 select (0 = 3b; 1 = 3a; 2 = transition)	13	14	u	2	1	0		
<zero fill>	15	24	i	2	5	0		
QUALITY INDICATORS								
Quality Indicator Bit Field If a bit is on (=1) then the statement is true.	25	28	u	4	1	0		

<p>bit 31: do not use scan for product generation bit 30: time sequence error detected within this scan (see below) bit 29: data gap precedes this scan bit 28: insufficient data for calibration (see below) bit 27: earth location data not available (see below) bit 26: first good time following a clock update (nominally 0) bit 25: instrument status changed with this scan bit 24: sync lock dropped during this frame bit 23: frame sync word error greater than zero bit 22: frame sync previously dropped lock bit 21: flywheeling detected during this frame bit 20: bit slippage detected during this frame bits 19-9: <zero fill> bit 8: TIP parity error detected bits 7-6: reflected sunlight detected ch 3b (0 = no anomaly; 1 = anomaly; 3 = unsure) bits 5-4: reflected sunlight detected ch 4 (0 = no anomaly; 1 = anomaly; 3 = unsure) bits 3-2: reflected sunlight detected ch 5 (0 = no anomaly; 1 = anomaly; 3 = unsure) bit 1: resync occurred on this frame bit 0: pseudo noise occurred on this frame</p>									
<p>Scan Line Quality Flags If a bit is on (=1) then the statement is true.</p> <p><i>Time Problem Code</i> (All bits off implies the scan time is as expected.) bits 31-24: <zero fill> bit 23: time field is bad but can probably be inferred from the previous good time. bit 22: time field is bad and can't be inferred from the previous good time. bit 21: this record starts a sequence that is inconsistent with previous times (i.e., there is a time discontinuity). This may or may not be associated with a spacecraft clock update. (See bit 26, Quality Indicator Bit Field) bit 20: start of a sequence that apparently repeats scan times that have been previously accepted. bits 19-16: <zero fill></p> <p><i>Calibration Problem Code</i> (Note these bits complement the channel indicators; all bits set to 0 indicates normal calibration.) bit 15: scan line was not calibrated because of bad time. bit 14: scan line was calibrated using fewer than the preferred number of scan lines because of proximity to start or end of data set or to a data gap. bit 13: scan line was not calibrated because of bad or insufficient PRT data. bit 12: scan line was calibrated but with marginal PRT data.</p>	29	32	u	4	1	0			

bit 11: some uncalibrated channels on this scan (see channel indicators) bits 10-8: <zero fill> <i>Earth Location Problem Code</i> (all bits set to 0 implies the earth location was normal) bit 7: not earth located because of bad time; earth location fields zero filled. bit 6: earth location questionable because of questionable time code. (See time problem flags above). bit 5: earth location questionable -- only marginal agreement with reasonableness check. bit 4: earth location questionable -- fails reasonableness check. bits 3-0: <zero fill>								
Calibration Quality Flags (all bits off implies a good calibration) <i>Word 1: Channel 3b</i> bits 15 - 8: <zero fill> bit 7: this channel is not calibrated bit 6: this channel is calibrated but questionable bit 5: all bad blackbody counts for scan line bit 4: all bad space view counts for scan line bit 3: <zero fill> bit 2: marginal blackbody view counts for this line bit 1: marginal space view counts for this line bit 0: <zero fill> <i>Word 2: Channel 4</i> <i>Word 3: Channel 5</i>	33	38	u	2	3	0		
Count of Bit Errors in Frame Sync	39	40	u	2	1	0		
<zero fill>	41	48	i	4	2	0		
CALIBRATION COEFFICIENTS								
Visible Operational Cal Ch 1 Slope 1	49	52	i	4	1	7		
Visible Operational Cal Ch 1 Intercept 1	53	56	i	4	1	6		
Visible Operational Cal Ch 1 Slope 2	57	60	i	4	1	7		
Visible Operational Cal Ch 1 Intercept 2	61	64	i	4	1	6		
Visible Operational Cal Ch 1 Intersection	65	68	i	4	1	0		
Visible Test Cal Ch 1 Slope 1	69	72	i	4	1	7		
Visible Test Cal Ch 1 Intercept 1	73	76	i	4	1	6		
Visible Test Cal Ch 1 Slope 2	77	80	i	4	1	7		

Visible Test Cal Ch 1 Intercept 2	81	84	i	4	1	6		
Visible Test Cal Ch 1 Intersection	85	88	i	4	1	0		
Visible Prelaunch Cal Ch 1 Slope 1	89	92	i	4	1	7		
Visible Prelaunch Cal Ch 1 Intercept 1	93	96	i	4	1	6		
Visible Prelaunch Cal Ch 1 Slope 2	97	100	i	4	1	7		
Visible Prelaunch Cal Ch 1 Intercept 2	101	104	i	4	1	6		
Visible Prelaunch Cal Ch 1 Intersection	105	108	i	4	1	0		
Visible Operational Cal Ch 2 Slope 1	109	112	i	4	1	7		
Visible Operational Cal Ch 2 Intercept 1	113	116	i	4	1	6		
Visible Operational Cal Ch 2 Slope 2	117	120	i	4	1	7		
Visible Operational Cal Ch 2 Intercept 2	121	124	i	4	1	6		
Visible Operational Cal Ch 2 Intersection	125	128	i	4	1	0		
Visible Test Cal Ch 2 Slope 1	129	132	i	4	1	7		
Visible Test Cal Ch 2 Intercept 1	133	136	i	4	1	6		
Visible Test Cal Ch 2 Slope 2	137	140	i	4	1	7		
Visible Test Cal Ch 2 Intercept 2	141	144	i	4	1	6		
Visible Test Cal Ch 2 Intersection	145	148	i	4	1	0		
Visible Prelaunch Cal Ch 2 Slope 1	149	152	i	4	1	7		
Visible Prelaunch Cal Ch 2 Intercept 1	153	156	i	4	1	6		
Visible Prelaunch Cal Ch 2 Slope 2	157	160	i	4	1	7		
Visible Prelaunch Cal Ch 2 Intercept 2	161	164	i	4	1	6		
Visible Prelaunch Cal Ch 2 Intersection	165	168	i	4	1	0		
Visible Operational Cal Ch 3a Slope 1	169	172	i	4	1	7		
Visible Operational Cal Ch 3a Intercept 1	173	176	i	4	1	6		
Visible Operational Cal Ch 3a Slope 2	177	180	i	4	1	7		
Visible Operational Cal Ch 3a Intercept 2	181	184	i	4	1	6		
Visible Operational Cal Ch 3a Intersection	185	188	i	4	1	0		
Visible Test Cal Ch 3a Slope 1	189	192	i	4	1	7		
Visible Test Cal Ch 3a Intercept 1	193	196	i	4	1	6		

Visible Test Cal Ch 3a Slope 2	197	200	i	4	1	7		
Visible Test Cal Ch 3a Intercept 2	201	204	i	4	1	6		
Visible Test Cal Ch 3a Intersection	205	208	i	4	1	0		
Visible Prelaunch Cal Ch 3a Slope 1	209	212	i	4	1	7		
Visible Prelaunch Cal Ch 3a Intercept 1	213	216	i	4	1	6		
Visible Prelaunch Cal Ch 3a Slope 2	217	220	i	4	1	7		
Visible Prelaunch Cal Ch 3a Intercept 2	221	224	i	4	1	6		
Visible Prelaunch Cal Ch 3a Intersection	225	228	i	4	1	0		
IR Operational Cal Ch 3b Coefficient 1	229	232	i	4	1	6		
IR Operational Cal Ch 3b Coefficient 2	233	236	i	4	1	6		
IR Operational Cal Ch 3b Coefficient 3	237	240	i	4	1	6		
IR Test Cal Ch 3b Coefficient 1	241	244	i	4	1	6		
IR Test Cal Ch 3b Coefficient 2	245	248	i	4	1	6		
IR Test Cal Ch 3b Coefficient 3	249	252	i	4	1	6		
IR Operational Cal Ch 4 Coefficient 1	253	256	i	4	1	6		
IR Operational Cal Ch 4 Coefficient 2	257	260	i	4	1	6		
IR Operational Cal Ch 4 Coefficient 3	261	264	i	4	1	6		
IR Test Cal Ch 4 Coefficient 1	265	268	i	4	1	6		
IR Test Cal Ch 4 Coefficient 2	269	272	i	4	1	6		
IR Test Cal Ch 4 Coefficient 3	273	276	i	4	1	6		
IR Operational Cal Ch 5 Coefficient 1	277	280	i	4	1	6		
IR Operational Cal Ch 5 Coefficient 2	281	284	i	4	1	6		
IR Operational Cal Ch 5 Coefficient 3	285	288	i	4	1	6		
IR Test Cal Ch 5 Coefficient 1	289	292	i	4	1	6		
IR Test Cal Ch 5 Coefficient 2	293	296	i	4	1	6		
IR Test Cal Ch 5 Coefficient 3	297	300	i	4	1	6		
<zero fill>	301	312	i	4	3	0		
NAVIGATION								
Navigation Status Bit Field	313	316	u	4	1	0		

bits 31-17: <zero fill>								
bit 16: 1 = earth location corrected for TIP Euler angles								
bits 15 - 12: earth location indicator 0 = earth location available; 1 = user ephemeris files greater than 24 hours old; 2 = no earth location available								
bits 11 - 8: spacecraft attitude control 0 = operating in YGC or NOMINAL mode; 1 = operating in another mode; 2 = attitude exceeds nominal tolerance; 3 = both 1 and 2.								
bits 7 - 4: attitude SMODE 0 = NOMINAL mode; 1 = rate nulling mode; 2 = YGC mode; 3 = search mode; 4 = coast mode								
bits 3 - 0: attitude Passive Wheel Test In Progress 0 = NOMINAL mode/no test; 1 = yaw axis test in progress; 2 = roll axis test in progress; 3 = pitch axis test in progress.								
Time Associated with TIP Euler Angles (Seconds)	317	320	u	4	1	0		
TIP Euler Angles <i>Word 1:</i> Roll <i>Word 2:</i> Pitch <i>Word 3:</i> Yaw	321	326	i	2	3	3	degrees	
Spacecraft Altitude above Reference Ellipsoid in km	327	328	u	2	1	1		
Angular Relationships (relative azimuth range ± 180.00 degrees) <i>Word 1:</i> Solar Zenith Angle, Point 25 <i>Word 2:</i> Satellite Zenith Angle, Point 25 <i>Word 3:</i> Relative Azimuth Angle, Point 25 <i>Word 4:</i> Solar Zenith Angle, Point 65 ... (set of 3 angles every 40 points) ... <i>Word 153:</i> Relative Azimuth Angle, Point 2025	329	634	i	2	153	2		
<zero fill>	635	640	i	2	3	0		

<p>Earth Location (North latitude and East longitude are positive)</p> <p><i>Word 1:</i> Latitude in Degrees, Point 25 <i>Word 2:</i> Longitude in Degrees, Point 25 <i>Word 3:</i> Latitude in Degrees, Point 65 ... (lat/lon word pair every 40 points) ... <i>Word 102:</i> Longitude in Degrees, Point 2025</p>	641	1048	i	4	102	4		
<zero fill>	1049	1056	i	4	2	0		
HRPT MINOR FRAME TELEMETRY								
<p>Frame Sync The first sixty bits (six 10-bit values: 644, 367, 860, 413, 527, 149) from a 63 bit pseudonoise generator starting in the all 1's state. The generator polynomial is: $x^6 + x^5 + x^2 + 1$</p>	1057	1068	u	2	6	0		
<p>ID</p> <p><i>Word 1</i> bits 15-10: <zero fill> bit 9: 0 = internal sync; 1 = AVHRR sync bits 8-7: 0 = not an HRPT frame but a GAC frame; 1 = minor frame 1; 2 = minor frame 2; 3 = minor frame 3 bits 6-3: spacecraft address bit 2: 0 = frame stable; 1 = frame resync occurred bit 1: 0 = pseudonoise AVHRR input; 1 = normal AVHRR input bit 0: 0 = AVHRR Ch 3b; 1 = AVHRR Ch 3a</p> <p><i>Word 2</i> bits 15-10: <zero fill> bits 9-0: <undefined></p>	1069	1072	u	2	2	0		
<p>Time Code</p> <p><i>Word 1</i> bits 15-10: <zero fill> bits 9-1: binary day count bit 0 = 0</p> <p><i>Word 2</i> bits 15-10: <zero fill> bit 9 = 1 bit 8 = 0 bit 7 = 1 bits 6-0: most significant part of binary millisecond of day count</p> <p><i>Word 3</i> bits 15-10: <zero fill> bits 9-0: part of binary millisecond of day count</p>	1073	1080	u	2	4	0		

<p><i>Word 4</i> bits 15-10: <zero fill> bits 9-0: least significant part of binary millisecond of day count</p>								
<p>Telemetry</p> <p><i>Word 1:</i> Ramp Calibration AVHRR Channel 1 <i>Word 2:</i> Ramp Calibration AVHRR Channel 2 <i>Word 3:</i> Ramp Calibration AVHRR Channel 3 <i>Word 4:</i> Ramp Calibration AVHRR Channel 4 <i>Word 5:</i> Ramp Calibration AVHRR Channel 5</p> <p><i>Words 6-9</i> AVHRR Internal Target Temperature Data Three readings from one of the four platinum resistance thermometers (PRT). A different PRT is sampled for each scan; every fifth scan will contain a reference value of 0 in place of each reading.</p> <p><i>Word 6:</i> PRT Reading 1 <i>Word 7:</i> PRT Reading 2 <i>Word 8:</i> PRT Reading 3 <i>Word 9:</i> Patch Temperature</p> <p><i>Word 10:</i> <undefined></p>	1081	1100	u	2	10	0		
<p>Back Scan</p> <p>Ten words of calibration target view data from each AVHRR channel 3, 4, and 5.</p> <p><i>Word 1:</i> Channel 3, Word 1 ... <i>Word 3:</i> Channel 5, Word 1 <i>Word 4:</i> Channel 3, Word 2 ... <i>Word 30:</i> Channel 5, Word 10</p>	1101	1160	u	2	30	0		
<p>Space Data</p> <p>Ten words of space view data from each AVHRR channel 1, 2, 3, 4, 5</p> <p><i>Word 1:</i> Channel 1, Word 1 ... <i>Word 5:</i> Channel 5, Word 1 <i>Word 6:</i> Channel 1, Word 2 ... <i>Word 50:</i> Channel 5, Word 10</p>	1161	1260	u	2	50	0		
<p>Sync Delta</p> <p>bits 15-10: <zero fill> bit 9: 0 = AVHRR sync early; 1 = AVHRR sync late bits 8-0: 9-bit binary count of 0.9984 MHz periods</p>	1261	1262	u	2	1	0		
<zero fill>	1263	1264	i	2	1	0		

AVHRR SENSOR DATA

Sensor Data, Band Interleaved by Pixel (BIP)	1265	14920	u	4	3414	0		
<i>Word 1</i> bits 31-30: <zero fill> bits 29-20: Channel 1, Point 1 bits 19-10: Channel 2, Point 1 bits 9-0: Channel 3, Point 1 <i>Word 2</i> bits 31-30: <zero fill> bits 29-20: Channel 4, Point 1 bits 19-10: Channel 5, Point 1 bits 9-0: Channel 1, Point 2 ... <i>Word 3414</i> bits 31-30: <zero fill> bits 29-20: Channel 5, Point 2048								
<zero fill>	14921	14928	i	4	2	0		
DIGITAL B TELEMETRY								
Invalid Word Bit Flags (if bit = 1, associated telemetry bit was not updated during most recent minor frame cycle - possibly due to lost frame) bit 15: motor/telemetry bit 14: electronics/telemetry bit 13: channel 1 status bit 12: channel 2 status bit 11: channel 3a status bit 10: channel 3b status bit 9: channel 4 status bit 8: channel 5 status bit 7: channel 3a/3b select status bit 6: voltage calibrate status bit 5: cooler heat bit 4: scan motor bit 3: telemetry lock bit 2: earth shield bit 1: patch control bit 0: <zero fill>	14929	14930	u	2	1	0		
AVHRR Digital B Data bit 15: motor/telemetry (0 = off; 1 = on) bit 14: electronics/telemetry (0 = off; 1 = on) bit 13: channel 1 status (0 = disable; 1 = enable) bit 12: channel 2 status (0 = disable; 1 = enable) bit 11: channel 3a status (0 = disable; 1 = enable) bit 10: channel 3b status (0 = disable; 1 = enable) bit 9: channel 4 status (0 = disable; 1 = enable)	14931	14932	u	2	1	0		

bit 8: channel 5 status (0 = disable; 1 = enable) bit 7: channel 3a/3b select status (0 = 3b; 1 = 3a) bit 6: voltage calibrate status (0 = off; 1 = on) bit 5: cooler heat (0 = off; 1 = on) bit 4: scan motor (0 = low; 1 = high) bit 3: telemetry lock (0 = off; 1 = lock) bit 2: earth shield (0 = disable; 1 = deploy) bit 1: patch control (0 = off; 1 = on) bit 0: <zero fill>								
<zero fill>	14933	14944	i	4	3	0		
ANALOG HOUSEKEEPING DATA (TIP)								
Invalid Word Bit Flags (if bit = 1, associated telemetry word was not updated during most recent minor frame cycle - possibly due to lost frame) bits 31 - 23: <zero fill> bit 22: reference voltage (word 22) bits 21-2: words 21 through 2 (in order) bit 1: patch temperature (word 1) bit 0: <zero fill>	14945	14948	u	4	1	0		
<i>Word 1:</i> Patch Temperature <i>Word 2:</i> Patch Temperature Extended <i>Word 3:</i> Patch Power <i>Word 4:</i> Radiator Temperature <i>Word 5:</i> Black Body Temperature 1 <i>Word 6:</i> Black Body Temperature 2 <i>Word 7:</i> Black Body Temperature 3 <i>Word 8:</i> Black Body Temperature 4 <i>Word 9:</i> Electronics Current <i>Word 10:</i> Motor Current <i>Word 11:</i> Earth Shield Position <i>Word 12:</i> Electronics Temperature <i>Word 13:</i> Cooler Housing Temperature <i>Word 14:</i> Baseplate Temperature <i>Word 15:</i> Motor Housing Temperature <i>Word 16:</i> A/D Converter Temperature <i>Word 17:</i> Detector #4 Bias Voltage <i>Word 18:</i> Detector #5 Bias Voltage <i>Word 19:</i> Channel 3b Blackbody View <i>Word 20:</i> Channel 4 Blackbody View <i>Word 21:</i> Channel 5 Blackbody View <i>Word 22:</i> Reference Voltage	14949	14970	u	1	22	0		
<zero fill>	14971	14976	i	2	3	0		
CLOUDS FROM AVHRR (CLAVR)								

<Reserved> CLAVR Status Bit Field bits 31 - 1: <undefined> bit 0: CLAVR status (0 = disable, CCM codes zero-filled; 1 = enable)	14977	14980	u	4	1	0		1
<Reserved>	14981	14984	u	4	1	0		
<Reserved>[CCM (Clear/Cloudy/Mixed) Codes (0 = clear; 1 = mixed clear; 2 = mixed cloudy; 3 = cloudy)] <i>Word 1</i> bits 15-14: CCM code, FOV 1 bits 13-12: CCM code, FOV 2 ... bits 1-0: CCM code, FOV 8 <i>Word 2</i> bits 15-14: CCM code, FOV 9 ... bits 1-0: CCM code, FOV 16 ... (set of 8 CCM codes per word) ... <i>Word 256</i> bits 15-14: CCM code, FOV 2041 ... bits 1-0: CCM code, FOV 2048	14985	15496	u	2	256	0		
FILLER								
<zero fill>	15497	15872	i	4	94	0		1
NOTES: 1. 13 Nov 1998: Redefine reserved CLAVR section to include CLAVR Status Bit Field (Fagan, 24 Sep1998); adjust trailing zero-fill. Clouds from AVHRR (CLAVR) is a complex set of tests to detect daytime and nighttime cloud cover using multi-channel AVHRR sensor data and a surface type database. The first application of CLAVR at NOAA was to support the first AVHRR Pathfinder Atmosphere (PATMOS) Project. PATMOS was replaced by PATMOS-x which reprocessed the entire AVHRR GAC database to create climate data records quality for climate change studies. More information about PATMOS-x is available at http://cimss.ssec.wisc.edu/patmosx/ . Since January 25, 2006, CLAVR-x is part of the operational processing system for NOAA Level 1b GAC, LAC, and HRPT . Bit 0 of the NOAA Level 1b CLAVR Status Bit Field is set to one, and the Clear/Cloudy/Mixed (CCM) Codes are in use. Please note that the NOAA Level 1b format allocates space for only a minimal subset of CLAVR parameters needed to generate products that require cloud masks.								

CLASS allows users to select any combination of one to five channels, and sensor data word sizes of 8 or 16 bits (this is known as the unpacked format). The unpacking process stores each (10-bit) sensor data value in a separate eight or sixteen bit word. When 8-bit words are selected, the sensor

data is reduced from ten to eight bits by removing the least significant two bits. When 16-bit words are selected, the sensor data is stored in the least significant ten bits and the six most significant bits are zero-filled. If a customer does not require all five channels from the AVHRR instrument, the unpacked format can also be reduced to any subset of active channels. At this time, however, the archive extraction programs do not differentiate between channels 3A and 3B. Channel selected data sets are not available in packed format. In all cases, the sensor data is stored in BIP order.

Tables 8.3.1.3.3.1-2 and 8.3.1.3.3.1-3 (containing the 8 and 16-bit unpacked structure, respectively) summarize how the selection of channel and sensor data word size affects the data set structure and record length documented in Table 8.3.1.3.3.1-1. The alignment of data words on eight octet (i.e., 64 bit) boundaries is maintained by adding binary zero-fill after the sensor data section.

Table 8.3.1.3.3.1-2. LAC/HRPT 8-bit Extract Structure.					
Number of Channels	1	2	3	4	5
Pre-Data	1 - 1264	1 - 1264	1 - 1264	1 - 1264	1 - 1264
Sensor Data	1265 - 3312	1265 - 5360	1265 - 7408	1265 - 9456	1265 - 11504
Alignment Zero-Fill	3313-3320	5361-5368	7409-7416	9457-9464	11505-11512
Post-Data	3321-3880	5369-5928	7417-7976	9465-10024	11513-12072
Trailing Zero-Fill	3881-4096	5929-6144	7977-8192	10025-10240	12073-12288
Record Length	4096	6144	8192	10240	12288

Table 8.3.1.3.3.1-3. LAC/HRPT 16-bit Extract Structure.					
Number of Channels	1	2	3	4	5
Pre-Data	1 - 1264	1 - 1264	1 - 1264	1 - 1264	1 - 1264
Sensor Data	1265 - 5360	1265 - 9456	1265 - 13552	1265 - 17648	1265 - 21744
Alignment Zero-Fill	5361-5368	9457-9464	13553-13560	17649-17656	21745-21752
Post-Data	5369-5928	9465-10024	13561-14120	17657-18216	21753-22312

Trailing Zero-Fill	5929-6144	10025-10240	14121-14336	18217-18432	22313-22528
Record Length	6144	10240	14336	18432	22528

8.3.1.3.3.2 NOAA-N Format (Version 5, post-November 14, 2006, all spacecraft)

Table 8.3.1.3.3.2-1 gives the format for the LAC/HRPT Level 1b data record for NOAA-N (version 3, post-April 28, 2005, all spacecraft). Eight and 16-bit extracts of the LAC/HRPT Level 1b data are supported by CLASS for all satellites. Version 4 (v4) was implemented on January 25, 2006, to reflect the start of CLAVR-x processing. Version 5 (v5) was implemented on November 14, 2006, for LAC/HRPT only.

Table 8.3.1.3.3.2-1. Format of LAC/HRPT Data Record for NOAA-N (Version 5, post-November 14, 2006, all spacecraft).								
Field Name	Start Octet	End Octet	Data Type	Word Size	Number of Words	Scale Factor	Units	Notes
SCAN LINE INFORMATION								
Scan Line Number (<i>cumulative, starting with 1; range: 0 - 65,535</i>)	1	2	u	2	1	0		
Scan Line Year (e.g., 1999)	3	4	u	2	1	0		
Scan Line Day of Year (e.g., 365)	5	6	u	2	1	0		
Satellite Clock Drift Delta	7	8	i	2	1	0	millisec	
Scan Line UTC Time of Day	9	12	u	4	1	0	millisec	
Scan Line Bit Field bit 15: satellite direction (0=northbound; 1=southbound) bit 14: clock drift correction (0=not corrected; 1=scan time corrected for clock drift) bits 13-2: <zero fill> bits 1-0: channel 3 select (0=3B; 1=3A; 2=transition)	13	14	u	2	1	0		
<zero fill>	15	24	i	2	5	0		
QUALITY INDICATORS								

<p>Quality Indicator Bit Field (<i>if a bit is on (=1), the statement is true</i>)</p> <p>bit 31: do not use scan for product generation</p> <p>bit 30: time sequence error detected within this scan (see below)</p> <p>bit 29: data gap precedes this scan</p> <p>bit 28: insufficient data for calibration (see below)</p> <p>bit 27: earth location data not available (see below)</p> <p>bit 26: first good time following a clock update (nominally 0)</p> <p>bit 25: instrument status changed with this scan</p> <p>bit 24: bit sync dropped lock during frame (NOAA) or <zero fill> MetOp</p> <p>bit 23: frame sync word has errors (NOAA) or <zero fill> MetOp</p> <p>bit 22: frame sync returned to lock (NOAA) or <zero fill> MetOp</p> <p>bit 21: frame sync word not valid (NOAA) or <zero fill> MetOp</p> <p>bit 20: bit slip occurred during this frame (NOAA) or <zero fill> MetOp</p> <p>bits 19-9: <zero fill></p> <p>bit 8: TIP parity error detected (NOAA) or <zero fill> MetOp</p> <p>bits 7-6: reflected sunlight detected ch 3B (0=no anomaly; 1=anomaly; 3=unsure)</p> <p>bits 5-4: reflected sunlight detected ch 4 (0=no anomaly; 1=anomaly; 3=unsure)</p> <p>bits 3-2: reflected sunlight detected ch 5 (0=no anomaly; 1=anomaly; 3=unsure)</p> <p>bit 1: resync occurred on this frame (NOAA) or <zero fill> MetOp</p> <p>bit 0: pseudonoise occurred on this frame (NOAA) or <zero fill> MetOp</p>	25	28	u	4	1	0		
<p>Scan Line Quality Flags [<Reserved>] (zero fill)</p>	29	29	u	1	1	0		
<p>Scan Line Quality Flags [Time Problem Code] (<i>If a bit is on (=1), the statement is true. All bits off implies the scan time is as expected.</i>)</p> <p>bit 7: time field is bad but can probably be inferred from the previous good time</p> <p>bit 6: time field is bad and can't be inferred from the previous good time</p> <p>bit 5: this record starts a sequence that is inconsistent with previous times (i.e., there is a time discontinuity). This may be associated with a spacecraft clock update. (See bit 26, Quality Indicator Bit Field.)</p> <p>bit 4: start of a sequence that apparently repeats scan times that have been previously accepted</p> <p>bits 3-0: <zero fill></p>	30	30	u	1	1	0		

<p>Scan Line Quality Flags [Calibration Problem Code] (<i>If a bit is on (=1), the statement is true. These bits complement the channel indicators; all bits set to 0 indicate normal calibration.</i>)</p> <p>bit 7: scan line not calibrated: all IR channels failed calibration.</p> <p>bit 6: scan line marginally calibrated: one or more IR channels marginally calibrated, or one or more, but not all, IR channels failed calibration.</p> <p>bit 5: scan line not calibrated: bad or insufficient PRT data</p> <p>bit 4: scan line marginally calibrated: marginal PRT data</p> <p>bit 3: some uncalibrated channels for this scan line (i.e., one or more, but not all, IR channels failed calibration)</p> <p>bit 2: No visible calibration due to either the presence of MIRP pseudonoise in place of AVHRR data (NOAA only) or calibration processing turned off.</p> <p>bit 1: <zero fill></p> <p>bit 0: scan line was not calibrated because of satellite maneuver (MetOp) or <zero fill> (NOAA)</p>	31	31	u	1	1	0		
<p>Scan Line Quality Flags [Earth Location Problem Code] (<i>If a bit is on (=1), the statement is true. All bits set to 0 imply the earth location was normal.</i>)</p> <p>bit 7: not earth located because of bad time; earth location fields zero-filled</p> <p>bit 6: earth location questionable: questionable time code (see time problem flags above)</p> <p>bit 5: earth location questionable: marginal agreement with reasonableness check</p> <p>bit 4: earth location questionable: fails reasonableness check</p> <p>bits 3-2: <zero fill></p> <p>bit 1: not earth located because of satellite in-plane maneuver (MetOp) or <zero fill> (NOAA)</p> <p>bit 0: not earth located because of satellite out-of-plane maneuver (MetOp) or <zero fill> (NOAA)</p>	32	32	u	1	1	0		
<p>Calibration Quality Flags (<i>all bits off implies a good calibration</i>)</p> <p>Word 1: Channel 3B</p> <p>bits 15-8: <zero fill></p> <p>bit 7: this channel is not calibrated</p> <p>bit 6: this channel is calibrated but questionable</p> <p>bit 5: all bad blackbody counts for scan line</p> <p>bit 4: all bad space view counts for scan line</p> <p>bit 3: <zero fill></p> <p>bit 2: marginal blackbody view counts for this line</p> <p>bit 1: marginal space view counts for this line</p> <p>bit 0: <zero fill></p> <p>Words 2-3: Channels 4-5 (in order)</p>	33	38	U	2	3	0		
Count of Bit Errors in Frame Sync (NOAA) or <zero fill> (MetOp)	39	40	u	2	1	0		
<zero fill>	41	48	i	4	2	0		
CALIBRATION COEFFICIENTS								

Visible Operational Cal Ch 1 Slope 1	49	52	i	4	1	7		
Visible Operational Cal Ch 1 Intercept 1	53	56	i	4	1	6		
Visible Operational Cal Ch 1 Slope 2	57	60	i	4	1	7		
Visible Operational Cal Ch 1 Intercept 2	61	64	i	4	1	6		
Visible Operational Cal Ch 1 Intersection	65	68	i	4	1	0		
Visible Test Cal Ch 1 Slope 1	69	72	i	4	1	7		
Visible Test Cal Ch 1 Intercept 1	73	76	i	4	1	6		
Visible Test Cal Ch 1 Slope 2	77	80	i	4	1	7		
Visible Test Cal Ch 1 Intercept 2	81	84	i	4	1	6		
Visible Test Cal Ch 1 Intersection	85	88	i	4	1	0		
Visible Prelaunch Cal Ch 1 Slope 1	89	92	i	4	1	7		
Visible Prelaunch Cal Ch 1 Intercept 1	93	96	i	4	1	6		
Visible Prelaunch Cal Ch 1 Slope 2	97	100	i	4	1	7		
Visible Prelaunch Cal Ch 1 Intercept 2	101	104	i	4	1	6		
Visible Prelaunch Cal Ch 1 Intersection	105	108	i	4	1	0		
Visible Operational Cal Ch 2 Slope 1	109	112	i	4	1	7		
Visible Operational Cal Ch 2 Intercept 1	113	116	i	4	1	6		
Visible Operational Cal Ch 2 Slope 2	117	120	i	4	1	7		
Visible Operational Cal Ch 2 Intercept 2	121	124	i	4	1	6		
Visible Operational Cal Ch 2 Intersection	125	128	i	4	1	0		
Visible Test Cal Ch 2 Slope 1	129	132	i	4	1	7		
Visible Test Cal Ch 2 Intercept 1	133	136	i	4	1	6		
Visible Test Cal Ch 2 Slope 2	137	140	i	4	1	7		
Visible Test Cal Ch 2 Intercept 2	141	144	i	4	1	6		
Visible Test Cal Ch 2 Intersection	145	148	i	4	1	0		
Visible Prelaunch Cal Ch 2 Slope 1	149	152	i	4	1	7		
Visible Prelaunch Cal Ch 2 Intercept 1	153	156	i	4	1	6		
Visible Prelaunch Cal Ch 2 Slope 2	157	160	i	4	1	7		
Visible Prelaunch Cal Ch 2 Intercept 2	161	164	i	4	1	6		

Visible Prelaunch Cal Ch 2 Intersection	165	168	i	4	1	0		
Visible Operational Cal Ch 3A Slope 1	169	172	i	4	1	7		
Visible Operational Cal Ch 3A Intercept 1	173	176	i	4	1	6		
Visible Operational Cal Ch 3A Slope 2	177	180	i	4	1	7		
Visible Operational Cal Ch 3A Intercept 2	181	184	i	4	1	6		
Visible Operational Cal Ch 3A Intersection	185	188	i	4	1	0		
Visible Test Cal Ch 3A Slope 1	189	192	i	4	1	7		
Visible Test Cal Ch 3A Intercept 1	193	196	i	4	1	6		
Visible Test Cal Ch 3A Slope 2	197	200	i	4	1	7		
Visible Test Cal Ch 3A Intercept 2	201	204	i	4	1	6		
Visible Test Cal Ch 3A Intersection	205	208	i	4	1	0		
Visible Prelaunch Cal Ch 3A Slope 1	209	212	i	4	1	7		
Visible Prelaunch Cal Ch 3A Intercept 1	213	216	i	4	1	6		
Visible Prelaunch Cal Ch 3A Slope 2	217	220	i	4	1	7		
Visible Prelaunch Cal Ch 3A Intercept 2	221	224	i	4	1	6		
Visible Prelaunch Cal Ch 3A Intersection	225	228	i	4	1	0		
IR Operational Cal Ch 3B Coefficient 1	229	232	i	4	1	6		
IR Operational Cal Ch 3B Coefficient 2	233	236	i	4	1	6		
IR Operational Cal Ch 3B Coefficient 3	237	240	i	4	1	6		
IR Test Cal Ch 3B Coefficient 1	241	244	i	4	1	6		
IR Test Cal Ch 3B Coefficient 2	245	248	i	4	1	6		
IR Test Cal Ch 3B Coefficient 3	249	252	i	4	1	6		
IR Operational Cal Ch 4 Coefficient 1	253	256	i	4	1	6		
IR Operational Cal Ch 4 Coefficient 2	257	260	i	4	1	6		
IR Operational Cal Ch 4 Coefficient 3	261	264	i	4	1	7		
IR Test Cal Ch 4 Coefficient 1	265	268	i	4	1	6		
IR Test Cal Ch 4 Coefficient 2	269	272	i	4	1	6		
IR Test Cal Ch 4 Coefficient 3	273	276	i	4	1	7		
IR Operational Cal Ch 5 Coefficient 1	277	280	i	4	1	6		

IR Operational Cal Ch 5 Coefficient 2	281	284	i	4	1	6		
IR Operational Cal Ch 5 Coefficient 3	285	288	i	4	1	7		
IR Test Cal Ch 5 Coefficient 1	289	292	i	4	1	6		
IR Test Cal Ch 5 Coefficient 2	293	296	i	4	1	6		
IR Test Cal Ch 5 Coefficient 3	297	300	i	4	1	7		
NAVIGATION								
Computed yaw Steering (MetOp: content defined below) or <zero fill> (NOAA) Word 1: Computed roll angle Word 2: Computed pitch angle Word 3: Computed yaw angle	301	306	i	2	3	0	degrees	
Total applied Attitude Correction Word 1: Roll Word 2: Pitch Word 3: Yaw	307	312	i	2	3	3	degrees	
Navigation Status Bit Field (<i>content, defined below, depends on origin of data, either NOAA or Metop</i>) <i>For NOAA Data:</i> bits 31-18: <zero fill> bit 17: earth location at the satellite subpoint is accurate and reasonable, i.e., is within tolerance defined by "Nadir Earth Location Tolerance" in header (0=out of tolerance; 1=in tolerance) bit 16: Euler error angles from the CPU telemetry used by AELDS to correct the earth locations (0=FALSE; 1=TRUE) bits 15-12: earth location indicator (0=earth location available; 1=first scan whose time is more than 24 hours older than the time [epoch] of the user ephemeris file; 2=no earth location available) bits 11-8: spacecraft attitude control (0=operating in YGC or NOMINAL mode and attitude is good; 1=operating in another mode but attitude is good; 2=operating in YGC or NOMINAL mode but tests are being conducted which may cause attitude to exceed nominal tolerance; 3=operating in another mode while tests are being conducted which may cause attitude to exceed nominal tolerance) bits 7-4: attitude SMODE (0=nominal mode; 1=rate nulling mode; 2=YGC mode; 3=search mode; 4=coast mode) bits 3-0: attitude PWTIP\$AC (0=nominal mode/no test; 1=yaw axis test in progress; 2=roll axis test in progress; 3=pitch axis test in progress) <i>For Metop Data:</i> bits 31-21: <zero fill> bit 20-19: yaw steering parameters usage indicator (0=no yaw steering correction; 1=measured angles from the Metop SVM telemetry; 2=computed angles from AELDS; 3=measured angles + computed angles) bit 18: Metop maneuver indicator (0=scan does not occur during a Metop in-plane or out-of-plane maneuver; 1=scan, or some part of it, occurs during a maneuver) bit 17: <same as defined for NOAA, above> bit 16: <zero fill> bits 15-12: <same as defined for NOAA, above> bits 11-8: <zero fill> bits 7-4: OPM PF sub-mode (0=fine pointing mode (FPM); 1=yaw steering mode (YSM))	313	316	u	4	1	0		

bits 3-0: SVM PF mode (0=LHM; 1=RRM; 2=CAM; 3=FAM1; 4=FAM2; 5=FAM3; 6=OPM; 7=OCM1; 8=OCM2; 9=OCMT; 10=OCM0)								
Time Associated with Euler Angles	317	320	u	4	1	0	seconds	
Euler Angles (<i>NOAA, from TI CPU telemetry near end of scan; MetOp [in FPM], from SVM telemetry just before start of scan</i>) or Yaw Steering Parameters (<i>MetOp [in YSM], from SVM telemetry or AELDS near nadir of scan</i>) Word 1: Roll Word 2: Pitch Word 3: Yaw	321	326	i	2	3	3	degrees	
Spacecraft Altitude above Reference Ellipsoid	327	328	u	2	1	1	km	
Angular Relationships (<i>relative azimuth range ± 180.00 degrees</i>) Word 1: Solar zenith angle, FOV 25 Word 2: Satellite zenith angle, FOV 25 Word 3: Relative azimuth angle, FOV 25 Word 4: Solar zenith angle, FOV 65 ... (set of 3 angles every 40 FOVs) ... Word 153: Relative azimuth angle, FOV 2025	329	634	i	2	153	2	degrees	
<zero fill>	635	640	i	2	3	0		
Earth Location (<i>north latitude and east longitude are positive</i>) Word 1: Latitude, FOV 25 Word 2: Longitude, FOV 25 Word 3: Latitude, FOV 65 ... (lat/lon word pair every 40 FOVs) ... Word 102: Longitude, FOV 2025	641	1048	i	4	102	4	degrees	
<zero fill>	1049	1056	i	4	2	0		
FRAME TELEMETRY								
Frame Sync (<i>The first 60 bits (in 6 10-bit values) from a 63-bit pseudonoise generator starting in the all 1's state. The generator polynomial is: $x^6 + x^5 + x^2 + 1$.</i>) (NOAA: content defined below) or <zero fill> MetOp Word 1: 644 Word 2: 367 Word 3: 860 Word 4: 413 Word 5: 527 Word 6: 149	1057	1068	u	2	6	0		

<p>ID</p> <p>Word 1</p> <p>bits 15-10: <zero fill></p> <p>bit 9: MIRP/AVHRR sync (0=internal sync; 1=AVHRR sync)</p> <p>bits 8-7: frame ID (0=GAC frame; 1=HRPT minor frame 1; 2=HRPT minor frame 2; 3=HRPT minor frame 3)</p> <p>bits 6-3: spacecraft address (<i>zero-fill for MetOp</i>)</p> <p>bit 2: resync (0=frame stable; 1=frame resync occurred)</p> <p>bit 1: AVHRR input (0=pseudonoise; 1=normal)</p> <p>bit 0: channel 3 status (0=AVHRR channel 3B; 1=AVHRR channel 3A)</p> <p>Word 2</p> <p>bits 15-10: <zero fill></p> <p>bits 9-0: <undefined></p>	1069	1072	u	2	2	0		
<p>Time Code (NOAA: content defined below) or <zero fill> MetOp</p> <p>Word 1</p> <p>bits 15-10: <zero fill></p> <p>bits 9-1: binary day count</p> <p>bit 0: 0 (zero)</p> <p>Word 2</p> <p>bits 15-10: <zero fill></p> <p>bit 9: 1 (one)</p> <p>bit 8: 0 (zero)</p> <p>bit 7: 1 (one)</p> <p>bits 6-0: most significant part of binary millisecond of day count</p> <p>Word 3</p> <p>bits 15-10: <zero fill></p> <p>bits 9-0: part of binary millisecond of day count</p> <p>Word 4</p> <p>bits 15-10: <zero fill></p> <p>bits 9-0: least significant part of binary millisecond of day count</p>	1073	1080	u	2	4	0		
<p>Ramp Calibration</p> <p>Word 1: Ramp calibration, channel 1</p> <p>Word 2: Ramp calibration, channel 2</p> <p>Word 3: Ramp calibration, channel 3</p> <p>Word 4: Ramp calibration, channel 4</p> <p>Word 5: Ramp calibration, channel 5</p>	1081	1090	u	2	5	0	counts	
<p>Internal Target Temperature (<i>Three readings from one of the four platinum resistance thermometers (PRT). A different PRT is sampled for each scan. Every fifth scan will contain a reference value of 0 in place of each reading.</i>)</p> <p>Word 1: PRT reading 1</p> <p>Word 2: PRT reading 2</p> <p>Word 3: PRT reading 3</p>	1091	1096	u	2	3	0	counts	
<p>Patch Temperature</p>	1097	1098	u	2	1	0	counts	
<p><Undefined> (NOAA) or <zero fill> MetOp</p>	1099	1100	u	2	1	0		

Back Scan (<i>Ten samples of calibration target view data from each of AVHRR channels 3, 4, and 5.</i>) Word 1: channel 3, sample 1 Word 2: channel 4, sample 1 Word 3: channel 5, sample 1 Word 4: channel 3, sample 2 ... Word 30: channel 5, sample 10	1101	1160	u	2	30	0	counts	
Space Data (<i>Ten samples of space view data from each of AVHRR channels 1, 2, 3, 4, and 5.</i>) Word 1: channel 1, sample 1 Word 2: channel 2, sample 1 ... Word 5: channel 5, sample 1 Word 6: channel 1, sample 2 ... Word 50: channel 5, sample 10	1161	1260	u	2	50	0	counts	
Sync Delta (NOAA: content defined below) or <zero fill> MetOp bits 15-10: <zero fill> bit 9: AVHRR sync (0=early; 1=late) bits 8-0: 9-bit binary count of 0.9984 MHz periods	1261	1262	u	2	1	0		
<zero fill>	1263	1264	i	2	1	0		
EARTH OBSERVATIONS								
Earth Data Word 1 bits 31-30: <zero fill> bits 29-20: channel 1, FOV 1 bits 19-10: channel 2, FOV 1 bits 9-0: channel 3, FOV 1 Word 2 bits 31-30: <zero fill> bits 29-20: channel 4, FOV 1 bits 19-10: channel 5, FOV 1 bits 9-0: channel 1, FOV 2 ... Word 3414 bits 31-30: <zero fill> bits 29-20: channel 5, FOV 2048 bits 19-0: <zero fill>	1265	14920	u	4	3414	0	counts	
<zero fill>	14921	14928	i	4	2	0		
DIGITAL B HOUSEKEEPING TELEMETRY								

<p>Digital B Telemetry Update Flags (<i>If bit = 0, associated telemetry item is up-to-date. If bit = 1, associated telemetry item was not updated during most recent telemetry cycle - possibly due to lost frame.</i>)</p> <p>bit 15: scan motor/telemetry status bit 14: electronics/telemetry status bit 13: channel 1 status bit 12: channel 2 status bit 11: channel 3A status bit 10: channel 3B status bit 9: channel 4 status bit 8: channel 5 status bit 7: channel 3A/3B select status bit 6: voltage calibration status bit 5: cooler heat status bit 4: scan motor mode status bit 3: telemetry lock status bit 2: earth shield status bit 1: patch control status bit 0: <zero fill></p>	14929	14930	u	2	1	0		
<p>AVHRR Digital B Data</p> <p>bit 15: scan motor/telemetry status (0=off; 1=on) bit 14: electronics/telemetry status (0=off; 1=on) bit 13: channel 1 status (0=disable; 1=enable) bit 12: channel 2 status (0=disable; 1=enable) bit 11: channel 3A status (0=disable; 1=enable) bit 10: channel 3B status (0=disable; 1=enable) bit 9: channel 4 status (0=disable; 1=enable) bit 8: channel 5 status (0=disable; 1=enable) bit 7: channel 3A/3B select status (0=3B; 1=3A) bit 6: voltage calibration status (0=off; 1=on) bit 5: cooler heat status (0=off; 1=on) bit 4: scan motor mode status (0=low; 1=high) bit 3: telemetry lock status (0=not locked on; 1=locked on) bit 2: earth shield status (0=disable; 1=deploy) bit 1: patch control status (0=off; 1=on) bit 0: <zero fill></p>	14931	14932	u	2	1	0		
<zero fill>	14933	14944	i	4	3	0		
ANALOG HOUSEKEEPING TELEMETRY								

Analog Telemetry Update Flags (<i>If bit = 0, associated telemetry item is up-to-date. If bit = 1, associated telemetry item was not updated during most recent telemetry cycle - possibly due to lost frame.</i>) bits 31-23: <zero fill> bit 22: motor current bit 21: electronics current bit 20: blackbody temperature, channel 5 bit 19: detector #5 bias voltage bit 18: blackbody temperature, channel bit 17: blackbody temperature, channel 3B bit 16: A/D converter temperature bit 15: black body temperature 4 bit 14: black body temperature 3 bit 13: black body temperature 2 bit 12: black body temperature 1 bit 11: motor housing temperature bit 10: baseplate temperature bit 9: electronics temperature bit 8: cooler housing temperature bit 7: radiator temperature bit 6: patch power bit 5: earth shield position bit 4: patch temperature extended bit 3: detector #4 bias voltage bit 2: reference voltage bit 1: patch power bit 0: <zero fill>	14945	14948	u	4	1	0		
Patch Temperature (<i>range: 0 - 255</i>)	14949	14949	u	1	1	0	counts	
Patch Temperature Extended (<i>range: 0 - 255</i>)	14950	14950	u	1	1	0	counts	
Patch Power (<i>range: 0 - 255</i>)	14951	14951	u	1	1	0	counts	
Radiator Temperature (<i>range: 0 - 255</i>)	14952	14952	u	1	1	0	counts	
Black Body Temperature 1 (<i>range: 0 - 255</i>)	14953	14953	u	1	1	0	counts	
Black Body Temperature 2 (<i>range: 0 - 255</i>)	14954	14954	u	1	1	0	counts	
Black Body Temperature 3 (<i>range: 0 - 255</i>)	14955	14955	u	1	1	0	counts	
Black Body Temperature 4 (<i>range: 0 - 255</i>)	14956	14956	u	1	1	0	counts	
Electronics Current (<i>range: 0 - 255</i>)	14957	14957	u	1	1	0	counts	
Motor Current (<i>range: 0 - 255</i>)	14958	14958	u	1	1	0	counts	
Earth Shield Position (<i>range: 0 - 255</i>)	14959	14959	u	1	1	0	counts	
Electronics Temperature (<i>range: 0 - 255</i>)	14960	14960	u	1	1	0	counts	
Cooler Housing Temperature (<i>range: 0 - 255</i>)	14961	14961	u	1	1	0	counts	

Baseplate Temperature (<i>range: 0 - 255</i>)	14962	14962	u	1	1	0	counts	
Motor Housing Temperature (<i>range: 0 - 255</i>)	14963	14963	u	1	1	0	counts	
A/D Converter Temperature (<i>range: 0 - 255</i>)	14964	14964	u	1	1	0	counts	
Detector #4 Bias Voltage (<i>range: 0 - 255</i>)	14965	14965	u	1	1	0	counts	
Detector #5 Bias Voltage (<i>range: 0 - 255</i>)	14966	14966	u	1	1	0	counts	
Blackbody Temperature, Channel 3B (<i>range: 0 - 255</i>)	14967	14967	u	1	1	0	counts	
Blackbody Temperature, Channel 4 (<i>range: 0 - 255</i>)	14968	14968	u	1	1	0	counts	
Blackbody Temperature, Channel 5 (<i>range: 0 - 255</i>)	14969	14969	u	1	1	0	counts	
Reference Voltage (<i>range: 0 - 255</i>)	14970	14970	u	1	1	0	counts	
<zero fill>	14971	14976	i	2	3	0		
CLOUDS FROM AVHRR (CLAVR)								
<Reserved> [CLAVR Status Bit Field] bits 31-1: <undefined> bit 0: CLAVR status (0=disable, CCM codes zero-filled; 1=enable)	14977	14980	u	4	1	0		
<Reserved> [CLAVR]	14981	14984	u	4	1	0		
<Reserved> [CLAVR CCM (Clear/Cloudy/Mixed) Codes (0=clear; 1=mixed clear; 2=mixed cloudy; 3=cloudy)] Word 1 bits 15-14: CCM code, FOV 1 bits 13-12: CCM code, FOV 2 ... bits 1-0: CCM code, FOV 8 Word 2 bits 15-14: CCM code, FOV 9 ... bits 1-0: CCM code, FOV 16 ... (set of 8 CCM codes per word) ... Word 256 bits 15-14: CCM code, FOV 2041 ... bits 1-0: CCM code, FOV 2048	14985	15496	u	2	256	0		
FILLER								
<zero fill>	15497	15872	i	4	94	0		

8.3.1.4 GAC Data Sets

This section describes the characteristics and formats of Global Area Coverage (GAC) data sets for both NOAA KLM (version 2) and NOAA-N (version 3) satellites. Version 2 format (v2) was used on all NOAA KLM data until April 28, 2005. After this date, the Version 3 format (v3), also known as the NOAA-N format, was implemented for *all* operational POES spacecraft. On January 25, 2006, Version 4 format (v4) was implemented to reflect the start of CLAVR-x processing. There is no plan at this time to reprocess archived data into the new format.

8.3.1.4.1 Data Characteristics

The processor on board the satellite samples the real-time AVHRR data to produce reduced resolution GAC data. Four out of every five samples along the scan line are used to compute one average value, and the data from only every third scan line are processed. As a result, the spatial resolution of GAC data near the subpoint is actually 1.1 km by 4.4 km with a 3.3 km gap between pixels across the scan line, although generally treated as 4 km resolution. All of the GAC data computed during a complete pass are recorded on board the satellite for transmission to Earth on command. The 10-bit precision of the AVHRR data is retained. Table 8.3.1.4.1-1 summarizes fundamental characteristics of the data.

Table 8.3.1.4.1-1. GAC Data Characteristics.	
Parameter	Value
Sample word size	10 bits
Number of sampled channels/available channels	5/6
Number of Earth samples per scan	409 per channel
Scan rate	120 scans per minute
Scan direction	East to West (northbound)
Instantaneous Field of View (IFOV)	0.07449 degrees (all channels)
Spatial resolution at nadir	4.36 km (cross track average) by 1.09 km (along track) at 833 km altitude
Cross track distance between sample centers at nadir	5.45 km at 833 km altitude
Along track distance between sample centers at nadir	3.27 km at 833 km altitude
Cross-track scan coverage	± 55.4 degrees from nadir

Swath width	2,399 km at 833 km altitude
-------------	-----------------------------

8.3.1.4.2 Header Records

The Data Set Header Record contains quality, navigation, calibration, and conversion coefficient information which applies to the GAC data records which follow. This section describes the header records for both NOAA KLM (version 2) and NOAA-N (version 3) satellites. Version 2 formats (v2) were used on all NOAA KLM data until April 28, 2005. After this date, the version 3 format (v3), also known as the NOAA-N format, was implemented for all operational POES spacecraft. Version 4 (v4) was implemented on January 25, 2006, to reflect the start of CLAVR-x processing. Version 5 (v5) was implemented on November 14, 2006, for LAC/HRPT processing only. GAC continues to remain at version 4.

8.3.1.4.2.1 NOAA KLM Header Records (Version 2, pre-April 28, 2005)

With the exception of the zero-fill padding, the format specifications for the GAC Level 1b primary header record for NOAA-KLM (Version 2, pre-April, 2005) is the same as the LAC/HRPT header record (Table 8.3.1.3.2.1-1). Please note that as part of the updates to the Level 1b formats for NOAA-N and -N' is the inclusion of additional, or secondary, header records. They will contain ancillary data set names and any metadata needed for reprocessing. Currently, the content and format of any secondary header records is to be determined. Applications that will access Level 1b data sets should use the "Count of Header Records in this Data Set" field, located in the first, or primary, header record, to calculate the position of the first data record and skip the secondary header records.

8.3.1.4.2.2 NOAA-N Header Records (Version 4, post-January 25, 2006, all spacecraft)

With the exception of the zero-fill padding, the format specifications for the GAC Level 1b primary header record for NOAA-N is the same as the LAC/HRPT header record (Table 8.3.1.3.2.2-1). Please note that as part of the updates to the Level 1b formats for NOAA-N and -N' is the inclusion of additional, or secondary, header records. They will contain ancillary data set names and any metadata needed for reprocessing. Currently, the content and format of any secondary header records is to be determined. Applications that will access Level 1b data sets should use the "Count of Header Records in this Data Set" field, located in the first, or primary, header record, to calculate the position of the first data record and skip the secondary header records.

8.3.1.4.3 Data Records

This section describes the Level 1b GAC data records for both the NOAA KLM and NOAA-N satellites. The Data Records for GAC data sets are archived in packed format to reduce storage requirements. Three 10-bit sensor samples are stored in a 32-bit word using the Band Interleaved by Pixel (BIP) method.

8.3.1.4.3.1 NOAA KLM Format (Version 2, pre-April 28, 2005)

The format for packed GAC data sets for NOAA KLM (version 2, pre-April 28, 2005) is documented in Table 8.3.1.4.3.1-1. However, this format is inconvenient for data processing.

NESDIS archive systems support the selection of any combination of one to five channels, and sensor data word sizes of 8 or 16 bits (this is known as the unpacked format). The unpacking process stores each (10-bit) sensor data value in a separate eight or sixteen bit word. When 8-bit words are selected, the sensor data is reduced from ten to eight bits by removing the least significant two bits. When 16-bit words are selected, the sensor data is stored in the least significant ten bits and the six most significant bits are zero-filled. If a customer does not require all five channels from the AVHRR instrument, the unpacked format can also be reduced to any subset of active channels. At this time, however, the archive extraction programs do not differentiate between channels 3A and 3B. Channel selected data sets are not available in packed format. In all cases, the sensor data is stored in BIP order.

Table 8.3.1.4.3.1-1. Format of packed GAC Data Record for NOAA KLM (Version 2, pre-April 28, 2005).

Field Name	Start Octet	End Octet	Data Type	Word Size	Number of Words	Scale Factor	Units	Notes
SCAN LINE INFORMATION								
Scan Line Number (cumulative, starting with 1)	1	2	u	2	1	0		
Scan Line Year (e.g., 1999)	3	4	u	2	1	0		
Scan Line Day of Year (e.g., 365)	5	6	u	2	1	0		
Satellite Clock Drift Delta	7	8	i	2	1	0	millisec	
Scan Line UTC Time of Day	9	12	u	4	1	0	millisec	
Scan Line Bit Field bit 15: 0 = northbound data; 1 = southbound data bit 14: 1 = scan time corrected for clock drift bits 13-2: <zero fill> bits 1-0: channel 3 select (0 = 3b; 1 = 3a; 2 = transition)	13	14	u	2	1	0		
<zero fill>	15	24	i	2	5	0		
QUALITY INDICATORS								
Quality Indicator Bit Field If a bit is on (=1) then the statement is true. bit 31: do not use scan for product generation bit 30: time sequence error detected within this scan (see below) bit 29: data gap precedes this scan bit 28: insufficient data for calibration (see below)	25	28	u	4	1	0		

<p>bit 27: earth location data not available (see below) bit 26: first good time following a clock update (nominally 0) bit 25: instrument status changed with this scan bit 24: sync lock dropped during this frame bit 23: frame sync word error greater than zero bit 22: frame sync previously dropped lock bit 21: flywheeling detected during this frame bit 20: bit slippage detected during this frame bits 19-9: <zero fill> bit 8: TIP parity error detected bits 7-6: reflected sunlight detected ch 3b (0 = no anomaly; 1 = anomaly; 3 = unsure) bits 5-4: reflected sunlight detected ch 4 (0 = no anomaly; 1 = anomaly; 3 = unsure) bits 3-2: reflected sunlight detected ch 5 (0 = no anomaly; 1 = anomaly; 3 = unsure) bit 1: resync occurred on this frame bit 0: pseudo noise occurred on this frame</p>								
<p>Scan Line Quality Flags If a bit is on (=1) then the statement is true.</p> <p><i>Time Problem Code</i> (All bits off implies the scan time is as expected.) bits 31-24: <zero fill> bit 23: time field is bad but can probably be inferred from the previous good time. bit 22: time field is bad and can't be inferred from the previous good time. bit 21: this record starts a sequence that is inconsistent with previous times (i.e., there is a time discontinuity). This may or may not be associated with a spacecraft clock update. (See bit 26, Quality Indicator Bit Field) bit 20: start of a sequence that apparently repeats scan times that have been previously accepted. bits 19-16: <zero fill></p> <p><i>Calibration Problem Code</i> (Note these bits complement the channel indicators; all bits set to 0 indicates normal calibration.) bit 15: scan line was not calibrated because of bad time. bit 14: scan line was calibrated using fewer than the preferred number of scan lines because of proximity to start or end of data set or to a data gap. bit 13: scan line was not calibrated because of bad or insufficient PRT data. bit 12: scan line was calibrated but with marginal PRT data. bit 11: some uncalibrated channels on this scan (see channel indicators) bits 10-8: <zero fill></p> <p><i>Earth Location Problem Code</i></p>	29	32	u	4	1	0		

(all bits set to 0 implies the earth location was normal) bit 7: not earth located because of bad time; earth location fields zero filled. bit 6: earth location questionable because of questionable time code. (See time problem flags above). bit 5: earth location questionable -- only marginal agreement with reasonableness check. bit 4: earth location questionable -- fails reasonableness check. bits 3-0: <zero fill>								
Calibration Quality Flags (all bits off implies a good calibration) <i>Word 1: Channel 3b</i> bits 15 - 8: <zero fill> bit 7: this channel is not calibrated bit 6: this channel is calibrated but questionable bit 5: all bad blackbody counts for scan line bit 4: all bad space view counts for scan line bit 3: <zero fill> bit 2: marginal blackbody view counts for this line bit 1: marginal space view counts for this line bit 0: <zero fill> <i>Word 2: Channel 4</i> <i>Word 3: Channel 5</i>	33	38	u	2	3	0		
Count of Bit Errors in Frame Sync	39	40	u	2	1	0		
<zero fill>	41	48	i	4	2	0		
CALIBRATION COEFFICIENTS								
Visible Operational Cal Ch 1 Slope 1	49	52	i	4	1	7		
Visible Operational Cal Ch 1 Intercept 1	53	56	i	4	1	6		
Visible Operational Cal Ch 1 Slope 2	57	60	i	4	1	7		
Visible Operational Cal Ch 1 Intercept 2	61	64	i	4	1	6		
Visible Operational Cal Ch 1 Intersection	65	68	i	4	1	0		
Visible Test Cal Ch 1 Slope 1	69	72	i	4	1	7		
Visible Test Cal Ch 1 Intercept 1	73	76	i	4	1	6		
Visible Test Cal Ch 1 Slope 2	77	80	i	4	1	7		
Visible Test Cal Ch 1 Intercept 2	81	84	i	4	1	6		
Visible Test Cal Ch 1 Intersection	85	88	i	4	1	0		
Visible Prelaunch Cal Ch 1 Slope 1	89	92	i	4	1	7		

Visible Prelaunch Cal Ch 1 Intercept 1	93	96	i	4	1	6		
Visible Prelaunch Cal Ch 1 Slope 2	97	100	i	4	1	7		
Visible Prelaunch Cal Ch 1 Intercept 2	101	104	i	4	1	6		
Visible Prelaunch Cal Ch 1 Intersection	105	108	i	4	1	0		
Visible Operational Cal Ch 2 Slope 1	109	112	i	4	1	7		
Visible Operational Cal Ch 2 Intercept 1	113	116	i	4	1	6		
Visible Operational Cal Ch 2 Slope 2	117	120	i	4	1	7		
Visible Operational Cal Ch 2 Intercept 2	121	124	i	4	1	6		
Visible Operational Cal Ch 2 Intersection	125	128	i	4	1	0		
Visible Test Cal Ch 2 Slope 1	129	132	i	4	1	7		
Visible Test Cal Ch 2 Intercept 1	133	136	i	4	1	6		
Visible Test Cal Ch 2 Slope 2	137	140	i	4	1	7		
Visible Test Cal Ch 2 Intercept 2	141	144	i	4	1	6		
Visible Test Cal Ch 2 Intersection	145	148	i	4	1	0		
Visible Prelaunch Cal Ch 2 Slope 1	149	152	i	4	1	7		
Visible Prelaunch Cal Ch 2 Intercept 1	153	156	i	4	1	6		
Visible Prelaunch Cal Ch 2 Slope 2	157	160	i	4	1	7		
Visible Prelaunch Cal Ch 2 Intercept 2	161	164	i	4	1	6		
Visible Prelaunch Cal Ch 2 Intersection	165	168	i	4	1	0		
Visible Operational Cal Ch 3a Slope 1	169	172	i	4	1	7		
Visible Operational Cal Ch 3a Intercept 1	173	176	i	4	1	6		
Visible Operational Cal Ch 3a Slope 2	177	180	i	4	1	7		
Visible Operational Cal Ch 3a Intercept 2	181	184	i	4	1	6		
Visible Operational Cal Ch 3a Intersection	185	188	i	4	1	0		
Visible Test Cal Ch 3a Slope 1	189	192	i	4	1	7		
Visible Test Cal Ch 3a Intercept 1	193	196	i	4	1	6		
Visible Test Cal Ch 3a Slope 2	197	200	i	4	1	7		
Visible Test Cal Ch 3a Intercept 2	201	204	i	4	1	6		
Visible Test Cal Ch 3a Intersection	205	208	i	4	1	0		

Visible Prelaunch Cal Ch 3a Slope 1	209	212	i	4	1	7		
Visible Prelaunch Cal Ch 3a Intercept 1	213	216	i	4	1	6		
Visible Prelaunch Cal Ch 3a Slope 2	217	220	i	4	1	7		
Visible Prelaunch Cal Ch 3a Intercept 2	221	224	i	4	1	6		
Visible Prelaunch Cal Ch 3a Intersection	225	228	i	4	1	0		
IR Operational Cal Ch 3b Coefficient 1	229	232	i	4	1	6		
IR Operational Cal Ch 3b Coefficient 2	233	236	i	4	1	6		
IR Operational Cal Ch 3b Coefficient 3	237	240	i	4	1	6		
IR Test Cal Ch 3b Coefficient 1	241	244	i	4	1	6		
IR Test Cal Ch 3b Coefficient 2	245	248	i	4	1	6		
IR Test Cal Ch 3b Coefficient 3	249	252	i	4	1	6		
IR Operational Cal Ch 4 Coefficient 1	253	256	i	4	1	6		
IR Operational Cal Ch 4 Coefficient 2	257	260	i	4	1	6		
IR Operational Cal Ch 4 Coefficient 3	261	264	i	4	1	6		
IR Test Cal Ch 4 Coefficient 1	265	268	i	4	1	6		
IR Test Cal Ch 4 Coefficient 2	269	272	i	4	1	6		
IR Test Cal Ch 4 Coefficient 3	273	276	i	4	1	6		
IR Operational Cal Ch 5 Coefficient 1	277	280	i	4	1	6		
IR Operational Cal Ch 5 Coefficient 2	281	284	i	4	1	6		
IR Operational Cal Ch 5 Coefficient 3	285	288	i	4	1	6		
IR Test Cal Ch 5 Coefficient 1	289	292	i	4	1	6		
IR Test Cal Ch 5 Coefficient 2	293	296	i	4	1	6		
IR Test Cal Ch 5 Coefficient 3	297	300	i	4	1	6		
<zero fill>	301	312	i	4	3	0		
NAVIGATION								
Navigation Status Bit Field	313	316	u	4	1	0		
bits 31-17: <zero fill>								
bit 16: 1 = earth location corrected for TIP Euler angles								
bits 15 - 12: earth location indicator								

<p>0 = earth location available; 1 = user ephemeris files greater than 24 hours old; 2 = no earth location available.</p> <p>bits 11 - 8: spacecraft attitude control 0 = operating in YGC or NOMINAL mode; 1 = operating in another mode; 2 = attitude exceeds nominal tolerance; 3 = both 1 and 2</p> <p>bits 7 - 4: attitude SMODE 0 = NOMINAL mode; 1 = rate nulling mode; 2 = YGC mode; 3 = search mode; 4 = coast mode</p> <p>bits 3 - 0: attitude Passive Wheel Test In Progress 0 = NOMINAL mode/no test; 1 = yaw axis test in progress; 2 = roll axis test in progress; 3 = pitch axis test in progress.</p>								
Time Associated with TIP Euler Angles	317	320	u	4	1	0	seconds	
TIP Euler Angles <i>Word 1:</i> Roll <i>Word 2:</i> Pitch <i>Word 3:</i> Yaw	321	326	i	2	3	3	degrees	
Spacecraft Altitude above Reference Ellipsoid	327	328	u	2	1	1	km	
Angular Relationships (relative azimuth range ± 180.00 degrees) <i>Word 1:</i> Solar Zenith Angle, Point 5 <i>Word 2:</i> Satellite Zenith Angle, Point 5 <i>Word 3:</i> Relative Azimuth Angle, Point 5 <i>Word 4:</i> Solar Zenith Angle, Point 13 ... (set of 3 angles every 8 points) ... <i>Word 153:</i> Relative Azimuth Angle, Point 405	329	634	i	2	153	2	degrees	
<zero fill>	635	640	i	2	3	0		

<p>Earth Location (North latitude and East longitude are positive)</p> <p><i>Word 1:</i> Latitude in Degrees, Point 5 <i>Word 2:</i> Longitude in Degrees, Point 5 <i>Word 3:</i> Latitude in Degrees, Point 13 ... (lat/lon word pair every 8 points) ... <i>Word 102:</i> Longitude in Degrees, Point 405</p>	641	1048	i	4	102	4		
<zero fill>	1049	1056	i	4	2	0		
HRPT MINOR FRAME TELEMETRY								
<p>Frame Sync The first sixty bits (six 10-bit values: 644, 367, 860, 413, 527, 149) from a 63 bit pseudonoise generator starting in the all 1's state. The generator polynomial is: $x^6 + x^5 + x^2 + 1$</p>	1057	1068	u	2	6	0		
<p>ID</p> <p><i>Word 1</i> bits 15-10: <zero fill> bit 9: 0 = internal sync; 1 = AVHRR sync bits 8-7: 0 = not an HRPT frame but a GAC frame; 1 = minor frame 1; 2 = minor frame 2; 3 = minor frame 3 bits 6-3: spacecraft address bit 2: 0 = frame stable; 1 = frame resync occurred bit 1: 0 = pseudonoise AVHRR input; 1 = normal AVHRR input bit 0: 0 = AVHRR Ch 3b; 1 = AVHRR Ch 3a</p> <p><i>Word 2</i> bits 15-10: <zero fill> bits 9-0: <undefined></p>	1069	1072	u	2	2	0		

<p>Time Code</p> <p><i>Word 1</i> bits 15-10: <zero fill> bits 9-1: binary day count bit 0 = 0</p> <p><i>Word 2</i> bits 15-10: <zero fill> bit 9 = 1 bit 8 = 0 bit 7 = 1 bits 6-0: most significant part of binary millisecond of day count</p> <p><i>Word 3</i> bits 15-10: <zero fill> bits 9-0: part of binary millisecond of day count</p> <p><i>Word 4</i> bits 15-10: <zero fill> bits 9-0: least significant part of binary millisecond of day count</p>	1073	1080	u	2	4	0		
<p>Telemetry</p> <p><i>Word 1:</i> Ramp Calibration AVHRR Channel 1 <i>Word 2:</i> Ramp Calibration AVHRR Channel 2 <i>Word 3:</i> Ramp Calibration AVHRR Channel 3 <i>Word 4:</i> Ramp Calibration AVHRR Channel 4 <i>Word 5:</i> Ramp Calibration AVHRR Channel 5</p> <p><i>Words 6-9</i> AVHRR Internal Target Temperature Data Three readings from one of the four platinum resistance thermometers (PRT). A different PRT is sampled for each scan; every fifth scan will contain a reference value of 0 in place of each reading.</p> <p><i>Word 6:</i> PRT Reading 1 <i>Word 7:</i> PRT Reading 2 <i>Word 8:</i> PRT Reading 3 <i>Word 9:</i> Patch Temperature</p> <p><i>Word 10:</i> <undefined></p>	1081	1100	u	2	10	0		

<p>Back Scan Ten words of calibration target view data from each AVHRR channel 3, 4, and 5.</p> <p><i>Word 1:</i> Channel 3, Word 1 ... <i>Word 3:</i> Channel 5, Word 1 <i>Word 4:</i> Channel 3, Word 2 ... <i>Word 30:</i> Channel 5, Word 10</p>	1101	1160	u	2	30	0		
<p>Space Data Ten words of space view data from each AVHRR channel 1, 2, 3, 4, 5</p> <p><i>Word 1:</i> Channel 1, Word 1 ... <i>Word 5:</i> Channel 5, Word 1 <i>Word 6:</i> Channel 1, Word 2 ... <i>Word 50:</i> Channel 5, Word 10</p>	1161	1260	u	2	50	0		
<p>Sync Delta bits 15-10: <zero fill> bit 9: 0 = AVHRR sync early; 1 = AVHRR sync late bits 8-0: 9-bit binary count of 0.9984 MHz periods</p>	1261	1262	u	2	1	0		
<zero fill>	1263	1264	i	2	1	0		
AVHRR SENSOR DATA								
<p>Sensor Data, Band Interleaved by Pixel (BIP)</p> <p><i>Word 1</i> bits 31-30: <zero fill> bits 29-20: Channel 1, Point 1 bits 19-10: Channel 2, Point 1 bits 9-0: Channel 3, Point 1</p> <p><i>Word 2</i> bits 31-30: <zero fill> bits 29-20: Channel 4, Point 1 bits 19-10: Channel 5, Point 1 bits 9-0: Channel 1, Point 2</p> <p>... <i>Word 682</i> bits 31-30: <zero fill> bits 29-20: Channel 4, Point 409 bits 19-10: Channel 5, Point 409 bits 9-0: <zero fill></p>	1265	3992	u	4	682	0		
<zero fill>	3993	4000	i	4	2	0		
DIGITAL B TELEMETRY								

Invalid Word Bit Flags (if bit = 1, associated telemetry bit was not updated during most recent minor frame cycle - possibly due to lost frame) bit 15: motor/telemetry bit 14: electronics/telemetry bit 13: channel 1 status bit 12: channel 2 status bit 11: channel 3a status bit 10: channel 3b status bit 9: channel 4 status bit 8: channel 5 status bit 7: channel 3a/3b select status bit 6: voltage calibrate status bit 5: cooler heat bit 4: scan motor bit 3: telemetry lock bit 2: earth shield bit 1: patch control bit 0: <zero fill>	4001	4002	u	2	1	0		
AVHRR Digital B Data bit 15: motor/telemetry (0 = off; 1 = on) bit 14: electronics/telemetry (0 = off; 1 = on) bit 13: channel 1 status (0 = disable; 1 = enable) bit 12: channel 2 status (0 = disable; 1 = enable) bit 11: channel 3a status (0 = disable; 1 = enable) bit 10: channel 3b status (0 = disable; 1 = enable) bit 9: channel 4 status (0 = disable; 1 = enable) bit 8: channel 5 status (0 = disable; 1 = enable) bit 7: channel 3a/3b select status (0 = 3b; 1 = 3a) bit 6: voltage calibrate status (0 = off; 1 = on) bit 5: cooler heat (0 = off; 1 = on) bit 4: scan motor (0 = low; 1 = high) bit 3: telemetry lock (0 = off; 1 = lock) bit 2: earth shield (0 = disable; 1 = deploy) bit 1: patch control (0 = off; 1 = on) bit 0: <zero fill>	4003	4004	u	2	1	0		
<zero fill>	4005	4016	i	4	3	0		
ANALOG HOUSEKEEPING DATA (TIP)								
Invalid Word Bit Flags (if bit = 1, associated telemetry word was not updated during most recent minor frame cycle - possibly due to lost frame) bits 31 - 23: <zero fill> bit 22: reference voltage (word 22) bits 21-2: words 21 through 2 (in order) bit 1: patch temperature (word 1) bit 0: <zero fill>	4017	4020	u	4	1	0		

<i>Word 1:</i> Patch Temperature <i>Word 2:</i> Patch Temperature Extended <i>Word 3:</i> Patch Power <i>Word 4:</i> Radiator Temperature <i>Word 5:</i> Black Body Temperature 1 <i>Word 6:</i> Black Body Temperature 2 <i>Word 7:</i> Black Body Temperature 3 <i>Word 8:</i> Black Body Temperature 4 <i>Word 9:</i> Electronics Current <i>Word 10:</i> Motor Current <i>Word 11:</i> Earth Shield Position <i>Word 12:</i> Electronics Temperature <i>Word 13:</i> Cooler Housing Temperature <i>Word 14:</i> Baseplate Temperature <i>Word 15:</i> Motor Housing Temperature <i>Word 16:</i> A/D Converter Temperature <i>Word 17:</i> Detector #4 Bias Voltage <i>Word 18:</i> Detector #5 Bias Voltage <i>Word 19:</i> Channel 3b Blackbody View <i>Word 20:</i> Channel 4 Blackbody View <i>Word 21:</i> Channel 5 Blackbody View <i>Word 22:</i> Reference Voltage	4021	4042	u	1	22	0		
<zero fill>	4043	4048	i	2	3	0		
CLOUDS FROM AVHRR (CLAVR)								
<Reserved>CLAVR Status Bit Field bits 31 - 1: <undefined> bit 0: CLAVR status 0 = disable, CCM codes zero-filled; 1 = enable	4049	4052	u	4	1	0		1
<Reserved>	4053	4056	u	4	1	0		

<Reserved>[CCM (Clear/Cloudy/Mixed) Codes (0 = clear; 1 = mixed clear; 2 = mixed cloudy; 3 =cloudy)]	4057	4160	u	2	52	0		
<i>Word 1</i> bits 15-14: CCM code, FOV 1 bits 13-12: CCM code, FOV 2 ... bits 1-0: CCM code, FOV 8 <i>Word 2</i> bits 15-14: CCM code, FOV 9 ... bits 1-0: CCM code, FOV 16 ... (set of 8 CCM codes per word) ... <i>Word 52</i> bits 15-14: CCM code, FOV 409 bits 13-0: <zero fill>								
FILLER								
<zero fill>	4161	4608	i	4	112	0		1

NOTES:

1. 12 Nov 1998: Redefine reserved CLAVR section to include CLAVR Status Bit Field (Fagan, 24 Sep1998); adjust trailing zero-fill.

Clouds from AVHRR (CLAVR) is a complex set of tests to detect daytime and nighttime cloud cover using multi-channel AVHRR sensor data and a surface type database. The first application of CLAVR at NOAA was to support the AVHRR Pathfinder Atmosphere (PATMOS) Project, which reprocessed AVHRR data to correct for calibration drift and produce a consistent record of atmospheric parameters for climate change studies. More information about the NOAA/NASA Pathfinder Program and PATMOS is available at <http://cimss.ssec.wisc.edu/clavr/patmosx.html> . Pathfinder products are available through the Comprehensive Large Array-data Stewardship System (CLASS): <http://www.class.noaa.gov>.

At this time CLAVR is part of the operational processing system for NOAA Level 1b GAC, LAC, and HRPT data sets as of Jan 25, 2006. Therefore, bit 0 of the NOAA Level 1b CLAVR Status Bit Field is set to one, and the Clear/Cloudy/Mixed (CCM) Codes are in use. Please note that the NOAA Level 1b format allocates space for only a minimal subset of CLAVR parameters needed to generate products that require cloud masks. NESDIS intends to implement CLAVR operationally as part of the Modernized AVHRR Processing System (MAPS).

More information about current CLAVR research and development at NOAA is available online at <http://cimss.ssec.wisc.edu/clavr/patmosx.html>.

Tables 8.3.1.4.3.1-2 and 8.3.1.4.3.1-3 (containing the 8 and 16-bit unpacked structure, respectively) summarize how the selection of channel and sensor data word size affects the octet placement of the data set structure documented in Table 8.3.1.4.3.1-1. While the alignment of data words on eight octet (i.e., 64 bit) boundaries is maintained by adding binary zero-fill after the sensor data section, in the interests of minimizing data set size the record lengths are no longer multiples of 512 octets.

Table 8.3.1.4.3.1-2. GAC 8-bit Extract Structure.					
Number of Channels	1	2	3	4	5
Pre-Data	1 - 1264	1 - 1264	1 - 1264	1 - 1264	1 - 1264
Sensor Data	1265 -1673	1265 - 2082	1265 - 2491	1265 - 2900	1265 - 3309
Alignment Zero-Fill	1674-1680	2083-2088	2492-2496	2901-2904	3310-3312
Post-Data	1681-1832	2089-2240	2497-2648	2905-3056	3313-3464
Trailing Zero-Fill	1833-1952	2241-2360	2649-2768	3057-3176	3465-3584
Record Length	6454	7679	8904	10129	11354

Table 8.3.1.4.3.1-3. GAC 16-bit Extract Structure.					
Number of Channels	1	2	3	4	5
Pre-Data	1 - 1264	1 - 1264	1 - 1264	1 - 1264	1 - 1264
Sensor Data	1265 - 2082	1265 - 2900	1265 - 3718	1265 - 4536	1265 - 5354
Alignment Zero-Fill	2083-2088	2901-2904	3719-3720	4537-4544	5355-5360
Post-Data	2089-2240	2905-3056	3721-3872	4545-4696	5361-5512
Trailing Zero-Fill	2241-2360	3057-3176	3873-3992	4697-4816	5513-5632
Record Length	2360	3176	3992	4816	5632

8.3.1.4.3.2 NOAA-N Format (Version 4, post-January 25, 2006 all spacecraft)

The format for packed GAC Level 1b data sets for NOAA-N (Version 4, post-January 25, 2006, all spacecraft) is documented in Table 8.3.1.4.3.2-1. See the legend in Section 8.3.1.1 for further explanation of the headings on this table.

Table 8.3.1.4.3.2-1. Format of GAC Data Record for NOAA-N (Version 4, post-January 25, 2006, all spacecraft).								
Field Name	Start Octet	End Octet	Data Type	Word Size	Number of Words	Scale Factor	Units	Notes
SCAN LINE INFORMATION								
Scan Line Number (<i>cumulative, starting with 1; range: 0 - 65,535</i>)	1	2	u	2	1	0		
Scan Line Year (e.g., 1999)	3	4	u	2	1	0		
Scan Line Day of Year (e.g., 365)	5	6	u	2	1	0		
Satellite Clock Drift Delta	7	8	i	2	1	0	millisec	
Scan Line UTC Time of Day	9	12	u	4	1	0	millisec	
Scan Line Bit Field bit 15: satellite direction (0=northbound; 1=southbound) bit 14: clock drift correction (0=not corrected; 1=scan time corrected for clock drift) bits 13-2: <zero fill> bits 1-0: channel 3 select (0=3B; 1=3A; 2=transition)	13	14	u	2	1	0		
<zero fill>	15	24	i	2	5	0		
QUALITY INDICATORS								

<p>Quality Indicator Bit Field (<i>if a bit is on (=1), the statement is true</i>)</p> <p>bit 31: do not use scan for product generation</p> <p>bit 30: time sequence error detected within this scan (see below)</p> <p>bit 29: data gap precedes this scanbit 28: insufficient data for calibration (see below)</p> <p>bit 27: earth location data not available (see below)</p> <p>bit 26: first good time following a clock update (nominally 0)</p> <p>bit 25: instrument status changed with this scan</p> <p>bit 24: sync lock dropped during this frame (NOAA) or <zero fill> MetOp</p> <p>bit 23: frame sync word has errors (NOAA) or <zero fill> MetOp</p> <p>bit 22: frame sync returned to lock (NOAA) or <zero fill> MetOp</p> <p>bit 21: frame sync word not valid (NOAA) or <zero fill> MetOp</p> <p>bit 20: bit slippage detected during this frame (NOAA) or <zero fill> MetOp</p> <p>bits 19-9: <zero fill></p> <p>bit 8: TIP parity error detected (NOAA) or <zero fill> MetOp</p> <p>bits 7-6: reflected sunlight detected ch 3B (0=no anomaly; 1=anomaly; 3=unsure)</p> <p>bits 5-4: reflected sunlight detected ch 4 (0=no anomaly; 1=anomaly; 3=unsure)</p> <p>bits 3-2: reflected sunlight detected ch 5 (0=no anomaly; 1=anomaly; 3=unsure)</p> <p>bit 1: resync occurred on this frame (NOAA) or <zero fill> MetOp</p> <p>bit 0: pseudonoise occurred on this frame (NOAA) or <zero fill> MetOp</p>	25	28	u	4	1	0		
<p>Scan Line Quality Flags [<Reserved>] (zero fill)</p>	29	29	u	1	1	0		
<p>Scan Line Quality Flags [Time Problem Code] (<i>If a bit is on (=1), the statement is true. All bits off implies the scan time is as expected.</i>)</p> <p>bit 7: time field is bad but can probably be inferred from the previous good time</p> <p>bit 6: time field is bad and can't be inferred from the previous good time</p> <p>bit 5: this record starts a sequence that is inconsistent with previous times (i.e., there is a time discontinuity). This may be associated with a spacecraft clock update. (See bit 26, Quality Indicator Bit Field.)</p> <p>bit 4: start of a sequence that apparently repeats scan times that have been previously accepted</p> <p>bits 3-0: <zero fill></p>	30	30	u	1	1	0		

Scan Line Quality Flags [Calibration Problem Code] (<i>If a bit is on (=1), the statement is true. These bits complement the channel indicators; all bits set to 0 indicate normal calibration.</i>) bit 7: scan line not calibrated: all IR channels failed calibration bit 6: scan line marginally calibrated: one or more IR channels marginally calibrated or one or more, but not all, IR channels failed calibration bit 5: scan line was not calibrated: bad or insufficient PRT data bit 4: scan line marginally calibrated: marginal PRT data bit 3: some uncalibrated channels for this scan line (i.e., one or more, but not all, IR channels failed calibration) bit 2: No visible calibration due to either the presence of MIRP pseudonoise in place of AVHRR data (NOAA only) or calibration processing turned off bit 1-0: <zero fill>	31	31	u	1	1	0		
Scan Line Quality Flags [Earth Location Problem Code] (<i>If a bit is on (=1), the statement is true. All bits set to 0 imply the earth location was normal.</i>) bit 7: not earth located because of bad time; earth location fields zero-filled bit 6: earth location questionable: questionable time code (see time problem flags above) bit 5: earth location questionable: marginal agreement with reasonableness check bit 4: earth location questionable: fails reasonableness check bits 3-2: <zero fill> bit 1: not earth located because of satellite in-plane maneuver (MetOp) or <zero fill> (NOAA) bit 0: not earth located because of satellite out-of-plane maneuver (MetOp) or <zero fill> (NOAA)	32	32	u	1	1	0		
Calibration Quality Flags (<i>all bits off implies a good calibration</i>) <i>Word 1: Channel 3B</i> bits 15-8: <zero fill> bit 7: this channel is not calibrated bit 6: this channel is calibrated but questionable bit 5: all bad blackbody counts for scan line bit 4: all bad space view counts for scan line bit 3: <zero fill> bit 2: marginal blackbody view counts for this line bit 1: marginal space view counts for this line bit 0: <zero fill> <i>Words 2-3: Channels 4-5 (in order)</i>	33	38	u	2	3	0		
Count of Bit Errors in Frame Sync (NOAA) or <zero fill> (MetOp)	39	40	u	2	1	0		
<zero fill>	41	48	i	4	2	0		
CALIBRATION COEFFICIENTS								
Visible Operational Cal Ch 1 Slope 1	49	52	i	4	1	7		

Visible Operational Cal Ch 1 Intercept 1	53	56	i	4	1	6		
Visible Operational Cal Ch 1 Slope 2	57	60	i	4	1	7		
Visible Operational Cal Ch 1 Intercept 2	61	64	i	4	1	6		
Visible Operational Cal Ch 1 Intersection	65	68	i	4	1	0		
Visible Test Cal Ch 1 Slope 1	69	72	i	4	1	7		
Visible Test Cal Ch 1 Intercept 1	73	76	i	4	1	6		
Visible Test Cal Ch 1 Slope 2	77	80	i	4	1	7		
Visible Test Cal Ch 1 Intercept 2	81	84	i	4	1	6		
Visible Test Cal Ch 1 Intersection	85	88	i	4	1	0		
Visible Prelaunch Cal Ch 1 Slope 1	89	92	i	4	1	7		
Visible Prelaunch Cal Ch 1 Intercept 1	93	96	i	4	1	6		
Visible Prelaunch Cal Ch 1 Slope 2	97	100	i	4	1	7		
Visible Prelaunch Cal Ch 1 Intercept 2	101	104	i	4	1	6		
Visible Prelaunch Cal Ch 1 Intersection	105	108	i	4	1	0		
Visible Operational Cal Ch 2 Slope 1	109	112	i	4	1	7		
Visible Operational Cal Ch 2 Intercept 1	113	116	i	4	1	6		
Visible Operational Cal Ch 2 Slope 2	117	120	i	4	1	7		
Visible Operational Cal Ch 2 Intercept 2	121	124	i	4	1	6		
Visible Operational Cal Ch 2 Intersection	125	128	i	4	1	0		
Visible Test Cal Ch 2 Slope 1	129	132	i	4	1	7		
Visible Test Cal Ch 2 Intercept 1	133	136	i	4	1	6		
Visible Test Cal Ch 2 Slope 2	137	140	i	4	1	7		
Visible Test Cal Ch 2 Intercept 2	141	144	i	4	1	6		
Visible Test Cal Ch 2 Intersection	145	148	i	4	1	0		
Visible Prelaunch Cal Ch 2 Slope 1	149	152	i	4	1	7		
Visible Prelaunch Cal Ch 2 Intercept 1	153	156	i	4	1	6		
Visible Prelaunch Cal Ch 2 Slope 2	157	160	i	4	1	7		
Visible Prelaunch Cal Ch 2 Intercept 2	161	164	i	4	1	6		
Visible Prelaunch Cal Ch 2 Intersection	165	168	i	4	1	0		

Visible Operational Cal Ch 3A Slope 1	169	172	i	4	1	7		
Visible Operational Cal Ch 3A Intercept 1	173	176	i	4	1	6		
Visible Operational Cal Ch 3A Slope 2	177	180	i	4	1	7		
Visible Operational Cal Ch 3A Intercept 2	181	184	i	4	1	6		
Visible Operational Cal Ch 3A Intersection	185	188	i	4	1	0		
Visible Test Cal Ch 3A Slope 1	189	192	i	4	1	7		
Visible Test Cal Ch 3A Intercept 1	193	196	i	4	1	6		
Visible Test Cal Ch 3A Slope 2	197	200	i	4	1	7		
Visible Test Cal Ch 3A Intercept 2	201	204	i	4	1	6		
Visible Test Cal Ch 3A Intersection	205	208	i	4	1	0		
Visible Prelaunch Cal Ch 3A Slope 1	209	212	i	4	1	7		
Visible Prelaunch Cal Ch 3A Intercept 1	213	216	i	4	1	6		
Visible Prelaunch Cal Ch 3A Slope 2	217	220	i	4	1	7		
Visible Prelaunch Cal Ch 3A Intercept 2	221	224	i	4	1	6		
Visible Prelaunch Cal Ch 3A Intersection	225	228	i	4	1	0		
IR Operational Cal Ch 3B Coefficient 1	229	232	i	4	1	6		
IR Operational Cal Ch 3B Coefficient 2	233	236	i	4	1	6		
IR Operational Cal Ch 3B Coefficient 3	237	240	i	4	1	6		
IR Test Cal Ch 3B Coefficient 1	241	244	i	4	1	6		
IR Test Cal Ch 3B Coefficient 2	245	248	i	4	1	6		
IR Test Cal Ch 3B Coefficient 3	249	252	i	4	1	6		
IR Operational Cal Ch 4 Coefficient 1	253	256	i	4	1	6		
IR Operational Cal Ch 4 Coefficient 2	257	260	i	4	1	6		
IR Operational Cal Ch 4 Coefficient 3	261	264	i	4	1	7		
IR Test Cal Ch 4 Coefficient 1	265	268	i	4	1	6		
IR Test Cal Ch 4 Coefficient 2	269	272	i	4	1	6		
IR Test Cal Ch 4 Coefficient 3	273	276	i	4	1	7		
IR Operational Cal Ch 5 Coefficient 1	277	280	i	4	1	6		
IR Operational Cal Ch 5 Coefficient 2	281	284	i	4	1	6		

IR Operational Cal Ch 5 Coefficient 3	285	288	i	4	1	7		
IR Test Cal Ch 5 Coefficient 1	289	292	i	4	1	6		
IR Test Cal Ch 5 Coefficient 2	293	296	i	4	1	6		
IR Test Cal Ch 5 Coefficient 3	297	300	i	4	1	7		
NAVIGATION								
Computed Yaw Steering (MetOp: content defined below) or <zero fill> (NOAA) Word 1: Computed roll angle Word 2: Computed pitch angle Word 3: Computed yaw angle	301	306	i	2	3	0	degrees	
Total Applied Attitude Correction Word 1: Roll Word 2: Pitch Word 3: Yaw	307	312	i	2	3	0	degrees	

<p>Navigation Status Bit Field (<i>content, defined below, depends on origin of data, either NOAA or Metop</i>)</p> <p><i>For NOAA Data:</i> bits 31-18: <zero fill> bit 17: earth location at the satellite subpoint is accurate and reasonable, i.e., is within tolerance defined by "Nadir Earth Location Tolerance" in header (0=out of tolerance; 1=in tolerance) bit 16: Euler error angles from the CPU telemetry used by AELDS to correct the earth locations (0=FALSE; 1=TRUE) bits 15-12: earth location indicator (0=earth location available; 1=first scan whose time is more than 24 hours older than the time [epoch] of the user ephemeris file; 2=no earth location available) bits 11-8: spacecraft attitude control (0=operating in YGC or NOMINAL mode and attitude is good; 1=operating in another mode but attitude is good; 2=operating in YGC or NOMINAL mode but tests are being conducted which may cause attitude to exceed nominal tolerance; 3=operating in another mode while tests are being conducted which may cause attitude to exceed nominal tolerance) bits 7-4: attitude SMODE (0=nominal mode; 1=rate nulling mode; 2=YGC mode; 3=search mode; 4=coast mode) bits 3-0: attitude PWTIP\$AC (0=nominal mode/no test; 1=yaw axis test in progress; 2=roll axis test in progress; 3=pitch axis test in progress)</p> <p><i>For Metop Data:</i> bits 31-21: <zero fill> bit 20-19: yaw steering parameters usage indicator (0=no yaw steering correction; 1=measured angles from the Metop SVM telemetry; 2=computed angles from AELDS; 3=measured angles + computed angles) bit 18: Metop maneuver indicator (0=scan does not occur during a Metop in-plane or out-of-plane maneuver; 1=scan, or some part of it, occurs during a maneuver) bit 17: <same as defined for NOAA, above> bit 16: <zero fill> bits 15-12: <same as defined for NOAA, above> bits 11-8: <zero fill> bits 7-4: OPM PF sub-mode (0=fine pointing mode (FPM); 1=yaw steering mode (YSM)) bits 3-0: SVM PF mode (0=LHM; 1=RRM; 2=CAM; 3=FAM1; 4=FAM2; 5=FAM3; 6=OPM; 7=OCM1; 8=OCM2; 9=OCMT; 10=OCM0)</p>	313	316	u	4	1	0		
Time Associated with Euler Angles	317	320	i	4	1	0	seconds	
<p>Euler Angles (<i>NOAA, from TIP CPU telemetry near end of scan; MetOp[in FPM], from SVM telemetry just before star of scan</i>) or Yaw Steering Parameters (<i>MetOp[in YSM], from SVM telemetry or AELDS near nadir of scan</i>)</p> <p>Word 1: Roll Word 2: Pitch Word 3: Yaw</p>	321	326	i	2	3	3	degrees	
Spacecraft Altitude above Reference Ellipsoid	327	328	u	2	1	1	km	

Angular Relationships (<i>relative azimuth range ±180.00 degrees</i>) Word 1: Solar zenith angle, FOV 5 Word 2: Satellite zenith angle, FOV 5 Word 3: Relative azimuth angle, FOV 5 Word 4: Solar zenith angle, FOV 13 ... (set of 3 angles every 8 FOVs) ... Word 153: Relative azimuth angle, FOV 405	329	634	i	2	153	2	degrees	
<Zero fill>	635	640	i	2	3	0		
Earth Location (<i>north latitude and east longitude are positive</i>) Word 1: Latitude, FOV 5 Word 2: Longitude, FOV 5 Word 3: Latitude, FOV 13 ...(lat/lon word pair every 8 FOVs) ... Word 102: Longitude, FOV 405	641	1048	i	4	102	4	degrees	
<Zero fill>	1049	1056	i	4	2	0		
FRAME TELEMETRY								
Frame Sync (<i>The first 60 bits (in 6 10-bit values) from a 63-bit pseudonoise generator starting in the all 1's state. The generator polynomial is: $x^6 + x^5 + x^2 + 1$.</i>) (NOAA: content defined below) or <Zero fill> MetOp Word 1: 644 Word 2: 367 Word 3: 860 Word 4: 413 Word 5: 527 Word 6: 149	1057	1068	u	2	6	0		
ID <i>Word 1</i> bits 15-10: <Zero fill> bit 9: MIRP/AVHRR sync (0=internal sync; 1=AVHRR sync) bits 8-7: frame ID 0=GAC frame; 1=HRPT minor frame 1; 2=HRPT minor frame 2; 3=HRPT minor frame 3. bits 6-3: spacecraft address bit 2: resync (0=frame stable; 1=frame resync occurred) bit 1: AVHRR input (0=pseudonoise; 1=normal) bit 0: channel 3 status (0=AVHRR channel 3B; 1=AVHRR channel 3A) <i>Word 2</i> bits 15-10: <Zero fill> bits 9-0: <undefined>	1069	1072	u	2	2	0		

<p>Time Code</p> <p><i>Word 1</i> bits 15-10: <Zero fill> bits 9-1: binary day count bit 0: 0 (zero)</p> <p><i>Word 2</i> bits 15-10: <Zero fill> bit 9: 1 (one) bit 8: 0 (zero) bit 7: 1 (one) bits 6-0: most significant part of binary millisecond of day count</p> <p><i>Word 3</i> bits 15-10: <Zero fill>bits 9-0: part of binary millisecond of day count</p> <p><i>Word 4</i> bits 15-10: <Zero fill> bits 9-0: least significant part of binary millisecond of day count</p>	1073	1080	u	2	4	0		
<p>Ramp Calibration</p> <p>Word 1: Ramp calibration, channel 1 Word 2: Ramp calibration, channel 2 Word 3: Ramp calibration, channel 3 Word 4: Ramp calibration, channel 4 Word 5: Ramp calibration, channel 5</p>	1081	1090	u	2	5	0	counts	
<p>Internal Target Temperature (<i>Three readings from one of the four platinum resistance thermometers (PRT). A different PRT is sampled for each scan. Every fifth scan will contain a reference value of 0 in place of each reading.</i>)</p> <p>Word 1: PRT reading 1 Word 2: PRT reading 2 Word 3: PRT reading 3</p>	1091	1096	u	2	3	0	counts	
<p>Patch Temperature</p>	1097	1098	u	2	1	0	counts	
<p><Undefined> (NOAA) or <Zero fill> MetOp</p>	1099	1100	u	2	1	0		
<p>Back Scan (<i>Ten samples of calibration target view data from each of AVHRR channels 3, 4, and 5.</i>)</p> <p>Word 1: channel 3, sample 1 Word 2: channel 4, sample 1 Word 3: channel 5, sample 1 Word 4: channel 3, sample 2 ... Word 30: channel 5, sample 10</p>	1101	1160	u	2	30	0	counts	

Space Data (<i>Ten samples of space view data from each of AVHRR channels 1, 2, 3, 4, and 5.</i>) Word 1: channel 1, sample 1 Word 2: channel 2, sample 1 ... Word 5: channel 5, sample 1 Word 6: channel 1, sample 2 ... Word 50: channel 5, sample 10	1161	1260	u	2	50	0	count	
Sync Delta (NOAA: content defined below) or <Zero fill> MetOp bits 15-10: <Zero fill> bit 9: AVHRR sync (0=early; 1=late)bits 8-0: 9-bit binary count of 0.9984 MHz periods	1261	1262	u	2	1	0		
<Zero fill>	1263	1264	i	2	1	0		
EARTH OBSERVATIONS								
Earth Data Word 1 bits 31-30: <Zero fill> bits 29-20: channel 1, FOV 1 bits 19-10: channel 2, FOV 1 bits 9-0: channel 3, FOV 1 Word 2 bits 31-30: <Zero fill> bits 29-20: channel 4, FOV 1 bits 19-10: channel 5, FOV 1 bits 9-0: channel 1, FOV 2 ... Word 682 bits 31-30: <Zero fill> bits 29-20: channel 4, FOV 409 bits 19-10: channel 5, FOV 409 bits 9-0: <Zero fill>	1265	3992	u	4	682	0	counts	
<Zero fill>	3993	4000	i	4	2	0		
DIGITAL B HOUSEKEEPING TELEMETRY								

<p>Digital B Telemetry Update Flags (<i>If bit = 0, associated telemetry item is up-to-date. If bit = 1, associated telemetry item was not updated during most recent telemetry cycle - possibly due to lost frame.</i>)</p> <p>bit 15: scan motor/telemetry status bit 14: electronics/telemetry status bit 13: channel 1 status bit 12: channel 2 status bit 11: channel 3A status bit 10: channel 3B status bit 9: channel 4 status bit 8: channel 5 status bit 7: channel 3A/3B select status bit 6: voltage calibration status bit 5: cooler heat status bit 4: scan motor mode status bit 3: telemetry lock status bit 2: earth shield status bit 1: patch control status bit 0: <Zero fill></p>	4001	4002	u	2	1	0		
<p>AVHRR Digital B Data</p> <p>bit 15: scan motor/telemetry status (0=off; 1=on) bit 14: electronics/telemetry status (0=off; 1=on) bit 13: channel 1 status (0=disable; 1=enable) bit 12: channel 2 status (0=disable; 1=enable) bit 11: channel 3A status (0=disable; 1=enable) bit 10: channel 3B status (0=disable; 1=enable) bit 9: channel 4 status (0=disable; 1=enable) bit 8: channel 5 status (0=disable; 1=enable) bit 7: channel 3A/3B select status (0=3B; 1=3A) bit 6: voltage calibration status (0=off; 1=on) bit 5: cooler heat status (0=off; 1=on) bit 4: scan motor mode status (0=low; 1=high) bit 3: telemetry lock status (0=not locked on; 1=locked on) bit 2: earth shield status (0=disable; 1=deploy) bit 1: patch control status (0=off; 1=on) bit 0: <Zero fill></p>	4003	4004	u	2	1	0		
<Zero fill>	4005	4016	i	4	3	0		
ANALOG HOUSEKEEPING TELEMETRY								

Analog Telemetry Update Flags (<i>If bit = 0, associated telemetry item is up-to-date. If bit = 1, associated telemetry item was not updated during most recent telemetry cycle - possibly due to lost frame.</i>) bits 31-23: <Zero fill> bit 22: motor current bit 21: electronics current bit 20: blackbody temperature, channel 5 bit 19: detector #5 bias voltage bit 18: blackbody temperature, channel 4 bit 17: blackbody temperature, channel 3B bit 16: A/D converter temperature bit 15: black body temperature 4 bit 14: black body temperature 3 bit 13: black body temperature 2 bit 12: black body temperature 1 bit 11: motor housing temperature bit 10: baseplate temperature bit 9: electronics temperature bit 8: cooler housing temperature bit 7: radiator temperature bit 6: patch temperature bit 5: earth shield position bit 4: patch temperature extended bit 3: detector #4 bias voltage bit 2: reference voltage bit 1: patch power bit 0: <Zero fill>	4017	4020	u	4	1	0		
Patch Temperature (<i>range: 0 - 255</i>)	4021	4021	u	1	1	0	counts	
Patch Temperature Extended (<i>range: 0 - 255</i>)	4022	4022	u	1	1	0	counts	
Patch Power (<i>range: 0 - 255</i>)	4023	4023	u	1	1	0	counts	
Radiator Temperature (<i>range: 0 - 255</i>)	4024	4024	u	1	1	0	counts	
Black Body Temperature 1 (<i>range: 0 - 255</i>)	4025	4025	u	1	1	0	counts	
Black Body Temperature 2 (<i>range: 0 - 255</i>)	4026	4026	u	1	1	0	counts	
Black Body Temperature 3 (<i>range: 0 - 255</i>)	4027	4027	u	1	1	0	counts	
Black Body Temperature 4 (<i>range: 0 - 255</i>)	4028	4028	u	1	1	0	counts	
Electronics Current (<i>range: 0 - 255</i>)	4029	4029	u	1	1	0	counts	
Motor Current (<i>range: 0 - 255</i>)	4030	4030	u	1	1	0	counts	
Earth Shield Position (<i>range: 0 - 255</i>)	4031	4031	u	1	1	0	counts	
Electronics Temperature (<i>range: 0 - 255</i>)	4032	4032	u	1	1	0	counts	
Cooler Housing Temperature (<i>range: 0 - 255</i>)	4033	4033	u	1	1	0	counts	

Baseplate Temperature (range: 0 - 255)	4034	4034	u	1	1	0	counts	
Motor Housing Temperature (range: 0 - 255)	4035	4035	u	1	1	0	counts	
A/D Converter Temperature (range: 0 - 255)	4036	4036	u	1	1	0	counts	
Detector #4 Bias Voltage (range: 0 - 255)	4037	4037	u	1	1	0	counts	
Detector #5 Bias Voltage (range: 0 - 255)	4038	4038	u	1	1	0	counts	
Blackbody Temperature, Channel 3B (range: 0 - 255)	4039	4039	u	1	1	0	counts	
Blackbody Temperature, Channel 4 (range: 0 - 255)	4040	4040	u	1	1	0	counts	
Blackbody Temperature, Channel 5 (range: 0 - 255)	4041	4041	u	1	1	0	counts	
Reference Voltage (range: 0 - 255)	4042	4042	u	1	1	0	counts	
<Zero fill>	4043	4048	i	2	3	0		
CLOUDS FROM AVHRR (CLAVR)								
<Reserved> [CLAVR Status Bit Field] bits 31-1: <undefined> bit 0: CLAVR status (0=disable, CCM codes zero-filled; 1=enable)	4049	4052	u	4	1	0		
<Reserved> [CLAVR]	4053	4056	u	4	1	0		
<Reserved> [CLAVR CCM (Clear/Cloudy/Mixed) Codes (0=clear; 1=mixed clear; 2=mixed cloudy; 3=cloudy)] Word 1 bits 15-14: CCM code, FOV 1 bits 13-12: CCM code, FOV 2 ... bits 1-0: CCM code, FOV 8 Word 2 bits 15-14: CCM code, FOV 9 ... bits 1-0: CCM code, FOV 16 ... set of 8 CCM codes per word) ... Word 52 bits 15-14: CCM code, FOV 409 bits 13-0: <Zero fill>	4057	4160	u	2	52	0		
FILLER								
<Zero fill>	4161	4608	i	4	112	0		

8.3.1.5 HIRS Data Sets

This section describes the characteristics and formats of the High Resolution Infrared Radiation Sounder (both HIRS/3 and HIRS/4) data sets for both NOAA KLM (Version 2) and NOAA-N (version 3) satellites. Version 2 formats (v2) were used on all NOAA KLM data until April 28, 2005. After this date, the Version 3 format (v3), also known as the NOAA-N format, will be implemented for all operational POES spacecraft. There is no plan at this time to reprocess archived data into the new format. **After January 25, 2006, the version number contained in the header was updated from 3 to 4 to reflect the inclusion of cloud mask information. All level 1b documentation should reflect that until another change is made.**

8.3.1.5.1 Data Characteristics

This section describes the characteristics of the High Resolution Infrared Radiation Sounder (both HIRS/3 and HIRS/4) instruments.

8.3.1.5.1.1 HIRS/3

HIRS/3 radiometric data is digitized to 13-bit precision. The data is recorded on the satellite and transmitted to Earth on command. Table 8.3.1.5.1.1-1 summarizes fundamental characteristics of the data.

Table 8.3.1.5.1.1-1. HIRS/3 Data Characteristics.	
Parameter	Value
Sample word size	13 bits
Number of sampled channels/available channels	20/20
Number of Earth samples per scan	56 per channel
Scan rate	9.4 scans per minute
Scan direction	West to East (northbound)
Instantaneous Field of View (IFOV)	1.3 to 1.4 degrees
Spatial resolution at nadir	18.9 to 20.3 km at 833 km altitude
Cross track distance between sample centers at nadir	26.2 km at 833 km altitude

Along track distance between sample centers at nadir	42 km at 833 km altitude
Cross-track scan coverage	± 49.5 degrees from nadir
Swath width	2240 km at 833 km altitude

8.3.1.5.1.2 HIRS/4

The HIRS/4 instrument replaced HIRS/3 on NOAA-18 and NOAA-19. Several modifications have been made: 1) the field of view has decreased to 10 km from 19 km for the HIRS/3; 2) another PRT has been added to the blackbody. This is directly in the center and gives a better characterization of the temperature gradient as well as providing a better estimate of the blackbody temperature within the smaller angular field of view; and 3) there is a new temperature sensor near the field stop. Table 3.2.2.1-1 contains a detailed description of the characteristics of the HIRS/4 instrument.

8.3.1.5.2 Header Records

This section describes the header record formats for both HIRS/3 and HIRS/4 instruments for both NOAA KLM (version 2) and NOAA-N (version 3) satellites. Version 2 formats (v2) apply to all NOAA KLM data until April 28, 2005. After this date, the version 3 format (v3), was in effect for all operational POES spacecraft until January 25, 2006. On January 26, 2006, version 4 was implemented to reflect the inclusion of cloud mask information.

8.3.1.5.2.1 HIRS/3 (Flown on NOAA KLM, version 2, pre-April 28, 2005)

The HIRS/3 Data Set Header Record format HIRS/3 (Flown on NOAA KLM, version 2, pre-April 28, 2005) is documented in Table 8.3.1.5.2.1-1.

Table 8.3.1.5.2.1-1. Format of HIRS/3 Data Set Header Record (Flown on NOAA KLM, version 2, pre-April 28, 2005)								
Field Name	Start Octet	End Octet	DT	Word Size	Number of Words	S F	Units	Notes
FILE IDENTIFICATION								

Data Set Creation Site ID CMS = Centre de Meteorologie Spatiale/France; DSS = Dundee Satellite Receiving Station/UK; NSS = National Environmental Satellite, Data and Information Service/USA; UKM = United Kingdom Meteorological Office/UK	1	3	c	3	1	0		
<ASCII blank = x20>	4	4	c	1	1	0		
NOAA Level 1b Format Version Number 1=TIROS-N, NOAA-6 through NOAA-14 2=NOAA-15, -16, -17 (pre-April 28, 2005 3=all satellites post-April 28, 2005, 4=cloud mask flag (CLAVR-x)-Jan 25, 2006	5	6	u	2	1	0		
NOAA Level 1b Format Version Year (e.g., 1999)	7	8	u	2	1	0		
NOAA Level 1b Format Version Day of Year (e.g., 365)	9	10	u	2	1	0		
<Reserved for Logical Record Length> For Creation Site use only. Logical Record Length of NOAA Level 1b data set prior to processing.	11	12	u	2	1	0	octets	
<Reserved for Block Size> For Creation Site use only. Block Size of NOAA Level 1b data set prior to processing.	13	14	u	2	1	0	octets	
Count of Header Records in this Data Set	15	16	u	2	1	0		
<zero fill>	17	22	i	2	3	0		
Data Set Name	23	64	c	42	1	0		
Processing Block Identification	65	72	c	8	1	0		

NOAA Spacecraft Identification Code 2 = NOAA-16; 4 = NOAA-15; 6 = NOAA-17; 7 = NOAA-18; 8 = NOAA-N' 11 = MetOp-1 12 = MetOp-2 13 = MetOp-3	73	74	u	2	1	0		
Instrument ID 301 = s/n 301 (NOAA-16); 302 = s/n 302 (NOAA-15); 303 = s/n 303 (NOAA-17); 305 = s/n 305 (NOAA-18); 308 = s/n 308 (NOAA-19) 306 = s/n306 (MetOp-A) 307 = s/n307 (MetOp-B)	75	76	u	2	1	0		
Data Type Code 5 = HIRS	77	78	u	2	1	0		
TIP Source Code 0 = unused, GAC/HRPT/LAC data; 1 = GAC embedded AMSU and TIP; 2 = stored TIP; 3 = HRPT/LAC embedded AMSU and TIP; 4 = stored AIP	79	80	u	2	1	0		
Start of Data Set Day Count starting from 0 at 00h, 1 Jan 1950	81	84	u	4	1	0		
Start of Data Set Year (e.g., 1999)	85	86	u	2	1	0		
Start of Data Set Day of Year (e.g., 365)	87	88	u	2	1	0		
Start of Data Set UTC Time of Day	89	92	u	4	1	0	milli- second	
End of Data Set Day Count starting from 0 at 00h, 1 Jan 1950	93	96	u	4	1	0		
End of Data Set Year (e.g., 1999)	97	98	u	2	1	0		
End of Data Set Day of Year (e.g., 365)	99	100	u	2	1	0		
End of Data Set UTC Time of Day	101	104	u	4	1	0	milli- second	
Year of Last CPIDS Update (e.g., 1999)	105	106	u	2	1	0		
Day of Year of Last CPIDS Update (e.g., 365)	107	108	u	2	1	0		

<zero fill>	109	116	i	2	4	0		
DATA SET QUALITY INDICATORS								
Instrument Status bits 31-16: <zero fill> bit 15: Instrument power bit 14: Electronics power bit 13: Filter motor power bit 12: Scan motor power bit 11: Cooler heater bit 10: Filter housing heater bit 9: Cooler door release bit 8: Cooler window heater bit 7: Go to NADIR position bit 6: Calibration sequence bit 5: Cooler door closed bit 4: Cooler door fully open bit 3: Filter motor power level bit 2: Patch temperature controller bits 1-0: <zero fill>	117	120	u	4	1	0		
<zero fill>	121	122	i	2	1	0		
Record Number of Status Change (if 0, none occurred)	123	124	u	2	1	0		
Second Instrument Status (if previous word is 0, no change)	125	128	u	4	1	0		
Count of Data Records in this Data Set	129	130	u	2	1	0		
Count of Calibrated, Earth Located Scan Lines in this Data Set	131	132	u	2	1	0		
Count of Missing Scan Lines	133	134	u	2	1	0		
Count of Data Gaps in this Data Set	135	136	u	2	1	0		
Count of Data Frames Without Frame Sync Word Errors	137	138	u	2	1	0		
Count of PACS Detected TIP Parity Errors	139	140	u	2	1	0		
Sum of All Auxiliary Sync Errors Detected in the Input Data	141	142	u	2	1	0		
Time Sequence Error (0 = none; otherwise the record number of the first occurrence)	143	144	u	2	1	0		

<p>Time Sequence Error Code These are bit flags taken from Scan Line Quality Flags Time Problem Code on data record reported in Time Sequence Error field above.</p> <p>If a bit is on (=1) then the statement is true.</p> <p>bits 15 - 8: <zero fill> bit 7: time field is bad but can probably be inferred from the previous good time. bit 6: time field is bad and can't be inferred from the previous good time. bit 5: this record starts a sequence that is inconsistent with previous times (i.e., there is a time discontinuity). This may or may not be associated with a spacecraft clock update. bit 4: start of a sequence that apparently repeats scan times that have been previously accepted. bits 3 - 0: <zero fill></p>	145	146	u	2	1	0		
<p>SOCC Clock Update Indicator (0 = none during this orbit; otherwise the record number of the first occurrence)</p>	147	148	u	2	1	0		
<p>Earth Location Error Indicator (0 = none during this orbit; otherwise the record number of the first occurrence)</p>	149	150	u	2	1	0		
<p>Earth Location Error Code These are bit flags taken from Scan Line Quality Flags Earth Location Problem Code on data record reported in Earth Location Error Indicator field above.</p> <p>If a bit is on (=1) then the statement is true.</p> <p>bits 15 - 8: <zero fill> bit 7: not earth located because of bad time; earth location fields zero filled. bit 6: earth location questionable because of questionable time code. (See time problem flags above.) bit 5: earth location questionable -- only marginal agreement with reasonableness check. bit 4: earth location questionable -- fails reasonableness check. bits 3-0: <zero fill></p>	151	152	u	2	1	0		

PACS Status Bit Field bits 15-3: <zero fill> bit 2: pseudo noise (0 = normal data; 1 = P/N data) bit 1: tape direction (0 = time decrementing) bit 0: data mode (0 = test data; 1 = flight data)	153	154	u	2	1	0		
PACS Data Source 0 = unused; 1 = Fairbanks, AK; 2 = Wallops Is, VA; 3 = SOCC 4 = Svalbard, Norway 5 = Monterey, CA	155	156	u	2	1	0		
<zero fill>	157	160	i	4	1	0		
<Reserved for the Ingester>	161	168	c	8	1	0		
<Reserved for Decommutation>	169	176	c	8	1	0		
<zero fill>	177	186	i	2	5	0		
CALIBRATION								
Ramp/auto Calibration Indicators Bit Field bit 0: auto calibration override switch for HIRS/3	187	188	u	2	1	0		
Year of Most Recent Solar Channel Calibration (e.g., 1999)	189	190	u	2	1	0		
Day of Year of Most Recent Solar Channel Calibration (e.g., 365)	191	192	u	2	1	0		
Mean Calibration Slope of Channel 1	193	196	i	4	1	6		
Standard Deviation of Calibration Slope for Channel 1	197	200	i	4	1	6		
B ₁ for Channel 1	201	204	i	4	1	6		
Std Deviation of Linear Regression for B ₁ Ch 1	205	208	i	4	1	6		
Mean Calibration Slope of Channel 17	209	212	i	4	1	6		
Standard Deviation of Calibration Slope for Channel 17	213	216	i	4	1	6		

B ₁ for Channel 17	217	220	i	4	1	6		
Std Deviation of Linear Regression for B ₁ Ch 17	221	224	i	4	1	6		
Mean Calibration Slope of Channel 2	225	228	i	4	1	6		
Standard Deviation of Calibration Slope for Channel 2	229	232	i	4	1	6		
B ₁ for Channel 2	233	236	i	4	1	6		
Std Deviation of Linear Regression for B ₁ Ch 2	237	240	i	4	1	6		
Mean Calibration Slope of Channel 3	241	244	i	4	1	6		
Standard Deviation of Calibration Slope for Channel 3	245	248	i	4	1	6		
B ₁ for Channel 3	249	252	i	4	1	6		
Std Deviation of Linear Regression for B ₁ Ch 3	253	256	i	4	1	6		
Mean Calibration Slope of Channel 13	257	260	i	4	1	6		
Standard Deviation of Calibration Slope for Channel 13	261	264	i	4	1	6		
B ₁ for Channel 13	265	268	i	4	1	6		
Std Deviation of Linear Regression for B ₁ Ch 13	269	272	i	4	1	6		
Mean Calibration Slope of Channel 4	273	276	i	4	1	6		
Standard Deviation of Calibration Slope for Channel 4	277	280	i	4	1	6		
B ₁ for Channel 4	281	284	i	4	1	6		
Std Deviation of Linear Regression for B ₁ Ch 4	285	288	i	4	1	6		
Mean Calibration Slope of Channel 18	289	292	i	4	1	6		
Standard Deviation of Calibration Slope for Channel 18	293	296	i	4	1	6		
B ₁ for Channel 18	297	300	i	4	1	6		
Std Deviation of Linear Regression for B ₁ Ch 18	301	304	i	4	1	6		

Mean Calibration Slope of Channel 11	305	308	i	4	1	6		
Standard Deviation of Calibration Slope for Channel 11	309	312	i	4	1	6		
B ₁ for Channel 11	313	316	i	4	1	6		
Std Deviation of Linear Regression for B ₁ Ch 11	317	320	i	4	1	6		
Mean Calibration Slope of Channel 19	321	324	i	4	1	6		
Standard Deviation of Calibration Slope for Channel 19	325	328	i	4	1	6		
B ₁ for Channel 19	329	332	i	4	1	6		
Std Deviation of Linear Regression for B ₁ Ch 19	333	336	i	4	1	6		
Mean Calibration Slope of Channel 7	337	340	i	4	1	6		
Standard Deviation of Calibration Slope for Channel 7	341	344	i	4	1	6		
B ₁ for Channel 7	345	348	i	4	1	6		
Std Deviation of Linear Regression for B ₁ Ch 7	349	352	i	4	1	6		
Mean Calibration Slope of Channel 8	353	356	i	4	1	6		
Standard Deviation of Calibration Slope for Channel 8	357	360	i	4	1	6		
B ₁ for Channel 8	361	364	i	4	1	6		
Std Deviation of Linear Regression for B ₁ Ch 8	365	368	i	4	1	6		
Mean Calibration Slope of Channel 20	369	372	i	4	1	6		
Standard Deviation of Calibration Slope for Channel 20	373	376	i	4	1	6		
B ₁ for Channel 20	377	380	i	4	1	6		
Std Deviation of Linear Regression for B ₁ Ch 20	381	384	i	4	1	6		
Mean Calibration Slope of Channel 10	385	388	i	4	1	6		
Standard Deviation of Calibration Slope for Channel 10	389	392	i	4	1	6		

B ₁ for Channel 10	393	396	i	4	1	6		
Std Deviation of Linear Regression for B ₁ Ch 10	397	400	i	4	1	6		
Mean Calibration Slope of Channel 14	401	404	i	4	1	6		
Standard Deviation of Calibration Slope for Channel 14	405	408	i	4	1	6		
B ₁ for Channel 14	409	412	i	4	1	6		
Std Deviation of Linear Regression for B ₁ Ch 14	413	416	i	4	1	6		
Mean Calibration Slope of Channel 6	417	420	i	4	1	6		
Standard Deviation of Calibration Slope for Channel 6	421	424	i	4	1	6		
B ₁ for Channel 6	425	428	i	4	1	6		
Std Deviation of Linear Regression for B ₁ Ch 6	429	432	i	4	1	6		
Mean Calibration Slope of Channel 5	433	436	i	4	1	6		
Standard Deviation of Calibration Slope for Channel 5	437	440	i	4	1	6		
B ₁ for Channel 5	441	444	i	4	1	6		
Std Deviation of Linear Regression for B ₁ Ch 5	445	448	i	4	1	6		
Mean Calibration Slope of Channel 15	449	452	i	4	1	6		
Standard Deviation of Calibration Slope for Channel 15	453	456	i	4	1	6		
B ₁ for Channel 15	457	460	i	4	1	6		
Std Deviation of Linear Regression for B ₁ Ch 15	461	464	i	4	1	6		
Mean Calibration Slope of Channel 12	465	468	i	4	1	6		
Standard Deviation of Calibration Slope for Channel 12	469	472	i	4	1	6		
B ₁ for Channel 12	473	476	i	4	1	6		
Std Deviation of Linear Regression for B ₁ Ch 12	477	480	i	4	1	6		

Mean Calibration Slope of Channel 16	481	484	i	4	1	6		
Standard Deviation of Calibration Slope for Channel 16	485	488	i	4	1	6		
B ₁ for Channel 16	489	492	i	4	1	6		
Std Deviation of Linear Regression for B ₁ Ch 16	493	496	i	4	1	6		
Mean Calibration Slope of Channel 9	497	500	i	4	1	6		
Standard Deviation of Calibration Slope for Channel 9	501	504	i	4	1	6		
B ₁ for Channel 9	505	508	i	4	1	6		
Std Deviation of Linear Regression for B ₁ Ch 9	509	512	i	4	1	6		
<zero fill>	513	520	i	4	2	0		
TEMPERATURE-RADIANCE CONVERSION								
Temperature-radiance Ch 1 Central Wavenumber	521	524	i	4	1	6	cm ⁻¹	
Temperature-radiance Ch 1 Constant 1	525	528	i	4	1	6		
Temperature-radiance Ch 1 Constant 2	529	532	i	4	1	6		
Temperature-radiance Ch 2 Central Wavenumber	533	536	i	4	1	6	cm ⁻¹	
Temperature-radiance Ch 2 Constant 1	537	540	i	4	1	6		
Temperature-radiance Ch 2 Constant 2	541	544	i	4	1	6		
Temperature-radiance Ch 3 Central Wavenumber	545	548	i	4	1	6	cm ⁻¹	
Temperature-radiance Ch 3 Constant 1	549	552	i	4	1	6		
Temperature-radiance Ch 3 Constant 2	553	556	i	4	1	6		
Temperature-radiance Ch 4 Central Wavenumber	557	560	i	4	1	6	cm ⁻¹	
Temperature-radiance Ch 4 Constant 1	561	564	i	4	1	6		
Temperature-radiance Ch 4 Constant 2	565	568	i	4	1	6		
Temperature-radiance Ch 5 Central Wavenumber	569	572	i	4	1	6	cm ⁻¹	

Temperature-radiance Ch 5 Constant 1	573	576	i	4	1	6		
Temperature-radiance Ch 5 Constant 2	577	580	i	4	1	6		
Temperature-radiance Ch 6 Central Wavenumber	581	584	i	4	1	6	cm ⁻¹	
Temperature-radiance Ch 6 Constant 1	585	588	i	4	1	6		
Temperature-radiance Ch 6 Constant 2	589	592	i	4	1	6		
Temperature-radiance Ch 7 Central Wavenumber	593	596	i	4	1	6	cm ⁻¹	
Temperature-radiance Ch 7 Constant 1	597	600	i	4	1	6		
Temperature-radiance Ch 7 Constant 2	601	604	i	4	1	6		
Temperature-radiance Ch 8 Central Wavenumber	605	608	i	4	1	6	cm ⁻¹	
Temperature-radiance Ch 8 Constant 1	609	612	i	4	1	6		
Temperature-radiance Ch 8 Constant 2	613	616	i	4	1	6		
Temperature-radiance Ch 9 Central Wavenumber	617	620	i	4	1	6	cm ⁻¹	
Temperature-radiance Ch 9 Constant 1	621	624	i	4	1	6		
Temperature-radiance Ch 9 Constant 2	625	628	i	4	1	6		
Temperature-radiance Ch 10 Central Wavenumber	629	632	i	4	1	6	cm ⁻¹	
Temperature-radiance Ch 10 Constant 1	633	636	i	4	1	6		
Temperature-radiance Ch 10 Constant 2	637	640	i	4	1	6		
Temperature-radiance Ch 11 Central Wavenumber	641	644	i	4	1	6	cm ⁻¹	
Temperature-radiance Ch 11 Constant 1	645	648	i	4	1	6		
Temperature-radiance Ch 11 Constant 2	649	652	i	4	1	6		
Temperature-radiance Ch 12 Central Wavenumber	653	656	i	4	1	6	cm ⁻¹	
Temperature-radiance Ch 12 Constant 1	657	660	i	4	1	6		
Temperature-radiance Ch 12 Constant 2	661	664	i	4	1	6		
Temperature-radiance Ch 13 Central Wavenumber	665	668	i	4	1	5	cm ⁻¹	

Temperature-radiance Ch 13 Constant 1	669	672	i	4	1	6		
Temperature-radiance Ch 13 Constant 2	673	676	i	4	1	6		
Temperature-radiance Ch 14 Central Wavenumber	677	680	i	4	1	5	cm ⁻¹	
Temperature-radiance Ch 14 Constant 1	681	684	i	4	1	6		
Temperature-radiance Ch 14 Constant 2	685	688	i	4	1	6		
Temperature-radiance Ch 15 Central Wavenumber	689	692	i	4	1	5	cm ⁻¹	
Temperature-radiance Ch 15 Constant 1	693	696	i	4	1	6		
Temperature-radiance Ch 15 Constant 2	697	700	i	4	1	6		
Temperature-radiance Ch 16 Central Wavenumber	701	704	i	4	1	5	cm ⁻¹	
Temperature-radiance Ch 16 Constant 1	705	708	i	4	1	6		
Temperature-radiance Ch 16 Constant 2	709	712	i	4	1	6		
Temperature-radiance Ch 17 Central Wavenumber	713	716	i	4	1	5	cm ⁻¹	
Temperature-radiance Ch 17 Constant 1	717	720	i	4	1	6		
Temperature-radiance Ch 17 Constant 2	721	724	i	4	1	6		
Temperature-radiance Ch 18 Central Wavenumber	725	728	i	4	1	5	cm ⁻¹	
Temperature-radiance Ch 18 Constant 1	729	732	i	4	1	6		
Temperature-radiance Ch 18 Constant 2	733	736	i	4	1	6		
Temperature-radiance Ch 19 Central Wavenumber	737	740	i	4	1	5	cm ⁻¹	
Temperature-radiance Ch 19 Constant 1	741	744	i	4	1	6		
Temperature-radiance Ch 19 Constant 2	745	748	i	4	1	6		
Albedo-radiance Ch 20 Solar Filtered Irradiance	749	750	i	2	1	6		
Albedo-radiance Ch 20 Equivalent Filter Width	751	752	i	2	1	6		
<zero fill>	753	760	i	4	2	0		
NAVIGATION								

Reference Ellipsoid Model ID The ellipsoid is a mathematically tractable approximation of the geoid, which is an equipotential surface at mean sea level. The maximum departure of the ellipsoid from the geoid is approximately ± 65 meters. (WGS-72 = World Geodetic Survey 1972)	761	768	c	8	1	0		
Nadir Earth Location Tolerance	769	770	u	2	1	1	km	
Earth Location Bit Field bits 15 - 2: <zero fill> bit 1: reasonableness test active (0 = inactive) bit 0: attitude error correction (0 = not corrected)	771	772	u	2	1	0		
<zero fill>	773	774	i	2	1	0		
Constant Roll Attitude Error	775	776	i	2	1	3	degrees	
Constant Pitch Attitude Error	777	778	i	2	1	3	degrees	
Constant Yaw Attitude Error	779	780	i	2	1	3	degrees	
Epoch Year for Orbit Vector	781	782	u	2	1	0		
Day of Epoch Year for Orbit Vector	783	784	u	2	1	0		
Epoch UTC Time of Day for Orbit Vector	785	788	u	4	1	0	milli-second	
Semi-major Axis	789	792	i	4	1	5	km	
Eccentricity	793	796	i	4	1	8		
Inclination	797	800	i	4	1	5	degrees	
Argument of Perigee	801	804	i	4	1	5	degrees	
Right Ascension of the Ascending Node	805	808	i	4	1	5	degrees	
Mean Anomaly	809	812	i	4	1	5	degrees	
Position Vector X Component	813	816	i	4	1	5	km	
Position Vector Y Component	817	820	i	4	1	5	km	
Position Vector Z Component	821	824	i	4	1	5	km	
Velocity Vector X-dot Component	825	828	i	4	1	8	km /sec	
Velocity Vector Y-dot Component	829	832	i	4	1	8	km /sec	
Velocity Vector Z-dot Component	833	836	i	4	1	8	km /sec	

Earth/Sun Distance Ratio	837	840	u	4	1	6		
<zero fill>	841	856	i	4	4	0		
ANALOG TELEMETRY CONVERSION								
Radiator Temperature Coefficient 1	857	858	i	2	1	2	K	
Radiator Temperature Coefficient 2	859	860	i	2	1	2	K/volt	
Radiator Temperature Coefficient 3	861	862	i	2	1	3	K/volt ²	
Radiator Temperature Coefficient 4	863	864	i	2	1	3	K/volt ³	
Radiator Temperature Coefficient 5	865	866	i	2	1	3	K/volt ⁴	
Radiator Temperature Coefficient 6	867	868	i	2	1	5	K/volt ⁵	
Base Plate Temperature Coefficient 1	869	870	i	2	1	2	K	
Base Plate Temperature Coefficient 2	871	872	i	2	1	2	K/volt	
Base Plate Temperature Coefficient 3	873	874	i	2	1	3	K/volt ²	
Base Plate Temperature Coefficient 4	875	876	i	2	1	3	K/volt ³	
Base Plate Temperature Coefficient 5	877	878	i	2	1	3	K/volt ⁴	
Base Plate Temperature Coefficient 6	879	880	i	2	1	5	K/volt ⁵	
Electronics Temperature Coefficient 1	881	882	i	2	1	2	K	
Electronics Temperature Coefficient 2	883	884	i	2	1	2	K/volt	
Electronics Temperature Coefficient 3	885	886	i	2	1	3	K/volt ²	
Electronics Temperature Coefficient 4	887	888	i	2	1	3	K/volt ³	
Electronics Temperature Coefficient 5	889	890	i	2	1	3	K/volt ⁴	
Electronics Temperature Coefficient 6	891	892	i	2	1	5	K/volt ⁵	
Patch Temperature Coefficient 1	893	894	i	2	1	2	K	
Patch Temperature Coefficient 2	895	896	i	2	1	2	K/volt	
Patch Temperature Coefficient 3	897	898	i	2	1	3	K/volt ²	
Patch Temperature Coefficient 4	899	900	i	2	1	3	K/volt ³	
Patch Temperature Coefficient 5	901	902	i	2	1	3	K/volt ⁴	
Patch Temperature Coefficient 6	903	904	i	2	1	5	K/volt ⁵	

Filter Housing Controller Current Coefficient 1	905	906	i	2	1	2	amps	
Filter Housing Controller Current Coefficient 2	907	908	i	2	1	2	amps/volt	
Filter Housing Controller Current Coefficient 3	909	910	i	2	1	3	amps/volt ²	
Filter Housing Controller Current Coefficient 4	911	912	i	2	1	3	amps/volt ³	
Filter Housing Controller Current Coefficient 5	913	914	i	2	1	3	amps/volt ⁴	
Filter Housing Controller Current Coefficient 6	915	916	i	2	1	5	amps/volt ⁵	
Scan Motor Temperature Coefficient 1	917	918	i	2	1	2	K	
Scan Motor Temperature Coefficient 2	919	920	i	2	1	2	K/volt	
Scan Motor Temperature Coefficient 3	921	922	i	2	1	3	K/volt ²	
Scan Motor Temperature Coefficient 4	923	924	i	2	1	3	K/volt ³	
Scan Motor Temperature Coefficient 5	925	926	i	2	1	3	K/volt ⁴	
Scan Motor Temperature Coefficient 6	927	928	i	2	1	5	K/volt ⁵	
Filter Wheel Motor Temperature Coefficient 1	929	930	i	2	1	2	K	
Filter Wheel Motor Temperature Coefficient 2	931	932	i	2	1	2	K/volt	
Filter Wheel Motor Temperature Coefficient 3	933	934	i	2	1	3	K/volt ²	
Filter Wheel Motor Temperature Coefficient 4	935	936	i	2	1	3	K/volt ³	
Filter Wheel Motor Temperature Coefficient 5	937	938	i	2	1	3	K/volt ⁴	
Filter Wheel Motor Temperature Coefficient 6	939	940	i	2	1	5	K/volt ⁵	
+5 VDC Monitor Coefficient 1	941	942	i	2	1	2		
+5 VDC Monitor Coefficient 2	943	944	i	2	1	2		
+5 VDC Monitor Coefficient 3	945	946	i	2	1	3		
+5 VDC Monitor Coefficient 4	947	948	i	2	1	3		

+5 VDC Monitor Coefficient 5	949	950	i	2	1	3		
+5 VDC Monitor Coefficient 6	951	952	i	2	1	5		
+10 VDC TLM/DC/DC Coefficient 1	953	954	i	2	1	2		
+10 VDC TLM/DC/DC Coefficient 2	955	956	i	2	1	2		
+10 VDC TLM/DC/DC Coefficient 3	957	958	i	2	1	3		
+10 VDC TLM/DC/DC Coefficient 4	959	960	i	2	1	3		
+10 VDC TLM/DC/DC Coefficient 5	961	962	i	2	1	3		
+10 VDC TLM/DC/DC Coefficient 6	963	964	i	2	1	5		
+7.5 VDC TLM/DC/DC Coefficient 1	965	966	i	2	1	2		
+7.5 VDC TLM/DC/DC Coefficient 2	967	968	i	2	1	2		
+7.5 VDC TLM/DC/DC Coefficient 3	969	970	i	2	1	3		
+7.5 VDC TLM/DC/DC Coefficient 4	971	972	i	2	1	3		
+7.5 VDC TLM/DC/DC Coefficient 5	973	974	i	2	1	3		
+7.5 VDC TLM/DC/DC Coefficient 6	975	976	i	2	1	5		
-7.5 VDC TLM/DC/DC Coefficient 1	977	978	i	2	1	2		
-7.5 VDC TLM/DC/DC Coefficient 2	979	980	i	2	1	2		
-7.5 VDC TLM/DC/DC Coefficient 3	981	982	i	2	1	3		
-7.5 VDC TLM/DC/DC Coefficient 4	983	984	i	2	1	3		
-7.5 VDC TLM/DC/DC Coefficient 5	985	986	i	2	1	3		
-7.5 VDC TLM/DC/DC Coefficient 6	987	988	i	2	1	5		
+15 VDC Monitor Coefficient 1	989	990	i	2	1	2		
+15 VDC Monitor Coefficient 2	991	992	i	2	1	2		
+15 VDC Monitor Coefficient 3	993	994	i	2	1	3		
+15 VDC Monitor Coefficient 4	995	996	i	2	1	3		
+15 VDC Monitor Coefficient 5	997	998	i	2	1	3		
+15 VDC Monitor Coefficient 6	999	1000	i	2	1	5		
-15 VDC Monitor Coefficient 1	1001	1002	i	2	1	2		
-15 VDC Monitor Coefficient 2	1003	1004	i	2	1	2		

-15 VDC Monitor Coefficient 3	1005	1006	i	2	1	3		
-15 VDC Monitor Coefficient 4	1007	1008	i	2	1	3		
-15 VDC Monitor Coefficient 5	1009	1010	i	2	1	3		
-15 VDC Monitor Coefficient 6	1011	1012	i	2	1	5		
Filter Wheel Motor Current Coefficient 1	1013	1014	i	2	1	2	amps	
Filter Wheel Motor Current Coefficient 2	1015	1016	i	2	1	2	amps/ volt	
Filter Wheel Motor Current Coefficient 3	1017	1018	i	2	1	3	amps/ volt ²	
Filter Wheel Motor Current Coefficient 4	1019	1020	i	2	1	3	amps/ volt ³	
Filter Wheel Motor Current Coefficient 5	1021	1022	i	2	1	3	amps/ volt ⁴	
Filter Wheel Motor Current Coefficient 6	1023	1024	i	2	1	5	amps/ volt ⁵	
Scan Motor Current Coefficient 1	1025	1026	i	2	1	2	amps	
Scan Motor Current Coefficient 3	1029	1030	i	2	1	3	amps/ volt ²	
Scan Motor Current Coefficient 4	1031	1032	i	2	1	3	amps/ volt ³	
Scan Motor Current Coefficient 5	1033	1034	i	2	1	3	amps/ volt ⁴	
Scan Motor Current Coefficient 6	1035	1036	i	2	1	5	amps/ volt ⁵	
Patch Controller Power Coefficient 1	1037	1038	i	2	1	2	watts	
Patch Controller Power Coefficient 2	1039	1040	i	2	1	2	watts/ volt	
Patch Controller Power Coefficient 3	1041	1042	i	2	1	3	watts/ volt ²	
Patch Controller Power Coefficient 4	1043	1044	i	2	1	3	watts/ volt ³	
Patch Controller Power Coefficient 5	1045	1046	i	2	1	3	watts/ volt ⁴	

Patch Controller Power Coefficient 6	1047	1048	i	2	1	5	watts/ volt ⁵	
FILLER								
<zero fill>	1049	4608	i	4	890	0		

8.3.1.5.2.2 HIRS/4 (Flown on NOAA-18 and NOAA-19 and Metop series, version 4, post-January 25, 2006)

This section describes the HIRS/4 Data Set Header Record format (version 4, post-January 25, 2006) and is documented in Table 8.3.1.5.2.2-1.

Table 8.3.1.5.2.2-1. Format of HIRS/4 Data Set Header Record (Flown on NOAA-18, NOAA-19, and Metop series, version 4, post-January 25, 2006)								
Field Name	Start Octet	End Octet	DT	Word Size	Number of Words	S F	Units	Notes
FILE IDENTIFICATION								
Data Set Creation Site ID CMS = Centre de Meteorologie Spatiale/France; DSS = Dundee Satellite Receiving Station/UK; NSS = National Environmental Satellite, Data and Information Service/USA; UKM = United Kingdom Meteorological Office/UK	1	3	c	3	1	0		
<ASCII blank = x20>	4	4	c	1	1	0		
NOAA Level 1b Format Version Number 1=TIROS-N, NOAA-6 through NOAA-14 2=NOAA-15, -16, -17 (pre-April 28, 2005) 3=all satellites post-April 28, 2005, 4=cloud mask flag (CLAVR-x)-Jan 25, 2006	5	6	u	2	1	0		
NOAA Level 1b Format Version Year (e.g., 1999)	7	8	u	2	1	0		
NOAA Level 1b Format Version Day of Year (e.g., 365)	9	10	u	2	1	0		

<Reserved for Logical Record Length> For Creation Site use only. Logical Record Length of NOAA Level 1b data set prior to processing.	11	12	u	2	1	0	octets	
<Reserved for Block Size> For Creation Site use only. Block Size of NOAA Level 1b data set prior to processing.	13	14	u	2	1	0	octets	
Count of Header Records in this Data Set	15	16	u	2	1	0		
<zero fill>	17	22	i	2	3	0		
Data Set Name	23	64	c	42	1	0		
Processing Block Identification	65	72	c	8	1	0		
NOAA Spacecraft Identification Code 2 = NOAA-16; 4 = NOAA-15; 6 = NOAA-17; 7 = NOAA-18; 8 = NOAA-19 11 = MetOp-B 12 = MetOp-A 13 = MetOp-3	73	74	u	2	1	0		
Instrument ID 301 = s/n H301 (NOAA-16); 302 = s/n H302 (NOAA-15); 303 = s/n H303 (NOAA-17); 305 = s/n H305 (NOAA-18); 308 = s/n H308 (NOAA-19) 306 = s/n H306 (MetOp-A) 307 = s/n H307 (MetOp-B)	75	76	u	2	1	0		
Data Type Code 5 = HIRS	77	78	u	2	1	0		
TIP Source Code (NOAA: values defined below) or <Zero fill> (MetOp) 0 = unused, GAC/HRPT/LAC data; 1 = GAC embedded AMSU and TIP; 2 = stored TIP; 3 = HRPT/LAC embedded AMSU and TIP; 4 = stored AIP	79	80	u	2	1	0		
Start of Data Set Day Count starting from 0 at 00h, 1 Jan 1950	81	84	u	4	1	0		
Start of Data Set Year (e.g., 1999)	85	86	u	2	1	0		

Start of Data Set Day of Year (e.g., 365)	87	88	u	2	1	0		
Start of Data Set UTC Time of Day	89	92	u	4	1	0	milli-second	
End of Data Set Day Count starting from 0 at 00h, 1 Jan 1950	93	96	u	4	1	0		
End of Data Set Year (e.g., 1999)	97	98	u	2	1	0		
End of Data Set Day of Year (e.g., 365)	99	100	u	2	1	0		
End of Data Set UTC Time of Day	101	104	u	4	1	0	milli-second	
Year of Last CPIDS Update (e.g., 1999)	105	106	u	2	1	0		
Day of Year of Last CPIDS Update (e.g., 365)	107	108	u	2	1	0		
Offset between Start of Scan and Center of First FOV	109	110	i	2	1	0	milli-second	
Instrument type HIRS/3 HIRS/4	111	116	c	6	1	0		
DATA SET QUALITY INDICATORS								
Instrument Status bits 31-16: <zero fill> bit 15: Instrument power (0=off; 1=on) bit 14: Electronics power (0=off; 1=on) bit 13: Filter motor power (0=off; 1=on) bit 12: Scan motor power (0=off; 1=on) bit 11: Cooler heater (0=off; 1=on) bit 10: Filter housing heater(0=off; 1=on) bit 9: Cooler door release (0=disabled; 1=enabled) bit 8: Cooler window heater (0=on; 1=off) bit 7: Go to NADIR position (0=no; 1=yes/initiated) bit 6: Calibration sequence (0=disabled; 1=enabled) bit 5: Cooler door closed (0=yes; 1=no) bit 4: Cooler door fully open (0=yes; 1=no) bit 3: Filter motor power level (0=normal; 1=high) bit 2: Patch temperature controller (0=off; 1=on) bits 1-0: <zero fill>	117	120	u	4	1	0		
<zero fill>	121	122	i	2	1	0		

Record Number of Status Change (if 0, none occurred)	123	124	u	2	1	0		
Second Instrument Status (if previous word is 0, no change)	125	128	u	4	1	0		
Count of Data Records in this Data Set	129	130	u	2	1	0		
Count of Calibrated, Earth Located Scan Lines in this Data Set	131	132	u	2	1	0		
Count of Missing Scan Lines	133	134	u	2	1	0		
Count of Data Gaps in this Data Set	135	136	u	2	1	0		
Count of Data Frames Without Frame Sync Word Errors (<i>NOAA</i>) or <Zero fill> (<i>MetOp</i>)	137	138	u	2	1	0		
Count of PACS Detected TIP Parity Errors(<i>NOAA</i>) or <Zero fill> (<i>MetOp</i>)	139	140	u	2	1	0		
Sum of All Auxiliary Sync Errors Detected in the Input Data (<i>NOAA</i>) or <Zero fill> (<i>MetOp</i>)	141	142	u	2	1	0		
Time Sequence Error (0 = none; otherwise the record number of the first occurrence)	143	144	u	2	1	0		
Time Sequence Error Code <i>These are bit flags taken from Scan Line Quality Flags Time Problem Code on data record reported in Time Sequence Error field above. If a bit is on (=1) then the statement is true.</i> bits 15 - 8: <zero fill> bit 7: time field is bad but can probably be inferred from the previous good time. bit 6: time field is bad and can't be inferred from the previous good time. bit 5: this record starts a sequence that is inconsistent with previous times (i.e., there is a time discontinuity). This may or may not be associated with a spacecraft clock update. bit 4: start of a sequence that apparently repeats scan times that have been previously accepted. bits 3 - 0: <zero fill>	145	146	u	2	1	0		

SOCC Clock Update Indicator (0 = none during this orbit; otherwise the record number of the first occurrence)	147	148	u	2	1	0		
Earth Location Error Indicator (0 = none during this orbit; otherwise the record number of the first occurrence)	149	150	u	2	1	0		
Earth Location Error Code <i>These are bit flags taken from Scan Line Quality Flags Earth Location Problem Code on data record reported in Earth Location Error Indicator field above. If a bit is on (=1) then the statement is true.</i> bits 15 - 8: <zero fill> bit 7: not earth located because of bad time; earth location fields zero filled. bit 6: earth location questionable because of questionable time code. (See time problem flags above.) bit 5: earth location questionable -- only marginal agreement with reasonableness check. bit 4: earth location questionable -- fails reasonableness check. bits 3-2: <zero fill> bit 1: not earth located because of in-plane maneuver (MetOp) or <zero fill> (NOAA) bit 0: not earth located because of out-of-plane maneuver (MetOp) or <zero fill> (NOAA)	151	152	u	2	1	0		
PACS Status Bit Field bits 15-3: <zero fill> bit 2: pseudo noise (0 = normal data; 1 = P/N data) bit 1: tape direction (0 = time decrementing) bit 0: data mode (0 = test data; 1 = flight data)	153	154	u	2	1	0		
PACS Data Source 0 = unused; 1 = Fairbanks, AK; 2 = Wallops Is, VA; 3 = SOCC; 4 = Svalbard, Norway; 5 = Monterey, CA	155	156	u	2	1	0		

<zero fill>	157	160	i	4	1	0		
<Reserved for the Ingestor>	161	168	c	8	1	0		
<Reserved for Decommutation>	169	176	c	8	1	0		
<zero fill>	177	186	i	2	5	0		
CALIBRATION								
Auto Calibration Indicators Bit Field bits 15-1: <zero fill> bit 0: auto calibration override switch for HIRS/4 (0=normal calibration sequence enabled during entire time period of this data set; 1=calibration sequence was disabled at some point during time period of this data set)	187	188	u	2	1	0		
Year of Most Recent Solar Channel Calibration (e.g., 1999)	189	190	u	2	1	0		
Day of Year of Most Recent Solar Channel Calibration (e.g., 365)	191	192	u	2	1	0		
Ch. 1 Mean Calibration Slope	193	196	i	4	1	6		
Ch. 1 Standard Deviation of Calibration Slope	197	200	i	4	1	6		
Ch. 1 B ₁	201	204	i	4	1	6		
Std Deviation of Linear Regression for B ₁ Ch 1	205	208	i	4	1	6		
Ch. 17 Mean Calibration Slope	209	212	i	4	1	6		
Ch. 17 Standard Deviation of Calibration Slope	213	216	i	4	1	6		
Ch. 17 B ₁	217	220	i	4	1	6		
Ch. 17 Std Deviation of Linear Regression for B ₁	221	224	i	4	1	6		
Ch. 2 Mean Calibration Slope	225	228	i	4	1	6		
Ch. 2 Standard Deviation of Calibration Slope	229	232	i	4	1	6		
Ch. 2 B ₁	233	236	i	4	1	6		

Ch. 2 Std Deviation of Linear Regression for B_1	237	240	i	4	1	6		
Ch. 3 Mean Calibration Slope	241	244	i	4	1	6		
Ch. 2 Standard Deviation of Calibration Slope	245	248	i	4	1	6		
Ch. 3 B_1	249	252	i	4	1	6		
Ch. 3 Std Deviation of Linear Regression for B_1	253	256	i	4	1	6		
Ch. 13 Mean Calibration Slope	257	260	i	4	1	6		
Ch. 13 Standard Deviation of Calibration Slope	261	264	i	4	1	6		
Ch. 13 B_1	265	268	i	4	1	6		
Ch. 13 Std Deviation of Linear Regression for B_1	269	272	i	4	1	6		
Ch. 4 Mean Calibration Slope	273	276	i	4	1	6		
Ch. 4 Standard Deviation of Calibration Slope	277	280	i	4	1	6		
Ch. 4 B_1	281	284	i	4	1	6		
Ch. 4 Std Deviation of Linear Regression for B_1	285	288	i	4	1	6		
Ch. 18 Mean Calibration Slope	289	292	i	4	1	6		
Ch. 18 Standard Deviation of Calibration Slope	293	296	i	4	1	6		
Ch. 18 B_1	297	300	i	4	1	6		
Ch. 18 Std Deviation of Linear Regression for B_1	301	304	i	4	1	6		
Ch. 11 Mean Calibration Slope	305	308	i	4	1	6		
Ch. 11 Standard Deviation of Calibration Slope	309	312	i	4	1	6		
Ch. 11 B_1	313	316	i	4	1	6		
Ch. 11 Std Deviation of Linear Regression for B_1	317	320	i	4	1	6		
Ch. 19 Mean Calibration Slope	321	324	i	4	1	6		

Ch. 19 Standard Deviation of Calibration Slope	325	328	i	4	1	6		
Ch. 19 B ₁	329	332	i	4	1	6		
Ch. 19 Std Deviation of Linear Regression for B ₁	333	336	i	4	1	6		
Ch. 7 Mean Calibration Slope	337	340	i	4	1	6		
Ch. 7 Standard Deviation of Calibration Slope	341	344	i	4	1	6		
Ch. 7 B ₁	345	348	i	4	1	6		
Ch. 7 Std Deviation of Linear Regression for B ₁	349	352	i	4	1	6		
Ch. 8 Mean Calibration Slope	353	356	i	4	1	6		
Ch. 8 Standard Deviation of Calibration Slope	357	360	i	4	1	6		
Ch. 8 B ₁	361	364	i	4	1	6		
Ch. 8 Std Deviation of Linear Regression for B ₁	365	368	i	4	1	6		
Ch. 20 Mean Calibration Slope	369	372	i	4	1	6		
Ch. 20 Standard Deviation of Calibration Slope	373	376	i	4	1	6		
Ch. 20 B ₁	377	380	i	4	1	6		
Ch. 20 Std Deviation of Linear Regression for B ₁	381	384	i	4	1	6		
Ch. 10 Mean Calibration Slope	385	388	i	4	1	6		
Ch. 10 Standard Deviation of Calibration Slope	389	392	i	4	1	6		
Ch. 10 B ₁	393	396	i	4	1	6		
Ch. 10 Std Deviation of Linear Regression for B ₁	397	400	i	4	1	6		
Ch. 14 Mean Calibration Slope	401	404	i	4	1	6		
Ch. 14 Standard Deviation of Calibration Slope	405	408	i	4	1	6		
Ch. 14 B ₁	409	412	i	4	1	6		

Ch. 14 Std Deviation of Linear Regression for B_1	413	416	i	4	1	6		
Ch. 6 Mean Calibration Slope	417	420	i	4	1	6		
Ch. 6 Standard Deviation of Calibration Slope	421	424	i	4	1	6		
Ch. 6 B_1	425	428	i	4	1	6		
Ch. 6 Std Deviation of Linear Regression for B_1	429	432	i	4	1	6		
Ch. 5 Mean Calibration Slope	433	436	i	4	1	6		
Ch. 5 Standard Deviation of Calibration Slope	437	440	i	4	1	6		
Ch. 5 B_1	441	444	i	4	1	6		
Ch. 5 Std Deviation of Linear Regression for B_1	445	448	i	4	1	6		
Ch. 15 Mean Calibration Slope	449	452	i	4	1	6		
Ch. 15 Standard Deviation of Calibration Slope	453	456	i	4	1	6		
Ch. 15 B_1	457	460	i	4	1	6		
Ch. 15 Std Deviation of Linear Regression for B_1	461	464	i	4	1	6		
Ch. 12 Mean Calibration Slope	465	468	i	4	1	6		
Ch. 12 Standard Deviation of Calibration Slope	469	472	i	4	1	6		
Ch. 12 B_1	473	476	i	4	1	6		
Ch. 12 Std Deviation of Linear Regression for B_1	477	480	i	4	1	6		
Ch. 16 Mean Calibration Slope	481	484	i	4	1	6		
Ch. 16 Standard Deviation of Calibration Slope	485	488	i	4	1	6		
Ch. 16 B_1	489	492	i	4	1	6		
Ch. 16 Std Deviation of Linear Regression for B_1	493	496	i	4	1	6		
Ch. 9 Mean Calibration Slope	497	500	i	4	1	6		

Ch. 9 Standard Deviation of Calibration Slope	501	504	i	4	1	6		
Ch. 9 B ₁	505	508	i	4	1	6		
Ch. 9 Std Deviation of Linear Regression for B ₁	509	512	i	4	1	6		
<zero fill>	513	520	i	4	2	0		
TEMPERATURE-RADIANCE CONVERSION								
Temperature-radiance Ch 1 Central Wavenumber	521	524	i	4	1	6	cm ⁻¹	
Temperature-radiance Ch 1 Constant 1	525	528	i	4	1	6		
Temperature-radiance Ch 1 Constant 2	529	532	i	4	1	6		
Temperature-radiance Ch 2 Central Wavenumber	533	536	i	4	1	6	cm ⁻¹	
Temperature-radiance Ch 2 Constant 1	537	540	i	4	1	6		
Temperature-radiance Ch 2 Constant 2	541	544	i	4	1	6		
Temperature-radiance Ch 3 Central Wavenumber	545	548	i	4	1	6	cm ⁻¹	
Temperature-radiance Ch 3 Constant 1	549	552	i	4	1	6		
Temperature-radiance Ch 3 Constant 2	553	556	i	4	1	6		
Temperature-radiance Ch 4 Central Wavenumber	557	560	i	4	1	6	cm ⁻¹	
Temperature-radiance Ch 4 Constant 1	561	564	i	4	1	6		
Temperature-radiance Ch 4 Constant 2	565	568	i	4	1	6		
Temperature-radiance Ch 5 Central Wavenumber	569	572	i	4	1	6	cm ⁻¹	
Temperature-radiance Ch 5 Constant 1	573	576	i	4	1	6		
Temperature-radiance Ch 5 Constant 2	577	580	i	4	1	6		
Temperature-radiance Ch 6 Central Wavenumber	581	584	i	4	1	6	cm ⁻¹	
Temperature-radiance Ch 6 Constant 1	585	588	i	4	1	6		
Temperature-radiance Ch 6 Constant 2	589	592	i	4	1	6		

Temperature-radiance Ch 7 Central Wavenumber	593	596	i	4	1	6	cm ⁻¹	
Temperature-radiance Ch 7 Constant 1	597	600	i	4	1	6		
Temperature-radiance Ch 7 Constant 2	601	604	i	4	1	6		
Temperature-radiance Ch 8 Central Wavenumber	605	608	i	4	1	6	cm ⁻¹	
Temperature-radiance Ch 8 Constant 1	609	612	i	4	1	6		
Temperature-radiance Ch 8 Constant 2	613	616	i	4	1	6		
Temperature-radiance Ch 9 Central Wavenumber	617	620	i	4	1	6	cm ⁻¹	
Temperature-radiance Ch 9 Constant 1	621	624	i	4	1	6		
Temperature-radiance Ch 9 Constant 2	625	628	i	4	1	6		
Temperature-radiance Ch 10 Central Wavenumber	629	632	i	4	1	6	cm ⁻¹	
Temperature-radiance Ch 10 Constant 1	633	636	i	4	1	6		
Temperature-radiance Ch 10 Constant 2	637	640	i	4	1	6		
Temperature-radiance Ch 11 Central Wavenumber	641	644	i	4	1	6	cm ⁻¹	
Temperature-radiance Ch 11 Constant 1	645	648	i	4	1	6		
Temperature-radiance Ch 11 Constant 2	649	652	i	4	1	6		
Temperature-radiance Ch 12 Central Wavenumber	653	656	i	4	1	6	cm ⁻¹	
Temperature-radiance Ch 12 Constant 1	657	660	i	4	1	6		
Temperature-radiance Ch 12 Constant 2	661	664	i	4	1	6		
Temperature-radiance Ch 13 Central Wavenumber	665	668	i	4	1	5	cm ⁻¹	
Temperature-radiance Ch 13 Constant 1	669	672	i	4	1	6		
Temperature-radiance Ch 13 Constant 2	673	676	i	4	1	6		
Temperature-radiance Ch 14 Central Wavenumber	677	680	i	4	1	5	cm ⁻¹	
Temperature-radiance Ch 14 Constant 1	681	684	i	4	1	6		
Temperature-radiance Ch 14 Constant 2	685	688	i	4	1	6		

Temperature-radiance Ch 15 Central Wavenumber	689	692	i	4	1	5	cm ⁻¹	
Temperature-radiance Ch 15 Constant 1	693	696	i	4	1	6		
Temperature-radiance Ch 15 Constant 2	697	700	i	4	1	6		
Temperature-radiance Ch 16 Central Wavenumber	701	704	i	4	1	5	cm ⁻¹	
Temperature-radiance Ch 16 Constant 1	705	708	i	4	1	6		
Temperature-radiance Ch 16 Constant 2	709	712	i	4	1	6		
Temperature-radiance Ch 17 Central Wavenumber	713	716	i	4	1	5	cm ⁻¹	
Temperature-radiance Ch 17 Constant 1	717	720	i	4	1	6		
Temperature-radiance Ch 17 Constant 2	721	724	i	4	1	6		
Temperature-radiance Ch 18 Central Wavenumber	725	728	i	4	1	5	cm ⁻¹	
Temperature-radiance Ch 18 Constant 1	729	732	i	4	1	6		
Temperature-radiance Ch 18 Constant 2	733	736	i	4	1	6		
Temperature-radiance Ch 19 Central Wavenumber	737	740	i	4	1	5	cm ⁻¹	
Temperature-radiance Ch 19 Constant 1	741	744	i	4	1	6		
Temperature-radiance Ch 19 Constant 2	745	748	i	4	1	6		
Albedo-radiance Ch 20 Solar Filtered Irradiance	749	750	i	2	1	6	Watts/ m ²	
Albedo-radiance Ch 20 Equivalent Filter Width	751	752	i	2	1	6	μm	
<zero fill>	753	760	i	4	2	0		
NAVIGATION								
Reference Ellipsoid Model ID The ellipsoid is a mathematically tractable approximation of the geoid, which is an equipotential surface at mean sea level. The maximum departure of the ellipsoid from the geoid is approximately ± 65 meters. (WGS-72 = World Geodetic Survey 1972) JGM3 =Joint Gravity Model 3	761	768	c	8	1	0		

Nadir Earth Location Tolerance	769	770	u	2	1	1	km	
Earth Location Bit Field bits 15 - 3: <zero fill> bit 2: dynamic attitude error correction (0=not performed; 1=performed) bit 1: reasonableness test active (0 = inactive; 1=performed) bit 0: attitude error correction (0 = not corrected; 1=performed)	771	772	u	2	1	0		
<zero fill>	773	774	i	2	1	0		
Constant Roll Attitude Error	775	776	i	2	1	3	degrees	
Constant Pitch Attitude Error	777	778	i	2	1	3	degrees	
Constant Yaw Attitude Error	779	780	i	2	1	3	degrees	
Epoch Year for Orbit Vector	781	782	u	2	1	0		
Day of Epoch Year for Orbit Vector	783	784	u	2	1	0		
Epoch UTC Time of Day for Orbit Vector	785	788	u	4	1	0	milli- second	
Semi-major Axis (at the orbit vector epoch time)	789	792	i	4	1	5	km	
Eccentricity (at the orbit vector epoch time)	793	796	i	4	1	8		
Inclination (at the orbit vector epoch time)	797	800	i	4	1	5	degrees	
Argument of Perigee(at the orbit vector epoch time)	801	804	i	4	1	5	degrees	
Right Ascension of the Ascending Node (<i>at the orbit vector epoch time</i>)	805	808	i	4	1	5	degrees	
Mean Anomaly (<i>at the orbit vector epoch time</i>)	809	812	i	4	1	5	degrees	
Position Vector X Component (<i>at the orbit vector epoch time</i>)	813	816	i	4	1	5	km	
Position Vector Y Component (<i>at the orbit vector epoch time</i>)	817	820	i	4	1	5	km	
Position Vector Z Component (<i>at the orbit vector epoch time</i>)	821	824	i	4	1	5	km	
Velocity Vector X-dot Component (<i>at the orbit vector epoch time</i>)	825	828	i	4	1	8	km/sec	

Velocity Vector Y-dot Component (<i>at the orbit vector epoch time</i>)	829	832	i	4	1	8	km/sec	
Velocity Vector Z-dot Component (<i>at the orbit vector epoch time</i>)	833	836	i	4	1	8	km/sec	
Earth/Sun Distance Ratio (at the orbit vector epoch time; relative to the mean distance of 1 AU)	837	840	u	4	1	6		
<zero fill>	841	856	i	4	4	0		
ANALOG TELEMETRY CONVERSION								
<i>Volts-to engineering units (e.g. temperature in Kelvin) conversion coefficients for the analog telemetry items.</i>								
Radiator Temperature Coefficient 1	857	860	i	4	1	2	K	1
Radiator Temperature Coefficient 2	861	864	i	4	1	2	K/volt	1
Radiator Temperature Coefficient 3	865	868	i	4	1	3	K/volt ²	1
Radiator Temperature Coefficient 4	869	872	i	4	1	3	K/volt ³	1
Radiator Temperature Coefficient 5	873	876	i	4	1	3	K/volt ⁴	1
Radiator Temperature Coefficient 6	877	880	i	4	1	5	K/volt ⁵	1
Base Plate Temperature Coefficient 1	881	884	i	4	1	2	K	1
Base Plate Temperature Coefficient 2	885	888	i	4	1	2	K/volt	1
Base Plate Temperature Coefficient 3	889	892	i	4	1	3	K/volt ²	1
Base Plate Temperature Coefficient 4	893	896	i	2	1	3	K/volt ³	1
Base Plate Temperature Coefficient 5	897	900	i	2	1	3	K/volt ⁴	1
Base Plate Temperature Coefficient 6	901	904	i	2	1	5	K/volt ⁵	1
Electronics Temperature Coefficient 1	905	908	i	4	1	2	K	1
Electronics Temperature Coefficient 2	909	912	i	4	1	2	K/volt	1
Electronics Temperature Coefficient 3	913	916	i	4	1	3	K/volt ²	1
Electronics Temperature Coefficient 4	917	920	i	4	1	3	K/volt ³	1
Electronics Temperature Coefficient 5	921	924	i	4	1	3	K/volt ⁴	1
Electronics Temperature Coefficient 6	925	928	i	4	1	5	K/volt ⁵	1
Patch Temperature Coefficient 1	929	932	i	4	1	2	K	1
Patch Temperature Coefficient 2	933	936	i	4	1	2	K/volt	1

Patch Temperature Coefficient 3	937	940	i	4	1	3	K/volt ²	1
Patch Temperature Coefficient 4	941	944	i	4	1	3	K/volt ³	1
Patch Temperature Coefficient 5	945	948	i	4	1	3	K/volt ⁴	1
Patch Temperature Coefficient 6	949	952	i	4	1	5	K/volt ⁵	1
Filter Housing Controller Current Coefficient 1	953	956	i	4	1	2	amps	1
Filter Housing Controller Current Coefficient 2	957	960	i	4	1	2	amps/volt	1
Filter Housing Controller Current Coefficient 3	961	964	i	4	1	3	amps/volt ²	1
Filter Housing Controller Current Coefficient 4	965	968	i	4	1	3	amps/volt ³	1
Filter Housing Controller Current Coefficient 5	969	972	i	4	1	3	amps/volt ⁴	1
Filter Housing Controller Current Coefficient 6	973	976	i	4	1	5	amps/volt ⁵	1
Scan Motor Temperature Coefficient 1	977	980	i	4	1	2	K	1
Scan Motor Temperature Coefficient 2	981	984	i	4	1	2	K/volt	1
Scan Motor Temperature Coefficient 3	985	988	i	4	1	3	K/volt ²	1
Scan Motor Temperature Coefficient 4	989	992	i	4	1	3	K/volt ³	1
Scan Motor Temperature Coefficient 5	993	996	i	4	1	3	K/volt ⁴	1
Scan Motor Temperature Coefficient 6	997	1000	i	4	1	5	K/volt ⁵	1
Filter Wheel Motor Temperature Coefficient 1	1001	1004	i	4	1	2	K	1
Filter Wheel Motor Temperature Coefficient 2	1005	1008	i	4	1	2	K/volt	1
Filter Wheel Motor Temperature Coefficient 3	1009	1012	i	4	1	3	K/volt ²	1
Filter Wheel Motor Temperature Coefficient 4	1013	1016	i	4	1	3	K/volt ³	1
Filter Wheel Motor Temperature Coefficient 5	1017	1020	i	4	1	3	K/volt ⁴	1
Filter Wheel Motor Temperature Coefficient 6	1021	1024	i	4	1	5	K/volt ⁵	1

+5 VDC Monitor Coefficient 1	1025	1028	i	4	1	2		1
+5 VDC Monitor Coefficient 2	1029	1032	i	4	1	2		1
+5 VDC Monitor Coefficient 3	1033	1036	i	4	1	3		1
+5 VDC Monitor Coefficient 4	1037	1040	i	4	1	3		1
+5 VDC Monitor Coefficient 5	1041	1044	i	4	1	3		1
+5 VDC Monitor Coefficient 6	1045	1048	i	4	1	5		1
+10 VDC TLM/DC/DC Coefficient 1	1049	1052	i	4	1	2		1
+10 VDC TLM/DC/DC Coefficient 2	1053	1056	i	4	1	2		1
+10 VDC TLM/DC/DC Coefficient 3	1057	1060	i	4	1	3		1
+10 VDC TLM/DC/DC Coefficient 4	1061	1064	i	4	1	3		1
+10 VDC TLM/DC/DC Coefficient 5	1065	1068	i	4	1	3		1
+10 VDC TLM/DC/DC Coefficient 6	1069	1072	i	4	1	5		1
+7.5 VDC TLM/DC/DC Coefficient 1	1073	1076	i	4	1	2		1
+7.5 VDC TLM/DC/DC Coefficient 2	1077	1080	i	4	1	2		1
+7.5 VDC TLM/DC/DC Coefficient 3	1081	1084	i	4	1	3		1
+7.5 VDC TLM/DC/DC Coefficient 4	1085	1088	i	4	1	3		1
+7.5 VDC TLM/DC/DC Coefficient 5	1089	1092	i	4	1	3		1
+7.5 VDC TLM/DC/DC Coefficient 6	1093	1096	i	4	1	5		1
-7.5 VDC TLM/DC/DC Coefficient 1	1097	1100	i	4	1	2		1
-7.5 VDC TLM/DC/DC Coefficient 2	1101	1104	i	4	1	2		1
-7.5 VDC TLM/DC/DC Coefficient 3	1105	1108	i	4	1	3		1
-7.5 VDC TLM/DC/DC Coefficient 4	1109	1112	i	4	1	3		1
-7.5 VDC TLM/DC/DC Coefficient 5	1113	1116	i	4	1	3		1
-7.5 VDC TLM/DC/DC Coefficient 6	1117	1120	i	4	1	5		1
+15 VDC Monitor Coefficient 1	1121	1124	i	4	1	2		1
+15 VDC Monitor Coefficient 2	1125	1128	i	4	1	2		1
+15 VDC Monitor Coefficient 3	1129	1132	i	4	1	3		1
+15 VDC Monitor Coefficient 4	1133	1136	i	4	1	3		1

+15 VDC Monitor Coefficient 5	1137	1140	i	4	1	3		1
+15 VDC Monitor Coefficient 6	1141	1144	i	4	1	5		1
-15 VDC Monitor Coefficient 1	1145	1148	i	4	1	2		1
-15 VDC Monitor Coefficient 2	1149	1152	i	4	1	2		1
-15 VDC Monitor Coefficient 3	1153	1156	i	4	1	3		1
-15 VDC Monitor Coefficient 4	1157	1160	i	4	1	3		1
-15 VDC Monitor Coefficient 5	1161	1164	i	4	1	3		1
-15 VDC Monitor Coefficient 6	1165	1168	i	4	1	5		
Filter Wheel Motor Current Coefficient 1	1169	1172	i	4	1	2	amps	1
Filter Wheel Motor Current Coefficient 2	1173	1176	i	4	1	2	amps/ volt	1
Filter Wheel Motor Current Coefficient 3	1177	1180	i	4	1	3	amps/ volt ²	1
Filter Wheel Motor Current Coefficient 4	1181	1184	i	4	1	3	amps/ volt ³	1
Filter Wheel Motor Current Coefficient 5	1185	1188	i	4	1	3	amps/ volt ⁴	1
Filter Wheel Motor Current Coefficient 6	1189	1192	i	4	1	5	amps/ volt ⁵	1
Scan Motor Current Coefficient 1	1193	1196	i	4	1	2	amps	1
Scan Motor Current Coefficient 2	1197	1200	i	4	1	2	amps/ volt	1
Scan Motor Current Coefficient 3	1201	1204	i	4	1	3	amps/ volt ²	1
Scan Motor Current Coefficient 4	1205	1208	i	4	1	3	amps/ volt ³	1
Scan Motor Current Coefficient 5	1209	1212	i	4	1	3	amps/ volt ⁴	1
Scan Motor Current Coefficient 6	1213	1216	i	4	1	5	amps/ volt ⁵	1
Patch Controller Power Coefficient 1	1217	1220	i	4	1	2	watts	1
Patch Controller Power Coefficient 2	1221	1224	i	4	1	2	watts/ volt	1

Patch Controller Power Coefficient 3	1225	1228	i	4	1	3	watts/ volt ²	1
Patch Controller Power Coefficient 4	1229	1232	i	4	1	3	watts/ volt ³	1
Patch Controller Power Coefficient 5	1233	1236	i	4	1	3	watts/ volt ⁴	1
Patch Controller Power Coefficient 6	1237	1240	i	4	1	5	watts/ volt ⁵	1
Digital A Telemetry Conversion								
Internal Warm Target, Temperature Sensor #1, Coefficient 1	1241	1244	i	4	1	6	K	
Internal Warm Target, Temperature Sensor #1, Coefficient 2	1245	1248	i	4	1	9	K/ count	
Internal Warm Target, Temperature Sensor #1, Coefficient 3	1249	1252	i	4	1	14	K/ count ²	
Internal Warm Target, Temperature Sensor #1, Coefficient 4	1253	1256	i	4	1	17	K/ count ³	
Internal Warm Target, Temperature Sensor #1, Coefficient 5	1257	1260	i	4	1	21	K/ count ⁴	
Internal Warm Target, Temperature Sensor #1, Coefficient 6	1261	1264	i	4	1	25	K/ count ⁵	
Internal Warm Target, Temperature Sensor #2, Coefficient 1	1265	1268	i	4	1	6	K	
Internal Warm Target, Temperature Sensor #2, Coefficient 2	1269	1272	i	4	1	9	K/ count	
Internal Warm Target, Temperature Sensor #2, Coefficient 3	1273	1276	i	4	1	14	K/ count ²	
Internal Warm Target, Temperature Sensor #2, Coefficient 4	1277	1280	i	4	1	17	K/ count ³	
Internal Warm Target, Temperature Sensor #2, Coefficient 5	1281	1284	i	4	1	21	K/ count ⁴	
Internal Warm Target, Temperature Sensor #2, Coefficient 6	1285	1288	i	4	1	25	K/ count ⁵	
Internal Warm Target, Temperature Sensor #3, Coefficient 1	1289	1292	i	4	1	6	K	

Internal Warm Target, Temperature Sensor #3, Coefficient 2	1293	1296	i	4	1	9	K/ count	
Internal Warm Target, Temperature Sensor #3, Coefficient 3	1297	1300	i	4	1	14	K/ count ²	
Internal Warm Target, Temperature Sensor #3, Coefficient 4	1301	1304	i	4	1	17	K count ³	
Internal Warm Target, Temperature Sensor #3, Coefficient 5	1305	1308	i	4	1	21	K/ count ⁴	
Internal Warm Target, Temperature Sensor #3, Coefficient 6	1309	1312	i	4	1	25	K/ count ⁵	
Internal Warm Target, Temperature Sensor #4, Coefficient 1	1313	1316	i	4	1	6	K	
Internal Warm Target, Temperature Sensor #4, Coefficient 2	1317	1320	i	4	1	9	K/ count	
Internal Warm Target, Temperature Sensor #4, Coefficient 3	1320	1324	i	4	1	14	K/ count ²	
Internal Warm Target, Temperature Sensor #4, Coefficient 4	1325	1328	i	4	1	17	K/ count ³	
Internal Warm Target, Temperature Sensor #4, Coefficient 5	1329	1332	i	4	1	21	K/ count ⁴	
Internal Warm Target, Temperature Sensor #4, Coefficient 6	1333	1336	i	4	1	25	K/ count ⁵	
Internal Warm Target, Temperature Sensor #5, Coefficient 1 (NOAA-N, N' and MetOp) or <zero fill> (NOAA KLM)	1337	1340	i	4	1	6	K	
Internal Warm Target, Temperature Sensor #5, Coefficient 2 (NOAA-N, N' and MetOp) or <zero fill> (NOAA KLM)	1341	1344	i	4	1	9	K/ count	
Internal Warm Target, Temperature Sensor #5, Coefficient 3 (NOAA-N, N' and MetOp) or <zero fill> (NOAA KLM)	1345	1348	i	4	1	14	K/ count ²	
Internal Warm Target, Temperature Sensor #5, Coefficient 4 (NOAA-N, N' and MetOp) or <zero fill> (NOAA KLM)	1349	1352	i	4	1	17	K/ count ³	
Internal Warm Target, Temperature Sensor #5, Coefficient 5 (NOAA-N, N' and MetOp) or <zero fill> (NOAA KLM)	1353	1356	i	4	1	21	K/ count ⁴	

Internal Warm Target, Temperature Sensor #5, Coefficient 6 (NOAA-N, N'and MetOp) or <zero fill> (NOAA KLM)	1357	1360	i	4	1	25	K/ count ⁵	
Internal Cold Target, Temperature Sensor #1, Coefficient 1	1361	1364	I	4	1	6	K	
Internal Cold Target, Temperature Sensor #1, Coefficient 2	1365	1368	i	4	1	9	K/ count	
Internal Cold Target, Temperature Sensor #1, Coefficient 3	1369	1372	i	4	1	14	K/ count ²	
Internal Cold Target, Temperature Sensor #1, Coefficient 4	1373	1376	i	4	1	17	K/ count ³	
Internal Cold Target, Temperature Sensor #1, Coefficient 5	1377	1380	i	4	1	21	K/ count ⁴	
Internal Cold Target, Temperature Sensor #1, Coefficient 6	1381	1384	i	4	1	25	K/ count ⁵	
Internal Cold Target, Temperature Sensor #2 , Coefficient 1 (NOAA KLM) or <zero fill> (NOAA-N, N'and MetOp)	1385	1388	I	4	1	6	K	
Internal Cold Target, Temperature Sensor #2, Coefficient 2 (NOAA KLM) or <zero fill> (NOAA-N, N'and MetOp)	1389	1392	i	4	1	9	K/ count	
Internal Cold Target, Temperature Sensor #2, Coefficient 3 (NOAA KLM) or <zero fill> (NOAA-N, N'and MetOp)	1393	1396	i	4	1	14	K/ count ²	
Internal Cold Target, Temperature Sensor #2, Coefficient 4 (NOAA KLM) or <zero fill> (NOAA-N, N'and MetOp)	1397	1400	i	4	1	17	K/ count ³	
Internal Cold Target, Temperature Sensor #2, Coefficient 5 (NOAA KLM) or <zero fill> (NOAA-N, N'and MetOp)	1401	1404	i	4	1	21	K/ count ⁴	
Internal Cold Target, Temperature Sensor #2, Coefficient 6 (NOAA KLM) or <zero fill> (NOAA-N, N'and MetOp)	1405	1408	i	4	1	25	K/ count ⁵	
Internal Cold Target, Temperature Sensor #3 , Coefficient 1 (NOAA KLM) or <zero fill> (NOAA-N, N'and MetOp)	1409	1412	I	4	1	6	K	
Internal Cold Target, Temperature Sensor #3, Coefficient 2 (NOAA KLM) or <zero fill> (NOAA-N, N'and MetOp)	1413	1416	i	4	1	9	K/ count	

Internal Cold Target, Temperature Sensor #3, Coefficient 3 (NOAA KLM) or <zero fill> (NOAA-N, N'and MetOp)	1417	1420	i	4	1	14	K/ count ²	
Internal Cold Target, Temperature Sensor #3, Coefficient 4 (NOAA KLM) or <zero fill> (NOAA-N, N'and MetOp)	1421	1424	i	4	1	17	K/ count ³	
Internal Cold Target, Temperature Sensor #3, Coefficient 5 (NOAA KLM) or <zero fill> (NOAA-N, N'and MetOp)	1425	1428	i	4	1	21	K/ count ⁴	
Internal Cold Target, Temperature Sensor #3, Coefficient 6 (NOAA KLM) or <zero fill> (NOAA-N, N'and MetOp) N'and MetOp)	1429	1432	i	4	1	25	K/ count ⁵	
Internal Cold Target, Temperature Sensor #4 , Coefficient 1 (NOAA KLM) or <zero fill> (NOAA-N, N'and MetOp)	1433	1436	I	4	1	6	K	
Internal Cold Target, Temperature Sensor #4, Coefficient 2 (NOAA KLM) or <zero fill> (NOAA-N, N'and MetOp)	1437	1440	i	4	1	9	K/ count	
Internal Cold Target, Temperature Sensor #4, Coefficient 3 (NOAA KLM) or <zero fill> (NOAA-N, N'and MetOp)	1441	1444	i	4	1	14	K/ count ²	
Internal Cold Target, Temperature Sensor #4, Coefficient 4 (NOAA KLM) or <zero fill> (NOAA-N, N'and MetOp)	1445	1448	i	4	1	17	K/ count ³	
Internal Cold Target, Temperature Sensor #4, Coefficient 5 (NOAA KLM) or <zero fill> (NOAA-N, N'and MetOp)	1449	1452	i	4	1	21	K/ count ⁴	
Internal Cold Target, Temperature Sensor #4, Coefficient 6 (NOAA KLM) or <zero fill> (NOAA-N, N'and MetOp)	1453	1456	i	4	1	25	K/ count ⁵	
Tertiary Telescope Temperature Sensor Coefficient 1 (NOAA-N, N'and MetOp) or <zero fill> (NOAA KLM)	1457	1460	i	4	1	6	K	
Tertiary Telescope Temperature Sensor Coefficient 2 (NOAA-N, N'and MetOp) or <zero fill> (NOAA KLM)	1461	1464	i	4	1	9	K/ count	
Tertiary Telescope Temperature Sensor Coefficient 3 (NOAA-N, N'and MetOp) or <zero fill> (NOAA KLM)	1465	1468	i	4	1	14	K/ count ²	

Tertiary Telescope Temperature Sensor Coefficient 4 (NOAA-N, N'and MetOp) or <zero fill> (NOAA KLM)	1469	1472	i	4	1	17	K/ count ³	
Tertiary Telescope Temperature Sensor Coefficient 5 (NOAA-N, N'and MetOp) or <zero fill> (NOAA KLM)	1473	1476	i	4	1	21	K/ count ⁴	
Tertiary Telescope Temperature Sensor Coefficient 6 (NOAA-N, N'and MetOp) or <zero fill> (NOAA KLM)	1477	1480	i	4	1	25	K/ count ⁵	
Filter Wheel Housing, Temperature Sensor #1, Coefficient 1	1481	1484	i	4	1	6	K	
Filter Wheel Housing, Temperature Sensor #1, Coefficient 2	1485	1488	i	4	1	9	K/ count	
Filter Wheel Housing, Temperature Sensor #1, Coefficient 3	1489	1492	i	4	1	14	K/ count ²	
Filter Wheel Housing, Temperature Sensor #1, Coefficient 4	1495	1496	i	4	1	17	K/ count ³	
Filter Wheel Housing, Temperature Sensor #1, Coefficient 5	1497	1500	i	4	1	21	K/ count ⁴	
Filter Wheel Housing, Temperature Sensor #1, Coefficient 6	1501	1504	i	4	1	25	K/ count ⁵	
Filter Wheel Housing, Temperature Sensor #2, Coefficient 1	1505	1508	i	4	1	6	K	
Filter Wheel Housing, Temperature Sensor #2, Coefficient 2	1509	1512	i	4	1	9	K/ count	
Filter Wheel Housing, Temperature Sensor #2, Coefficient 3	1513	1516	i	4	1	14	K/ count ²	
Filter Wheel Housing, Temperature Sensor #2, Coefficient 4	1517	1520	i	4	1	17	K/ count ³	
Filter Wheel Housing, Temperature Sensor #2, Coefficient 5	1521	1524	i	4	1	21	K/ count ⁴	
Filter Wheel Housing, Temperature Sensor #2, Coefficient 6	1525	1528	i	4	1	25	K/ count ⁵	
Filter Wheel Housing, Temperature Sensor #3, Coefficient 1	1529	1532	i	4	1	6	K	
Filter Wheel Housing, Temperature Sensor #3, Coefficient 2	1533	1536	i	4	1	9	K/ count	

Filter Wheel Housing, Temperature Sensor #3, Coefficient 3	1537	1540	i	4	1	14	K/ count ²	
Filter Wheel Housing, Temperature Sensor #3, Coefficient 4	1541	1544	i	4	1	17	K/ count ³	
Filter Wheel Housing, Temperature Sensor #3, Coefficient 5	1545	1548	i	4	1	21	K/ count ⁴	
Filter Wheel Housing, Temperature Sensor #3, Coefficient 6	1549	1552	i	4	1	25	K/ count ⁵	
Filter Wheel Housing, Temperature Sensor #4, Coefficient 1	1553	1556	i	4	1	6	K	
Filter Wheel Housing, Temperature Sensor #4, Coefficient 2	1557	1560	i	4	1	9	K/ count	
Filter Wheel Housing, Temperature Sensor #4, Coefficient 3	1561	1564	i	4	1	14	K/ count ²	
Filter Wheel Housing, Temperature Sensor #4, Coefficient 4	1565	1568	i	4	1	17	K/ count ³	
Filter Wheel Housing, Temperature Sensor #4, Coefficient 5	1569	1572	i	4	1	21	K/ count ⁴	
Filter Wheel Housing, Temperature Sensor #4, Coefficient 6	1573	1576	i	4	1	25	K/ count ⁵	
Patch Temperature (Expanded Scale) Coefficient 1	1577	1580	i	4	1	6	K	
Patch Temperature (Expanded Scale) Coefficient 2	1581	1584	i	4	1	9	K/ count	
Patch Temperature (Expanded Scale) Coefficient 3	1585	1588	i	4	1	14	K/ count ²	
Patch Temperature (Expanded Scale) Coefficient 4	1589	1592	i	4	1	17	K/ count ³	
Patch Temperature (Expanded Scale) Coefficient 5	1593	1596	i	4	1	21	K/ count ⁴	
Patch Temperature (Expanded Scale) Coefficient 6	1597	1600	i	4	1	25	K/ count ⁵	
First Stage Radiator Temperature Sensor Coefficient 1	1601	1604	i	4	1	6	K	
First Stage Radiator Temperature Sensor Coefficient 2	1605	1608	i	4	1	9	K/ count	

First Stage Radiator Temperature Sensor Coefficient 3	1609	1612	i	4	1	14	K/ count ²	
First Stage Radiator Temperature Sensor Coefficient 4	1613	1616	i	4	1	17	K/ count ³	
First Stage Radiator Temperature Sensor Coefficient 5	1617	1620	i	4	1	21	K/ count ⁴	
First Stage Radiator Temperature Sensor Coefficient 6	1621	1624	i	4	1	25	K/ count ⁵	
Scan Mirror Temperature Coefficient 1	1625	1628	i	4	1	6	K	
Scan Mirror Temperature Coefficient 2	1629	1632	i	4	1	9	K/ count	
Scan Mirror Temperature Coefficient 3	1633	1636	i	4	1	14	K/ count ²	
Scan Mirror Temperature Coefficient 4	1637	1640	i	4	1	17	K/ count ³	
Scan Mirror Temperature Coefficient 5	1641	1644	i	4	1	21	K/ count ⁴	
Scan Mirror Temperature Coefficient 6	1645	1648	i	4	1	25	K/ count ⁵	
Primary Telescope Temperature Coefficient 1	1649	1652	i	4	1	6	K	
Primary Telescope Temperature Coefficient 2	1653	1656	i	4	1	9	K/ count	
Primary Telescope Temperature Coefficient 3	1657	1660	i	4	1	14	K/ count ²	
Primary Telescope Temperature Coefficient 4	1661	1664	i	4	1	17	K/ count ³	
Primary Telescope Temperature Coefficient 5	1665	1668	i	4	1	21	K/ count ⁴	
Primary Telescope Temperature Coefficient 6	1669	1672	i	4	1	25	K/ count ⁵	
Secondary Telescope Temperature Coefficient 1	1673	1676	i	4	1	6	K	
Secondary Telescope Temperature Coefficient 2	1677	1680	i	4	1	9	K/ count	

Secondary Telescope Temperature Coefficient 3	1681	1684	i	4	1	14	K/ count ²	
Secondary Telescope Temperature Coefficient 4	1685	1688	i	4	1	17	K/ count ³	
Secondary Telescope Temperature Coefficient 5	1689	1692	i	4	1	21	K/ count ⁴	
Secondary Telescope Temperature Coefficient 6	1693	1696	i	4	1	25	K/ count ⁵	
Baseplate Temperature Coefficient 1	1697	1700	i	4	1	6	K	
Baseplate Temperature Coefficient 2	1701	1704	i	4	1	9	K/ count	
Baseplate Temperature Coefficient 3	1705	1708	i	4	1	14	K/ count ²	
Baseplate Temperature Coefficient 4	1709	1712	i	4	1	17	K/ count ³	
Baseplate Temperature Coefficient 5	1713	1716	i	4	1	21	K/ count ⁴	
Baseplate Temperature Coefficient 6	1717	1720	i	4	1	25	K/ count ⁵	
Electronics Temperature Coefficient 1	1721	1724	i	4	1	6	K	
Electronics Temperature Coefficient 2	1725	1728	i	4	1	9	K/ count	
Electronics Temperature Coefficient 3	1729	1732	i	4	1	14	K/ count ²	
Electronics Temperature Coefficient 4	1733	1736	i	4	1	17	K/ count ³	
Electronics Temperature Coefficient 5	1737	1740	i	4	1	21	K/ count ⁴	
Electronics Temperature Coefficient 6	1741	1744	i	4	1	25	K/ count ⁵	
Patch Temperature Full Range Coefficient 1	1745	1748	i	4	1	6	K	
Patch Temperature Full Range Coefficient 2	1749	1752	i	4	1	9	K/ count	
Patch Temperature Full Range Coefficient 3	1753	1756	i	4	1	14	K/ count ²	

Patch Temperature Full Range Coefficient 4	1757	1760	i	4	1	17	K/ count ³	
Patch Temperature Full Range Coefficient 5	1761	1764	i	4	1	21	K/ count ⁴	
Patch Temperature Full Range Coefficient 6	1765	1768	i	4	1	25	K/ count ⁵	
Scan Motor Temperature Coefficient 1	1769	1772	i	4	1	6	K	
Scan Motor Temperature Coefficient 2	1773	1776	i	4	1	9	K/ count	
Scan Motor Temperature Coefficient 3	1777	1780	i	4	1	14	K/ count ²	
Scan Motor Temperature Coefficient 4	1781	1784	i	4	1	17	K/ count ³	
Scan Motor Temperature Coefficient 5	1785	1788	i	4	1	21	K/ count ⁴	
Scan Motor Temperature Coefficient 6	1789	1792	i	4	1	25	K/ count ⁵	
Filter Wheel Motor Temperature Coefficient 1	1793	1796	i	4	1	6	K	
Filter Wheel Motor Temperature Coefficient 2	1797	1800	i	4	1	9	K/ count	
Filter Wheel Motor Temperature Coefficient 3	1801	1804	i	4	1	14	K/ count ²	
Filter Wheel Motor Temperature Coefficient 4	1805	1808	i	4	1	17	K/ count ³	
Filter Wheel Motor Temperature Coefficient 5	1809	1812	i	4	1	21	K/ count ⁴	
Filter Wheel Motor Temperature Coefficient 6	1813	1816	i	4	1	25	K/ count ⁵	
Cooler Housing Temperature Coefficient 1	1817	1820	i	4	1	6	K	
Cooler Housing Temperature Coefficient 2	1821	1824	i	4	1	9	K/ count	
Cooler Housing Temperature Coefficient 3	1825	1828	i	4	1	14	K/ count ²	
Cooler Housing Temperature Coefficient 4	1829	1832	i	4	1	17	K/ count ³	

Cooler Housing Temperature Coefficient 5	1833	1836	i	4	1	21	K/ count ⁴	
Cooler Housing Temperature Coefficient 6	1837	1840	i	4	1	25	K/ count ⁵	
Filter Wheel Housing Heater Current Conversion Constant	1841	1844	i	4	1	9	amps/ count	
Electronic Calibration Digital to Analog Converter Conversion Constant	1845	1848	i	4	1	1		
Patch Control Power Conversion Constant	1849	1852	i	4	1	17	watts/ count ²	
Scan Motor Current Conversion Constant	1853	1856	i	4	1	9	amps/ count ³	
Filter Motor Current Conversion Constant	1857	1860	i	4	1	9	amps/ count	
+15 VDC Conversion Constant	1861	1864	i	4	1	8	volts/ count	
-15 VDC Conversion Constant	1865	1868	i	4	1	8	volts/ count	
+7.5 VDC Conversion Constant	1869	1872	i	4	1	8	volts/ count	
-7.5 VDC Conversion Constant	1873	1876	i	4	1	8	volts/ count	
+10 VDC Conversion Constant	1877	1880	i	4	1	8	volts/ count	
+5 VDC Conversion Constant	1881	1884	i	4	1	8	volts/ count	
Lunar Contamination								
Count of Space View Scans Containing Lunar Contaminated Space Views (<i>Also, see bits 1 and 0 of "Scan Line Quality Flags [Calibration Problem Code]" field in data record.</i>) -1=the detection algorithm for lunar contamination is turned off 0=the detection algorithm is turned on: no lunar-contaminated space view scans were found >0=the detection algorithm is turned on: the value in this field represents the number of lunar-contaminated space view scans	1885	1886	i	2	1	0		

Lunar Angle Threshold <i>Any space view whose lunar angle -- see "Lunar Angle" field in data record -- is less than this value is flagged as being "lunar contaminated" and is not used in the calibration.</i>	1887	1888	i	2	1	2	degree	
<Spare> (content undefined)	1889	1890	i	4	20	0		
MetOp Maneuvers Identification The fields in this section are MetOp specific. For NOAA originated HIRS data, these fields are spare (zero fill).								
Start of Maneuver Year (four digits, e.g. 2000)	1969	1970	u	2	1	0		
Start of Maneuver Day (three digits, e.g. 365)	1971	1972	u	2	1	0		
Start of Maneuver UTC Time of Day	1973	1976	u	4	1	0		
End of Maneuver Year (four digits, e.g. 2000)	1977	1978	u	2	1	0		
End of Maneuver Day (three digits, e.g. 365)	1979	1980	u	2	1	0		
End of Maneuver UTC Time of Day	1981	1984	u	4	1	0		
<zero fill>	1985	1996	u	4	3	1		
Spacecraft Mass Word 1: Mass before Maneuver Word 2: Mass after Maneuver	1997	2004	u	4	2	3	kg	
Filler								
<zero fill>	1969	4608	i	2	1320	0		
Notes: 1) 1 count = 0.02 volts								

8.3.1.5.3 Data Records

8.3.1.5.3.1 NOAA KLM (Version 2, pre-April 28, 2005)

The HIRS/3 Data Record format (Version 2, pre-April 28, 2005) is documented in Table 8.3.1.5.3.1-1.

Table 8.3.1.5.3.1-1. Format of HIRS/3 Data Record (Version 2, pre-April 28, 2005)
--

Field Name	Start Octet	End Octet	DT	Word Size	Number of Words	S F	Units	Notes
SCAN LINE INFORMATION								
Scan Line Number (cumulative, starting with 1)	1	2	u	2	1	0		
Scan Line Year (e.g., 1999)	3	4	u	2	1	0		
Scan Line Day of Year (e.g., 365)	5	6	u	2	1	0		
Satellite Clock Drift Delta	7	8	i	2	1	0	milli-seconds	
Scan Line UTC Time of Day	9	12	u	4	1	0	milli-seconds	
Scan Line Bit Field bit 15: 0 = northbound data; 1 = southbound data bit 14: 1 = scan time corrected for clock drift bits 13-0: <zero fill>	13	14	u	2	1	0		
Major Frame Count (cumulative, starting with 1)	15	16	u	2	1	0		
Scan Position Number in 32 Second Cycle	17	18	u	2	1	0		
Scan Type Code 0 = earth view; 1 = space view; 2 = cold BB view; 3 = main BB view	19	20	u	2	1	0		
<zero fill>	21	28	i	4	2	0		
QUALITY INDICATORS								
Quality Indicator Bit Field If a bit is on (=1) then the statement is true. bit 31: do not use scan for product generation bit 30: time sequence error detected within this scan (see below) bit 29: data gap precedes this scan bit 28: insufficient data for calibration anomaly detected (see below) bit 27: earth location data not available	29	32	u	4	1	0		

(see below) bit 26: first good time following a clock update (nominally 0) bit 25: instrument status changed with this scan bits 24 - 0: <zero fill>								
<p>Scan Line Quality Flags If a bit is on (=1) then the statement is true.</p> <p><i>Time Problem Code</i> (All bits off implies the scan time is as expected.) bits 31-24: <zero fill> bit 23: time field is bad but can probably be inferred from the previous good time. bit 22: time field is bad and can't be inferred from the previous good time. bit 21: this record starts a sequence that is inconsistent with previous times (i.e., there is a time discontinuity). This may or may not be associated with a spacecraft clock update. (See bit 26, Quality Indicator Bit Field) bit 20: start of a sequence that apparently repeats scan times that have been previously accepted. bits 19 - 16: <zero fill></p> <p><i>Calibration Anomaly Problem Code</i> (Note these bits complement the channel indicators; all bits set to 0 indicates normal calibration.) bit 15: scan line was not calibrated because of bad time. bit 14: scan line was calibrated using fewer than the preferred number of scan lines because of proximity to start or end of data set or to a data gap. bit 13: scan line was not calibrated because of bad or insufficient PRT data. bit 12: scan line was calibrated but with marginal PRT data. bit 11: some uncalibrated channels on this scan (see channel indicators). bit 10: uncalibrated due to instrument mode. bits 9: moonlight detected in space views bit- 8: <zero fill></p>	33	36	u	4	1	0		

<p><i>Earth Location Problem Code</i> (all bits set to 0 implies the earth location was normal) bit 7: not earth located because of bad time; earth location fields zero filled. bit 6: earth location questionable because of questionable time code (see time problem flags above). bit 5: earth location questionable -- only marginal agreement with reasonableness check. bit 4: earth location questionable -- fails reasonableness check. bits 3-0: <zero fill></p>								
<p>Calibration Quality Flags (all bits off implies a good calibration)</p> <p><i>Word 1: Channel 1</i> bit 15-6: <zero fill> bit 5: all bad blackbody counts for scan line bit 4: all bad space view counts for scan line bit 3: all bad PRTs for this line bit 2: marginal blackbody view counts for this line bit 1: marginal space view counts for this line bit 0: marginal PRT temperatures on this line</p> <p><i>Words 2-20</i> Channels 17, 2, 3, 13, 4, 18, 11, 19, 7, 8, 20, 10, 14, 6, 5, 15, 12, 16, 9 (in order)</p>	37	76	u	2	20	0		
<p>Minor Frame Quality Indicator Bit Fields For bits 7 through 1, if bit is on (=1) then statement is true.</p> <p><i>Word 1: Minor Frame 0</i> bit 7: this frame suspect due to a time error bit 6: this frame contains data gap data fill bit 5: this frame contains TIP dwell data fill bit 4: data suspect due to PACS QC error bit 3: mirror locked during this frame bit 2: mirror position error during this</p>	77	140	u	1	64	0		

frame bit 1: mirror was moving during this frame bit 0: minor word odd parity bit <i>Words 2 - 64: Minor Frames 1 - 63 (in order)</i>								
<zero fill>	141	156	i	4	4	0		
CALIBRATION COEFFICIENTS								
Note: The following coefficients are <zero fill> in commanded position modes (nadir, space, internal cold target, internal warm target). Refer to Data Element 63, First and Second Status Words for the current mode.								
Primary Calibration Ch 1 Second Order Term	157	160	i	4	1	12		
Primary Calibration Ch 1 First Order Term	161	164	i	4	1	9		
Primary Calibration Ch 1 Zeroth Order Term	165	168	i	4	1	6		
Primary Calibration Ch 17 Second Order Term	169	172	i	4	1	12		
Primary Calibration Ch 17 First Order Term	173	176	i	4	1	9		
Primary Calibration Ch 17 Zeroth Order Term	177	180	i	4	1	6		
Primary Calibration Ch 2 Second Order Term	181	184	i	4	1	12		
Primary Calibration Ch 2 First Order Term	185	188	i	4	1	9		
Primary Calibration Ch 2 Zeroth Order Term	189	192	i	4	1	6		
Primary Calibration Ch 3 Second Order Term	193	196	i	4	1	12		
Primary Calibration Ch 3 First Order Term	197	200	i	4	1	9		
Primary Calibration Ch 3 Zeroth Order Term	201	204	i	4	1	6		
Primary Calibration Ch 13 Second Order Term	205	208	i	4	1	12		

Primary Calibration Ch 13 First Order Term	209	212	i	4	1	9		
Primary Calibration Ch 13 Zeroth Order Term	213	216	i	4	1	6		
Primary Calibration Ch 4 Second Order Term	217	220	i	4	1	12		
Primary Calibration Ch 4 First Order Term	221	224	i	4	1	9		
Primary Calibration Ch 4 Zeroth Order Term	225	228	i	4	1	6		
Primary Calibration Ch 18 Second Order Term	229	232	i	4	1	12		
Primary Calibration Ch 18 First Order Term	233	236	i	4	1	9		
Primary Calibration Ch 18 Zeroth Order Term	237	240	i	4	1	6		
Primary Calibration Ch 11 Second Order Term	241	244	i	4	1	12		
Primary Calibration Ch 11 First Order Term	245	248	i	4	1	9		
Primary Calibration Ch 11 Zeroth Order Term	249	252	i	4	1	6		
Primary Calibration Ch 19 Second Order Term	253	256	i	4	1	12		
Primary Calibration Ch 19 First Order Term	257	260	i	4	1	9		
Primary Calibration Ch 19 Zeroth Order Term	261	264	i	4	1	6		
Primary Calibration Ch 7 Second Order Term	265	268	i	4	1	12		
Primary Calibration Ch 7 First Order Term	269	272	i	4	1	9		
Primary Calibration Ch 7 Zeroth Order Term	273	276	i	4	1	6		
Primary Calibration Ch 8 Second Order Term	277	280	i	4	1	12		

Primary Calibration Ch 8 First Order Term	281	284	i	4	1	9		
Primary Calibration Ch 8 Zeroth Order Term	285	288	i	4	1	6		
Primary Calibration Ch 20 Second Order Term	289	292	i	4	1	12		
Primary Calibration Ch 20 First Order Term	293	296	i	4	1	9		
Primary Calibration Ch 20 Zeroth Order Term	297	300	i	4	1	6		
Primary Calibration Ch 10 Second Order Term	301	304	i	4	1	12		
Primary Calibration Ch 10 First Order Term	305	308	i	4	1	9		
Primary Calibration Ch 10 Zeroth Order Term	309	312	i	4	1	6		
Primary Calibration Ch 14 Second Order Term	313	316	i	4	1	12		
Primary Calibration Ch 14 First Order Term	317	320	i	4	1	9		
Primary Calibration Ch 14 Zeroth Order Term	321	324	i	4	1	6		
Primary Calibration Ch 6 Second Order Term	325	328	i	4	1	12		
Primary Calibration Ch 6 First Order Term	329	332	i	4	1	9		
Primary Calibration Ch 6 Zeroth Order Term	333	336	i	4	1	6		
Primary Calibration Ch 5 Second Order Term	337	340	i	4	1	12		
Primary Calibration Ch 5 First Order Term	341	344	i	4	1	9		
Primary Calibration Ch 5 Zeroth Order Term	345	348	i	4	1	6		
Primary Calibration Ch 15 Second Order Term	349	352	i	4	1	12		

Primary Calibration Ch 15 First Order Term	353	356	i	4	1	9		
Primary Calibration Ch 15 Zeroth Order Term	357	360	i	4	1	6		
Primary Calibration Ch 12 Second Order Term	361	364	i	4	1	12		
Primary Calibration Ch 12 First Order Term	365	368	i	4	1	9		
Primary Calibration Ch 12 Zeroth Order Term	369	372	i	4	1	6		
Primary Calibration Ch 16 Second Order Term	373	376	i	4	1	12		
Primary Calibration Ch 16 First Order Term	377	380	i	4	1	9		
Primary Calibration Ch 16 Zeroth Order Term	381	384	i	4	1	6		
Primary Calibration Ch 9 Second Order Term	385	388	i	4	1	12		
Primary Calibration Ch 9 First Order Term	389	392	i	4	1	9		
Primary Calibration Ch 9 Zeroth Order Term	393	396	i	4	1	6		
Spare Calibration Ch 1 Second Order Term	397	400	i	4	1	12		
Spare Calibration Ch 1 First Order Term	401	404	i	4	1	9		
Spare Calibration Ch 1 Zeroth Order Term	405	408	i	4	1	6		
Spare Calibration Ch 17 Second Order Term	409	412	i	4	1	12		
Spare Calibration Ch 17 First Order Term	413	416	i	4	1	9		
Spare Calibration Ch 17 Zeroth Order Term	417	420	i	4	1	6		
Spare Calibration Ch 2 Second Order Term	421	424	i	4	1	12		
Spare Calibration Ch 2 First Order Term	425	428	i	4	1	9		

Spare Calibration Ch 2 Zeroth Order Term	429	432	i	4	1	6		
Spare Calibration Ch 3 Second Order Term	433	436	i	4	1	12		
Spare Calibration Ch 3 First Order Term	437	440	i	4	1	9		
Spare Calibration Ch 3 Zeroth Order Term	441	444	i	4	1	6		
Spare Calibration Ch 13 Second Order Term	445	448	i	4	1	12		
Spare Calibration Ch 13 First Order Term	449	452	i	4	1	9		
Spare Calibration Ch 13 Zeroth Order Term	453	456	i	4	1	6		
Spare Calibration Ch 4 Second Order Term	457	460	i	4	1	12		
Spare Calibration Ch 4 First Order Term	461	464	i	4	1	9		
Spare Calibration Ch 4 Zeroth Order Term	465	468	i	4	1	6		
Spare Calibration Ch 18 Second Order Term	469	472	i	4	1	12		
Spare Calibration Ch 18 First Order Term	473	476	i	4	1	9		
Spare Calibration Ch 18 Zeroth Order Term	477	480	i	4	1	6		
Spare Calibration Ch 11 Second Order Term	481	484	i	4	1	12		
Spare Calibration Ch 11 First Order Term	485	488	i	4	1	9		
Spare Calibration Ch 11 Zeroth Order Term	489	492	i	4	1	6		
Spare Calibration Ch 19 Second Order Term	493	496	i	4	1	12		
Spare Calibration Ch 19 First Order Term	497	500	i	4	1	9		
Spare Calibration Ch 19 Zeroth Order Term	501	504	i	4	1	6		

Spare Calibration Ch 7 Second Order Term	505	508	i	4	1	12		
Spare Calibration Ch 7 First Order Term	509	512	i	4	1	9		
Spare Calibration Ch 7 Zeroth Order Term	513	516	i	4	1	6		
Spare Calibration Ch 8 Second Order Term	517	520	i	4	1	12		
Spare Calibration Ch 8 First Order Term	521	524	i	4	1	9		
Spare Calibration Ch 8 Zeroth Order Term	525	528	i	4	1	6		
Spare Calibration Ch 20 Second Order Term	529	532	i	4	1	12		
Spare Calibration Ch 20 First Order Term	533	536	i	4	1	9		
Spare Calibration Ch 20 Zeroth Order Term	537	540	i	4	1	6		
Spare Calibration Ch 10 Second Order Term	541	544	i	4	1	12		
Spare Calibration Ch 10 First Order Term	545	548	i	4	1	9		
Spare Calibration Ch 10 Zeroth Order Term	549	552	i	4	1	6		
Spare Calibration Ch 14 Second Order Term	553	556	i	4	1	12		
Spare Calibration Ch 14 First Order Term	557	560	i	4	1	9		
Spare Calibration Ch 14 Zeroth Order Term	561	564	i	4	1	6		
Spare Calibration Ch 6 Second Order Term	565	568	i	4	1	12		
Spare Calibration Ch 6 First Order Term	569	572	i	4	1	9		
Spare Calibration Ch 6 Zeroth Order Term	573	576	i	4	1	6		
Spare Calibration Ch 5 Second Order Term	577	580	i	4	1	12		
Spare Calibration Ch 5 First Order Term	581	584	i	4	1	9		

Spare Calibration Ch 5 Zeroth Order Term	585	588	i	4	1	6		
Spare Calibration Ch 15 Second Order Term	589	592	i	4	1	12		
Spare Calibration Ch 15 First Order Term	593	596	i	4	1	9		
Spare Calibration Ch 15 Zeroth Order Term	597	600	i	4	1	6		
Spare Calibration Ch 12 Second Order Term	601	604	i	4	1	12		
Spare Calibration Ch 12 First Order Term	605	608	i	4	1	9		
Spare Calibration Ch 12 Zeroth Order Term	609	612	i	4	1	6		
Spare Calibration Ch 16 Second Order Term	613	616	i	4	1	12		
Spare Calibration Ch 16 First Order Term	617	620	i	4	1	9		
Spare Calibration Ch 16 Zeroth Order Term	621	624	i	4	1	6		
Spare Calibration Ch 9 Second Order Term	625	628	i	4	1	12		
Spare Calibration Ch 9 First Order Term	629	632	i	4	1	9		
Spare Calibration Ch 9 Zeroth Order Term	633	636	i	4	1	6		
<zero fill>	637	648	i	4	3	0		
NAVIGATION								
Navigation Status Bit Field bits 31-17: <zero fill> bit 16: 1 = earth location corrected for TIP Euler angles bits 15 - 12: earth location indicator 0 = earth location available; 1 = user ephemeris files greater than 24 hours old; 2 = no earth location available	649	652	u	4	1	0		

bits 11 - 8: spacecraft attitude control 0 = operating in YGC or NOMINAL mode; 1 = operating in another mode; 2 = attitude exceeds nominal tolerance; 3 = both 1 and 2. bits 7 - 4: attitude SMODE 0 = NOMINAL mode; 1 = rate nulling mode; 2 = YGC mode; 3 = search mode; 4 = coast mode bits 3 - 0: attitude PWTIP\$AC 0 = NOMINAL mode/no test; 1 = yaw axis test in progress; 2 = roll axis test in progress; 3 = pitch axis test in progress								
Time Associated with TIP Euler Angles	653	656	u	4	1	0	seconds	
TIP Euler Angles <i>Word 1: Roll</i> <i>Word 2: Pitch</i> <i>Word 3: Yaw</i>	657	662	i	2	3	3	degrees	
Spacecraft Altitude above Reference Ellipsoid	663	664	u	2	1	1	km	
Angular Relationships (local azimuth range ± 180.00 degrees) Word 1: Solar Zenith Angle, Point 1 Word 2: Satellite Zenith Angle, Point 1 Word 3: Local Azimuth Angle, Point 1 Word 4: Solar Zenith Angle, Point 2 ... (set of 3 angles for every point) ... Word 168: Local Azimuth Angle, Point 56	665	1000	i	2	168	2	degrees	

Earth Location (North latitude and East longitude are positive) <i>Word 1:</i> Latitude in Degrees, Point 1 <i>Word 2:</i> Longitude in Degrees, Point 1 <i>Word 3:</i> Latitude in Degrees, Point 2 ... (lat/lon word pair for every point) ... <i>Word 112:</i> Longitude in Degrees, Point 56	1001	1448	i	4	112	4	degrees	
<zero fill>	1449	1456	i	4	2	0		
HIRS DATA ELEMENTS								
Header for Element 0 (same format through Element 63) bits 31-24: scan encoder position bits 23-19: electronic cal level indicator bits 18-13: <zero fill> bits 12-7: channel 1 period monitor bits 6-1: element number bit 0: filter sync designator	1457	1460	u	4	1	0		
Radiometric Data (same format through Element 55) <i>Word 1:</i> Channel 1 bits 15-13: <zero fill> bits 12-0: 13 bit data. To retrieve, read in as signed 2 byte integer and then subtract 4096. The resultant value should be between -4095 and +4096. <i>Words 2-20:</i> Channels 17, 2, 3, 13, 4, 18, 11, 19, 7, 8, 20, 10, 14, 6, 5, 15, 12, 16, 9 (in order)	1461	1500	u	2	20	0		
Bit Flags (same format through Element 63) bit 15: valid data flag (0 = ignore data, 1 = good data) bit 14: odd bit parity bits 13-0: <zero fill>	1501	1502	u	2	1	0		
<zero fill>	1503	1504	i	2	1	0		
Header for Element 1	1505	1508	u	4	1	0		
Radiometric Data	1509	1548	u	2	20	0		

Bit Flags	1549	1550	u	2	1	0		
<zero fill>	1551	1552	i	2	1	0		
Header for Element 2	1553	1556	u	4	1	0		
Radiometric Data	1557	1596	u	2	20	0		
Bit Flags	1597	1598	u	2	1	0		
<zero fill>	1599	1600	i	2	1	0		
Header for Element 3	1601	1604	u	4	1	0		
Radiometric Data	1605	1644	u	2	20	0		
Bit Flags	1645	1646	u	2	1	0		
<zero fill>	1647	1648	i	2	1	0		
Header for Element 4	1649	1652	u	4	1	0		
Radiometric Data	1653	1692	u	2	20	0		
Bit Flags	1693	1694	u	2	1	0		
<zero fill>	1695	1696	i	2	1	0		
Header for Element 5	1697	1700	u	4	1	0		
Radiometric Data	1701	1740	u	2	20	0		
Bit Flags	1741	1742	u	2	1	0		
<zero fill>	1743	1744	i	2	1	0		
Header for Element 6	1745	1748	u	4	1	0		
Radiometric Data	1749	1788	u	2	20	0		
Bit Flags	1789	1790	u	2	1	0		
<zero fill>	1791	1792	i	2	1	0		
Header for Element 7	1793	1796	u	4	1	0		
Radiometric Data	1797	1836	u	2	20	0		
Bit Flags	1837	1838	u	2	1	0		
<zero fill>	1839	1840	i	2	1	0		
Header for Element 8	1841	1844	u	4	1	0		
Radiometric Data	1845	1884	u	2	20	0		

Bit Flags	1885	1886	u	2	1	0		
<zero fill>	1887	1888	i	2	1	0		
Header for Element 9	1889	1892	u	4	1	0		
Radiometric Data	1893	1932	u	2	20	0		
Bit Flags	1933	1934	u	2	1	0		
<zero fill>	1935	1936	i	2	1	0		
Header for Element 10	1937	1940	u	4	1	0		
Radiometric Data	1941	1980	u	2	20	0		
Bit Flags	1981	1982	u	2	1	0		
<zero fill>	1983	1984	i	2	1	0		
Header for Element 11	1985	1988	u	4	1	0		
Radiometric Data	1989	2028	u	2	20	0		
Bit Flags	2029	2030	u	2	1	0		
<zero fill>	2031	2032	i	2	1	0		
Header for Element 12	2033	2036	u	4	1	0		
Radiometric Data	2037	2076	u	2	20	0		
Bit Flags	2077	2078	u	2	1	0		
<zero fill>	2079	2080	i	2	1	0		
Header for Element 13	2081	2084	u	4	1	0		
Radiometric Data	2085	2124	u	2	20	0		
Bit Flags	2125	2126	u	2	1	0		
<zero fill>	2127	2128	i	2	1	0		
Header for Element 14	2129	2132	u	4	1	0		
Radiometric Data	2133	2172	u	2	20	0		
Bit Flags	2173	2174	u	2	1	0		
<zero fill>	2175	2176	i	2	1	0		
Header for Element 15	2177	2180	u	4	1	0		
Radiometric Data	2181	2220	u	2	20	0		

Bit Flags	2221	2222	u	2	1	0		
<zero fill>	2223	2224	i	2	1	0		
Header for Element 16	2225	2228	u	4	1	0		
Radiometric Data	2229	2268	u	2	20	0		
Bit Flags	2269	2270	u	2	1	0		
<zero fill>	2271	2272	i	2	1	0		
Header for Element 17	2273	2276	u	4	1	0		
Radiometric Data	2277	2316	u	2	20	0		
Bit Flags	2317	2318	u	2	1	0		
<zero fill>	2319	2320	i	2	1	0		
Header for Element 18	2321	2324	u	4	1	0		
Radiometric Data	2325	2364	u	2	20	0		
Bit Flags	2365	2366	u	2	1	0		
<zero fill>	2367	2368	i	2	1	0		
Header for Element 19	2369	2372	u	4	1	0		
Radiometric Data	2373	2412	u	2	20	0		
Bit Flags	2413	2414	u	2	1	0		
<zero fill>	2415	2416	i	2	1	0		
Header for Element 20	2417	2420	u	4	1	0		
Radiometric Data	2421	2460	u	2	20	0		
Bit Flags	2461	2462	u	2	1	0		
<zero fill>	2463	2464	i	2	1	0		
Header for Element 21	2465	2468	u	4	1	0		
Radiometric Data	2469	2508	u	2	20	0		
Bit Flags	2509	2510	u	2	1	0		
<zero fill>	2511	2512	i	2	1	0		
Header for Element 22	2513	2516	u	4	1	0		
Radiometric Data	2517	2556	u	2	20	0		

Bit Flags	2557	2558	u	2	1	0		
<zero fill>	2559	2560	i	2	1	0		
Header for Element 23	2561	2564	u	4	1	0		
Radiometric Data	2565	2604	u	2	20	0		
Bit Flags	2605	2606	u	2	1	0		
<zero fill>	2607	2608	i	2	1	0		
Header for Element 24	2609	2612	u	4	1	0		
Radiometric Data	2613	2652	u	2	20	0		
Bit Flags	2653	2654	u	2	1	0		
<zero fill>	2655	2656	i	2	1	0		
Header for Element 25	2657	2660	u	4	1	0		
Radiometric Data	2661	2700	u	2	20	0		
Bit Flags	2701	2702	u	2	1	0		
<zero fill>	2703	2704	i	2	1	0		
Header for Element 26	2705	2708	u	4	1	0		
Radiometric Data	2709	2748	u	2	20	0		
Bit Flags	2749	2750	u	2	1	0		
<zero fill>	2751	2752	i	2	1	0		
Header for Element 27	2753	2756	u	4	1	0		
Radiometric Data	2757	2796	u	2	20	0		
Bit Flags	2797	2798	u	2	1	0		
<zero fill>	2799	2800	i	2	1	0		
Header for Element 28	2801	2804	u	4	1	0		
Radiometric Data	2805	2844	u	2	20	0		
Bit Flags	2845	2846	u	2	1	0		
<zero fill>	2847	2848	i	2	1	0		
Header for Element 29	2849	2852	u	4	1	0		
Radiometric Data	2853	2892	u	2	20	0		

Bit Flags	2893	2894	u	2	1	0		
<zero fill>	2895	2896	i	2	1	0		
Header for Element 30	2897	2900	u	4	1	0		
Radiometric Data	2901	2940	u	2	20	0		
Bit Flags	2941	2942	u	2	1	0		
<zero fill>	2943	2944	i	2	1	0		
Header for Element 31	2945	2948	u	4	1	0		
Radiometric Data	2949	2988	u	2	20	0		
Bit Flags	2989	2990	u	2	1	0		
<zero fill>	2991	2992	i	2	1	0		
Header for Element 32	2993	2996	u	4	1	0		
Radiometric Data	2997	3036	u	2	20	0		
Bit Flags	3037	3038	u	2	1	0		
<zero fill>	3039	3040	i	2	1	0		
Header for Element 33	3041	3044	u	4	1	0		
Radiometric Data	3045	3084	u	2	20	0		
Bit Flags	3085	3086	u	2	1	0		
<zero fill>	3087	3088	i	2	1	0		
Header for Element 34	3089	3092	u	4	1	0		
Radiometric Data	3093	3132	u	2	20	0		
Bit Flags	3133	3134	u	2	1	0		
<zero fill>	3135	3136	i	2	1	0		
Header for Element 35	3137	3140	u	4	1	0		
Radiometric Data	3141	3180	u	2	20	0		
Bit Flags	3181	3182	u	2	1	0		
<zero fill>	3183	3184	i	2	1	0		
Header for Element 36	3185	3188	u	4	1	0		
Radiometric Data	3189	3228	u	2	20	0		

Bit Flags	3229	3230	u	2	1	0		
<zero fill>	3231	3232	i	2	1	0		
Header for Element 37	3233	3236	u	4	1	0		
Radiometric Data	3237	3276	u	2	20	0		
Bit Flags	3277	3278	u	2	1	0		
<zero fill>	3279	3280	i	2	1	0		
Header for Element 38	3281	3284	u	4	1	0		
Radiometric Data	3285	3324	u	2	20	0		
Bit Flags	3325	3326	u	2	1	0		
<zero fill>	3327	3328	i	2	1	0		
Header for Element 39	3329	3332	u	4	1	0		
Radiometric Data	3333	3372	u	2	20	0		
Bit Flags	3373	3374	u	2	1	0		
<zero fill>	3375	3376	i	2	1	0		
Header for Element 40	3377	3380	u	4	1	0		
Radiometric Data	3381	3420	u	2	20	0		
Bit Flags	3421	3422	u	2	1	0		
<zero fill>	3423	3424	i	2	1	0		
Header for Element 41	3425	3428	u	4	1	0		
Radiometric Data	3429	3468	u	2	20	0		
Bit Flags	3469	3470	u	2	1	0		
<zero fill>	3471	3472	i	2	1	0		
Header for Element 41	3473	3476	u	4	1	0		
Radiometric Data	3477	3516	u	2	20	0		
Bit Flags	3517	3518	u	2	1	0		
<zero fill>	3519	3520	i	2	1	0		
Header for Element 43	3521	3524	u	4	1	0		
Radiometric Data	3525	3564	u	2	20	0		

Bit Flags	3565	3566	u	2	1	0		
<zero fill>	3567	3568	i	2	1	0		
Header for Element 44	3569	3572	u	4	1	0		
Radiometric Data	3573	3612	u	2	20	0		
Bit Flags	3613	3614	u	2	1	0		
<zero fill>	3615	3616	i	2	1	0		
Header for Element 45	3617	3620	u	4	1	0		
Radiometric Data	3621	3660	u	2	20	0		
Bit Flags	3661	3662	u	2	1	0		
<zero fill>	3663	3664	i	2	1	0		
Header for Element 46	3665	3668	u	4	1	0		
Radiometric Data	3669	3708	u	2	20	0		
Bit Flags	3709	3710	u	2	1	0		
<zero fill>	3711	3712	i	2	1	0		
Header for Element 47	3713	3716	u	4	1	0		
Radiometric Data	3717	3756	u	2	20	0		
Bit Flags	3757	3758	u	2	1	0		
<zero fill>	3759	3760	i	2	1	0		
Header for Element 48	3761	3764	u	4	1	0		
Radiometric Data	3765	3804	u	2	20	0		
Bit Flags	3805	3806	u	2	1	0		
<zero fill>	3807	3808	i	2	1	0		
Header for Element 49	3809	3812	u	4	1	0		
Radiometric Data	3813	3852	u	2	20	0		
Bit Flags	3853	3854	u	2	1	0		
<zero fill>	3855	3856	i	2	1	0		
Header for Element 50	3857	3860	u	4	1	0		
Radiometric Data	3861	3900	u	2	20	0		

Bit Flags	3901	3902	u	2	1	0		
<zero fill>	3903	3904	i	2	1	0		
Header for Element 51	3905	3908	u	4	1	0		
Radiometric Data	3909	3948	u	2	20	0		
Bit Flags	3949	3950	u	2	1	0		
<zero fill>	3951	3952	i	2	1	0		
Header for Element 51	3953	3956	u	4	1	0		
Radiometric Data	3957	3996	u	2	20	0		
Bit Flags	3997	3998	u	2	1	0		
<zero fill>	3999	4000	i	2	1	0		
Header for Element 53	4001	4004	u	4	1	0		
Radiometric Data	4005	4044	u	2	20	0		
Bit Flags	4045	4046	u	2	1	0		
<zero fill>	4047	4048	i	2	1	0		
Header for Element 54	4049	4052	u	4	1	0		
Radiometric Data	4053	4092	u	2	20	0		
Bit Flags	4093	4094	u	2	1	0		
<zero fill>	4095	4096	i	2	1	0		
Header for Element 55	4097	4100	u	4	1	0		
Radiometric Data	4101	4140	u	2	20	0		
Bit Flags	4141	4142	u	2	1	0		
<zero fill>	4143	4144	i	2	1	0		
Header for Element 56	4145	4148	u	4	1	0		
Positive Calibration Word 1: Channel 1 Words 2-20: Channels 17, 2, 3, 13, 4, 18, 11, 19, 7, 8, 20, 10, 14, 6, 5, 15, 12, 16, 9 (in order)	4149	4188	u	2	20	0		
Bit Flags	4189	4190	u	2	1	0		
<zero fill>	4191	4192	i	2	1	0		

Header for Element 57	4193	4196	u	4	1	0		
Negative Calibration <i>Word 1:</i> Channel 1 <i>Words 2-20:</i> Channels 17, 2, 3, 13, 4, 18, 11, 19, 7, 8, 20, 10, 14, 6, 5, 15, 12, 16, 9 (in order)	4197	4236	u	2	20	0		
Bit Flags	4237	4238	u	2	1	0		
<zero fill>	4239	4240	i	2	1	0		
Header for Element 58	4241	4244	u	4	1	0		
Internal Warm Target, Temperature Sensor #1 (zero fill in commanded position modes) <i>Word 1:</i> Reading 1 ... <i>Word 5:</i> Reading 5	4245	4254	i	2	5	0		
Internal Warm Target, Temperature Sensor #2 (zero fill in commanded position modes) <i>Word 1:</i> Reading 1 ... <i>Word 5:</i> Reading 5	4255	4264	i	2	5	0		
Internal Warm Target, Temperature Sensor #3 (zero fill in commanded position modes) <i>Word 1:</i> Reading 1 ... <i>Word 5:</i> Reading 5	4265	4274	i	2	5	0		
Internal Warm Target, Temperature Sensor #4 (zero fill in commanded position modes) <i>Word 1:</i> Reading 1 ... <i>Word 5:</i> Reading 5	4275	4284	i	2	5	0		
Bit Flags	4285	4286	u	2	1	0		
<zero fill>	4287	4288	i	2	1	0		
Header for Element 59	4289	4292	u	4	1	0		

Space View (zero fill in commanded position modes) <i>Word 1:</i> Reading 1 ... <i>Word 5:</i> Reading 5	4293	4302	i	2	5	0		
Space View (zero fill in commanded position modes) <i>Word 1:</i> Reading 1 ... <i>Word 5:</i> Reading 5	4303	4312	i	2	5	0		
Space View (zero fill in commanded position modes) <i>Word 1:</i> Reading 1 ... <i>Word 5:</i> Reading 5	4313	4322	i	2	5	0		
Space View (zero fill in commanded position modes) <i>Word 1:</i> Reading 1 ... <i>Word 5:</i> Reading 5	4323	4332	i	2	5	0		
Bit Flags	4333	4334	u	2	1	0		
<zero fill>	4335	4336	i	2	1	0		
Header for Element 60	4337	4340	u	4	1	0		
Internal Filter Wheel Housing, Temperature sensor #1 <i>Word 1:</i> Reading 1 ... <i>Word 5:</i> Reading 5	4341	4350	i	2	5	0		
Internal Filter Wheel Housing, Temperature sensor #2 <i>Word 1:</i> Reading 1 ... <i>Word 5:</i> Reading 5	4351	4360	i	2	5	0		
Internal Filter Wheel Housing, Temperature sensor #3 <i>Word 1:</i> Reading 1 ... <i>Word 5:</i> Reading 5	4361	4370	i	2	5	0		

Internal Filter Wheel Housing, Temperature sensor #4 <i>Word 1: Reading 1</i> ... <i>Word 5: Reading 5</i>	4371	4380	i	2	5	0		
Bit Flags	4381	4382	u	2	1	0		
<zero fill>	4383	4384	i	2	1	0		
Header for Element 61	4385	4388	u	4	1	0		
Patch Temperature (Expanded Scale) <i>Word 1: Reading 1</i> ... <i>Word 5: Reading 5</i>	4389	4398	i	2	5	0		
1st Stage Radiator Temperature Sensor <i>Word 1: Reading 1</i> ... <i>Word 5: Reading 5</i>	4399	4408	i	2	5	0		
Filter Wheel Housing Heater Current <i>Word 1: Reading 1</i> ... <i>Word 5: Reading 5</i>	4409	4418	i	2	5	0		
Electronic Cal. Digital to Analog Converter <i>Word 1: Reading 1</i> ... <i>Word 5: Reading 5</i>	4419	4428	i	2	5	0		
Bit Flags	4429	4430	u	2	1	0		
<zero fill>	4431	4432	i	2	1	0		
Header for Element 62	4433	4436	u	4	1	0		
Scan Mirror Temperature	4437	4438	i	2	1	0		
Primary Telescope Temperature	4439	4440	i	2	1	0		
Secondary Telescope Temperature	4441	4442	i	2	1	0		
HIRS Baseplate Temperature	4443	4444	i	2	1	0		
HIRS Electronics Temperature	4445	4446	i	2	1	0		
Patch Temperature Full Range	4447	4448	i	2	1	0		
Scan Motor Temperature	4449	4450	i	2	1	0		
Filter Wheel Motor Temperature	4451	4452	i	2	1	0		

Cooler Housing Temperature	4453	4454	i	2	1	0		
Patch Control Power	4455	4456	i	2	1	0		
Scan Motor Current	4457	4458	i	2	1	0		
Filter Motor Current	4459	4460	i	2	1	0		
+15 VDC	4461	4462	i	2	1	0		
-15 VDC	4463	4464	i	2	1	0		
+7.5 VDC	4465	4466	i	2	1	0		
-7.5 VDC	4467	4468	i	2	1	0		
+10 VDC	4469	4470	i	2	1	0		
+5 VDC	4471	4472	i	2	1	0		
Analog Ground	4473	4474	i	2	1	0		
Analog Ground	4475	4476	i	2	1	0		
Bit Flags	4477	4478	u	2	1	0		
<zero fill>	4479	4480	i	2	1	0		
Header for Element 63	4481	4484	u	4	1	0		
Line Counter (The number of lines from the last auto calibration sequence)	4485	4486	u	2	1	0		
First Status Word bits 15-13: <zero fill> bits 12-8: instrument serial number (?? = s/n 301; 13 = s/n 302) bit 7: instrument on/off (0 = off; 1 = on) bit 6: scan motor on/off (0 = on; 1 = off) bit 5: filter wheel on/off (0 = on; 1 = off) bit 4: electronics on/off (0 = off; 1 = on) bit 3: cooler heat on/off (0 = on; 1 = off) bit 2: internal warm target position (0 = true) bit 1: internal cold target position (0 = true) bit 0: space position (0 = true)	4487	4488	u	2	1	0		
Second Status Word bits 15-8: <zero fill> bit 7: nadir position (0 = true) bit 6: calibration enable/disable (0 = enabled)	4489	4490	u	2	1	0		

bit 5: cooler door release enable/disable (0 = enabled) bit 4: cooler door open (0 = no; 1 = yes) bit 3: cooler door closed (0 = no; 1 = yes) bit 2: filter housing heat on/off (0 = on; 1 = off) bit 1: patch temperature control on/off (0 = on; 1 = off) bit 0: filter motor power high (0 = high; 1 = normal)								
Data Verification Binary Code	4491	4524	u	2	17	0		
Bit Flags	4525	4526	u	2	1	0		
<zero fill>	4527	4540	i	2	7	0		
DIGITAL B TELEMETRY								
Invalid Word Bit Flags (if bit = 1, associated telemetry bit was not updated during most recent minor frame cycle - possibly due to lost frame) bit 15: instrument power bit 14: electronics power bit 13: filter motor power bit 12: scan motor power bit 11: cooler heater bit 10: filter housing heater bit 9: cooler door release bit 8: cooler window heater bit 7: go to nadir position bit 6: calibration sequence bit 5: cooler door closed bit 4: cooler door fully open bit 3: filter motor power level bit 2: patch temperature controller bits 1-0: <zero fill>	4541	4542	u	2	1	0		
Digital B Data bit 15: instrument power (0 = off; 1 = on) bit 14: electronics power (0 = off; 1 = on) bit 13: filter motor power (0 = off; 1 = on) bit 12: scan motor power (0 = off; 1 = on) bit 11: cooler heater (0 = off; 1 = on) bit 10: filter housing heater (0 = off; 1 = on)	4543	4544	u	2	1	0		

bit 9: cooler door release (0 = disabled; 1 = enabled) bit 8: cooler window heater (0 = on; 1 = off) bit 7: go to nadir position (0 = no; 1 = yes/initiated) bit 6: calibration sequence (0 = disabled; 1 = enabled) bit 5: cooler door closed (0 = yes; 1 = no) bit 4: cooler door fully open (0 = yes; 1 = no) bit 3: filter motor power level (0 = normal; 1 = high) bit 2: patch temperature controller (0 = off; 1 = on) bits 1-0: <zero fill>								
ANALOG TELEMETRY								
Invalid Word Bit Flags (if bit = 1, associated telemetry word was not updated during most recent minor frame cycle - possibly due to lost frame) bits 31 - 17: <zero fill> bit 16: patch controller power (word 16) bits 15-2: words 15 through 2 (in order) bit 1: radiator temperature (word 1) bit 0: <zero fill>	4545	4548	u	4	1	0		
<i>Word 1: Radiator Temperature</i> <i>Word 2: Base Plate Temperature</i> <i>Word 3: Electronics Temperature</i> <i>Word 4: Patch Temperature</i> <i>Word 5: Filter Housing Controller Current</i> <i>Word 6: Scan Motor Temperature</i> <i>Word 7: Filter Wheel Motor Temperature</i> <i>Word 8: +5 VDC Monitor</i> <i>Word 9: +10V VDC TLM/DC/DC Conv.</i> <i>Word 10: +7.5 VDC TLM/DC/DC Conv.</i> <i>Word 11: -7.5 VDC TLM/DC/DC Conv.</i> <i>Word 12: +15 VDC Monitor</i> <i>Word 13: -15 VDC Monitor</i> <i>Word 14: Filter Wheel Motor Current</i> <i>Word 15: Scan Motor Current</i> <i>Word 16: Patch Controller Power</i>	4549	4564	u	1	16	0		

FILLER								
<zero fill>	4565	4608	i	4	11	0		

8.3.1.5.3.2 NOAA-N Format (Version 4, post-January 25, 2006)

The HIRS/4 Level 1b Data Format (Version 4, post-January 25, 2006, NOAA-18, NOAA-19 and Metop Series) is described in Table 8.3.1.5.3.2-1.

Table 8.3.1.5.3.2-1. Format of HIRS/4 Data Format (Version 4, post-January 25, 2006, NOAA-18, NOAA-19 and Metop Series)								
Field Name	Start Octet	End Octet	Data Type	Word Size	Number of Words	Scale Factor	Units	Notes
SCAN LINE INFORMATION								
Scan Line Number (cumulative, starting with 1)	1	2	u	2	1	0		
Scan Line Year (e.g., 1999)	3	4	u	2	1	0		
Scan Line Day of Year (e.g., 365)	5	6	u	2	1	0		
Satellite Clock Drift Delta	7	8	i	2	1	0	millisec	
Scan Line UTC Time of Day	9	12	u	4	1	0	millisec	
Scan Line Bit Field bit 15: satellite direction (0=northbound; 1=southbound) bit 14: clock drift correction (0=not corrected; 1=scan time corrected for clock drift) bits 13-0: <zero fill>	13	14	u	2	1	0		
Major Frame Count (cumulative, starting with 1)	15	16	u	2	1	0		
Scan Position Number in 32 Second Cycle	17	18	u	2	1	0		
Scan Type Code 0=earth view 1=space view 2=cold blackbody (BB) view 3=main (warm) BB view	19	20	u	2	1	0		
<zero fill>	21	28	i	4	2	0		
QUALITY INDICATORS								
Quality Indicator Bit Field (if a bit is on (=1), the statement is true) bit 31: do not use scan for product generation bit 30: time sequence error detected within this scan (see below) bit 29: data gap precedes this scan bit 28: calibration anomaly detected (see below) bit 27: earth location data not available (see below) bit 26: first good time following a clock update (nominally 0) bit 25: instrument status changed with this scan bits 24 - 0: <zero fill>	29	32	u	4	1	0		

Scan Line Quality Flags [Additional Calibration Problem Code] (If a bit is on (=1), the statement is true. See "Scan Line Quality Flags [Calibration Problem Code]", below.) bits 7-0: <zero fill>	33	33	u	1	1	0		
Scan Line Quality Flags [Time Problem Code] (If a bit is on (=1), the statement is true. All bits off implies the scan time is as expected.) bit 7: time field is bad but can probably be inferred from the previous good time bit 6: time field is bad and can't be inferred from the previous good time bit 5: this record starts a sequence that is inconsistent with previous times (i.e., there is a time discontinuity). This may be associated with a spacecraft clock update. (See bit 26, Quality Indicator Bit Field.) bit 4: start of a sequence that apparently repeats scan times that have been previously accepted bits 3-0: <zero fill>	34	34	u	1	1	0		
Scan Line Quality Flags [Calibration Problem Code] (If a bit is on (=1), the statement is true. These bits, along with those in "Scan Line Quality Flags [Additional Calibration Problem Code]", complement the channel indicators; all bits set to 0 indicates normal calibration.) bit 7: scan was not calibrated bit 6: anomalous space or BB view data, calibration slope value came from the HCF, or some QC tests could not be applied in some of the IR channels bit 5: PRT quality test failed bit 4: PRT data marginal, some readings were rejected bit 3: scan contains some uncalibrated channels bit 2: scan indicates that the normal HIRS calibration sequence is disabled bit 1: space view scan is lunar contaminated bit 0: <zero fill>	35	35	u	1	1	0		
Scan Line Quality Flags [Earth Location Problem Code] (If a bit is on (=1), the statement is true. All bits set to 0 implies the earth location was normal.) bit 7: not earth located because of bad time; earth location fields zero-filled bit 6: earth location questionable: questionable time code (see time problem flags above) bit 5: earth location questionable: marginal agreement with reasonableness check bit 4: earth location questionable: fails reasonableness check bits 3-0: <zero fill>	36	36	u	1	1	0		4

Calibration Quality Flags NOTE: (1) All bits off implies a good calibration. (2) These flags on the earth view scans for each channel will be inherited from the flags on the space view and blackbody view scans. Word 1: Channel 1 bit 15-6: <zero fill> bit 5: calibration failed bit 4: anomalous space or BB view data bit 3: calibration slope value came from the HCF bit 2: BB views failed NEDC test bit 1: space views failed NEDC test bit 0: some QC tests could not be applied Words 2-20: Channels 17, 2, 3, 13, 4, 18, 11, 19, 7, 8, 20, 10, 14, 6, 5, 15, 12, 16, 9 (in order)	37	76	u	2	20	0		3
Minor Frame Quality Indicator Bit Fields (for bits 7 through 1, if bit is on (=1) then statement is true) Word 1: Minor Frame 0 bit 7: this frame suspect due to a time error bit 6: this frame contains data gap data fill bit 5: this frame contains TIP dwell data fill bit 4: data suspect due to PACS QC error bit 3: mirror locked during this frame bit 2: mirror position error during this frame bit 1: mirror was moving during this frame bit 0: minor word odd parity bit Words 2 - 64: Minor Frames 1 - 63 (in order)	77	140	u	1	64	0		
<zero fill>	141	156	i	4	4	0		
CALIBRATION COEFFICIENTS								
<i>Note: The following coefficients are <zero fill> in commanded position modes (nadir, space, internal cold target, internal warm target). Refer to Data Element 63, First and Second Status Words for the current mode.</i>								
Primary Calibration Ch 1 Second Order Term	157	160	i	4	1	12		
Primary Calibration Ch 1 First Order Term	161	164	i	4	1	9		
Primary Calibration Ch 1 First Order Term	161	164	i	4	1	9		
Primary Calibration Ch 1 Zeroth Order Term	165	168	i	4	1	6		
Primary Calibration Ch 17 Second Order Term	169	172	i	4	1	12		
Primary Calibration Ch 17 First Order Term	173	176	i	4	1	9		
Primary Calibration Ch 17 Zeroth Order Term	177	180	i	4	1	6		
Primary Calibration Ch 2 Second Order Term	181	184	i	4	1	12		
Primary Calibration Ch 2 First Order Term	185	188	i	4	1	9		
Primary Calibration Ch 2 Zeroth Order Term	189	192	i	4	1	6		
Primary Calibration Ch 3 Second Order Term	193	196	i	4	1	12		
Primary Calibration Ch 3 First Order Term	197	200	i	4	1	9		
Primary Calibration Ch 3 First Order Term	197	200	i	4	1	9		
Primary Calibration Ch 3 Zeroth Order Term	201	204	i	4	1	6		
Primary Calibration Ch 13 Second Order Term	205	208	i	4	1	12		
Primary Calibration Ch 13 First Order Term	209	212	i	4	1	9		
Primary Calibration Ch 13 Zeroth Order Term	213	216	i	4	1	6		
Primary Calibration Ch 4 Second Order Term	217	220	i	4	1	12		

Primary Calibration Ch 4 First Order Term	221	224	i	4	1	9		
Primary Calibration Ch 4 Zeroth Order Term	225	228	i	4	1	6		
Primary Calibration Ch 18 Second Order Term	229	232	i	4	1	12		
Primary Calibration Ch 18 First Order Term	233	236	i	4	1	9		
Primary Calibration Ch 18 Zeroth Order Term	237	240	i	4	1	6		
Primary Calibration Ch 11 Second Order Term	241	244	i	4	1	12		
Primary Calibration Ch 11 First Order Term	245	248	i	4	1	9		
Primary Calibration Ch 11 Zeroth Order Term	249	252	i	4	1	6		
Primary Calibration Ch 19 Second Order Term	253	256	i	4	1	12		
Primary Calibration Ch 19 First Order Term	257	260	i	4	1	9		
Primary Calibration Ch 19 Zeroth Order Term	261	264	i	4	1	6		
Primary Calibration Ch 7 Second Order Term	265	268	i	4	1	12		
Primary Calibration Ch 7 First Order Term	269	272	i	4	1	9		
Primary Calibration Ch 7 Zeroth Order Term	273	276	i	4	1	6		
Primary Calibration Ch 8 Second Order Term	277	280	i	4	1	12		
Primary Calibration Ch 8 First Order Term	281	284	i	4	1	9		
Primary Calibration Ch 8 Zeroth Order Term	285	288	i	4	1	6		
Primary Calibration Ch 20 Second Order Term	289	292	i	4	1	12		
Primary Calibration Ch 20 First Order Term	293	296	i	4	1	9		
Primary Calibration Ch 20 Zeroth Order Term	297	300	i	4	1	6		
Primary Calibration Ch 10 Second Order Term	301	304	i	4	1	12		
Primary Calibration Ch 10 First Order Term	305	308	i	4	1	9		
Primary Calibration Ch 10 Zeroth Order Term	309	312	i	4	1	6		
Primary Calibration Ch 14 Second Order Term	313	316	i	4	1	12		
Primary Calibration Ch 14 First Order Term	317	320	i	4	1	9		
Primary Calibration Ch 14 Zeroth Order Term	321	324	i	4	1	6		
Primary Calibration Ch 6 Second Order Term	325	328	i	4	1	12		
Primary Calibration Ch 6 First Order Term	329	332	i	4	1	9		
Primary Calibration Ch 6 Zeroth Order Term	333	336	i	4	1	6		
Primary Calibration Ch 5 Second Order Term	337	340	i	4	1	12		
Primary Calibration Ch 5 First Order Term	341	344	i	4	1	9		
Primary Calibration Ch 5 Zeroth Order Term	345	348	i	4	1	6		
Primary Calibration Ch 15 Second Order Term	349	352	i	4	1	12		
Primary Calibration Ch 15 First Order Term	353	356	i	4	1	9		
Primary Calibration Ch 15 Zeroth Order Term	357	360	i	4	1	6		
Primary Calibration Ch 12 Second Order Term	361	364	i	4	1	12		
Primary Calibration Ch 12 First Order Term	365	368	i	4	1	9		
Primary Calibration Ch 12 Zeroth Order Term	369	372	i	4	1	6		
Primary Calibration Ch 16 Second Order Term	373	376	i	4	1	12		
Primary Calibration Ch 16 First Order Term	377	380	i	4	1	9		
Primary Calibration Ch 16 Zeroth Order Term	381	384	i	4	1	6		
Primary Calibration Ch 9 Second Order Term	385	388	i	4	1	12		
Primary Calibration Ch 9 First Order Term	389	392	i	4	1	9		
Primary Calibration Ch 9 Zeroth Order Term	393	396	i	4	1	6		

Spare Calibration Ch 1 Second Order Term	397	400	i	4	1	12		
Spare Calibration Ch 1 First Order Term	401	404	i	4	1	9		
Spare Calibration Ch 1 Zeroth Order Term	405	408	i	4	1	6		
Spare Calibration Ch 17 Second Order Term	409	412	i	4	1	12		
Spare Calibration Ch 17 First Order Term	413	416	i	4	1	9		
Spare Calibration Ch 17 Zeroth Order Term	417	420	i	4	1	6		
Spare Calibration Ch 2 Second Order Term	421	424	i	4	1	12		
Spare Calibration Ch 2 First Order Term	425	428	i	4	1	9		
Spare Calibration Ch 2 Zeroth Order Term	429	432	i	4	1	6		
Spare Calibration Ch 3 Second Order Term	433	436	i	4	1	12		
Spare Calibration Ch 3 First Order Term	437	440	i	4	1	9		
Spare Calibration Ch 3 Zeroth Order Term	441	444	i	4	1	6		
Spare Calibration Ch 13 Second Order Term	445	448	i	4	1	12		
Spare Calibration Ch 13 First Order Term	449	452	i	4	1	9		
Spare Calibration Ch 13 Zeroth Order Term	453	456	i	4	1	6		
Spare Calibration Ch 4 Second Order Term	457	460	i	4	1	12		
Spare Calibration Ch 4 First Order Term	461	464	i	4	1	9		
Spare Calibration Ch 4 Zeroth Order Term	465	468	i	4	1	6		
Spare Calibration Ch 18 Second Order Term	469	472	i	4	1	12		
Spare Calibration Ch 18 First Order Term	473	476	i	4	1	9		
Spare Calibration Ch 18 Zeroth Order Term	477	480	i	4	1	6		
Spare Calibration Ch 11 Second Order Term	481	484	i	4	1	12		
Spare Calibration Ch 11 First Order Term	485	488	i	4	1	9		
Spare Calibration Ch 11 Zeroth Order Term	489	492	i	4	1	6		
Spare Calibration Ch 19 Second Order Term	493	496	i	4	1	12		
Spare Calibration Ch 19 First Order Term	497	500	i	4	1	9		
Spare Calibration Ch 19 Zeroth Order Term	501	504	i	4	1	6		
Spare Calibration Ch 7 Second Order Term	505	508	i	4	1	12		
Spare Calibration Ch 7 First Order Term	509	512	i	4	1	9		
Spare Calibration Ch 7 Zeroth Order Term	513	516	i	4	1	6		
Spare Calibration Ch 8 Second Order Term	517	520	i	4	1	12		
Spare Calibration Ch 8 First Order Term	521	524	i	4	1	9		
Spare Calibration Ch 8 Zeroth Order Term	525	528	i	4	1	6		
Spare Calibration Ch 20 Second Order Term	529	532	i	4	1	12		
Spare Calibration Ch 20 First Order Term	533	536	i	4	1	9		
Spare Calibration Ch 20 Zeroth Order Term	537	540	i	4	1	6		
Spare Calibration Ch 10 Second Order Term	541	544	i	4	1	12		
Spare Calibration Ch 10 First Order Term	545	548	i	4	1	9		
Spare Calibration Ch 10 Zeroth Order Term	549	552	i	4	1	6		
Spare Calibration Ch 14 Second Order Term	553	556	i	4	1	12		
Spare Calibration Ch 14 First Order Term	557	560	i	4	1	9		
Spare Calibration Ch 14 Zeroth Order Term	561	564	i	4	1	6		
Spare Calibration Ch 6 Second Order Term	565	568	i	4	1	12		
Spare Calibration Ch 6 First Order Term	569	572	i	4	1	9		

Spare Calibration Ch 6 Zeroth Order Term	573	576	i	4	1	6		
Spare Calibration Ch 5 Second Order Term	577	580	i	4	1	12		
Spare Calibration Ch 5 First Order Term	581	584	i	4	1	9		
Spare Calibration Ch 5 Zeroth Order Term	585	588	i	4	1	6		
Spare Calibration Ch 15 Second Order Term	589	592	i	4	1	12		
Spare Calibration Ch 15 First Order Term	593	596	i	4	1	9		
Spare Calibration Ch 15 Zeroth Order Term	597	600	i	4	1	6		
Spare Calibration Ch 12 Second Order Term	601	604	i	4	1	12		
Spare Calibration Ch 12 First Order Term	605	608	i	4	1	9		
Spare Calibration Ch 12 Zeroth Order Term	609	612	i	4	1	6		
Spare Calibration Ch 16 Second Order Term	613	616	i	4	1	12		
Spare Calibration Ch 16 First Order Term	617	620	i	4	1	9		
Spare Calibration Ch 16 Zeroth Order Term	621	624	i	4	1	6		
Spare Calibration Ch 9 Second Order Term	625	628	i	4	1	12		
Spare Calibration Ch 9 First Order Term	629	632	i	4	1	9		
Spare Calibration Ch 9 Zeroth Order Term	633	636	i	4	1	6		
NAVIGATION								
Computed Yaw Steering (<i>MetOp: contend definded below</i>) or <Zero Fill> (NOAA)	637	642	i	2	3	0	degrees	
Total Applied Attitude Correction Word 1: Roll Word 2: Pitch Word 3: Yaw	643	648	i	2	3	3	degrees	

<p>Navigation Status Bit Field (<i>content, defined below, depends on origin of data, either NOAA or Metop</i>) <i>For NOAA Data:</i> bits 31-18: <zero fill> bit 17: earth location at the satellite subpoint is accurate and reasonable, i.e., is within tolerance defined by "Nadir Earth Location Tolerance" in header (0=out of tolerance; 1=in tolerance) bit 16: Euler error angles from the CPU telemetry used by AELDS to correct the earth locations (0=FALSE; 1=TRUE) bits 15-12: earth location indicator (0=earth location available; 1=first scan whose time is more than 24 hours older than the time [epoch] of the user ephemeris file; 2=no earth location available) bits 11-8: spacecraft attitude control (0=operating in YGC or NOMINAL mode and attitude is good; 1=operating in another mode but attitude is good; 2=operating in YGC or NOMINAL mode but tests are being conducted which may cause attitude to exceed nominal tolerance; 3=operating in another mode while tests are being conducted which may cause attitude to exceed nominal tolerance) bits 7-4: attitude SMODE (0=nominal mode; 1=rate nulling mode; 2=YGC mode; 3=search mode; 4=coast mode) bits 3-0: attitude PWTIP\$AC (0=nominal mode/no test; 1=yaw axis test in progress; 2=roll axis test in progress; 3=pitch axis test in progress) <i>For Metop Data:</i> bits 31-21: <zero fill> bit 20-19: yaw steering parameters usage indicator (0=no yaw steering correction; 1=measured angles from the Metop SVM telemetry; 2=computed angles from AELDS; 3=measured angles + computed angles) bit 18: Metop maneuver indicator (0=scan does not occur during a Metop in-plane or out-of-plane maneuver; 1=scan, or some part of it, occurs during a maneuver) bit 17: <same as defined for NOAA, above> bit 16: <zero fill> bits 15-12: <same as defined for NOAA, above> bits 11-8: <zero fill> bits 7-4: OPM PF sub-mode (0=fine pointing mode (FPM); 1=yaw steering mode (YSM)) bits 3-0: SVM PF mode (0=LHM; 1=RRM; 2=CAM; 3=FAM1; 4=FAM2; 5=FAM3; 6=OPM; 7=OCM1; 8=OCM2; 9=OCMT; 10=OCM0)</p>	649	652	u	4	1	0		
Time Associated with Euler Angles	653	656	i	4	1	0	seconds	
Euler Angles (<i>NOAA, from TIP CPU telemetry near end of scan; MetOp [in FPM] from SVM telemetry just before start of scan</i>) or Yaw Steering Parameters (<i>MetOp [in YSM], from SVM telemetry or AELDS near nadir of scan</i>) Word 1: Roll Word 2: Pitch Word 3: Yaw	657	662	i	2	3	3	degrees	
Spacecraft Altitude above Reference Ellipsoid	663	664	u	2	1	1	km	

Angular Relationships (<i>relative azimuth range +/- 180.00 degrees</i>) Word 1: Solar zenith angle, FOV 1 Word 2: Satellite zenith angle, FOV 1 Word 3: Relative azimuth angle, FOV 1 Word 4: Solar zenith angle, FOV 2 ... (set of 3 angles every FOV) ... Word 168: Relative azimuth angle, FOV56	665	1000	i	2	168	2	degrees	
Earth Location (<i>north latitude and east longitude are positive</i>) Word 1: Latitude, FOV 1 Word 2: Longitude, FOV 1 Word 3: Latitude, FOV 2 ... (lat/lon word pair every FOV) ... Word 112: Longitude, FOV 56	1001	1448	i	4	112	4	degrees	
Lunar Angle (<i>angle between moon and space view; only applicable for the space view scan, otherwise, undefined; range 0 to 180.00 degrees</i>)	1449	1450	u	2	1	2	degrees	
HIRS DATA ELEMENTS								
Header for Element 0 (<i>same format through element 63</i>) bits 31-24: scan encoder position bits 23-19: electronic cal level indicator bits 18-13: <zero fill> bits 12-7: channel 1 period monitor bits 6-1: element number bit 0: filter sync designator	1457	1460	u	4	1	0		
Radiometric Data for Element 0 (<i>same format through element 55</i>) Word 1: Channel 1 bits 15-13: <zero fill> bits 12-0: 13-bit data <i>Words 2-20: Channels 17, 2, 3, 13, 4, 18, 11, 19, 7, 8, 20, 10, 14, 6, 5, 15, 12, 16, 9 (in order)</i>	1461	1500	u	2	20	0	counts	2
Bit Flags for Element 0 (same format through element 63) bit 15: valid data flag (0=ignore data; 1=good data) bit 14: odd bit parity bits 13-0: <zero fill>	1501	1502	u	2	1	0		
<zero fill>	1503	1504	i	2	1	0		
Header for Element 1	1505	1508	u	4	1	0		
Radiometric Data for Element 1	1509	1548	u	2	20	0	counts	
Bit Flags for Element 1	1549	1550	u	2	1	0		
<zero fill>	1551	1552	i	2	1	0		
Header for Element 2	1553	1556	u	4	1	0		

Radiometric Data for Element 2	1557	1596	u	2	20	0	counts	
Bit Flags for Element 2	1597	1598	u	2	1	0		
<zero fill>	1599	1600	i	2	1	0		
Header for Element 3	1601	1604	u	4	1	0		
Radiometric Data for Element 3	1605	1644	u	2	20	0	counts	
Bit Flags for Element 3	1645	1646	u	2	1	0		
<zero fill>	1647	1648	i	2	1	0		
Header for Element 4	1649	1652	u	4	1	0		
Radiometric Data for Element 4	1653	1692	u	2	20	0	counts	
Bit Flags for Element 4	1693	1694	u	2	1	0		
<zero fill>	1695	1696	i	2	1	0		
Header for Element 5	1697	1700	u	4	1	0		
Radiometric Data for Element 5	1701	1740	u	2	20	0	counts	
Bit Flags for Element 5	1741	1742	u	2	1	0		
<zero fill>	1743	1744	i	2	1	0		
Header for Element 6	1745	1748	u	4	1	0		
Radiometric Data for Element 6	1749	1788	u	2	20	0	counts	
Bit Flags for Element 6	1789	1790	u	2	1	0		
<zero fill>	1791	1792	i	2	1	0		
Header for Element 7	1793	1796	u	4	1	0		
Radiometric Data for Element 7	1797	1836	u	2	20	0	counts	
Bit Flags for Element 7	1837	1838	u	2	1	0		
<zero fill>	1839	1840	i	2	1	0		
Header for Element 8	1841	1844	u	4	1	0		
Radiometric Data for Element 8	1845	1884	u	2	20	0	counts	
Bit Flags for Element 8	1885	1886	u	2	1	0		
<zero fill>	1887	1888	i	2	1	0		
Header for Element 9	1889	1892	u	4	1	0		
Radiometric Data for Element 9	1893	1932	u	2	20	0	counts	
Bit Flags for Element 9	1933	1934	u	2	1	0		
<zero fill>	1935	1936	i	2	1	0		
Header for Element 10	1937	1940	u	4	1	0		
Radiometric Data for Element 10	1941	1980	u	2	20	0	counts	
Bit Flags for Element 10	1981	1982	u	2	1	0		
<zero fill>	1983	1984	i	2	1	0		
Header for Element 11	1985	1988	u	4	1	0		
Header for Element 11	1985	1988	u	4	1	0		
Bit Flags for Element 11	2029	2030	u	2	1	0		
<zero fill>	2031	2032	i	2	1	0		
Header for Element 12	2033	2036	u	4	1	0		
Radiometric Data for Element 12	2037	2076	u	2	20	0	counts	
Bit Flags for Element 12	2077	2078	u	2	1	0		
Header for Element 13	2081	2084	u	4	1	0		
Radiometric Data for Element 13	2085	2124	u	2	20	0	counts	

Bit Flags for Element 13	2125	2126	u	2	1	0		
<zero fill>	2127	2128	i	2	1	0		
Header for Element 14	2129	2132	u	4	1	0		
Radiometric Data for Element 14	2133	2172	u	2	20	0	counts	
Bit Flags for Element 14	2173	2174	u	2	1	0		
<zero fill>	2175	2176	i	2	1	0		
Header for Element 15	2177	2180	u	4	1	0		
Radiometric Data for Element 15	2181	2220	u	2	20	0	counts	
Bit Flags for Element 15	2221	2222	u	2	1	0		
<zero fill>	2223	2224	i	2	1	0		
Header for Element 16	2225	2228	u	4	1	0		
Radiometric Data for Element 16	2229	2268	u	2	20	0	counts	
Bit Flags for Element 16	2269	2270	u	2	1	0		
<zero fill>	2271	2272	i	2	1	0		
Header for Element 17	2273	2276	u	4	1	0		
Radiometric Data for Element 17	2277	2316	u	2	20	0	counts	
Bit Flags for Element 17	2317	2318	u	2	1	0		
<zero fill>	2319	2320	i	2	1	0		
Header for Element 18	2321	2324	u	4	1	0		
Radiometric Data for Element 18	2325	2364	u	2	20	0	counts	
Bit Flags for Element 18	2365	2366	u	2	1	0		
<zero fill>	2367	2368	i	2	1	0		
Header for Element 19	2369	2372	u	4	1	0		
Radiometric Data for Element 19	2373	2412	u	2	20	0	counts	
Bit Flags for Element 19	2413	2414	u	2	1	0		
<zero fill>	2415	2416	i	2	1	0		
Header for Element 20	2417	2420	u	4	1	0		
Radiometric Data for Element 20	2421	2460	u	2	20	0	counts	
Bit Flags for Element 20	2461	2462	u	2	1	0		
<zero fill>	2463	2464	i	2	1	0		
Header for Element 21	2465	2468	u	4	1	0		
Radiometric Data for Element 21	2469	2508	u	2	20	0	counts	
Bit Flags for Element 21	2509	2510	u	2	1	0		
<zero fill>	2511	2512	i	2	1	0		
Header for Element 22	2513	2516	u	4	1	0		
Radiometric Data for Element 22	2517	2556	u	2	20	0	counts	
Bit Flags for Element 22	2557	2558	u	2	1	0		
<zero fill>	2559	2560	i	2	1	0		
Header for Element 23	2561	2564	u	4	1	0		
Radiometric Data for Element 23	2565	2604	u	2	20	0	counts	
Bit Flags for Element 23	2605	2606	u	2	1	0		
<zero fill>	2607	2608	i	2	1	0		
Header for Element 24	2609	2612	u	4	1	0		
Radiometric Data for Element 24	2613	2652	u	2	20	0	counts	

Bit Flags for Element 24	2653	2654	u	2	1	0		
<zero fill>	2655	2656	i	2	1	0		
Header for Element 25	2657	2660	u	4	1	0		
Radiometric Data for Element 25	2661	2700	u	2	20	0	counts	
Bit Flags for Element 25	2701	2702	u	2	1	0		
<zero fill>	2703	2704	i	2	1	0		
Header for Element 26	2705	2708	u	4	1	0		
Radiometric Data for Element 26	2709	2748	u	2	20	0	counts	
Bit Flags for Element 26	2749	2750	u	2	1	0		
<zero fill>	2751	2752	i	2	1	0		
Header for Element 27	2753	2756	u	4	1	0		
Radiometric Data for Element 27	2757	2796	u	2	20	0	counts	
Bit Flags for Element 27	2797	2798	u	2	1	0		
<zero fill>	2799	2800	i	2	1	0		
Header for Element 28	2801	2804	u	4	1	0		
Radiometric Data for Element 28	2805	2844	u	2	20	0	counts	
Bit Flags for Element 28	2845	2846	u	2	1	0		
<zero fill>	2847	2848	i	2	1	0		
Header for Element 29	2849	2852	u	4	1	0		
Radiometric Data for Element 29	2853	2892	u	2	20	0	counts	
Bit Flags for Element 29	2893	2894	u	2	1	0		
<zero fill>	2895	2896	i	2	1	0		
Header for Element 30	2897	2900	u	4	1	0		
Radiometric Data for Element 30	2901	2940	u	2	20	0	counts	
Bit Flags for Element 30	2941	2942	u	2	1	0		
<zero fill>	2943	2944	i	2	1	0		
Header for Element 31	2945	2948	u	4	1	0		
Radiometric Data for Element 31	2949	2988	u	2	20	0	counts	
Bit Flags for Element 31	2989	2990	u	2	1	0		
<zero fill>	2991	2992	i	2	1	0		
Header for Element 32	2993	2996	u	4	1	0		
Radiometric Data for Element 32	2997	3036	u	2	20	0	counts	
Bit Flags for Element 32	3037	3038	u	2	1	0		
<zero fill>	3039	3040	i	2	1	0		
Header for Element 33	3041	3044	u	4	1	0		
Radiometric Data for Element 33	3045	3084	u	2	20	0	counts	
Bit Flags for Element 33	3085	3086	u	2	1	0		
<zero fill>	3087	3088	i	2	1	0		
Header for Element 34	3089	3092	u	4	1	0		
Radiometric Data for Element 34	3093	3132	u	2	20	0	counts	
Bit Flags for Element 34	3133	3134	u	2	1	0		
<zero fill>	3135	3136	i	2	1	0		
Header for Element 35	3137	3140	u	4	1	0		
Radiometric Data for Element 35	3141	3180	u	2	20	0	counts	

Bit Flags for Element 35	3181	3182	u	2	1	0		
<zero fill>	3183	3184	i	2	1	0		
Header for Element 36	3185	3188	u	4	1	0		
Radiometric Data for Element 36	3189	3228	u	2	20	0	counts	
Bit Flags for Element 36	3229	3230	u	2	1	0		
<zero fill>	3231	3232	i	2	1	0		
Header for Element 37	3233	3236	u	4	1	0		
Radiometric Data for Element 37	3237	3276	u	2	20	0	counts	
Bit Flags for Element 37	3277	3278	u	2	1	0		
<zero fill>	3279	3280	i	2	1	0		
Header for Element 38	3281	3284	u	4	1	0		
Radiometric Data for Element 38	3285	3324	u	2	20	0	counts	
Bit Flags for Element 38	3325	3326	u	2	1	0		
<zero fill>	3327	3328	i	2	1	0		
Header for Element 39	3329	3332	u	4	1	0		
Radiometric Data for Element 39	3333	3372	u	2	20	0	counts	
Bit Flags for Element 39	3373	3374	u	2	1	0		
<zero fill>	3375	3376	i	2	1	0		
Header for Element 40	3377	3380	u	4	1	0		
Radiometric Data for Element 40	3381	3420	u	2	20	0	counts	
Bit Flags for Element 40	3421	3422	u	2	1	0		
<zero fill>	3423	3424	i	2	1	0		
Header for Element 41	3425	3428	u	4	1	0		
Radiometric Data for Element 41	3429	3468	u	2	20	0	counts	
Bit Flags for Element 41	3469	3470	u	2	1	0		
<zero fill>	3471	3472	i	2	1	0		
Header for Element 42	3473	3476	u	4	1	0		
Radiometric Data for Element 42	3477	3516	u	2	20	0	counts	
Bit Flags for Element 42	3517	3518	u	2	1	0		
<zero fill>	3519	3520	i	2	1	0		
Header for Element 43	3521	3524	u	4	1	0		
Radiometric Data for Element 43	3525	3564	u	2	20	0	counts	
Bit Flags for Element 43	3565	3566	u	2	1	0		
<zero fill>	3567	3568	i	2	1	0		
Header for Element 44	3569	3572	u	4	1	0		
Radiometric Data for Element 44	3573	3612	u	2	20	0	counts	
Bit Flags for Element 44	3613	3614	u	2	1	0		
<zero fill>	3615	3616	i	2	1	0		
Header for Element 45	3617	3620	u	4	1	0		
Radiometric Data for Element 45	3621	3660	u	2	20	0	counts	
Bit Flags for Element 45	3661	3662	u	2	1	0		
<zero fill>	3663	3664	i	2	1	0		
Header for Element 46	3665	3668	u	4	1	0		
Radiometric Data for Element 46	3669	3708	u	2	20	0	counts	

Bit Flags for Element 46	3709	3710	u	2	1	0		
<zero fill>	3711	3712	i	2	1	0		
Header for Element 47	3713	3716	u	4	1	0		
Radiometric Data for Element 47	3717	3756	u	2	20	0	counts	
Bit Flags for Element 47	3757	3758	u	2	1	0		
<zero fill>	3759	3760	i	2	1	0		
Header for Element 48	3761	3764	u	4	1	0		
Radiometric Data for Element 48	3765	3804	u	2	20	0	counts	
Bit Flags for Element 48	3805	3806	u	2	1	0		
<zero fill>	3807	3808	i	2	1	0		
Header for Element 49	3809	3812	u	4	1	0		
Radiometric Data for Element 49	3813	3852	u	2	20	0	counts	
Bit Flags for Element 49	3853	3854	u	2	1	0		
<zero fill>	3855	3856	i	2	1	0		
Header for Element 50	3857	3860	u	4	1	0		
Radiometric Data for Element 50	3861	3900	u	2	20	0	counts	
Bit Flags for Element 50	3901	3902	u	2	1	0		
<zero fill>	3903	3904	i	2	1	0		
Header for Element 51	3905	3908	u	4	1	0		
Radiometric Data for Element 51	3909	3948	u	2	20	0	counts	
Bit Flags for Element 51	3949	3950	u	2	1	0		
<zero fill>	3951	3952	i	2	1	0		
Header for Element 52	3953	3956	u	4	1	0		
Radiometric Data for Element 52	3957	3996	u	2	20	0	counts	
Bit Flags for Element 52	3997	3998	u	2	1	0		
<zero fill>	3999	4000	i	2	1	0		
Header for Element 53	4001	4004	u	4	1	0		
Radiometric Data for Element 53	4005	4044	u	2	20	0	counts	
Bit Flags for Element 53	4045	4046	u	2	1	0		
<zero fill>	4047	4048	i	2	1	0		
Header for Element 54	4049	4052	u	4	1	0		
Radiometric Data for Element 54	4053	4092	u	2	20	0	counts	
Bit Flags for Element 54	4093	4094	u	2	1	0		
<zero fill>	4095	4096	i	2	1	0		
Header for Element 55	4097	4100	u	4	1	0		
Radiometric Data for Element 55	4101	4140	u	2	20	0	counts	
Bit Flags for Element 55	4141	4142	u	2	1	0		
<zero fill>	4143	4144	i	2	1	0		
Header for Element 56	4145	4148	u	4	1	0		
Positive Calibration Word 1: Channel 1 Words 2-20: Channels 17, 2, 3, 13, 4, 18, 11, 19, 7, 8, 20, 10, 14, 6, 5, 15, 12, 16, 9 (in order)	4149	4188	u	2	20	0	counts	
Bit Flags for Element 56	4189	4190	u	2	1	0		
<zero fill>	4191	4192	i	2	1	0		

Header for Element 57	4193	4196	u	4	1	0		
Negative Calibration Word 1: Channel 1 Words 2-20: Channels 17, 2, 3, 13, 4, 18, 11, 19, 7, 8, 20, 10, 14, 6, 5, 15, 12, 16, 9 (in order)	4197	4236	u	2	20	0	counts	
Bit Flags for Element 57	4237	4238	u	2	1	0		
<zero fill>	4239	4240	i	2	1	0		
Header for Element 58	4241	4244	u	4	1	0		
Internal Warm Target, Temperature Sensor #1 (Zero fill in commanded position modes) Word 1: Reading 1 ... Word 5: Reading 5	4245	4254	i	2	5	0	counts	
Internal Warm Target, Temperature Sensor #2 (Zero fill in commanded position modes) Word 1: Reading 1 ... Word 5: Reading 5	4255	4264	i	2	5	0	counts	
Internal Warm Target, Temperature Sensor #3 (Zero fill in commanded position modes) Word 1: Reading 1 ... Word 5: Reading 5	4265	4274	i	2	5	0	counts	
Internal Warm Target, Temperature Sensor #4 (Zero fill in commanded position modes) Word 1: Reading 1 ... Word 5: Reading 5	4275	4284	i	2	5	0	counts	
Bit Flags for Element 58	4285	4286	u	2	1	0		
Bit Flags for Element 58	4285	4286	u	2	1	0		
Header for Element 59	4289	4292	u	4	1	0		
Internal Cold Target, Temperature Sensor #1 (Zero fill in commanded position modes) Word 1: Reading 1 ... Word 5: Reading 5	4293	4302	i	2	5	0	counts	
Internal Cold Target, Temperature Sensor #2 (NOAA- KLM) Analog Ground 3 (NOAA-N,N' and MetOp) (Zero fill in commanded position modes) Word 1: Reading 1 ... Word 5: Reading 5	4303	4312	i	2	5	0	counts	

Internal Cold Target, Temperature Sensor #3 (NOAA-KLM) Internal Warm Target, Temperature Sensor #5 (NOAA-N,N' and MetOp) (Zero fill in commanded position modes) Word 1: Reading 1 ... Word 5: Reading 5	4313	4322	i	2	5	0	counts	
Internal Cold Target, Temperature Sensor #4 (NOAA-KLM) Tertiary Telescope Temperature Sensor (NOAA-N,N' and MetOp) (Zero fill in commanded position modes) Word 1: Reading 1 ... Word 5: Reading 5	4323	4332	i	2	5	0	counts	
Bit Flags for Element 59	4333	4334	u	2	1	0		
<zero fill>	4335	4336	i	2	1	0		
Header for Element 60	4337	4340	u	4	1	0		
Filter Wheel Housing, Temperature Sensor #1 Word 1: Reading 1 ... Word 5: Reading 5	4341	4350	i	2	5	0	counts	
Filter Wheel Housing, Temperature Sensor #2 Word 1: Reading 1 ... Word 5: Reading 5	4351	4360	i	2	5	0	counts	
Filter Wheel Housing, Temperature Sensor #3 Word 1: Reading 1 ... Word 5: Reading 5	4361	4370	i	2	5	0	counts	
Filter Wheel Housing, Temperature Sensor #3 Word 1: Reading 1 ... Word 5: Reading 5	4361	4370	i	2	5	0	counts	
Bit Flags for Element 60	4381	4382	u	2	1	0		
Bit Flags for Element 60	4381	4382	u	2	1	0		
<zero fill>	4383	4384	i	2	1	0		
Header for Element 61	4385	4388	u	4	1	0		
Patch Temperature (Expanded Scale) Word 1: Reading 1 ... Word 5: Reading 5	4389	4398	i	2	5	0	counts	
First Stage Radiator Temperature Sensor Word 1: Reading 1 ... Word 5: Reading 5	4399	4408	i	2	5	0	counts	

Filter Wheel Housing Heater Current Word 1: Reading 1 ... Word 5: Reading 5	4409	4418	i	2	5	0	counts	
Electronic Calibration Digital to Analog Converter Word 1: Reading 1 ... Word 5: Reading 5	4419	4428	i	2	5	0	counts	
Bit Flags for Element 61	4429	4430	u	2	1	0		
<zero fill>	4431	4432	i	2	1	0		
Header for Element 62	4433	4436	u	4	1	0		
Scan Mirror Temperature	4437	4438	i	2	1	0	counts	
Primary Telescope Temperature	4439	4440	i	2	1	0	counts	
Secondary Telescope Temperature	4441	4442	i	2	1	0	counts	
Baseplate Temperature	4443	4444	i	2	1	0	counts	
Electronics Temperature	4445	4446	i	2	1	0	counts	
Patch Temperature Full Range	4447	4448	i	2	1	0	counts	
Scan Motor Temperature	4449	4450	i	2	1	0	counts	
Filter Wheel Motor Temperature	4451	4452	i	2	1	0	counts	
Cooler Housing Temperature	4453	4454	i	2	1	0	counts	
Patch Control Power	4455	4456	i	2	1	0	counts	
Scan Motor Current	4457	4458	i	2	1	0	counts	
Filter Motor Current	4459	4460	i	2	1	0	counts	
+15 VDC	4461	4462	i	2	1	0	counts	
-15 VDC	4463	4464	i	2	1	0	counts	
+7.5 VDC	4465	4466	i	2	1	0	counts	
-7.5 VDC	4467	4468	i	2	1	0	counts	
+10 VDC	4469	4470	i	2	1	0	counts	
+5 VDC	4471	4472	i	2	1	0	counts	
Analog Ground 1	4473	4474	i	2	1	0	counts	
Analog Ground 2	4475	4476	i	2	1	0	counts	
Bit Flags for Element 62	4477	4478	u	2	1	0		
<zero fill>	4479	4480	i	2	1	0		
Header for Element 63	4481	4484	u	4	1	0		
Line Counter (number of lines from the last auto calibration sequence)	4485	4486	u	2	1	0		
First Status Word bits 15-13: <zero fill> bits 12-8: instrument serial number bit 7: instrument (0=off; 1=on) bit 6: scan motor (0=on; 1=off) bit 5: filter wheel (0=on; 1=off) bit 4: electronics (0=off; 1=on) bit 3: cooler heat (0=on; 1=off) bit 2: internal warm target position (0=true; 1=false) bit 1: internal cold target position (0=true; 1=false) bit 0: space position (0=true; 1=false)	4487	4488	u	2	1	0		

Second Status Word bits 15-8: <zero fill> bit 7: nadir position (0=true; 1=false) bit 6: calibration (0=enabled; 1=disabled) bit 5: cooler door release (0=enabled; 1=disabled) bit 4: cooler door open (0=no; 1=yes) bit 3: cooler door closed (0=no; 1=yes) bit 2: filter housing heat (0=on; 1=off) bit 1: patch temperature control (0=on; 1=off) bit 0: filter motor power (0=high; 1=normal)	4489	4490	u	2	1	0		
Data Verification Binary Code Words 1-17: +3875, +1443, -1522, -1882, -1631, -1141, +1125, +3655, -2886, -3044, -3764, - 3262, -2283, -2251, +3214, +1676, +1992	4491	4524	u	2	17	0		
Bit Flags for Element 63	4525	4526	u	2	1	0		
<zero fill>	4527	4540	i	2	7	0		
DIGITAL B HOUSEKEEPING TELEMETRY								
Digital B Telemetry Update Flags (If bit = 0, associated telemetry item is up-to-date. If bit = 1, associated telemetry item was not updated during most recent telemetry cycle - possibly due to lost frame.) bit 15: instrument power bit 14: electronics power bit 13: filter motor power bit 12: scan motor power bit 11: cooler heater bit 10: filter housing heater bit 9: cooler door release bit 8: cooler window heater bit 7: go to nadir position bit 6: calibration sequence bit 5: cooler door closed bit 4: cooler door fully open bit 3: filter motor power level bit 2: patch temperature controller bits 1-0: <zero fill>	4541	4542	u	2	1	0		

Digital B Data bit 15: instrument power (0=off; 1=on) bit 14: electronics power (0=off; 1=on) bit 13: filter motor power (0=off; 1=on) bit 12: scan motor power (0=off; 1=on) bit 11: cooler heater (0=off; 1=on) bit 10: filter housing heater (0=off; 1=on) bit 9: cooler door release (0=disabled; 1=enabled) bit 8: cooler window heater (0=on; 1=off) bit 7: go to nadir position (0=no; 1=yes/initiated) bit 6: calibration sequence (0=disabled; 1=enabled) bit 5: cooler door closed (0=yes; 1=no) bit 4: cooler door fully open (0=yes; 1=no) bit 3: filter motor power level (0=normal; 1=high) bit 2: patch temperature controller (0=off; 1=on) bits 1-0: <zero fill>	4543	4544	u	2	1	0		
ANALOG HOUSEKEEPING TELEMETRY								
Analog Telemetry Update Flags (If bit = 0, associated telemetry item is up-to-date. If bit = 1, associated telemetry item was not updated during most recent telemetry cycle - possibly due to lost frame.) bits 31-17: <zero fill> bit 16: patch controller power bit 15: scan motor current bit 14: filter wheel motor current bit 13: -15 VDC monitor bit 12: +15 VDC monitor bit 11: -7.5 VDC TLM/DC/DC conv. bit 10: +7.5 VDC TLM/DC/DC conv. bit 9: +10V VDC TLM/DC/DC conv. bit 8: +5 VDC monitor bit 7: filter wheel motor temperature bit 6: scan motor temperature bit 5: filter housing controller current bit 4: patch temperature bit 3: electronics temperature bit 2: base plate temperature bit 1: radiator temperature bit 0: <zero fill>	4545	4548	u	4	1	0		
Radiator Temperature (range: 0 - 255)	4549	4549	u	1	1	0	counts	
Base Plate Temperature (range: 0 - 255)	4550	4550	u	1	1	0	counts	
Electronics Temperature (range: 0 - 255)	4551	4551	u	1	1	0	counts	
Patch Temperature (range: 0 - 255)	4552	4552	u	1	1	0	counts	
Filter Housing Controller Current (range: 0 - 255)	4553	4553	u	1	1	0	counts	
Scan Motor Temperature (range: 0 - 255)	4554	4554	u	1	1	0	counts	
Filter Wheel Motor Temperature (range: 0 - 255)	4555	4555	u	1	1	0	counts	
+5 VDC Monitor (range: 0 - 255)	4556	4556	u	1	1	0	counts	
+10V VDC TLM/DC/DC Conv. (range: 0 - 255)	4557	4557	u	1	1	0	counts	
+7.5 VDC TLM/DC/DC Conv. (range: 0 - 255)	4558	4558	u	1	1	0	counts	
-7.5 VDC TLM/DC/DC Conv. (range: 0 - 255)	4559	4559	u	1	1	0	counts	

+15 VDC Monitor (range: 0 - 255)	4560	4560	u	1	1	0	counts	
-15 VDC Monitor (range: 0 - 255)	4561	4561	u	1	1	0	counts	
Filter Wheel Motor Current (range: 0 - 255)	4562	4562	u	1	1	0	counts	
Scan Motor Current (range: 0 - 255)	4563	4563	u	1	1	0	counts	
Patch Controller Power (range: 0 - 255)	4564	4564	u	1	1	0	counts	
FILLER								
<zero fill>	4565	4608	i	4	11	0		

NOTES:

- 1) The interpretation of the HIRS data is dependent on the element in which it resides. Each 13-bit HIRS word in the 56 FOVs (elements 0-55) is stored in the least significant 13 bits of a 2-byte word. Therefore, bits 15-13 are zero fill, bit 12 is the HIRS inverted sign bit, and bits 11-0 is the radiant signal amplitude. However, if the HIRS word is negative, bits 11-0 are in a "two's complement-like" form (see description in "Radiometric Data for Element 0"). Each 13-bit HIRS word in the remaining 8 elements (56-63) that represents a value (i.e., not packed bit flags and fields) is "unpacked" into a 2-byte word. Therefore, bit 15 is the sign bit (not inverted) and bits 14-0 is the magnitude of the value (in two's complement form if the value is negative).
- 2) To unpack a channel's 2-byte, radiometric reading, subtract 4,096 from it--i.e., "u = p - 4096", where 'p' is the channel's reading as stored in the Level 1b (described below), and 'u' is the unpacked reading.
- 3) Anomalous is defined as the absolute value (mean - median) > NEDC where mean and median are after 3 sigma filtering. The channel calibration quality flags for earth views for each channel will be inherited from the flags in the space and blackbody view scan lines.
- 4) This is triggered if bit 4, 3, or 0 in channel calibration quality flag is set for any IR channel.

8.3.1.6 AMSU-A Data Sets

This section describes the characteristics and formats of Advanced Microwave Sounding Unit-A (AMSU-A) data sets for both NOAA KLM (version 2) and NOAA-N (version 3) satellites. Version 2 formats (v2) were used on all NOAA KLM data until April 28, 2005, after which version 3 format (v3), also known as the NOAA-N format, was in effect for all operational POES spacecraft until January 25, 2006. After January 25, 2006, the version 4 was implemented to reflect the inclusion of cloud mask information.

8.3.1.6.1 Data Characteristics

Table 8.3.1.6.1-1 summarizes fundamental characteristics of the data.

Table 8.3.1.6.1-1. AMSU-A Data Characteristics.	
Parameter	Value
Sample word size	16 bits
Number of sampled channels/available channels	15/15
Number of Earth samples per scan	30 per channel
Scan rate	7.5 scans per minute
Scan direction	West to East (northbound)
Instantaneous Field of View (IFOV)	3.3 degrees (all channels)

Spatial resolution at nadir	48 km at 833 km altitude
Cross track distance between sample centers at nadir	48 km at 833 km altitude
Along track distance between sample centers at nadir	52.7 km at 833 km altitude
Cross-track scan coverage	± 50 degrees from nadir
Swath width	2069.6 km at 833 km altitude

8.3.1.6.2 Header Records

The Data Set Header Record contains quality, navigation, calibration and conversion coefficient information which applies to the AMSU-A data records which follow. This section describes the header records for both NOAA KLM (Version 2) and NOAA-N (Version 3) satellites. Version 2 was in effect on all NOAA KLM data until April 28, 2005, then version 3 format (v3), also known as the NOAA-N format, was in effect for all operational POES spacecraft until January 25, 2006. After January 25, 2006 the format was changed to version 4 to reflect the inclusion of cloud mask information.

8.3.1.6.2.1 NOAA KLM Format (Version 2, pre-April 28, 2005)

The AMSU-A Data Set Header Record format (version 2, pre-April 28, 2005) is documented in Table 8.3.1.6.2.1-1. See the legend in Section 8.3.1.1 for further explanation of the headings on this table.

Field Name	Start Octet	End Octet	Data Type	Word Size	Number of Words	Scale Factor	Units	Notes
FILE IDENTIFICATION								
Data Set Creation Site ID CMS=Centre de Meteorologie Spatiale/France DSS=Dundee Satellite Receiving Station/UK NSS=National Environmental Satellite, Data and Information Service/USA UKM=United Kingdom Meteorological Office/UK <ASCII blank = x20>	1	3	c	3	1	0		
Level 1b Format Version Number	4	4	c	1	1	0		
Level 1b Format Version Year (<i>four digits, e.g., 2000</i>)	5	6	u	2	1	0		
Level 1b Format Version Day of Year (<i>e.g., 365</i>)	7	8	u	2	1	0		
<Reserved for Logical Record Length> (<i>For Creation Site use only. Logical Record Length of source 1b data set prior to processing.</i>)	9	10	u	2	1	0	octets	
<Reserved for Block Size> (<i>For Creation Site use only. Block Size of source 1b data set prior to processing.</i>)	11	12	u	2	1	0	octets	
Count of Header Records in this Data Set	13	14	u	2	1	0		
<Zero Fill>	15	16	u	2	1	0		
Data Set Name	17	22	i	2	3	0		
Processing Block Identification	23	64	c	42	1	0		
	65	72	c	8	1	0		

Spacecraft Identification Code 2=NOAA-16 4=NOAA-15 6=NOAA-17 7=NOAA-18 8=NOAA-N' 11=Metop-1 12=Metop-A 13=Metop-3	73	74	u	2	1	0		
Instrument ID <i>Word 1: AMSU-A2 ID Number</i> 6=protoflight model (PFM), s/n 102 (NOAA-15) 10=flight model (FM) 1, s/n 103 (NOAA-16) 14=FM 2, s/n 104 (NOAA-17) 18=FM 3, s/n 105 (NOAA-18) 30=FM 6, s/n 108 (Metop-A) <i>Word 2: AMSU-A1 ID Number</i> 5=PFM, s/n 102 (NOAA-16) 9=FM 1, s/n 103 (NOAA-15) 13=FM 2, s/n 104 (NOAA-17) 21=FM 4, s/n 106 (Metop-A) 33=FM 7, s/n 109 (NOAA-18) Data Type Code 10=AMSU-A TIP Source Code (NOAA: values defined below) or <Zero Fill> (Metop) 0=unused, i.e., GAC/HRPT/LAC data 1=GAC-embedded AMSU and TIP 2=stored TIP (STIP) 3=HRPT/LAC-embedded AMSU and TIP 4=stored AIP (SAIP)	75	76	u	1	2	0		
	77	78	u	2	1	0		
	79	80	u	2	1	0		
Start of Data Set Day Count starting from 0 at 00h, 1 Jan 1950	81	84	u	4	1	0		
Start of Data Set Year (four digits, e.g., 2000)	85	86	u	2	1	0		
Start of Data Set Day of Year (e.g., 365)	87	88	u	2	1	0		
Start of Data Set UTC Time of Day	89	92	u	4	1	0	milliseconds	
End of Data Set Day Count starting from 0 at 00h, 1 Jan 1950	93	96	u	4	1	0		
End of Data Set Year (four digits, e.g., 2000)	97	98	u	2	1	0		
End of Data Set Day of Year (e.g., 365)	99	100	u	2	1	0		
End of Data Set UTC Time of Day	101	104	u	4	1	0	milliseconds	
Year of Last CPIDS Update (four digits, e.g., 2000)	105	106	u	2	1	0		
Day of Year of Last CPIDS Update (e.g., 365)	107	108	u	2	1	0		
Offset between Start of Scan and Center of First FOV	109	110	i	2	1	0	milliseconds	
<Zero Fill>	111	120	i	2	5	0		
DATA SET QUALITY INDICATORS								

Instrument Status A2 (<i>see "Digital B Telemetry for AMSU-A2" field in data record</i>) bits 31-15: <zero fill> bit 14: cold cal position, msb bit 13: cold cal position, lsb bit 12: antenna in nadir position (0=no; 1=yes) bit 11: antenna in cold cal position (0=no; 1=yes) bit 10: antenna in warm cal position (0=no; 1=yes) bit 9: full scan mode (0=no; 1=yes) bits 5-8: <zero fill> bit 4: survival heater (0=off; 1=on) bit 3: module power (0=disconnect; 1=connect) bit 2: compensator motor (0=off; 1=on) bit 1: scanner A2 power (0=off; 1=on) bit 0: <zero fill>	121	124	u	4	1	0		
<Zero Fill>	125	126	i	2	1	0		
Record Number of Status Change of A2 (<i>if 0, none occurred</i>)	127	128	u	2	1	0		
Second Instrument Status A2 (<i>if previous word is 0, no change</i>)	129	132	u	4	1	0		
Instrument Status A1 (<i>see "Digital B Telemetry for AMSU-A1" field in data record</i>) bits 31-15: <zero fill> bit 14: cold cal position, msb bit 13: cold cal position, lsb bit 12: antenna in nadir position (0=no; 1=yes) bit 11: antenna in cold cal position (0=no; 1=yes) bit 10: antenna in warm cal position (0=no; 1=yes) bit 9: full scan mode (0=no; 1=yes) bits 8-6: <zero fill> bit 5: module power (0=disconnect; 1=connect) bit 4: survival heater (0=off; 1=on) bit 3: phase lock loop (0=redundant; 1=primary) bit 2: scanner A1-2 power (0=off; 1=on) bit 1: scanner A1-1 power (0=off; 1=on) bit 0: <zero fill>	133	136	u	4	1	0		
<Zero Fill>	137	138	i	2	1	0		
Record Number of Status Change of A1 (<i>if 0, none occurred</i>)	139	140	u	2	1	0		
Second Instrument Status A1 (<i>if previous word is 0, no change</i>)	141	144	u	4	1	0		
Count of Data Records in this Data Set	145	146	u	2	1	0		
Count of Calibrated, Earth Located Scan Lines in this Data Set	147	148	u	2	1	0		
Count of Missing Scan Lines	149	150	u	2	1	0		
Count of Data Gaps in this Data Set	151	152	u	2	1	0		
Count of Data Frames Without Frame Sync Word Errors	153	154	u	2	1	0		
Count of PACS Detected TIP Parity Errors	155	156	u	2	1	0		
Sum of All Auxiliary Sync Errors Detected in the Input Data	157	158	u	2	1	0		

Time Sequence Error 0=none; otherwise, the record number of the first occurrence	159	160	u	2	1	0		
Time Sequence Error Code (<i>These are bit flags taken from "Scan Line Quality Flags [Time Problem Code]" on data record reported in "Time Sequence Error" field above. If a bit is on (=1) then the statement is true.</i>) bits 15-8: <zero fill> bit 7: time field is bad but can probably be inferred from the previous good time bit 6: time field is bad and can't be inferred from the previous good time bit 5: this record starts a sequence that is inconsistent with previous times (i.e., there is a time discontinuity); may be associated with a spacecraft clock update bit 4: start of a sequence that apparently repeats scan times that have been previously accepted bits 3-0: <zero fill>	161	162	u	2	1	0		
SOCC Clock Update Indicator 0=none during this orbit; otherwise, the record number of the first occurrence	163	164	u	2	1	0		
Earth Location Error Indicator 0=none during this orbit; otherwise, the record number of the first occurrence	165	166	u	2	1	0		
Earth Location Error Code (<i>These are bit flags taken from "Scan Line Quality Flags [Earth Location Problem Code]" on data record reported in "Earth Location Error Indicator" field above. If a bit is on (=1) then the statement is true.</i>) bits 15-8: <zero fill> bit 7: not earth located because of bad time; earth location fields zero-filled bit 6: earth location questionable: questionable time code bit 5: earth location questionable: marginal agreement with reasonableness check bit 4: earth location questionable: fails reasonableness check bit 3: earth location questionable because of antenna position check bit 2: <zero fill> bit 1: earth location questionable: satellite in-plane maneuver (Metop) or <zero fill> (NOAA) bit 0: earth location questionable: satellite out-of-plane maneuver (Metop) or <zero fill> (NOAA)	167	168	u	2	1	0		
PACS Status Bit Field bits 15-3: <zero fill> bit 2: pseudonoise (0=normal data; 1=pseudonoise data) bit 1: tape direction (0=reverse playback, time decrementing) bit 0: data mode (0=test data; 1=flight data)	169	170	u	2	1	0		

Data Source 0=unused 1=Fairbanks, AK 2=Wallops Is., VA 3=SOCC 4=Svalbard, Norway 5=Monterey, CA	171	172	u	2	1	0		
<Zero Fill>	173	176	i	4	1	0		
<Reserved for the Ingestor>	177	184	c	8	1	0		
<Reserved for Decommuation>	185	192	c	8	1	0		
<Zero Fill>	193	208	i	4	4	0		
CALIBRATION								
<Zero Fill>	209	210	i	2	1	0		
Instrument Temperature Sensor ID Word 1: 0=RF Shelf A1-1; 1=RF Mux A1-1 Word 2: 0=RF Shelf A1-2; 1=RF Mux A1-2 Word 3: 0=RF Shelf A2; 1=RF Mux/Diplexer A2	211	216	u	2	3	0		2
RF Shelf A1-1 Minimum Reference Temperature, PLLO#1	217	218	i	2	1	2	K	
RF Shelf A1-1 Nominal Reference Temperature, PLLO#1	219	220	i	2	1	2	K	
RF Shelf A1-1 Maximum Reference Temperature, PLLO#1	221	222	i	2	1	2	K	
RF Shelf A1-2 Minimum Reference Temperature	223	224	i	2	1	2	K	
RF Shelf A1-2 Nominal Reference Temperature	225	226	i	2	1	2	K	
RF Shelf A1-2 Maximum Reference Temperature	227	228	i	2	1	2	K	
RF Shelf A2 Minimum Reference Temperature	229	230	i	2	1	2	K	
RF Shelf A2 Nominal Reference Temperature	231	232	i	2	1	2	K	
RF Shelf A2 Maximum Reference Temperature	233	234	i	2	1	2	K	
RF Shelf A1-1 Minimum Reference Temperature, PLLO#2	235	236	i	2	1	2	K	
RF Shelf A1-1 Nominal Reference Temperature, PLLO#2	237	238	i	2	1	2	K	
RF Shelf A1-1 Maximum Reference Temperature, PLLO#2	239	240	i	2	1	2	K	
RF Mux A1-1 Minimum Reference Temperature, PLLO#1	241	242	i	2	1	2	K	
RF Mux A1-1 Nominal Reference Temperature, PLLO#1	243	244	i	2	1	2	K	
RF Mux A1-1 Maximum Reference Temperature, PLLO#1	245	246	i	2	1	2	K	
RF Mux A1-2 Minimum Reference Temperature	247	248	i	2	1	2	K	
RF Mux A1-2 Nominal Reference Temperature	249	250	i	2	1	2	K	
RF Mux A1-2 Maximum Reference Temperature	251	252	i	2	1	2	K	
RF Mux/Diplexer A2 Minimum Reference Temperature	253	254	i	2	1	2	K	2
RF Mux/Diplexer A2 Nominal Reference Temperature	255	256	i	2	1	2	K	2
RF Mux/Diplexer A2 Maximum Reference Temperature	257	258	i	2	1	2	K	2
RF Mux A1-1 Minimum Reference Temperature, PLLO#2	259	260	i	2	1	2	K	
RF Mux A1-1 Nominal Reference Temperature, PLLO#2	261	262	i	2	1	2	K	

RF Mux A1-1 Maximum Reference Temperature, PLL0#2	263	264	i	2	1	2	K	
Warm Target Fixed Bias Corr Ch1 at Min RF Shelf Temp	265	266	i	2	1	3	K	
Warm Target Fixed Bias Corr Ch1 at Nom RF Shelf Temp	267	268	i	2	1	3	K	
Warm Target Fixed Bias Corr Ch1 at Max RF Shelf Temp	269	270	i	2	1	3	K	
Cold Space Fixed Bias Corr Ch1	271	272	i	2	1	3	K	
Warm Target Fixed Bias Corr Ch2 at Min RF Shelf Temp	273	274	i	2	1	3	K	
Warm Target Fixed Bias Corr Ch2 at Nom RF Shelf Temp	275	276	i	2	1	3	K	
Warm Target Fixed Bias Corr Ch2 at Max RF Shelf Temp	277	278	i	2	1	3	K	
Cold Space Fixed Bias Corr Ch2	279	280	i	2	1	3	K	
Warm Target Fixed Bias Corr Ch3 at Min RF Shelf Temp	281	282	i	2	1	3	K	
Warm Target Fixed Bias Corr Ch3 at Nom RF Shelf Temp	283	284	i	2	1	3	K	
Warm Target Fixed Bias Corr Ch3 at Max RF Shelf Temp	285	286	i	2	1	3	K	
Cold Space Fixed Bias Corr Ch3	287	288	i	2	1	3	K	
Warm Target Fixed Bias Corr Ch4 at Min RF Shelf Temp	289	290	i	2	1	3	K	
Warm Target Fixed Bias Corr Ch4 at Nom RF Shelf Temp	291	292	i	2	1	3	K	
Warm Target Fixed Bias Corr Ch4 at Max RF Shelf Temp	293	294	i	2	1	3	K	
Cold Space Fixed Bias Corr Ch4	295	296	i	2	1	3	K	
Warm Target Fixed Bias Corr Ch5 at Min RF Shelf Temp	297	298	i	2	1	3	K	
Warm Target Fixed Bias Corr Ch5 at Nom RF Shelf Temp	299	300	i	2	1	3	K	
Warm Target Fixed Bias Corr Ch5 at Max RF Shelf Temp	301	302	i	2	1	3	K	
Cold Space Fixed Bias Corr Ch5	303	304	i	2	1	3	K	
Warm Target Fixed Bias Corr Ch6 at Min RF Shelf Temp	305	306	i	2	1	3	K	
Warm Target Fixed Bias Corr Ch6 at Nom RF Shelf Temp	307	308	i	2	1	3	K	
Warm Target Fixed Bias Corr Ch6 at Max RF Shelf Temp	309	310	i	2	1	3	K	
Cold Space Fixed Bias Corr Ch6	311	312	i	2	1	3	K	
Warm Target Fixed Bias Corr Ch7 at Min RF Shelf Temp	313	314	i	2	1	3	K	
Warm Target Fixed Bias Corr Ch7 at Nom RF Shelf Temp	315	316	i	2	1	3	K	
Warm Target Fixed Bias Corr Ch7 at Max RF Shelf Temp	317	318	i	2	1	3	K	
Cold Space Fixed Bias Corr Ch7	319	320	i	2	1	3	K	

Warm Target Fixed Bias Corr Ch8 at Min RF Shelf Temp	321	322	i	2	1	3	K	
Warm Target Fixed Bias Corr Ch8 at Nom RF Shelf Temp	323	324	i	2	1	3	K	
Warm Target Fixed Bias Corr Ch8 at Max RF Shelf Temp	325	326	i	2	1	3	K	
Cold Space Fixed Bias Corr Ch8	327	328	i	2	1	3	K	
Warm Target Fixed Bias Corr Ch9 at Min RF Shelf Temp	329	330	i	2	1	3	K	
Warm Target Fixed Bias Corr Ch9 at Nom RF Shelf Temp	331	332	i	2	1	3	K	
Warm Target Fixed Bias Corr Ch9 at Max RF Shelf Temp	333	334	i	2	1	3	K	
Cold Space Fixed Bias Corr Ch9	335	336	i	2	1	3	K	
Warm Target Fixed Bias Corr Ch10 at Min RF Shelf Temp	337	338	i	2	1	3	K	
Warm Target Fixed Bias Corr Ch10 at Nom RF Shelf Temp	339	340	i	2	1	3	K	
Warm Target Fixed Bias Corr Ch10 at Max RF Shelf Temp	341	342	i	2	1	3	K	
Cold Space Fixed Bias Corr Ch10	343	344	i	2	1	3	K	
Warm Target Fixed Bias Corr Ch11 at Min RF Shelf Temp	345	346	i	2	1	3	K	
Warm Target Fixed Bias Corr Ch11 at Nom RF Shelf Temp	347	348	i	2	1	3	K	
Warm Target Fixed Bias Corr Ch11 at Max RF Shelf Temp	349	350	i	2	1	3	K	
Cold Space Fixed Bias Corr Ch11	351	352	i	2	1	3	K	
Warm Target Fixed Bias Corr Ch12 at Min RF Shelf Temp	353	354	i	2	1	3	K	
Warm Target Fixed Bias Corr Ch12 at Nom RF Shelf Temp	355	356	i	2	1	3	K	
Warm Target Fixed Bias Corr Ch12 at Max RF Shelf Temp	357	358	i	2	1	3	K	
Cold Space Fixed Bias Corr Ch12	359	360	i	2	1	3	K	
Warm Target Fixed Bias Corr Ch13 at Min RF Shelf Temp	361	362	i	2	1	3	K	
Warm Target Fixed Bias Corr Ch13 at Nom RF Shelf Temp	363	364	i	2	1	3	K	
Warm Target Fixed Bias Corr Ch13 at Max RF Shelf Temp	365	366	i	2	1	3	K	
Cold Space Fixed Bias Corr Ch13	367	368	i	2	1	3	K	
Warm Target Fixed Bias Corr Ch14 at Min RF Shelf Temp	369	370	i	2	1	3	K	
Warm Target Fixed Bias Corr Ch14 at Nom RF Shelf Temp	371	372	i	2	1	3	K	
Warm Target Fixed Bias Corr Ch14 at Max RF Shelf Temp	373	374	i	2	1	3	K	
Cold Space Fixed Bias Corr Ch14	375	376	i	2	1	3	K	
Warm Target Fixed Bias Corr Ch15 at Min RF Shelf Temp	377	378	i	2	1	3	K	

Warm Target Fixed Bias Corr Ch15 at Nom RF Shelf Temp	379	380	i	2	1	3	K	
Warm Target Fixed Bias Corr Ch15 at Max RF Shelf Temp	381	382	i	2	1	3	K	
Cold Space Fixed Bias Corr Ch15	383	384	i	2	1	3	K	
Warm Target Bias Corr Ch9 at PLL0#2 RF Shelf A1-1 Min Ref Temp	385	386	i	2	1	3	K	
Warm Target Bias Corr Ch9 at PLL0#2 RF Shelf A1-1 Nom Ref Temp	387	388	i	2	1	3	K	
Warm Target Bias Corr Ch9 at PLL0#2 RF Shelf A1-1 Max Ref Temp	389	390	i	2	1	3	K	
Warm Target Bias Corr Ch10 at PLL0#2 RF Shelf A1-1 Min Ref Temp	391	392	i	2	1	3	K	
Warm Target Bias Corr Ch10 at PLL0#2 RF Shelf A1-1 Nom Ref Temp	393	394	i	2	1	3	K	
Warm Target Bias Corr Ch10 at PLL0#2 RF Shelf A1-1 Max Ref Temp	395	396	i	2	1	3	K	
Warm Target Bias Corr Ch11 at PLL0#2 RF Shelf A1-1 Min Ref Temp	397	398	i	2	1	3	K	
Warm Target Bias Corr Ch11 at PLL0#2 RF Shelf A1-1 Nom Ref Temp	399	400	i	2	1	3	K	
Warm Target Bias Corr Ch11 at PLL0#2 RF Shelf A1-1 Max Ref Temp	401	402	i	2	1	3	K	
Warm Target Bias Corr Ch12 at PLL0#2 RF Shelf A1-1 Min Ref Temp	403	404	i	2	1	3	K	
Warm Target Bias Corr Ch12 at PLL0#2 RF Shelf A1-1 Nom Ref Temp	405	406	i	2	1	3	K	
Warm Target Bias Corr Ch12 at PLL0#2 RF Shelf A1-1 Max Ref Temp	407	408	i	2	1	3	K	
Warm Target Bias Corr Ch13 at PLL0#2 RF Shelf A1-1 Min Ref Temp	409	410	i	2	1	3	K	
Warm Target Bias Corr Ch13 at PLL0#2 RF Shelf A1-1 Nom Ref Temp	411	412	i	2	1	3	K	
Warm Target Bias Corr Ch13 at PLL0#2 RF Shelf A1-1 Max Ref Temp	413	414	i	2	1	3	K	
Warm Target Bias Corr Ch14 at PLL0#2 RF Shelf A1-1 Min Ref Temp	415	416	i	2	1	3	K	
Warm Target Bias Corr Ch14 at PLL0#2 RF Shelf A1-1 Nom Ref Temp	417	418	i	2	1	3	K	
Warm Target Bias Corr Ch14 at PLL0#2 RF Shelf A1-1 Max Ref Temp	419	420	i	2	1	3	K	
Nonlinearity Coef. Ch 1 at Min Ref Temp	421	424	i	4	1	6	$m^2\text{-sr-cm}^{-1}$ /mW	
Nonlinearity Coef. Ch 1 at Nom Ref Temp	425	428	i	4	1	6	$m^2\text{-sr-cm}^{-1}$ /mW	
Nonlinearity Coef. Ch 1 at Max Ref Temp	429	432	i	4	1	6	$m^2\text{-sr-cm}^{-1}$ /mW	
Nonlinearity Coef. Ch 2 at Min Ref Temp	433	436	i	4	1	6	$m^2\text{-sr-cm}^{-1}$ /mW	
Nonlinearity Coef. Ch 2 at Nom Ref Temp	437	440	i	4	1	6	$m^2\text{-sr-cm}^{-1}$ /mW	

Nonlinearity Coef. Ch 2 at Max Ref Temp	441	444	i	4	1	6	$m^2\text{-sr-cm}^{-1}$ /mW	
Nonlinearity Coef. Ch 3 at Min Ref Temp	445	448	i	4	1	6	$m^2\text{-sr-cm}^{-1}$ /mW	
Nonlinearity Coef. Ch 3 at Nom Ref Temp	449	452	i	4	1	6	$m^2\text{-sr-cm}^{-1}$ /mW	
Nonlinearity Coef. Ch 3 at Max Ref Temp	453	456	i	4	1	6	$m^2\text{-sr-cm}^{-1}$ /mW	
Nonlinearity Coef. Ch 4 at Min Ref Temp	457	460	i	4	1	6	$m^2\text{-sr-cm}^{-1}$ /mW	
Nonlinearity Coef. Ch 4 at Nom Ref Temp	461	464	i	4	1	6	$m^2\text{-sr-cm}^{-1}$ /mW	
Nonlinearity Coef. Ch 4 at Max Ref Temp	465	468	i	4	1	6	$m^2\text{-sr-cm}^{-1}$ /mW	
Nonlinearity Coef. Ch 5 at Min Ref Temp	469	472	i	4	1	6	$m^2\text{-sr-cm}^{-1}$ /mW	
Nonlinearity Coef. Ch 5 at Nom Ref Temp	473	476	i	4	1	6	$m^2\text{-sr-cm}^{-1}$ /mW	
Nonlinearity Coef. Ch 5 at Max Ref Temp	477	480	i	4	1	6	$m^2\text{-sr-cm}^{-1}$ /mW	
Nonlinearity Coef. Ch 6 at Min Ref Temp	481	484	i	4	1	6	$m^2\text{-sr-cm}^{-1}$ /mW	
Nonlinearity Coef. Ch 6 at Nom Ref Temp	485	488	i	4	1	6	$m^2\text{-sr-cm}^{-1}$ /mW	
Nonlinearity Coef. Ch 6 at Max Ref Temp	489	492	i	4	1	6	$m^2\text{-sr-cm}^{-1}$ /mW	
Nonlinearity Coef. Ch 7 at Min Ref Temp	493	496	i	4	1	6	$m^2\text{-sr-cm}^{-1}$ /mW	
Nonlinearity Coef. Ch 7 at Nom Ref Temp	497	500	i	4	1	6	$m^2\text{-sr-cm}^{-1}$ /mW	
Nonlinearity Coef. Ch 7 at Max Ref Temp	501	504	i	4	1	6	$m^2\text{-sr-cm}^{-1}$ /mW	
Nonlinearity Coef. Ch 8 at Min Ref Temp	505	508	i	4	1	6	$m^2\text{-sr-cm}^{-1}$ /mW	
Nonlinearity Coef. Ch 8 at Nom Ref Temp	509	512	i	4	1	6	$m^2\text{-sr-cm}^{-1}$ /mW	
Nonlinearity Coef. Ch 8 at Max Ref Temp	513	516	i	4	1	6	$m^2\text{-sr-cm}^{-1}$ /mW	
Nonlinearity Coef. Ch 9 at Min Ref Temp	517	520	i	4	1	6	$m^2\text{-sr-cm}^{-1}$ /mW	
Nonlinearity Coef. Ch 9 at Nom Ref Temp	521	524	i	4	1	6	$m^2\text{-sr-cm}^{-1}$ /mW	
Nonlinearity Coef. Ch 9 at Max Ref Temp	525	528	i	4	1	6	$m^2\text{-sr-cm}^{-1}$ /mW	
Nonlinearity Coef. Ch 10 at Min Ref Temp	529	532	i	4	1	6	$m^2\text{-sr-cm}^{-1}$ /mW	
Nonlinearity Coef. Ch 10 at Nom Ref Temp	533	536	i	4	1	6	$m^2\text{-sr-cm}^{-1}$ /mW	
Nonlinearity Coef. Ch 10 at Max Ref Temp	537	540	i	4	1	6	$m^2\text{-sr-cm}^{-1}$ /mW	

Nonlinearity Coef. Ch 11 at Min Ref Temp	541	544	i	4	1	6	$m^2\text{-sr-cm}^{-1}$ /mW	
Nonlinearity Coef. Ch 11 at Nom Ref Temp	545	548	i	4	1	6	$m^2\text{-sr-cm}^{-1}$ /mW	
Nonlinearity Coef. Ch 11 at Max Ref Temp	549	552	i	4	1	6	$m^2\text{-sr-cm}^{-1}$ /mW	
Nonlinearity Coef. Ch 12 at Min Ref Temp	553	556	i	4	1	6	$m^2\text{-sr-cm}^{-1}$ /mW	
Nonlinearity Coef. Ch 12 at Nom Ref Temp	557	560	i	4	1	6	$m^2\text{-sr-cm}^{-1}$ /mW	
Nonlinearity Coef. Ch 12 at Max Ref Temp	561	564	i	4	1	6	$m^2\text{-sr-cm}^{-1}$ /mW	
Nonlinearity Coef. Ch 13 at Min Ref Temp	565	568	i	4	1	6	$m^2\text{-sr-cm}^{-1}$ /mW	
Nonlinearity Coef. Ch 13 at Nom Ref Temp	569	572	i	4	1	6	$m^2\text{-sr-cm}^{-1}$ /mW	
Nonlinearity Coef. Ch 13 at Max Ref Temp	573	576	i	4	1	6	$m^2\text{-sr-cm}^{-1}$ /mW	
Nonlinearity Coef. Ch 14 at Min Ref Temp	577	580	i	4	1	6	$m^2\text{-sr-cm}^{-1}$ /mW	
Nonlinearity Coef. Ch 14 at Nom Ref Temp	581	584	i	4	1	6	$m^2\text{-sr-cm}^{-1}$ /mW	
Nonlinearity Coef. Ch 14 at Max Ref Temp	585	588	i	4	1	6	$m^2\text{-sr-cm}^{-1}$ /mW	
Nonlinearity Coef. Ch 15 at Min Ref Temp	589	592	i	4	1	6	$m^2\text{-sr-cm}^{-1}$ /mW	
Nonlinearity Coef. Ch 15 at Nom Ref Temp	593	596	i	4	1	6	$m^2\text{-sr-cm}^{-1}$ /mW	
Nonlinearity Coef. Ch 15 at Max Ref Temp	597	600	i	4	1	6	$m^2\text{-sr-cm}^{-1}$ /mW	
Nonlinearity Coef. Ch 9 for PLL0#2 at Min Ref Temp	601	604	i	4	1	6	$m^2\text{-sr-cm}^{-1}$ /mW	
Nonlinearity Coef. Ch 9 for PLL0#2 at Nom Ref Temp	605	608	i	4	1	6	$m^2\text{-sr-cm}^{-1}$ /mW	
Nonlinearity Coef. Ch 9 for PLL0#2 at Max Ref Temp	609	612	i	4	1	6	$m^2\text{-sr-cm}^{-1}$ /mW	
Nonlinearity Coef. Ch 10 for PLL0#2 at Min Ref Temp	613	616	i	4	1	6	$m^2\text{-sr-cm}^{-1}$ /mW	
Nonlinearity Coef. Ch 10 for PLL0#2 at Nom Ref Temp	617	620	i	4	1	6	$m^2\text{-sr-cm}^{-1}$ /mW	
Nonlinearity Coef. Ch 10 for PLL0#2 at Max Ref Temp	621	624	i	4	1	6	$m^2\text{-sr-cm}^{-1}$ /mW	
Nonlinearity Coef. Ch 11 for PLL0#2 at Min Ref Temp	625	628	i	4	1	6	$m^2\text{-sr-cm}^{-1}$ /mW	
Nonlinearity Coef. Ch 11 for PLL0#2 at Nom Ref Temp	629	632	i	4	1	6	$m^2\text{-sr-cm}^{-1}$ /mW	
Nonlinearity Coef. Ch 11 for PLL0#2 at Max Ref Temp	633	636	i	4	1	6	$m^2\text{-sr-cm}^{-1}$ /mW	
Nonlinearity Coef. Ch 12 for PLL0#2 at Min Ref Temp	637	640	i	4	1	6	$m^2\text{-sr-cm}^{-1}$ /mW	

Nonlinearity Coef. Ch 12 for PLL0#2 at Nom Ref Temp	641	644	i	4	1	6	$m^2\text{-sr-cm}^{-1}$ /mW	
Nonlinearity Coef. Ch 12 for PLL0#2 at Max Ref Temp	645	648	i	4	1	6	$m^2\text{-sr-cm}^{-1}$ /mW	
Nonlinearity Coef. Ch 13 for PLL0#2 at Min Ref Temp	649	652	i	4	1	6	$m^2\text{-sr-cm}^{-1}$ /mW	
Nonlinearity Coef. Ch 13 for PLL0#2 at Nom Ref Temp	653	656	i	4	1	6	$m^2\text{-sr-cm}^{-1}$ /mW	
Nonlinearity Coef. Ch 13 for PLL0#2 at Max Ref Temp	657	660	i	4	1	6	$m^2\text{-sr-cm}^{-1}$ /mW	
Nonlinearity Coef. Ch 14 for PLL0#2 at Min Ref Temp	661	664	i	4	1	6	$m^2\text{-sr-cm}^{-1}$ /mW	
Nonlinearity Coef. Ch 14 for PLL0#2 at Nom Ref Temp	665	668	i	4	1	6	$m^2\text{-sr-cm}^{-1}$ /mW	
Nonlinearity Coef. Ch 14 for PLL0#2 at Max Ref Temp	669	672	i	4	1	6	$m^2\text{-sr-cm}^{-1}$ /mW	
<Zero Fill>	673	688	i	4	4	0		
TEMPERATURE-RADIANCE CONVERSION								
Temperature-radiance Ch 1 Central Wavenumber	689	692	i	4	1	6	cm^{-1}	
Temperature-radiance Ch 1 Constant 1	693	696	i	4	1	6		
Temperature-radiance Ch 1 Constant 2, Slope	697	700	i	4	1	6		
Temperature-radiance Ch 2 Central Wavenumber	701	704	i	4	1	6	cm^{-1}	
Temperature-radiance Ch 2 Constant 1	705	708	i	4	1	6		
Temperature-radiance Ch 2 Constant 2, Slope	709	712	i	4	1	6		
Temperature-radiance Ch 3 Central Wavenumber	713	716	i	4	1	6	cm^{-1}	
Temperature-radiance Ch 3 Constant 1	717	720	i	4	1	6		
Temperature-radiance Ch 3 Constant 2, Slope	721	724	i	4	1	6		
Temperature-radiance Ch 4 Central Wavenumber	725	728	i	4	1	6	cm^{-1}	
Temperature-radiance Ch 4 Constant 1	729	732	i	4	1	6		
Temperature-radiance Ch 4 Constant 2, Slope	733	736	i	4	1	6		
Temperature-radiance Ch 5 Central Wavenumber	737	740	i	4	1	6	cm^{-1}	
Temperature-radiance Ch 5 Constant 1	741	744	i	4	1	6		
Temperature-radiance Ch 5 Constant 2, Slope	745	748	i	4	1	6		
Temperature-radiance Ch 6 Central Wavenumber	749	752	i	4	1	6	cm^{-1}	
Temperature-radiance Ch 6 Constant 1	753	756	i	4	1	6		
Temperature-radiance Ch 6 Constant 2, Slope	757	760	i	4	1	6		
Temperature-radiance Ch 7 Central Wavenumber	761	764	i	4	1	6	cm^{-1}	
Temperature-radiance Ch 7 Constant 1	765	768	i	4	1	6		
Temperature-radiance Ch 7 Constant 2, Slope	769	772	i	4	1	6		
Temperature-radiance Ch 8 Central Wavenumber	773	776	i	4	1	6	cm^{-1}	
Temperature-radiance Ch 8 Constant 1	777	780	i	4	1	6		
Temperature-radiance Ch 8 Constant 2, Slope	781	784	i	4	1	6		
Temperature-radiance Ch 9 Central Wavenumber	785	788	i	4	1	6	cm^{-1}	
Temperature-radiance Ch 9 Constant 1	789	792	i	4	1	6		
Temperature-radiance Ch 9 Constant 2, Slope	793	796	i	4	1	6		
Temperature-radiance Ch 10 Central Wavenumber	797	800	i	4	1	6	cm^{-1}	
Temperature-radiance Ch 10 Constant 1	801	804	i	4	1	6		

Temperature-radiance Ch 10 Constant 2, Slope	805	808	i	4	1	6		
Temperature-radiance Ch 11 Central Wavenumber	809	812	i	4	1	6	cm ⁻¹	
Temperature-radiance Ch 11 Constant 1	813	816	i	4	1	6		
Temperature-radiance Ch 11 Constant 2, Slope	817	820	i	4	1	6		
Temperature-radiance Ch 12 Central Wavenumber	821	824	i	4	1	6	cm ⁻¹	
Temperature-radiance Ch 12 Constant 1	825	828	i	4	1	6		
Temperature-radiance Ch 12 Constant 2, Slope	829	832	i	4	1	6		
Temperature-radiance Ch 13 Central Wavenumber	833	836	i	4	1	6	cm ⁻¹	
Temperature-radiance Ch 13 Constant 1	837	840	i	4	1	6		
Temperature-radiance Ch 13 Constant 2, Slope	841	844	i	4	1	6		
Temperature-radiance Ch 14 Central Wavenumber	845	848	i	4	1	6	cm ⁻¹	
Temperature-radiance Ch 14 Constant 1	849	852	i	4	1	6		
Temperature-radiance Ch 14 Constant 2, Slope	853	856	i	4	1	6		
Temperature-radiance Ch 15 Central Wavenumber	857	860	i	4	1	6	cm ⁻¹	
Temperature-radiance Ch 15 Constant 1	861	864	i	4	1	6		
Temperature-radiance Ch 15 Constant 2, Slope	865	868	i	4	1	6		
<Zero Fill>	869	880	i	4	3	0		
NAVIGATION								
Reference Ellipsoid Model ID (<i>The ellipsoid is a mathematically tractable approximation of the geoid, which is an equipotential surface at mean sea level. The maximum departure of the ellipsoid from the geoid is approximately +/- 65 meters.</i>) WGS-72=World Geodetic Survey 1972 Nadir Earth Location Tolerance	881	888	c	8	1	0		
Earth Location Bit Field bits 15-3: <zero fill> bit 2: dynamic attitude error correction (0=not performed; 1=performed) bit 1: reasonableness test (0=inactive; 1=active) bit 0: constant attitude error correction (0=not performed; 1=performed) <Zero Fill>	889	890	u	2	1	1	kilometers	
Earth Location Bit Field bits 15-3: <zero fill> bit 2: dynamic attitude error correction (0=not performed; 1=performed) bit 1: reasonableness test (0=inactive; 1=active) bit 0: constant attitude error correction (0=not performed; 1=performed) <Zero Fill>	891	892	u	2	1	0		
Constant Roll Attitude Error	893	894	i	2	1	0		
Constant Roll Attitude Error	895	896	i	2	1	3	degrees	
Constant Pitch Attitude Error	897	898	i	2	1	3	degrees	
Constant Yaw Attitude Error	899	900	i	2	1	3	degrees	
Epoch Year for Orbit Vector	901	902	u	2	1	0		
Day of Epoch Year for Orbit Vector	903	904	u	2	1	0		
Epoch UTC Time of Day for Orbit Vector	905	908	u	4	1	0	milliseconds	
Semi-major Axis (<i>at the orbit vector epoch time</i>)	909	912	i	4	1	5	kilometers	
Eccentricity (<i>at the orbit vector epoch time</i>)	913	916	i	4	1	8		
Inclination (<i>at the orbit vector epoch time</i>)	917	920	i	4	1	5	degrees	
Argument of Perigee (<i>at the orbit vector epoch time</i>)	921	924	i	4	1	5	degrees	
Right Ascension of the Ascending Node (<i>at the orbit vector epoch time</i>)	925	928	i	4	1	5	degrees	
Mean Anomaly (<i>at the orbit vector epoch time</i>)	929	932	i	4	1	5	degrees	
Position Vector X Component (<i>at the orbit vector epoch time</i>)	933	936	i	4	1	5	kilometers	

Position Vector Y Component (<i>at the orbit vector epoch time</i>)	937	940	i	4	1	5	kilometers	
Position Vector Z Component (<i>at the orbit vector epoch time</i>)	941	944	i	4	1	5	kilometers	
Velocity Vector X-dot Component (<i>at the orbit vector epoch time</i>)	945	948	i	4	1	8	km/second	
Velocity Vector Y-dot Component (<i>at the orbit vector epoch time</i>)	949	952	i	4	1	8	km/second	
Velocity Vector Z-dot Component (<i>at the orbit vector epoch time</i>)	953	956	i	4	1	8	km/second	
Earth/Sun Distance Ratio (<i>at the orbit vector epoch time; relative to the mean distance of 1 AU</i>)	957	960	u	4	1	6		
<Zero Fill>	961	976	i	4	4	0		

AMSU-A1 DIGITAL A CONVERSION

Counts-to-temperature conversion coefficients for the AMSU-A1 digital A telemetry items

Scan Motor A1-1 Temperature Coefficient 0	977	980	i	4	1	4	K	
Scan Motor A1-1 Temperature Coefficient 1	981	984	i	4	1	9	K/count	
Scan Motor A1-1 Temperature Coefficient 2	985	988	i	4	1	16	K/count ²	
Scan Motor A1-1 Temperature Coefficient 3	989	992	i	4	1	20	K/count ³	
Scan Motor A1-2 Temperature Coefficient 0	993	996	i	4	1	4	K	
Scan Motor A1-2 Temperature Coefficient 1	997	1000	i	4	1	9	K/count	
Scan Motor A1-2 Temperature Coefficient 2	1001	1004	i	4	1	16	K/count ²	
Scan Motor A1-2 Temperature Coefficient 3	1005	1008	i	4	1	20	K/count ³	
Feed Horn A1-1 Temperature Coefficient 0	1009	1012	i	4	1	4	K	
Feed Horn A1-1 Temperature Coefficient 1	1013	1016	i	4	1	9	K/count	
Feed Horn A1-1 Temperature Coefficient 2	1017	1020	i	4	1	16	K/count ²	
Feed Horn A1-1 Temperature Coefficient 3	1021	1024	i	4	1	20	K/count ³	
Feed Horn A1-2 Temperature Coefficient 0	1025	1028	i	4	1	4	K	
Feed Horn A1-2 Temperature Coefficient 1	1029	1032	i	4	1	9	K/count	
Feed Horn A1-2 Temperature Coefficient 2	1033	1036	i	4	1	16	K/count ²	
Feed Horn A1-2 Temperature Coefficient 3	1037	1040	i	4	1	20	K/count ³	
RF Mux A1-1 Temperature Coefficient 0	1041	1044	i	4	1	4	K	
RF Mux A1-1 Temperature Coefficient 1	1045	1048	i	4	1	9	K/count	
RF Mux A1-1 Temperature Coefficient 2	1049	1052	i	4	1	16	K/count ²	
RF Mux A1-1 Temperature Coefficient 3	1053	1056	i	4	1	20	K/count ³	
RF Mux A1-2 Temperature Coefficient 0	1057	1060	i	4	1	4	K	
RF Mux A1-2 Temperature Coefficient 1	1061	1064	i	4	1	9	K/count	
RF Mux A1-2 Temperature Coefficient 2	1065	1068	i	4	1	16	K/count ²	
RF Mux A1-2 Temperature Coefficient 3	1069	1072	i	4	1	20	K/count ³	
Local Oscillator Channel 3 Temperature Coefficient 0	1073	1076	i	4	1	4	K	
Local Oscillator Channel 3 Temperature Coefficient 1	1077	1080	i	4	1	9	K/count	
Local Oscillator Channel 3 Temperature Coefficient 2	1081	1084	i	4	1	16	K/count ²	
Local Oscillator Channel 3 Temperature Coefficient 3	1085	1088	i	4	1	20	K/count ³	
Local Oscillator Channel 4 Temperature Coefficient 0	1089	1092	i	4	1	4	K	
Local Oscillator Channel 4 Temperature Coefficient 1	1093	1096	i	4	1	9	K/count	
Local Oscillator Channel 4 Temperature Coefficient 2	1097	1100	i	4	1	16	K/count ²	
Local Oscillator Channel 4 Temperature Coefficient 3	1101	1104	i	4	1	20	K/count ³	
Local Oscillator Channel 5 Temperature Coefficient 0	1105	1108	i	4	1	4	K	
Local Oscillator Channel 5 Temperature Coefficient 1	1109	1112	i	4	1	9	K/count	
Local Oscillator Channel 5 Temperature Coefficient 2	1113	1116	i	4	1	16	K/count ²	

Local Oscillator Channel 5 Temperature Coefficient 3	1117	1120	i	4	1	20	K/count ³	
Local Oscillator Channel 6 Temperature Coefficient 0	1121	1124	i	4	1	4	K	
Local Oscillator Channel 6 Temperature Coefficient 1	1125	1128	i	4	1	9	K/count	
Local Oscillator Channel 6 Temperature Coefficient 2	1129	1132	i	4	1	16	K/count ²	
Local Oscillator Channel 6 Temperature Coefficient 3	1133	1136	i	4	1	20	K/count ³	
Local Oscillator Channel 7 Temperature Coefficient 0	1137	1140	i	4	1	4	K	
Local Oscillator Channel 7 Temperature Coefficient 1	1141	1144	i	4	1	9	K/count	
Local Oscillator Channel 7 Temperature Coefficient 2	1145	1148	i	4	1	16	K/count ²	
Local Oscillator Channel 7 Temperature Coefficient 3	1149	1152	i	4	1	20	K/count ³	
Local Oscillator Channel 8 Temperature Coefficient 0	1153	1156	i	4	1	4	K	
Local Oscillator Channel 8 Temperature Coefficient 1	1157	1160	i	4	1	9	K/count	
Local Oscillator Channel 8 Temperature Coefficient 2	1161	1164	i	4	1	16	K/count ²	
Local Oscillator Channel 8 Temperature Coefficient 3	1165	1168	i	4	1	20	K/count ³	
Local Oscillator Channel 15 Temperature Coefficient 0	1169	1172	i	4	1	4	K	
Local Oscillator Channel 15 Temperature Coefficient 1	1173	1176	i	4	1	9	K/count	
Local Oscillator Channel 15 Temperature Coefficient 2	1177	1180	i	4	1	16	K/count ²	
Local Oscillator Channel 15 Temperature Coefficient 3	1181	1184	i	4	1	20	K/count ³	
PLLO #2 Channels 9 Through 14 Temperature Coefficient 0	1185	1188	i	4	1	4	K	
PLLO #2 Channels 9 Through 14 Temperature Coefficient 1	1189	1192	i	4	1	9	K/count	
PLLO #2 Channels 9 Through 14 Temperature Coefficient 2	1193	1196	i	4	1	16	K/count ²	
PLLO #2 Channels 9 Through 14 Temperature Coefficient 3	1197	1200	i	4	1	20	K/count ³	
PLLO #1 Channels 9 Through 14 Temperature Coefficient 0	1201	1204	i	4	1	4	K	
PLLO #1 Channels 9 Through 14 Temperature Coefficient 1	1205	1208	i	4	1	9	K/count	
PLLO #1 Channels 9 Through 14 Temperature Coefficient 2	1209	1212	i	4	1	16	K/count ²	
PLLO #1 Channels 9 Through 14 Temperature Coefficient 3	1213	1216	i	4	1	20	K/count ³	
PLLO (Reference Oscillator) Temperature Coefficient 0 (NOAA-KLM) or <Zero Fill> (NOAA-NN', Metop)	1217	1220	i	4	1	4	K	
PLLO (Reference Oscillator) Temperature Coefficient 1 (NOAA-KLM) or <Zero Fill> (NOAA-NN', Metop)	1221	1224	i	4	1	9	K/count	
PLLO (Reference Oscillator) Temperature Coefficient 2 (NOAA-KLM) or <Zero Fill> (NOAA-NN', Metop)	1225	1228	i	4	1	16	K/count ²	
PLLO (Reference Oscillator) Temperature Coefficient 3 (NOAA-KLM) or <Zero Fill> (NOAA-NN', Metop)	1229	1232	i	4	1	20	K/count ³	
Mixer/IF Amplifier Channel 3 Temperature Coefficient 0	1233	1236	i	4	1	4	K	
Mixer/IF Amplifier Channel 3 Temperature Coefficient 1	1237	1240	i	4	1	9	K/count	
Mixer/IF Amplifier Channel 3 Temperature Coefficient 2	1241	1244	i	4	1	16	K/count ²	
Mixer/IF Amplifier Channel 3 Temperature Coefficient 3	1245	1248	i	4	1	20	K/count ³	
Mixer/IF Amplifier Channel 4 Temperature Coefficient 0	1249	1252	i	4	1	4	K	
Mixer/IF Amplifier Channel 4 Temperature Coefficient 1	1253	1256	i	4	1	9	K/count	
Mixer/IF Amplifier Channel 4 Temperature Coefficient 2	1257	1260	i	4	1	16	K/count ²	
Mixer/IF Amplifier Channel 4 Temperature Coefficient 3	1261	1264	i	4	1	20	K/count ³	
Mixer/IF Amplifier Channel 5 Temperature Coefficient 0	1265	1268	i	4	1	4	K	
Mixer/IF Amplifier Channel 5 Temperature Coefficient 1	1269	1272	i	4	1	9	K/count	

Mixer/IF Amplifier Channel 5 Temperature Coefficient 2	1273	1276	i	4	1	16	K/count ²	
Mixer/IF Amplifier Channel 5 Temperature Coefficient 3	1277	1280	i	4	1	20	K/count ³	
Mixer/IF Amplifier Channel 6 Temperature Coefficient 0	1281	1284	i	4	1	4	K	
Mixer/IF Amplifier Channel 6 Temperature Coefficient 1	1285	1288	i	4	1	9	K/count	
Mixer/IF Amplifier Channel 6 Temperature Coefficient 2	1289	1292	i	4	1	16	K/count ²	
Mixer/IF Amplifier Channel 6 Temperature Coefficient 3	1293	1296	i	4	1	20	K/count ³	
Mixer/IF Amplifier Channel 7 Temperature Coefficient 0	1297	1300	i	4	1	4	K	
Mixer/IF Amplifier Channel 7 Temperature Coefficient 1	1301	1304	i	4	1	9	K/count	
Mixer/IF Amplifier Channel 7 Temperature Coefficient 2	1305	1308	i	4	1	16	K/count ²	
Mixer/IF Amplifier Channel 7 Temperature Coefficient 3	1309	1312	i	4	1	20	K/count ³	
Mixer/IF Amplifier Channel 8 Temperature Coefficient 0	1313	1316	i	4	1	4	K	
Mixer/IF Amplifier Channel 8 Temperature Coefficient 1	1317	1320	i	4	1	9	K/count	
Mixer/IF Amplifier Channel 8 Temperature Coefficient 2	1321	1324	i	4	1	16	K/count ²	
Mixer/IF Amplifier Channel 8 Temperature Coefficient 3	1325	1328	i	4	1	20	K/count ³	
Mixer/IF Amplifier Channel 9/14 Temperature Coefficient 0	1329	1332	i	4	1	4	K	
Mixer/IF Amplifier Channel 9/14 Temperature Coefficient 1	1333	1336	i	4	1	9	K/count	
Mixer/IF Amplifier Channel 9/14 Temperature Coefficient 2	1337	1340	i	4	1	16	K/count ²	
Mixer/IF Amplifier Channel 9/14 Temperature Coefficient 3	1341	1344	i	4	1	20	K/count ³	
Mixer/IF Amplifier Channel 15 Temperature Coefficient 0	1345	1348	i	4	1	4	K	
Mixer/IF Amplifier Channel 15 Temperature Coefficient 1	1349	1352	i	4	1	9	K/count	
Mixer/IF Amplifier Channel 15 Temperature Coefficient 2	1353	1356	i	4	1	16	K/count ²	
Mixer/IF Amplifier Channel 15 Temperature Coefficient 3	1357	1360	i	4	1	20	K/count ³	
IF Amplifier Channel 11/14 Temperature Coefficient 0	1361	1364	i	4	1	4	K	
IF Amplifier Channel 11/14 Temperature Coefficient 1	1365	1368	i	4	1	9	K/count	
IF Amplifier Channel 11/14 Temperature Coefficient 2	1369	1372	i	4	1	16	K/count ²	
IF Amplifier Channel 11/14 Temperature Coefficient 3	1373	1376	i	4	1	20	K/count ³	
IF Amplifier Channel 9 Temperature Coefficient 0	1377	1380	i	4	1	4	K	
IF Amplifier Channel 9 Temperature Coefficient 1	1381	1384	i	4	1	9	K/count	
IF Amplifier Channel 9 Temperature Coefficient 2	1385	1388	i	4	1	16	K/count ²	
IF Amplifier Channel 9 Temperature Coefficient 3	1389	1392	i	4	1	20	K/count ³	
IF Amplifier Channel 10 Temperature Coefficient 0	1393	1396	i	4	1	4	K	
IF Amplifier Channel 10 Temperature Coefficient 1	1397	1400	i	4	1	9	K/count	
IF Amplifier Channel 10 Temperature Coefficient 2	1401	1404	i	4	1	16	K/count ²	
IF Amplifier Channel 10 Temperature Coefficient 3	1405	1408	i	4	1	20	K/count ³	
IF Amplifier Channel 11 Temperature Coefficient 0	1409	1412	i	4	1	4	K	
IF Amplifier Channel 11 Temperature Coefficient 1	1413	1416	i	4	1	9	K/count	
IF Amplifier Channel 11 Temperature Coefficient 2	1417	1420	i	4	1	16	K/count ²	
IF Amplifier Channel 11 Temperature Coefficient 3	1421	1424	i	4	1	20	K/count ³	
DC/DC Converter Temperature Coefficient 0	1425	1428	i	4	1	4	K	
DC/DC Converter Temperature Coefficient 1	1429	1432	i	4	1	9	K/count	
DC/DC Converter Temperature Coefficient 2	1433	1436	i	4	1	16	K/count ²	
DC/DC Converter Temperature Coefficient 3	1437	1440	i	4	1	20	K/count ³	
IF Amplifier Channel 13 Temperature Coefficient 0	1441	1444	i	4	1	4	K	

IF Amplifier Channel 13 Temperature Coefficient 1	1445	1448	i	4	1	9	K/count	
IF Amplifier Channel 13 Temperature Coefficient 2	1449	1452	i	4	1	16	K/count ²	
IF Amplifier Channel 13 Temperature Coefficient 3	1453	1456	i	4	1	20	K/count ³	
IF Amplifier Channel 14 Temperature Coefficient 0	1457	1460	i	4	1	4	K	
IF Amplifier Channel 14 Temperature Coefficient 1	1461	1464	i	4	1	9	K/count	
IF Amplifier Channel 14 Temperature Coefficient 2	1465	1468	i	4	1	16	K/count ²	
IF Amplifier Channel 14 Temperature Coefficient 3	1469	1472	i	4	1	20	K/count ³	
IF Amplifier Channel 12 Temperature Coefficient 0	1473	1476	i	4	1	4	K	
IF Amplifier Channel 12 Temperature Coefficient 1	1477	1480	i	4	1	9	K/count	
IF Amplifier Channel 12 Temperature Coefficient 2	1481	1484	i	4	1	16	K/count ²	
IF Amplifier Channel 12 Temperature Coefficient 3	1485	1488	i	4	1	20	K/count ³	
RF Shelf A1-1 Temperature Coefficient 0	1489	1492	i	4	1	4	K	
RF Shelf A1-1 Temperature Coefficient 1	1493	1496	i	4	1	9	K/count	
RF Shelf A1-1 Temperature Coefficient 2	1497	1500	i	4	1	16	K/count ²	
RF Shelf A1-1 Temperature Coefficient 3	1501	1504	i	4	1	20	K/count ³	
RF Shelf A1-2 Temperature Coefficient 0	1505	1508	i	4	1	4	K	
RF Shelf A1-2 Temperature Coefficient 1	1509	1512	i	4	1	9	K/count	
RF Shelf A1-2 Temperature Coefficient 2	1513	1516	i	4	1	16	K/count ²	
RF Shelf A1-2 Temperature Coefficient 3	1517	1520	i	4	1	20	K/count ³	
Detector/preamp Assembly Temperature Coefficient 0	1521	1524	i	4	1	4	K	
Detector/preamp Assembly Temperature Coefficient 1	1525	1528	i	4	1	9	K/count	
Detector/preamp Assembly Temperature Coefficient 2	1529	1532	i	4	1	16	K/count ²	
Detector/preamp Assembly Temperature Coefficient 3	1533	1536	i	4	1	20	K/count ³	
A1-1 Warm Load 1 Temperature Coefficient 0	1537	1540	i	4	1	4	K	
A1-1 Warm Load 1 Temperature Coefficient 1	1541	1544	i	4	1	9	K/count	
A1-1 Warm Load 1 Temperature Coefficient 2	1545	1548	i	4	1	16	K/count ²	
A1-1 Warm Load 1 Temperature Coefficient 3	1549	1552	i	4	1	20	K/count ³	
A1-1 Warm Load 2 Temperature Coefficient 0	1553	1556	i	4	1	4	K	
A1-1 Warm Load 2 Temperature Coefficient 1	1557	1560	i	4	1	9	K/count	
A1-1 Warm Load 2 Temperature Coefficient 2	1561	1564	i	4	1	16	K/count ²	
A1-1 Warm Load 2 Temperature Coefficient 3	1565	1568	i	4	1	20	K/count ³	
A1-1 Warm Load 3 Temperature Coefficient 0	1569	1572	i	4	1	4	K	
A1-1 Warm Load 3 Temperature Coefficient 1	1573	1576	i	4	1	9	K/count	
A1-1 Warm Load 3 Temperature Coefficient 2	1577	1580	i	4	1	16	K/count ²	
A1-1 Warm Load 3 Temperature Coefficient 3	1581	1584	i	4	1	20	K/count ³	
A1-1 Warm Load 4 Temperature Coefficient 0	1585	1588	i	4	1	4	K	
A1-1 Warm Load 4 Temperature Coefficient 1	1589	1592	i	4	1	9	K/count	
A1-1 Warm Load 4 Temperature Coefficient 2	1593	1596	i	4	1	16	K/count ²	
A1-1 Warm Load 4 Temperature Coefficient 3	1597	1600	i	4	1	20	K/count ³	
A1-1 Warm Load Center Temperature Coefficient 0	1601	1604	i	4	1	4	K	
A1-1 Warm Load Center Temperature Coefficient 1	1605	1608	i	4	1	9	K/count	
A1-1 Warm Load Center Temperature Coefficient 2	1609	1612	i	4	1	16	K/count ²	
A1-1 Warm Load Center Temperature Coefficient 3	1613	1616	i	4	1	20	K/count ³	
A1-2 Warm Load 1 Temperature Coefficient 0	1617	1620	i	4	1	4	K	
A1-2 Warm Load 1 Temperature Coefficient 1	1621	1624	i	4	1	9	K/count	
A1-2 Warm Load 1 Temperature Coefficient 2	1625	1628	i	4	1	16	K/count ²	
A1-2 Warm Load 1 Temperature Coefficient 3	1629	1632	i	4	1	20	K/count ³	
A1-2 Warm Load 2 Temperature Coefficient 0	1633	1636	i	4	1	4	K	
A1-2 Warm Load 2 Temperature Coefficient 1	1637	1640	i	4	1	9	K/count	
A1-2 Warm Load 2 Temperature Coefficient 2	1641	1644	i	4	1	16	K/count ²	

A1-2 Warm Load 2 Temperature Coefficient 3	1645	1648	i	4	1	20	K/count ³	
A1-2 Warm Load 3 Temperature Coefficient 0	1649	1652	i	4	1	4	K	
A1-2 Warm Load 3 Temperature Coefficient 1	1653	1656	i	4	1	9	K/count	
A1-2 Warm Load 3 Temperature Coefficient 2	1657	1660	i	4	1	16	K/count ²	
A1-2 Warm Load 3 Temperature Coefficient 3	1661	1664	i	4	1	20	K/count ³	
A1-2 Warm Load 4 Temperature Coefficient 0	1665	1668	i	4	1	4	K	
A1-2 Warm Load 4 Temperature Coefficient 1	1669	1672	i	4	1	9	K/count	
A1-2 Warm Load 4 Temperature Coefficient 2	1673	1676	i	4	1	16	K/count ²	
A1-2 Warm Load 4 Temperature Coefficient 3	1677	1680	i	4	1	20	K/count ³	
A1-2 Warm Load Center Temperature Coefficient 0	1681	1684	i	4	1	4	K	
A1-2 Warm Load Center Temperature Coefficient 1	1685	1688	i	4	1	9	K/count	
A1-2 Warm Load Center Temperature Coefficient 2	1689	1692	i	4	1	16	K/count ²	
A1-2 Warm Load Center Temperature Coefficient 3	1693	1696	i	4	1	20	K/count ³	
<Zero Fill>	1697	1700	i	4	1	0		

AMSU-A1 ANALOG TELEMETRY CONVERSION

Volts-to-engineering units (e.g., temperature in Kelvin) conversion coefficients for the AMSU-A1 analog telemetry items. (NOTE: 1 count = 0.02 volts.)

A1-1 Scan Motor Temp Intercept	1701	1704	i	4	1	3	K	
A1-1 Scan Motor Temp Slope	1705	1708	i	4	1	3	K/volt	
A1-2 Scan Motor Temp Intercept	1709	1712	i	4	1	3	K	
A1-2 Scan Motor Temp Slope	1713	1716	i	4	1	3	K/volt	
A1-1 RF Shelf Temp Intercept	1717	1720	i	4	1	3	K	
A1-1 RF Shelf Temp Slope	1721	1724	i	4	1	3	K/volt	
A1-2 RF Shelf Temp Intercept	1725	1728	i	4	1	3	K	
A1-2 RF Shelf Temp Slope	1729	1732	i	4	1	3	K/volt	
A1-1 Warm Load Temp Intercept	1733	1736	i	4	1	3	K	
A1-1 Warm Load Temp Slope	1737	1740	i	4	1	3	K/volt	
A1-2 Warm Load Temp Intercept	1741	1744	i	4	1	3	K	
A1-2 Warm Load Temp Slope	1745	1748	i	4	1	3	K/volt	
A1-1 Antenna Motor Current Intercept	1749	1752	i	4	1	3	mA	
A1-1 Antenna Motor Current Slope	1753	1756	i	4	1	3	mA/volt	
A1-2 Antenna Motor Current Intercept	1757	1760	i	4	1	3	mA	
A1-2 Antenna Motor Current Slope	1761	1764	i	4	1	3	mA/volt	
+15v Signal Processing Intercept	1765	1768	i	4	1	3	volts	
+15v Signal Processing Slope	1769	1772	i	4	1	3		
+15v Antenna Drive Intercept	1773	1776	i	4	1	3	volts	
+15v Antenna Drive Slope	1777	1780	i	4	1	3		
-15v Signal Processing Intercept	1781	1784	i	4	1	3	volts	
-15v Signal Processing Slope	1785	1788	i	4	1	3		
-15v Antenna Drive Intercept	1789	1792	i	4	1	3	volts	
-15v Antenna Drive Slope	1793	1796	i	4	1	3		
+8v Receiver Amps Intercept	1797	1800	i	4	1	3	volts	
+8v Receiver Amps Slope	1801	1804	i	4	1	3		
+5v Signal Processing Intercept	1805	1808	i	4	1	3	volts	
+5v Signal Processing Slope	1809	1812	i	4	1	3		
+5v Antenna Drive Intercept	1813	1816	i	4	1	3	volts	
+5v Antenna Drive Slope	1817	1820	i	4	1	3		
+8.5v Phase Lock Loop Ch 9/14	1821	1824	i	4	1	3	volts	

+8.5v Phase Lock Loop Ch 9/14 Slope	1825	1828	i	4	1	3		
+15v Phase Lock Loop Ch 9/14 Intercept	1829	1832	i	4	1	3	volts	
+15v Phase Lock Loop Ch 9/14 Slope	1833	1836	i	4	1	3		
-15v Phase Lock Loop Ch 9/14 Intercept	1837	1840	i	4	1	3	volts	
-15v Phase Lock Loop Ch 9/14 Slope	1841	1844	i	4	1	3		
LO Voltage 50.3 GHz Ch 3 Intercept	1845	1848	i	4	1	3	volts	3
LO Voltage 50.3 GHz Ch 3 Slope	1849	1852	i	4	1	3		3
LO Voltage 52.8 GHz Ch 4 Intercept	1853	1856	i	4	1	3	volts	3
LO Voltage 52.8 GHz Ch 4 Slope	1857	1860	i	4	1	3		3
LO Voltage 53.596 GHz Ch 5 Intercept	1861	1864	i	4	1	3	volts	3
LO Voltage 53.596 GHz Ch 5 Slope	1865	1868	i	4	1	3		3
LO Voltage 54.4 GHz Ch 6 Intercept	1869	1872	i	4	1	3	volts	3
LO Voltage 54.4 GHz Ch 6 Slope	1873	1876	i	4	1	3		3
LO Voltage 54.94 GHz Ch 7 Intercept	1877	1880	i	4	1	3	volts	3
LO Voltage 54.94 GHz Ch 7 Slope	1881	1884	i	4	1	3		3
LO Voltage 55.5 GHz Ch 8 Intercept	1885	1888	i	4	1	3	volts	3
LO Voltage 55.5 GHz Ch 8 Slope	1889	1892	i	4	1	3		3
PLLO Primary Lock Detect Intercept	1893	1896	i	4	1	3	volts	
PLLO Primary Lock Detect Slope	1897	1900	i	4	1	3		
PLLO Redundant Lock Detect Intercept	1901	1904	i	4	1	3	volts	
PLLO Redundant Lock Detect Slope	1905	1908	i	4	1	3		
GDO Voltage 89.0 GHz Ch 15 Intercept	1909	1912	i	4	1	3	volts	3
GDO Voltage 89.0 GHz Ch 15 Slope	1913	1916	i	4	1	3		3
<Zero Fill>	1917	1920	i	4	1	0		

AMSU-A2 DIGITAL A CONVERSION

Counts-to-temperature conversion coefficients for the AMSU-A2 digital A telemetry items.

Scan Motor Temp. Conv. Coeff 0	1921	1924	i	4	1	4	K	
Scan Motor Temp. Conv. Coeff 1	1925	1928	i	4	1	9	K/count	
Scan Motor Temp. Conv. Coeff 2	1929	1932	i	4	1	16	K/count ²	
Scan Motor Temp. Conv. Coeff 3	1933	1936	i	4	1	20	K/count ³	
Feed Horn Temp. Conv. Coeff 0	1937	1940	i	4	1	4	K	
Feed Horn Temp. Conv. Coeff 1	1941	1944	i	4	1	9	K/count	
Feed Horn Temp. Conv. Coeff 2	1945	1948	i	4	1	16	K/count ²	
Feed Horn Temp. Conv. Coeff 3	1949	1952	i	4	1	20	K/count ³	
RF Mux/Diplexer Temp. Conv. Coeff 0	1953	1956	i	4	1	4	K	2
RF Mux/Diplexer Temp. Conv. Coeff 1	1957	1960	i	4	1	9	K/count	2
RF Mux/Diplexer Temp. Conv. Coeff 2	1961	1964	i	4	1	16	K/count ²	2
RF Mux/Diplexer Temp. Conv. Coeff 3	1965	1968	i	4	1	20	K/count ³	2
Mixer/IF Amplifier Channel 1 Temp. Conv. Coeff 0	1969	1972	i	4	1	4	K	
Mixer/IF Amplifier Channel 1 Temp. Conv. Coeff 1	1973	1976	i	4	1	9	K/count	
Mixer/IF Amplifier Channel 1 Temp. Conv. Coeff 2	1977	1980	i	4	1	16	K/count ²	
Mixer/IF Amplifier Channel 1 Temp. Conv. Coeff 3	1981	1984	i	4	1	20	K/count ³	
Mixer/IF Amplifier Channel 2 Temp. Conv. Coeff 0	1985	1988	i	4	1	4	K	
Mixer/IF Amplifier Channel 2 Temp. Conv. Coeff 1	1989	1992	i	4	1	9	K/count	
Mixer/IF Amplifier Channel 2 Temp. Conv. Coeff 2	1993	1996	i	4	1	16	K/count ²	
Mixer/IF Amplifier Channel 2 Temp. Conv. Coeff 3	1997	2000	i	4	1	20	K/count ³	
Local Oscillator Channel 1 Temp. Conv. Coeff 0	2001	2004	i	4	1	4	K	

Local Oscillator Channel 1 Temp. Conv. Coeff 1	2005	2008	i	4	1	9	K/count	
Local Oscillator Channel 1 Temp. Conv. Coeff 2	2009	2012	i	4	1	16	K/count ²	
Local Oscillator Channel 1 Temp. Conv. Coeff 3	2013	2016	i	4	1	20	K/count ³	
Local Oscillator Channel 2 Temp. Conv. Coeff 0	2017	2020	i	4	1	4	K	
Local Oscillator Channel 2 Temp. Conv. Coeff 1	2021	2024	i	4	1	9	K/count	
Local Oscillator Channel 2 Temp. Conv. Coeff 2	2025	2028	i	4	1	16	K/count ²	
Local Oscillator Channel 2 Temp. Conv. Coeff 3	2029	2032	i	4	1	20	K/count ³	
Compensation Motor Temp. Conv. Coeff 0	2033	2036	i	4	1	4	K	
Compensation Motor Temp. Conv. Coeff 1	2037	2040	i	4	1	9	K/count	
Compensation Motor Temp. Conv. Coeff 2	2041	2044	i	4	1	16	K/count ²	
Compensation Motor Temp. Conv. Coeff 3	2045	2048	i	4	1	20	K/count ³	
Subreflector Temp. Conv. Coeff 0	2049	2052	i	4	1	4	K	
Subreflector Temp. Conv. Coeff 1	2053	2056	i	4	1	9	K/count	
Subreflector Temp. Conv. Coeff 2	2057	2060	i	4	1	16	K/count ²	
Subreflector Temp. Conv. Coeff 3	2061	2064	i	4	1	20	K/count ³	
DC/DC Converter Temp. Conv. Coeff 0	2065	2068	i	4	1	4	K	
DC/DC Converter Temp. Conv. Coeff 1	2069	2072	i	4	1	9	K/count	
DC/DC Converter Temp. Conv. Coeff 2	2073	2076	i	4	1	16	K/count ²	
DC/DC Converter Temp. Conv. Coeff 3	2077	2080	i	4	1	20	K/count ³	
RF Shelf Temp. Conv. Coeff 0	2081	2084	i	4	1	4	K	
RF Shelf Temp. Conv. Coeff 1	2085	2088	i	4	1	9	K/count	
RF Shelf Temp. Conv. Coeff 2	2089	2092	i	4	1	16	K/count ²	
RF Shelf Temp. Conv. Coeff 3	2093	2096	i	4	1	20	K/count ³	
Detector/preamp Assembly Temp. Conv. Coeff 0	2097	2100	i	4	1	4	K	
Detector/preamp Assembly Temp. Conv. Coeff 1	2101	2104	i	4	1	9	K/count	
Detector/preamp Assembly Temp. Conv. Coeff 2	2105	2108	i	4	1	16	K/count ²	
Detector/preamp Assembly Temp. Conv. Coeff 3	2109	2112	i	4	1	20	K/count ³	
Warm Load Center Temp. Conv. Coeff 0	2113	2116	i	4	1	4	K	
Warm Load Center Temp. Conv. Coeff 1	2117	2120	i	4	1	9	K/count	
Warm Load Center Temp. Conv. Coeff 2	2121	2124	i	4	1	16	K/count ²	
Warm Load Center Temp. Conv. Coeff 3	2125	2128	i	4	1	20	K/count ³	
Warm Load 1 Temp. Conv. Coeff 0	2129	2132	i	4	1	4	K	
Warm Load 1 Temp. Conv. Coeff 1	2133	2136	i	4	1	9	K/count	
Warm Load 1 Temp. Conv. Coeff 2	2137	2140	i	4	1	16	K/count ²	
Warm Load 1 Temp. Conv. Coeff 3	2141	2144	i	4	1	20	K/count ³	
Warm Load 2 Temp. Conv. Coeff 0	2145	2148	i	4	1	4	K	
Warm Load 2 Temp. Conv. Coeff 1	2149	2152	i	4	1	9	K/count	
Warm Load 2 Temp. Conv. Coeff 2	2153	2156	i	4	1	16	K/count ²	
Warm Load 2 Temp. Conv. Coeff 3	2157	2160	i	4	1	20	K/count ³	
Warm Load 3 Temp. Conv. Coeff 0	2161	2164	i	4	1	4	K	
Warm Load 3 Temp. Conv. Coeff 1	2165	2168	i	4	1	9	K/count	
Warm Load 3 Temp. Conv. Coeff 2	2169	2172	i	4	1	16	K/count ²	
Warm Load 3 Temp. Conv. Coeff 3	2173	2176	i	4	1	20	K/count ³	
Warm Load 4 Temp. Conv. Coeff 0	2177	2180	i	4	1	4	K	
Warm Load 4 Temp. Conv. Coeff 1	2181	2184	i	4	1	9	K/count	
Warm Load 4 Temp. Conv. Coeff 2	2185	2188	i	4	1	16	K/count ²	
Warm Load 4 Temp. Conv. Coeff 3	2189	2192	i	4	1	20	K/count ³	
Warm Load 5 Temp. Conv. Coeff 0	2193	2196	i	4	1	4	K	
Warm Load 5 Temp. Conv. Coeff 1	2197	2200	i	4	1	9	K/count	
Warm Load 5 Temp. Conv. Coeff 2	2201	2204	i	4	1	16	K/count ²	

Warm Load 5 Temp. Conv. Coeff 3	2205	2208	i	4	1	20	K/count ³	
Warm Load 6 Temp. Conv. Coeff 0	2209	2212	i	4	1	4	K	
Warm Load 6 Temp. Conv. Coeff 1	2213	2216	i	4	1	9	K/count	
Warm Load 6 Temp. Conv. Coeff 2	2217	2220	i	4	1	16	K/count ²	
Warm Load 6 Temp. Conv. Coeff 3	2221	2224	i	4	1	20	K/count ³	
<Zero Fill>	2225	2228	i	4	1	0		
AMSU-A2 ANALOG TELEMETRY CONVERSION								
<i>Volts-to-engineering units (e.g., temperature in Celsius) conversion coefficients for the AMSU-A2 analog telemetry items. (NOTE: 1 count = 0.02 volts.)</i>								
A2 Scan Motor Temp Intercept	2229	2232	i	4	1	3	K	
A2 Scan Motor Temp Slope	2233	2236	i	4	1	3	K/volt	
Compensator Motor Temp Intercept	2237	2240	i	4	1	3	K	
Compensator Motor Temp Slope	2241	2244	i	4	1	3	K/volt	
RF Shelf Temp Intercept	2245	2248	i	4	1	3	K	
RF Shelf Temp Slope	2249	2252	i	4	1	3	K/volt	
Warm Load Temp Intercept	2253	2256	i	4	1	3	K	
Warm Load Temp Slope	2257	2260	i	4	1	3	K/volt	
Compensator Motor Current Intercept	2261	2264	i	4	1	3	mA	
Compensator Motor Current Slope	2265	2268	i	4	1	3	mA/volt	
Antenna Motor Current Intercept	2269	2272	i	4	1	3	mA	
Antenna Motor Current Slope	2273	2276	i	4	1	3	mA/volt	
+15v Signal Processing Intercept	2277	2280	i	4	1	3	volts	
+15v Signal Processing Slope	2281	2284	i	4	1	3		
+15v Antenna Drive Intercept	2285	2288	i	4	1	3	volts	
+15v Antenna Drive Slope	2289	2292	i	4	1	3		
-15v Signal Processing Intercept	2293	2296	i	4	1	3	volts	
-15v Signal Processing Slope	2297	2300	i	4	1	3		
-15v Antenna Drive Intercept	2301	2304	i	4	1	3	volts	
-15v Antenna Drive Slope	2305	2308	i	4	1	3		
+8v Receiver Amps Intercept (NOAA-KLM) or +10v Receiver/Mixer/IF Amps Intercept (NOAA-NN', Metop)	2309	2312	i	4	1	3	volts	
+8v Receiver Amps Slope (NOAA-KLM) or +10v Receiver/Mixer/IF Amps Slope (NOAA-NN', Metop)	2313	2316	i	4	1	3		
+5v Signal Processing Intercept	2317	2320	i	4	1	3	volts	
+5v Signal Processing Slope	2321	2324	i	4	1	3		
+5v Antenna Drive Intercept	2325	2328	i	4	1	3	volts	
+5v Antenna Drive Slope	2329	2332	i	4	1	3		
LO Voltage 23.8 GHz Ch 1 Intercept	2333	2336	i	4	1	3	volts	3
LO Voltage 23.8 GHz Ch 1 Slope	2337	2340	i	4	1	3		3
LO Voltage 31.4 GHz Ch 2 Intercept	2341	2344	i	4	1	3	volts	3
LO Voltage 31.4 GHz Ch 2 Slope	2345	2348	i	4	1	3		3
<Zero Fill>	2349	2560	i	4	53	0		

8.3.1.6.2.2 NOAA-N Format (Version 4, post-January 25, 2006, All Spacecraft)

The AMSU-A Data Set Header Record format (Version 4, post-January 25, 2006, All Spacecraft) is documented in Table 8.3.1.6.2.2-1. See the legend in Section 8.3.1.1 for further explanation of the headings on this table.

Table 8.3.1.6.2.2-1. Format of AMSU-A Data Set Header Record (Version 4, post-January 25, 2006, All Spacecraft).								
Field Name	Start Octet	End Octet	DT	Word Size	Number of Words	SF	Units	Notes
FILE IDENTIFICATION								
Data Set Creation Site ID CMS=Centre de Meteorologie Spatiale/France DSS=Dundee Satellite Receiving Station/UK NSS=National Environmental Satellite, Data and Information Service/USA UKM=United Kingdom Meteorological Office/UK	1	3	c	3	1	0		
<ASCII blank = x20>	4	4	c	1	1	0		
Level 1b Format Version Number	5	6	u	2	1	0		
Level 1b Format Version Year (e.g., 2000)	7	8	u	2	1	0		
Level 1b Format Version Day of Year (e.g., 365)	9	10	u	2	1	0		
<Reserved for Logical Record Length> (<i>For Creation Site use only. Logical Record Length of source 1b data set prior to processing.</i>)	11	12	u	2	1	0	octets	
<Reserved for Block Size> (<i>For Creation Site use only. Block Size of source 1b data set prior to processing.</i>)	13	14	u	2	1	0	octets	
Count of Header Records in this Data Set	15	16	u	2	1	0		
<zero fill>	17	22	i	2	3	0		
Data Set Name	23	64	c	42	1	0		
Processing Block Identification	65	72	c	8	1	0		
NOAA Spacecraft Identification Code 2=NOAA-16 4=NOAA-15 6=NOAA-17 7=NOAA-18 8=NOAA-N' 11=MetOp-1 12=MetOp-A	73	74	u	2	1	0		
Instrument ID Word 1: AMSU-A2 ID Number 6= PFM, s/n 102 (NOAA-15) 10= FM 1, s/n 103 (NOAA-16) 14=FM 2, s/n 104 (NOAA-17) 18=FM 3, s/n 105 (NOAA-N) 26=FM 5, s/n 107 (NOAA-N')	75	76	u	1	2	0		

Word 2: AMSU-A1 ID Number 5=PFM, s/n 102 (NOAA-16) 9=FM 1, s/n 103 (NOAA-15) 13=FM 2, s/n 104 (NOAA-17) 17=FM 3, s/n 105 (NOAA-N') 33=FM 7, s/n 109 (NOAA-N)								
Data Type Code	77	78	u	2	1	0		
10=AMSU-A								
TIP Source Code 0=unused, i.e., GAC/HRPT/LAC data 1=GAC-embedded AMSU and TIP 2=stored TIP (STIP) 3=HRPT/LAC-embedded AMSU and TIP 4=stored AIP (SAIP)	79	80	u	2	1	0		
Start of Data Set Day Count starting from 0 at 00h, 1 Jan 1950	81	84	u	4	1	0		
Start of Data Set Year (e.g., 2000)	85	86	u	2	1	0		
Start of Data Set Day of Year (e.g., 365)	87	88	u	2	1	0		
Start of Data Set UTC Time of Day	89	92	u	4	1	0	milli-seconds	
End of Data Set Day Count starting from 0 at 00h, 1 Jan 1950	93	96	u	4	1	0		
End of Data Set Year (e.g., 2000)	97	98	u	2	1	0		
End of Data Set Day of Year (e.g., 365)	99	100	u	2	1	0		
End of Data Set UTC Time of Day	101	104	u	4	1	0	milli-seconds	
Year of Last CPIDS Update (e.g., 2000)	105	106	u	2	1	0		
Day of Year of Last CPIDS Update (e.g., 365)	107	108	u	2	1	0		
Offset between Start of Scan and Center of First FOV	109	110	i	2	1	0	milli-seconds	
<zero fill>	111	120	i	2	5	0		
DATA SET QUALITY INDICATORS								
Instrument Status A2 (<i>see "Digital B Telemetry for AMSU-A2" field in data record</i>) bits 31-15: <zero fill> bit 14: cold cal position, msb bit 13: cold cal position, lsb bit 12: antenna in nadir position (0=no; 1=yes) bit 11: antenna in cold cal position (0=no; 1=yes) bit 10: antenna in warm cal position (0=no; 1=yes) bit 9: full scan mode (0=no; 1=yes) bits 5-8: <zero fill> bit 4: survival heater (0=off; 1=on) bit 3: module power (0=disconnect; 1=connect) bit 2: compensator motor (0=off; 1=on) bit 1: scanner A2 power (0=off; 1=on) bit 0: <zero fill>	121	124	u	4	1	0		
<zero fill>	125	126	i	2	1	0		

Record Number of Status Change of A2 (if 0, none occurred)	127	128	u	2	1	0		
Second Instrument Status A2 (if previous word is 0, no change)	129	132	u	4	1	0		
Instrument Status A1 (see "Digital B Telemetry for AMSU-A1" field in data record) bits 31-15: <zero fill> bit 14: cold cal position, msb bit 13: cold cal position, lsb bit 12: antenna in nadir position (0=no; 1=yes) bit 11: antenna in cold cal position (0=no; 1=yes) bit 10: antenna in warm cal position (0=no; 1=yes) bit 9: full scan mode (0=no; 1=yes) bits 8-6: <zero fill> bit 5: module power (0=disconnect; 1=connect) bit 4: survival heater (0=off; 1=on) bit 3: phase lock loop (0=redundant; 1=primary) bit 2: scanner A1-2 power (0=off; 1=on) bit 1: scanner A1-1 power (0=off; 1=on) bit 0: <zero fill>	133	136	u	4	1	0		
<zero fill>	137	138	i	2	1	0		
Record Number of Status Change of A1 (if 0, none occurred)	139	140	u	2	1	0		
Second Instrument Status A1 (if previous word is 0, no change)	141	144	u	4	1	0		
Count of Data Records in this Data Set	145	146	u	2	1	0		
Count of Calibrated, Earth Located Scan Lines in this Data Set	147	148	u	2	1	0		
Count of Missing Scan Lines	149	150	u	2	1	0		
Count of Data Gaps in this Data Set	151	152	u	2	1	0		
Count of Data Frames Without Frame Sync Word Errors	153	154	u	2	1	0		
Count of PACS Detected TIP Parity Errors	155	156	u	2	1	0		
Sum of All Auxiliary Sync Errors Detected in the Input Data	157	158	u	2	1	0		
Time Sequence Error 0=none; otherwise, the record number of the first occurrence	159	160	u	2	1	0		

Time Sequence Error Code (<i>These are bit flags taken from "Scan Line Quality Flags [Time Problem Code]" on data record reported in "Time Sequence Error" field above. If a bit is on (=1) then the statement is true.</i>) bits 15-8: <zero fill> bit 7: time field is bad but can probably be inferred from the previous good time bit 6: time field is bad and can't be inferred from the previous good time bit 5: this record starts a sequence that is inconsistent with previous times (i.e., there is a time discontinuity); may be associated with a spacecraft clock update bit 4: start of a sequence that apparently repeats scan times that have been previously accepted bits 3-0: <zero fill>	161	162	u	2	1	0		
SOCC Clock Update Indicator 0=none during this orbit; otherwise, the record number of the first occurrence	163	164	u	2	1	0		
Earth Location Error Indicator 0=none during this orbit; otherwise, the record number of the first occurrence	165	166	u	2	1	0		
Earth Location Error Code (<i>These are bit flags taken from "Scan Line Quality Flags [Earth Location Problem Code]" on data record reported in "Earth Location Error Indicator" field above. If a bit is on (=1) then the statement is true.</i>) bits 15-8: <zero fill> bit 7: not earth located because of bad time; earth location fields zero-filled bit 6: earth location questionable: questionable time code bit 5: earth location questionable: marginal agreement with reasonableness check bit 4: earth location questionable: fails reasonableness check bit 3: earth location questionable because of antenna position checkbits 2-0: <zero fill>	167	168	u	2	1	0		
PACS Status Bit Field bits 15-3: <zero fill> bit 2: pseudonoise (0=normal data; 1=pseudonoise data) bit 1: tape direction (0=reverse playback, time decrementing) bit 0: data mode (0=test data; 1=flight data)	169	170	u	2	1	0		

Data Source	171	172	u	2	1	0		
0=unused 1=Fairbanks, AK 2=Wallops Is., VA 3=SOCC 4=Svalbard, Norway 5=Monterey, CA								
<zero fill>	173	176	i	4	1	0		
<Reserved for the Ingester>	177	184	c	8	1	0		
<Reserved for Decommutation>	185	192	c	8	1	0		
<zero fill>	193	208	i	4	4	0		
CALIBRATION								
<zero fill>	209	210	i	2	1	0		
Instrument Temperature Sensor ID	211	216	u	2	3	0		2
Word 1: 0=RF Shelf A1-1; 1=RF Mux A1-1 Word 2: 0=RF Shelf A1-2; 1=RF Mux A1-2 Word 3: 0=RF Shelf A2; 1=RF Mux/Diplexer A2								
RF Shelf A1-1 Minimum Reference Temperature, PLLO#1	217	218	i	2	1	2	K	
RF Shelf A1-1 Nominal Reference Temperature, PLLO#1	219	220	i	2	1	2	K	
RF Shelf A1-1 Maximum Reference Temperature, PLLO#1	221	222	i	2	1	2	K	
RF Shelf A1-2 Minimum Reference Temperature	223	224	i	2	1	2	K	
RF Shelf A1-2 Nominal Reference Temperature	225	226	i	2	1	2	K	
RF Shelf A1-2 Maximum Reference Temperature	227	228	i	2	1	2	K	
RF Shelf A2 Minimum Reference Temperature	229	230	i	2	1	2	K	
RF Shelf A2 Nominal Reference Temperature	231	232	i	2	1	2	K	
RF Shelf A2 Maximum Reference Temperature	233	234	i	2	1	2	K	
RF Shelf A1-1 Minimum Reference Temperature, PLLO#2	235	236	i	2	1	2	K	
RF Shelf A1-1 Nominal Reference Temperature, PLLO#2	237	238	i	2	1	2	K	
RF Shelf A1-1 Maximum Reference Temperature, PLLO#2	239	240	i	2	1	2	K	
RF Mux A1-1 Minimum Reference Temperature, PLLO#1	241	242	i	2	1	2	K	
RF Mux A1-1 Nominal Reference Temperature, PLLO#1	243	244	i	2	1	2	K	
RF Mux A1-1 Maximum Reference Temperature, PLLO#1	245	246	i	2	1	2	K	
RF Mux A1-2 Minimum Reference Temperature	247	248	i	2	1	2	K	
RF Mux A1-2 Nominal Reference Temperature	249	250	i	2	1	2	K	
RF Mux A1-2 Maximum Reference Temperature	251	252	i	2	1	2	K	
RF/Mux/Diplexer A2 Minimum Reference Temperature	253	254	i	2	1	2	K	2
RF/Mux/Diplexer A2 Nominal Reference	255	256	i	2	1	2	K	2

Temperature								
RF/Mux/Diplexer A2 Minimum Reference Temperature	257	258	i	2	1	2	K	2
RF Mux A1-1 Minimum Reference Temperature, PLL0#2	259	260	i	2	1	2	K	
RF Mux A1-1 Nominal Reference Temperature, PLL0#2	261	262	i	2	1	2	K	
RF Mux A1-1 Maximum Reference Temperature, PLL0#2	263	264	i	2	1	2	K	
Warm Target Fixed Bias Corr Ch1 Min RF Shelf Temp	265	266	i	2	1	3	K	
Warm Target Fixed Bias Corr Ch1 Nom RF Shelf Temp	267	268	i	2	1	3	K	
Warm Target Fixed Bias Corr Ch1 Max RF Shelf Temp	269	270	i	2	1	3	K	
Cold Space Fixed Bias Corr Ch1	271	272	i	2	1	3	K	
Warm Target Fixed Bias Corr Ch2 Min RF Shelf Temp	273	274	i	2	1	3	K	
Warm Target Fixed Bias Corr Ch2 Nom RF Shelf Temp	275	276	i	2	1	3	K	
Warm Target Fixed Bias Corr Ch2 Max RF Shelf Temp	277	278	i	2	1	3	K	
Cold Space Fixed Bias Corr Ch2	279	280	i	2	1	3	K	
Warm Target Fixed Bias Corr Ch3 Min RF Shelf Temp	281	282	i	2	1	3	K	
Warm Target Fixed Bias Corr Ch3 Nom RF Shelf Temp	283	284	i	2	1	3	K	
Warm Target Fixed Bias Corr Ch3 Max RF Shelf Temp	285	286	i	2	1	3	K	
Cold Space Fixed Bias Corr Ch3	287	288	i	2	1	3	K	
Warm Target Fixed Bias Corr Ch4 Min RF Shelf Temp	289	290	i	2	1	3	K	
Warm Target Fixed Bias Corr Ch4 Nom RF Shelf Temp	291	292	i	2	1	3	K	
Warm Target Fixed Bias Corr Ch4 Max RF Shelf Temp	293	294	i	2	1	3	K	
Cold Space Fixed Bias Corr Ch4	295	296	i	2	1	3	K	
Warm Target Fixed Bias Corr Ch5 Min RF Shelf Temp	297	298	i	2	1	3	K	
Warm Target Fixed Bias Corr Ch5Nom RF Shelf Temp	299	300	i	2	1	3	K	
Warm Target Fixed Bias Corr Ch5 Max RF Shelf Temp	301	302	i	2	1	3	K	
Cold Space Fixed Bias Corr Ch5	303	304	I	2	1	3	K	
Warm Target Fixed Bias Corr Ch6 Min RF Shelf Temp	305	306	i	2	1	3	K	
Warm Target Fixed Bias Corr Ch6 Nom RF Shelf Temp	307	308	i	2	1	3	K	
Warm Target Fixed Bias Corr Ch6 Max RF Shelf	309	310	i	2	1	3	K	

Temp								
Cold Space Fixed Bias Corr Ch6	311	312	i	2	1	3	K	
Warm Target Fixed Bias Corr Ch7 Min RF Shelf Temp	313	314	i	2	1	3	K	
Warm Target Fixed Bias Corr Ch7 Nom RF Shelf Temp	315	316	i	2	1	3	K	
Warm Target Fixed Bias Corr Ch7 Max RF Shelf Temp	317	318	i	2	1	3	K	
Cold Space Fixed Bias Corr Ch7	319	320	i	2	1	3	K	
Warm Target Fixed Bias Corr Ch8 Min RF Shelf Temp	321	322	i	2	1	3	K	
Warm Target Fixed Bias Corr Ch8 Nom RF Shelf Temp	323	324	i	2	1	3	K	
Warm Target Fixed Bias Corr Ch8 Max RF Shelf Temp	325	326	i	2	1	3	K	
Cold Space Fixed Bias Corr Ch8	327	328	i	2	1	3	K	
Warm Target Fixed Bias Corr Ch9 Min RF Shelf Temp	329	330	i	2	1	3	K	
Warm Target Fixed Bias Corr Ch9 Nom RF Shelf Temp	331	332	i	2	1	3	K	
Warm Target Fixed Bias Corr Ch9 Max RF Shelf Temp	333	334	i	2	1	3	K	
Cold Space Fixed Bias Corr Ch9	335	336	i	2	1	3	K	
Warm Target Fixed Bias Corr Ch10 Min RF Shelf Temp	337	338	i	2	1	3	K	
Warm Target Fixed Bias Corr Ch10 Nom RF Shelf Temp	339	340	i	2	1	3	K	
Warm Target Fixed Bias Corr Ch10 Max RF Shelf Temp	341	342	i	2	1	3	K	
Cold Space Fixed Bias Corr Ch10	343	344	i	2	1	3	K	
Warm Target Fixed Bias Corr Ch11 Min RF Shelf Temp	345	346	i	2	1	3	K	
Warm Target Fixed Bias Corr Ch11 Nom RF Shelf Temp	347	348	i	2	1	3	K	
Warm Target Fixed Bias Corr Ch11 Max RF Shelf Temp	349	350	i	2	1	3	K	
Cold Space Fixed Bias Corr Ch11	351	352	i	2	1	3	K	
Warm Target Fixed Bias Corr Ch12 Min RF Shelf Temp	353	354	i	2	1	3	K	
Warm Target Fixed Bias Corr Ch12 Nom RF Shelf Temp	355	356	i	2	1	3	K	
Warm Target Fixed Bias Corr Ch12 Max RF Shelf Temp	357	258	i	2	1	3	K	
Cold Space Fixed Bias Corr Ch12	359	360	i	2	1	3	K	
Warm Target Fixed Bias Corr Ch13 Min RF Shelf Temp	361	362	i	2	1	3	K	
Warm Target Fixed Bias Corr Ch13 Nom RF Shelf Temp	363	364	i	2	1	3	K	

Warm Target Fixed Bias Corr Ch13 Max RF Shelf Temp	365	366	i	2	1	3	K	
Cold Space Fixed Bias Corr Ch13	367	368	i	2	1	3	K	
Warm Target Fixed Bias Corr Ch14 Min RF Shelf Temp	369	370	i	2	1	3	K	
Warm Target Fixed Bias Corr Ch14 Nom RF Shelf Temp	371	372	i	2	1	3	K	
Warm Target Fixed Bias Corr Ch14 Max RF Shelf Temp	373	374	i	2	1	3	K	
Cold Space Fixed Bias Corr Ch14	375	376	i	2	1	3	K	
Warm Target Fixed Bias Corr Ch15 Min RF Shelf Temp	377	378	i	2	1	3	K	
Warm Target Fixed Bias Corr Ch15 Nom RF Shelf Temp	379	380	i	2	1	3	K	
Warm Target Fixed Bias Corr Ch15 Max RF Shelf Temp	381	382	i	2	1	3	K	
Cold Space Fixed Bias Corr Ch15	383	384	i	2	1	3	K	
Warm Target Bias Corr Ch9 at PLL0#2 RF Shelf A1-1 Min Ref Temp	385	386	i	2	1	3	K	
Warm Target Bias Corr Ch9 at PLL0#2 RF Shelf A1-1 Nom Ref Temp	387	388	i	2	1	3	K	
Warm Target Bias Corr Ch9 at PLL0#2 RF Shelf A1-1 Max Ref Temp	389	390	i	2	1	3	K	
Warm Target Bias Corr Ch10 at PLL0#2 RF Shelf A1-1 Min Ref Temp	391	392	i	2	1	3	K	
Warm Target Bias Corr Ch10 at PLL0#2 RF Shelf A1-1 Nom Ref Temp	393	394	i	2	1	3	K	
Warm Target Bias Corr Ch10 at PLL0#2 RF Shelf A1-1 Max Ref Temp	395	396	i	2	1	3	K	
Warm Target Bias Corr Ch11 at PLL0#2 RF Shelf A1-1 Min Ref Temp	397	398	i	2	1	3	K	
Warm Target Bias Corr Ch11 at PLL0#2 RF Shelf A1-1 Nom Ref Temp	399	400	i	2	1	3	K	
Warm Target Bias Corr Ch11 at PLL0#2 RF Shelf A1-1 Max Ref Temp	401	402	i	2	1	3	K	
Warm Target Bias Corr Ch12 at PLL0#2 RF Shelf A1-1 Min Ref Temp	403	404	i	2	1	3	K	
Warm Target Bias Corr Ch12 at PLL0#2 RF Shelf A1-1 Nom Ref Temp	405	406	i	2	1	3	K	
Warm Target Bias Corr Ch12 at PLL0#2 RF Shelf A1-1 Max Ref Temp	407	408	i	2	1	3	K	
Warm Target Bias Corr Ch13 at PLL0#2 RF Shelf A1-1 Min Ref Temp	409	410	i	2	1	3	K	
Warm Target Bias Corr Ch13 at PLL0#2 RF Shelf A1-1 Nom Ref Temp	411	412	i	2	1	3	K	
Warm Target Bias Corr Ch13 at PLL0#2 RF Shelf A1-1 Max Ref Temp	413	414	i	2	1	3	K	
Warm Target Bias Corr Ch14 at PLL0#2 RF Shelf A1-1 Min Ref Temp	415	416	i	2	1	3	K	

Warm Target Bias Corr Ch14 at PLL0#2 RF Shelf A1-1 Nom Ref Temp	417	418	i	2	1	3	K	
Warm Target Bias Corr Ch14 at PLL0#2 RF Shelf A1-1 Max Ref Temp	419	420	i	2	1	3	K	
Nonlinearity Coef. Ch 1 at Minimum Reference Temperature	421	424	i	4	1	6	m^2 -sr- cm^{-1}/mW	
Nonlinearity Coef. Ch 1 at Nominal Reference Temperature	425	428	i	4	1	6	m^2 -sr- cm^{-1}/mW	
Nonlinearity Coef. Ch 1 at Maximum Reference Temperature	429	432	i	4	1	6	m^2 -sr- cm^{-1}/mW	
Nonlinearity Coef. Ch 2 at Minimum Reference Temperature	433	436	i	4	1	6	m^2 -sr- cm^{-1}/mW	
Nonlinearity Coef. Ch 2 at Nominal Reference Temperature	437	440	i	4	1	6	m^2 -sr- cm^{-1}/mW	
Nonlinearity Coef. Ch 2 at Maximum Reference Temperature	441	444	i	4	1	6	m^2 -sr- cm^{-1}/mW	
Nonlinearity Coef. Ch 3 at Minimum Reference Temperature	445	448	i	4	1	6	m^2 -sr- cm^{-1}/mW	
Nonlinearity Coef. Ch 3 at Nominal Reference Temperature	449	452	i	4	1	6	m^2 -sr- cm^{-1}/mW	
Nonlinearity Coef. Ch 3 at Maximum Reference Temperature	453	456	i	4	1	6	m^2 -sr- cm^{-1}/mW	
Nonlinearity Coef. Ch 4 at Minimum Reference Temperature	457	460	i	4	1	6	m^2 -sr- cm^{-1}/mW	
Nonlinearity Coef. Ch 4 at Nominal Reference Temperature	461	464	i	4	1	6	m^2 -sr- cm^{-1}/mW	
Nonlinearity Coef. Ch 4 at Maximum Reference Temperature	465	468	i	4	1	6	m^2 -sr- cm^{-1}/mW	
Nonlinearity Coef. Ch 5 at Minimum Reference Temperature	469	472	i	4	1	6	m^2 -sr- cm^{-1}/mW	
Nonlinearity Coef. Ch 5 at Nominal Reference Temperature	473	476	i	4	1	6	m^2 -sr- cm^{-1}/mW	
Nonlinearity Coef. Ch 5 at Maximum Reference Temperature	477	480	i	4	1	6	m^2 -sr- cm^{-1}/mW	
Nonlinearity Coef. Ch 6 at Minimum Reference Temperature	481	484	i	4	1	6	m^2 -sr- cm^{-1}/mW	
Nonlinearity Coef. Ch 6 at Nominal Reference Temperature	485	488	i	4	1	6	m^2 -sr- cm^{-1}/mW	
Nonlinearity Coef. Ch 6 at Maximum Reference Temperature	489	492	i	4	1	6	m^2 -sr- cm^{-1}/mW	
Nonlinearity Coef. Ch 7 at Minimum Reference Temperature	493	496	i	4	1	6	m^2 -sr- cm^{-1}/mW	
Nonlinearity Coef. Ch 7 at Nominal Reference Temperature	497	500	i	4	1	6	m^2 -sr- cm^{-1}/mW	
Nonlinearity Coef. Ch 7 at Maximum Reference Temperature	501	504	i	4	1	6	m^2 -sr- cm^{-1}/mW	
Nonlinearity Coef. Ch 8 at Minimum Reference Temperature	505	508	i	4	1	6	m^2 -sr- cm^{-1}/mW	

Nonlinearity Coef. Ch 8 at Nominal Reference Temperature	509	512	i	4	1	6	m ² -sr-cm ⁻¹ /mW	
Nonlinearity Coef. Ch 8 at Maximum Reference Temperature	513	516	i	4	1	6	m ² -sr-cm ⁻¹ /mW	
Nonlinearity Coef. Ch 9 at Minimum Reference Temperature	517	520	i	4	1	6	m ² -sr-cm ⁻¹ /mW	
Nonlinearity Coef. Ch 9 at Nominal Reference Temperature	521	524	i	4	1	6	m ² -sr-cm ⁻¹ /mW	
Nonlinearity Coef. Ch 9 at Maximum Reference Temperature	525	528	i	4	1	6	m ² -sr-cm ⁻¹ /mW	
Nonlinearity Coef. Ch 10 at Minimum Reference Temperature	529	532	i	4	1	6	m ² -sr-cm ⁻¹ /mW	
Nonlinearity Coef. Ch 10 at Nominal Reference Temperature	533	536	i	4	1	6	m ² -sr-cm ⁻¹ /mW	
Nonlinearity Coef. Ch 10 at Maximum Reference Temperature	537	540	i	4	1	6	m ² -sr-cm ⁻¹ /mW	
Nonlinearity Coef. Ch 11 at Minimum Reference Temperature	541	544	i	4	1	6	m ² -sr-cm ⁻¹ /mW	
Nonlinearity Coef. Ch 11 at Nominal Reference Temperature	545	548	i	4	1	6	m ² -sr-cm ⁻¹ /mW	
Nonlinearity Coef. Ch 11 at Maximum Reference Temperature	549	552	i	4	1	6	m ² -sr-cm ⁻¹ /mW	
Nonlinearity Coef. Ch 12 at Minimum Reference Temperature	553	556	i	4	1	6	m ² -sr-cm ⁻¹ /mW	
Nonlinearity Coef. Ch 12 at Nominal Reference Temperature	557	560	i	4	1	6	m ² -sr-cm ⁻¹ /mW	
Nonlinearity Coef. Ch 12 at Maximum Reference Temperature	561	564	i	4	1	6	m ² -sr-cm ⁻¹ /mW	
Nonlinearity Coef. Ch 13 at Minimum Reference Temperature	565	568	i	4	1	6	m ² -sr-cm ⁻¹ /mW	
Nonlinearity Coef. Ch 13 at Nominal Reference Temperature	569	572	i	4	1	6	m ² -sr-cm ⁻¹ /mW	
Nonlinearity Coef. Ch 13 at Maximum Reference Temperature	573	576	i	4	1	6	m ² -sr-cm ⁻¹ /mW	
Nonlinearity Coef. Ch 14 at Minimum Reference Temperature	577	580	i	4	1	6	m ² -sr-cm ⁻¹ /mW	
Nonlinearity Coef. Ch 14 at Nominal Reference Temperature	581	584	i	4	1	6	m ² -sr-cm ⁻¹ /mW	
Nonlinearity Coef. Ch 14 at Maximum Reference Temperature	585	588	i	4	1	6	m ² -sr-cm ⁻¹ /mW	
Nonlinearity Coef. Ch 15 at Minimum Reference Temperature	589	592	i	4	1	6	m ² -sr-cm ⁻¹ /mW	
Nonlinearity Coef. Ch 15 at Nominal Reference Temperature	593	596	i	4	1	6	m ² -sr-cm ⁻¹ /mW	
Nonlinearity Coef. Ch 15 at Maximum Reference Temperature	597	600	i	4	1	6	m ² -sr-cm ⁻¹ /mW	
Nonlinearity Coef. Ch 9 for PLL0 #2 at Minimum Reference Temperature	601	604	i	4	1	6	m ² -sr-cm ⁻¹ /mW	

Nonlinearity Coef. Ch 9 for PLLO #2 at Nominal Reference Temperature	605	608	i	4	1	6	m ² -sr-cm ⁻¹ /mW	
Nonlinearity Coef. Ch 9 for PLLO #2 at Maximum Reference Temperature	609	612	i	4	1	6	m ² -sr-cm ⁻¹ /mW	
Nonlinearity Coef. Ch 10 for PLLO #2 at Minimum Reference Temperature	613	616	i	4	1	6	m ² -sr-cm ⁻¹ /mW	
Nonlinearity Coef. Ch 10 for PLLO #2 at Nominal Reference Temperature	617	620	i	4	1	6	m ² -sr-cm ⁻¹ /mW	
Nonlinearity Coef. Ch 10 for PLLO #2 at Maximum Reference Temperature	621	624	i	4	1	6	m ² -sr-cm ⁻¹ /mW	
Nonlinearity Coef. Ch 11 for PLLO #2 at Minimum Reference Temperature	625	628	i	4	1	6	m ² -sr-cm ⁻¹ /mW	
Nonlinearity Coef. Ch 11 for PLLO #2 at Nominal Reference Temperature	629	632	i	4	1	6	m ² -sr-cm ⁻¹ /mW	
Nonlinearity Coef. Ch 11 for PLLO #2 at Maximum Reference Temperature	633	636	i	4	1	6	m ² -sr-cm ⁻¹ /mW	
Nonlinearity Coef. Ch 12 for PLLO #2 at Minimum Reference Temperature	637	640	i	4	1	6	m ² -sr-cm ⁻¹ /mW	
Nonlinearity Coef. Ch 12 for PLLO #2 at Nominal Reference Temperature	641	644	i	4	1	6	m ² -sr-cm ⁻¹ /mW	
Nonlinearity Coef. Ch 12 for PLLO #2 at Maximum Reference Temperature	645	648	i	4	1	6	m ² -sr-cm ⁻¹ /mW	
Nonlinearity Coef. Ch 13 for PLLO #2 at Minimum Reference Temperature	649	652	i	4	1	6	m ² -sr-cm ⁻¹ /mW	
Nonlinearity Coef. Ch 13 for PLLO #2 at Nominal Reference Temperature	653	656	i	4	1	6	m ² -sr-cm ⁻¹ /mW	
Nonlinearity Coef. Ch 13 for PLLO #2 at Maximum Reference Temperature	657	660	i	4	1	6	m ² -sr-cm ⁻¹ /mW	
Nonlinearity Coef. Ch 14 for PLLO #2 at Minimum Reference Temperature	661	664	i	4	1	6	m ² -sr-cm ⁻¹ /mW	
Nonlinearity Coef. Ch 14 for PLLO #2 at Nominal Reference Temperature	665	668	i	4	1	6	m ² -sr-cm ⁻¹ /mW	
Nonlinearity Coef. Ch 14 for PLLO #2 at Maximum Reference Temperature	669	672	i	4	1	6	m ² -sr-cm ⁻¹ /mW	
<zero fill>	673	688	i	4	4	0		
Temperature-Radiance Conversion								
Temperature-radiance Ch 1 Central Wavenumber	689	692	i	4	1	6	cm ⁻¹	
Temperature-radiance Ch 1 Constant 1	693	696	i	4	1	6		
Temperature-radiance Ch 1 Constant 2, Slope	697	700	i	4	1	6		
Temperature-radiance Ch 2 Central Wavenumber	701	704	i	4	1	6	cm ⁻¹	
Temperature-radiance Ch 2 Constant 1	705	708	i	4	1	6		
Temperature-radiance Ch 2 Constant 2, Slope	709	712	i	4	1	6		
Temperature-radiance Ch 3 Central Wavenumber	713	716	i	4	1	6	cm ⁻¹	
Temperature-radiance Ch 3 Constant 1	717	720	i	4	1	6		
Temperature-radiance Ch 3 Constant 2, Slope	721	724	i	4	1	6		
Temperature-radiance Ch 4 Central Wavenumber	725	728	i	4	1	6	cm ⁻¹	
Temperature-radiance Ch 4 Constant 1	729	732	i	4	1	6		

Temperature-radiance Ch 4 Constant 2, Slope	733	736	i	4	1	6		
Temperature-radiance Ch 5 Central Wavenumber	737	740	i	4	1	6	cm ⁻¹	
Temperature-radiance Ch 5 Constant 1	741	744	i	4	1	6		
Temperature-radiance Ch 5 Constant 2, Slope	745	748	i	4	1	6		
Temperature-radiance Ch 6 Central Wavenumber	749	752	i	4	1	6	cm ⁻¹	
Temperature-radiance Ch 6 Constant 1	753	756	i	4	1	6		
Temperature-radiance Ch 6 Constant 2, Slope	757	760	i	4	1	6		
Temperature-radiance Ch 7 Central Wavenumber	761	764	i	4	1	6	cm ⁻¹	
Temperature-radiance Ch 7 Constant 1	765	768	i	4	1	6		
Temperature-radiance Ch 7 Constant 2, Slope	769	772	i	4	1	6		
Temperature-radiance Ch 8 Central Wavenumber	773	776	i	4	1	6	cm ⁻¹	
Temperature-radiance Ch 8 Constant 1	777	780	i	4	1	6		
Temperature-radiance Ch 8 Constant 2, Slope	781	784	i	4	1	6		
Temperature-radiance Ch 9 Central Wavenumber	785	788	i	4	1	6	cm ⁻¹	
Temperature-radiance Ch 9 Constant 1	789	792	i	4	1	6		
Temperature-radiance Ch 9 Constant 2, Slope	793	796	i	4	1	6		
Temperature-radiance Ch 10 Central Wavenumber	797	800	i	4	1	6	cm ⁻¹	
Temperature-radiance Ch 10 Constant 1	801	804	i	4	1	6		
Temperature-radiance Ch 10 Constant 2, Slope	805	808	i	4	1	6		
Temperature-radiance Ch 11 Central Wavenumber	809	812	i	4	1	6	cm ⁻¹	
Temperature-radiance Ch 11 Constant 1	813	816	i	4	1	6		
Temperature-radiance Ch 11 Constant 2, Slope	807	820	i	4	1	6		
Temperature-radiance Ch 12 Central Wavenumber	821	824	i	4	1	6	cm ⁻¹	
Temperature-radiance Ch 12 Constant 1	825	828	i	4	1	6		
Temperature-radiance Ch 12 Constant 2, Slope	829	832	i	4	1	6		
Temperature-radiance Ch 13 Central Wavenumber	833	836	i	4	1	6	cm ⁻¹	
Temperature-radiance Ch 13 Constant 1	837	840	i	4	1	6		
Temperature-radiance Ch 13 Constant 2, Slope	841	844	i	4	1	6		
Temperature-radiance Ch 14 Central Wavenumber	845	848	i	4	1	6	cm ⁻¹	
Temperature-radiance Ch 14 Constant 1	849	852	i	4	1	6		
Temperature-radiance Ch 14 Constant 2, Slope	853	856	i	4	1	6		
Temperature-radiance Ch 15 Central Wavenumber	857	860	i	4	1	6	cm ⁻¹	
Temperature-radiance Ch 15 Constant 1	861	864	i	4	1	6		
Temperature-radiance Ch 15 Constant 2, Slope	865	868	i	4	1	6		
<zero fill>	869	880	i	4	3	0		
Navigation								
Reference Ellipsoid Model ID (The ellipsoid is a mathematically tractable approximation of the geoid, which is an equipotential surface at mean sea level. The maximum departure of the ellipsoid from the geoid is approximately ± 65)	881	888	c	8	1	0		

meters.) WGS-72 = World Geodetic Survey 1972 JGM3 =Joint Gravity Model 3								
Nadir Earth Location Tolerance	889	890	u	2	1	1	km	
Earth Location Bit Field bits 15-3: <zero fill> bit 2: dynamic attitude error correction (0=not performed; 1=performed) bit 1: reasonableness test (0=inactive; 1=active) bit 0: constant attitude error correction (0=not performed; 1=performed)	891	892	u	2	1	0		
<zero fill>	893	894	i	2	1	0		
Constant Roll Attitude Error	895	896	i	2	1	3	Degrees	
Constant Pitch Attitude Error	897	898	i	2	1	3	Degrees	
Constant Yaw Attitude Error	899	900	i	2	1	3	Degrees	
Epoch Year for Orbit Vector (e.g., 1999)	901	902	u	2	1	0		
Day of Epoch Year for Orbit Vector (e.g., 365)	903	904	u	2	1	0		
Epoch UTC Time of Day for Orbit Vector	905	908	u	4	1	0	Milli-seconds	
Semi-major Axis (at the orbit vector epoch time)	909	912	i	4	1	5	km	
Eccentricity (at the orbit vector epoch time)	913	916	i	4	1	8		
Inclination (at the orbit vector epoch time)	917	920	i	4	1	5	Degrees	
Argument of Perigee (at orbit vector epoch time)	921	924	i	4	4	5	Degrees	
Right Ascension of the Ascending Node (at the orbit vector epoch time)	925	928	i	4	1	5	Degrees	
Mean Anomaly (at the orbit vector epoch time)	929	932	i	4	1	5	Degrees	
Position Vector X Component (at the orbit vector epoch time)	933	936	i	4	1	5	km	
Position Vector Y Component (at the orbit vector epoch time)	937	940	i	4	1	5	km	
Position Vector Z Component (at the orbit vector epoch time)	941	944	i	4	1	5	km	
Position Vector X-dot Component (at the orbit vector epoch time)	945	948	i	4	1	8	Km/sec	
Position Vector Y-dot Component (at the orbit vector epoch time)	949	952	i	4	1	8	Km/sec	
Position Vector Z-dot Component (at the orbit vector epoch time)	953	956	i	4	1	8	Km/sec	
Earth/Sun Distance Ration (at the orbit vector epoch time; relative to the mean distance of 1 AU)	957	960	u	4	1	6		
<zero fill>	961	976	i	4	4	0		
AMSU-A1 Digital A Conversion								
<i>Counts-to-temperature conversion coefficients for the AMSU-A1 digital A telemetry items.</i>								
Scan Motor A1-1 Temperature Coefficient 0	977	980	i	4	1	4	K	
Scan Motor A1-1 Temperature Coefficient 1	981	984	i	4	1	9	K/count	
Scan Motor A1-1 Temperature Coefficient 2	985	988	i	4	1	16	K/count ²	
Scan Motor A1-1 Temperature Coefficient 3	989	992	i	4	1	20	K/count ³	
Scan Motor A1-2 Temperature Coefficient 0	993	996	i	4	1	4	K	
Scan Motor A1-2 Temperature Coefficient 1	997	1000	i	4	1	9	K/count	

Scan Motor A1-2 Temperature Coefficient 2	1001	1004	i	4	1	16	K/count ²	
Scan Motor A1-2 Temperature Coefficient 3	1005	1008	i	4	1	20	K/count ³	
Feed Horn A1-1 Temperature Coefficient 0	1009	1012	i	4	1	4	K	
Feed Horn A1-1 Temperature Coefficient 1	1013	1016	i	4	1	9	K/count	
Feed Horn A1-1 Temperature Coefficient 2	1017	1020	i	4	1	16	K/count ²	
Feed Horn A1-1 Temperature Coefficient 3	1021	1024	i	4	1	20	K/count ³	
Feed Horn A1-2 Temperature Coefficient 0	1025	1028	i	4	1	4	K	
Feed Horn A1-2 Temperature Coefficient 1	1029	1032	i	4	1	9	K/count	
Feed Horn A1-2 Temperature Coefficient 2	1033	1036	i	4	1	16	K/count ²	
Feed Horn A1-2 Temperature Coefficient 3	1037	1040	i	4	1	20	K/count ³	
RF Mux A1-1 Temperature Coefficient 0	1041	1044	i	4	1	4	K	
RF Mux A1-1 Temperature Coefficient 1	1045	1048	i	4	1	9	K/count	
RF Mux A1-1 Temperature Coefficient 2	1049	1052	i	4	1	16	K/count ²	
RF Mux A1-1 Temperature Coefficient 3	1053	1056	i	4	1	20	K/count ³	
RF Mux A1-2 Temperature Coefficient 0	1057	1060	i	4	1	4	K	
RF Mux A1-2 Temperature Coefficient 1	1061	1064	i	4	1	9	K/count	
RF Mux A1-2 Temperature Coefficient 2	1065	1068	i	4	1	16	K/count ²	
RF Mux A1-2 Temperature Coefficient 3	1069	1072	i	4	1	20	K/count ³	
Local Oscillator Channel 3 Temperature Coefficient 0	1073	1076	i	4	1	4	K	
Local Oscillator Channel 3 Temperature Coefficient 1	1077	1080	i	4	1	9	K/count	
Local Oscillator Channel 3 Temperature Coefficient 2	1081	1084	i	4	1	16	K/count ²	
Local Oscillator Channel 3 Temperature Coefficient 3	1085	1088	i	4	1	20	K/count ³	
Local Oscillator Channel 4 Temperature Coefficient 0	1089	1092	i	4	1	4	K	
Local Oscillator Channel 4 Temperature Coefficient 1	1093	1096	i	4	1	9	K/count	
Local Oscillator Channel 4 Temperature Coefficient 2	1097	1100	i	4	1	16	K/count ²	
Local Oscillator Channel 4 Temperature Coefficient 3	1101	1104	i	4	1	20	K/count ³	
Local Oscillator Channel 5 Temperature Coefficient 0	1105	1108	i	4	1	4	K	
Local Oscillator Channel 5 Temperature Coefficient 1	1109	1112	i	4	1	9	K/count	
Local Oscillator Channel 5 Temperature Coefficient 2	1103	1116	i	4	1	16	K/count ²	
Local Oscillator Channel 5 Temperature Coefficient 3	1107	1120	i	4	1	20	K/count ³	
Local Oscillator Channel 6 Temperature Coefficient 0	1121	1124	i	4	1	4	K	
Local Oscillator Channel 6 Temperature Coefficient 1	1125	1128	i	4	1	9	K/count	
Local Oscillator Channel 6 Temperature Coefficient 2	1129	1132	i	4	1	16	K/count ²	

Local Oscillator Channel 6 Temperature Coefficient 3	1133	1136	i	4	1	20	K/count ³	
Local Oscillator Channel 7 Temperature Coefficient 0	1137	1140	i	4	1	4	K	
Local Oscillator Channel 7 Temperature Coefficient 1	1141	1144	i	4	1	9	K/count	
Local Oscillator Channel 7 Temperature Coefficient 2	1145	1148	i	4	1	16	K/count ²	
Local Oscillator Channel 7 Temperature Coefficient 3	1149	1152	i	4	1	20	K/count ³	
Local Oscillator Channel 8 Temperature Coefficient 0	1153	1156	i	4	1	4	K	
Local Oscillator Channel 8 Temperature Coefficient 1	1157	1160	i	4	1	9	K/count	
Local Oscillator Channel 8 Temperature Coefficient 2	1161	1164	i	4	1	16	K/count ²	
Local Oscillator Channel 8 Temperature Coefficient 3	1165	1168	i	4	1	20	K/count ³	
Local Oscillator Channel 15 Temperature Coefficient 0	1169	1172	i	4	1	4	K	
Local Oscillator Channel 15 Temperature Coefficient 1	1173	1176	i	4	1	9	K/count	
Local Oscillator Channel 15 Temperature Coefficient 2	1177	1180	i	4	1	16	K/count ²	
Local Oscillator Channel 15 Temperature Coefficient 3	1181	1184	i	4	1	20	K/count ³	
PLLO #2 Channels 9 Through 14 Temperature Coefficient 0	1185	1188	i	4	1	4	K	
PLLO #2 Channels 9 Through 14 Temperature Coefficient 1	1189	1192	i	4	1	9	K/count	
PLLO #2 Channels 9 Through 14 Temperature Coefficient 2	1193	1196	i	4	1	16	K/count ²	
PLLO #2 Channels 9 Through 14 Temperature Coefficient 3	1197	1200	i	4	1	20	K/count ³	
PLLO #1 Channels 9 Through 14 Temperature Coefficient 0	1201	1204	i	4	1	4	K	
PLLO #1 Channels 9 Through 14 Temperature Coefficient 1	1205	1208	i	4	1	9	K/count	
PLLO #1 Channels 9 Through 14 Temperature Coefficient 2	1209	1212	i	4	1	16	K/count ²	
PLLO #1 Channels 9 Through 14 Temperature Coefficient 3	1213	1216	i	4	1	20	K/count ³	
PLLO (Reference Oscillator) Temperature Coefficient 0 (NOAA KLM) or <zero fill> (NOAA-N-N')	1217	1220	i	4	1	4	K	
PLLO (Reference Oscillator) Temperature Coefficient 1 (NOAA KLM) or <zero fill> (NOAA-N-N')	1221	1224	i	4	1	9	K/count	
PLLO (Reference Oscillator) Temperature	1225	1228	i	4	1	16	K/count ²	

Coefficient 2 (NOAA KLM) or <zero fill> (NOAA-N-N')								
PLLO (Reference Oscillator) Temperature Coefficient 3 (NOAA KLM) or <zero fill> (NOAA-N-N')	1229	1232	i	4	1	20	K/count ³	
Mixer/IF Amplifier Channel 3 Temperature Coefficient 0	1233	1236	i	4	1	4	K	
Mixer/IF Amplifier Channel 3 Temperature Coefficient 1	1237	1240	i	4	1	9	K/count	
Mixer/IF Amplifier Channel 3 Temperature Coefficient 2	1241	1244	i	4	1	16	K/count ²	
Mixer/IF Amplifier Channel 3 Temperature Coefficient 3	1245	1248	i	4	1	20	K/count ³	
Mixer/IF Amplifier Channel 4 Temperature Coefficient 0	1249	1252	i	4	1	4	K	
Mixer/IF Amplifier Channel 4 Temperature Coefficient 1	1253	1256	i	4	1	9	K/count	
Mixer/IF Amplifier Channel 4 Temperature Coefficient 2	1257	1260	i	4	1	16	K/count ²	
Mixer/IF Amplifier Channel 4 Temperature Coefficient 3	1261	1264	i	4	1	20	K/count ³	
Mixer/IF Amplifier Channel 5 Temperature Coefficient	1265	1268	i	4	1	4	K	
Mixer/IF Amplifier Channel 5 Temperature Coefficient 1	1269	1272	i	4	1	9	K/count	
Mixer/IF Amplifier Channel 5 Temperature Coefficient 2	1273	1276	i	4	1	16	K/count ²	
Mixer/IF Amplifier Channel 5 Temperature Coefficient 3	1277	1280	i	4	1	20	K/count ³	
Mixer/IF Amplifier Channel 6 Temperature Coefficient 0	1281	1284	i	4	1	4	K	
Mixer/IF Amplifier Channel 6 Temperature Coefficient 1	1285	1288	i	4	1	9	K/count	
Mixer/IF Amplifier Channel 6 Temperature Coefficient 2	1289	1292	i	4	1	16	K/count ²	
Mixer/IF Amplifier Channel 6 Temperature Coefficient 3	1293	1296	i	4	1	20	K/count ³	
Mixer/IF Amplifier Channel 7 Temperature Coefficient 0	1297	1300	i	4	1	4	K	
Mixer/IF Amplifier Channel 7 Temperature Coefficient 1	1301	1304	i	4	1	9	K/count	
Mixer/IF Amplifier Channel 7 Temperature Coefficient 2	1305	1308	i	4	1	16	K/count ²	
Mixer/IF Amplifier Channel 7 Temperature Coefficient 3	1309	1312	i	4	1	20	K/count ³	
Mixer/IF Amplifier Channel 8 Temperature Coefficient 0	1313	1316	i	4	1	4	K	
Mixer/IF Amplifier Channel 8 Temperature Coefficient 1	1317	1320	i	4	1	9	K/count	

Mixer/IF Amplifier Channel 8 Temperature Coefficient 2	1321	1324	i	4	1	16	K/count ²	
Mixer/IF Amplifier Channel 8 Temperature Coefficient 3	1325	1328	i	4	1	20	K/count ³	
Mixer/IF Amplifier Channel 9/14 Temperature Coefficient 0	1329	1332	i	4	1	4	K	
Mixer/IF Amplifier Channel 9/14 Temperature Coefficient 1	1333	1336	i	4	1	9	K/count	
Mixer/IF Amplifier Channel 9/14 Temperature Coefficient 2	1337	1340	i	4	1	16	K/count ²	
Mixer/IF Amplifier Channel 9/14 Temperature Coefficient 3	1341	1344	i	4	1	20	K/count ³	
Mixer/IF Amplifier Channel 15 Temperature Coefficient 0	1345	1348	i	4	1	4	K	
Mixer/IF Amplifier Channel 15 Temperature Coefficient 1	1349	1352	i	4	1	9	K/count	
Mixer/IF Amplifier Channel 15 Temperature Coefficient 2	1353	1356	i	4	1	16	K/count ²	
Mixer/IF Amplifier Channel 15 Temperature Coefficient 3	1357	1360	i	4	1	20	K/count ³	
IF Amplifier Channel 11/14 Temperature Coefficient 0	1361	1364	i	4	1	4	K	
IF Amplifier Channel 11/14 Temperature Coefficient 1	1365	1368	i	4	1	9	K/count	
IF Amplifier Channel 11/14 Temperature Coefficient 2	1369	1372	i	4	1	16	K/count ²	
IF Amplifier Channel 11/14 Temperature Coefficient 3	1373	1376	i	4	1	20	K/count ³	
IF Amplifier Channel 9 Temperature Coefficient 0	1377	1380	i	4	1	4	K	
IF Amplifier Channel 9 Temperature Coefficient 1	1381	1384	i	4	1	9	K/count	
IF Amplifier Channel 9 Temperature Coefficient 2	1385	1388	i	4	1	16	K/count ²	
IF Amplifier Channel 9 Temperature Coefficient 3	1389	1392	i	4	1	20	K/count ³	
IF Amplifier Channel 10 Temperature Coefficient 0	1393	1396	i	4	1	4	K	
IF Amplifier Channel 10 Temperature Coefficient 1	1397	1400	i	4	1	9	K/count	
IF Amplifier Channel 10 Temperature Coefficient 2	1401	1404	i	4	1	16	K/count ²	
IF Amplifier Channel 10 Temperature Coefficient 3	1405	1408	i	4	1	20	K/count ³	
IF Amplifier Channel 11 Temperature Coefficient 0	1409	1412	i	4	1	4	K	
IF Amplifier Channel 11 Temperature Coefficient 1	1413	1416	i	4	1	9	K/count	
IF Amplifier Channel 11 Temperature Coefficient 2	1417	1420	i	4	1	16	K/count ²	
IF Amplifier Channel 11 Temperature Coefficient 3	1421	1424	i	4	1	20	K/count ³	
DC/DC Converter Temperature Coefficient 0	1425	1428	i	4	1	4	K	

DC/DC Converter Temperature Coefficient 1	1429	1432	i	4	1	9	K/count	
DC/DC Converter Temperature Coefficient 2	1433	1436	i	4	1	16	K/count ²	
DC/DC Converter Temperature Coefficient 3	1437	1440	i	4	1	20	K/count ³	
IF Amplifier Channel 13 Temperature Coefficient 0	1441	1444	i	4	1	4	K	
IF Amplifier Channel 13 Temperature Coefficient 0	1445	1448	i	4	1	9	K/count	
IF Amplifier Channel 13 Temperature Coefficient 0	1449	1452	i	4	1	16	K/count ²	
IF Amplifier Channel 13 Temperature Coefficient 0	1453	1456	i	4	1	20	K/count ³	
IF Amplifier Channel 14 Temperature Coefficient 0	1457	1460	i	4	1	4	K	
IF Amplifier Channel 14 Temperature Coefficient 1	1461	1464	i	4	1	9	K/count	
IF Amplifier Channel 14 Temperature Coefficient 2	1465	1468	i	4	1	16	K/count ²	
IF Amplifier Channel 14 Temperature Coefficient 3	1469	1472	i	4	1	20	K/count ³	
IF Amplifier Channel 12 Temperature Coefficient 0	1473	1476	i	4	1	4	K	
IF Amplifier Channel 12 Temperature Coefficient 1	1477	1480	i	4	1	9	K/count	
IF Amplifier Channel 12 Temperature Coefficient 2	1481	1484	i	4	1	16	K/count ²	
IF Amplifier Channel 12 Temperature Coefficient 3	1485	1488	i	4	1	20	K/count ³	
RF Shelf A1-1 Temperature Coefficient 0	1489	1492	i	4	1	4	K	
RF Shelf A1-1 Temperature Coefficient 1	1493	1496	i	4	1	9	K/count	
RF Shelf A1-1 Temperature Coefficient 2	1497	1500	i	4	1	16	K/count ²	
RF Shelf A1-1 Temperature Coefficient 3	1501	1504	i	4	1	20	K/count ³	
RF Shelf A1-2 Temperature Coefficient 0	1505	1508	i	4	1	4	K	
RF Shelf A1-2 Temperature Coefficient 1	1509	1512	i	4	1	9	K/count	
RF Shelf A1-2 Temperature Coefficient 2	1513	1516	i	4	1	16	K/count ²	
RF Shelf A1-2 Temperature Coefficient 3	1517	1520	i	4	1	20	K/count ³	
Detector/preamp Assembly Temperature Coefficient 0	1521	1524	i	4	1	4	K	
Detector/preamp Assembly Temperature Coefficient 1	1525	1528	i	4	1	9	K/count	
Detector/preamp Assembly Temperature Coefficient 2	1529	1532	i	4	1	16	K/count ²	
Detector/preamp Assembly Temperature Coefficient 3	1533	1536	i	4	1	20	K/count ³	
A1-1 Warm Load 1 Temperature Coefficient 0	1537	1540	i	4	1	4	K	
A1-1 Warm Load 1 Temperature Coefficient 1	1541	1544	i	4	1	9	K/count	
A1-1 Warm Load 1 Temperature Coefficient 2	1545	1548	i	4	1	16	K/count ²	
A1-1 Warm Load 1 Temperature Coefficient 3	1549	1552	i	4	1	20	K/count ³	
A1-1 Warm Load 2 Temperature Coefficient 0	1553	1556	i	4	1	4	K	

A1-1 Warm Load 2 Temperature Coefficient 1	1557	1560	i	4	1	9	K/count	
A1-1 Warm Load 2 Temperature Coefficient 2	1561	1564	i	4	1	16	K/count ²	
A1-1 Warm Load 2 Temperature Coefficient 3	1565	1568	i	4	1	20	K/count ³	
A1-1 Warm Load 3 Temperature Coefficient 0	1569	1572	i	4	1	4	K	
A1-1 Warm Load 3 Temperature Coefficient 1	1573	1576	i	4	1	9	K/count	
A1-1 Warm Load 3 Temperature Coefficient 2	1577	1580	i	4	1	16	K/count ²	
A1-1 Warm Load 3 Temperature Coefficient 3	1581	1584	i	4	1	20	K/count ³	
A1-1 Warm Load 4 Temperature Coefficient 0	1585	1588	i	4	1	4	K	
A1-1 Warm Load 4 Temperature Coefficient 1	1589	1592	i	4	1	9	K/count	
A1-1 Warm Load 4 Temperature Coefficient 2	1593	1596	i	4	1	16	K/count ²	
A1-1 Warm Load 4 Temperature Coefficient 3	1597	1600	i	4	1	20	K/count ³	
A1-1 Warm Load Center Temperature Coefficient 0	1601	1604	i	4	1	4	K	
A1-1 Warm Load Center Temperature Coefficient 1	1605	1608	i	4	1	9	K/count	
A1-1 Warm Load Center Temperature Coefficient 2	1609	1612	i	4	1	16	K/count ²	
A1-1 Warm Load Center Temperature Coefficient 3	1613	1616	i	4	1	20	K/count ³	
A1-2 Warm Load 1 Temperature Coefficient 0	1617	1620	i	4	1	4	K	
A1-2 Warm Load 1 Temperature Coefficient 1	1621	1624	i	4	1	9	K/count	
A1-2 Warm Load 1 Temperature Coefficient 2	1625	1628	i	4	1	16	K/count ²	
A1-2 Warm Load 1 Temperature Coefficient 3	1629	1632	i	4	1	20	K/count ³	
A1-2 Warm Load 2 Temperature Coefficient 0	1633	1636	i	4	1	4	K	
A1-2 Warm Load 2 Temperature Coefficient 1	1637	1640	i	4	1	9	K/count	
A1-2 Warm Load 2 Temperature Coefficient 2	1641	1644	i	4	1	16	K/count ²	
A1-2 Warm Load 2 Temperature Coefficient 3	1645	1648	i	4	1	20	K/count ³	
A1-2 Warm Load 3 Temperature Coefficient 0	1649	1652	i	4	1	4	K	
A1-2 Warm Load 3 Temperature Coefficient 1	1653	1656	i	4	1	9	K/count	
A1-2 Warm Load 3 Temperature Coefficient 2	1657	1660	i	4	1	16	K/count ²	
A1-2 Warm Load 3 Temperature Coefficient 3	1661	1664	i	4	1	20	K/count ³	
A1-2 Warm Load 4 Temperature Coefficient 0	1665	1668	i	4	1	4	K	
A1-2 Warm Load 4 Temperature Coefficient 1	1669	1672	i	4	1	9	K/count	
A1-2 Warm Load 4 Temperature Coefficient 2	1673	1676	i	4	1	16	K/count ²	
A1-2 Warm Load 4 Temperature Coefficient 3	1677	1680	i	4	1	20	K/count ³	
A1-2 Warm Load Center Temperature Coefficient 0	1681	1684	i	4	1	4	K	
A1-2 Warm Load Center Temperature Coefficient 1	1685	1688	i	4	1	9	K/count	
A1-2 Warm Load Center Temperature Coefficient 2	1689	1692	i	4	1	16	K/count ²	
A1-2 Warm Load Center Temperature Coefficient 3	1693	1696	i	4	1	20	K/count ³	
<zero fill>	1697	1700	i	4	1	0		
AMSU-A1 Analog Telemetry Conversion								
<i>Volts to engineering units (e.g., temperature in Kelvin) conversion coefficients for the AMSU-A1 analog telemetry items.</i>								
<i>(Note: 1 count = 0.02 volts)</i>								

A1-1 Scan Motor Temp Intercept	1701	1704	i	4	1	3	K	
A1-1 Scan Motor Temp Slope	1705	1708	i	4	1	3	K/volt	
A1-2 Scan Motor Temp Intercept	1709	1712	i	4	1	3	K	
A1-2 Scan Motor Temp Slope	1713	1716	i	4	1	3	K/volt	
A1-1 RF Shelf Temp Intercept	1717	1720	i	4	1	3	K	
A1-1 RF Shelf Temp Slope	1721	1724	i	4	1	3	K/volt	
A1-2 RF Shelf Temp Intercept	1725	1728	i	4	1	3	K	
A1-2 RF Shelf Temp Slope	1729	1732	i	4	1	3	K/volt	
A1-1 Warm LoadTemp Intercept	1733	1736	i	4	1	3	K	
A1-1 Warm LoadTemp Slope	1737	1740	i	4	1	3	K/volt	
A1-2 Warm Load Temp Intercept	1741	1744	i	4	1	3	K	
A1-2 Warm Load Temp Slope	1745	1748	i	4	1	3	K/volt	
A1-1 Antenna Motor Current Intercept	1749	1752	i	4	1	3	milli-amps	
A1-1 Antenna Motor Current Slope	1753	1756	i	4	1	3	milli-amps/volt	
A1-2 Antenna Motor Current Intercept	1757	1760	i	4	1	3	milli-amps	
A1-2 Antenna Motor Current Slope	1761	1764	i	4	1	3	milli-amps/volt	
+15v Signal Processing Intercept	1765	1768	i	4	1	3	volts	
+15v Signal Processing Slope	1769	1772	i	4	1	3		
+15v Antenna Drive Intercept	1773	1776	i	4	1	3	volts	
+15v Antenna Drive Slope	1777	1780	i	4	1	3		
-15v Signal Processing Intercept	1781	1784	i	4	1	3	volts	
-15v Signal Processing Slope	1785	1788	i	4	1	3		
-15v Antenna Drive Intercept	1789	1792	i	4	1	3	volts	
-15v Antenna Drive Slope	1793	1796	i	4	1	3		
+8v Receiver Amps Intercept	1797	1800	i	4	1	3	volts	
+8v Receiver Amps Slope	1801	1804	i	4	1	3		
+5v Signal Processing Intercept	1805	1808	i	4	1	3	volts	
+5v Signal Processing Slope	1809	1812	i	4	1	3		
+5v Antenna Drive Intercept	1813	1816	i	4	1	3	volts	
+5v Antenna Drive Slope	1817	1820	i	4	1	3		
+8.5v Phase Lock Loop Ch 9/14 Intercept (NOAA KLM) or +10 VDC Receiver Mixer/IF Intercept (NOAA-N,-N')	1821	1824	i	4	1	3	volts	
+8.5v Phase Lock Loop Ch 9/14 Slope (NOAA KLM) or +10 VDC Receiver Mixer/IF Slope (NOAA-N,-N')	1825	1828	i	4	1	3		
+15v Phase Lock Loop Ch 9/14 Intercept	1829	1832	i	4	1	3	volts	
+15v Phase Lock Loop Ch 9/14 Slope	1833	1836	i	4	1	3		
-15v Phase Lock Loop Ch 9/14 Intercept	1837	1840	i	4	1	3	volts	
-15v Phase Lock Loop Ch 9/14 Slope	1841	1844	i	4	1	3		
LO Voltage 50.3 GHz Ch 3 Intercept	1845	1848	i	4	1	3	volts	3
LO Voltage 50.3 GHz Ch 3 Slope	1849	1852	i	4	1	3		3
LO Voltage 52.8 GHz Ch 4 Intercept	1853	1858	i	4	1	3	volts	3

LO Voltage 52.8 GHz Ch 4 Slope	1857	1860	i	4	1	3		3
LO Voltage 53.596 GHz Ch 5 Intercept	1861	1864	i	4	1	3	volts	3
LO Voltage 53.596 GHz Ch 5 Slope	1865	1868	i	4	1	3		3
LO Voltage 54.4 GHz Ch 6 Intercept	1869	1872	i	4	1	3	volts	3
LO Voltage 54.4 GHz Ch 6 Slope	1873	1876	i	4	1	3		3
LO Voltage 54.94 GHz Ch 7 Intercept	1877	1880	i	4	1	3	volts	3
LO Voltage 54.94 GHz Ch 7 Slope	1881	1884	i	4	1	3		3
LO Voltage 55.5 GHz Ch 8 Intercept	1885	1888	i	4	1	3	volts	3
LO Voltage 55.5 GHz Ch 8 Slope	1889	1892	i	4	1	3		3
PLLO Primary Lock Detect Intercept	1893	1896	i	4	1	3	volts	
PLLO Primary Lock Detect Slope	1897	1900	i	4	1	3		
PLLO Redundant Lock Detect Intercept	1901	1904	i	4	1	3	volts	
PLLO Redundant Lock Detect Slope	1905	1908	i	4	1	3		
GDO Voltage 89.0 GHz Ch 15 Intercept	1909	1912	i	4	1	3		3
GDO Voltage 89.0 GHz Ch 15 Slope	1913	1916	i	4	1	3	volts	3
<zero fill>	1917	1920	i	4	1	3		
AMSU-A2 DIGITAL A CONVERSION								
<i>Counts to temperature conversion coefficients for the AMSU-A2 digital A telemetry items.</i>								
Scan Motor Temp. Conv. Coeff 0	1921	1924	i	4	1	4	K	
Scan Motor Temp. Conv. Coeff 1	1925	1928	i	4	1	9	K/count	
Scan Motor Temp. Conv. Coeff 2	1929	1932	i	4	1	16	K/count ²	
Scan Motor Temp. Conv. Coeff 3	1933	1936	i	4	1	20	K/count ³	
Feed Horn Temp. Conv. Coeff 0	1937	1940	i	4	1	4	K	
Feed Horn Temp. Conv. Coeff 1	1941	1944	i	4	1	9	K/count	
Feed Horn Temp. Conv. Coeff 2	1945	1948	i	4	1	16	K/count ²	
Feed Horn Temp. Conv. Coeff 3	1949	1952	i	4	1	20	K/count ³	
RF Mux/Diplexer Temp. Conv. Coeff 0	1953	1956	i	4	1	4	K	2
RF Mux/Diplexer Temp. Conv. Coeff 1	1957	1960	i	4	1	9	K/count	2
RF Mux/Diplexer Temp. Conv. Coeff 2	1961	1964	i	4	1	16	K/count ²	2
RF Mux/Diplexer Temp. Conv. Coeff 3	1965	1968	i	4	1	20	K/count ³	2
Mixer/IF Amplifier Channel 1 Temp. Conv. Coeff 0	1969	1972	i	4	1	4	K	
Mixer/IF Amplifier Channel 1 Temp. Conv. Coeff 1	1973	1976	i	4	1	9	K/count	
Mixer/IF Amplifier Channel 1 Temp. Conv. Coeff 2	1977	1980	i	4	1	16	K/count ²	
Mixer/IF Amplifier Channel 1 Temp. Conv. Coeff 3	1981	1984	i	4	1	20	K/count ³	
Mixer/IF Amplifier Channel 2 Temp. Conv. Coeff 0	1985	1988	i	4	1	4	K	
Mixer/IF Amplifier Channel 2 Temp. Conv. Coeff 1	1989	1992	i	4	1	9	K/count	
Mixer/IF Amplifier Channel 2 Temp. Conv. Coeff 2	1993	1996	i	4	1	16	K/count ²	
Mixer/IF Amplifier Channel 2 Temp. Conv. Coeff 3	1997	2000	i	4	1	20	K/count ³	
Local Oscillator Channel 1 Temp. Conv. Coeff 0	2001	2004	i	4	1	4	K	

Local Oscillator Channel 1 Temp. Conv. Coeff 1	2005	2008	i	4	1	9	K/count	
Local Oscillator Channel 1 Temp. Conv. Coeff 2	2009	2012	i	4	1	16	K/count ²	
Local Oscillator Channel 1 Temp. Conv. Coeff 3	2013	2016	i	4	1	20	K/count ³	
Local Oscillator Channel 2 Temp. Conv. Coeff 0	2017	2020	i	4	1	4	K	
Local Oscillator Channel 2 Temp. Conv. Coeff 1	2021	2024	i	4	1	9	K/count	
Local Oscillator Channel 2 Temp. Conv. Coeff 2	2025	2028	i	4	1	16	K/count ²	
Local Oscillator Channel 2 Temp. Conv. Coeff 3	2029	2032	i	4	1	20	K/count ³	
Compensation Motor Temp. Conv. Coeff 0	2033	2036	i	4	1	4	K	
Compensation Motor Temp. Conv. Coeff 1	2037	2040	i	4	1	9	K/count	
Compensation Motor Temp. Conv. Coeff 2	2041	2044	i	4	1	16	K/count ²	
Compensation Motor Temp. Conv. Coeff 3	2045	2048	i	4	1	20	K/count ³	
Subreflector Temp. Conv. Coeff 0	2049	2052	i	4	1	4	K	
Subreflector Temp. Conv. Coeff 1	2053	2056	i	4	1	9	K/count	
Subreflector Temp. Conv. Coeff 2	2057	2060	i	4	1	16	K/count ²	
Subreflector Temp. Conv. Coeff 3	2061	2064	i	4	1	20	K/count ³	
DC/DC Converter Temp. Conv. Coeff 0	2065	2068	i	4	1	4	K	
DC/DC Converter Temp. Conv. Coeff 1	2069	2072	i	4	1	9	K/count	
DC/DC Converter Temp. Conv. Coeff 2	2073	2076	i	4	1	16	K/count ²	
DC/DC Converter Temp. Conv. Coeff 3	2077	2080	i	4	1	20	K/count ³	
RF Shelf Temp. Conv. Coeff 0	2081	2084	i	4	1	4	K	
RF Shelf Temp. Conv. Coeff 1	2085	2088	i	4	1	9	K/count	
RF Shelf Temp. Conv. Coeff 2	2089	2092	i	4	1	16	K/count ²	
RF Shelf Temp. Conv. Coeff 3	2093	2096	i	4	1	20	K/count ³	
Detector/preamp Assembly Temp. Conv. Coeff 0	2097	2100	i	4	1	4	K	
Detector/preamp Assembly Temp. Conv. Coeff 1	2101	2104	i	4	1	9	K/count	
Detector/preamp Assembly Temp. Conv. Coeff 2	2105	2108	i	4	1	16	K/count ²	
Detector/preamp Assembly Temp. Conv. Coeff 3	2109	2112	i	4	1	20	K/count ³	
Warm Load Center Temp. Conv. Coeff 0	2113	2116	i	4	1	4	K	
Warm Load Center Temp. Conv. Coeff 1	2117	2120	i	4	1	9	K/count	
Warm Load Center Temp. Conv. Coeff 2	2121	2124	i	4	1	16	K/count ²	
Warm Load Center Temp. Conv. Coeff 3	2125	2128	i	4	1	20	K/count ³	
Warm Load 1 Temp. Conv. Coeff 0	2129	2132	i	4	1	4	K	
Warm Load 1 Temp. Conv. Coeff 1	2133	2136	i	4	1	9	K/count	
Warm Load 1 Temp. Conv. Coeff 2	2137	2140	i	4	1	16	K/count ²	
Warm Load 1 Temp. Conv. Coeff 3	2141	2144	i	4	1	20	K/count ³	
Warm Load 2 Temp. Conv. Coeff 0	2145	2148	i	4	1	4	K	
Warm Load 2 Temp. Conv. Coeff 1	2149	2152	i	4	1	9	K/count	
Warm Load 2 Temp. Conv. Coeff 2	2153	2156	i	4	1	16	K/count ²	
Warm Load 2 Temp. Conv. Coeff 3	2157	2160	i	4	1	20	K/count ³	
Warm Load 3 Temp. Conv. Coeff 0	2161	2164	i	4	1	4	K	
Warm Load 3 Temp. Conv. Coeff 1	2165	2168	i	4	1	9	K/count	
Warm Load 3 Temp. Conv. Coeff 2	2169	2172	i	4	1	16	K/count ²	
Warm Load 3 Temp. Conv. Coeff 3	2173	2176	i	4	1	20	K/count ³	
Warm Load 4 Temp. Conv. Coeff 0	2177	2180	i	4	1	4	K	
Warm Load 4 Temp. Conv. Coeff 1	2181	2184	i	4	1	9	K/count	
Warm Load 4 Temp. Conv. Coeff 2	2185	2188	i	4	1	16	K/count ²	

Warm Load 4 Temp. Conv. Coeff 3	2189	2192	i	4	1	20	K/count ³	
Warm Load 5 Temp. Conv. Coeff 0	2193	2196	i	4	1	4	K	
Warm Load 5 Temp. Conv. Coeff 1	2197	2200	i	4	1	9	K/count	
Warm Load 5 Temp. Conv. Coeff 2	2201	2204	i	4	1	16	K/count ²	
Warm Load 5 Temp. Conv. Coeff 3	2205	2208	i	4	1	20	K/count ³	
Warm Load 6 Temp. Conv. Coeff 0	2209	2212	i	4	1	4	K	
Warm Load 6 Temp. Conv. Coeff 1	2213	2216	i	4	1	9	K/count	
Warm Load 6 Temp. Conv. Coeff 2	2217	2220	i	4	1	16	K/count ²	
Warm Load 6 Temp. Conv. Coeff 3	2221	2224	i	4	1	20	K/count ³	
<zero fill>	2225	2228	i	4	1	0		
AMSU-A2 ANALOG TELEMETRY CONVERSION								
<i>Volts to engineering units (e.g., temperature in Kelvin) conversion coefficients for the AMSU-A2 analog telemetry items. (Note: 1 count = 0.02 volts.)</i>								
A2 Scan Motor Temp Intercept	2229	2232	i	4	1	3	K	
A2 Scan Motor Temp Slope	2233	2236	i	4	1	3	K/volt	
Compensator Motor Temp Intercept	2237	2240	i	4	1	3	K	
Compensator Motor Temp Slope	2241	2244	i	4	1	3	K/volt	
RF Shelf Temp Intercept	2245	2248	i	4	1	3	K	
RF Shelf Temp Slope	2249	2252	i	4	1	3	K/volt	
Warm Load Temp Intercept	2253	2256	i	4	1	3	K	
Warm Load Temp Slope	2257	2260	i	4	1	3	K/volt	
Compensator Motor Current Intercept	2261	2264	i	4	1	3	milliamp	
Compensator Motor Current Slope	2265	2268	i	4	1	3	milliamp/ volt	
Antenna Motor Current Intercept	2269	2272	i	4	1	3	milliamp	
Antenna Motor Current Intercept	2273	2276	i	4	1	3	milliamp/ volt	
+15v Signal Processing Intercept	2277	2280	i	4	1	3	volts	
+15v Signal Processing Slope	2281	2284	i	4	1	3		
+15v Antenna Drive Intercept	2285	2288	i	4	1	3	volts	
+15v Antenna Drive Slope	2289	2292	i	4	1	3		
-15v Signal Processing Intercept	2293	2296	i	4	1	3	volts	
-15v Signal Processing Slope	2297	2300	i	4	1	3		
-15v Antenna Drive Intercept	2301	2304	i	4	1	3	volts	
-15v Antenna Drive Slope	2305	2308	i	4	1	3		
+8v Receiver Amps Intercept (NOAA KLM) or +10v Receiver/Mixer/IF Amps Intercept (NOAA- N,-N')	2309	2312	i	4	1	3	volts	
+8v Receiver Amps Slope (NOAA KLM) or +10v Receiver/Mixer/IF Amps Slope (NOAA-N,-N')	2313	2316	i	4	1	3		
+5v Signal Processing Intercept	2317	2320	i	4	1	3	volts	
+5v Signal Processing Slope	2321	2324	i	4	1	3		
+5v Antenna Drive Intercept	2325	2328	i	4	1	3	volts	
+5v Antenna Drive Slope	2329	2332	i	4	1	3		
LO Voltage 23.8 GHz Ch 1 Intercept	2333	2336	i	4	1	3	volts	3
LO Voltage 23.8 GHz Ch 1 Slope	2337	2340	i	4	1	3		3
LO Voltage 31.4 GHz Ch 2 Intercept	2341	2344	i	4	1	3	volts	3

LO Voltage 31.4 GHz Ch 2 Slope	2345	2348	i	4	1	3		3
<zero fill>	2349	2356	i	4	2	0		
LUNAR CONTAMINATION CORRECTION								
Count of Scans containing Lunar-Contaminated Space Views (Also, see bits 6 and 7 of "Calibration Quality Flags" field in data record.) -1=the detection algorithm for lunar-contamination is turned off 0=the detection algorithm is turned on: no scans containing lunar-contaminated space views were found 0=the detection algorithm is turned on: the value in this field represents the number of scans found that contain lunar-contaminated space views	2557	2558	i	2	1	0		
Distance between the Earth and Moon (average of distance computed on first and last scans of orbit)	2359	2360	u	2	1	2	Earth radii (R_E)	
Angle between the Moon and Sun (as seen from the earth; average of angle computed on first and last scans of orbit; range: 0 - 180)	2361	2362	u	2	1	2	degrees	
<zero fill>	2363	2364	i	2	1	0		
For NOAA originated AMSU-A data, these fields are spare (<zero fill>)	2365	2400	i	2	18	0		
Filler								
<zero fill>	2401	2560	i	2	80	0		
NOTES:								
1) An AMSU-A instrument on NOAA-N,-N' may produce a brief period of erroneous data during its transition between one mode and another. This transition period is defined as "NO" mode. Some "NO" mode events will occur during on-orbit validation (OV). After OV it is expected that the instrument will be kept in the normal scan mode, and thus will not get into "NO" mode.								
2) For AMSU-A2, "RF Mux" is only applicable for NOAA KLM, while "RF Diplexer" is only applicable for NOAA-N,-N'.								
3) The local oscillators (LOs) for the NOAA KLM AMSU-A instruments are Gunn Diode Oscillators (GDOs). The LOs for channels 1-8 of the NOAA-N,-N' AMSU-A instruments are Dielectric Resonant Oscillators (DROs). A GDO is still used for channel 15.								
4) There are no conversion coefficients available for the last item, "Reference voltage", so none are specified in the header.								

8.3.1.6.3 Data Record Format

8.3.1.6.3.1 NOAA-KLM (Version-2, pre-april 28, 2005)

8.3.1.6.3.2 Format of AMSU-A Data Record Format (Version 4, post-January 25, 2006, All Spacecraft).

Table 8.3.1.6.3.2-1. Format of AMSU-A Data Record Format (Version 4, post-January 25, 2006, All Spacecraft).

Field Name	Start Octet	End Octet	Data Type	Word Size	Number of Words	Scale Factor	Units	Notes
SCAN LINE INFORMATION								
Scan Line Number (<i>cumulative, starting with 1</i>)	1	2	u	2	1	0		
Scan Line Year (<i>four digits, e.g., 2000</i>)	3	4	u	2	1	0		
Scan Line Day of Year (<i>e.g., 365</i>)	5	6	u	2	1	0		
Satellite Clock Drift Delta	7	8	i	2	1	0	milli-sec	
Scan Line UTC Time of Day	9	12	u	4	1	0	milli-sec	
Scan Line Bit Field bit 15: satellite direction (0=northbound; 1=southbound) bit 14: clock drift correction (0=not corrected; 1=scan time corrected for clock drift) bits 13-0: <zero fill>	13	14	u	2	1	0		
Major Frame Count (<i>cumulative, starting with 1</i>) (NOAA) or <Zero Fill> (Metop)	15	16	u	2	1	0		
<Zero Fill>	17	24	i	4	2	0		
QUALITY INDICATORS								
Quality Indicator Bit Field (<i>if a bit is on (=1), the statement is true</i>) bit 31: do not use scan for product generation bit 30: time sequence error detected within this scan (see "Scan Line Quality Flags [Time Problem Code]") bit 29: data gap precedes this scan bit 28: insufficient data for calibration (see "Scan Line Quality Flags [Calibration Problem Code]" and "Scan Line Quality Flags [Additional Calibration Problem Code]") bit 27: earth location data not available (see "Scan Line Quality Flags [Earth Location Problem Code]") bit 26: first good time following a clock update (nominally 0) bit 25: instrument status changed with this scan bits 24-4: <zero fill> bit 3: AMSU sync error detected (NOAA) or <zero fill> (Metop) bit 2: AMSU minor frame error detected (NOAA) or <zero fill> (Metop) bit 1: AMSU major frame error detected (NOAA) or <zero fill> (Metop) bit 0: AMSU parity error detected (NOAA) or <zero fill> (Metop)	25	28	u	4	1	0		
Scan Line Quality Flags [Additional Calibration Problem Code] (<i>If a bit is on (=1), the statement is true. See "Scan Line Quality Flags [Calibration Problem Code]", below.</i>) bits 7-0: <zero fill>	29	29	u	1	1	0		

<p>Scan Line Quality Flags [Time Problem Code] <i>(If a bit is on (=1), the statement is true. All bits off implies the scan time is as expected.)</i></p> <p>bit 7: time field is bad but can probably be inferred from the previous good time bit 6: time field is bad and can't be inferred from the previous good time bit 5: this record starts a sequence that is inconsistent with previous times (i.e., there is a time discontinuity). This may be associated with a spacecraft clock update. (See bit 26, Quality Indicator Bit Field.) bit 4: start of a sequence that apparently repeats scan times that have been previously accepted bits 3-0: <zero fill></p>	30	30	u	1	1	0		
<p>Scan Line Quality Flags [Calibration Problem Code] <i>(If a bit is on (=1), the statement is true. These bits, along with those in "Scan Line Quality Flags [Additional Calibration Problem Code]", complement the channel indicators; all bits set to 0 indicates normal calibration.)</i></p> <p>bit 7: scan line was not calibrated because of bad time bit 6: scan line was calibrated using fewer than the preferred number of scan lines because of proximity to start or end of data set or to a data gap bit 5: scan line was not calibrated because of bad or insufficient PRT data bit 4: scan line was calibrated but with marginal PRT data bit 3: some uncalibrated channels on this scan (see channel indicators) bit 2: uncalibrated due to instrument mode bit 1: questionable calibration because of antenna position error of space view bit 0: questionable calibration because of antenna position error of blackbody view</p>	31	31	u	1	1	0		
<p>Scan Line Quality Flags [Earth Location Problem Code] <i>(If a bit is on (=1), the statement is true. All bits set to 0 implies the earth location was normal.)</i></p> <p>bit 7: not earth located because of bad time; earth location fields zero-filled bit 6: earth location questionable: questionable time code (see time problem flags above) bit 5: earth location questionable: marginal agreement with reasonableness check bit 4: earth location questionable: fails reasonableness check bit 3: earth location questionable because of antenna position check bit 2: <zero fill> bit 1: earth location questionable: satellite in-plane maneuver (Metop) or <zero fill> (NOAA) bit 0: earth location questionable: satellite out-of-plane maneuver (Metop) or <zero fill> (NOAA)</p>	32	32	u	1	1	0		

Calibration Quality Flags (<i>all bits off implies a good calibration</i>) <i>Word 1: Channel 1</i> bits 15-9: <zero fill> bit 8: this scan line is either the last one before or the first one after a sudden, anomalous jump (or drop) in calibration counts bit 7: lunar contamination was detected in the space view counts of this channel bit 6: the space view counts of this channel were corrected for lunar contamination when used in the calibration (only applicable if the previous flag [bit 7] is 1; otherwise, zero) bit 5: all bad blackbody view counts for scan line bit 4: all bad space view counts for scan line bit 3: all bad PRTs for this line bit 2: marginal blackbody view counts for this line bit 1: marginal space view counts for this line bit 0: marginal PRT temps on this line <i>Words 2-15: Channels 2-15 (in order)</i> <i>Word 16: <zero fill></i>	33	64	u	2	16	0		
<Zero Fill>	65	80	i	4	4	0		
CALIBRATION COEFFICIENTS								
<i>Note: The following coefficients are only available in Full Scan mode, otherwise the coefficient fields are <Zero Fill>. Refer to Digital A Telemetry, Digital Housekeeping Word 1 for the current mode.</i>								
Primary Calibration Ch 1 Second Order Term, a2	81	84	i	4	1	19		
Primary Calibration Ch 1 First Order Term, a1	85	88	i	4	1	13		
Primary Calibration Ch 1 Zeroth Order Term, a0	89	92	i	4	1	9		
Primary Calibration Ch 2 Second Order Term, a2	93	96	i	4	1	19		
Primary Calibration Ch 2 First Order Term, a1	97	100	i	4	1	13		
Primary Calibration Ch 2 Zeroth Order Term, a0	101	104	i	4	1	9		
Primary Calibration Ch 3 Second Order Term, a2	105	108	i	4	1	19		
Primary Calibration Ch 3 First Order Term, a1	109	112	i	4	1	13		
Primary Calibration Ch 3 Zeroth Order Term, a0	113	116	i	4	1	9		
Primary Calibration Ch 4 Second Order Term, a2	117	120	i	4	1	19		
Primary Calibration Ch 4 First Order Term, a1	121	124	i	4	1	13		
Primary Calibration Ch 4 Zeroth Order Term, a0	125	128	i	4	1	9		
Primary Calibration Ch 5 Second Order Term, a2	129	132	i	4	1	19		
Primary Calibration Ch 5 First Order Term, a1	133	136	i	4	1	13		
Primary Calibration Ch 5 Zeroth Order Term, a0	137	140	i	4	1	9		
Primary Calibration Ch 6 Second Order Term, a2	141	144	i	4	1	19		
Primary Calibration Ch 6 First Order Term, a1	145	148	i	4	1	13		
Primary Calibration Ch 6 Zeroth Order Term, a0	149	152	i	4	1	9		
Primary Calibration Ch 7 Second Order Term, a2	153	156	i	4	1	19		
Primary Calibration Ch 7 First Order Term, a1	157	160	i	4	1	13		
Primary Calibration Ch 7 Zeroth Order Term, a0	161	164	i	4	1	9		
Primary Calibration Ch 8 Second Order Term, a2	165	168	i	4	1	19		
Primary Calibration Ch 8 First Order Term, a1	169	172	i	4	1	13		

Primary Calibration Ch 8 Zeroth Order Term, a0	173	176	i	4	1	9		
Primary Calibration Ch 9 Second Order Term, a2	177	180	i	4	1	19		
Primary Calibration Ch 9 First Order Term, a1	181	184	i	4	1	13		
Primary Calibration Ch 9 Zeroth Order Term, a0	185	188	i	4	1	9		
Primary Calibration Ch 10 Second Order Term, a2	189	192	i	4	1	19		
Primary Calibration Ch 10 First Order Term, a1	193	196	i	4	1	13		
Primary Calibration Ch 10 Zeroth Order Term, a0	197	200	i	4	1	9		
Primary Calibration Ch 11 Second Order Term, a2	201	204	i	4	1	19		
Primary Calibration Ch 11 First Order Term, a1	205	208	i	4	1	13		
Primary Calibration Ch 11 Zeroth Order Term, a0	209	212	i	4	1	9		
Primary Calibration Ch 12 Second Order Term, a2	213	216	i	4	1	19		
Primary Calibration Ch 12 First Order Term, a1	217	220	i	4	1	13		
Primary Calibration Ch 12 Zeroth Order Term, a0	221	224	i	4	1	9		
Primary Calibration Ch 13 Second Order Term, a2	225	228	i	4	1	19		
Primary Calibration Ch 13 First Order Term, a1	229	232	i	4	1	13		
Primary Calibration Ch 13 Zeroth Order Term, a0	233	236	i	4	1	9		
Primary Calibration Ch 14 Second Order Term, a2	237	240	i	4	1	19		
Primary Calibration Ch 14 First Order Term, a1	241	244	i	4	1	13		
Primary Calibration Ch 14 Zeroth Order Term, a0	245	248	i	4	1	9		
Primary Calibration Ch 15 Second Order Term, a2	249	252	i	4	1	19		
Primary Calibration Ch 15 First Order Term, a1	253	256	i	4	1	13		
Primary Calibration Ch 15 Zeroth Order Term, a0	257	260	i	4	1	9		
Secondary Calibration Ch 1 Second Order Term, a2	261	264	i	4	1	19		
Secondary Calibration Ch 1 First Order Term, a1	265	268	i	4	1	13		
Secondary Calibration Ch 1 Zeroth Order Term, a0	269	272	i	4	1	9		
Secondary Calibration Ch 2 Second Order Term, a2	273	276	i	4	1	19		
Secondary Calibration Ch 2 First Order Term, a1	277	280	i	4	1	13		
Secondary Calibration Ch 2 Zeroth Order Term, a0	281	284	i	4	1	9		
Secondary Calibration Ch 3 Second Order Term, a2	285	288	i	4	1	19		
Secondary Calibration Ch 3 First Order Term, a1	289	292	i	4	1	13		
Secondary Calibration Ch 3 Zeroth Order Term, a0	293	296	i	4	1	9		
Secondary Calibration Ch 4 Second Order Term, a2	297	300	i	4	1	19		
Secondary Calibration Ch 4 First Order Term, a1	301	304	i	4	1	13		
Secondary Calibration Ch 4 Zeroth Order Term, a0	305	308	i	4	1	9		
Secondary Calibration Ch 5 Second Order Term, a2	309	312	i	4	1	19		
Secondary Calibration Ch 5 First Order Term, a1	313	316	i	4	1	13		
Secondary Calibration Ch 5 Zeroth Order Term, a0	317	320	i	4	1	9		
Secondary Calibration Ch 6 Second Order Term, a2	321	324	i	4	1	19		
Secondary Calibration Ch 6 First Order Term, a1	325	328	i	4	1	13		
Secondary Calibration Ch 6 Zeroth Order Term, a0	329	332	i	4	1	9		
Secondary Calibration Ch 7 Second Order Term, a2	333	336	i	4	1	19		
Secondary Calibration Ch 7 First Order Term, a1	337	340	i	4	1	13		

Secondary Calibration Ch 7 Zeroth Order Term, a0	341	344	i	4	1	9		
Secondary Calibration Ch 8 Second Order Term, a2	345	348	i	4	1	19		
Secondary Calibration Ch 8 First Order Term, a1	349	352	i	4	1	13		
Secondary Calibration Ch 8 Zeroth Order Term, a0	353	356	i	4	1	9		
Secondary Calibration Ch 9 Second Order Term, a2	357	360	i	4	1	19		
Secondary Calibration Ch 9 First Order Term, a1	361	364	i	4	1	13		
Secondary Calibration Ch 9 Zeroth Order Term, a0	365	368	i	4	1	9		
Secondary Calibration Ch 10 Second Order Term, a2	369	372	i	4	1	19		
Secondary Calibration Ch 10 First Order Term, a1	373	376	i	4	1	13		
Secondary Calibration Ch 10 Zeroth Order Term, a0	377	380	i	4	1	9		
Secondary Calibration Ch 11 Second Order Term, a2	381	384	i	4	1	19		
Secondary Calibration Ch 11 First Order Term, a1	385	388	i	4	1	13		
Secondary Calibration Ch 11 Zeroth Order Term, a0	389	392	i	4	1	9		
Secondary Calibration Ch 12 Second Order Term, a2	393	396	i	4	1	19		
Secondary Calibration Ch 12 First Order Term, a1	397	400	i	4	1	13		
Secondary Calibration Ch 12 Zeroth Order Term, a0	401	404	i	4	1	9		
Secondary Calibration Ch 13 Second Order Term, a2	405	408	i	4	1	19		
Secondary Calibration Ch 13 First Order Term, a1	409	412	i	4	1	13		
Secondary Calibration Ch 13 Zeroth Order Term, a0	413	416	i	4	1	9		
Secondary Calibration Ch 14 Second Order Term, a2	417	420	i	4	1	19		
Secondary Calibration Ch 14 First Order Term, a1	421	424	i	4	1	13		
Secondary Calibration Ch 14 Zeroth Order Term, a0	425	428	i	4	1	9		
Secondary Calibration Ch 15 Second Order Term, a2	429	432	i	4	1	19		
Secondary Calibration Ch 15 First Order Term, a1	433	436	i	4	1	13		
Secondary Calibration Ch 15 Zeroth Order Term, a0	437	440	i	4	1	9		
<Zero Fill>	441	444	i	2	2	0		
NAVIGATION								
Computed Yaw Steering (<i>Metop: content defined below</i>) or <Zero Fill> (<i>NOAA</i>) Word 1: Computed roll angle Word 2: Computed pitch angle Word 3: Computed yaw angle	445	450	i	2	3	3	degrees	
Total Applied Attitude Correction Word 1: Roll Word 2: Pitch Word 3: Yaw	451	456	i	2	3	3	degrees	

<p>Navigation Status Bit Field (<i>content, defined below, depends on origin of data, either NOAA or Metop</i>)</p> <p><i>For NOAA Data:</i> bits 31-18: <zero fill> bit 17: earth location at the satellite subpoint is accurate and reasonable, i.e., is within tolerance defined by "Nadir Earth Location Tolerance" in header (0=out of tolerance; 1=in tolerance) bit 16: Euler error angles from the CPU telemetry used by AELDS to correct the earth locations (0=FALSE; 1=TRUE) bits 15-12: earth location indicator (0=earth location available; 1=first scan whose time is more than 24 hours older than the time [epoch] of the user ephemeris file; 2=no earth location available) bits 11-8: spacecraft attitude control (0=operating in YGC or NOMINAL mode and attitude is good; 1=operating in another mode but attitude is good; 2=operating in YGC or NOMINAL mode but tests are being conducted which may cause attitude to exceed nominal tolerance; 3=operating in another mode while tests are being conducted which may cause attitude to exceed nominal tolerance) bits 7-4: attitude SMODE (0=nominal mode; 1=rate nulling mode; 2=YGC mode; 3=search mode; 4=coast mode) bits 3-0: attitude PWTIP\$AC (0=nominal mode/no test; 1=yaw axis test in progress; 2=roll axis test in progress; 3=pitch axis test in progress)</p> <p><i>For Metop Data:</i> bits 31-21: <zero fill> bit 20-19: yaw steering parameters usage indicator (0=no yaw steering correction; 1=measured angles from the Metop SVM telemetry; 2=computed angles from AELDS; 3=measured angles + computed angles) bit 18: Metop maneuver indicator (0=scan does not occur during a Metop in-plane or out-of-plane maneuver; 1=scan, or some part of it, occurs during a maneuver) bit 17: <same as defined for NOAA, above> bit 16: <zero fill> bits 15-12: <same as defined for NOAA, above> bits 11-8: <zero fill> bits 7-4: OPM PF sub-mode (0=fine pointing mode (FPM); 1=yaw steering mode (YSM)) bits 3-0: SVM PF mode (0=LHM; 1=RRM; 2=CAM; 3=FAM1; 4=FAM2; 5=FAM3; 6=OPM; 7=OCM1; 8=OCM2; 9=OCMT; 10=OCMO)</p>	457	460	u	4	1	0		
Time Associated with Euler Error Angles	461	464	i	4	1	0	seconds	
<p>Euler Error Angles (<i>NOAA, from TIP CPU telemetry near end of scan; Metop [in FPM], from SVM telemetry just before start of scan</i>) or</p> <p>Yaw Steering Parameters (<i>Metop [in YSM], from SVM telemetry or AELDS near nadir of scan</i>)</p> <p>Word 1: Roll Word 2: Pitch Word 3: Yaw</p>	465	470	i	2	3	3	degrees	
Spacecraft Altitude above Reference Ellipsoid	471	472	u	2	1	1	km	
<p>Angular Relationships (<i>relative azimuth range +/- 180.00 degrees</i>)</p> <p>Word 1: Solar zenith angle, FOV 1 Word 2: Satellite zenith angle, FOV 1 Word 3: Relative azimuth angle, FOV 1 Word 4: Solar zenith angle, FOV 2 ... (set of 3 angles every FOV) ... Word 90: Relative azimuth angle, FOV 30</p>	473	652	i	2	90	2	degrees	

Earth Location (<i>north latitude and east longitude are positive</i>) Word 1: Latitude, FOV 1 Word 2: Longitude, FOV 1 Word 3: Latitude, FOV 2 ... (lat/lon word pair every FOV) ... Word 60: Longitude, FOV 30	653	892	i	4	60	4	degrees	
<Zero Fill>	893	896	i	4	1	0		
AMSU-AI DIGITAL A TELEMETRY								
Synchronization Sequence (<i>hex FF</i>)	897	899	u	1	3	0		
Unit Identification and Serial Number 5=PFM, s/n 102 (NOAA-L) 9=FM 1, s/n 103 (NOAA-K) 13=FM 2, s/n 104 (NOAA-M) 21=FM 4, s/n 106 (Metop-2) 33=FM 7, s/n 109 (NOAA-N)	900	900	u	1	1	0		
Digital Housekeeping <i>Word 1: Data 1</i> bit 7: <zero fill> bit 6: cold cal position msb bit 5: cold cal position lsb (cold cal position: 0=6.667°, 1=8.333°, 2=9.999°, 3=13.332°; angles measured from -Z (NOAA) or -X (Metop)) bit 4: nadir mode (0=not in nadir; 1=nadir) bit 3: cold cal mode (0=not in cold cal; 1=cold cal) bit 2: warm cal mode (0=not in warm cal; 1=warm cal) bit 1: full scan mode (0=not full scan; 1=full scan) bit 0: <zero fill> <i>Word 2: Data 2</i> bits 7-5: <zero fill> bit 4: survival heater power (0=off; 1=on) bit 3: PLL power (0=redundant; 1=primary) bit 2: scanner A1-2 power (0=off; 1=on) bit 1: scanner A1-1 power (0=off; 1=on) bit 0: <zero fill> <i>Words 3-4: <Zero Fill></i>	901	904	u	1	4	0		
Scene Telemetry (<i>Scanner is parked at warm cal position while in warm cal mode, cold cal position while in cold cal mode, and nadir position while in nadir mode (see Digital Housekeeping Word 1, above). In parked modes, words 1 through 17 are repeated 29 times for a total of 30 data sets at the designated scanner position. In full scan mode, the scanner is stepped from positions 1 to 30 as indicated.</i>) Word 1: Reflector A1-1, position 1, first reading Word 2: Reflector A1-2, position 1, first reading Word 3: Reflector A1-1, position 1, second reading Word 4: Reflector A1-2, position 1, second reading Words 5-17: Scene count at position 1, channels 3 through 15 (in order) Word 18: Reflector A1-1, position 2, first reading ... (17 words every position) ... Words 498-510: Scene count at position 30, channels 3 through 15 (in order)	905	1924	u	2	510	0		

<p>Cold Calibration Telemetry (<i>These words are zero-filled in warm cal, cold cal, and nadir modes. In full scan mode, these words contain the following data.</i>)</p> <p>Word 1: Reflector A1-1, cold calibration position, first reading Word 2: Reflector A1-2, cold calibration position, first reading Word 3: Reflector A1-1, cold calibration position, second reading Word 4: Reflector A1-2, cold calibration position, second reading Words 5-17: Cold cal count 1, channels 3 through 15 (in order) Words 18-30: Cold cal count 2, channels 3 through 15 (in order)</p>	1925	1984	u	2	30	0	counts	
<p>Temperature Sensor Telemetry</p> <p>Word 1: Scan motor A1-1 Word 2: Scan motor A1-2 Word 3: Feed horn A1-1 Word 4: Feed horn A1-2 Word 5: RF mux A1-1 Word 6: RF mux A1-2 Words 7-12: Local oscillator channels 3 – 8 Word 13: Local oscillator channel 15 Word 14: PLL LO #2 Channels 9 – 14 Word 15: PLL LO #1 Channels 9 – 14 Word 16: PLL (reference oscillator) (NOAA-KLM) or <zero fill> (NOAA-NN', Metop) Words 17-22: Mixer/IF amplifier channels 3 – 8 Word 23: Mixer/IF amplifier channel 9/14 Word 24: Mixer/IF amplifier channel 15 Word 25: IF amplifier channel 11/14 Words 26-28: IF amplifier channels 9 – 11 Word 29: DC/DC converter Words 30-31: IF amplifier channels 13 – 14 Word 32: IF amplifier channel 12 Word 33: RF shelf A1-1 Word 34: RF shelf A1-2 Word 35: Detector/preamplifier assembly Words 36-39: A1-1 warm load 1 – 4 Word 40: A1-1 warm load center Words 41-44: A1-2 warm load 1 – 4 Word 45: A1-2 warm load center Word 46: Reference voltage</p>	1985	2076	u	2	46	0	counts	4
<p>Warm Calibration Telemetry (<i>These words are zero-filled in warm cal, cold cal, and nadir modes. In full scan mode, these words contain the following data.</i>)</p> <p>Word 1: Reflector A1-1, warm calibration position, first reading Word 2: Reflector A1-2, warm calibration position, first reading Word 3: Reflector A1-1, warm calibration position, second reading Word 4: Reflector A1-2, warm calibration position, second reading Words 5-17: Warm cal count 1, channels 3 through 15 (in order) Words 18-30: Warm cal count 2, channels 3 through 15 (in order)</p>	2077	2136	u	2	30	0	counts	
<Zero Fill>	2137	2140	i	4	1	0		

AMSU-A1 DIGITAL B TELEMETRY

<p>Digital B Telemetry Update Flags (<i>If bit = 1, associated telemetry item was not updated during most recent minor frame cycle - possibly due to lost frame.</i>) bit 15: <zero fill> bit 14: cold cal position, msb bit 13: cold cal position, lsb bit 12: antenna in nadir position bit 11: antenna in cold cal position bit 10: antenna in warm cal position bit 9: full scan mode bits 8-6: <zero fill> bit 5: module power bit 4: survival heater bit 3: phase lock loop bit 2: scanner A1-2 power bit 1: scanner A1-1 power bit 0: <zero fill></p>	2141	2142	u	2	1	0		
<p>Digital B Telemetry for AMSU-A1 <i>* If bits 9-12 are all set to 0, the instrument is either in the warm calibration position (NOAA-KLM) or operating in "NO" mode (NOAA-NN, Metop). When in "NO" mode, digital A telemetry, analog telemetry, and bits 3, 13, and 14 of the digital B telemetry should be ignored.</i> <i>* For cold cal position bits 13 and 14: 0=6.667°, 1=8.333°, 2=9.999°, 3=13.332° (angles measured from -Z (NOAA) or -X (Metop)).</i> bit 15: <zero fill> bit 14: cold cal position, msb bit 13: cold cal position, lsb bit 12: antenna in nadir position (0=no; 1=yes) bit 11: antenna in cold cal position (0=no; 1=yes) bit 10: antenna in warm cal position (0=no; 1=yes) bit 9: full scan (0=no; 1=yes) bits 8-6: <zero fill> bit 5: module power (0=disconnect; 1=connect) bit 4: survival heater (0=off; 1=on) bit 3: phase lock loop (0=redundant; 1=primary) bit 2: scanner A1-2 power (0=off; 1=on) bit 1: scanner A1-1 power (0=off; 1=on) bit 0: <zero fill></p>	2143	2144	u	2	1	0		1
<Zero Fill>	2145	2148	i	4	1	0		

AMSU-A1 ANALOG TELEMETRY

Analog Telemetry Update Flags (<i>If bit = 1, associated telemetry item was not updated during most recent minor frame cycle - possibly due to lost frame.</i>) bits 31-28: <zero fill> bit 27: GDO voltage 89.0 GHz ch. 15 bit 26: PLL0 redundant lock detect bit 25: PLL0 primary lock detect bit 24: LO voltage 55.5 GHz ch. 8 bit 23: LO voltage 54.94 GHz ch. 7 bit 22: LO voltage 54.4 GHz ch. 6 bit 21: LO voltage 53.596 GHz ch. 5 bit 20: LO voltage 52.8 GHz ch. 4 bit 19: LO voltage 50.3 GHz ch. 3 bit 18: -15 VDC phase lock loop ch. 9/14 bit 17: +15 VDC phase lock loop ch. 9/14 bit 16: +8.5 VDC phase lock loop ch. 9/14 (NOAA-KLM) or +10 VDC Receiver mixer/IF (NOAA-NN', Metop) bit 15: +5 VDC (antenna drive) bit 14: +5 VDC (signal processing) bit 13: +8 VDC (receiver amplifiers) bit 12: -15 VDC (antenna drive) bit 11: -15 VDC (signal processing) bit 10: +15 VDC (antenna drive) bit 9: +15 VDC (signal processing) bit 8: antenna A1-2 drive motor current (avg) bit 7: antenna A1-1 drive motor current (avg) bit 6: warm load A1-2 temperature bit 5: warm load A1-1 temperature bit 4: RF shelf A1-2 temperature bit 3: RF shelf A1-1 temperature bit 2: A1-2 scanner motor temperature bit 1: A1-1 scanner motor temperature bit 0: <zero fill>	2149	2152	u	4	1	0		3
A1 Analog Telemetry (<i>range: 0 - 255</i>)	2153	2180	u	1	28	0	counts	3

Word 1: A1-1 scanner motor temperature								
Word 2: A1-2 scanner motor temperature								
Word 3: RF shelf A1-1 temperature								
Word 4: RF shelf A1-2 temperature								
Word 5: Warm load A1-1 temperature								
Word 6: Warm load A1-2 temperature								
Word 7: Antenna A1-1 drive motor current (Avg)								
Word 8: Antenna A1-2 drive motor current (Avg)								
Word 9: +15 VDC (signal processing)								
Word 10: +15 VDC (antenna drive)								
Word 11: -15 VDC (signal processing)								
Word 12: -15 VDC (antenna drive)								
Word 13: +8 VDC (receiver amplifiers)								
Word 14: +5 VDC (signal processing)								
Word 15: +5 VDC (antenna drive)								
Word 16: +8.5 VDC phase lock loop ch. 9/14 (NOAA-KLM) or +10 VDC Receiver mixer/IF (NOAA-NN', Metop)								
Word 17: +15 VDC phase lock loop ch. 9/14								
Word 18: -15 VDC phase lock loop ch. 9/14								
Word 19: LO voltage 50.3 Ghz ch. 3								
Word 20: LO voltage 52.8 Ghz ch. 4								
Word 21: LO voltage 53.596 Ghz ch. 5								
Word 22: LO voltage 54.4 Ghz ch. 6								
Word 23: LO voltage 54.94 Ghz ch. 7								
Word 24: LO voltage 55.5 Ghz ch. 8								
Word 25: PLL0 primary lock detect								
Word 26: PLL0 redundant lock detect								
Word 27: GDO voltage 89.0 Ghz ch. 15								
Word 28: <zero fill>								
<Zero Fill>	2181	2184	i	4	1	0		
AMSU-A2 DIGITAL A TELEMETRY								
Synchronization Sequence (<i>hex FF</i>)	2185	2187	u	1	3	0		
Unit Identification and Serial Number 6=PFM, s/n 102 (NOAA-K) 10=FM 1, s/n 103 (NOAA-L) 14=FM 2, s/n 104 (NOAA-M) 18=FM 3, s/n 105 (NOAA-N) 30=FM 6, s/n 108 (Metop-2)	2188	2188	u	1	1	0		
Digital Housekeeping	2189	2192	u	1	4	0		

<p><i>Word 1: Data 1</i> bit 7: <zero fill> bit 6: cold cal position msb bit 5: cold cal position lsb (cold cal position: 0=6.667°, 1=8.333°, 2=9.999°, 3=13.332°; angles measured from -Z (NOAA) or -X (Metop)) bit 4: nadir mode (0=not in nadir; 1=nadir) bit 3: cold cal mode (0=not in cold cal; 1=cold cal) bit 2: warm cal mode (0=not in warm cal; 1=warm cal) bit 1: full scan mode (0=not full scan; 1=full scan) bit 0: <zero fill></p> <p><i>Word 2: Data 2</i> bits 7-5: <zero fill> bit 4: survival heater power (0=off; 1=on) bit 3: <zero fill> bit 2: scanner compensator power (0=off; 1=on) bit 1: scanner A2 power (0=off; 1=on) bit 0: <zero fill></p> <p><i>Word 3: Data 3</i> bits 7-0: <zero fill></p> <p><i>Word 4: Data 4</i> bits 7-0: <zero fill></p>								
<p><i>Scene Telemetry (Scanner is parked at warm cal position while in warm cal mode, cold cal position while in cold cal mode, and nadir position while in nadir mode (see Digital Housekeeping Word 1, above). In parked modes, words 1 through 4 are repeated 29 times for a total of 30 data sets at the designated scanner position. In full scan mode, the scanner is stepped from positions 1 to 30 as indicated.)</i> Word 1: Reflector, position 1, first reading Word 2: Reflector, position 1, second reading Words 3-4: Scene count at position 1, Channels 1 and 2 (in order) Word 5: Reflector, position 2, first reading ... (4 words every position) ... Words 119-120: Scene count at position 30, Channels 1 and 2 (in order)</p>	2193	2432	u	2	120	0		
<p><i>Cold Calibration Telemetry (These words are zero-filled in warm cal, cold cal, and nadir modes. In full scan mode, these words contain the following data.)</i> Word 1: Reflector, cold calibration position, first reading Word 2: Reflector, cold calibration position, second reading Words 3-4: Cold cal count 1, channels 1 and 2 Words 5-6: Cold cal count 2, channels 1 and 2</p>	2433	2444	u	2	6	0	counts	

Temperature Sensor Telemetry Word 1: Scan motor Word 2: Feed horn Word 3: RF mux/diplexer Words 4-5: Mixer/IF amplifier channels 1 and 2 Words 6-7: Local oscillator channels 1 and 2 Word 8: Compensation motor Word 9: Subreflector Word 10: DC/DC converter Word 11: RF shelf A2 Word 12: Detector/preamplifier assembly Word 13: Warm load center Words 14-19: Warm load 1 – 6 Word 20: Reference voltage	2445	2484	u	2	20	0	counts	2,4
Warm Calibration Telemetry (<i>These words are zero-filled in warm cal, cold cal, and nadir modes. In full scan mode, these words contain the following data.</i>) Word 1: Reflector, warm calibration position, first reading Word 2: Reflector, warm calibration position, second reading Words 3-4: Warm calibration 1, channels 1 and 2 Words 5-6: Warm calibration 2, channels 1 and 2	2485	2496	u	2	6	0	counts	
<Zero Fill>	2497	2500	i	4	1	0		
AMSU-A2 DIGITAL B TELEMETRY								
Digital B Telemetry Update Flags (<i>If bit = 1, associated telemetry item was not updated during most recent minor frame cycle - possibly due to lost frame.</i>) bit 15: <zero fill> bit 14: cold cal position, msb bit 13: cold cal position, lsb bit 12: antenna in nadir position bit 11: antenna in cold cal position bit 10: antenna in warm cal position bit 9: full scan mode bits 8-5: <zero fill> bit 4: survival heater bit 3: module power bit 2: compensator motor bit 1: scanner A2 power bit 0: <zero fill>	2501	2502	u	2	1	0		

<p>Digital B Telemetry for AMSU-A2</p> <p><i>* If bits 9-12 are all set to 0, the instrument is either in the warm calibration position (NOAA-KLM) or operating in "NO" mode (NOAA-NN', Metop). When in "NO" mode, digital A telemetry, analog telemetry, and bits 13 and 14 of the digital B telemetry should be ignored.</i></p> <p><i>* For cold cal position bits 13 and 14: 0=6.667°, 1=8.333°, 2=9.999°, 3=13.332° (angles measured from -Z (NOAA) or -X (Metop)).</i></p> <p>bit 15: <zero fill> bit 14: cold cal position, msb bit 13: cold cal position, lsb bit 12: antenna in nadir position (0=no; 1=yes) bit 11: antenna in cold cal position (0=no; 1=yes) bit 10: antenna in warm cal position (0=no; 1=yes) bit 9: full scan mode (0=no; 1=yes) bits 8-5: <zero fill> bit 4: survival heater (0=off; 1=on) bit 3: module power (0=disconnect; 1=connect) bit 2: compensator motor (0=off; 1=on) bit 1: scanner A2 power (0=off; 1=on) bit 0: <zero fill></p>	2503	2504	u	2	1	0		1
<Zero Fill>	2505	2508	i	4	1	0		
AMSU-A2 ANALOG TELEMETRY DATA								
<p>Analog Telemetry Update Flags (<i>If bit = 1, associated telemetry item was not updated during most recent minor frame cycle - possibly due to lost frame.</i>)</p> <p>bits 31-16: <zero fill> bit 15: LO voltage ch. 2 (31.4 GHz) bit 14: LO voltage ch. 1 (23.8 GHz) bit 13: +5 VDC (antenna drive) bit 12: +5 VDC (signal processing) bit 11: +8 VDC (receiver) (NOAA-KLM) or +10 VDC(receiver/mixer/IF) (NOAA-NN', Metop) bit 10: -15 VDC (antenna drive) bit 9: -15 VDC (signal processing) bit 8: +15 VDC (antenna drive) bit 7: +15 VDC (signal processing) bit 6: antenna drive motor current (avg) bit 5: compensator motor current (avg) bit 4: warm load A2 temperature bit 3: RF shelf temperature bit 2: compensator motor temperature bit 1: scanner motor temperature bit 0: <zero fill></p>	2509	2512	u	4	1	0		3

A2 Analog Telemetry (<i>range: 0 - 255</i>) Word 1: Scanner motor temperature Word 2: Compensator motor temperature Word 3: RF shelf temperature Word 4: Warm load A2 temperature Word 5: Compensator motor current (Avg) Word 6: Antenna drive motor current (Avg) Word 7: +15 VDC (signal processing) Word 8: +15 VDC (antenna drive) Word 9: -15 VDC (signal processing) Word 10: -15 VDC (antenna drive) Word 11: +8 VDC (receiver) (NOAA-KLM) or +10 VDC (receiver/mixer/IF) (NOAA-NN', Metop) Word 12: +5 VDC (signal processing) Word 13: +5 VDC (antenna drive) Word 14: LO voltage ch. 1 (23.8 GHz) Word 15: LO voltage ch. 2 (31.4 GHz) Word 16: <zero fill>	2513	2528	u	1	16	0	counts	3
LUNAR CONTAMINATION CORRECTION								
Space View Count Corrections, ΔC_c <i>$\Delta C_c = \text{raw space count} - \text{corrected space count}$. If the ΔC_c value is subtracted from the raw space counts, the value of the corrected space counts used in the calibration is obtained. A value of $\Delta C_c = 0$ indicates that no correction was made. NOTE: The raw space counts are the "cold cal" counts of the "Cold Calibration Telemetry" fields. Range: 0 - 100</i> Word 1: ΔC_c for channel 1 Words 2-15: ΔC_c 's for channels 2-15, in order	2529	2543	u	1	15	0	counts	
<Zero Fill>	2544	2544	i	1	1	0		
Lunar Azimuth Angles (<i>with respect to the space view position of each AMSU-A antenna; range: -180 to +180</i>) Word 1: Angle for A1-1 antenna Word 2: Angle for A1-2 antenna Word 3: Angle for A2 antenna	2545	2550	i	2	3	2	degrees	
Lunar Elevation Angles (<i>with respect to the space view position of each AMSU-A antenna; range: -90 to +90</i>) Word 1: Angle for A1-1 antenna Word 2: Angle for A1-2 antenna Word 3: Angle for A2 antenna	2551	2556	i	2	3	2	degrees	
FILLER								
<Zero Fill>	2557	2560	i	4	1	0		

8.3.1.7 AMSU-B Data Sets

This section describes the characteristics and format of Advanced Microwave Sounding Unit-B (AMSU-B) data sets for each version. Note: AMSU-B was replaced with the Microwave Humidity Sounder starting with NOAA-N. The format changes remain in step with the other instruments' formats for the NOAA KLM satellites.

8.3.1.7.1 Data Characteristics

Table 8.3.1.7.1-1 summarizes fundamental characteristics of the data.

Parameter	Value
Sample word size	16 bits
Number of sampled channels/available channels	5/5
Number of Earth samples per scan	90 per channel
Scan rate	22.5 scans per minute
Scan direction	West to East (northbound)
Instantaneous Field of View (IFOV)	1.1 degrees (all channels)
Spatial resolution at nadir	16 km at 833 km altitude
Cross track distance between sample centers at nadir	16 km at 833 km altitude
Along track distance between sample centers at nadir	17.6 km at 833 km altitude
Cross-track scan coverage	± 49.5 degrees from nadir
Swath width	2126.2 km at 833 km altitude

8.3.1.7.2 Header Records

The Data Set Header Record contains quality, navigation, calibration and conversion coefficient information which applies to the AMSU-B data records which follow. This section describes the header records for both NOAA KLM (version 2) and NOAA-N (version 3) satellites. Version 2 formats (v2) were used on all NOAA KLM data until April 28, 2005. After this date, the Version 3 format (v3) was in effect for all operational POES spacecraft until January 25, 2006. Since January 26, 2006 Version 4 was used to reflect the inclusion of cloud mask information

8.3.1.7.2.1 NOAA KLM (Version 2, pre-April 28, 2005)

The AMSU-B Data Set Header Record format for NOAA KLM (Version 2, pre-April 28, 2005) is documented in Table 8.3.1.7.2.1-1. See the legend in Section 8.3.1.1 for further explanation of the headings on this table.

GENERAL INFORMATION	Start Octet	End Octet	DT	Word Size	SF	Number of Words
Data Set Creation Site ID CMS = Centre de Meteorologie Spatiale/France; DSS = Dundee Satellite Receiving Station/UK; NSS = National Environmental Satellite, Data and Information Service/USA; UKM = United Kingdom Meteorological Office/UK)	1	3	c	3	0	1
<ASCII blank = x20>	4	4	c	1	0	1

NOAA Level 1b Format Version Number 1=TIROS-N, NOAA-6 through NOAA-14; 2=NOAA-15, -16, -17(pre-April 28, 2005); 3=all satellites post-April 28, 2005; 4=cloud mask flag (CLAVRx) Jan 25, 2006.	5	6	u	2	0	1
NOAA Level 1b Format Version Year (e.g., 1999)	7	8	u	2	0	1
NOAA Level 1b Format Version Day of Year (e.g., 365)	9	10	u	2	0	1
<Reserved for Logical Record Length> For Creation Site use only. Logical Record Length of NOAA Level 1b data set prior to processing.	11	12	u	2	0	1
<Reserved for Block Size> For Creation Site use only. Block Size of NOAA Level 1b data set prior to processing.	13	14	u	2	0	1
Count of Header Records in this Data Set	15	16	u	2	0	1
<zero fill>	17	22	i	2	0	3
Data Set Name	23	64	c	42	0	1
Processing Block Identification	65	72	c	8	0	1
NOAA Spacecraft Identification Code 2=NOAA-16 4=NOAA-15 6=NOAA-17 7=NOAA-18 8=NOAA-N' 11=MetOp-1 12=MetOp-A	73	74	u	2	0	1
Instrument ID 0 = Engineering Model; 4 = Protoflight Model; 8 = Flight Model 2; 12 = Flight Model 3	75	76	u	2	0	1
Data Type Code 1 = LAC; 2 = GAC; 3 = HRPT; 4 = TIP; 5 = HIRS; 6 = MSU; 7 = SSU; 8 = DCS; 9 = SEM; 10 = AMSU-A; 11 = AMSU-B	77	78	u	2	0	1
TIP Source Code 0 = unused, GAC/HRPT/LAC data; 1 = GAC embedded AMSU and TIP; 2 = stored TIP; 3 = HRPT/LAC embedded AMSU and TIP; 4 = stored AIP	79	80	u	2	0	1
Start of Data Set Day Count starting from 0 at 00h, 1 Jan 1950	81	84	u	4	0	1

Start of Data Set Year (e.g., 1999)	85	86	u	2	0	1
Start of Data Set Day of Year (e.g., 365)	87	88	u	2	0	1
Start of Data Set UTC Time of Day in Milliseconds	89	92	u	4	0	1
End of Data Set Day Count starting from 0 at 00h, 1 Jan 1950	93	96	u	4	0	1
End of Data Set Year (e.g., 1999)	97	98	u	2	0	1
End of Data Set Day of Year (e.g., 365)	99	100	u	2	0	1
End of Data Set UTC Time of Day in Milliseconds	101	104	u	4	0	1
Year of Last CPIDS Update (e.g., 1999)	105	106	u	2	0	1
Day of Year of Last CPIDS Update (e.g., 365)	107	108	u	2	0	1
Offset between Start of Scan and Center of first FOV in Milliseconds	109	110	i	2	0	1
<zero fill>	111	120	i	2	0	6
DATA SET QUALITY INDICATORS						
Instrument Status bits 31 - 29: <not defined> bit 28: processor check flag (0 = passed; 1 = failed) bit 27: scan control status (0 = running; 1 = aborted) bit 26: pixel data invalid flag (0 = valid; 1 = invalid) bit 25: scan synchronization (0 = error < 0.1 deg; 1 = error >= 0.1 deg) bit 24: mode transition flag (0 = transition complete; 1 = transition in progress) bit 23: module ID (msb) (0 = EM; 4 = PFM; 8 = FM2; 12 = FM3) bits 22 - 17: module ID bit 16: module ID (lsb) bit 15: RAM check flag (0 = passed; 1 = failed) bit 14: ROM check flag (0 = passed; 1 = failed) bit 13: memory checks status (0 = disabled; 1 = enabled) bit 12: space view select (lsb) bit 11: space view select (msb) bit 10: channel 18/19/20 on/off (relay 5 status) (0 = off; 1 = on) bit 9: channel 17 on/off (relay 4 status) (0 = off; 1 = on) bit 8: channel 16 on/off (relay 3 status) (0 = off; 1 = on) bit 7: stepped mode (0 = no; 1 = yes) bit 6: investigation mode (0 = no; 1 = yes) bit 5: parked in space view mode (0 = no; 1 = yes) bit 4: parked in nadir view mode (0 = no; 1 = yes) bit 3: parked in target view mode (0 = no; 1 = yes) bit 2: scan normal mode (0 = no; 1 = yes) bit 1: survival heater on/off (relay 2 status) (0 = off; 1 = on) bit 0: power on/off (relay 1 status) (0 = off; 1 = on)	121	124	u	4	0	1
<zero fill>	125	126	i	2	0	1
Record Number of Status Change (if 0, none occurred)	127	128	u	2	0	1

Second Instrument Status (if previous word is 0, no change)	129	132	u	4	0	1
Count of Data Records in this Data Set	133	134	u	2	0	1
Count of Calibrated, Earth Located Scan Lines in this Data Set	135	136	u	2	0	1
Count of Missing Scan Lines	137	138	u	2	0	1
Count of Data Gaps in this Data Set	139	140	u	2	0	1
Count of Data Frames Without Frame Sync Word Errors	141	142	u	2	0	1
Count of PACS Detected TIP Parity Errors	143	144	u	2	0	1
Sum of All Auxiliary Sync Errors Detected in the Input Data	145	146	u	2	0	1
Time Sequence Error (0 = none; otherwise the record number of the first occurrence)	147	148	u	2	0	1
Time Sequence Error Code These are bit flags taken from Scan Line Quality Flags Time Problem Code on data record reported in Time Sequence Error field above. If a bit is on (=1) then the statement is true. bits 15 - 8: <zero fill> bit 7: time field is bad but can probably be inferred from the previous good time. bit 6: time field is bad and can't be inferred from the previous good time. bit 5: this record starts a sequence that is inconsistent with previous times (i.e., there is a time discontinuity). This may or may not be associated with a spacecraft clock update. bit 4: start of a sequence that apparently repeats scan times that have been previously accepted. bits 3 - 0: <zero fill>	149	150	u	2	0	1
SOCC Clock Update Indicator (0 = none during this orbit; otherwise the record number of the first occurrence)	151	152	u	2	0	1
Earth Location Error Indicator (0 = none during this orbit; otherwise the record number of the first occurrence)	153	154	u	2	0	1

Earth Location Error Code These are bit flags taken from Scan Line Quality Flags Earth Location Problem Code on data record reported in Earth Location Error Indicator field above. If a bit is on (=1) then the statement is true. bits 15 - 8: <zero fill> bit 7: not earth located because of bad time; earth location fields zero filled. bit 6: earth location questionable because of questionable time code. (See time problem flags.) bit 5: earth location questionable -- only marginal agreement with reasonableness check. bit 4: earth location questionable -- fails reasonableness check. bit 3: earth location questionable because of antenna position check [rs060794.doc & rs062094.do1] bits 2-0: <zero fill>	155	156	u	2	0	1
PACS Status Bit Field bits 15-3: <zero fill> bit 2: pseudo noise (0 = normal data; 1 = P/N data) bit 1: tape direction (0 = time decrementing) bit 0: data mode (0 = test data; 1 = flight data)	157	158	u	2	0	1
PACS Data Source 0 = unused; 1 = Fairbanks, AK; 2 = Wallops Island, VA; 3 = SOCC; 4=Svalbard, Norway; 5=Monterey, CA	159	160	u	2	0	1
<Reserved for the Ingester>	161	168	c	8	0	1
<Reserved for Decommutation>	169	176	c	8	0	1
<zero fill>	177	192	i	4	0	4
CALIBRATION						
Instrument Temperature Sensor ID 0 = Mixer Temp of Ch 18 - 20; 1 = Mixer Temp of Ch 16	193	194	i	2	0	1
<zero fill>	195	196	i	2	0	1
Minimum Reference Temperature, mixer of Ch 18 - 20	197	198	i	2	2	1
Nominal Reference Temperature, mixer of Ch 18 - 20	199	200	i	2	2	1
Maximum Reference Temperature, mixer of Ch 18 - 20	201	202	i	2	2	1
Minimum Reference Temperature, mixer of Ch 16	203	204	i	2	2	1
Nominal Reference Temperature, mixer of Ch 16	205	206	i	2	2	1
Maximum Reference Temperature, mixer of Ch 16	207	208	i	2	2	1
Warm Target Fixed Bias Correction Ch 16 Min Temperature	209	210	i	2	3	1
Warm Target Fixed Bias Correction Ch 16 Nominal Temperature	211	212	i	2	3	1

Warm Target Fixed Bias Correction Ch 16 Max Temperature	213	214	i	2	3	1
Space Fixed Bias Correction Ch 16	215	216	i	2	3	1
Warm Target Fixed Bias Correction Ch 17 Min Temperature	217	218	i	2	3	1
Warm Target Fixed Bias Correction Ch 17 Nominal Temperature	219	220	i	2	3	1
Warm Target Fixed Bias Correction Ch 17 Max Temperature	221	222	i	2	3	1
Space Fixed Bias Correction Ch 17	223	224	i	2	3	1
Warm Target Fixed Bias Correction Ch 18 Min Temperature	225	226	i	2	3	1
Warm Target Fixed Bias Correction Ch 18 Nominal Temperature	227	228	i	2	3	1
Warm Target Fixed Bias Correction Ch 18 Max Temperature	229	230	i	2	3	1
Space Fixed Bias Correction Ch 18	231	232	i	2	3	1
Warm Target Fixed Bias Correction Ch 19 Min Temperature	233	234	i	2	3	1
Warm Target Fixed Bias Correction Ch 19 Nominal Temperature	235	236	i	2	3	1
Warm Target Fixed Bias Correction Ch 19 Max Temperature	237	238	i	2	3	1
Space Fixed Bias Correction Ch 19	239	240	i	2	3	1
Warm Target Fixed Bias Correction Ch 20 Min Temperature	241	242	i	2	3	1
Warm Target Fixed Bias Correction Ch 20 Nominal Temperature	243	244	i	2	3	1
Warm Target Fixed Bias Correction Ch 20 Max Temperature	245	246	i	2	3	1
Space Fixed Bias Correction Ch 20	247	248	i	2	3	1
Nonlinearity Coeff. Ch 1 at Reference Temperature 1	249	252	i	4	3	1
Nonlinearity Coeff. Ch 1 at Reference Temperature 2	253	256	i	4	3	1
Nonlinearity Coeff. Ch 1 at Reference Temperature 3	257	260	i	4	3	1
Nonlinearity Coeff. Ch 2 at Reference Temperature 1	261	264	i	4	3	1
Nonlinearity Coeff. Ch 2 at Reference Temperature 2	265	268	i	4	3	1
Nonlinearity Coeff. Ch 2 at Reference Temperature 3	269	272	i	4	3	1
Nonlinearity Coeff. Ch 3 at Reference Temperature 1	273	276	i	4	3	1
Nonlinearity Coeff. Ch 3 at Reference Temperature 2	277	280	i	4	3	1
Nonlinearity Coeff. Ch 3 at Reference Temperature 3	281	284	i	4	3	1
Nonlinearity Coeff. Ch 4 at Reference Temperature 1	285	288	i	4	3	1
Nonlinearity Coeff. Ch 4 at Reference Temperature 2	289	292	i	4	3	1
Nonlinearity Coeff. Ch 4 at Reference Temperature 3	293	296	i	4	3	1
Nonlinearity Coeff. Ch 5 at Reference Temperature 1	297	300	i	4	3	1
Nonlinearity Coeff. Ch 5 at Reference Temperature 2	301	304	i	4	3	1
Nonlinearity Coeff. Ch 5 at Reference Temperature 3	305	308	i	4	3	1
<zero fill>	309	324	i	4	0	4
TEMPERATURE-RADIANCE CONVERSION						
Temperature-radiance Ch 16 Central Wavenumber	325	328	i	4	6	1
Temperature-radiance Ch 16 Constant 1	329	332	i	4	6	1

Temperature-radiance Ch 16 Constant 2	333	336	i	4	6	1
Temperature-radiance Ch 17 Central Wavenumber	337	340	i	4	6	1
Temperature-radiance Ch 17 Constant 1	341	344	i	4	6	1
Temperature-radiance Ch 17 Constant 2	345	348	i	4	6	1
Temperature-radiance Ch 18 Central Wavenumber	349	352	i	4	6	1
Temperature-radiance Ch 18 Constant 1	353	356	i	4	6	1
Temperature-radiance Ch 18 Constant 2	357	360	i	4	6	1
Temperature-radiance Ch 19 Central Wavenumber	361	364	i	4	6	1
Temperature-radiance Ch 19 Constant 1	365	368	i	4	6	1
Temperature-radiance Ch 19 Constant 2	369	372	i	4	6	1
Temperature-radiance Ch 20 Central Wavenumber	373	376	i	4	6	1
Temperature-radiance Ch 20 Constant 1	377	380	i	4	6	1
Temperature-radiance Ch 20 Constant 2	381	384	i	4	6	1
<zero fill>	385	400	i	4	0	4
NAVIGATION						
Reference Ellipsoid Model ID The ellipsoid is a mathematically tractable approximation of the geoid, which is an equipotential surface at mean sea level. The maximum departure of the ellipsoid from the geoid is approximately ± 65 meters. (WGS-72 = World Geodetic Survey 1972) JGM3 =Joint Gravity Model 3	401	408	c	8	0	1
Nadir Earth Location Tolerance in Kilometers	409	410	u	2	1	1
Earth Location Bit Field bits 15 - 2: <zero fill> bit 1: reasonableness test active (0 = inactive) bit 0: attitude error correction (0 = not corrected)	411	412	u	2	0	1
<zero fill>	413	414	i	2	0	1
Constant Roll Attitude Error in Degrees	415	416	i	2	3	1
Constant Pitch Attitude Error in Degrees	417	418	i	2	3	1
Constant Yaw Attitude Error in Degrees	419	420	i	2	3	1
Epoch Year for Orbit Vector (e.g., 1999)	421	422	u	2	0	1
Day of Epoch Year for Orbit Vector (e.g., 365)	423	424	u	2	0	1
Epoch UTC Time of Day in Milliseconds for Orbit Vector	425	428	u	4	0	1
Semi-major Axis in Kilometers	429	432	i	4	5	1
Eccentricity	433	436	i	4	8	1
Inclination in Degrees	437	440	i	4	5	1
Argument of Perigee in Degrees	441	444	i	4	5	1
Right Ascension of the Ascending Node in Degrees	445	448	i	4	5	1
Mean Anomaly in Degrees	449	452	i	4	5	1
Position Vector x Component in Kilometers	453	456	i	4	5	1
Position Vector y Component in Kilometers	457	460	i	4	5	1
Position Vector z Component in Kilometers	461	464	i	4	5	1
Velocity Vector x-dot Component in Kilometers/second	465	468	i	4	8	1
Velocity Vector y-dot Component in Kilometers/second	469	472	i	4	8	1

Velocity Vector z-dot Component in Kilometers/second	473	476	i	4	8	1
Earth/Sun Distance Ratio	477	480	u	4	6	1
<zero fill>	481	496	i	4	0	4
DIGITAL A CONVERSION						
Mixer 16 Temperature Coefficient 0	497	498	i	2	2	1
Mixer 16 Temperature Coefficient 1	499	500	i	2	7	1
Mixer 16 Temperature Coefficient 2	501	502	i	2	1	1
Mixer 16 Temperature Coefficient 3	503	504	i	2	1	1
Mixer 17 Temperature Coefficient 0	505	506	i	2	2	1
Mixer 17 Temperature Coefficient 1	507	508	i	2	7	1
Mixer 17 Temperature Coefficient 2	509	510	i	2	1	1
Mixer 17 Temperature Coefficient 3	511	512	i	2	1	1
Mixer 18, 19, & 20 Temperature Coefficient 0	513	514	i	2	2	1
Mixer 18, 19, & 20 Temperature Coefficient 1	515	516	i	2	7	1
Mixer 18, 19, & 20 Temperature Coefficient 2	517	518	i	2	1	1
Mixer 18, 19, & 20 Temperature Coefficient 3	519	520	i	2	1	1
FET Amplifier 16 Temperature Coefficient 0	521	522	i	2	2	1
FET Amplifier 16 Temperature Coefficient 1	523	524	i	2	7	1
FET Amplifier 16 Temperature Coefficient 2	525	526	i	2	1	1
FET Amplifier 16 Temperature Coefficient 3	527	528	i	2	1	1
FET Amplifier 17 Temperature Coefficient 0	529	530	i	2	2	1
FET Amplifier 17 Temperature Coefficient 1	531	532	i	2	7	1
FET Amplifier 17 Temperature Coefficient 2	533	534	i	2	1	1
FET Amplifier 17 Temperature Coefficient 3	535	536	i	2	1	1
FET Amplifier 18 Temperature Coefficient 0	537	538	i	2	2	1
FET Amplifier 18 Temperature Coefficient 1	539	540	i	2	7	1
FET Amplifier 18 Temperature Coefficient 2	541	542	i	2	1	1
FET Amplifier 18 Temperature Coefficient 3	543	544	i	2	1	1
FET Amplifier 19 Temperature Coefficient 0	545	546	i	2	2	1
FET Amplifier 19 Temperature Coefficient 1	547	548	i	2	7	1
FET Amplifier 19 Temperature Coefficient 2	549	550	i	2	1	1
FET Amplifier 19 Temperature Coefficient 3	551	552	i	2	1	1
FET Amplifier 20 Temperature Coefficient 0	553	554	i	2	2	1
FET Amplifier 20 Temperature Coefficient 1	555	556	i	2	7	1
FET Amplifier 20 Temperature Coefficient 2	557	558	i	2	1	1
FET Amplifier 20 Temperature Coefficient 3	559	560	i	2	1	1
Calibration Target Temperature 1 Coefficient 0	561	562	i	2	2	1
Calibration Target Temperature 1 Coefficient 1	563	564	i	2	7	1
Calibration Target Temperature 1 Coefficient 2	565	566	i	2	1	1
Calibration Target Temperature 1 Coefficient 3	567	568	i	2	1	1
Calibration Target Temperature 2 Coefficient 0	569	570	i	2	2	1
Calibration Target Temperature 2 Coefficient 1	571	572	i	2	7	1
Calibration Target Temperature 2 Coefficient 2	573	574	i	2	12	1
Calibration Target Temperature 2 Coefficient 3	575	576	i	2	18	1
Calibration Target Temperature 3 Coefficient 0	577	578	i	2	2	1
Calibration Target Temperature 3 Coefficient 1	579	580	i	2	7	1
Calibration Target Temperature 3 Coefficient 2	581	582	i	2	12	1
Calibration Target Temperature 3 Coefficient 3	583	584	i	2	18	1

Calibration Target Temperature 4 Coefficient 0	585	586	i	2	2	1
Calibration Target Temperature 4 Coefficient 1	587	588	i	2	7	1
Calibration Target Temperature 4 Coefficient 2	589	590	i	2	12	1
Calibration Target Temperature 4 Coefficient 3	591	592	i	2	18	1
Calibration Target Temperature 5 Coefficient 0	593	594	i	2	2	1
Calibration Target Temperature 5 Coefficient 1	595	596	i	2	7	1
Calibration Target Temperature 5 Coefficient 2	597	598	i	2	12	1
Calibration Target Temperature 5 Coefficient 3	599	600	i	2	18	1
Calibration Target Temperature 6 Coefficient 0	601	602	i	2	2	1
Calibration Target Temperature 6 Coefficient 1	603	604	i	2	7	1
Calibration Target Temperature 6 Coefficient 2	605	606	i	2	12	1
Calibration Target Temperature 6 Coefficient 3	607	608	i	2	18	1
Calibration Target Temperature 7 Coefficient 0	609	610	i	2	2	1
Calibration Target Temperature 7 Coefficient 1	611	612	i	2	7	1
Calibration Target Temperature 7 Coefficient 2	613	614	i	2	12	1
Calibration Target Temperature 7 Coefficient 3	615	616	i	2	18	1
Sub-reflector Temperature 1 Coefficient 0	617	618	i	2	2	1
Sub-reflector Temperature 1 Coefficient 1	619	620	i	2	7	1
Sub-reflector Temperature 1 Coefficient 2	621	622	i	2	12	1
Sub-reflector Temperature 1 Coefficient 3	623	624	i	2	18	1
LO Monitor Current Ch 16 Coefficient 0	625	626	i	2	3	1
LO Monitor Current Ch 16 Coefficient 1	627	628	i	2	5	1
LO Monitor Current Ch 16 Coefficient 2	629	630	i	2	0	1
LO Monitor Current Ch 16 Coefficient 3	631	632	i	2	0	1
LO Monitor Current Ch 17 Coefficient 0	633	634	i	2	3	1
LO Monitor Current Ch 17 Coefficient 1	635	636	i	2	5	1
LO Monitor Current Ch 17 Coefficient 2	637	638	i	2	0	1
LO Monitor Current Ch 17 Coefficient 3	639	640	i	2	0	1
LO Monitor Current Ch 18, 19, & 20 Coefficient 0	641	642	i	2	3	1
LO Monitor Current Ch 18, 19, & 20 Coefficient 1	643	644	i	2	5	1
LO Monitor Current Ch 18, 19, & 20 Coefficient 2	645	646	i	2	0	1
LO Monitor Current Ch 18, 19, & 20 Coefficient 3	647	648	i	2	0	1
LO Ch 16 Temperature Coefficient 0	649	650	i	2	2	1
LO Ch 16 Temperature Coefficient 1	651	652	i	2	7	1
LO Ch 16 Temperature Coefficient 2	653	654	i	2	12	1
LO Ch 16 Temperature Coefficient 3	655	656	i	2	18	1
LO Ch 17 Temperature Coefficient 0	657	658	i	2	2	1
LO Ch 17 Temperature Coefficient 1	659	660	i	2	7	1
LO Ch 17 Temperature Coefficient 2	661	662	i	2	12	1
LO Ch 17 Temperature Coefficient 3	663	664	i	2	18	1
LO Ch 18, 19, & 20 Temperature Coefficient 0	665	666	i	2	2	1
LO Ch 18, 19, & 20 Temperature Coefficient 1	667	668	i	2	7	1
LO Ch 18, 19, & 20 Temperature Coefficient 2	669	670	i	2	12	1
LO Ch 18, 19, & 20 Temperature Coefficient 3	671	672	i	2	18	1
PRT Bridge Voltage Coefficient 0	673	674	i	2	0	1
PRT Bridge Voltage Coefficient 1	675	676	i	2	5	1
PRT Bridge Voltage Coefficient 2	677	678	i	2	0	1
PRT Bridge Voltage Coefficient 3	679	680	i	2	0	1
PRT Board Temperature Coefficient 0	681	682	i	2	1	1

PRT Board Temperature Coefficient 1	683	684	i	2	6	1
PRT Board Temperature Coefficient 2	685	686	i	2	10	1
PRT Board Temperature Coefficient 3	687	688	i	2	15	1
<zero fill>	689	704	i	4	0	4
ANALOG TELEMETRY CONVERSION						
+12V (A) Secondary Conversion Coefficient 0	705	708	I	4	6	1
+12V (A) Secondary Conversion Coefficient 1	709	712	i	4	6	1
+12V (A) Secondary Conversion Coefficient 2	713	716	i	4	6	1
+12V (A) Secondary Conversion Coefficient 3	717	720	i	4	6	1
-12V (A) Secondary Conversion Coefficient 0	721	724	i	4	6	1
-12V (A) Secondary Conversion Coefficient 1	725	728	i	4	6	1
-12V (A) Secondary Conversion Coefficient 2	729	732	i	4	6	1
-12V (A) Secondary Conversion Coefficient 3	733	736	i	4	6	1
+15V (A) Secondary Conversion Coefficient 0	737	740	i	4	6	1
+15V (A) Secondary Conversion Coefficient 1	741	744	i	4	6	1
+15V (A) Secondary Conversion Coefficient 2	745	748	i	4	6	1
+15V (A) Secondary Conversion Coefficient 3	749	752	i	4	6	1
-15V (A) Secondary Conversion Coefficient 0	753	756	i	4	6	1
-15V (A) Secondary Conversion Coefficient 1	757	760	i	4	6	1
-15V (A) Secondary Conversion Coefficient 2	761	764	i	4	6	1
-15V (A) Secondary Conversion Coefficient 3	765	768	i	4	6	1
+8v (A) Secondary Conversion Coefficient 0	769	772	i	4	6	1
+8v (A) Secondary Conversion Coefficient 1	773	776	i	4	6	1
+8v (A) Secondary Conversion Coefficient 2	777	780	i	4	6	1
+8v (A) Secondary Conversion Coefficient 3	781	784	i	4	6	1
+5V (D) Secondary Conversion Coefficient 0	785	788	i	4	6	1
+5V (D) Secondary Conversion Coefficient 1	789	792	i	4	6	1
+5V (D) Secondary Conversion Coefficient 2	793	796	i	4	6	1
+5V (D) Secondary Conversion Coefficient 3	797	800	i	4	6	1
+5V (A) Secondary Conversion Coefficient 0	801	804	i	4	6	1
+5V (A) Secondary Conversion Coefficient 1	805	808	i	4	6	1
+5V (A) Secondary Conversion Coefficient 2	809	812	i	4	6	1
+5V (A) Secondary Conversion Coefficient 3	813	816	i	4	6	1
-5V (A) Secondary Conversion Coefficient 0	817	820	i	4	6	1
-5V (A) Secondary Conversion Coefficient 1	821	824	i	4	6	1
-5V (A) Secondary Conversion Coefficient 2	825	828	i	4	6	1
-5V (A) Secondary Conversion Coefficient 3	829	832	i	4	6	1
+5V Reference Secondary Conv Coefficient 0	833	836	i	4	6	1
+5V Reference Secondary Conv Coefficient 1	837	840	i	4	6	1
+5V Reference Secondary Conv Coefficient 2	841	844	i	4	6	1
+5V Reference Secondary Conv Coefficient 3	845	848	i	4	6	1
ICE Temperature Conversion Coefficient 0	849	852	i	4	6	1
ICE Temperature Conversion Coefficient 1	853	856	i	4	6	1
ICE Temperature Conversion Coefficient 2	857	860	i	4	6	1
ICE Temperature Conversion Coefficient 3	861	864	i	4	6	1
MDE Temperature Conversion Coefficient 0	865	868	i	4	6	1
MDE Temperature Conversion Coefficient 1	869	872	i	4	6	1
MDE Temperature Conversion Coefficient 2	873	876	i	4	6	1
MDE Temperature Conversion Coefficient 3	877	880	i	4	6	1

PEU Temperature Conversion Coefficient 0	881	884	i	4	6	1
PEU Temperature Conversion Coefficient 1	885	888	i	4	6	1
PEU Temperature Conversion Coefficient 2	889	892	i	4	6	1
PEU Temperature Conversion Coefficient 3	893	896	i	4	6	1
PSU Temperature Conversion Coefficient 0	897	900	i	4	6	1
PSU Temperature Conversion Coefficient 1	901	904	i	4	6	1
PSU Temperature Conversion Coefficient 2	905	908	i	4	6	1
PSU Temperature Conversion Coefficient 3	909	912	i	4	6	1
Scan Motor Temperature Conv Coefficient 0	913	916	i	4	6	1
Scan Motor Temperature Conv Coefficient 1	917	920	i	4	6	1
Scan Motor Temperature Conv Coefficient 2	921	924	i	4	6	1
Scan Motor Temperature Conv Coefficient 3	925	928	i	4	6	1
Scan Motor Current Conversion Coefficient 0	929	932	i	4	6	1
Scan Motor Current Conversion Coefficient 1	933	936	i	4	6	1
Scan Motor Current Conversion Coefficient 2	937	940	i	4	6	1
Scan Motor Current Conversion Coefficient 3	941	944	i	4	6	1
Ch 16 LO Temperature Conversion Coefficient 0	945	948	i	4	6	1
Ch 16 LO Temperature Conversion Coefficient 1	949	952	i	4	6	1
Ch 16 LO Temperature Conversion Coefficient 2	953	956	i	4	6	1
Ch 16 LO Temperature Conversion Coefficient 3	957	960	i	4	6	1
Ch 17 LO Temperature Conversion Coefficient 0	961	964	i	4	6	1
Ch 17 LO Temperature Conversion Coefficient 1	965	968	i	4	6	1
Ch 17 LO Temperature Conversion Coefficient 2	969	972	i	4	6	1
Ch 17 LO Temperature Conversion Coefficient 3	973	976	i	4	6	1
Ch 18/19/20 LO Temp Conversion Coefficient 0	977	980	i	4	6	1
Ch 18/19/20 LO Temp Conversion Coefficient 1	981	984	i	4	6	1
Ch 18/19/20 LO Temp Conversion Coefficient 2	985	988	i	4	6	1
Ch 18/19/20 LO Temp Conversion Coefficient 3	989	992	i	4	6	1
<zero fill>	993	1000	i	4	6	2
BIAS CORRECTION 1						
Bias Correction Values 2 (values are given in counts) Ordered by channel, field of view (FOV), and transmitter as follows: Word 1: Channel 16, FOV 1, STX-1 Word 2: Channel 17, FOV 1, STX-1 Word 3: Channel 18, FOV 1, STX-1 Word 4: Channel 19, FOV 1, STX-1 Word 5: Channel 20, FOV 1, STX-1 Word 6: Channel 16, FOV 5, STX-1 ... (channel values for FOVs 5, 10, 15, ... , 90) ... Word 95: Channel 20, FOV 90, STX-1 Word 96: Channel 16, Space View, STX-1 ... Word 100: Channel 20, Space View, STX-1 Word 101: Channel 16, Warm View, STX-1	1001	1840	i	2	0	420

... Word 106: Channel 16, FOV 1, STX-2 ... Word 211: Channel 16, FOV 1, STX-3 ... Word 316: Channel 16, FOV 1, SARR ... Word 420: Channel 20, Warm View, SARR						
<zero fill>	1841	1848	i	4	0	2
TRANSMITTER 1						
Transmitter Reference Power Mean power at the time bias corrections were derived. (values are given in counts from 0 to 255, representing analog voltages from 0 to 5.1) Word 1: STX-1 Word 2: STX-2 Word 3: STX-3 Word 4: SARR	1849	1856	i	2	1	4
<zero fill>	1857	1864	i	4	0	2
“NEW” BIAS CORRECTION 2						
“New” Bias Correction Values (values are given in counts) Ordered by channel, field of view (FOV), and cycle within 8 second period as follows: Word 1: Channel 16, FOV 1, Cycle 1 Word 2: Channel 17, FOV 1, Cycle 1 Word 3: Channel 18, FOV 1, Cycle 1 Word 4: Channel 19, FOV 1, Cycle 1 Word 5: Channel 20, FOV 1, Cycle 1 Word 6: Channel 16, FOV 3, Cycle 1 ... (channel correction values for FOVs 3, 6, 9, ... , 90) ... Word 155: Channel 20, FOV 90, Cycle 1 Word 156: Channel 16, Space View, Cycle 1 ... Word 160: Channel 20, Space View, Cycle 1 Word 161: Channel 16, Warm View, Cycle 1 ... Word 165: Channel 20, Warm View, Cycle 1 Word 166: Channel 16, FOV 1, Cycle 2 ... Word 330: Channel 20, Warm View, Cycle 2 Word 331: Channel 16, FOV 1, Cycle 3 ... Word 495: Channel 20, Warm View, Cycle 3	1865	2854	i	2	0	495
FILLER 2						
<zero fill>	2855	3072	i	2	0	109

Notes (Revision History):

- 1) 12 Nov 1998 (NOAA-15 Orbit B0260303): Add bias correction and transmitter power fields; adjust trailing zero fill.
- 2) 04 Mar 1999 (NOAA-15 Orbit B0419595): Add “new” bias corrections rename bias correction Cold and Warm Cal FOV to Space and Warm View ,respectively; adjust trailing zero fill.

8.3.1.7.2.2 NOAA-N Format (Version 4, post-January 25, 2006, All Spacecraft)

The AMSU-B Data Set Header Record format for version 4 after January 25, 2006 for NOAA 15, -16, and -17 is documented in Table 8.3.1.7.2.2-1. See the legend in Section 8.3.1.1 for further explanation of the headings on this table.

Table 8.3.1.7.2.2-1. Format of AMSU-B Data Set Header Record for NOAA-N (Version 4, post-January 25, 2006, All Spacecraft).								
Field Name	Start Octet	End Octet	D T	Word Size	Number of Words	S F	Units	Notes
FILE IDENTIFICATION								
Data Set Creation Site ID CMS=Centre de Meteorologie Spatiale/France DSS=Dundee Satellite Receiving Station/UK NSS=National Environmental Satellite, Data and Information Service/USA UKM=United Kingdom Meteorological Office/UK	1	3	c	3	1	0		
<ASCII blank = x20>	4	4	c	1	1	0		
Level 1b Format Version Number 1=TIROS-N, NOAA-6 through NOAA-14; 2=NOAA-15, -16, -17 (pre-April 28, 2005); 3=all satellites post-April 28, 2005 4=cloud mask flag (CLAVR-x)-Jan 25, 2006	5	6	u	2	1	0		
Level 1b Format Version Year (<i>four digits, e.g., 2000</i>)	7	8	u	2	1	0		
Level 1b Format Version Day of Year (<i>e.g., 365</i>)	9	10	u	2	1	0		
<Reserved for Logical Record Length> (<i>For Creation Site use only. Logical Record Length of source 1b data set prior to processing.</i>)	11	12	u	2	1	0	octets	
<Reserved for Block Size> (<i>For Creation Site use only. Block Size of source 1b data set prior to processing.</i>)	13	14	u	2	1	0	octets	
Count of Header Records in this Data Set	15	16	u	2	1	0		
<zero fill>	17	22	i	2	3	0		
Data Set Name	23	64	c	42	1	0		
Processing Block Identification	65	72	c	8	1	0		

NOAA Spacecraft Identification Code 2=NOAA-16 4=NOAA-15 6=NOAA-17 7=NOAA-18 8=NOAA-N' 11=MetOp-1 12=MetOp-2	73	74	u	2	1	0		
Instrument ID 0=Engineering Model; 4=protoflight model (PFM); 8=FM 2 ; 12=FM 3.	75	76	u	2	1	0		
Data Type Code 11=AMSU-B	77	78	u	2	1	0		
TIP Source Code 0=unused, i.e., GAC/HRPT/LAC data 1=GAC-embedded AMSU and TIP 2=stored TIP (STIP) 3=HRPT/LAC-embedded AMSU and TIP 4=stored AIP (SAIP)	79	80	u	2	1	0		
Start of Data Set Day Count starting from 0 at 00h, 1 Jan 1950	81	84	u	4	1	0		
Start of Data Set Year (<i>four digits, e.g., 2000</i>)	85	86	u	2	1	0		
Start of Data Set Day of Year (<i>e.g., 365</i>)	87	88	u	2	1	0		
Start of Data Set UTC Time of Day	89	92	u	4	1	0	milli-second	
End of Data Set Day Count starting from 0 at 00h, 1 Jan 1950	93	96	u	4	1	0		
End of Data Set Year (<i>four digits, e.g., 2000</i>)	97	98	u	2	1	0		
End of Data Set Day of Year (<i>e.g., 365</i>)	99	100	u	2	1	0		
End of Data Set UTC Time of Day	101	104	u	4	1	0	milli-second	
Year of Last CPIDS Update (<i>four digits, e.g., 2000</i>)	105	106	u	2	1	0		
Day of Year of Last CPIDS Update (<i>e.g., 365</i>)	107	108	u	2	1	0		
Offset between Start of Scan and Center of First FOV	109	110	i	2	1	0	milli-second	
<zero fill>	111	120	i	2	5	0		
DATA SET QUALITY INDICATORS								

Instrument Status bits 31-29: <not defined> bit 28: processor check flag (0=passed; 1=failed) bit 27: scan control status (0=running; 1=aborted) bit 26: pixel data invalid flag (0=valid; 1=invalid) bit 25: scan synchronization (0=error < 0.1 deg; 1=error >= 0.1 deg) bit 24: mode transition flag (0=transition complete; 1=transition in progress) bit 23: module ID, msbbits 22 - 17: module ID bit 16: module ID, lsbbit 15: RAM check flag (0=passed; 1=failed) bit 14: ROM check flag (0=passed; 1=failed) bit 13: memory checks status (0=disabled; 1=enabled) bit 12: space view select, lsbbit 11: space view select, msbbit 10: channel 18/19/20 (relay 5 status) (0=off; 1=on) bit 9: channel 17 (relay 4 status) (0=off; 1=on) bit 8: channel 16 (relay 3 status) (0=off; 1=on) bit 7: stepped mode (0=no; 1=yes) bit 6: investigation mode (0=no; 1=yes) bit 5: parked in space view mode (0=no; 1=yes) bit 4: parked in nadir view mode (0=no; 1=yes) bit 3: parked in target view mode (0=no; 1=yes) bit 2: scan normal mode (0=no; 1=yes) bit 1: survival heater (relay 2 status) (0=off; 1=on) bit 0: power (relay 1 status) (0=off; 1=on)	121	124	u	4	1	0		
<zero fill>	125	126	i	2	1	0		
Record Number of Status Change (<i>if 0, none occurred</i>)	127	128	u	2	1	0		
Second Instrument Status (<i>if previous word is 0, no change</i>)	129	132	u	4	1	0		
Count of Data Records in this Data Set	133	134	u	2	1	0		
Count of Calibrated, Earth Located Scan Lines in this Data Set	135	136	u	2	1	0		
Count of Missing Scan Lines	137	138	u	2	1	0		
Count of Data Gaps in this Data Set	139	140	u	2	1	0		
Count of Data Frames Without Frame Sync Word Errors	141	142	u	2	1	0		
Count of PACS Detected TIP Parity Errors	143	144	u	2	1	0		
Sum of All Auxiliary Sync Errors Detected in the Input Data	145	146	u	2	1	0		
Time Sequence Error 0=none; otherwise, the record number of the first occurrence	147	148	u	2	1	0		
Time Sequence Error Code (<i>These are bit flags</i>)	149	150	u	2	1	0		

<p>taken from "Scan Line Quality Flags [Time Problem Code]" on data record reported in "Time Sequence Error" field above. If a bit is on (=1) then the statement is true.)</p> <p>bits 15-8: <zero fill></p> <p>bit 7: time field is bad but can probably be inferred from the previous good time</p> <p>bit 6: time field is bad and can't be inferred from the previous good time</p> <p>bit 5: this record starts a sequence that is inconsistent with previous times (i.e., there is a time discontinuity); may be associated with a spacecraft clock update</p> <p>bit 4: start of a sequence that apparently repeats scan times that have been previously accepted</p> <p>bits 3-0: <zero fill></p>								
<p>SOCC Clock Update Indicator</p> <p>0=none during this orbit; otherwise, the record number of the first occurrence</p>	151	152	u	2	1	0		
<p>Earth Location Error Indicator</p> <p>0=none during this orbit; otherwise, the record number of the first occurrence</p>	153	154	u	2	1	0		
<p>Earth Location Error Code (<i>These are bit flags taken from "Scan Line Quality Flags [Earth Location Problem Code]" on data record reported in "Earth Location Error Indicator" field above. If a bit is on (=1) then the statement is true.</i>)</p> <p>bits 15-8: <zero fill></p> <p>bit 7: not earth located because of bad time; earth location fields zero-filled</p> <p>bit 6: earth location questionable: questionable time code</p> <p>bit 5: earth location questionable: marginal agreement with reasonableness check</p> <p>bit 4: earth location questionable: fails reasonableness check</p> <p>bit 3: earth location questionable because of antenna position</p> <p>checkbits 2-0: <zero fill></p>	155	156	u	2	1	0		
<p>PACS Status Bit Field</p> <p>bits 15-3: <zero fill></p> <p>bit 2: pseudonoise (0=normal data; 1=pseudonoise data)</p> <p>bit 1: tape direction (0=reverse playback, time decrementing)</p> <p>bit 0: data mode (0=test data; 1=flight data)</p>	157	158	u	2	1	0		
<p>Data Source</p> <p>0=unused</p> <p>1=Fairbanks, AK</p> <p>2=Wallops Island, VA</p> <p>3=SOCC</p>	159	160	u	2	1	0		

4=Svalbard, Norway								
5=Monterey, CA								
<Reserved for the Ingester>	161	168	c	8	1	0		
<Reserved for Decommutation>	169	176	c	8	1	0		
<zero fill>	177	192	i	4	4	0		
CALIBRATION								
Instrument Temperature Sensor ID 0=mixer temperature of channels 18-201=mixer temperature of channel 16	193	194	i	2	1	0		
<zero fill>	195	196	i	2	1	0		
Minimum Reference Temperature, mixer of Ch 18 - 20	197	198	i	2	1	2	K	
Nominal Reference Temperature, mixer of Ch 18 - 20	199	200	i	2	1	2	K	
Maximum Reference Temperature, mixer of Ch 18 - 20	201	202	i	2	1	2	K	
Minimum Reference Temperature, mixer of Ch 16	203	204	i	2	1	2	K	
Nominal Reference Temperature, mixer of Ch 16	205	206	i	2	1	2	K	
Maximum Reference Temperature, mixer of Ch 16	207	208	i	2	1	2	K	
Warm Target Fixed Bias Correction Ch 16 Min Temperature	209	210	i	2	1	3	K	
Warm Target Fixed Bias Correction Ch 16 Nominal Temperature	211	212	i	2	1	3	K	
Warm Target Fixed Bias Correction Ch 16 Max Temperature	213	214	i	2	1	3	K	
Space Fixed Bias Correction Ch 16	215	216	i	2	1	3	K	
Warm Target Fixed Bias Correction Ch 17 Min Temperature	217	218	i	2	1	3	K	
Warm Target Fixed Bias Correction Ch 17 Nominal Temperature	219	220	i	2	1	3	K	
Warm Target Fixed Bias Correction Ch 17 Max Temperature	221	222	i	2	1	3	K	
Space Fixed Bias Correction Ch 17	223	224	i	2	1	3	K	
Warm Target Fixed Bias Correction Ch 18 Min Temperature	225	226	i	2	1	3	K	
Warm Target Fixed Bias Correction Ch 18 Nominal Temperature	227	228	i	2	1	3	K	
Warm Target Fixed Bias Correction Ch 18 Max Temperature	229	230	i	2	1	3	K	
Space Fixed Bias Correction Ch 18	231	232	i	2	1	3	K	
Warm Target Fixed Bias Correction Ch 19 Min Temperature	233	234	i	2	1	3	K	
Warm Target Fixed Bias Correction Ch 19 Nominal Temperature	235	236	i	2	1	3	K	
Warm Target Fixed Bias Correction Ch 19 Max Temperature	237	238	i	2	1	3	K	
Space Fixed Bias Correction Ch 19	239	240	i	2	1	3	K	

Warm Target Fixed Bias Correction Ch 20 Min Temperature	241	242	i	2	1	3	K	
Warm Target Fixed Bias Correction Ch 20 Nominal Temperature	243	244	i	2	1	3	K	
Warm Target Fixed Bias Correction Ch 20 Max Temperature	245	246	i	2	1	3	K	
Space Fixed Bias Correction Ch 20	247	248	i	2	1	3	K	
Nonlinearity Coeff. Ch 1 at Reference Temperature 1	249	252	i	4	1	3	m ² -sr-cm ¹ /m W	
Nonlinearity Coeff. Ch 1 at Reference Temperature 2	253	256	i	4	1	3	m ² -sr-cm ¹ /m W	
Nonlinearity Coeff. Ch 1 at Reference Temperature 3	257	260	i	4	1	3	m ² -sr-cm ¹ /m W	
Nonlinearity Coeff. Ch 2 at Reference Temperature 1	261	264	i	4	1	3	m ² -sr-cm ¹ /m W	
Nonlinearity Coeff. Ch 2 at Reference Temperature 2	265	268	i	4	1	3	m ² -sr-cm ¹ /m W	
Nonlinearity Coeff. Ch 2 at Reference Temperature 3	269	272	i	4	1	3	m ² -sr-cm ¹ /m W	
Nonlinearity Coeff. Ch 3 at Reference Temperature 1	273	276	i	4	1	3	m ² -sr-cm ¹ /m W	
Nonlinearity Coeff. Ch 3 at Reference Temperature 2	277	280	i	4	1	3	m ² -sr-cm ¹ /m W	
Nonlinearity Coeff. Ch 3 at Reference Temperature 3	281	284	i	4	1	3	m ² -sr-cm ¹ /m W	
Nonlinearity Coeff. Ch 4 at Reference Temperature 1	285	288	i	4	1	3	m ² -sr-cm ¹ /m W	
Nonlinearity Coeff. Ch 4 at Reference Temperature 2	289	292	i	4	1	3	m ² -sr-cm ¹ /m W	
Nonlinearity Coeff. Ch 4 at Reference Temperature 3	293	296	i	4	1	3	m ² -sr-cm ¹ /m W	
Nonlinearity Coeff. Ch 5 at Reference Temperature 1	297	300	i	4	1	3	m ² -sr-cm ¹ /m W	
Nonlinearity Coeff. Ch 5 at Reference Temperature 2	301	304	i	4	1	3	m ² -sr-cm ¹ /m W	
Nonlinearity Coeff. Ch 5 at Reference	305	308	i	4	1	3	m ² -sr-	

Temperature 3							cm ¹ /m W	
<zero fill>	309	324	i	4	4	0		
TEMPERATURE-RADIANCE CONVERSION								
Temperature-radiance Ch 16 Central Wavenumber	325	328	i	4	1	6	cm ⁻¹	
Temperature-radiance Ch 16 Constant 1	329	332	i	4	1	6		
Temperature-radiance Ch 16 Constant 2	333	336	i	4	1	6		
Temperature-radiance Ch 17 Central Wavenumber	337	340	i	4	1	6	cm ⁻¹	
Temperature-radiance Ch 17 Constant 1	341	344	i	4	1	6		
Temperature-radiance Ch 17 Constant 2	345	348	i	4	1	6		
Temperature-radiance Ch 18 Central Wavenumber	349	352	i	4	1	6	cm ⁻¹	
Temperature-radiance Ch 18 Constant 1	353	356	i	4	1	6		
Temperature-radiance Ch 18 Constant 2	357	360	i	4	1	6		
Temperature-radiance Ch 19 Central Wavenumber	361	364	i	4	1	6	cm ⁻¹	
Temperature-radiance Ch 19 Constant 1	365	368	i	4	1	6		
Temperature-radiance Ch 19 Constant 2	369	372	i	4	1	6		
Temperature-radiance Ch 20 Central Wavenumber	373	376	i	4	1	6	cm ⁻¹	
Temperature-radiance Ch 20 Constant 1	377	380	i	4	1	6		
Temperature-radiance Ch 20 Constant 2	381	384	i	4	1	6		
<zero fill>	385	400	i	4	4	0		
NAVIGATION								
Reference Ellipsoid Model ID (<i>The ellipsoid is a mathematically tractable approximation of the geoid, which is an equipotential surface at mean sea level. The maximum departure of the ellipsoid from the geoid is approximately ± 65 meters.</i>) WGS-72=World Geodetic Survey 1972 JGM3 =Joint Gravity Model 3	401	408	c	8	1	0		
Nadir Earth Location Tolerance	409	410	u	2	1	1	Kilo- meters	
Earth Location Bit Field bits 15-3: <zero fill>bit 2: dynamic attitude error correction (0=not performed; 1=performed)bit 1: reasonableness test (0=inactive; 1=active)bit 0: constant attitude error correction (0=not performed; 1=performed)	411	412	u	2	1	0		
<zero fill>	413	414	i	2	1	0		
Constant Roll Attitude Error	415	416	i	2	1	3	degrees	
Constant Pitch Attitude Error	417	418	i	2	1	3	degrees	
Constant Yaw Attitude Error	419	420	i	2	1	3	degrees	
Epoch Year for Orbit Vector	421	422	u	2	1	0		
Day of Epoch Year for Orbit Vector	423	424	u	2	1	0		
Epoch UTC Time of Day for Orbit Vector	425	428	u	4	1	0	milli- second	
Semi-major Axis (<i>at the orbit vector epoch time</i>)	429	432	i	4	1	5	km	
Eccentricity (<i>at the orbit vector epoch time</i>)	433	436	i	4	1	8		
Inclination (<i>at the orbit vector epoch time</i>)	437	440	i	4	1	5	degrees	
Argument of Perigee (<i>at the orbit vector epoch</i>)	441	444	i	4	1	5	degrees	

<i>time)</i>								
Right Ascension of the Ascending Node (<i>at the orbit vector epoch time</i>)	445	448	i	4	1	5	degrees	
Mean Anomaly (<i>at the orbit vector epoch time</i>)	449	452	i	4	1	5	degrees	
Position Vector X Component (<i>at the orbit vector epoch time</i>)	453	456	i	4	1	5	km	
Position Vector Y Component (<i>at the orbit vector epoch time</i>)	457	460	i	4	1	5	km	
Position Vector Z Component (<i>at the orbit vector epoch time</i>)	461	464	i	4	1	5	km	
Velocity Vector X-dot Component (<i>at the orbit vector epoch time</i>)	465	468	i	4	1	8	km/sec	
Velocity Vector Y-dot Component (<i>at the orbit vector epoch time</i>)	469	472	i	4	1	8	km/sec	
Velocity Vector Z-dot Component (<i>at the orbit vector epoch time</i>)	473	476	i	4	1	8	km/sec	
Earth/Sun Distance Ratio (<i>at the orbit vector epoch time; relative to the mean distance of 1 AU</i>)	477	480	u	4	1	6		
<zero fill>	481	496	i	4	4	0		
DIGITAL A TELEMETRY CONVERSION								
Mixer 16 Temperature Coefficient 0	497	498	i	2	1	2	K	
Mixer 16 Temperature Coefficient 1	499	500	i	2	1	7	K/ count	
Mixer 16 Temperature Coefficient 2	501	502	i	2	1	12	K/ count ²	
Mixer 16 Temperature Coefficient 3	503	504	i	2	1	18	K/ count ³	
Mixer 17 Temperature Coefficient 0	505	506	i	2	1	2	K	
Mixer 17 Temperature Coefficient 1	507	508	i	2	1	7	K/ count	
Mixer 17 Temperature Coefficient 2	509	510	i	2	1	12	K/ count ²	
Mixer 17 Temperature Coefficient 3	511	512	i	2	1	18	K/ count ³	
Mixer 18, 19, & 20 Temperature Coefficient 0	513	514	i	2	1	2	K	
Mixer 18, 19, & 20 Temperature Coefficient 1	515	516	i	2	1	7	K/ count	
Mixer 18, 19, & 20 Temperature Coefficient 2	517	518	i	2	1	12	K/ count ²	
Mixer 18, 19, & 20 Temperature Coefficient 3	519	520	i	2	1	18	K/ count ³	
FET Amplifier 16 Temperature Coefficient 0	521	522	i	2	1	2	K	
FET Amplifier 16 Temperature Coefficient 1	523	524	i	2	1	7	K/ count	
FET Amplifier 16 Temperature Coefficient 2	525	526	i	2	1	12	K/ count ²	
FET Amplifier 16 Temperature Coefficient 3	527	528	i	2	1	18	K/ count ³	

FET Amplifier 17 Temperature Coefficient 0	529	530	i	2	1	2	K	
FET Amplifier 17 Temperature Coefficient 1	531	532	i	2	1	7	K/ count	
FET Amplifier 17 Temperature Coefficient 2	533	534	i	2	1	12	K/ count ²	
FET Amplifier 17 Temperature Coefficient 3	535	536	i	2	1	18	K/ count ³	
FET Amplifier 18 Temperature Coefficient 0	537	538	i	2	1	2	K	
FET Amplifier 18 Temperature Coefficient 1	539	540	i	2	1	7	K/ count	
FET Amplifier 18 Temperature Coefficient 2	541	542	i	2	1	12	K/ count ²	
FET Amplifier 18 Temperature Coefficient 3	543	544	i	2	1	18	K/ count ³	
FET Amplifier 19 Temperature Coefficient 0	545	546	i	2	1	2	K	
FET Amplifier 19 Temperature Coefficient 1	547	548	i	2	1	7	K/ count	
FET Amplifier 19 Temperature Coefficient 2	549	550	i	2	1	12	K/ count ²	
FET Amplifier 19 Temperature Coefficient 3	551	552	i	2	1	18	K/ count ³	
FET Amplifier 20 Temperature Coefficient 0	553	554	i	2	1	2	K	
FET Amplifier 20 Temperature Coefficient 1	555	556	i	2	1	7	K/ count	
FET Amplifier 20 Temperature Coefficient 2	557	558	i	2	1	12	K/ count ²	
FET Amplifier 20 Temperature Coefficient 3	559	560	i	2	1	18	K/ count ³	
Calibration Target Temperature 1 Coefficient 0	561	562	i	2	1	2	K	
Calibration Target Temperature 1 Coefficient 1	563	564	i	2	1	7	K/ count	
Calibration Target Temperature 1 Coefficient 2	565	566	i	2	1	12	K/ count ²	
Calibration Target Temperature 1 Coefficient 3	567	568	i	2	1	18	K/ count ³	
Calibration Target Temperature 2 Coefficient 0	569	570	i	2	1	2	K	
Calibration Target Temperature 2 Coefficient 1	571	572	i	2	1	7	K/ count	
Calibration Target Temperature 2 Coefficient 2	573	574	i	2	1	12	K/ count ²	
Calibration Target Temperature 2 Coefficient 3	575	576	i	2	1	18	K/ count ³	
Calibration Target Temperature 3 Coefficient 0	577	578	i	2	1	2	K	
Calibration Target Temperature 3 Coefficient 1	579	580	i	2	1	7	K/ count	
Calibration Target Temperature 3 Coefficient 2	581	582	i	2	1	12	K/ count ²	
Calibration Target Temperature 3 Coefficient 3	583	584	i	2	1	18	K/	

							count ³	
Calibration Target Temperature 4 Coefficient 0	585	586	i	2	1	2	K	
Calibration Target Temperature 4 Coefficient 1	587	588	i	2	1	7	K/ count	
Calibration Target Temperature 4 Coefficient 2	589	590	i	2	1	12	K/ count ²	
Calibration Target Temperature 4 Coefficient 3	591	592	i	2	1	18	K/ count ³	
Calibration Target Temperature 5 Coefficient 0	593	594	i	2	1	2	K	
Calibration Target Temperature 5 Coefficient 1	595	596	i	2	1	7	K/ count	
Calibration Target Temperature 5 Coefficient 2	597	598	i	2	1	12	K/ count ²	
Calibration Target Temperature 5 Coefficient 3	599	600	i	2	1	18	K/ count ³	
Calibration Target Temperature 6 Coefficient 0	601	602	i	2	1	2	K	
Calibration Target Temperature 6 Coefficient 1	603	604	i	2	1	7	K/ count	
Calibration Target Temperature 6 Coefficient 2	605	606	i	2	1	12	K/ count ²	
Calibration Target Temperature 6 Coefficient 3	607	608	i	2	1	18	K/ count ³	
Calibration Target Temperature 7 Coefficient 0	609	610	i	2	1	2	K	
Calibration Target Temperature 7 Coefficient 1	611	612	i	2	1	7	K/ count	
Calibration Target Temperature 7 Coefficient 2	613	614	i	2	1	12	K/ count ²	
Calibration Target Temperature 7 Coefficient 3	615	616	i	2	1	18	K/ count ³	
Sub-reflector Temperature 1 Coefficient 0	617	618	i	2	1	2	K	
Sub-reflector Temperature 1 Coefficient 1	619	620	i	2	1	7	K/ count	
Sub-reflector Temperature 1 Coefficient 2	621	622	i	2	1	12	K/ count ²	
Sub-reflector Temperature 1 Coefficient 3	623	624	i	2	1	18	K/ count ³	
LO Monitor Current Ch 16 Coefficient 0	625	626	i	2	1	3	mA	
LO Monitor Current Ch 16 Coefficient 1	627	628	i	2	1	5	mA/ count	
LO Monitor Current Ch 16 Coefficient 2	629	630	i	2	1	0	mA/ count ²	
LO Monitor Current Ch 16 Coefficient 3	631	632	i	2	1	0	mA/ count ³	
LO Monitor Current Ch 17 Coefficient 0	633	634	i	2	1	3	mA	
LO Monitor Current Ch 17 Coefficient 1	635	636	i	2	1	5	mA/ count	
LO Monitor Current Ch 17 Coefficient 2	637	638	i	2	1	0	mA/ count ²	

LO Monitor Current Ch 17 Coefficient 3	639	640	i	2	1	0	mA/ count ³	
LO Monitor Current Ch 18, 19, & 20 Coefficient 0	641	642	i	2	1	3	mA	
LO Monitor Current Ch 18, 19, & 20 Coefficient 1	643	644	i	2	1	5	mA/ count	
LO Monitor Current Ch 18, 19, & 20 Coefficient 2	645	646	i	2	1	0	mA/ count ²	
LO Monitor Current Ch 18, 19, & 20 Coefficient 3	647	648	i	2	1	0	mA/ count ³	
LO Ch 16 Temperature Coefficient 0	649	650	i	2	1	2	K	
LO Ch 16 Temperature Coefficient 1	651	652	i	2	1	7	K/ count	
LO Ch 16 Temperature Coefficient 2	653	654	i	2	1	12	K/ count ²	
LO Ch 16 Temperature Coefficient 3	655	656	i	2	1	18	K/ count ³	
LO Ch 17 Temperature Coefficient 0	657	658	i	2	1	2	K	
LO Ch 17 Temperature Coefficient 1	659	660	i	2	1	7	K/ count	
LO Ch 17 Temperature Coefficient 2	661	662	i	2	1	12	K/ count ²	
LO Ch 17 Temperature Coefficient 3	663	664	i	2	1	18	K/ count ³	
LO Ch 18, 19, & 20 Temperature Coefficient 0	665	666	i	2	1	2	K	
LO Ch 18, 19, & 20 Temperature Coefficient 1	667	668	i	2	1	7	K/ count	
LO Ch 18, 19, & 20 Temperature Coefficient 2	669	670	i	2	1	12	K/ count ²	
LO Ch 18, 19, & 20 Temperature Coefficient 3	671	672	i	2	1	18	K/ count ³	
PRT Bridge Voltage Coefficient 0	673	674	i	2	1	0	V	
PRT Bridge Voltage Coefficient 1	675	676	i	2	1	5	V/ count	
PRT Bridge Voltage Coefficient 2	677	678	i	2	1	0	V/ count ²	
PRT Bridge Voltage Coefficient 3	679	680	i	2	1	0	V/ count ³	
PRT Board Temperature Coefficient 0	681	682	i	2	1	1	K	
PRT Board Temperature Coefficient 1	683	684	i	2	1	6	K/ count	
PRT Board Temperature Coefficient 2	685	686	i	2	1	10	K/ count ²	
PRT Board Temperature Coefficient 3	687	688	i	2	1	15	K/ count ³	
<zero fill>	689	704	i	4	4	0		
ANALOG TELEMETRY CONVERSION								
+12V (A) Secondary Conversion Coefficient 0	705	708	i	4	1	6	V	

+12V (A) Secondary Conversion Coefficient 1	709	712	i	4	1	6	V/ count	
+12V (A) Secondary Conversion Coefficient 2	713	716	i	4	1	6	V/ count ²	
+12V (A) Secondary Conversion Coefficient 3	717	720	i	4	1	6	V/ count ³	
-12V (A) Secondary Conversion Coefficient 0	721	724	i	4	1	6	V	
-12V (A) Secondary Conversion Coefficient 1	725	728	i	4	1	6	V/ count	
-12V (A) Secondary Conversion Coefficient 2	729	732	i	4	1	6	V/ count ²	
-12V (A) Secondary Conversion Coefficient 3	733	736	i	4	1	6	V/ count ³	
+15V (A) Secondary Conversion Coefficient 0	737	740	i	4	1	6	V	
+15V (A) Secondary Conversion Coefficient 1	741	744	i	4	1	6	V/ count	
+15V (A) Secondary Conversion Coefficient 2	745	748	i	4	1	6	V/ count ²	
+15V (A) Secondary Conversion Coefficient 3	749	752	i	4	1	6	V/ count ³	
-15V (A) Secondary Conversion Coefficient 0	753	756	i	4	1	6	V	
-15V (A) Secondary Conversion Coefficient 1	757	760	i	4	1	6	V/ count	
-15V (A) Secondary Conversion Coefficient 2	761	764	i	4	1	6	V/ count ²	
-15V (A) Secondary Conversion Coefficient 3	765	768	i	4	1	6	V/ count ³	
+8v (A) Secondary Conversion Coefficient 0	769	772	i	4	1	6	V	
+8v (A) Secondary Conversion Coefficient 1	773	776	i	4	1	6	V/ count	
+8v (A) Secondary Conversion Coefficient 2	777	780	i	4	1	6	V/ count ²	
+8v (A) Secondary Conversion Coefficient 3	781	784	i	4	1	6	V/ count ³	
+5V (D) Secondary Conversion Coefficient 0	785	788	i	4	1	6	V	
+5V (D) Secondary Conversion Coefficient 1	789	792	i	4	1	6	V/ count	
+5V (D) Secondary Conversion Coefficient 2	793	796	i	4	1	6	V/ count ²	
+5V (D) Secondary Conversion Coefficient 3	797	800	i	4	1	6	V/ count ³	
+5V (A) Secondary Conversion Coefficient 0	801	804	i	4	1	6	V	
+5V (A) Secondary Conversion Coefficient 1	805	808	i	4	1	6	V/ count	
+5V (A) Secondary Conversion Coefficient 2	809	812	i	4	1	6	V/ count ²	
+5V (A) Secondary Conversion Coefficient 3	813	816	i	4	1	6	V/ count ³	

-5V (A) Secondary Conversion Coefficient 0	817	820	i	4	1	6	V	
-5V (A) Secondary Conversion Coefficient 1	821	824	i	4	1	6	V/ count	
-5V (A) Secondary Conversion Coefficient 2	825	828	i	4	1	6	V/ count ²	
-5V (A) Secondary Conversion Coefficient 3	829	832	i	4	1	6	V/ count ³	
+5V Reference Secondary Conv Coefficient 0	833	836	i	4	1	6	V	
+5V Reference Secondary Conv Coefficient 1	837	840	i	4	1	6	V/ count	
+5V Reference Secondary Conv Coefficient 2	841	844	i	4	1	6	V/ count ²	
+5V Reference Secondary Conv Coefficient 3	845	848	i	4	1	6	V/ count ³	
ICE Temperature Conversion Coefficient 0	849	852	i	4	1	6	K	
ICE Temperature Conversion Coefficient 1	853	856	i	4	1	6	K/ count	
ICE Temperature Conversion Coefficient 2	857	860	i	4	1	6	K/ count ²	
ICE Temperature Conversion Coefficient 3	861	864	i	4	1	6	K/ count ³	
MDE Temperature Conversion Coefficient 0	865	868	i	4	1	6	K	
MDE Temperature Conversion Coefficient 1	869	872	i	4	1	6	K/ count	
MDE Temperature Conversion Coefficient 2	873	876	i	4	1	6	K/ count ²	
MDE Temperature Conversion Coefficient 3	877	880	i	4	1	6	K/ count ³	
PEU Temperature Conversion Coefficient 0	881	884	i	4	1	6	K	
PEU Temperature Conversion Coefficient 1	885	888	i	4	1	6	K/ count	
PEU Temperature Conversion Coefficient 2	889	892	i	4	1	6	K/ count ²	
PEU Temperature Conversion Coefficient 3	893	896	i	4	1	6	K/ count ³	
PSU Temperature Conversion Coefficient 0	897	900	i	4	1	6	K	
PSU Temperature Conversion Coefficient 1	901	904	i	4	1	6	K/ count	
PSU Temperature Conversion Coefficient 2	905	908	i	4	1	6	K/ count ²	
PSU Temperature Conversion Coefficient 3	909	912	i	4	1	6	K/ count ³	
Scan Motor Temperature Conv Coefficient 0	913	916	i	4	1	6	K	
Scan Motor Temperature Conv Coefficient 1	917	920	i	4	1	6	K/ count	
Scan Motor Temperature Conv Coefficient 2	921	924	i	4	1	6	K/ count ²	
Scan Motor Temperature Conv Coefficient 3	925	928	i	4	1	6	K/	

							count ³	
Scan Motor Current Conversion Coefficient 0	929	932	i	4	1	6	A	
Scan Motor Current Conversion Coefficient 1	933	936	i	4	1	6	A/ count	
Scan Motor Current Conversion Coefficient 2	937	940	i	4	1	6	A/ count ²	
Scan Motor Current Conversion Coefficient 3	941	944	i	4	1	6	A/ count ³	
Ch 16 LO Temperature Conversion Coefficient 0	945	948	i	4	1	6	K	
Ch 16 LO Temperature Conversion Coefficient 1	949	952	i	4	1	6	K/ count	
Ch 16 LO Temperature Conversion Coefficient 2	953	956	i	4	1	6	K/ count ²	
Ch 16 LO Temperature Conversion Coefficient 3	957	960	i	4	1	6	K/ count ³	
Ch 17 LO Temperature Conversion Coefficient 0	961	964	i	4	1	6	K	
Ch 17 LO Temperature Conversion Coefficient 1	965	968	i	4	1	6	K/ count	
Ch 17 LO Temperature Conversion Coefficient 2	969	972	i	4	1	6	K/ count ²	
Ch 17 LO Temperature Conversion Coefficient 3	973	976	i	4	1	6	K/ count ³	
Ch 18/19/20 LO Temperature Conversion Coefficient 0	977	980	i	4	1	6	K	
Ch 18/19/20 LO Temperature Conversion Coefficient 1	981	984	i	4	1	6	K/ count	
Ch 18/19/20 LO Temperature Conversion Coefficient 2	985	988	i	4	1	6	K/ count ²	
Ch 18/19/20 LO Temperature Conversion Coefficient 3	989	992	i	4	1	6	K/ count ³	
<zero fill>	993	1000	i	4	2	0		
Bias Correction								
Bias Correction Values (values are given in counts) Ordered by channel, field of view (FOV), and transmitter as follows: <i>Word 1:</i> Channel 16, FOV 1, STX-1 <i>Word 2:</i> Channel 17, FOV 1, STX-1 <i>Word 3:</i> Channel 18, FOV 1, STX-1 <i>Word 4:</i> Channel 19, FOV 1, STX-1 <i>Word 5:</i> Channel 20, FOV 1, STX-1 <i>Word 6:</i> Channel 16, FOV 5, STX-1 ... (channel values for FOVs 5, 10, 15, ... , 90) ... <i>Word 95:</i> Channel 20, FOV 90, STX-1 <i>Word 96:</i> Channel 16, Space View, STX-1 ...	1001	1840	i	2	420	0	counts	

Word 100: Channel 20, Space View, STX-1 Word 101: Channel 16, Warm View, STX-1 ... Word 106: Channel 16, FOV 1, STX-2 ... Word 211: Channel 16, FOV 1, STX-3 ... Word 316: Channel 16, FOV 1, SARR ... Word 420: Channel 20, Warm View, SARR								
<zero fill>	1841	1848	i	4	2	0		
Transmitter								
Transmitter Reference Power (Mean power at the time bias corrections were derived. Range: 0 to 255, representing analog voltages from 0 to 5.1.) Word 1: STX-1 Word 2: STX-2 Word 3: STX-3 Word 4: SARR	1849	1856	i	2	4	1	counts	
<zero fill>	1857	1864	i	4	2	0		
“New” Bias Correction								
"New" Bias Correction Values (Ordered by channel, field of view (FOV), and cycle within 8 second period) Word 1: Channel 16, FOV 1, Cycle 1 Word 2: Channel 17, FOV 1, Cycle 1 Word 3: Channel 18, FOV 1, Cycle 1 Word 4: Channel 19, FOV 1, Cycle 1 Word 5: Channel 20, FOV 1, Cycle 1 Word 6: Channel 16, FOV 3, Cycle 1 ... (channel correction values for FOVs 3, 6, 9, ... , 90) ... Word 155: Channel 20, FOV 90, Cycle 1 Word 156: Channel 16, Space View, Cycle 1 ... Word 160: Channel 20, Space View, Cycle 1 Word 161: Channel 16, Warm View, Cycle 1 ... Word 165: Channel 20, Warm View, Cycle 1 Word 166: Channel 16, FOV 1, Cycle 2 ... Word 330: Channel 20, Warm View, Cycle 2 Word 331: Channel 16, FOV 1, Cycle 3 ... Word 495: Channel 20, Warm View, Cycle 3	1865	2854	i	2	495	0	counts	
LUNAR CONTAMINATION								
Count of Scans Containing Lunar-Contaminated	2855	2856	i	2	1	0		

Space Views (Also, see bits 7 and 6 of "Scan Line Quality Flags [Additional Calibration Problem Code]" field in data record.) -1 = the detection algorithm for lunar contamination is turned off; 0 = the detection algorithm is turned on: no scans containing lunar-contaminated space views were found; >0 = the detection algorithm is turned on: the value in this field represents the number of scans found that contain lunar-contaminated space views.								
Lunar Angle Threshold (Any space view whose lunar angle - see "Lunar Angles" field in data record - is less than this value is flagged as being "lunar contaminated" and is not used in the calibration.)	2857	2858	u	2	1	2	degrees	
Filler								
<zero fill>	2859	3072	i	2	107	0		

8.3.1.7.3 Data Record Format

8.3.1.7.3.1 NOAA KLM (Version 2, pre-April 28, 2005)

Table 8.3.1.7.3.1-1. NOAA KLM Data Record Format (Version 2, pre-April 22, 2005)

Field Name	Start Octet	End Octet	Data Type	Word Size	Scale Factor	Number of Words	Units	Notes
Data Set Creation Site ID CMS = Centre de Meteorologie Spatiale/France; DSS = Dundee Satellite Receiving Station/UK; NSS = National Environmental Satellite, Data and Information Service/USA; UKM = United Kingdom Meteorological Office/UK	1	3	c	3	0	1		
<ASCII blank = x20>	4	4	c	1	0			
OAA Level 1b Format Version Number 1=TIROS-N, NOAA-6 through NOAA-14; 2=NOAA-15, -16, -17(pre-April 28, 2005); 3=all satellites post-April 28, 2005.	5	6			u	2		
NOAA Level 1b Format Version Year (e.g., 1999)	7	8	u	2	0	1		
NOAA Level 1b Format Version Day of Year (e.g., 365)	9	10	u	2	0	1		
<Reserved for Logical Record Length> For Creation Site use only. Logical Record Length of NOAA Level 1b data set prior to processing.	11	12	u	2	0	1		
<Reserved for Block Size>	13	14	u	2	0	1		

For Creation Site use only. Block Size of NOAA Level 1b data set prior to processing.								
Count of Header Records in this Data Set	15	16	u	2	0	1		
<Zero Fill>	17	22	i	2	0	3		
Data Set Name	23	64	c	42	0	1		
Processing Block Identification	65	72	c	8	0	1		
NOAA Spacecraft Identification Code 2 = NOAA-16; 4 = NOAA-15; 6 = NOAA-17	73	74	u	2	0			
Instrument ID (0 = Engineering Model; 4 = Protoflight Model; 8 = Flight Model 2; 12 = Flight Model 3	75	76	u	2	0	1		
Data Type Code 1 = LAC; 2 = GAC; 3 = HRPT; 4 = TIP; 5 = HIRS; 6 = MSU; 7 = SSU; 8 = DCS; 9 = SEM; 10 = AMSU-A; 11 = AMSU-B	77	78	u	2	0	1		
TIP Source Code 0 = unused, GAC/HRPT/LAC data; 1 = GAC embedded AMSU and TIP; 2 = stored TIP; 3 = HRPT/LAC embedded AMSU and TIP, 4 = stored AIP	79	80	u	2	0	1		
Start of Data Set Day Count starting from 0 at 00h, 1 Jan 1950	81	84	u	4	0	1		
Start of Data Set Year (e.g., 1999)	85	86	u	2	0	1		
Start of Data Set Day of Year (e.g., 365)	87	88	u	2	0	1		
Start of Data Set UTC Time of Day in Milliseconds	89	92	u	4	0	1		
End of Data Set Day Count starting from 0 at 00h, 1 Jan 1950	93	96	u	4	0	1		
End of Data Set Year (e.g., 1999)	97	98	u	2	0	1		
End of Data Set Day of Year (e.g., 365)	99	100	u	2	0	1		
End of Data Set UTC Time of Day in Milliseconds	101	104	u	4	0	1		
Year of Last CPIDS Update (e.g., 1999)	105	106	u	2	0	1		
Day of Year of Last CPIDS Update (e.g., 365)	107	108	u	2	0	1		
Offset between Start of Scan and Center of first FOV in Milliseconds	109	110	i	2	0	1		
<Zero Fill>	111	120	i	2	0	6		
Instrument Status bits 31 - 29: <not defined> bit 28: processor check flag (0 = passed; 1 = failed)	121	124	u	4	0	1		

bit 27: scan control status (0 = running; 1 = aborted) bit 26: pixel data invalid flag (0 = valid; 1 = invalid) bit 25: scan synchronization (0 = error < 0.1 deg; 1 = error >= 0.1 deg) bit 24: mode transition flag (0 = transition complete; 1 = transition in progress) bit 23: module ID (msb) (0 = EM; 4 = PFM; 8 = FM2; 12 = FM3) bits 22 - 17: module ID bit 16: module ID (lsb) bit 15: RAM check flag (0 = passed; 1 = failed) bit 14: ROM check flag (0 = passed; 1 = failed) bit 13: memory checks status (0 = disabled; 1 = enabled) bit 12: space view select (lsb) bit 11: space view select (msb) bit 10: channel 18/19/20 on/off (relay 5 status) (0 = off; 1 = on) bit 9: channel 17 on/off (relay 4 status) (0 = off; 1 = on) bit 8: channel 16 on/off (relay 3 status) (0 = off; 1 = on) bit 7: stepped mode (0 = no; 1 = yes) bit 6: investigation mode (0 = no; 1 = yes) bit 5: parked in space view mode (0 = no; 1 = yes) bit 4: parked in nadir view mode (0 = no; 1 = yes) bit 3: parked in target view mode (0 = no; 1 = yes) bit 2: scan normal mode (0 = no; 1 = yes) bit 1: survival heater on/off (relay 2 status) (0 = off; 1 = on) bit 0: power on/off (relay 1 status) (0 = off; 1 = on)								
<Zero Fill>	125	126	i	2	0	1		
Record Number of Status Change (if 0, none occurred)	127	128	u	2	0	1		
Second Instrument Status (if previous word is 0, no change)	129	132	u	4	0	1		
Count of Data Records in this Data Set	133	134	u	2	0	1		
Count of Calibrated, Earth Located Scan Lines in this Data Set	135	136	u	2	0	1		
Count of Missing Scan Lines	137	138	u	2	0	1		
Count of Data Gaps in this Data Set	139	140	u	2	0	1		
Count of Data Frames Without Frame Sync Word Errors	141	142	u	2	0	1		
Count of PACS Detected TIP Parity Errors	143	144	u	2	0	1		
Sum of All Auxiliary Sync Errors Detected in the Input Data	145	146	u	2	0	1		
Time Sequence Error (0 = none; otherwise the record number of the first occurrence)	147	148	u	2		1		
Time Sequence Error Code These are bit flags taken from Scan Line Quality Flags Time Problem Code on data record reported in Time Sequence Error field above.	149	150	u	2	0	1		

<p>If a bit is on (=1) then the statement is true.</p> <p>bits 15 - 8: <zero fill> bit 7: time field is bad but can probably be inferred from the previous good time. bit 6: time field is bad and can't be inferred from the previous good time. bit 5: this record starts a sequence that is inconsistent with previous times (i.e., there is a time discontinuity). This may or may not be associated with a spacecraft clock update. bit 4: start of a sequence that apparently repeats scan times that have been previously accepted. bits 3 - 0: <zero fill></p>								
<p>SOCC Clock Update Indicator (0 = none during this orbit; otherwise the record number of the first occurrence)</p>	151	152	u	2	0	1		
<p>Earth Location Error Indicator (0 = none during this orbit; otherwise the record number of the first occurrence)</p>	153	154	u	2	0	1		
<p>Earth Location Error Code These are bit flags taken from Scan Line Quality Flags Earth Location Problem Code on data record reported in Earth Location Error Indicator field above.</p> <p>If a bit is on (=1) then the statement is true.</p> <p>bits 15 - 8: <zero fill> bit 7: not earth located because of bad time; earth location fields zero filled. bit 6: earth location questionable because of questionable time code. (See time problem flags.) bit 5: earth location questionable -- only marginal agreement with reasonableness check. bit 4: earth location questionable -- fails reasonableness check. bit 3: earth location questionable because of antenna position check [rs060794.doc & rs062094.do1] bits 2-0: <zero fill></p>	155	156	u	2	0	1		
<p>PACS Status Bit Field bits 15-3: <zero fill> bit 2: pseudo noise (0 = normal data; 1 = P/N data) bit 1: tape direction (0 = time decrementing) bit 0: data mode (0 = test data; 1 = flight data)</p>	157	158	u	2	0	1		
<p>PACS Data Source (0 = unused; 1 = Fairbanks, AK; 2 = Wallops Island, VA; 3 = SOCC; 4=Svalbard, Norway; 5=Monterey, CA)</p>	159	160	u	2	0	1		
<Reserved for the Ingester>	161	168	c	8	0	1		
<Reserved for Decommuration>	169	176	c	8	0	1		
<Zero Fill>	177	192	i	4	0	4		

CALIBRATION

Instrument Temperature Sensor ID 0 = Mixer Temp of Ch 18 - 20; 1 = Mixer Temp of Ch 16	193	194	i	2	0			
<Zero Fill>	195	196	i	2	0			
Minimum Reference Temperature, mixer of Ch 18 - 20	197	198	i	2	2			
Nominal Reference Temperature, mixer of Ch 18 - 20	199	200	i	2	2			
Maximum Reference Temperature, mixer of Ch 18 - 20	201	202	i	2	2			
Minimum Reference Temperature, mixer of Ch 16	203	204	i	2	2			
Nominal Reference Temperature, mixer of Ch 16	205	206	i	2	2			
Maximum Reference Temperature, mixer of Ch 16	207	208	i	2	2			
Warm Target Fixed Bias Correction Ch 16 Min Temperature	209	210	i	2	3			
Warm Target Fixed Bias Correction Ch 16 Nominal Temperature	211	212	i	2	3			
Warm Target Fixed Bias Correction Ch 16 Max Temperature	213	214	i	2	3			
Space Fixed Bias Correction Ch 16	215	216	i	2	3			
Warm Target Fixed Bias Correction Ch 17 Min Temperature	217	218	i	2	3			
Warm Target Fixed Bias Correction Ch 17 Nominal Temperature	219	220	i	2	3			
Warm Target Fixed Bias Correction Ch 17 Max Temperature	221	222	i	2	3			
Space Fixed Bias Correction Ch 17	223	224	i	2	3			
Warm Target Fixed Bias Correction Ch 18 Min Temperature	225	226	i	2	3			
Warm Target Fixed Bias Correction Ch 18 Nominal Temperature	227	228	i	2	3			
Warm Target Fixed Bias Correction Ch 18 Max Temperature	229	230	i	2	3			
Space Fixed Bias Correction Ch 18	231	232	i	2	3			
Warm Target Fixed Bias Correction Ch 19 Min Temperature	233	234	i	2	3			
Warm Target Fixed Bias Correction Ch 19 Nominal Temperature	235	236	i	2	3			
Warm Target Fixed Bias Correction Ch 19 Max Temperature	237	238	i	2	3			
Space Fixed Bias Correction Ch 19	239	240	i	2	3			
Warm Target Fixed Bias Correction Ch 20 Min Temperature	241	242	i	2	3			
Warm Target Fixed Bias Correction Ch 20 Nominal Temperature	243	244	i	2	3			
Warm Target Fixed Bias Correction Ch 20 Max Temperature	245	246	i	2	3			
Space Fixed Bias Correction Ch 20	247	248	i	2	3			
Nonlinearity Coeff. Ch 1 at Reference Temperature 1	249	252	i	4	3			
Nonlinearity Coeff. Ch 1 at Reference Temperature 2	253	256	i	4	3			
Nonlinearity Coeff. Ch 1 at Reference Temperature 3	257	260	i	4	3			
Nonlinearity Coeff. Ch 2 at Reference Temperature 1	261	264	i	4	3			

Nonlinearity Coeff. Ch 2 at Reference Temperature 2	265	268	i	4	3			
Nonlinearity Coeff. Ch 2 at Reference Temperature 3	269	272	i	4	3			
Nonlinearity Coeff. Ch 3 at Reference Temperature 1	273	276	i	4	3			
Nonlinearity Coeff. Ch 3 at Reference Temperature 2	277	280	i	4	3			
Nonlinearity Coeff. Ch 3 at Reference Temperature 3	281	284	i	4	3			
Nonlinearity Coeff. Ch 4 at Reference Temperature 1	285	288	i	4	3			
Nonlinearity Coeff. Ch 4 at Reference Temperature 2	289	292	i	4	3			
Nonlinearity Coeff. Ch 4 at Reference Temperature 3	293	296	i	4	3			
Nonlinearity Coeff. Ch 5 at Reference Temperature 1	297	300	i	4	3			
Nonlinearity Coeff. Ch 5 at Reference Temperature 2	301	304	i	4	3			
Nonlinearity Coeff. Ch 5 at Reference Temperature 3	305	308	i	4	3			
<Zero Fill>	309	324	i	4	0			
TEMPERATURE-RADIANCE CONVERSION								
Temperature-radiance Ch 16 Central Wavenumber	325	328	i	4	6			
Temperature-radiance Ch 16 Constant 1	329	332	i	4	6			
Temperature-radiance Ch 16 Constant 2	333	336	i	4	6			
Temperature-radiance Ch 17 Central Wavenumber	337	340	i	4	6			
Temperature-radiance Ch 17 Constant 1	341	344	i	4	6			
Temperature-radiance Ch 17 Constant 2	345	348	i	4	6			
Temperature-radiance Ch 18 Central Wavenumber	349	352	i	4	6			
Temperature-radiance Ch 18 Constant 1	353	356	i	4	6			
Temperature-radiance Ch 18 Constant 2	357	360	i	4	6			
Temperature-radiance Ch 19 Central Wavenumber	361	364	i	4	6			
Temperature-radiance Ch 19 Constant 1	365	368	i	4	6			
Temperature-radiance Ch 19 Constant 2	369	372	i	4	6			
Temperature-radiance Ch 20 Central Wavenumber	373	376	i	4	6			
Temperature-radiance Ch 20 Constant 1	377	380	i	4	6			
Temperature-radiance Ch 20 Constant 2	381	384	i	4	6			
<Zero Fill>	385	400	i	4	0			
NAVIGATION								
Reference Ellipsoid Model ID The ellipsoid is a mathematically tractable approximation of the geoid, which is an equipotential surface at mean sea level. The maximum departure of the ellipsoid from the geoid is approximately ± 65 meters. (WGS-72 = World Geodetic Survey 1972)	401	408	c	8	0			
Nadir Earth Location Tolerance in Kilometers	409	410	u	2	1			
Earth Location Bit Field bits 15 - 2: <zero fill> bit 1: reasonableness test active (0 = inactive) bit 0: attitude error correction (0 = not corrected)	411	412	u	2	0			
<Zero Fill>	413	414	i	2	0			
Constant Roll Attitude Error in Degrees	415	416	i	2	3			
Constant Pitch Attitude Error in Degrees	417	418	i	2	3			
Constant Yaw Attitude Error in Degrees	419	420	i	2	3			
Epoch Year for Orbit Vector (e.g., 1999)	421	422	u	2	0			
Day of Epoch Year for Orbit Vector (e.g., 365)	423	424	u	2	0			
Epoch UTC Time of Day in Milliseconds for Orbit	425	428	u	4	0			

Vector								
Semi-major Axis in Kilometers	429	432	i	4	5			
Eccentricity	433	436	i	4	8			
Inclination in Degrees	437	440	i	4	5			
Argument of Perigee in Degrees	441	444	i	4	5			
Right Ascension of the Ascending Node in Degrees	445	448	i	4	5			
Mean Anomaly in Degrees	449	452	i	4	5			
Position Vector x Component in Kilometers	453	456	i	4	5			
Position Vector y Component in Kilometers	457	460	i	4	5			
Position Vector z Component in Kilometers	461	464	i	4	5			
Velocity Vector x-dot Component in Kilometers/second	465	468	i	4	8			
Velocity Vector y-dot Component in Kilometers/second	469	472	i	4	8			
Velocity Vector z-dot Component in Kilometers/second	473	476	I	4	8			
Earth/Sun Distance Ratio	477	480	u	4	6			
<Zero Fill>	481	496	i	4	0			
DIGITAL A CONVERSION								
Mixer 16 Temperature Coefficient 0	497	498	i	2	2			
Mixer 16 Temperature Coefficient 1	499	500	i	2	7			
Mixer 16 Temperature Coefficient 2	501	502	i	2	12			
Mixer 16 Temperature Coefficient 3	503	504	i	2	18			
Mixer 17 Temperature Coefficient 0	505	506	i	2	2			
Mixer 17 Temperature Coefficient 1	507	508	i	2	7			
Mixer 17 Temperature Coefficient 2	509	510	i	2	12			
Mixer 17 Temperature Coefficient 3	511	512	i	2	18			
Mixer 18, 19, & 20 Temperature Coefficient 0	513	514	i	2	2			
Mixer 18, 19, & 20 Temperature Coefficient 1	515	516	i	2	7			
Mixer 18, 19, & 20 Temperature Coefficient 2	517	518	i	2	12			
Mixer 18, 19, & 20 Temperature Coefficient 3	519	520	i	2	18			
FET Amplifier 16 Temperature Coefficient 0	521	522	i	2	2			
FET Amplifier 16 Temperature Coefficient 1	523	524	i	2	7			
FET Amplifier 16 Temperature Coefficient 2	525	526	i	2	12			
FET Amplifier 16 Temperature Coefficient 3	527	528	i	2	18			
FET Amplifier 17 Temperature Coefficient 0	529	530	i	2	2			
FET Amplifier 17 Temperature Coefficient 1	531	532	i	2	7			
FET Amplifier 17 Temperature Coefficient 2	533	534	i	2	12			
FET Amplifier 17 Temperature Coefficient 3	535	536	i	2	18			
FET Amplifier 18 Temperature Coefficient 0	537	538	i	2	2			
FET Amplifier 18 Temperature Coefficient 1	539	540	i	2	7			
FET Amplifier 18 Temperature Coefficient 2	541	542	i	2	12			
FET Amplifier 18 Temperature Coefficient 3	543	544	i	2	18			
FET Amplifier 19 Temperature Coefficient 0	545	546	i	2	2			
FET Amplifier 19 Temperature Coefficient 1	547	548	i	2	7			
FET Amplifier 19 Temperature Coefficient 2	549	550	i	2	12			
FET Amplifier 19 Temperature Coefficient 3	551	552	i	2	18			
FET Amplifier 20 Temperature Coefficient 0	553	554	i	2	2			

FET Amplifier 20 Temperature Coefficient 1	555	556	i	2	7			
FET Amplifier 20 Temperature Coefficient 2	557	558	i	2	12			
FET Amplifier 20 Temperature Coefficient 3	559	560	i	2	18			
Calibration Target Temperature 1 Coefficient 0	561	562	i	2	2			
Calibration Target Temperature 1 Coefficient 1	563	564	i	2	7			
Calibration Target Temperature 1 Coefficient 2	565	566	i	2	12			
Calibration Target Temperature 1 Coefficient 3	567	568	i	2	18			
Calibration Target Temperature 2 Coefficient 0	569	570	i	2	2			
Calibration Target Temperature 2 Coefficient 1	571	572	i	2	7			
Calibration Target Temperature 2 Coefficient 2	573	574	i	2	12			
Calibration Target Temperature 2 Coefficient 3	575	576	i	2	18			
Calibration Target Temperature 3 Coefficient 0	577	578	i	2	2			
Calibration Target Temperature 3 Coefficient 1	579	580	i	2	7			
Calibration Target Temperature 3 Coefficient 2	581	582	i	2	12			
Calibration Target Temperature 3 Coefficient 3	583	584	i	2	18			
Calibration Target Temperature 4 Coefficient 0	585	586	i	2	2			
Calibration Target Temperature 4 Coefficient 1	587	588	i	2	7			
Calibration Target Temperature 4 Coefficient 2	589	590	i	2	12			
Calibration Target Temperature 4 Coefficient 3	591	592	i	2	18			
Calibration Target Temperature 5 Coefficient 0	593	594	i	2	2			
Calibration Target Temperature 5 Coefficient 1	595	596	i	2	7			
Calibration Target Temperature 5 Coefficient 2	597	598	i	2	12			
Calibration Target Temperature 5 Coefficient 3	599	600	i	2	18			
Calibration Target Temperature 6 Coefficient 0	601	602	i	2	2			
Calibration Target Temperature 6 Coefficient 1	603	604	i	2	7			
Calibration Target Temperature 6 Coefficient 2	605	606	i	2	12			
Calibration Target Temperature 6 Coefficient 3	607	608	i	2	18			
Calibration Target Temperature 7 Coefficient 0	609	610	i	2	2			
Calibration Target Temperature 7 Coefficient 1	611	612	i	2	7			
Calibration Target Temperature 7 Coefficient 2	613	614	i	2	12			
Calibration Target Temperature 7 Coefficient 3	615	616	i	2	18			
Sub-reflector Temperature 1 Coefficient 0	617	618	i	2	2			
Sub-reflector Temperature 1 Coefficient 1	619	620	i	2	7			
Sub-reflector Temperature 1 Coefficient 2	621	622	i	2	12			
Sub-reflector Temperature 1 Coefficient 3	623	624	i	2	18			
LO Monitor Current Ch 16 Coefficient 0	625	626	i	2	3			
LO Monitor Current Ch 16 Coefficient 1	627	628	i	2	5			
LO Monitor Current Ch 16 Coefficient 2	629	630	i	2	0			
LO Monitor Current Ch 16 Coefficient 3	631	632	i	2	0			
LO Monitor Current Ch 17 Coefficient 0	633	634	i	2	3			
LO Monitor Current Ch 17 Coefficient 1	635	636	i	2	5			
LO Monitor Current Ch 17 Coefficient 2	637	638	i	2	0			
LO Monitor Current Ch 17 Coefficient 3	639	640	i	2	0			
LO Monitor Current Ch 18, 19, & 20 Coefficient 0	641	642	i	2	3			
LO Monitor Current Ch 18, 19, & 20 Coefficient 1	643	644	i	2	5			
LO Monitor Current Ch 18, 19, & 20 Coefficient 2	645	646	i	2	0			
LO Monitor Current Ch 18, 19, & 20 Coefficient 3	647	648	i	2	0			
LO Ch 16 Temperature Coefficient 0	649	650	i	2	2			

LO Ch 16 Temperature Coefficient 1	651	652	i	2	7			
LO Ch 16 Temperature Coefficient 2	653	654	i	2	12			
LO Ch 16 Temperature Coefficient 3	655	656	i	2	18			
LO Ch 17 Temperature Coefficient 0	657	658	i	2	2			
LO Ch 17 Temperature Coefficient 1	659	660	i	2	7			
LO Ch 17 Temperature Coefficient 2	661	662	i	2	12			
LO Ch 17 Temperature Coefficient 3	663	664	i	2	18			
LO Ch 18, 19, & 20 Temperature Coefficient 0	665	666	i	2	2			
LO Ch 18, 19, & 20 Temperature Coefficient 1	667	668	i	2	7			
LO Ch 18, 19, & 20 Temperature Coefficient 2	669	670	i	2	12			
LO Ch 18, 19, & 20 Temperature Coefficient 3	671	672	i	2	18			
PRT Bridge Voltage Coefficient 0	673	674	i	2	0			
PRT Bridge Voltage Coefficient 1	675	676	i	2	5			
PRT Bridge Voltage Coefficient 2	677	678	i	2	0			
PRT Bridge Voltage Coefficient 3	679	680	i	2	0			
PRT Board Temperature Coefficient 0	681	682	i	2	1			
PRT Board Temperature Coefficient 1	683	684	i	2	6			
PRT Board Temperature Coefficient 2	685	686	i	2	10			
PRT Board Temperature Coefficient 3	687	688	i	2	15			
<Zero Fill>	689	704	i	4	0			
ANALOG TELEMETRY CONVERSION								
+12V (A) Secondary Conversion Coefficient 0	705	708	i	4	6			
+12V (A) Secondary Conversion Coefficient 1	709	712	i	4	6			
+12V (A) Secondary Conversion Coefficient 2	713	716	i	4	6			
+12V (A) Secondary Conversion Coefficient 3	717	720	i	4	6			
-12V (A) Secondary Conversion Coefficient 0	721	724	i	4	6			
-12V (A) Secondary Conversion Coefficient 1	725	728	i	4	6			
-12V (A) Secondary Conversion Coefficient 2	729	732	i	4	6			
-12V (A) Secondary Conversion Coefficient 3	733	736	i	4	6			
+15V (A) Secondary Conversion Coefficient 0	737	740	i	4	6			
+15V (A) Secondary Conversion Coefficient 1	741	744	i	4	6			
+15V (A) Secondary Conversion Coefficient 2	745	748	i	4	6			
+15V (A) Secondary Conversion Coefficient 3	749	752	i	4	6			
-15V (A) Secondary Conversion Coefficient 0	753	756	i	4	6			
-15V (A) Secondary Conversion Coefficient 1	757	760	i	4	6			
-15V (A) Secondary Conversion Coefficient 2	761	764	i	4	6			
-15V (A) Secondary Conversion Coefficient 3	765	768	i	4	6			
+8v (A) Secondary Conversion Coefficient 0	769	772	i	4	6			
+8v (A) Secondary Conversion Coefficient 1	773	776	i	4	6			
+8v (A) Secondary Conversion Coefficient 2	777	780	i	4	6			
+8v (A) Secondary Conversion Coefficient 3	781	784	i	4	6			
+5V (D) Secondary Conversion Coefficient 0	785	788	i	4	6			
5V (D) Secondary Conversion Coefficient 1	789	792	i	4	6			
+5V (D) Secondary Conversion Coefficient 2	793	796	i	4	6			
+5V (D) Secondary Conversion Coefficient 3	797	800	i	4	6			
+5V (A) Secondary Conversion Coefficient 0	801	804	i	4	6			
+5V (A) Secondary Conversion Coefficient 1	805	808	i	4	6			
+5V (A) Secondary Conversion Coefficient 2	809	812	i	4	6			

+5V (A) Secondary Conversion Coefficient 3	813	816	i	4	6			
-5V (A) Secondary Conversion Coefficient 0	817	820	i	4	6			
-5V (A) Secondary Conversion Coefficient 1	821	824	i	4	6			
-5V (A) Secondary Conversion Coefficient 2	825	828	i	4	6			
-5V (A) Secondary Conversion Coefficient 3	829	832	i	4	6			
+5V Reference Secondary Conv Coefficient 0	833	836	i	4	6			
+5V Reference Secondary Conv Coefficient 1	837	840	i	4	6			
+5V Reference Secondary Conv Coefficient 2	841	844	i	4	6			
+5V Reference Secondary Conv Coefficient 3	845	848	i	4	6			
ICE Temperature Conversion Coefficient 0	849	852	i	4	6			
ICE Temperature Conversion Coefficient 1	853	856	i	4	6			
ICE Temperature Conversion Coefficient 2	857	860	i	4	6			
ICE Temperature Conversion Coefficient 3	861	864	i	4	6			
MDE Temperature Conversion Coefficient 0	865	868	i	4	6			
MDE Temperature Conversion Coefficient 1	869	872	i	4	6			
MDE Temperature Conversion Coefficient 2	873	876	i	4	6			
MDE Temperature Conversion Coefficient 3	877	880	i	4	6			
PEU Temperature Conversion Coefficient 0	881	884	i	4	6			
PEU Temperature Conversion Coefficient 1	885	888	i	4	6			
PEU Temperature Conversion Coefficient 2	889	892	i	4	6			
PEU Temperature Conversion Coefficient 3	893	896	i	4	6			
PSU Temperature Conversion Coefficient 0	897	900	i	4	6			
PSU Temperature Conversion Coefficient 1	901	904	i	4	6			
PSU Temperature Conversion Coefficient 2	905	908	i	4	6			
PSU Temperature Conversion Coefficient 3	909	912	i	4	6			
Scan Motor Temperature Conv Coefficient 0	913	916	i	4	6			
Scan Motor Temperature Conv Coefficient 1	917	920	i	4	6			
Scan Motor Temperature Conv Coefficient 2	921	924	i	4	6			
Scan Motor Temperature Conv Coefficient 3	925	928	i	4	6			
Scan Motor Current Conversion Coefficient 0	929	932	i	4	6			
Scan Motor Current Conversion Coefficient 1	933	936	i	4	6			
Scan Motor Current Conversion Coefficient 2	937	940	i	4	6			
Scan Motor Current Conversion Coefficient 3	941	944	i	4	6			
Ch 16 LO Temperature Conversion Coefficient 0	945	948	i	4	6			
Ch 16 LO Temperature Conversion Coefficient 1	949	952	i	4	6			
Ch 16 LO Temperature Conversion Coefficient 2	953	956	i	4	6			
Ch 16 LO Temperature Conversion Coefficient 3	957	960	i	4	6			
Ch 17 LO Temperature Conversion Coefficient 0	961	964	i	4	6			
Ch 17 LO Temperature Conversion Coefficient 1	965	968	i	4	6			
Ch 17 LO Temperature Conversion Coefficient 2	969	972	i	4	6			
Ch 17 LO Temperature Conversion Coefficient 3	973	976	i	4	6			
Ch 18/19/20 LO Temp Conversion Coefficient 0	977	980	i	4	6			
Ch 18/19/20 LO Temp Conversion Coefficient 1	981	984	i	4	6			
Ch 18/19/20 LO Temp Conversion Coefficient 2	985	988	i	4	6			
Ch 18/19/20 LO Temp Conversion Coefficient 3	989	992	i	4	6			
<Zero Fill>	993	1000	i	4	0			
BIAS CORRECTION 1								
Bias Correction Values 2	1001	1840	i	2	0			

(values are given in counts) Ordered by channel, field of view (FOV), and transmitter as follows: Word 1: Channel 16, FOV 1, STX-1 Word 2: Channel 17, FOV 1, STX-1 Word 3: Channel 18, FOV 1, STX-1 Word 4: Channel 19, FOV 1, STX-1 Word 5: Channel 20, FOV 1, STX-1 Word 6: Channel 16, FOV 5, STX-1 ... (channel values for FOVs 5, 10, 15, ... , 90) ... Word 95: Channel 20, FOV 90, STX-1 Word 96: Channel 16, Space View, STX-1 ... Word 100: Channel 20, Space View, STX-1 Word 101: Channel 16, Warm View, STX-1 ... Word 106: Channel 16, FOV 1, STX-2 ... Word 211: Channel 16, FOV 1, STX-3 ... Word 316: Channel 16, FOV 1, SARR ... Word 420: Channel 20, Warm View, SARR								
<Zero Fill>	1841	1848	i	4	0			
TRANSMITTER 1								
Transmitter Reference Power Mean power at the time bias corrections were derived. (values are given in counts from 0 to 255, representing analog voltages from 0 to 5.1) Word 1: STX-1 Word 2: STX-2 Word 3: STX-3 Word 4: SARR	1849	1856	i	2	1			
<Zero Fill>	1857	1864	i	4	0			
“NEW” BIAS CORRECTION 2	1865	1864						
New” Bias Correction Values (values are given in counts) Ordered by channel, field of view (FOV), and cycle within 8 second period as follows: Word 1: Channel 16, FOV 1, Cycle 1 Word 2: Channel 17, FOV 1, Cycle 1 Word 3: Channel 18, FOV 1, Cycle 1 Word 4: Channel 19, FOV 1, Cycle 1 Word 5: Channel 20, FOV 1, Cycle 1 Word 6: Channel 16, FOV 3, Cycle 1	1865	2854	i	2	0			

...								
(channel correction values for FOVs 3, 6, 9, ... , 90)								
...								
Word 155: Channel 20, FOV 90, Cycle 1								
Word 156: Channel 16, Space View, Cycle 1								
...								
Word 160: Channel 20, Space View, Cycle 1								
Word 161: Channel 16, Warm View, Cycle 1								
...								
Word 165: Channel 20, Warm View, Cycle 1								
Word 166: Channel 16, FOV 1, Cycle 2								
...								
Word 330: Channel 20, Warm View, Cycle 2								
Word 331: Channel 16, FOV 1, Cycle 3								
...								
Word 495: Channel 20, Warm View, Cycle 3								
Filler 2								
<Zero Fill>	2855	3072	i	2	0			

8.3.1.7.3.2 Version 4 format, post-January 25, 2006, Applies to only NOAA KLM for AMSU-B

Table 8.3.1.7.3.2-1 NOAA-N Format (Version 4, post-January 25, 2006, NOAA KLM Spacecraft)								
Field Name	Start Octet	End Octet	Data Type	Word Size	Number of Words	Scale Factor	Units	Notes
FILE IDENTIFICATION								
Data Set Creation Site ID CMS=Centre de Meteorologie Spatiale/France DSS=Dundee Satellite Receiving Station/UK NSS=National Environmental Satellite, Data and Information Service/USA UKM=United Kingdom Meteorological Office/UK <ASCII blank = x20>	1	3	c	3	1	0		
Level 1b Format Version Number	4	4	c	1	1	0		
Level 1b Format Version Year (<i>four digits, e.g., 2000</i>)	5	6	u	2	1	0		
Level 1b Format Version Day of Year (<i>e.g., 365</i>)	7	8	u	2	1	0		
<Reserved for Logical Record Length> (<i>For Creation Site use only. Logical Record Length of source 1b data set prior to processing.</i>)	9	10	u	2	1	0	octets	
<Reserved for Block Size> (<i>For Creation Site use only. Block Size of source 1b data set prior to processing.</i>)	11	12	u	2	1	0	octets	
Count of Header Records in this Data Set	13	14	u	2	1	0		
<Zero Fill>	15	16	u	2	1	0		
Data Set Name	17	22	i	2	3	0		
Processing Block Identification	23	64	c	42	1	0		
NOAA Spacecraft Identification Code 2=NOAA-L 4=NOAA-K 6=NOAA-M	65	72	c	8	1	0		
Instrument ID 4=protoflight model (PFM) (NOAA-K) 8=FM 2 (NOAA-L) 12=FM 3 (NOAA-M)	73	74	u	2	1	0		
	75	76	u	2	1	0		

Data Type Code	77	78	u	2	1	0		
11=AMSU-B								
TIP Source Code	79	80	u	2	1	0		
0=unused, i.e., GAC/HRPT/LAC data								
1=GAC-embedded AMSU and TIP								
2=stored TIP (STIP)								
3=HRPT/LAC-embedded AMSU and TIP								
4=stored AIP (SAIP)								
Start of Data Set Day Count starting from 0 at 00h, 1 Jan 1950	81	84	u	4	1	0		
Start of Data Set Year (<i>four digits, e.g., 2000</i>)	85	86	u	2	1	0		
Start of Data Set Day of Year (<i>e.g., 365</i>)	87	88	u	2	1	0		
Start of Data Set UTC Time of Day	89	92	u	4	1	0	millisec	
End of Data Set Day Count starting from 0 at 00h, 1 Jan 1950	93	96	u	4	1	0		
End of Data Set Year (<i>four digits, e.g., 2000</i>)	97	98	u	2	1	0		
End of Data Set Day of Year (<i>e.g., 365</i>)	99	100	u	2	1	0		
End of Data Set UTC Time of Day	101	104	u	4	1	0	millisec	
Year of Last CPIDS Update (<i>four digits, e.g., 2000</i>)	105	106	u	2	1	0		
Day of Year of Last CPIDS Update (<i>e.g., 365</i>)	107	108	u	2	1	0		
Offset between Start of Scan and Center of First FOV	109	110	i	2	1	0	millisec	
<Zero Fill>	111	120	i	2	5	0		
DATA SET QUALITY INDICATORS								
Instrument Status	121	124	u	4	1	0		
bits 31-29: <not defined>								
bit 28: processor check flag (0=passed; 1=failed)								
bit 27: scan control status (0=running; 1=aborted)								
bit 26: pixel data invalid flag (0=valid; 1=invalid)								
bit 25: scan synchronization (0=error < 0.1 deg; 1=error >= 0.1 deg)								
bit 24: mode transition flag (0=transition complete; 1=transition in progress)								
bit 23: module ID, msb								
bits 22 - 17: module ID								
bit 16: module ID, lsb								
bit 15: RAM check flag (0=passed; 1=failed)								
bit 14: ROM check flag (0=passed; 1=failed)								
bit 13: memory checks status (0=disabled; 1=enabled)								
bit 12: space view select, lsb								
bit 11: space view select, msb								
bit 10: channel 18/19/20 (relay 5 status) (0=off; 1=on)								
bit 9: channel 17 (relay 4 status) (0=off; 1=on)								
bit 8: channel 16 (relay 3 status) (0=off; 1=on)								
bit 7: stepped mode (0=no; 1=yes)								
bit 6: investigation mode (0=no; 1=yes)								
bit 5: parked in space view mode (0=no; 1=yes)								
bit 4: parked in nadir view mode (0=no; 1=yes)								
bit 3: parked in target view mode (0=no; 1=yes)								
bit 2: scan normal mode (0=no; 1=yes)								
bit 1: survival heater (relay 2 status) (0=off; 1=on)								
bit 0: power (relay 1 status) (0=off; 1=on)								
<Zero Fill>	125	126	i	2	1	0		
Record Number of Status Change (<i>if 0, none occurred</i>)	127	128	u	2	1	0		
Second Instrument Status (<i>if previous word is 0, no change</i>)	129	132	u	4	1	0		
Count of Data Records in this Data Set	133	134	u	2	1	0		

Count of Calibrated, Earth Located Scan Lines in this Data Set	135	136	u	2	1	0		
Count of Missing Scan Lines	137	138	u	2	1	0		
Count of Data Gaps in this Data Set	139	140	u	2	1	0		
Count of Data Frames Without Frame Sync Word Errors	141	142	u	2	1	0		
Count of PACS Detected TIP Parity Errors	143	144	u	2	1	0		
Sum of All Auxiliary Sync Errors Detected in the Input Data	145	146	u	2	1	0		
Time Sequence Error 0=none; otherwise, the record number of the first occurrence	147	148	u	2	1	0		
Time Sequence Error Code (<i>These are bit flags taken from "Scan Line Quality Flags [Time Problem Code]" on data record reported in "Time Sequence Error" field above. If a bit is on (=1) then the statement is true.</i>) bits 15-8: <zero fill> bit 7: time field is bad but can probably be inferred from the previous good time bit 6: time field is bad and can't be inferred from the previous good time bit 5: this record starts a sequence that is inconsistent with previous times (i.e., there is a time discontinuity); may be associated with a spacecraft clock update bit 4: start of a sequence that apparently repeats scan times that have been previously accepted bits 3-0: <zero fill>	149	150	u	2	1	0		
SOCC Clock Update Indicator 0=none during this orbit; otherwise, the record number of the first occurrence	151	152	u	2	1	0		
Earth Location Error Indicator 0=none during this orbit; otherwise, the record number of the first occurrence	153	154	u	2	1	0		
Earth Location Error Code (<i>These are bit flags taken from "Scan Line Quality Flags [Earth Location Problem Code]" on data record reported in "Earth Location Error Indicator" field above. If a bit is on (=1) then the statement is true.</i>) bits 15-8: <zero fill> bit 7: not earth located because of bad time; earth location fields zero-filled bit 6: earth location questionable: questionable time code bit 5: earth location questionable: marginal agreement with reasonableness check bit 4: earth location questionable: fails reasonableness check bit 3: earth location questionable because of antenna position check bits 2-0: <zero fill>	155	156	u	2	1	0		
PACS Status Bit Field bits 15-3: <zero fill> bit 2: pseudonoise 0=normal data; 1=pseudonoise data bit 1: tape direction (0=reverse playback, time decrementing) bit 0: data mode 0=test data; 1=flight data	157	158	u	2	1	0		

Data Source 0=unused 1=Fairbanks, AK 2=Wallops Is., VA 3=SOCC 4=Svalbard, Norway 5=Monterey, CA	159	160	u	2	1	0		
<Reserved for the Ingester>	161	168	c	8	1	0		
<Reserved for Decommutation>	169	176	c	8	1	0		
<Zero Fill>	177	192	i	4	4	0		
CALIBRATION								
Instrument Temperature Sensor ID 0=mixer temperature of channels 18-20 1=mixer temperature of channel 16	193	194	i	2	1	0		
<Zero Fill>	195	196	i	2	1	0		
Minimum Reference Temperature, mixer of Ch 18 - 20	197	198	i	2	1	2	K	
Nominal Reference Temperature, mixer of Ch 18 - 20	199	200	i	2	1	2	K	
Maximum Reference Temperature, mixer of Ch 18 - 20	201	202	i	2	1	2	K	
Minimum Reference Temperature, mixer of Ch 16	203	204	i	2	1	2	K	
Nominal Reference Temperature, mixer of Ch 16	205	206	i	2	1	2	K	
Maximum Reference Temperature, mixer of Ch 16	207	208	i	2	1	2	K	
Warm Target Fixed Bias Correction Ch 16 Min Temperature	209	210	i	2	1	3	K	
Warm Target Fixed Bias Correction Ch 16 Nominal Temperature	211	212	i	2	1	3	K	
Warm Target Fixed Bias Correction Ch 16 Max Temperature	213	214	i	2	1	3	K	
Space Fixed Bias Correction Ch 16	215	216	i	2	1	3	K	
Warm Target Fixed Bias Correction Ch 17 Min Temperature	217	218	i	2	1	3	K	
Warm Target Fixed Bias Correction Ch 17 Nominal Temperature	219	220	i	2	1	3	K	
Warm Target Fixed Bias Correction Ch 17 Max Temperature	221	222	i	2	1	3	K	
Space Fixed Bias Correction Ch 17	223	224	i	2	1	3	K	
Warm Target Fixed Bias Correction Ch 18 Min Temperature	225	226	i	2	1	3	K	
Warm Target Fixed Bias Correction Ch 18 Nominal Temperature	227	228	i	2	1	3	K	
Warm Target Fixed Bias Correction Ch 18 Max Temperature	229	230	i	2	1	3	K	
Space Fixed Bias Correction Ch 18	231	232	i	2	1	3	K	
Warm Target Fixed Bias Correction Ch 19 Min Temperature	233	234	i	2	1	3	K	
Warm Target Fixed Bias Correction Ch 19 Nominal Temperature	235	236	i	2	1	3	K	
Warm Target Fixed Bias Correction Ch 19 Max Temperature	237	238	i	2	1	3	K	
Space Fixed Bias Correction Ch 19	239	240	i	2	1	3	K	
Warm Target Fixed Bias Correction Ch 20 Min Temperature	241	242	i	2	1	3	K	
Warm Target Fixed Bias Correction Ch 20 Nominal Temperature	243	244	i	2	1	3	K	

Warm Target Fixed Bias Correction Ch 20 Max Temperature	245	246	i	2	1	3	K	
Space Fixed Bias Correction Ch 20	247	248	i	2	1	3	K	
Nonlinearity Coeff. Ch 1 at Reference Temperature 1	249	252	i	4	1	3	$\text{m}^2\text{-sr-cm}^{-1}/\text{mW}$	
Nonlinearity Coeff. Ch 1 at Reference Temperature 2	253	256	i	4	1	3	$\text{m}^2\text{-sr-cm}^{-1}/\text{mW}$	
Nonlinearity Coeff. Ch 1 at Reference Temperature 3	257	260	i	4	1	3	$\text{m}^2\text{-sr-cm}^{-1}/\text{mW}$	
Nonlinearity Coeff. Ch 2 at Reference Temperature 1	261	264	i	4	1	3	$\text{m}^2\text{-sr-cm}^{-1}/\text{mW}$	
Nonlinearity Coeff. Ch 2 at Reference Temperature 2	265	268	i	4	1	3	$\text{m}^2\text{-sr-cm}^{-1}/\text{mW}$	
Nonlinearity Coeff. Ch 2 at Reference Temperature 3	269	272	i	4	1	3	$\text{m}^2\text{-sr-cm}^{-1}/\text{mW}$	
Nonlinearity Coeff. Ch 3 at Reference Temperature 1	273	276	i	4	1	3	$\text{m}^2\text{-sr-cm}^{-1}/\text{mW}$	
Nonlinearity Coeff. Ch 3 at Reference Temperature 2	277	280	i	4	1	3	$\text{m}^2\text{-sr-cm}^{-1}/\text{mW}$	
Nonlinearity Coeff. Ch 3 at Reference Temperature 3	281	284	i	4	1	3	$\text{m}^2\text{-sr-cm}^{-1}/\text{mW}$	
Nonlinearity Coeff. Ch 4 at Reference Temperature 1	285	288	i	4	1	3	$\text{m}^2\text{-sr-cm}^{-1}/\text{mW}$	
Nonlinearity Coeff. Ch 4 at Reference Temperature 2	289	292	i	4	1	3	$\text{m}^2\text{-sr-cm}^{-1}/\text{mW}$	
Nonlinearity Coeff. Ch 4 at Reference Temperature 3	293	296	i	4	1	3	$\text{m}^2\text{-sr-cm}^{-1}/\text{mW}$	
Nonlinearity Coeff. Ch 5 at Reference Temperature 1	297	300	i	4	1	3	$\text{m}^2\text{-sr-cm}^{-1}/\text{mW}$	
Nonlinearity Coeff. Ch 5 at Reference Temperature 2	301	304	i	4	1	3	$\text{m}^2\text{-sr-cm}^{-1}/\text{mW}$	
Nonlinearity Coeff. Ch 5 at Reference Temperature 3	305	308	i	4	1	3	$\text{m}^2\text{-sr-cm}^{-1}/\text{mW}$	
<Zero Fill>	309	324	i	4	4	0		
TEMPERATURE-RADIANCE CONVERSION								
Temperature-radiance Ch 16 Central Wavenumber	325	328	i	4	1	6	cm^{-1}	
Temperature-radiance Ch 16 Constant 1	329	332	i	4	1	6		
Temperature-radiance Ch 16 Constant 2	333	336	i	4	1	6		
Temperature-radiance Ch 17 Central Wavenumber	337	340	i	4	1	6	cm^{-1}	
Temperature-radiance Ch 17 Constant 1	341	344	i	4	1	6		
Temperature-radiance Ch 17 Constant 2	345	348	i	4	1	6		
Temperature-radiance Ch 18 Central Wavenumber	349	352	i	4	1	6	cm^{-1}	
Temperature-radiance Ch 18 Constant 1	353	356	i	4	1	6		
Temperature-radiance Ch 18 Constant 2	357	360	i	4	1	6		
Temperature-radiance Ch 19 Central Wavenumber	361	364	i	4	1	6	cm^{-1}	
Temperature-radiance Ch 19 Constant 1	365	368	i	4	1	6		
Temperature-radiance Ch 19 Constant 2	369	372	i	4	1	6		
Temperature-radiance Ch 20 Central Wavenumber	373	376	i	4	1	6	cm^{-1}	
Temperature-radiance Ch 20 Constant 1	377	380	i	4	1	6		
Temperature-radiance Ch 20 Constant 2	381	384	i	4	1	6		
<Zero Fill>	385	400	i	4	4	0		

NAVIGATION

Reference Ellipsoid Model ID (<i>The ellipsoid is a mathematically tractable approximation of the geoid, which is an equipotential surface at mean sea level. The maximum departure of the ellipsoid from the geoid is approximately +/- 65 meters.</i>) WGS-72=World Geodetic Survey 1972	401	408	c	8	1	0		
Nadir Earth Location Tolerance	409	410	u	2	1	1	km	
Earth Location Bit Field bits 15-3: <zero fill> bit 2: dynamic attitude error correction 0=not performed; 1=performed bit 1: reasonableness test 0=inactive; 1=active bit 0: constant attitude error correction 0=not performed; 1=performed <Zero Fill>	411	412	u	2	1	0		
	413	414	i	2	1	0		
Constant Roll Attitude Error	415	416	i	2	1	3	degrees	
Constant Pitch Attitude Error	417	418	i	2	1	3	degrees	
Constant Yaw Attitude Error	419	420	i	2	1	3	degrees	
Epoch Year for Orbit Vector	421	422	u	2	1	0		
Day of Epoch Year for Orbit Vector	423	424	u	2	1	0		
Epoch UTC Time of Day for Orbit Vector	425	428	u	4	1	0	millisec	
Semi-major Axis (<i>at the orbit vector epoch time</i>)	429	432	i	4	1	5	km	
Eccentricity (<i>at the orbit vector epoch time</i>)	433	436	i	4	1	8		
Inclination (<i>at the orbit vector epoch time</i>)	437	440	i	4	1	5	degrees	
Argument of Perigee (<i>at the orbit vector epoch time</i>)	441	444	i	4	1	5	degrees	
Right Ascension of the Ascending Node (<i>at the orbit vector epoch time</i>)	445	448	i	4	1	5	degrees	
Mean Anomaly (<i>at the orbit vector epoch time</i>)	449	452	i	4	1	5	degrees	
Position Vector X Component (<i>at the orbit vector epoch time</i>)	453	456	i	4	1	5	km	
Position Vector Y Component (<i>at the orbit vector epoch time</i>)	457	460	i	4	1	5	km	
Position Vector Z Component (<i>at the orbit vector epoch time</i>)	461	464	i	4	1	5	km	
Velocity Vector X-dot Component (<i>at the orbit vector epoch time</i>)	465	468	i	4	1	8	km/sec	
Velocity Vector Y-dot Component (<i>at the orbit vector epoch time</i>)	469	472	i	4	1	8	km/sec	
Velocity Vector Z-dot Component (<i>at the orbit vector epoch time</i>)	473	476	i	4	1	8	km/sec	
Earth/Sun Distance Ratio (<i>at the orbit vector epoch time; relative to the mean distance of 1 AU</i>) <Zero Fill>	477	480	u	4	1	6		
	481	496	i	4	4	0		
DIGITAL A TELEMETRY CONVERSION								
Mixer 16 Temperature Coefficient 0	497	498	i	2	1	2	K	
Mixer 16 Temperature Coefficient 1	499	500	i	2	1	7	K/count	

Mixer 16 Temperature Coefficient 2	501	502	i	2	1	12	K/count ²
Mixer 16 Temperature Coefficient 3	503	504	i	2	1	18	K/count ³
Mixer 17 Temperature Coefficient 0	505	506	i	2	1	2	K
Mixer 17 Temperature Coefficient 1	507	508	i	2	1	7	K/count
Mixer 17 Temperature Coefficient 2	509	510	i	2	1	12	K/count ²
Mixer 17 Temperature Coefficient 3	511	512	i	2	1	18	K/count ³
Mixer 18, 19, & 20 Temperature Coefficient 0	513	514	i	2	1	2	K
Mixer 18, 19, & 20 Temperature Coefficient 1	515	516	i	2	1	7	K/count
Mixer 18, 19, & 20 Temperature Coefficient 2	517	518	i	2	1	12	K/count ²
Mixer 18, 19, & 20 Temperature Coefficient 3	519	520	i	2	1	18	K/count ³
FET Amplifier 16 Temperature Coefficient 0	521	522	i	2	1	2	K
FET Amplifier 16 Temperature Coefficient 1	523	524	i	2	1	7	K/count
FET Amplifier 16 Temperature Coefficient 2	525	526	i	2	1	12	K/count ²
FET Amplifier 16 Temperature Coefficient 3	527	528	i	2	1	18	K/count ³
FET Amplifier 17 Temperature Coefficient 0	529	530	i	2	1	2	K
FET Amplifier 17 Temperature Coefficient 1	531	532	i	2	1	7	K/count
FET Amplifier 17 Temperature Coefficient 2	533	534	i	2	1	12	K/count ²
FET Amplifier 17 Temperature Coefficient 3	535	536	i	2	1	18	K/count ³
FET Amplifier 18 Temperature Coefficient 0	537	538	i	2	1	2	K
FET Amplifier 18 Temperature Coefficient 1	539	540	i	2	1	7	K/count
FET Amplifier 18 Temperature Coefficient 2	541	542	i	2	1	12	K/count ²
FET Amplifier 18 Temperature Coefficient 3	543	544	i	2	1	18	K/count ³
FET Amplifier 19 Temperature Coefficient 0	545	546	i	2	1	2	K
FET Amplifier 19 Temperature Coefficient 1	547	548	i	2	1	7	K/count
FET Amplifier 19 Temperature Coefficient 2	549	550	i	2	1	12	K/count ²
FET Amplifier 19 Temperature Coefficient 3	551	552	i	2	1	18	K/count ³
FET Amplifier 20 Temperature Coefficient 0	553	554	i	2	1	2	K
FET Amplifier 20 Temperature Coefficient 1	555	556	i	2	1	7	K/count
FET Amplifier 20 Temperature Coefficient 2	557	558	i	2	1	12	K/count ²
FET Amplifier 20 Temperature Coefficient 3	559	560	i	2	1	18	K/count ³
Calibration Target Temperature 1 Coefficient 0	561	562	i	2	1	2	K
Calibration Target Temperature 1 Coefficient 1	563	564	i	2	1	7	K/count
Calibration Target Temperature 1 Coefficient 2	565	566	i	2	1	12	K/count ²
Calibration Target Temperature 1 Coefficient 3	567	568	i	2	1	18	K/count ³
Calibration Target Temperature 2 Coefficient 0	569	570	i	2	1	2	K
Calibration Target Temperature 2 Coefficient 1	571	572	i	2	1	7	K/count
Calibration Target Temperature 2 Coefficient 2	573	574	i	2	1	12	K/count ²
Calibration Target Temperature 2 Coefficient 3	575	576	i	2	1	18	K/count ³
Calibration Target Temperature 3 Coefficient 0	577	578	i	2	1	2	K
Calibration Target Temperature 3 Coefficient 1	579	580	i	2	1	7	K/count
Calibration Target Temperature 3 Coefficient 2	581	582	i	2	1	12	K/count ²
Calibration Target Temperature 3 Coefficient 3	583	584	i	2	1	18	K/count ³
Calibration Target Temperature 4 Coefficient 0	585	586	i	2	1	2	K
Calibration Target Temperature 4 Coefficient 1	587	588	i	2	1	7	K/count
Calibration Target Temperature 4 Coefficient 2	589	590	i	2	1	12	K/count ²
Calibration Target Temperature 4 Coefficient 3	591	592	i	2	1	18	K/count ³
Calibration Target Temperature 5 Coefficient 0	593	594	i	2	1	2	K
Calibration Target Temperature 5 Coefficient 1	595	596	i	2	1	7	K/count
Calibration Target Temperature 5 Coefficient 2	597	598	i	2	1	12	K/count ²
Calibration Target Temperature 5 Coefficient 3	599	600	i	2	1	18	K/count ³

Calibration Target Temperature 6 Coefficient 0	601	602	i	2	1	2	K
Calibration Target Temperature 6 Coefficient 1	603	604	i	2	1	7	K/count
Calibration Target Temperature 6 Coefficient 2	605	606	i	2	1	12	K/count ²
Calibration Target Temperature 6 Coefficient 3	607	608	i	2	1	18	K/count ³
Calibration Target Temperature 7 Coefficient 0	609	610	i	2	1	2	K
Calibration Target Temperature 7 Coefficient 1	611	612	i	2	1	7	K/count
Calibration Target Temperature 7 Coefficient 2	613	614	i	2	1	12	K/count ²
Calibration Target Temperature 7 Coefficient 3	615	616	i	2	1	18	K/count ³
Sub-reflector Temperature 1 Coefficient 0	617	618	i	2	1	2	K
Sub-reflector Temperature 1 Coefficient 1	619	620	i	2	1	7	K/count
Sub-reflector Temperature 1 Coefficient 2	621	622	i	2	1	12	K/count ²
Sub-reflector Temperature 1 Coefficient 3	623	624	i	2	1	18	K/count ³
LO Monitor Current Ch 16 Coefficient 0	625	626	i	2	1	3	mA
LO Monitor Current Ch 16 Coefficient 1	627	628	i	2	1	5	mA/count
LO Monitor Current Ch 16 Coefficient 2	629	630	i	2	1	0	mA/count ²
LO Monitor Current Ch 16 Coefficient 3	631	632	i	2	1	0	mA/count ³
LO Monitor Current Ch 17 Coefficient 0	633	634	i	2	1	3	mA
LO Monitor Current Ch 17 Coefficient 1	635	636	i	2	1	5	mA/count
LO Monitor Current Ch 17 Coefficient 2	637	638	i	2	1	0	mA/count ²
LO Monitor Current Ch 17 Coefficient 3	639	640	i	2	1	0	mA/count ³
LO Monitor Current Ch 18, 19, & 20 Coefficient 0	641	642	i	2	1	3	mA
LO Monitor Current Ch 18, 19, & 20 Coefficient 1	643	644	i	2	1	5	mA/count
LO Monitor Current Ch 18, 19, & 20 Coefficient 2	645	646	i	2	1	0	mA/count ²
LO Monitor Current Ch 18, 19, & 20 Coefficient 3	647	648	i	2	1	0	mA/count ³
LO Ch 16 Temperature Coefficient 0	649	650	i	2	1	2	K
LO Ch 16 Temperature Coefficient 1	651	652	i	2	1	7	K/count
LO Ch 16 Temperature Coefficient 2	653	654	i	2	1	12	K/count ²
LO Ch 16 Temperature Coefficient 3	655	656	i	2	1	18	K/count ³
LO Ch 17 Temperature Coefficient 0	657	658	i	2	1	2	K
LO Ch 17 Temperature Coefficient 1	659	660	i	2	1	7	K/count
LO Ch 17 Temperature Coefficient 2	661	662	i	2	1	12	K/count ²
LO Ch 17 Temperature Coefficient 3	663	664	i	2	1	18	K/count ³
LO Ch 18, 19, & 20 Temperature Coefficient 0	665	666	i	2	1	2	K
LO Ch 18, 19, & 20 Temperature Coefficient 1	667	668	i	2	1	7	K/count
LO Ch 18, 19, & 20 Temperature Coefficient 2	669	670	i	2	1	12	K/count ²
LO Ch 18, 19, & 20 Temperature Coefficient 3	671	672	i	2	1	18	K/count ³
PRT Bridge Voltage Coefficient 0	673	674	i	2	1	0	V
PRT Bridge Voltage Coefficient 1	675	676	i	2	1	5	V/count
PRT Bridge Voltage Coefficient 2	677	678	i	2	1	0	V/count ²
PRT Bridge Voltage Coefficient 3	679	680	i	2	1	0	V/count ³
PRT Board Temperature Coefficient 0	681	682	i	2	1	1	K
PRT Board Temperature Coefficient 1	683	684	i	2	1	6	K/count
PRT Board Temperature Coefficient 2	685	686	i	2	1	10	K/count ²
PRT Board Temperature Coefficient 3	687	688	i	2	1	15	K/count ³
<Zero Fill>	689	704	i	4	4	0	
ANALOG TELEMETRY CONVERSION							
+12V (A) Secondary Conversion Coefficient 0	705	708	i	4	1	6	V
+12V (A) Secondary Conversion Coefficient 1	709	712	i	4	1	6	V/count
+12V (A) Secondary Conversion Coefficient 2	713	716	i	4	1	6	V/count ²
+12V (A) Secondary Conversion Coefficient 3	717	720	i	4	1	6	V/count ³

-12V (A) Secondary Conversion Coefficient 0	721	724	i	4	1	6	V
-12V (A) Secondary Conversion Coefficient 1	725	728	i	4	1	6	V/count
-12V (A) Secondary Conversion Coefficient 2	729	732	i	4	1	6	V/count ²
-12V (A) Secondary Conversion Coefficient 3	733	736	i	4	1	6	V/count ³
+15V (A) Secondary Conversion Coefficient 0	737	740	i	4	1	6	V
+15V (A) Secondary Conversion Coefficient 1	741	744	i	4	1	6	V/count
+15V (A) Secondary Conversion Coefficient 2	745	748	i	4	1	6	V/count ²
+15V (A) Secondary Conversion Coefficient 3	749	752	i	4	1	6	V/count ³
-15V (A) Secondary Conversion Coefficient 0	753	756	i	4	1	6	V
-15V (A) Secondary Conversion Coefficient 1	757	760	i	4	1	6	V/count
-15V (A) Secondary Conversion Coefficient 2	761	764	i	4	1	6	V/count ²
-15V (A) Secondary Conversion Coefficient 3	765	768	i	4	1	6	V/count ³
+8v (A) Secondary Conversion Coefficient 0	769	772	i	4	1	6	V
+8v (A) Secondary Conversion Coefficient 1	773	776	i	4	1	6	V/count
+8v (A) Secondary Conversion Coefficient 2	777	780	i	4	1	6	V/count ²
+8v (A) Secondary Conversion Coefficient 3	781	784	i	4	1	6	V/count ³
+5V (D) Secondary Conversion Coefficient 0	785	788	i	4	1	6	V
+5V (D) Secondary Conversion Coefficient 1	789	792	i	4	1	6	V/count
+5V (D) Secondary Conversion Coefficient 2	793	796	i	4	1	6	V/count ²
+5V (D) Secondary Conversion Coefficient 3	797	800	i	4	1	6	V/count ³
+5V (A) Secondary Conversion Coefficient 0	801	804	i	4	1	6	V
+5V (A) Secondary Conversion Coefficient 1	805	808	i	4	1	6	V/count
+5V (A) Secondary Conversion Coefficient 2	809	812	i	4	1	6	V/count ²
+5V (A) Secondary Conversion Coefficient 3	813	816	i	4	1	6	V/count ³
-5V (A) Secondary Conversion Coefficient 0	817	820	i	4	1	6	V
-5V (A) Secondary Conversion Coefficient 1	821	824	i	4	1	6	V/count
-5V (A) Secondary Conversion Coefficient 2	825	828	i	4	1	6	V/count ²
-5V (A) Secondary Conversion Coefficient 3	829	832	i	4	1	6	V/count ³
+5V Reference Secondary Conv Coefficient 0	833	836	i	4	1	6	V
+5V Reference Secondary Conv Coefficient 1	837	840	i	4	1	6	V/count
+5V Reference Secondary Conv Coefficient 2	841	844	i	4	1	6	V/count ²
+5V Reference Secondary Conv Coefficient 3	845	848	i	4	1	6	V/count ³
ICE Temperature Conversion Coefficient 0	849	852	i	4	1	6	K
ICE Temperature Conversion Coefficient 1	853	856	i	4	1	6	K/count
ICE Temperature Conversion Coefficient 2	857	860	i	4	1	6	K/count ²
ICE Temperature Conversion Coefficient 3	861	864	i	4	1	6	K/count ³
MDE Temperature Conversion Coefficient 0	865	868	i	4	1	6	K
MDE Temperature Conversion Coefficient 1	869	872	i	4	1	6	K/count
MDE Temperature Conversion Coefficient 2	873	876	i	4	1	6	K/count ²
MDE Temperature Conversion Coefficient 3	877	880	i	4	1	6	K/count ³
PEU Temperature Conversion Coefficient 0	881	884	i	4	1	6	K
PEU Temperature Conversion Coefficient 1	885	888	i	4	1	6	K/count
PEU Temperature Conversion Coefficient 2	889	892	i	4	1	6	K/count ²
PEU Temperature Conversion Coefficient 3	893	896	i	4	1	6	K/count ³
PSU Temperature Conversion Coefficient 0	897	900	i	4	1	6	K
PSU Temperature Conversion Coefficient 1	901	904	i	4	1	6	K/count
PSU Temperature Conversion Coefficient 2	905	908	i	4	1	6	K/count ²
PSU Temperature Conversion Coefficient 3	909	912	i	4	1	6	K/count ³
Scan Motor Temperature Conv Coefficient 0	913	916	i	4	1	6	K
Scan Motor Temperature Conv Coefficient 1	917	920	i	4	1	6	K/count

Scan Motor Temperature Conv Coefficient 2	921	924	i	4	1	6	K/count ²	
Scan Motor Temperature Conv Coefficient 3	925	928	i	4	1	6	K/count ³	
Scan Motor Current Conversion Coefficient 0	929	932	i	4	1	6	A	
Scan Motor Current Conversion Coefficient 1	933	936	i	4	1	6	A/count	
Scan Motor Current Conversion Coefficient 2	937	940	i	4	1	6	A/count ²	
Scan Motor Current Conversion Coefficient 3	941	944	i	4	1	6	A/count ³	
Ch 16 LO Temperature Conversion Coefficient 0	945	948	i	4	1	6	K	
Ch 16 LO Temperature Conversion Coefficient 1	949	952	i	4	1	6	K/count	
Ch 16 LO Temperature Conversion Coefficient 2	953	956	i	4	1	6	K/count ²	
Ch 16 LO Temperature Conversion Coefficient 3	957	960	i	4	1	6	K/count ³	
Ch 17 LO Temperature Conversion Coefficient 0	961	964	i	4	1	6	K	
Ch 17 LO Temperature Conversion Coefficient 1	965	968	i	4	1	6	K/count	
Ch 17 LO Temperature Conversion Coefficient 2	969	972	i	4	1	6	K/count ²	
Ch 17 LO Temperature Conversion Coefficient 3	973	976	i	4	1	6	K/count ³	
Ch 18/19/20 LO Temp Conversion Coefficient 0	977	980	i	4	1	6	K	
Ch 18/19/20 LO Temp Conversion Coefficient 1	981	984	i	4	1	6	K/count	
Ch 18/19/20 LO Temp Conversion Coefficient 2	985	988	i	4	1	6	K/count ²	
Ch 18/19/20 LO Temp Conversion Coefficient 3	989	992	i	4	1	6	K/count ³	
<Zero Fill>	993	1000	i	4	2	0		
BIAS CORRECTION								
Bias Correction Values (<i>ordered by channel, field of view (FOV), and transmitter</i>)	1001	1840	i	2	420	0	counts	
Word 1: Channel 16, FOV 1, STX-1								
Word 2: Channel 17, FOV 1, STX-1								
Word 3: Channel 18, FOV 1, STX-1								
Word 4: Channel 19, FOV 1, STX-1								
Word 5: Channel 20, FOV 1, STX-1								
Word 6: Channel 16, FOV 5, STX-1								
...								
(channel values for FOVs 5, 10, 15, ... , 90)								
...								
Word 95: Channel 20, FOV 90, STX-1								
Word 96: Channel 16, space view, STX-1								
...								
Word 100: Channel 20, space view, STX-1								
Word 101: Channel 16, warm view, STX-1								
...								
Word 106: Channel 16, FOV 1, STX-2								
...								
Word 211: Channel 16, FOV 1, STX-3								
...								
Word 316: Channel 16, FOV 1, SARR								
...								
Word 420: Channel 20, warm view, SARR								
<Zero Fill>	1841	1848	i	4	2	0		
TRANSMITTER								
Transmitter Reference Power (<i>Mean power at the time bias corrections were derived. Range: 0 to 255, representing analog voltages from 0 to 5.1.</i>)	1849	1856	i	2	4	1	counts	
Word 1: STX-1								
Word 2: STX-2								
Word 3: STX-3								
Word 4: SARR								
<Zero Fill>	1857	1864	i	4	2	0		
"NEW" BIAS CORRECTION								

"New" Bias Correction Values (<i>ordered by channel, field of view (FOV), and cycle within 8 second period</i>) Word 1: Channel 16, FOV 1, cycle 1 Word 2: Channel 17, FOV 1, cycle 1 Word 3: Channel 18, FOV 1, cycle 1 Word 4: Channel 19, FOV 1, cycle 1 Word 5: Channel 20, FOV 1, cycle 1 Word 6: Channel 16, FOV 3, cycle 1 ... (channel correction values for FOVs 3, 6, 9, ... , 90) ... Word 155: Channel 20, FOV 90, cycle ... Word 156: Channel 16, space view, cycle 1 ... Word 160: Channel 20, space view, cycle 1 Word 161: Channel 16, warm view, cycle 1 ... Word 165: Channel 20, warm view, cycle 1 Word 166: Channel 16, FOV 1, cycle 2 ... Word 330: Channel 20, warm view, cycle 2 Word 331: Channel 16, FOV 1, cycle 3 ... Word 495: Channel 20, warm view, cycle 3	1865	2854	i	2	495	0	counts	
LUNAR CONTAMINATION								
Count of Scans Containing Lunar-Contaminated Space Views (<i>Also, see bits 7 and 6 of "Scan Line Quality Flags [Additional Calibration Problem Code]" field in data record.</i>) -1=the detection algorithm for lunar contamination is turned off 0=the detection algorithm is turned on: no scans containing lunar-contaminated space views were found >0=the detection algorithm is turned on: the value in this field represents the number of scans found that contain lunar-contaminated space views	2855	2856	i	2	1	0		
Lunar Angle Threshold (<i>Any space view whose lunar angle--see "Lunar Angles" field in data record--is less than this value is flagged as being "lunar contaminated" and is not used in the calibration.</i>)	2857	2858	u	2	1	2	degrees	
FILLER								
<Zero Fill>	2859	3072	i	2	107	0		

8.3.1.8 SEM-2 Data Sets

This section describes the data characteristics and data format of Space Environment Monitor (SEM/2) data. The data stream is processed by NESDIS into NOAA Level 1b format and delivered electronically to NOAA's Space Environment Center (SEC) in Boulder, Colorado. SEC reformats the data and is responsible for archiving and distributing the data. As such, the NOAA Level 1b format described in this section is ephemeral and should not be used for data retrieved from the SEC archive.

8.3.1.8.1 Data Characteristics

NESDIS extracts SEM-2 Minor Frame data from words 20 and 21 of the TIP Minor Frame telemetry at a rate of twenty 8-bit words per second. The characteristics of the SEM-2 instrument are summarized in Table 1.2.2.4-1.

8.3.1.8.2 Header Records

The SEM-2 Data Set Header Record format is documented in Table 8.3.1.8.2-1. See the legend in Section 8.3.1.1 for further explanation of the headings on this table.

Table 8.3.1.8.2-1. Format of SEM-2 Data Set Header Record.							
GENERAL INFORMATION	Start Octet	End Octet	D T	Word Size	Number of Words	S F	Notes
Data Set Creation Site ID CMS = Centre de Meteorologie Spatiale/France; DSS = Dundee Satellite Receiving Station/UK; NSS = National Environmental Satellite, Data and Information Service/USA; UKM = United Kingdom Meteorological Office/UK)	1	3	c	3	1	0	
<ASCII blank = x20>	4	4	c	1	1	0	
NOAA Level 1b Format Version Number 1=TIROS-N, NOAA-6 through NOAA-14; 2=NOAA-15, -16, -17 (pre-April 28, 2005); 3=all satellites post-April 28, 2005 4=cloud mask flag (CLAVR-x)-Jan 25, 2006	5	6	u	2	1	0	
NOAA Level 1b Format Version Year (e.g., 1999)	7	8	u	2	1	0	
NOAA Level 1b Format Version Day of Year (e.g., 365)	9	10	u	2	1	0	
<Reserved for Logical Record Length> For Creation Site use only. Logical Record Length of NOAA Level 1b data set prior to processing.	11	12	u	2	1	0	
<Reserved for Block Size> For Creation Site use only. Block Size of NOAA Level 1b data set prior to processing.	13	14	u	2	1	0	
Count of Header Records in this Data Set	15	16	u	2	1	0	
<zero fill>	17	18	i	2	1	0	
Data Set Name	19	60	c	42	1	0	
Processing Block Identification	61	68	c	8	1	0	

NOAA Spacecraft Identification Code 2=NOAA-15 4=NOAA-16 6=NOAA-17 7=NOAA-18 8=NOAA-N' 11=MetOp-1 12=MetOp-A	69	70	u	2	1	0	
Instrument ID <Undefined> The SEM Instrument ID is not included in telemetry, so this field is undefined. PFM (Prototype Flight Model) is on NOAA-15, FM1 is on NOAA-16, and FM2 is on NOAA-17.	71	72	u	2	1	0	
Data Type Code 9 = SEM	73	74	u	2	1	0	
TIP Source Code (normally 000) 0 = unused, GAC/HRPT/LAC data; 1 = GAC embedded AMSU and TIP; 2 = stored TIP; 3 = HRPT/LAC embedded AMSU and TIP; 4 = stored AIP)	75	76	u	2	1	0	
Start of Data Set Day Count starting from 0 at 00h, 1 Jan 1950	77	80	u	4	1	0	
Start of Data Set Year (4 digit year)	81	82	u	2	1	0	
Start of Data Set Day of Year (3 digit day)	83	84	u	2	1	0	
Start of Data Set UTC Time of Day in Milliseconds	85	88	u	4	1	0	
End of Data Set Day Count starting from 0 at 00h, 1 Jan 1950	89	92	u	4	1	0	
End of Data Set Year (4 digit year)	93	94	u	2	1	0	
End of Data Set Day of Year (3 digit day)	95	96	u	2	1	0	
End of Data Set UTC Time of Day in Milliseconds	97	100	u	4	1	0	
Year of Last CPIDS Update (4 digit year)	101	102	u	2	1	0	1
Day of Year of Last CPIDS Update (3 digit day)	103	104	u	2	1	0	1
<zero fill>	105	112	i	4	2	0	
DATA SET QUALITY INDICATORS							
Instrument Status (contents of TIP word 8, status 1 and status 2 at the beginning time of the data set) bytes 113 and 114:<zero fill> bit 8, MSB of byte 115: Microprocessor System ID bit 7: TED IFC flag bit 6: MEPED IFC flag bit 5: MSB of the TED electron pulse discriminator level setting bit 4: LSB of the TED electron pulse discriminator level setting	113	116	u	4	1	0	

bits 3-2: <zero fill> bit 1, LSB of byte 115: <zero fill> bit 8, MSB of byte 116: Microprocessor A Watch Dog error bit 7: Microprocessor B Watch Dog error bit 6: MSB of the TED proton pulse discriminator level setting bit 5: LSB of the TED proton pulse discriminator level setting bits 4-1: <zero fill>							
<zero fill>	117	118	i	2	1	0	
Record Number of Status Change in TIP word 8 (if 0, none occurred)	119	120	u	2	1	0	2
TIP word 8, status 1 and status 2 after a Status change	121	124	u	4	1	0	2
Count of 2-second Data Records in this Data Set	125	126	u	2	1	0	3
Count of Data Gaps in this Data Set	127	128	u	2	1	0	
Count of TIP Minor Frames Without Frame Sync Word Errors	129	130	u	2	1	0	3
Count of PACS Detected TIP Parity Errors	131	132	u	2	1	0	
Sum of All Sync Errors Detected in the Input Data	133	134	u	2	1	0	
Time Sequence Error (0 = no time error; otherwise the record number of the first occurrence of an error)	135	136	u	2	1	0	
Time Sequence Error Code These are bit flags taken from Scan Line Quality Flags Time Problem Code on data record reported in Time Sequence Error field above. If a bit is on (=1) then the statement is true. byte 137: <zero fill> bit 8: MSB of byte 138: time field is bad but can probably be inferred from the previous good time. bit 7: time field is bad and cannot be inferred from the previous good time. bit 6: this record starts a sequence that is inconsistent with previous times (i.e., there is a time discontinuity). This may or may not be associated with a spacecraft clock update. bit 5: start of a sequence that apparently repeats scan times that have been previously accepted. bits 4-1: <zero fill>	137	138	u	2	1	0	
SOCC Clock Update Indicator (0 = no clock update during this orbit; otherwise the record number of the first occurrence. Typically, there is a spacecraft clock update of a few milliseconds each day.)	139	140	u	2	1	0	

Earth Location Error Indicator (0 = none during this orbit; otherwise the record number of the first occurrence)	141	142	u	2	1	0	
Earth Location Error Code (If there is an earth location error, the following provides details of that error. If a bit is on (=1) then the statement is true.) byte 143: <zero fill> bit 8: MSB of byte 144: not earth located because of bad time; earth location fields zero filled. bit 7: earth location questionable because of questionable time code. (See time problem flags.) bit 6: earth location questionable -- only marginal agreement with reasonableness check. bit 5: earth location questionable -- fails reasonableness check. bits 4-1: <zero fill>	143	144	u	2	1	0	
PACS Status Bit Field (These bytes are not used in SEM data processing.) byte 145: <zero fill> bit 8: MSB of byte 146: <zero fill> bits 7-4: <zero fill> bit 3: 0 if data is pseudo noise bit 2: tape direction (0 = reverse playback, 1=forward) bit 1: LSB of byte 146: data mode (0 = test data; 1 = flight data; normally, the value of byte 146 is decimal 3, bits 1 and 2 set to 1.)	145	146	u	2	1	0	
PACS Data Source 0 = unused; 1 = Fairbanks, AK; 2 = Wallops Island, VA; 3 = SOCC 4 = Svalbard, Norway 5 = Monterey, CA	147	148	u	2	1	0	
<zero fill>	149	176	i	28	1	0	
NAVIGATION							
Reference Ellipsoid Model ID (The ellipsoid is a mathematically tractable approximation of the geoid, which is an equipotential surface at mean sea level. The maximum departure of the ellipsoid from the geoid is approximately ± 65 meters. In ASCII.) WGS-72 = World Geodetic Survey 1972 JGM3 =Joint Gravity Model 3	177	184	c	8	1	0	
Nadir Earth Location Tolerance in Kilometers	185	186	u	2	1	1	4
Earth Location Bit Field bits 15 - 2: <zero fill> bit 1: reasonableness test active (0 = inactive) bit 0: attitude error correction (0 = not corrected)	187	188	u	2	1	0	

<zero fill>	189	190	i	2	1	0	
Constant Roll Attitude Error in Degrees	191	192	i	2	1	3	
Constant Pitch Attitude Error in Degrees	193	194	i	2	1	3	
Constant Yaw Attitude Error in Degrees	195	196	i	2	1	3	
Epoch Year for Orbit Vector (4 digit year)	197	198	u	2	1	0	
Day of Epoch Year for Orbit Vector (3 digit day)	199	200	u	2	1	0	
Epoch UTC Time of Day in Milliseconds for Orbit Vector	201	204	u	4	1	0	
Semi-major Axis in Kilometers	205	208	i	4	1	5	
Orbit eccentricity	209	212	i	4	1	8	5
Orbit Inclination in Degrees (This is used in SEM data processing.)	213	216	i	4	1	5	
Argument of Perigee in Degrees	217	220	i	4	1	5	
Right Ascension of the Ascending Node in Degrees	221	224	i	4	1	5	
Mean Anomaly in Degrees	225	228	i	4	1	5	
Satellite location, x coordinate in Kilometers	229	232	i	4	1	5	6
Satellite location, y coordinate in Kilometers	233	236	i	4	1	5	6
Satellite location, z coordinate in Kilometers	237	240	i	4	1	5	6
Satellite Velocity Vector x Component in Kilometers/second	241	244	i	4	1	8	7
Satellite Velocity Vector y Component in Kilometers/second	245	248	i	4	1	8	7
Satellite Velocity Vector z Component in Kilometers/second	249	252	i	4	1	8	7
Earth/Sun Distance Ratio	253	256	u	4	1	6	
<zero fill>	257	272	i	4	4	0	
ANALOG TELEMETRY CONVERSION							
<Reserved> (<Zero fill> at this time)	273	492	i	2	110	0	
FILLER							
<Reserved>	493	512	i	4	5	0	
NOTES:							
1. CPIDS refers to a comprehensive calibration data set and these bytes provide the year and day of year of the latest data set update.							
2. If the contents of status1 or status2 change during the course of this data set, bytes 119-120 contain the data record number of that change. Bytes 121-124 contain the contents of status1 and status2 after that change with the bit assignments in bytes 113-116. Normally a change in the contents of status1 and status2 is associated with an in-flight calibration.							
3. Bytes 125-126 contain the number of 2-second SEM data records in this incremental file. Bytes 129-130 contain the number of TIP minor frames within this incremental file that did not have sync errors. If there were no sync error records, the integer number in bytes 129-130 should be exactly 20 times the integer number in bytes 125-126 because there are 20 TIP minor frames in each 2-second data record. If sync errors are present, the value of bytes 129-130 will be less than 20 times the integer value of bytes 125-126.							
4. This is not used in SEM processing.							
5. A survey of header files shows the eccentricity (and the semi-major axis) varies a great deal day to day. The orbit eccentricity given in the 2-line NORAD orbit elements obtained from http://celestrak.com/NORAD/elements/noaa.txt do not show nearly that variation and the NORAD eccentricities generally do not agree with those obtained from this header record. There is no explanation for this.							
6. These values are in earth-centered inertial coordinates. That is, the Z axis directed north parallel to earth's axis of rotation, X axis directed toward the vernal equinox, and the Y axis completing the right handed Cartesian coordinate system.							

7. The coordinate system is earth-centered inertial.

8.3.1.8.3 Data Records

A sequence of SEM data records follow the header record in an incremental file. Usually an incremental file contains about one orbit's data or about 6000 seconds. A single physical 512 byte data record in the file contains two seconds of data so that each incremental file contains about 3000 physical data records. Each two second data record contains 20 TIP minor frames of data, parsed so that the first minor frame is always mod 020. That is, the first TIP minor frame in each data record is either 000, 020, 040, 060, 080, 100, 120, 140, 160, 180, 200, 220, 240, 260, 280 or 300. Table 8.3.1.8.3-1 contains a byte-by-byte description of the contents of an incremental file data record. The SEM-2 Data Record format is documented in Table 8.3.1.8.3-1. See the legend in Section 8.3.1.1 for further explanation of the headings on this table.

Table 8.3.1.8.3-1. Format of SEM-2 Data Record.							
FRAME INFORMATION	Start Octet	End Octet	D T	Word Size	Number of Words	SF	Notes
TIP Major Frame number (0 to 7)	1	2	u	2	1	0	
TIP Minor Frame Number (cyclic: 0, 20,...,280,300; at start of this 2-second data record)	3	4	u	2	1	0	
Minor Frame Year (at start of this 2-second data record)	5	6	u	2	1	0	
Minor Frame Day of Year (at start of this 2-second data record)	7	8	u	2	1	0	
<zero fill>	9	10	i	2	1	0	
Satellite Clock Drift Delta (relative to UTC; nominally near zero)	11	12	i	2	1	0	
Minor Frame UTC Time of Day in milliseconds	13	16	u	4	1	0	
Satellite Travel Direction indicator (required for calculation of sensor look angles with respect to the geomagnetic field) 0 = northbound data; 1 = southbound data	17	18	u	2	1	0	1
<zero fill>	19	28	i	2	5	0	
QUALITY INDICATORS							
Quality Indicator Flags (These bytes indicate various timing and earth location problems according to the following bit assignments. If a bit is on (=1) then the statement is true.) bit 8 (MSB of byte 29): this 2-second frame is not valid bit 7: time sequence error in this 2-second frame bit 6: data gap precedes this 2-second frame bit 5: <Zero fill> bit 4: earth location data not available (bytes	29	32	u	4	1	0	

65-72 set to zero) bit 3: first good time following a spacecraft clock update bit 2: SEM instrument status changed beginning with this frame bit 1 (LSB of byte 29): <zero fill> bytes 30-32: <zero fill>							
Time Quality and Satellite Location Quality Flags (If a bit is on (=1) then the statement is true. These bytes provide details of the problems flagged in bytes 29-32.) Time Problem Code byte 33: <zero fill> bit 8, MSB of byte 34: time is bad but can probably be inferred from the previous good time. bit 7: time is bad and cannot be inferred from the previous good time. bit 6: there is a time discontinuity, including a spacecraft clock update. bit 5: this time starts a sequence that duplicates previous times bits 4-1: <zero fill> byte 35: <zero fill> bit 8, MSB of byte 36: No earth location because of bad time; bytes 65-72: <zero fill> bit 7: Earth location questionable because of questionable time code. bit 6: Earth location questionable - marginal agreement with reasonableness check. bit 5: Earth location questionable -- fails reasonableness check. bits 4-1: <zero fill>	33	36	u	4	1	0	
<zero fill>	37	48	i	2	6	0	
NAVIGATION							
Navigation Status Bit Field bits 31-17: <zero fill> bit 16: 1 = earth location corrected for TIP Euler angles (not applicable for SEM) bits 15 - 12: earth location indicator (0 = earth location available; 1 = user ephemeris files greater than 24 hours old; 2 = no earth location available) bits 11 - 8: spacecraft attitude control (0 = operating in YGC or NOMINAL mode; 1 =	49	52	u	4	1	0	2

operating in another mode; 2 = attitude exceeds nominal tolerance; 3 = both 1 and 2) bits 7 - 4: attitude SMODE (0 = NOMINAL mode; 1 = rate nulling mode; 2 = YGC mode; 3 = search mode; 4 = coast mode) bits 3 - 0: attitude PWTIP\$AC (0 = NOMINAL mode/no test; 1 = yaw axis test in progress; 2 = roll axis test in progress; 3 = pitch axis test in progress)							
Time Associated with TIP Euler Angles (Seconds)	53	56	u		1	0	
TIP Euler Angles in Degrees Bytes 57-58: Roll Euler Angle Bytes 59-60: Pitch Euler Angle Bytes 61-62: Yaw Euler Angle	57	62	i	2	3	3	3
Spacecraft Altitude above Reference Ellipsoid in km	63	64	u	2	1	1	
Earth Location (Geodetic subsatellite point normal to ellipsoid; North latitude and East longitude are positive) Bytes 65-68: Latitude in Degrees Bytes 69-72: Longitude in Degrees	65	72	i	4	2	4	
<zero fill>	73	80	i	4	2	0	
SEM MINOR FRAME							
Missing Data Bit Flags (20 entries each for TIP words 20 and 21; used for instances when data from TIP words 20 and 21 could not be recovered because of bit sync loss and the data padded with value 000. This information is important to the further processing of SEM-2 data.) Bits 8-1, byte 81: <zero fill> Bits 8-1, byte 82: <zero fill> Bits 8-1, byte 83: <zero fill> bit 1 (LSB of byte 83): if 1, TIP word 21, minor frame + 19 is padded bit 8 (MSB of byte 84): if 1, TIP word 20, minor frame + 19 is padded bit 7: if 1, TIP word 21, minor frame + 14 is padded bit 6: if 1, TIP word 20, minor frame + 14 is padded bit 5: if 1, TIP word 21, minor frame + 13 is padded bit 4: if 1, TIP word 20, minor frame + 13 is padded	81	88	u	4	2	0	

<p>bit 3: if 1, TIP word 21, minor frame +12 is padded bit 2: if 1, TIP word 21, minor frame + 12 is padded bit 1 (LSB of byte 85): if 1, TIP word 21, minor frame + 11 is padded bit 8 (MSB of byte 86): if 1, TIP word 20, minor frame +11 is padded bit 7: if 1, TIP word 21, minor frame +10 is padded bit 6: if 1, TIP word 20, minor frame +10 is padded bit 5: if 1, TIP word 21, minor frame +09 is padded bit 4: if 1, TIP word 20, minor frame +09 is padded bit 3: if 1, TIP word 21, minor frame +08 is padded bit 2: if 1, TIP word 20, minor frame +08 is padded bit 1 (LSB of byte 86): if 1, TIP word 21, minor frame +07 is padded bit 8 (MSB of byte 87): if 1, TIP word 20, minor frame +07 is padded bit 7: if 1, TIP word 21, minor frame +06 is padded bit 6: if 1, TIP word 20, minor frame +06 is padded bit 5: if 1, TIP word 21, minor frame +05 is padded bit 4: if 1, TIP word 20, minor frame +05 is padded bit 3: if 1, TIP word 21, minor frame +04 is padded bit 2: if 1, TIP word 20, minor frame +04 is padded bit 1 (LSB of byte 87): if 1, TIP word 21, minor frame +03 is padded bit 8 (MSB of byte 88): if 1, TIP word 20, minor frame +03 is padded bit 7: if 1, TIP word 21, minor frame +02 is padded bit 6: if 1, TIP word 20, minor frame +02 is padded bit 5: if 1, TIP word 21, minor frame +01 is padded bit 4: if 1, TIP word 20, minor frame +01 is padded bit 3: if 1, TIP word 21, minor frame +00 is padded bit 2: if 1, TIP word 20, minor frame +00 is padded bit 1 (LSB of byte 88): <zero fill></p>							
TIP word 20, start TIP minor frame plus 00	89	89	u	1	1	0	
TIP word 21, start TIP minor frame plus 00	90	90	u	1	1	0	
TIP word 20, start TIP minor frame plus 01	91	91	u	1	1	0	
TIP word 21, start TIP minor frame plus 01	92	92	u	1	1	0	
TIP word 20, start TIP minor frame plus 02	93	93	u	1	1	0	
TIP word 21, start TIP minor frame plus 02	94	94	u	1	1	0	
TIP word 20, start TIP minor frame plus 03	95	95	u	1	1	0	
TIP word 21, start TIP minor frame plus 03	96	96	u	1	1	0	
TIP word 20, start TIP minor frame plus 04	97	97	u	1	1	0	
TIP word 21, start TIP minor frame plus 04	98	98	u	1	1	0	
TIP word 20, start TIP minor frame plus 05	99	99	u	1	1	0	
TIP word 21, start TIP minor frame plus 05	100	100	u	1	1	0	
TIP word 20, start TIP minor frame plus 06	101	101	u	1	1	0	
TIP word 21, start TIP minor frame plus 06	102	102	u	1	1	0	
TIP word 20, start TIP minor frame plus 07	103	103	u	1	1	0	

TIP word 21, start TIP minor frame plus 07	104	104	u	1	1	0	
TIP word 20, start TIP minor frame plus 08	105	105	u	1	1	0	
TIP word 21, start TIP minor frame plus 08	106	106	u	1	1	0	
TIP word 20, start TIP minor frame plus 09	107	107	u	1	1	0	
TIP word 21, start TIP minor frame plus 09	108	108	u	1	1	0	
TIP word 20, start TIP minor frame plus 10	109	109	u	1	1	0	
TIP word 21, start TIP minor frame plus 10	110	110	u	1	1	0	
TIP word 20, start TIP minor frame plus 11	111	111	u	1	1	0	
TIP word 21, start TIP minor frame plus 11	112	112	u	1	1	0	
TIP word 20, start TIP minor frame plus 12	113	113	u	1	1	0	
TIP word 21, start TIP minor frame plus 12	114	114	u	1	1	0	
TIP word 20, start TIP minor frame plus 13	115	115	u	1	1	0	
TIP word 21, start TIP minor frame plus 13	116	116	u	1	1	0	
TIP word 20, start TIP minor frame plus 14	117	117	u	1	1	0	
TIP word 21, start TIP minor frame plus 14	118	118	u	1	1	0	
TIP word 20, start TIP minor frame plus 15	119	119	u	1	1	0	
TIP word 21, start TIP minor frame plus 15	120	120	u	1	1	0	
TIP word 20, start TIP minor frame plus 16	121	121	u	1	1	0	
TIP word 21, start TIP minor frame plus 16	122	122	u	1	1	0	
TIP word 20, start TIP minor frame plus 17	123	123	u	1	1	0	
TIP word 21, start TIP minor frame plus 17	124	124	u	1	1	0	
TIP word 20, start TIP minor frame plus 18	125	125	u	1	1	0	
TIP word 21, start TIP minor frame plus 18	126	126	u	1	1	0	
TIP word 20, start TIP minor frame plus 19	127	127	u	1	1	0	
TIP word 21, start TIP minor frame plus 19	128	128	u	1	1	0	
<zero fill>	129	132	i	4	1	0	
DIGITAL B TELEMETRY							
Invalid Word Bit Flags (Indicates whether updated instrument status data from TIP word 8 is in this minor frame.) bit 8, MSB of byte 133: if 0, update of microprocessor System ID occurred bit 7: if 0, update of TED IFC status occurred bit 6: if 0, update of MEPED IFC status occurred bit 5: if 0, update of TED electron PHD level occurred, MSB bit 4: if 0, update of TED electron PHD level occurred, LSB bits 3-1: <zero fill>bit 8, MSB of byte 134: if 0, update of microprocessor A Watchdog occurred bit 7: if 0, update of microprocessor B Watchdog occurred bit 6: if 0, update of TED proton PHD level occurred, MSB bit 5: if 0, update of TED proton PHD level occurred, LSB bits 4-1: <zero fill>	133	134	u	2	1	0	
Digital B Telemetry (contain the actual instrument status bits)bit 8, MSB of byte 135: Microprocessor System ID, 0 for processor A bit 7: TED IFC (0 = off; 1 = on)bit 6: MEPED IFC (0 = off; 1 = on)bit 5: TED electron PHD	135	136	u	2	1	0	

level, MSB bit 4: TED electron PHD level, LSB bits 3-1: <zero fill>bit 8, MSB of byte 136: microprocessor A watchdog, 0=normal bit 7: microprocessor B watchdog, 0=normal bit 6: TED proton PHD level, MSB bit 5: TED proton PHD level, LSB bits 4-1: <zero fill>							
<zero fill>	137	140		4	1	0	
ANALOG HOUSEKEEPING DATA (TIP)							
Invalid Word Bit Flags (TIP word 09 and 10 housekeeping availability flags. These indicate whether updated instrument analog housekeeping data from TIP words 9 and 10 are in this minor frame.)byte 141: <zero fill>bit 8, MSB of byte 142: <zero fill>bit 7: if 0, update of primary bus voltage monitor bit 6: if 0, update of backup pitch coil driver monitor (attitude control)bit 5: if 0, update of primary pitch coil driver monitor (attitude control) bit 4: if 0, update of backup roll/yaw coil driver bit 3: if 0, update of primary roll/yaw coil driver bit 2: if 0, update of Z axis gyro torque current monitor bit 1, LSB of byte 142: if 0, update of Y axis gyro torque current monitor bit 8, MSB of byte 143: if 0, update of X axis gyro torque current monitor bit 7: if 0, update of S gyro torque current monitor bit 6: if 0, update of DPU temperature monitor bit 5: if 0, update of TED temperature monitor bit 4: if 0, update MEPED proton telescope temperature monitor bit 3: if 0, update of MEPED circuit temperature monitor bit 2: if 0, update of Omni detector bias voltage monitor bit 1, LSB of byte 143: if 0, update of TED proton CEM high voltage monitor bit 8, MSB of byte 144: if 0, update of TED electron CEM high voltage monitor bit 7: if 0, update of TED sweep voltage monitor bit 6: if 0, update of TED +5V monitor bit 5: if 0, update of MEPED +5V monitor bit 4: if 0, update of DPU +5V monitor bit 3: if 0, update of microprocessor B +5V monitor bit 2: if 0, update of microprocessor A +5V monitor bit 1, LSB of byte 144: <zero fill>	141	144	u	4	1	0	
Analog Telemetry (Actual values of TIP analog housekeeping words 09 and 10 refreshed only when the corresponding bit in bytes 142-144 is set to 0.)byte 145: microprocessor A +5V monitor byte 146: microprocessor B +5V monitor byte 147: DPU +5V Monitor byte 148: MEPED +5V Monitor byte 149: TED +5V Monitor byte 150: TED	145	166	u	1	22	0	

Sweep Voltage monitor byte 151: TED electron CEM High Voltage monitor byte 152: TED proton CEM High Voltage monitor byte 153: MEPED Omni detector Bias Voltage monitor byte 154: MEPED electronics circuit temperature monitor byte 155: MEPED proton telescope temperature monitor byte 156: TED Temperature monitor byte 157: DPU Temperature monitor byte 158: S Gyro Torque Current monitor byte 159: X Gyro Torque Current monitor byte 160: Y Gyro Torque Current monitor byte 161: Z Gyro Torque Current monitor byte 162: Primary Roll/Yaw Coil Driver current monitor byte 163: Backup Roll/Yaw Coil Driver current monitor byte 164: Primary Pitch Coil Driver current monitor byte 165: Backup Pitch Coil Driver current monitor byte 166: Primary Bus Voltage monitor							
FILLER							
<zero fill>	167	512	i	2	173	0	
NOTES:							
1. The direction of satellite travel is required for calculation of sensor look angles with respect to the geomagnetic field.							
2. A survey of the data in the incremental files shows that bytes 49-52 are always zero and it seems that satellite attitude quality flags are not introduced in the SEM-2 incremental data file.							
3. A survey of the data in the incremental files shows that bytes 53-62 are always zero and it seems that satellite attitude status data are not introduced in the SEM-2 incremental data file.							

An extensive survey of SEM incremental data files was done to verify this documentation. Of the bytes between 29 and 62 inclusive, that include navigation error flags and information about the Euler angles, only bytes 29, 34, and 36, ever show values other than 000. The conclusion is that navigation/attitude status flags (bytes 49-52) and Euler angle information (bytes 53-62) are not provided.

Moreover, certain bits in bytes 29, 34 and 36, that are defined as providing status, never seem to be used. Specifically, bit 3 in byte 29 (first good time following a spacecraft clock update) is never set to 1; bit 8 in byte 34 (time is bad but probably can be inferred from previous time) nor bit 5 in byte 34 (this time starts a sequence that duplicates previous times) are never set to 1; bit 6 in byte 36 (earth location questionable - marginal agreement with reasonableness check) nor bit 5 in byte 36 (earth location questionable - fails reasonableness check) are never set to 1.

The study did confirm that bit 2 in byte 29 (SEM instrument status changed beginning this frame) is a reliable indicator of when the TED or MEPED are undergoing IFC. The combination of bit 8 in byte 29 (this 2-second frame is not valid) set to 1, bit 7 in byte 29 (time sequence error in this 2-second frame) set to 1, bit 4 in byte 29 (earth location data not available) set to 1, and bit 8 in byte 36 (no earth location because of bad time) set to 1 proves to be a reliable indicator of zero fill in the earth location field (bytes 65 to 72).

Information about when the magnetic torque coils were energized, a procedure required to maintain spacecraft attitude control, was introduced into the SEM data record. This was done because of concern that when the coils were energized the measurement of low energy particles by the TED would be compromised. The analysis to determine whether or not the TED observations are influenced by the torque coils has not been done. However, it was verified that data in bytes 162-165 do reflect those times when the roll/yaw and pitch coils are energized and so that analysis of any impact on TED can be done.

8.3.1.9 MHS Data Sets

This section describes the characteristics and format of Microwave Humidity Sounder (MHS) data sets.

- Section 8.3.1.9.1 Data Characteristics
- Section 8.3.1.9.2 Header Records
- Section 8.3.1.9.3 Data Records

8.3.1.9.1 Data Characteristics

The Microwave Humidity Sounder (MHS) replaced AMSU-B on NOAA-N and -N', and is flown on the Metop series satellites. Since it shares some commonality with the AMSU-B instrument, the AMSU-B Level 1b format was maintained as much as possible. For example, a number of MHS Level 1b fields that are similar to AMSU-B Level 1b fields (e.g., calibration coefficients, earth location data, and earth FOV counts) have the same byte offsets as their corresponding AMSU-B fields. Also, the MHS Level 1b record length is 3,072 bytes, which is the same as the AMSU-B Level 1b record length. However, in addition to some obvious telemetry differences, nomenclature used by the instrument manufacturer in MHS documentation is used in this document for consistency. For example, the channels on MHS are referred to as H1, H2, H3, H4 and H5, as opposed to channels 16, 17, 18, 19 and 20, respectively, on AMSU-B.

The MHS instrument, and its associated interface unit (the MIU) on the NOAA satellites, can operate in a variety of different modes and output several different packets, or formats, of data. The MHS Level 1b format given in this document is applicable for any mode of the MHS instrument and for the “nominal” modes of the MIU, i.e., the modes in which the MIU passes through its received MHS data without replacement with its own telemetry data. The MHS Level 1b data will not contain any MIU telemetry. (Note: the MIU is a NOAA-specific piece of hardware. Therefore, references to the MIU and how it affects the data stream are only applicable to the MHS data from the NOAA satellites.)

Table 8.3.1.9.1-1 shows the nine MHS modes in which packet data is output and the three types of packets that are output in these modes.

Table 8.3.1.9.1-1. MHS modes.	
MHS Mode	MHS Output
Power-on	Empty Science Data Packet
Warm-up	Empty Science Data Packet
Standby	Empty Science Data Packet
Scan	Science Data Packet
Fixed View	Science Data Packet
Self-test	Extended Test Data Packet
Safeing	Empty Science Data Packet
Fault	Empty Science Data Packet
Memory Dump	Extended Memory Data Packet

An empty science data packet has the same format as the science data packet. However, except for the initial 39 bytes of housekeeping data, the packet is empty - i.e., zero filled. In fixed view mode, the instrument is not scanning, but is set, or fixed, at one view position. Therefore, all of its normal views of earth, space, and the on-board calibration target (OBCT) are of this fixed view position instead. When an empty science data packet is received or when the instrument is in fixed view mode, calibration is unable to be performed. Therefore, scans generated in either of these two situations are marked as unusable.

Technically, memory dump mode is not an actual mode of the MHS. Instead, the MHS can be commanded to perform a memory dump during most of its modes. The extended memory data packet generated during a memory dump supersedes the packet normally output during that particular mode. For the sake of simplicity, this document treats memory dump mode as a unique MHS mode.

According to Table 8.3.1.9.1-1, when MHS is in "self-test" mode or "memory dump" mode, it will output an extended test data packet or extended memory dump packet, respectively. In all other modes, including "scan" mode, it will output a (possibly empty) science data packet. The instrument will normally be in "scan" mode. Each different type of packet output by MHS results in a different type of data record output to the MHS Level 1b data set. This document provides Level 1b format specifications for all three types of data records. However, no matter the type of data record, they all share the same basic three-part organization: a header section, a packet data section, and a trailer section. The format of the header and trailer sections are identical across the three types of data records. The header section is composed of the first 29 bytes of the data record, which comprise the fields "Scan Line Number" through "Scan Line Quality Flags [Time Problem Code]", inclusively. The trailer section is composed of the last 238 bytes of the data record, which begins with the field "Main Bus Select Status" and continues through the "<zero fill>" padding at end of record. The content and format of the packet data section varies depending on the type of data record. In all cases though, the actual data from the particular MHS packet within this section begins at the same byte offset (1481). Additionally, in the case of data records containing either extended test data packets or extended memory data packets, the packet data is inserted exactly as received from the spacecraft without modification. (Some of the data in a science packet is slightly

re-ordered, to align with common fields of the AMSU-B Level 1b data record, with a few additional fields inserted.)

As mentioned above, an empty science data packet and a science data packet have the same format. The difference is that most of the content of an empty science data packet is, as its name implies, empty. In terms of a Level 1b data record containing an empty science data packet, the following fields are zero filled (empty):

- "Scene (Earth View) Data" (bytes 1481-2560) through "OBCT View Position Validity Flags" (bytes 2686-2686)
- "Status Word" (byte 2727) through "Science Packet Spare Words" (bytes 2787-2831)

However, an empty science data packet does contain valid housekeeping data. So, in a data record containing an empty science data packet, the "Mode and Sub-commutation Code" field (byte 2687) through the "Raw Current Consumption Data" field (bytes 2720-2725) contain valid data.

8.3.1.9.2 Header Records

The MHS Primary Header Record format is documented in Table 8.3.1.9.2-1. See the legend in Section 8.3.1.1 for further explanation of the headings on this table.

Table 8.3.1.9.2-1. MHS Primary Header Record Format.								
Field Name	Start Octet	End Octet	DT	Word Size	Number of Words	SF	Units	Notes
FILE IDENTIFICATION								
Data Set Creation Site ID CMS=Centre de Meteorologie Spatiale/France DSS=Dundee Satellite Receiving Station/UK NSS=National Environmental Satellite, Data and Information Service/USA UKM=United Kingdom Meteorological Office/UK	1	3	c	3	1	0		
<ASCII blank = x20>	4	4	c	1	1	0		
Level 1b Format Version Number 1=TIROS-N, NOAA-6 through NOAA-14; 2=NOAA-15, -16, -17 (pre-April 28, 2005); 3=all satellites post-April 28, 2005; 4=cloud mask flag (CLAVR-x)-Jan 25, 2006.	5	6	u	2	1	0		
Level 1b Format Version Year (four digits, e.g., 2000)	7	8	u	2	1	0		
Level 1b Format Version Day of Year (e.g., 365)	9	10	u	2	1	0		
<Reserved for Logical Record Length> (For Creation Site use only. Logical Record Length of source Level 1b data set prior to processing.)	11	12	u	2	1	0	octets	

<Reserved for Block Size> (For Creation Site use only. Block Size of source 1b data set prior to processing.)	13	14	u	2	1	0	octets	
Count of Header Records in this Data Set	15	16	u	2	1	0		
<zero fill>	17	22	i	2	3	0		
Data Set Name	23	64	c	42	1	0		
Processing Block Identification	65	72	c	8	1	0		
NOAA Spacecraft Identification Code 2=NOAA-15 4=NOAA-16 6=NOAA-17 7=NOAA-18 8=NOAA-19 11=MetOp-1 12=MetOp-2	73	74	u	2	1	0		
Instrument ID 0 = Proto-Flight Model (PFM) (NOAA-N) 2 = Flight Model 2 (FM2) (NOAA-N')	75	76	u	2	1	0		
Data Type Code 12=MHS	77	78	u	2	1	0		
TIP Source Code 0=unused, i.e., GAC/HRPT/LAC data 1=GAC-embedded AMSU and TIP 2=stored TIP (STIP) 3=HRPT/LAC-embedded AMSU and TIP 4=stored AIP (SAIP)	79	80	u	2	1	0		
Start of Data Set Day Count starting from 0 at 00h, 1 Jan 1950	81	84	u	4	1	0		
Start of Data Set Year (four digits, e.g., 2000)	85	86	u	2	1	0		
Start of Data Set Day of Year (e.g., 365)	87	88	u	2	1	0		
Start of Data Set UTC Time of Day	89	92	u	4	1	0	msec	
End of Data Set Day Count starting from 0 at 00h, 1 Jan 1950	93	96	u	4	1	0		
End of Data Set Year (four digits, e.g., 2000)	97	98	u	2	1	0		
End of Data Set Day of Year (e.g., 365)	99	100	u	2	1	0		
End of Data Set UTC Time of Day	101	104	u	4	1	0	msec	
Year of Last CPIDS Update (four digits, e.g., 2000)	105	106	u	2	1	0		
Day of Year of Last CPIDS Update (e.g., 365)	107	108	u	2	1	0		
Offset between Start of Scan and Center of First FOV	109	110	i	2	1	0	msec	
<zero fill>	111	120	i	2	5	0		
DATA SET QUALITY INDICATORS								
Instrument Status (These are bit flags taken from "Mode and Sub-commutation Code" field and "Switch Status" field on first data record for which all of the individual status flags have been reported at least once.) bits 31-28: mode code (0=power on; 1=warm up;	121	124	u	4	1	0		

2=stand by; 3=scan; 4=fixed view; 5=self test; 6=safeing; 7=fault; 8-14=<unused>; 15=memory data packet ID bit 27: PIE ID (0=PIE A; 1=PIE B) bits 26-24: sub-commutation code (only meaningful for telemetry packet data) bit 23: receiver channel H4 backend (0=off; 1=on) bit 22: receiver channel H3 backend (0=off; 1=on) bit 21: receiver channel H3/H4 local oscillator selected (0=A; 1=B) bit 20: receiver channel H3/H4 front-end (0=off; 1=on) bit 19: receiver channel H2 local oscillator selected (0=A; 1=B) bit 18: receiver channel H2 (0=off; 1=on) bit 17: receiver channel H1 local oscillator selected (0=A; 1=B) bit 16: receiver channel H1 (0=off; 1=on) bit 15: PROM (1=a PROM segment switch has failed ON) bit 14: signal processing electronics/scan control electronics (0=off; 1=on) bit 13: auxiliary operational heaters (0=off; 1=on) bit 12: scan mechanism operational heaters (0=off; 1=on) bit 11: receiver operational heaters (0=off; 1=on) bit 10: Rx CV (0=off; 1=on) bit 9: receiver channel H5 local oscillator selected (0=A; 1=B) bit 8: receiver channel H5 (0=off; 1=on) bit 7: FDM motor current trip status (0=enabled; 1=disabled) bit 6: RDM motor current trip status (0=enabled; 1=disabled) bit 5: FDM motor supply (0=off; 1=on) bit 4: RDM motor supply (0=off; 1=on) bit 3: FDM motor sensors selected (0=A; 1=B) bit 2: RDM motor sensors selected (0=A; 1=B) bit 1: FDM zero position sensors (0=A; 1=B) bit 0: RDM zero position sensors (0=A; 1=B)								
<zero fill>	125	126	i	2	1	0		
Record Number of Status Change (if 0, none occurred)	127	128	u	2	1	0		
Second Instrument Status (if previous word is 0, no change)	129	132	u	4	1	0		
Count of Data Records in this Data Set	133	134	u	2	1	0		
Count of Calibrated, Earth Located Scan Lines in this Data Set	135	136	u	2	1	0		

Count of Missing Scan Lines	137	138	u	2	1	0		
Count of Data Gaps in this Data Set (NOTE: Gaps are due to either actual lost data, such as during transmissions, or ignored data when the instrument science data is superseded by other telemetry data during non-nominal modes of the TIP or MIU.)	139	140	u	2	1	0		
Count of Scans Containing Lunar-Contaminated Space Views (Also, see bits 8 and 9 of "Scan Line Quality Flags [Calibration Problem Code]" field in data record.) -1=the detection algorithm for lunar contamination is turned off 0=the detection algorithm is turned on: no scans containing lunar-contaminated space views were found >0=the detection algorithm is turned on: the value in this field represents the number of scans found that contain lunar- contaminated space views	141	142	i	2	1	0		
Count of Data Frames Without Frame Sync Word Errors	143	144	u	2	1	0		
Count of PACS Detected TIP Parity Errors	145	146	u	2	1	0		
Sum of All Auxiliary Sync Errors Detected in the Input Data	147	148	u	2	1	0		
Time Sequence Error 0=none; otherwise, the record number of the first occurrence	149	150	u	2	1	0		
Time Sequence Error Code (These are bit flags taken from "Scan Line Quality Flags [Time Problem Code]" on data record reported in "Time Sequence Error" field above. If a bit is on (=1) then the statement is true.) bits 15-8: <zero fill> bit 7: time field is bad but can probably be inferred from the previous good time bit 6: time field is bad and can't be inferred from the previous good time bit 5: this record starts a sequence that is inconsistent with previous times (i.e., there is a time discontinuity); may be associated with a spacecraft clock update bit 4: start of a sequence that apparently repeats scan times that have been previously accepted bits 3-0: <zero fill>	151	152	u	2	1	0		
SOCC Clock Update Indicator 0=none during this orbit; otherwise, the record number of the first occurrence	153	154	u	2	1	0		
Earth Location Error Indicator 0=none during this orbit; otherwise, the record number of the first occurrence	155	156	u	2	1	0		

Earth Location Error Code (These are bit flags taken from "Scan Line Quality Flags [Earth Location Problem Code]" on data record reported in "Earth Location Error Indicator" field above. If a bit is on (=1) then the statement is true.) bits 15-8: <zero fill> bit 7: not earth located because of bad time; earth location fields zero-filled bit 6: earth location questionable: questionable time code bit 5: earth location questionable: marginal agreement with reasonableness checkbit 4: earth location questionable: fails reasonableness checkbit 3: earth location questionable because of antenna position checkbits 2-0: <zero fill>	157	158	u	2	1	0		
PACS Status Bit Field bits 15-3: <zero fill> bit 2: pseudonoise (0=normal data; 1=pseudonoise data) bit 1: tape direction (0=reverse playback, time decrementing) bit 0: data mode (0=test data; 1=flight data)	159	160	u	2	1	0		
Data Source 0=unused 1=Fairbanks, AK 2=Wallops Is., VA 3=SOCC 4=Svalbard, Norway 5=Monterey, CA	161	162	u	2	1	0		
<Reserved for the Ingester>	163	170	c	8	1	0		
<Reserved for Decommutation>	171	178	c	8	1	0		
<zero fill>	179	194	i	2	8	0		
CALIBRATION								
Instrument Temperature Sensor ID 0=primary (H5 Local Oscillator (LO) temperature Q-band Source [QBS5])1=backup (H1 LO temperature [QBS1])	195	196	i	2	1	0		
<zero fill>	197	198	i	2	1	0		
Primary Reference Temperature (from QBS5), Minimum	199	200	i	2	1	2	K	
Primary Reference Temperature (from QBS5), Nominal	201	202	i	2	1	2	K	
Primary Reference Temperature (from QBS5), Maximum	203	204	i	2	1	2	K	
Backup Reference Temperature (from QBS1), Minimum	205	206	i	2	1	2	K	
Backup Reference Temperature (from QBS1), Nominal	207	208	i	2	1	2	K	

Backup Reference Temperature (from QBS1), Maximum	209	210	i	2	1	2	K	
Ch. H1 Warm Load Correction Factor (minimum temperature)	211	212	i	2	1	3	K	
Ch. H1 Warm Load Correction Factor (nominal temperature)	213	214	i	2	1	3	K	
Ch. H1 Warm Load Correction Factor (maximum temperature)	215	216	i	2	1	3	K	
Ch. H1 Cold Space Temperature Correction (profile 0)	217	218	i	2	1	3	K	
Ch. H1 Cold Space Temperature Correction (profile 1)	219	220	i	2	1	3	K	
Ch. H1 Cold Space Temperature Correction (profile 2)	221	222	i	2	1	3	K	
<Reserved for Profile 3>	223	224	i	2	1	0		
Ch. H2 Warm Load Correction Factor (minimum temperature)	225	226	i	2	1	3	K	
Ch. H2 Warm Load Correction Factor (nominal temperature)	227	228	i	2	1	3	K	
Ch. H2 Warm Load Correction Factor (maximum temperature)	229	230	i	2	1	3	K	
Ch. H2 Cold Space Temperature Correction (profile 0)	231	232	i	2	1	3	K	
Ch. H2 Cold Space Temperature Correction (profile 1)	233	234	i	2	1	3	K	
Ch. H2 Cold Space Temperature Correction (profile 2)	235	236	i	2	1	3	K	
<Reserved for Profile 3>	237	238	i	2	1	0		
Ch. H3 Warm Load Correction Factor (minimum temperature)	239	240	i	2	1	3	K	
Ch. H3 Warm Load Correction Factor (nominal temperature)	241	242	i	2	1	3	K	
Ch. H3 Warm Load Correction Factor (maximum temperature)	243	244	i	2	1	3	K	
Ch. H3 Cold Space Temperature Correction (profile 0)	245	246	i	2	1	3	K	
Ch. H3 Cold Space Temperature Correction (profile 1)	247	248	i	2	1	3	K	
Ch. H3 Cold Space Temperature Correction (profile 2)	249	250	i	2	1	3	K	
<Reserved for Profile 3>	251	252	i	2	1	0		
Ch. H4 Warm Load Correction Factor (minimum temperature)	253	254	i	2	1	3	K	
Ch. H4 Warm Load Correction Factor (nominal temperature)	255	256	i	2	1	3	K	
Ch. H4 Warm Load Correction Factor (maximum temperature)	257	258	i	2	1	3	K	
Ch. H4 Cold Space Temperature Correction (profile 0)	259	260	i	2	1	3	K	

Ch. H4 Cold Space Temperature Correction (profile 1)	261	262	i	2	1	3	K	
Ch. H4 Cold Space Temperature Correction (profile 2)	263	264	i	2	1	3	K	
<Reserved for Profile 3>	265	266	i	2	1	0		
Ch. H5 Warm Load Correction Factor (minimum temperature)	267	268	i	2	1	3	K	
Ch. H5 Warm Load Correction Factor (nominal temperature)	269	270	i	2	1	3	K	
Ch. H5 Warm Load Correction Factor (maximum temperature)	271	272	i	2	1	3	K	
Ch. H5 Cold Space Temperature Correction (profile 0)	273	274	i	2	1	3	K	
Ch. H5 Cold Space Temperature Correction (profile 1)	275	276	i	2	1	3	K	
Ch. H5 Cold Space Temperature Correction (profile 2)	277	278	i	2	1	3	K	
<Reserved for Profile 3>	279	280	i	2	1	0		
LO A Ch. H1 Nonlinearity Coefficient (minimum temperature)	281	284	i	4	1	8	$m^2\text{-sr-cm}^{-1}/mW$	
LO A Ch. H1 Nonlinearity Coefficient (nominal temperature)	285	288	i	4	1	8	$m^2\text{-sr-cm}^{-1}/mW$	
LO A Ch. H1 Nonlinearity Coefficient (maximum temperature)	289	292	i	4	1	8	$m^2\text{-sr-cm}^{-1}/mW$	
LO A Ch. H2 Nonlinearity Coefficient (minimum temperature)	293	296	i	4	1	8	$m^2\text{-sr-cm}^{-1}/mW$	
LO A Ch. H2 Nonlinearity Coefficient (nominal temperature)	297	300	i	4	1	8	$m^2\text{-sr-cm}^{-1}/mW$	
LO A Ch. H2 Nonlinearity Coefficient (maximum temperature)	301	304	i	4	1	8	$m^2\text{-sr-cm}^{-1}/mW$	
LO A Ch. H3 Nonlinearity Coefficient (minimum temperature)	305	308	i	4	1	8	$m^2\text{-sr-cm}^{-1}/mW$	
LO A Ch. H3 Nonlinearity Coefficient (nominal temperature)	309	312	i	4	1	8	$m^2\text{-sr-cm}^{-1}/mW$	
LO A Ch. H3 Nonlinearity Coefficient (maximum temperature)	313	316	i	4	1	8	$m^2\text{-sr-cm}^{-1}/mW$	
LO A Ch. H4 Nonlinearity Coefficient (minimum temperature)	317	320	i	4	1	8	$m^2\text{-sr-cm}^{-1}/mW$	
LO A Ch. H4 Nonlinearity Coefficient (nominal temperature)	321	324	i	4	1	8	$m^2\text{-sr-cm}^{-1}/mW$	
LO A Ch. H4 Nonlinearity Coefficient (maximum temperature)	325	328	i	4	1	8	$m^2\text{-sr-cm}^{-1}/mW$	
LO A Ch. H5 Nonlinearity Coefficient (minimum temperature)	329	332	i	4	1	8	$m^2\text{-sr-cm}^{-1}/mW$	
LO A Ch. H5 Nonlinearity Coefficient (nominal temperature)	333	336	i	4	1	8	$m^2\text{-sr-cm}^{-1}/mW$	
LO A Ch. H5 Nonlinearity Coefficient (maximum temperature)	337	340	i	4	1	8	$m^2\text{-sr-cm}^{-1}/mW$	
LO B Ch. H1 Nonlinearity Coefficient (minimum temperature)	341	344	i	4	1	8	$m^2\text{-sr-cm}^{-1}/mW$	

LO B Ch. H1 Nonlinearity Coefficient (nominal temperature)	345	348	i	4	1	8	m ² -sr-cm ⁻¹ /mW	
LO B Ch. H1 Nonlinearity Coefficient (maximum temperature)	349	352	i	4	1	8	m ² -sr-cm ⁻¹ /mW	
LO B Ch. H2 Nonlinearity Coefficient (minimum temperature)	353	356	i	4	1	8	m ² -sr-cm ⁻¹ /mW	
LO B Ch. H2 Nonlinearity Coefficient (nominal temperature)	357	360	i	4	1	8	m ² -sr-cm ⁻¹ /mW	
LO B Ch. H2 Nonlinearity Coefficient (maximum temperature)	361	364	i	4	1	8	m ² -sr-cm ⁻¹ /mW	
LO B Ch. H3 Nonlinearity Coefficient (minimum temperature)	365	368	i	4	1	8	m ² -sr-cm ⁻¹ /mW	
LO B Ch. H3 Nonlinearity Coefficient (nominal temperature)	369	372	i	4	1	8	m ² -sr-cm ⁻¹ /mW	
LO B Ch. H3 Nonlinearity Coefficient (maximum temperature)	373	376	i	4	1	8	m ² -sr-cm ⁻¹ /mW	
LO B Ch. H4 Nonlinearity Coefficient (minimum temperature)	377	380	i	4	1	8	m ² -sr-cm ⁻¹ /mW	
LO B Ch. H4 Nonlinearity Coefficient (nominal temperature)	381	384	i	4	1	8	m ² -sr-cm ⁻¹ /mW	
LO B Ch. H4 Nonlinearity Coefficient (maximum temperature)	385	388	i	4	1	8	m ² -sr-cm ⁻¹ /mW	
LO B Ch. H5 Nonlinearity Coefficient (minimum temperature)	389	392	i	4	1	8	m ² -sr-cm ⁻¹ /mW	
LO B Ch. H5 Nonlinearity Coefficient (nominal temperature)	393	396	i	4	1	8	m ² -sr-cm ⁻¹ /mW	
LO B Ch. H5 Nonlinearity Coefficient (maximum temperature)	397	400	i	4	1	8	m ² -sr-cm ⁻¹ /mW	
<zero fill>	401	416	i	4	4	0		
TEMPERATURE-RADIANCE CONVERSION								
Temperature-radiance Ch H1 Central Wavenumber	417	420	i	4	1	6	cm ⁻¹	
Temperature-radiance Ch H1 Constant 1	421	424	i	4	1	6		
Temperature-radiance Ch H1 Constant 2	425	428	i	4	1	6		
Temperature-radiance Ch H2 Central Wavenumber	429	432	i	4	1	6	cm ⁻¹	
Temperature-radiance Ch H2 Constant 1	433	436	i	4	1	6		
Temperature-radiance Ch H2 Constant 2	437	440	i	4	1	6		
Temperature-radiance Ch H3 Central Wavenumber	441	444	i	4	1	6	cm ⁻¹	
Temperature-radiance Ch H3 Constant 1	445	448	i	4	1	6		
Temperature-radiance Ch H3 Constant 2	449	452	i	4	1	6		
Temperature-radiance Ch H4 Central Wavenumber	453	456	i	4	1	6	cm ⁻¹	
Temperature-radiance Ch H4 Constant 1	457	460	i	4	1	6		
Temperature-radiance Ch H4 Constant 2	461	464	i	4	1	6		
Temperature-radiance Ch H5 Central Wavenumber	465	468	i	4	1	6	cm ⁻¹	
Temperature-radiance Ch H5 Constant 1	469	472	i	4	1	6		
Temperature-radiance Ch H5 Constant 2	473	476	i	4	1	6		

<zero fill>	477	492	i	4	4	0		
NAVIGATION								
Reference Ellipsoid Model ID (The ellipsoid is a mathematically tractable approximation of the geoid, which is an equipotential surface at mean sea level. The maximum departure of the ellipsoid from the geoid is approximately ± 65 meters.) WGS-72=World Geodetic Survey 1972 JGM3 =Joint Gravity Model 3	493	500	c	8	1	0		
Nadir Earth Location Tolerance	501	502	u	2	1	1	Km	
Earth Location Bit Field bits 15-3: <zero fill> bit 2: dynamic attitude error correction (0= not performed; 1=performed) bit 1: reasonableness test (0=inactive; 1=active) bit 0: constant attitude error correction (0=not performed; 1=performed)	503	504	u	2	1	0		
<zero fill>	505	506	i	2	1	0		
Constant Roll Attitude Error	507	508	i	2	1	3	degrees	
Constant Pitch Attitude Error	509	510	i	2	1	3	degrees	
Constant Yaw Attitude Error	511	512	i	2	1	3	degrees	
Epoch Year for Orbit Vector	513	514	u	2	1	0		
Day of Epoch Year for Orbit Vector	515	516	u	2	1	0		
Epoch UTC Time of Day for Orbit Vector	517	520	u	4	1	0	ms	
Semi-major Axis (at the orbit vector epoch time)	521	524	i	4	1	5	km	
Eccentricity (at the orbit vector epoch time)	525	528	i	4	1	8		
Inclination (at the orbit vector epoch time)	529	532	i	4	1	5	degrees	
Argument of Perigee (at the orbit vector epoch time)	533	536	i	4	1	5	degrees	
Right Ascension of the Ascending Node (at the orbit vector epoch time)	537	540	i	4	1	5	degrees	
Mean Anomaly (at the orbit vector epoch time)	541	544	i	4	1	5	degrees	
Position Vector X Component (at the orbit vector epoch time)	545	548	i	4	1	5	km	
Position Vector Y Component (at the orbit vector epoch time)	549	552	i	4	1	5	km	
Position Vector Z Component (at the orbit vector epoch time)	553	556	i	4	1	5	km	
Velocity Vector X-dot Component (at the orbit vector epoch time)	557	560	i	4	1	8	km/sec	
Velocity Vector Y-dot Component (at the orbit vector epoch time)	561	564	i	4	1	8	km/sec	
Velocity Vector Z-dot Component (at the orbit vector epoch time)	565	568	i	4	1	8	km/sec	
Earth/Sun Distance Ratio (at the orbit vector epoch time; relative to the mean distance of 1 AU)	569	572	u	4	1	6		
<zero fill>	573	588	i	4	4	0		
THERMISTOR TELEMETRY CONVERSION								
Counts-to-temperature (K) conversion coefficients for the 24 housekeeping thermistors.								

Thermistor Temperature Coefficient 0	589	592	i	4	1	4	K	
Thermistor Temperature Coefficient 1	593	596	i	4	1	7	K/count	
Thermistor Temperature Coefficient 2	597	600	i	4	1	10	K/count ²	
Thermistor Temperature Coefficient 3	601	604	i	4	1	12	K/count ³	
Thermistor Temperature Coefficient 4	605	608	i	4	1	15	K/count ⁴	
<zero fill>	609	624	i	4	4	0		
RAW CURRENT CONSUMPTION CONVERSION								
EE and SM +5V Current Coefficient 0	625	628	i	4	1	6	amps	
EE and SM +5V Current Coefficient 1	629	632	i	4	1	6	amps/ count	
Receiver +8V Current Coefficient 0	633	636	i	4	1	6	amps	
Receiver +8V Current Coefficient 1	637	640	i	4	1	6	amps/ count	
Receiver +15V Current Coefficient 0	641	644	i	4	1	6	amps	
Receiver +15V Current Coefficient 1	645	648	i	4	1	6	amps/ count	
Receiver -15V Current Coefficient 0	649	652	i	4	1	6	amps	
Receiver -15V Current Coefficient 1	653	656	i	4	1	6	amps/ count	
RDM Motor Current Coefficient 0	657	660	i	4	1	6	amps	
RDM Motor Current Coefficient 1	661	664	i	4	1	6	amps/ count	
FDM Motor Current Coefficient 0	665	668	i	4	1	6	amps	
FDM Motor Current Coefficient 1	669	672	i	4	1	6	amps/ count	
OBCT TEMPERATURE CONVERSION								
PRT resistance-to-temperature conversion coefficients, where resistance is in ohms and temperature is in K.								
PIE-A PRT 1 Coefficient 0	673	676	i	4	1	6	K	
PIE-A PRT 1 Coefficient 1	677	680	i	4	1	6	K/ohm	
PIE-A PRT 1 Coefficient 2	681	684	i	4	1	10	K/ohm ²	
PIE-A PRT 1 Coefficient 3	685	688	i	4	1	13	K/ohm ³	
PIE-A PRT 2 Coefficient 0	689	692	i	4	1	6	K	
PIE-A PRT 2 Coefficient 1	693	696	i	4	1	6	K/ohm	
PIE-A PRT 2 Coefficient 2	697	700	i	4	1	10	K/ohm ²	
PIE-A PRT 2 Coefficient 3	701	704	i	4	1	13	K/ohm ³	
PIE-A PRT 3 Coefficient 0	705	708	i	4	1	6	K	
PIE-A PRT 3 Coefficient 1	709	712	i	4	1	6	K/ohm	
PIE-A PRT 3 Coefficient 2	713	716	i	4	1	10	K/ohm ²	
PIE-A PRT 3 Coefficient 3	717	720	i	4	1	13	K/ohm ³	
PIE-A PRT 4 Coefficient 0	721	724	i	4	1	6	K	
PIE-A PRT 4 Coefficient 1	725	728	i	4	1	6	K/ohm	
PIE-A PRT 4 Coefficient 2	729	732	i	4	1	10	K/ohm ²	
PIE-A PRT 4 Coefficient 3	733	736	i	4	1	13	K/ohm ³	
PIE-A PRT 5 Coefficient 0	737	740	i	4	1	6	K	
PIE-A PRT 5 Coefficient 1	741	744	i	4	1	6	K/ohm	
PIE-A PRT 5 Coefficient 2	745	748	i	4	1	10	K/ohm ²	
PIE-A PRT 5 Coefficient 3	749	752	i	4	1	13	K/ohm ³	
PIE-B PRT 1 Coefficient 0	753	756	i	4	1	6	K	
PIE-B PRT 1 Coefficient 1	757	760	i	4	1	6	K/ohm	

PIE-B PRT 1 Coefficient 2	761	764	i	4	1	10	K/ohm ²	
PIE-B PRT 1 Coefficient 3	765	768	i	4	1	13	K/ohm ²	
PIE-B PRT 2 Coefficient 0	769	772	i	4	1	6	K	
PIE-B PRT 2 Coefficient 1	773	776	i	4	1	6	K/ohm	
PIE-B PRT 2 Coefficient 2	777	780	i	4	1	10	K/ohm ²	
PIE-B PRT 2 Coefficient 3	781	784	i	4	1	13	K/ohm ³	
PIE-B PRT 3 Coefficient 0	785	788	i	4	1	6	K	
PIE-B PRT 3 Coefficient 1	789	792	i	4	1	6	K/ohm	
PIE-B PRT 3 Coefficient 2	793	796	i	4	1	10	K/ohm ²	
PIE-B PRT 3 Coefficient 3	797	800	i	4	1	13	K/ohm ³	
PIE-B PRT 4 Coefficient 0	801	804	i	4	1	6	K	
PIE-B PRT 4 Coefficient 1	805	808	i	4	1	6	K/ohm	
PIE-B PRT 4 Coefficient 2	809	812	i	4	1	10	K/ohm ²	
PIE-B PRT 4 Coefficient 3	813	816	i	4	1	13	K/ohm ³	
PIE-B PRT 5 Coefficient 0	817	820	i	4	1	6	K	
PIE-B PRT 5 Coefficient 1	821	824	i	4	1	6	K/ohm	
PIE-B PRT 5 Coefficient 2	825	828	i	4	1	10	K/ohm ²	
PIE-B PRT 5 Coefficient 3	829	832	i	4	1	13	K/ohm ³	
SURVIVAL TEMPERATURE CONVERSION								
Volts-to-temperature (K) conversion coefficients for the 3 survival temperature parameters. (NOTE: volts = 0.02 x counts.)								
Survival Temperature Coefficient 0	833	836	i	4	1	6	K	
Survival Temperature Coefficient 1	837	840	i	4	1	6	K/volt	
Survival Temperature Coefficient 2	841	844	i	4	1	6	K/volt ²	
Survival Temperature Coefficient 3	845	848	i	4	1	6	K/volt ²	
Survival Temperature Coefficient 4	849	852	i	4	1	6	K/volt ⁴	
Survival Temperature Coefficient 5	853	856	i	4	1	6	K/volt ⁵	
ANTENNA POSITION CONVERSION								
Antenna Position Conversion Factor (for converting "mid-pixel position" data of earth, space, and OBCT views to degrees)	857	860	u	4	1	8	degrees/count	
value = 7.2/1024 = 0.00703125 degrees/count								
PRT CALIBRATION CHANNELS								
PIE-A Calibration Channel 1 Resistance	861	864	i	4	1	4	ohms	
PIE-A Calibration Channel 2 Resistance	865	868	i	4	1	4	ohms	
PIE-A Calibration Channel 3 Resistance	869	872	i	4	1	4	ohms	
PIE-B Calibration Channel 1 Resistance	873	876	i	4	1	4	ohms	
PIE-B Calibration Channel 2 Resistance	877	880	i	4	1	4	ohms	
PIE-B Calibration Channel 3 Resistance	881	884	i	4	1	4	ohms	
LUNAR CONTAMINATION DETECTION								
Lunar Angle Threshold (Any space view whose lunar angle--see "Lunar Angles" field in data record--is less than this value is flagged as being "lunar contaminated" and is not used in the calibration.)	885	886	u	2	1	2	degrees	
RFI CORRECTION								

Bias Correction Values (ordered by channel, FOV, and transmitter) Word 1: Channel H1, FOV 1, STX_1 Word 2: Channel H2, FOV 1, STX_1 Word 3: Channel H3, FOV 1, STX_1 Word 4: Channel H4, FOV 1, STX_1 Word 5: Channel H5, FOV 1, STX_1 Word 6: Channel H1, FOV 5, STX_1...(channel values for FOVs 5, 10, 15, ... , 90)...Word 95: Channel H5, FOV 90, STX_1 Word 96: Channel H1, space view, STX_1...Word 100: Channel H5, space view, STX_1 Word 101: Channel H1, OBCT view, STX_1...Word 106: Channel H1, FOV 1, STX_2...Word 211: Channel H1, FOV 1, STX_3...Word 316: Channel H1, FOV 1, SARR...Word 420: Channel H5, OBCT view, SARR	887	1726	i	2	420	0	counts	1
<zero fill>	1727	1734	i	4	2	0		
Transmitter Reference Power (mean power at the time bias corrections were derived. Range: 0 to 255, representing analog voltages from 0 to 5.1.) Word 1: STX-1 Word 2: STX-2 Word 3: STX-3 Word 4: SARR	1735	1742	i	2	4	1	counts	1
<zero fill>	1743	1752	i	2	5	0		
<zero fill> (for NOAA-originated MHS data, these fields are spare)	1753	1788	i	2	13	0		
FILLER								
<zero fill>	1789	3072	i	2	642	0		
NOTES:								
1) The RFI/bias correction data is based on experience with the AMSU-B instrument from the NOAA KLM series of satellites. While it may not be necessary, it is being left in the MHS Level 1b format. Until a determination is made that it is necessary, it will be zero filled.								

8.3.1.9.3 Data Records (Version 3, post-April 28, 2005, All Spacecraft)

The MHS instrument and its associated interface unit (MIU) on the NOAA satellites can operate in a variety of different modes and output several different packets, or formats, of data. This section describes the different packets that the MHS instrument outputs.

8.3.1.9.3.1 Science Packet

The MHS Level 1b Record Format (Science Packet) is documented in Table 8.3.1.9.3.1-1. See Section 8.3.1.1 for further explanation of the headings on this table.

Table 8.3.1.9.3.1-1. Format of MHS Level 1b Record (Science Packet).

Field Name	Start Octet	End Octet	Data Type	Word Size	Number of Words	Scale Factor	Units	Notes
SCAN LINE INFORMATION								

Scan Line Number (<i>cumulative, starting with 1</i>)	1	2	u	2	1	0	
Scan Line Year (<i>four digits, e.g., 2000</i>)	3	4	u	2	1	0	
Scan Line Day of Year (<i>e.g., 365</i>)	5	6	u	2	1	0	
Satellite Clock Drift Delta	7	8	i	2	1	0msec	
Scan Line UTC Time of Day	9	12	u	4	1	0msec	
Scan Line Bit Field bit 15: satellite direction (0=northbound; 1=southbound) bit 14: clock drift correction (0=not corrected; 1=scan time corrected for clock drift) bits 13-0: <zero fill>	13	14	u	2	1	0	
Major Frame Count (<i>cumulative, starting with 1</i>)	15	16	u	2	1	0	
Coarse MHS On-board Time (OBT) (<i>time since last reset to zero</i>)	17	20	u	4	1	0seconds	
Fine MHS OBT (<i>fraction of second since last increment of coarse MHS OBT. Resolution: 2⁻¹⁶ seconds; range: 0 - 65,535.</i>)	21	22	u	2	1	0	
MHS Mode Flag 0=power-on ("empty" MHS science data) 1=warm-up ("empty" MHS science data) 2=standby ("empty" MHS science data) 3=scan (valid MHS science data) 4=fixed view (valid MHS science data, but instrument is viewing a fixed location) 5=self test (test data) 6=safeing ("empty" MHS science data) 7=fault ("empty" MHS science data) 8-14=<undefined> (unknown data) 15=memory dump (memory dump data) <zero fill>	23	23	u	1	1	0	
QUALITY INDICATORS							
Quality Indicator Bit Field (<i>if a bit is on (=1), the statement is true</i>) bit 31: do not use scan for product generation bit 30: time sequence error detected within this scan (see below) bit 29: data gap precedes this scan (gap may be due to actual lost scans or scans in which the TIP or MIU are in non-nominal modes) bit 28: insufficient data for calibration (see below) bit 27: earth location data not available (see below) bit 26: first good time following a clock update (nominally 0) bit 25: instrument status changed with this scan bits 24 -5: <zero fill> bit 4: transmitter status change occurred (see note 2) bit 3: AMSU sync error detected bit 2: AMSU minor frame error detected bit 1: AMSU major frame error detected bit 0: AMSU parity error detected	25	28	u	4	1	0	2

<p>Scan Line Quality Flags [Time Problem Code] <i>(If a bit is on (=1), the statement is true. All bits off implies the scan time is as expected.)</i></p> <p>bit 7: time field is bad but can probably be inferred from the previous good time</p> <p>bit 6: time field is bad and can't be inferred from the previous good time</p> <p>bit 5: this record starts a sequence that is inconsistent with previous times (i.e., there is a time discontinuity). This may be associated with a spacecraft clock update. (See bit 26, Quality Indicator Bit Field.)</p> <p>bit 4: start of a sequence that apparently repeats scan times that have been previously accepted</p> <p>bits 3-0: <zero fill></p>	29	29	u	1	1	0		
<p>Scan Line Quality Flags [Calibration Problem Code] <i>(If a bit is on (=1), the statement is true. These bits complement the channel indicators; all bits set to 0 indicates normal calibration.)</i></p> <p>Word 1</p> <p>bits 7-2: <zero fill></p> <p>bit 1: scan line contains one or more space views that are lunar contaminated</p> <p>bit 0: lunar-contaminated scan line was able to be calibrated (only applicable if the previous flag [bit 1] is 1; otherwise, zero)</p> <p>Word 2</p> <p>bit 7: scan line was not calibrated because of bad time</p> <p>bit 6: scan line was calibrated using fewer than the preferred number of scan lines because of proximity to start or end of data set or to a data gap</p> <p>bit 5: scan line was not calibrated because of bad or insufficient PRT data</p> <p>bit 4: scan line was calibrated but with marginal PRT data</p> <p>bit 3: some uncalibrated channels on this scan (see channel indicators)</p> <p>bit 2: uncalibrated due to instrument mode</p> <p>bit 1: questionable calibration because of antenna position error of space view</p> <p>bit 0: questionable calibration because of antenna position error of OBCT view</p>	30	31	u	2	1	0		
<p>Scan Line Quality Flags [Earth Location Problem Code] <i>(If a bit is on (=1), the statement is true. All bits set to 0 implies the earth location was normal.)</i></p> <p>bit 7: not earth located because of bad time; earth location fields zero-filled</p> <p>bit 6: earth location questionable: questionable time code (see time problem flags above)</p> <p>bit 5: earth location questionable: marginal agreement with reasonableness check</p> <p>bit 4: earth location questionable: fails reasonableness check</p> <p>bit 3: earth location questionable because of antenna position</p> <p>checkbits 2-0: <zero fill></p>	32	32	u	1	1	0		

Calibration Quality Flags (<i>all bits off implies a good calibration</i>) Word 1: Channel H1 bits 15-7: <zero fill> bit 6: this scan line is either the last one before or the first one after a sudden, anomalous jump (or drop) in calibration counts bit 5: all bad OBCT view counts for scan line bit 4: all bad space view counts for scan line bit 3: all bad PRTs for this line bit 2: marginal OBCT view counts for this line bit 1: marginal space view counts for this line bit 0: marginal PRT temps on this line Words 2-5: Channels H2-H5 (in order)	33	42	u	2	5	0		
<zero fill>	43	60	i	2	9	0		
CALIBRATION COEFFICIENTS								
<i>Note: The following coefficients are only available in Scan and Fixed View modes otherwise the coefficient fields are <zero fill>. Refer to bits 7-4 of the Mode and Sub-commutation Code field for the current mode.</i>								
Primary Calibration Ch H1 Second Order Term, a2	61	64	i	4	1	16		
Primary Calibration Ch H1 First Order Term, a1	65	68	i	4	1	10		
Primary Calibration Ch H1 Zeroth Order Term, a0	69	72	i	4	1	6		
Primary Calibration Ch H2 Second Order Term, a2	73	76	i	4	1	16		
Primary Calibration Ch H2 First Order Term, a1	77	80	i	4	1	10		
Primary Calibration Ch H2 Zeroth Order Term, a0	81	84	i	4	1	6		
Primary Calibration Ch H3 Second Order Term, a2	85	88	i	4	1	16		
Primary Calibration Ch H3 First Order Term, a1	89	92	i	4	1	10		
Primary Calibration Ch H3 Zeroth Order Term, a0	93	96	i	4	1	6		
Primary Calibration Ch H4 Second Order Term, a2	97	100	i	4	1	16		
Primary Calibration Ch H4 First Order Term, a1	101	104	i	4	1	10		
Primary Calibration Ch H4 Zeroth Order Term, a0	105	108	i	4	1	6		
Primary Calibration Ch H5 Second Order Term, a2	109	112	i	4	1	16		
Primary Calibration Ch H5 First Order Term, a1	113	116	i	4	1	10		
Primary Calibration Ch H5 Zeroth Order Term, a0	117	120	i	4	1	6		
Secondary Calibration Ch H1 Second Order Term, a2	121	124	i	4	1	16		
Secondary Calibration Ch H1 First Order Term, a1	125	128	i	4	1	10		
Secondary Calibration Ch H1 Zeroth Order Term, a0	129	132	i	4	1	6		
Secondary Calibration Ch H2 Second Order Term, a2	133	136	i	4	1	16		
Secondary Calibration Ch H2 First Order Term, a1	137	140	i	4	1	10		
Secondary Calibration Ch H2 Zeroth Order Term, a0	141	144	i	4	1	6		
Secondary Calibration Ch H3 Second Order Term, a2	145	148	i	4	1	16		
Secondary Calibration Ch H3 First Order Term, a1	149	152	i	4	1	10		
Secondary Calibration Ch H3 Zeroth Order Term, a0	153	156	i	4	1	6		
Secondary Calibration Ch H4 Second Order Term, a2	157	160	i	4	1	16		
Secondary Calibration Ch H4 First Order Term, a1	161	164	i	4	1	10		
Secondary Calibration Ch H4 Zeroth Order Term, a0	165	168	i	4	1	6		
Secondary Calibration Ch H5 Second Order Term, a2	169	172	i	4	1	16		
Secondary Calibration Ch H5 First Order Term, a1	173	176	i	4	1	10		
Secondary Calibration Ch H5 Zeroth Order Term, a0	177	180	i	4	1	6		
<zero fill>	181	184	i	2	2	0		
NAVIGATION								

Computed Yaw Steering<zero fill> for NOAA	185	190	i	2	3	0	
Total Applied Attitude Correction Word 1: Roll Word 2: Pitch Word 3: Yaw	191	196	i	2	3	3	degrees
Navigation Status Bit Field bits 31-18: <zero fill> bit 17: earth location at the satellite subpoint is accurate and reasonable, i.e., is within tolerance defined by "nadir Earth Location Tolerance" in header (0=out of tolerance; 1=in tolerance) bit 16: earth location corrected for Euler angles (0=FALSE; 1=TRUE) bits 15-12: earth location indicator (0=earth location available; 1=user ephemeris files greater than 24 hours old; 2=no earth location available) bits 11-8: spacecraft attitude control (0=operating in YGC or NOMINAL mode; 1=operating in another mode; 2=attitude exceeds nominal tolerance; 3=both 1 and 2) bits 7-4: attitude SMODE (0=nominal mode; 1=rate nulling mode; 2=YGC mode; 3=search mode; 4=coast mode) bits 3-0: attitude PWTIP\$AC (0=nominal mode/no test; 1=yaw axis test in progress; 2=roll axis test in progress; 3=pitch axis test in progress)	197	200	u	4	1	0	
Time Associated with Euler Angles	201	204	i	4	1	0	seconds
Euler Angles Word 1: Roll Word 2: Pitch Word 3: Yaw	205	210	i	2	3	3	degrees
Spacecraft Altitude above Reference Ellipsoid	211	212	u	2	1	1	km
Angular Relationships (<i>local azimuth range ± 180.00 degrees</i>) Word 1: Solar zenith angle, FOV 1 Word 2: Satellite zenith angle, FOV 1 Word 3: Local azimuth angle, FOV 1 Word 4: Solar zenith angle, FOV 2...(set of 3 angles every FOV) ... Word 270: Local azimuth angle, FOV 90	213	752	i	2	270	2	degrees
Earth Location (<i>north latitude and east longitude are positive</i>) Word 1: Latitude, FOV 1 Word 2: Longitude, FOV 1 Word 3: Latitude, FOV 2...(lat/lon word pair every FOV) ... Word 180: Longitude, FOV 90	753	1472	i	4	180	4	degrees
Lunar Angles (<i>angles between moon and individual space views; range 0 to 180.00 degrees</i>) Word 1: Angle between moon and space view 1 Word 2: Angle between moon and space view 2 Word 3: Angle between moon and space view 3 Word 4: Angle between moon and space view 4	1473	1480	u	2	4	2	degrees
MHS SENSOR DATA							
<i>In fixed view mode, the pixel data is the same format as scan mode, but the concept of earth, space, and OBCT views does not apply. All 98 views (i.e., 90 earth + 4 space + 4 OBCT) are for the fixed view position.</i>							

Scene (Earth View) Data (<i>range: 0 - 65,535</i>) Word 1: Mid-pixel position for FOV 1 Word 2: Scene counts for FOV 1, channel H1 Word 3: Scene counts for FOV 1, channel H2 Word 4: Scene counts for FOV 1, channel H3 Word 5: Scene counts for FOV 1, channel H4 Word 6: Scene counts for FOV 1, channel H5 Word 7: Mid-pixel position for FOV 2 Words 8-12: Scene counts for FOV 2, channels H1-H5 (in order) ... (6 words for every FOV) ... Word 535: Mid-pixel position for FOV 90 Words 536-540: Scene counts for FOV 90, channels H1-H5 (in order)	1481	2560	u	2	540	0	counts	
<zero fill>	2561	2568	i	4	2	0		
CALIBRATION DATA								
Space View Data (<i>range: 0 - 65,535</i>) Word 1: Mid-pixel position for space view 1 Word 2: Counts for space view 1, channel H1 Word 3: Counts for space view 1, channel H2 Word 4: Counts for space view 1, channel H3 Word 5: Counts for space view 1, channel H4 Word 6: Counts for space view 1, channel H5 Word 7: Mid-pixel position for space view 2 Word 8-12: Counts for space view 2, channel H1-H5 (in order) Word 13: Mid-pixel position for space view 3 Word 14-18: Counts for space view 3, channel H1-H5 (in order) Word 19: Mid-pixel position for space view 4 Word 20-24: Counts for space view 4, channel H1-H5 (in order)	2569	2616	u	2	24	0	counts	
OBCT View Data (<i>range: 0 - 65,535</i>) Word 1: Mid-pixel position for OBCT view 1 Word 2: Counts for OBCT view 1, channel H1 Word 3: Counts for OBCT view 1, channel H2 Word 4: Counts for OBCT view 1, channel H3 Word 5: Counts for OBCT view 1, channel H4 Word 6: Counts for OBCT view 1, channel H5 Word 7: Mid-pixel position for OBCT view 2 Word 8-12: Counts for OBCT view 2, channel H1-H5 (in order) Word 13: Mid-pixel position for OBCT view 3	2617	2664	u	2	24	0	counts	

Word 14-18: Counts for OBCT view 3, channel H1-H5 (in order)								
Word 19: Mid-pixel position for OBCT view 4 Word 20-24: Counts for OBCT view 4, channel H1-H5 (in order)								
<zero fill>	2665	2672	i	4	2	0		
POSITION VALIDITY FLAGS								
<i>There is one bit flag for each FOV (earth, space, and OBCT). If bit flag = 0, then mid-pixel antenna position for corresponding FOV is within its nominal range. Otherwise (if = 1), position is outside of its nominal range.</i>								
Earth View Position Validity Flags Word 1: position flags for FOVs 1-8 (bits 0-7) Word 2: position flags for FOVs 9-16 (bits 0-7) ... Word 11: position flags for FOVs 81-88 (bits 0-7) Word 12: position flags for FOVs 89-90 (bits 0-1; bits 2-7 are <zero fill>)	2673	2684	u	1	12	0		2
Space View Position Validity Flags bits 7-4: <zero fill> bit 3: position flag for space view 4 bit 2: position flag for space view 3 bit 1: position flag for space view 2 bit 0: position flag for space view 1	2685	2685	u	1	1	0		2
OBCT View Position Validity Flags bits 7-4: <zero fill> bit 3: position flag for OBCT view 4 bit 2: position flag for OBCT view 3 bit 1: position flag for OBCT view 2 bit 0: position flag for OBCT view 1	2686	2686	u	1	1	0		2
FULL HOUSEKEEPING DATA								
Mode and Sub-commutation Code bits 7-4: mode code (0=power on; 1=warm up; 2=stand by; 3=scan; 4=fixed view; 5=self test; 6=safeing; 7=fault; 8-14=<unused>; 15=memory data packet ID) bit 3: PIE ID (0=PIE A; 1=PIE B)bits 2-0: sub-commutation code (<i>only meaningful for telemetry packet data</i>)	2687	2687	u	1	1	0		
Telecomm and Acknowledgement and Fault Code <i>Words 1-2:</i> bit 15: TC clean (1=no parity or checksum error found in received packet) bit 14: TC conforms (1=header of received command conforms to the CCSDS format) bit 13: TC recognized (1=received command is a recognized MHS command of the correct format) bit 12: TC legal (1=received command is legal for execution in the current MHS operating mode) bit 11: FDM motor current trip status (1=instantaneous current in the FDM motor has exceeded a pre-set level, resulting in the disabling of the FDM motor drive circuit) bits 10-0: TC application ID (taken from the packet ID field of the primary header of the received serial command)	2688	2692	u	1	5	0		3,4

<p>Words 3-4:bits 15-2: TC packet sequence count bits 1-0: TC received count</p> <p>Word 5:bit 7: current monitor fault (1=one or more PSU current monitor parameters exceed their expected limits); see note 3</p> <p>bit 6: thermistor monitor fault (1=one or more thermistor temperature monitor parameters exceed their expected limits); see note 3</p> <p>bit 5: switch fault (1=a switch status telemetry parameter does not agree with its last commanded state, or a PROM board switch error has occurred)</p> <p>bit 4: processor fault (1=a processor internal fault has occurred (overflow, illegal address, BIT failure))</p> <p>bit 3: RDM motor current trip status (1=instantaneous current in the RDM motor has exceeded a pre-set level, resulting in the disabling of the RDM motor drive circuit)</p> <p>bit 2: DC offset error (1=one or more channel calibration target's readings indicate a change in the DC offset is required)</p> <p>bit 1: scan control error (1=the measured mid-pixel position of the reflector during earth, space, or OBCT views is outside the limits for the scan mode profile, or the reflector position is outside the limits of the requested position for fixed view mode, or the position acquisition initialization has failed); see note 4</p> <p>bit 0: REF CK error (1=scan control clock stops as a result of the platform reference clock stopping for a period of >= 2.5 ms)</p>								
<p>Switch Status</p> <p>Word 1:</p> <p>bit 7: receiver channel H4 backend (0=off; 1=on)</p> <p>bit 6: receiver channel H3 backend (0=off; 1=on)</p> <p>bit 5: receiver channel H3/H4 local oscillator selected (0=A; 1=B)</p> <p>bit 4: receiver channel H3/H4 front-end (0=off; 1=on)</p> <p>bit 3: receiver channel H2 local oscillator selected (0=A; 1=B)</p> <p>bit 2: receiver channel H2 (0=off; 1=on)</p> <p>bit 1: receiver channel H1 local oscillator selected (0=A; 1=B)</p> <p>bit 0: receiver channel H1 (0=off; 1=on)</p> <p>Word 2:</p> <p>bit 7: PROM (1=a PROM segment switch has failed ON)</p> <p>bit 6:signal processing electronics/scan control electronics (0=off; 1=on)</p> <p>bit 5: auxiliary operational heaters (0=off; 1=on)</p> <p>bit 4: scan mechanism operational heaters (0=off; 1=on)</p> <p>bit 3: receiver operational heaters (0=off; 1=on)</p> <p>bit 2: Rx CV (0=off; 1=on)</p> <p>bit 1: receiver channel H5 local oscillator selected (0=A; 1=B)</p> <p>bit 0: receiver channel H5 (0=off; 1=on)</p>	2693	2695	u	1	3	0		

<p><i>Word 3:</i> bit 7: FDM motor current trip status (0=enabled; 1=disabled) bit 6: RDM motor current trip status (0=enabled; 1=disabled) bit 5: FDM motor supply (0=off; 1=on) bit 4: RDM motor supply (0=off; 1=on) bit 3: FDM motor sensors selected (0=A; 1=B) bit 2: RDM motor sensors selected (0=A; 1=B) bit 1: FDM zero position sensors (0=A; 1=B) bit 0: RDM zero position sensors (0=A; 1=B)</p>								
<p>Temperature Data (<i>range: 0-255</i>) Word 1: LO H1 temperature Word 2: LO H2 temperature Word 3: LO H3/H4 temperature Word 4: LO H5 temperature Word 5: Mixer/LNA/Multiplexer H1 temperature Word 6: Mixer/LNA/Multiplexer H2 temperature Word 7: Mixer/LNA/Multiplexer H3/H4 temperature Word 8: Mixer/LNA/Multiplexer H5 temperature Word 9: Quasi-optics baseplate temperature #1 (dichroic D1(A) or polarizer(B)) Word 10: Quasi-optics baseplate temperature #2 (dichroic D2(A) or mirror(B)) Word 11: IF baseplate temperature #1 Word 12: IF baseplate temperature #2 Word 13: Scan mechanism core temperature Word 14: Scan mechanism housing temperature Word 15: RDM SSHM temperature Word 16: FDM SSHM temperature Word 17: Structure 1 temperature (-A edge, next to baseplate cutout) Word 18: Structure 2 temperature (-A edge, in-between Rx and SM) Word 19: Structure 3 temperature (-V edge, in-between EE and SM) Word 20: Processor module temperature Word 21: Main DC/DC converter module temperature Word 22: SCE RDM module temperature Word 23: SCE FDM module temperature Word 24: RF DC/DC converter module temperature</p>	2696	2719	u	1	24	0	counts	
<p>Raw Current Consumption Data (<i>internal PSU current analog telemetry; range: 0-255</i>) Word 1: EE and SM +5V current Word 2: receiver +8V current Word 3: receiver +15V current Word 4: receiver -15V current Word 5: RDM motor current Word 6: FDM motor current</p>	2720	2725	u	1	6	0	counts	
<zero fill>	2726	2726	i	1	1	0		
STATUS WORD								
Status Word	2727	2727	u	1	1	0		

bit 7: DC offset valid (1=all channels' calibration target's readings lie within acceptable limits) bit 6: scan control valid: only set in scan mode or fixed view mode (1=all mid-pixel positions of the reflector during earth, space, or OBCT views are within limits) bits 5-4: profile (0=profile 0--the nominal scan mode profile with nominal space view position; 1=profile 1--alternate space view position; 2=profile 2--alternate space view position; 3=no profile calculated--profile will be manually loaded and modified) bits 3-0: <unused>								
<zero fill>	2728	2734	i	1	7	0		
SIGNAL PROCESSING STATUS								
DC Offset Words (<i>range: 0-255</i>) Word 1: Channel H1 DC offset word Word 2: Channel H2 DC offset word Word 3: Channel H3 DC offset word Word 4: Channel H4 DC offset word Word 5: Channel H5 DC offset word	2735	2739	u	1	5	0	counts	
bit 7: H1 valid (1=all samples of channel H1 for this scan lie within the ADC dynamic range) bit 6: H2 valid (1=all samples of channel H2 for this scan lie within the ADC dynamic range) bit 5: H3 valid (1=all samples of channel H3 for this scan lie within the ADC dynamic range) bit 4: H4 valid (1=all samples of channel H4 for this scan lie within the ADC dynamic range) bit 3: H5 valid (1=all samples of channel H5 for this scan lie within the ADC dynamic range) bits 2-0: SPE MUX code (0=channel H1 connected to SPE 6; 1=H2 to SPE 6; 2=H3 to SPE 6; 3=SPE 6 not used; 4=H4 to SPE 6; 5=H5 to SPE 6; 6=SPE 6 not used; 7=SPE 6 not used)	2740	2740	u	1	1	0		
Channel Gain (<i>i.e., gain setting of the receiver video output channels</i>) <i>Values of 0 to 3 imply 0 db gain to 3 dB gain, respectively. Values of 4 to 7 are not used.</i> <i>Word 1:</i> bits 7-5: channel H1 gain bits 4-2: channel H2 gain bits 1-0: <unused> <i>Word 2:</i> bits 7-5: channel H3 gain bits 4-2: channel H4 gain bits 1-0: <unused> <i>Word 3:</i> bits 7-5: channel H5 gain bits 4-2: <unused> bits 1-0: <unused>	2741	2743	u	1	3	0		
<zero fill>	2744	2750	i	1	7	0		
OBCT TEMPERATURE DATA								
OBCT (PRT) Readings	2751	2760	u	2	5	0	counts	

Word 1: PRT 1 Word 2: PRT 2 Word 3: PRT 3 Word 4: PRT 4 Word 5: PRT 5								
PRT Calibration Channels Word 1: Calibration channel 1 (upper value) Word 2: Calibration channel 2 (middle value) Word 3: Calibration channel 3 (lower value)	2761	2766	u	2	3	0	counts	
<zero fill>	2767	2768	i	2	1	0		
Computed OBCT Temperatures Word 1: OBCT temperature 1 (based on PRT 1 reading) Word 2: OBCT temperature 2 (based on PRT 2 reading) Word 3: OBCT temperature 3 (based on PRT 3 reading) Word 4: OBCT temperature 4 (based on PRT 4 reading) Word 5: OBCT temperature 5 (based on PRT 5 reading)	2769	2788	u	4	5	3	K	
Science Packet Spare Words (<i>set to zero</i>)	2789	2833	u	1	45	0		
<zero fill>	2834	2834	i	1	1	0		
DISCRETE TELEMETRY <i>Equivalent to digital B and analog housekeeping telemetry in other instruments.</i>								
Main Bus Select Status (<i>indicate which main bus (A or B) is used by the MHS</i>) 1 (0V)=A bus (relay closed) 0 (5V)=B bus (relay opened)	2835	2835	u	1	1	0		1
MHS Survival Heater 1=on 0=off	2836	2836	u	1	1	0		1
RF Converter Protect Disable 1=no 0=yes	2837	2837	u	1	1	0		1
MHS Power A 1=on 0=off	2838	2838	u	1	1	0		1
MHS Power B 1=on 0=off	2839	2839	u	1	1	0		1
Main Converter Protect Disable 1=no 0=yes	2840	2840	u	1	1	0		1
Survival Temperatures Word 1: Receiver temperature Word 2: Electronics equipment temperature Word 3: Scan mechanism temperature	2841	2846	u	2	3	0	counts	1

Transmitter Telemetry Word 1: STX-1 status Word 2: STX-2 status Word 3: STX-3 status Word 4: STX-4 status Word 5: STX-1 power Word 6: STX-2 power Word 7: STX-3 power Word 8: SARR-A power Word 9: SARR-B power	2847	2864	u	2	9	0	counts	1
Discrete Telemetry Update Flags (<i>If bit = 0, associated telemetry item is up-to-date. If bit = 1, associated telemetry item was not updated during most recent telemetry cycle - possibly due to lost frame.</i>) bits 31-18: <zero fill> bit 17: SARR-B power bit 16: SARR-A power bit 15: STX-3 power bit 14: STX-2 power bit 13: STX-1 power bit 12: STX-4 status bit 11: STX-3 status bit 10: STX-2 status bit 9: STX-1 status bit 8: Scan mechanism temperature bit 7: Electronics equipment temperature bit 6: Receiver temperature bit 5: Main converter protect disable bit 4: MHS power B bit 3: MHS power A bit 2: RF converter protect disable bit 1: MHS survival heater bit 0: Main bus select status	2865	2868	u	1	4	0		1
FILLER								
<zero fill>	2869	3072	i	2	102	0		

NOTES:

1. The MHS Level 1b data will not contain any MIU related analog or digital B telemetry items from the NOAA data stream. These items will be archived in a separate NOAA telemetry file.
2. To determine the word location and bit location within the word of a particular FOV's validity flag, use the following equations:
word = truncate((FOV - 1) / 8) + 1; bit = (FOV - 1) mod 8
For example, FOV 64's validity flag is located in bit 7 of word 8, computed as follows : word = truncate (64 - 1) / 8) + 1 = truncate (63 / 8) + 1 = truncate (7.875) + 1 = 7 + 1 = 8; bit = (64 - 1) mod 8 = 63 mod 8 = 7.
3. The limits are defined in the Telemetry Limits Table, which is loaded into the instrument's memory. This table can be found in Appendix B of *MHS TM-TC and Science Data Format Directory*, and in Table 3.2.2.2.9-3 of *MHS Instrument ICD*. There are two levels of limits: "warning" limits and "fault" limits. If a telemetry item goes outside of the "warning" limits, then this bit is set. If the telemetry item goes outside of the "fault" limits, then an error flag is raised in the "fault code" field and the instrument switches to "fault" mode.
4. This bit is related to the Earth/Space/OBCT View Position Validity Flags. It is set by the instrument and comes in the data stream. The Position Validity Flags are set by the preprocessor. If this bit is set, then at least one bit of the Position Validity Flags should be set also.

8.3.1.9.3.2

Extended Test Data Packet

The MHS Level 1b Record Format (Extended Test Data Packet) is documented in Table 8.3.1.9.3-2. See the legend in Section 8.3.1.1 for further explanation of the headings on this table.

Table 8.3.1.9.3.2-1. Format of MHS Level 1b Record (Extended Test Data Packet).								
Field Name	Start Octet	End Octet	Data Type	Word Size	Number of Words	Scale Factor	Units	Notes
SCAN LINE INFORMATION								
Scan Line Number (<i>cumulative, starting with 1</i>)	1	2	u	2	1	0		
Scan Line Year (<i>four digits, e.g., 2000</i>)	3	4	u	2	1	0		
Scan Line Day of Year (<i>e.g., 365</i>)	5	6	u	2	1	0		
Satellite Clock Drift Delta	7	8	i	2	1	0	msec	
Scan Line UTC Time of Day	9	12	u	4	1	0	msec	
Scan Line Bit Field bit 15: satellite direction (0=northbound; 1=southbound) bit 14: clock drift correction (0=not corrected; 1=scan time corrected for clock drift)bits 13-0: <zero fill>	13	14	u	2	1	0		
Major Frame Count (<i>cumulative, starting with 1</i>)	15	16	u	2	1	0		
Coarse MHS On-board Time (OBT) (<i>time since last reset to zero</i>)	17	20	u	4	1	0	seconds	
Fine MHS OBT (<i>fraction of second since last increment of coarse MHS OBT. Resolution: 2⁻¹⁶ seconds; range: 0 - 65,535.</i>)	21	22	u	2	1	0		
MHS Mode Flag 0=power-on ("empty" MHS science data) 1=warm-up ("empty" MHS science data) 2=Standby ("empty" MHS science data) 3=scan (valid MHS science data) 4=fixed view (valid MHS science data, but instrument is viewing a fixed location) 5=self test (test data) 6=safeing ("empty" MHS science data) 7=fault ("empty" MHS science data) 8-14=<undefined> (unknown data) 15=memory dump (memory dump data) <zero fill>	23	23	u	1	1	0		
	24	24	i	1	1	0		
QUALITY INDICATORS								
Quality Indicator Bit Field (<i>if a bit is on (=1), the statement is true</i>) bit 31: do not use scan for product generation bit 30: time sequence error detected within this scan (see below) bit 29: data gap precedes this scan (gap may be due to actual lost scans or scans in which the TIP or MIU are in non-nominal modes)	25	28	u	4	1	0		2

bit 28: insufficient data for calibration (see below) bit 27: earth location data not available (see below) bit 26: first good time following a clock update (nominally 0) bit 25: instrument status changed with this scan bits 24 - 5: <zero fill> bit 4: transmitter status change occurred (see note 2) bit 3: AMSU sync error detected bit 2: AMSU minor frame error detected bit 1: AMSU major frame error detected bit 0: AMSU parity error detected Scan Line Quality Flags [Time Problem Code] (<i>If a bit is on (=1), the statement is true. All bits off implies the scan time is as expected.</i>) bit 7: time field is bad but can probably be inferred from the previous good time bit 6: time field is bad and can't be inferred from the previous good time bit 5: this record starts a sequence that is inconsistent with previous times (i.e., there is a time discontinuity). This may be associated with a spacecraft clock update. (See bit 26, Quality Indicator Bit Field.) bit 4: start of a sequence that apparently repeats scan times that have been previously accepted bits 3-0: <zero fill>								
Scan Line Quality Flags [Time Problem Code] (<i>If a bit is on (=1), the statement is true. All bits off implies the scan time is as expected.</i>) bit 7: time field is bad but can probably be inferred from the previous good time bit 6: time field is bad and can't be inferred from the previous good time bit 5: this record starts a sequence that is inconsistent with previous times (i.e., there is a time discontinuity). This may be associated with a spacecraft clock update. (See bit 26, Quality Indicator Bit Field.) bit 4: start of a sequence that apparently repeats scan times that have been previously accepted bits 3-0: <zero fill>	29	29	u	1	1	0		
<zero fill>	30	1480	i	1	1451	0		
EXTENDED TEST DATA PACKET								
Mode Code/PIE ID/Self-Test Code bits 7-4: mode code (5=self test) bit 3: PIE ID (0=PIE A; 1=PIE B) bits 2-0: self-test code	1481	1481	u	1	1	0		
Unused (<i>set to zero</i>)	1482	1519	u	1	38	0		

Extended Test Data	1520	2766	u	1	1247	0	3
<zero fill>	2767	2834	i	2	34	0	
DISCRETE TELEMETRY <i>Equivalent to digital B and analog housekeeping telemetry in other instruments.</i>							
Main Bus Select Status (<i>indicate which main bus (A or B) is used by the MHS</i>) 1 (0V)=A bus (relay closed) 0 (5V)=B bus (relay opened)	2835	2835	u	1	1	0	1
MHS Survival Heater	2836	2836	u	1	1	0	1
1=on 0=off							
RF Converter Protect Disable 1=no 0=yes	2837	2837	u	1	1	0	1
MHS Power A 1=on 0=off	2838	2838	u	1	1	0	1
MHS Power B 1=on 0=off	2839	2839	u	1	1	0	1
Main Converter Protect Disable 1=no 0=yes	2840	2840	u	1	1	0	1
Survival Temperatures Word 1: Receiver temperature Word 2: Electronics equipment temperature Word 3: Scan mechanism temperature	2841	2846	u	2	3	0counts	1
Transmitter Telemetry Word 1: STX-1 status Word 2: STX-2 status Word 3: STX-3 status Word 4: STX-4 status Word 5: STX-1 power Word 6: STX-2 power Word 7: STX-3 power Word 8: SARR-A power Word 9: SARR-B power	2847	2864	u	2	9	0counts	1
Discrete Telemetry Update Flags (<i>If bit = 0, associated telemetry item is up-to-date. If bit = 1, associated telemetry item was not updated during most recent telemetry cycle - possibly due to lost frame.</i>)	2865	2868	u	1	4	0	1
bits 31-18: <zero fill> bit 17: SARR-B power bit 16: SARR-A power bit 15: STX-3 power bit 14: STX-2 power bit 13: STX-1 power bit 12: STX-4 status							

bit 11: STX-3 status								
bit 10: STX-2 status								
bit 9: STX-1 status								
bit 8: Scan mechanism temperature								
bit 7: Electronics equipment temperature								
bit 6: Receiver temperature								
bit 5: Main converter protect disable								
bit 4: MHS power B								
bit 3: MHS power A								
bit 2: RF converter protect disable								
bit 1: MHS survival heater								
bit 0: Main bus select status								
FILLER								
<zero fill>	2869	3072	i	2	102	0		
NOTES:								
1. The MHS Level 1b will not contain any MIU-related analog or digital B telemetry items from the NOAA data stream. These items will be archived in a separate NOAA telemetry file.								
2. The RFI bias correction data is based on experience with the AMSU-B instrument from the NOAA KLM series of satellites. While it may not be necessary, it is being left in the MHS Level 1b format. Until a determination is made that it is necessary, it will be zero filled.								
3. Refer to Section 4.3.2.3 of <i>MHS TM-TC and Science Data Format Directory</i> for a detailed description of the content of this field.								

8.3.1.9.3.3 Extended Memory Data Packet

The MHS Level 1b Record Format (Extended Memory Data Packet) is documented in Table 8.3.1.9.3.3-1. See the legend in Section 8.3.1.1 for further explanation of the headings on this table.

Table 8.3.1.9.3.3-1. Format of MHS Level 1b Record (Extended Memory Data Packet).								
Field Name	Start Octet	End Octet	Data Type	Word Size	Number of Words	Scale Factor	Units	Notes
SCAN LINE INFORMATION								
Scan Line Number (<i>cumulative, starting with 1</i>)	1	2	u	2	1	0		
Scan Line Year (<i>four digits, e.g., 2000</i>)	3	4	u	2	1	0		
Scan Line Day of Year (<i>e.g., 365</i>)	5	6	u	2	1	0		
Satellite Clock Drift Delta	7	8	i	2	1	0	msec	
Scan Line UTC Time of Day	9	12	u	4	1	0	msec	
Scan Line Bit Field bit 15: satellite direction (0=northbound; 1=southbound) bit 14: clock drift correction (0=not corrected; 1=scan time corrected for clock drift) bits 13-0: <zero fill>	13	14	u	2	1	0		

Major Frame Count (<i>cumulative, starting with 1</i>)	15	16	u	2	1	0		
Coarse MHS On-board Time (OBT) (<i>time since last reset to zero</i>)	17	20	u	4	1	0	seconds	
Fine MHS OBT (<i>fraction of second since last increment of coarse MHS OBT. Resolution: 2⁻¹⁶ seconds; range: 0 - 65,535.</i>)	21	22	u	2	1	0		
MHS Mode Flag 0=power-on ("empty" MHS science data) 1=warm-up ("empty" MHS science data) 2=Standby ("empty" MHS science data) 3=scan (valid MHS science data) 4=fixed view (valid MHS science data, but instrument is viewing a fixed location) 5=self test (test data) 6=safeing ("empty" MHS science data) 7=fault ("empty" MHS science data) 8-14=<undefined> (unknown data) 15=memory dump (memory dump data)	23	23	u	1	1	0		
<zero fill>	24	24	i	1	1	0		
QUALITY INDICATORS								
Quality Indicator Bit Field (<i>if a bit is on (=1), the statement is true</i>) bit 31: do not use scan for product generation bit 30: time sequence error detected within this scan (see below) bit 29: data gap precedes this scan (gap may be due to actual lost scans or scans in which the TIP or MIU are in non-nominal modes) bit 28: insufficient data for calibration (see below) bit 27: earth location data not available (see below) bit 26: first good time following a clock update (nominally 0) bit 25: instrument status changed with this scan bits 24 - 5: <zero fill> bit 4: transmitter status change occurred (see note 2) bit 3: AMSU sync error detected bit 2: AMSU minor frame error detected bit 1: AMSU major frame error detected bit 0: AMSU parity error detected	25	28	u	4	1	0		2
Scan Line Quality Flags [Time Problem Code] (<i>If a bit is on (=1), the statement</i>	29	29	u	1	1	0		

is true. All bits off implies the scan time is as expected.) bit 7: time field is bad but can probably be inferred from the previous good time bit 6: time field is bad and can't be inferred from the previous good time bit 5: this record starts a sequence that is inconsistent with previous times (i.e., there is a time discontinuity). This may be associated with a spacecraft clock update. (See bit 26, Quality Indicator Bit Field.) bit 4: start of a sequence that apparently repeats scan times that have been previously accepted bits 3-0: <zero fill>								
<zero fill>	30	1480	i	1	1451	0		
EXTENDED MEMORY DATA PACKET								
Packet ID/PIE ID bits 7-4: packet ID (15=memory data packet) bit 3: PIE ID (0=PIE A; 1=PIE B) bits 2-0: unused (undefined)	1481	1481	u	1	1	0		
Start Address (<i>where, word 1 is the most significant byte of address and word 3 is the least significant byte</i>)	1482	1484	u	1	3	0		
Data Words	1485	2508	u	2	512	0		
<zero fill>	2509	2834	i	2	163	0		
DISCRETE TELEMETRY								
<i>Equivalent to digital B and analog housekeeping telemetry in other instruments.</i>								
Main Bus Select Status (<i>indicate which main bus (A or B) is used by the MHS</i>) 1 (0V)=A bus (relay closed) 0 (5V)=B bus (relay opened)	2835	2835	u	1	1	0		1
MHS Survival Heater 1=on 0=off	2836	2836	u	1	1	0		1
RF Converter Protect Disable 1=no 0=yes	2837	2837	u	1	1	0		1
MHS Power A 1=on 0=off	2838	2838	u	1	1	0		1
MHS Power B 1=on 0=off	2839	2839	u	1	1	0		1
Main Converter Protect Disable 1=no 0=yes	2840	2840	u	1	1	0		1
Survival Temperatures	2841	2846	u	2	3	0	counts	1

Word 1: Receiver temperature Word 2: Electronics equipment temperature Word 3: Scan mechanism temperature								
Transmitter Telemetry Word 1: STX-1 status Word 2: STX-2 status Word 3: STX-3 status Word 4: STX-4 status Word 5: STX-1 power Word 6: STX-2 power Word 7: STX-3 power Word 8: SARR-A power Word 9: SARR-B power	2847	2864	u	2	9	0	counts	1
Discrete Telemetry Update Flags (<i>If bit = 0, associated telemetry item is up-to-date. If bit = 1, associated telemetry item was not updated during most recent telemetry cycle - possibly due to lost frame.</i>) bits 31-18: <zero fill> bit 17: SARR-B power bit 16: SARR-A power bit 15: STX-3 power bit 14: STX-2 power bit 13: STX-1 power bit 12: STX-4 status bit 11: STX-3 status bit 10: STX-2 status bit 9: STX-1 status bit 8: Scan mechanism temperature bit 7: Electronics equipment temperature bit 6: Receiver temperature bit 5: Main converter protect disable bit 4: MHS power B bit 3: MHS power A bit 2: RF converter protect disable bit 1: MHS survival heater bit 0: Main bus select status	2865	2868	u	1	4	0		1
FILLER								
<zero fill>	2869	3072	i	2	102	0		
NOTES:								
<p>1. The MHS Level 1b will not contain any MIU-related analog or digital B telemetry items from the NOAA data stream. These items will be archived in a separate NOAA telemetry file.</p> <p>2. The RFI bias correction data is based on experience with the AMSU-B instrument from the NOAA KLM series of satellites. While it may not be necessary, it is being left in the MHS Level 1b format. Until a determination is made that it is necessary, it will be zero filled.</p> <p>3. Refer to Section 4.3.2.2 of <i>MHS TM-TC and Science Data Format Directory</i> for a detailed description of the content of this field.</p>								

8.3.1.9.3.4 Unknown Packet

If the mode code in the MHS data stream is missing or corrupt, the mode of the instrument (and therefore the type of packet) is unknown. If this is the case, the packet data is placed into this field without modification. The MHS unknown packet is documented in Table 8.3.1.9.3.4-1. See the legend in Section 8.3.1.1 for further explanation of the headings on this table.

Table 8.3.1.9.3.4-1. Format of MHS Level 1b Record (Unknown Packet).								
Field Name	Start Octet	End Octet	Data Type	Word Size	Number of Words	Scale Factor	Units	Notes
SCAN LINE INFORMATION								
Scan Line Number (<i>cumulative, starting with 1</i>)	1	2	u	2	1	0		
Scan Line Year (<i>four digits, e.g., 2000</i>)	3	4	u	2	1	0		
Scan Line Day of Year (<i>e.g., 365</i>)	5	6	u	2	1	0		
Satellite Clock Drift Delta	7	8	i	2	1	0	msec	
Scan Line UTC Time of Day	9	12	u	4	1	0	msec	
Scan Line Bit Field bit 15: satellite direction (0=northbound; 1=southbound) bit 14: clock drift correction (0=not corrected; 1=scan time corrected for clock drift) bits 13-0: <zero fill>	13	14	u	2	1	0		
Major Frame Count (<i>cumulative, starting with 1</i>)	15	16	u	2	1	0		
Coarse MHS On-board Time (OBT) (<i>time since last reset to zero</i>)	17	20	u	4	1	0	seconds	
Fine MHS OBT (<i>fraction of second since last increment of coarse MHS OBT. Resolution: 2⁻¹⁶ seconds; range: 0 - 65,535.</i>)	21	22	u	2	1	0		
MHS Mode Flag 0=power-on ("empty" MHS science data) 1=warm-up ("empty" MHS science data) 2=Standby ("empty" MHS science data) 3=scan (valid MHS science data) 4=fixed view (valid MHS science data, but instrument is viewing a fixed location) 5=self test (test data) 6=safeing ("empty" MHS science data) 7=fault ("empty" MHS science data) 8-14=<undefined> (unknown data) 15=memory dump (memory dump data)	23	23	u	1	1	0		
<zero fill>	24	24	i	1	1	0		

QUALITY INDICATORS							
Quality Indicator Bit Field (<i>if a bit is on (=1), the statement is true</i>) bit 31: do not use scan for product generation bit 30: time sequence error detected within this scan (see below) bit 29: data gap precedes this scan (gap may be due to actual lost scans or scans in which the TIP or MIU are in non-nominal modes) bit 28: insufficient data for calibration (see below) bit 27: earth location data not available (see below) bit 26: first good time following a clock update (nominally 0) bit 25: instrument status changed with this scan bits 24 - 5: <zero fill> bit 4: transmitter status change occurred (see note 2) bit 3: AMSU sync error detected bit 2: AMSU minor frame error detected bit 1: AMSU major frame error detected bit 0: AMSU parity error detected	25	28	u	4	1	0	2
Scan Line Quality Flags [Time Problem Code] (<i>If a bit is on (=1), the statement is true. All bits off implies the scan time is as expected.</i>) bit 7: time field is bad but can probably be inferred from the previous good time bit 6: time field is bad and can't be inferred from the previous good time bit 5: this record starts a sequence that is inconsistent with previous times (i.e., there is a time discontinuity). This may be associated with a spacecraft clock update. (See bit 26, Quality Indicator Bit Field.) bit 4: start of a sequence that apparently repeats scan times that have been previously accepted bits 3-0: <zero fill>	29	29	u	1	1	0	
<zero fill>	30	1480	i	1	1451	0	
UNKNOWN PACKET DATA							
Packet Data	1481	2766	u	1	1286	0	3
<zero fill>	2767	2834	i	2	34	0	
DISCRETE TELEMETRY <i>Equivalent to digital B and analog housekeeping telemetry in other instruments.</i>							

Main Bus Select Status (<i>indicate which main bus (A or B) is used by the MHS</i>) 1 (0V)=A bus (relay closed) 0 (5V)=B bus (relay opened)	2835	2835	u	1	1	0		1
MHS Survival Heater 1=on 0=off	2836	2836	u	1	1	0		1
RF Converter Protect Disable 1=no 0=yes	2837	2837	u	1	1	0		1
MHS Power A 1=on 0=off	2838	2838	u	1	1	0		1
MHS Power B 1=on 0=off	2839	2839	u	1	1	0		1
Main Converter Protect Disable 1=no 0=yes	2840	2840	u	1	1	0		1
Survival Temperatures Word 1: Receiver temperature Word 2: Electronics equipment temperature Word 3: Scan mechanism temperature	2841	2846	u	2	3	0	counts	1
Transmitter Telemetry Word 1: STX-1 status Word 2: STX-2 status Word 3: STX-3 status Word 4: STX-4 status Word 5: STX-1 power Word 6: STX-2 power Word 7: STX-3 power Word 8: SARR-A power Word 9: SARR-B power	2847	2864	u	2	9	0	counts	1
Discrete Telemetry Update Flags (<i>If bit = 0, associated telemetry item is up-to-date. If bit = 1, associated telemetry item was not updated during most recent telemetry cycle - possibly due to lost frame.</i>) bits 31-18: <zero fill> bit 17: SARR-B power bit 16: SARR-A power bit 15: STX-3 power bit 14: STX-2 power bit 13: STX-1 power bit 12: STX-4 status bit 11: STX-3 status bit 10: STX-2 status bit 9: STX-1 status	2865	2868	u	1	4	0		1

bit 8: Scan mechanism temperature								
bit 7: Electronics equipment temperature								
bit 6: Receiver temperature								
bit 5: Main converter protect disable								
bit 4: MHS power B								
bit 3: MHS power A bit 2: RF converter protect disable								
bit 1: MHS survival heater								
bit 0: Main bus select status								
FILLER								
<zero fill>	2869	3072	i	2	102	0		
NOTES:								
<p>1. The MHS Level 1b will not contain any MIU-related analog or digital B telemetry items from the NOAA data stream. These items will be archived in a separate NOAA telemetry file.</p> <p>2. The RFI bias correction data is based on experience with the AMSU-B instrument from the NOAA KLM series of satellites. While it may not be necessary, it is being left in the MHS Level 1b format. Until a determination is made that it is necessary, it will be zero filled.</p> <p>3. The mode of the instrument and therefore the type of packet is unknown if the mode code in the data stream is either missing (due to a missing minor frame, for example) or corrupt (i.e., set to one of the "unused" values). In the event of an unknown mode/packet, the packet data is placed into this field without modification.</p>								

9.0 NESDIS OPERATIONAL PRODUCTS

Please note that this section is outdated. For the latest information and access to NESDIS operational products please go to <http://www.nesdis.noaa.gov/>.

The following products are generated from the NOAA KLM Level 1b data and are further described in this section:

- Sea Surface Temperature (SST) Products
- Mapped GAC Products
- Radiation Budget Products
- Sounding Products
- CoastWatch Products
- Snow and Ice Products
- Ozone (SBUV/2) Products
- Aerosol/Optical Thickness Products
- Comprehensive Large Array-data Stewardship System (CLASS)

9.1 SEA SURFACE TEMPERATURE (SST) PRODUCTS

NOAA/NESDIS produces and archives two types of SST products, gridded products and geographically organized retrievals. In addition, through an agreement under the NOAA/DOD Shared Processing Program, NESDIS receives and archives global Sea Surface Temperature retrievals from the Naval Oceanographic Office at Stennis Space Center, Mississippi. Both the NESDIS and Navy retrieval Archive cartridges contain eight days of 8-km resolution SST observations from a current operational NOAA polar orbiter (normally the afternoon spacecraft). All gridded products are produced from the 8-km resolution observations. Monthly archives are produced for all the gridded products. They include daily 100-km (Global-Scale Analysis), bi-weekly 50 km (Regional Scale Analysis), and biweekly 14 km (Local Scale) gridded SST fields. Monthly means are also produced from the observations on a 250-km grid (SST Monthly Mean) and archived yearly.

Any queries regarding SST products should be directed to:

National Climatic Data Center
Climate Services Division
151 Patton Avenue
Asheville, NC 28801-5001
email: NCDC.satorder@noaa.gov

The 14-km gridded, 50-km gridded, and 100-km gridded SST fields are generated by NESDIS in the SST Field Format which is described in Section 9.1.1. Section 9.1.2 describes the SST

Observation File and the SST Monthly Mean is described in Section 9.1.3.

Most SST archive cartridges contain a Header File which will usually be the first file on the cartridge. The Header File consists of one 400-byte physical record which contains some of the information shown in Table 9.1-1.

Table 9.1-1. Format of the SST Header File			
Word #	# Bytes	Content	Range
1-20	80	Title of data set archived in File 2 of this cartridge	1-80 characters with blank fill
21-27	28	Data set name of disk data set	1-28 characters with blank fill
28-29	8	Original archive cartridge number	1-8 characters with blank fill
Date of earliest data on cartridge:			
30	1	Year	0-99
	1	Month	1-12
	1	Day	1-31
	1	Blank	
Date of most current data on cartridge:			
31	1	Year	0-99
	1	Month	1-12
	1	Day	1-31
	1	Blank	
Date and time when data was archived from disk to cartridge:			
32	4	Year	0-99
33	4	Month	1-12
34	4	Day	1-31
35	4	Hour	0-23

36	4	Minute	0-59
37	4	Second	0-59
38	4	Number of records of data in File 2 of cartridge	n/a
39	4	Number of files of data on the cartridge (not counting Header file)	n/a
40-100	244	Spare	n/a

9.1.1 SST FIELD FORMAT

All of the SST Field products including the 14-km gridded (0.125 degree), 50-km gridded (0.5 degree), and 100-km gridded (1 degree) are derived from the basic 8-km SST observations. An SST Field consists of a specific set of information pertaining to latitude and longitude intersections. The Global-Scale (1 degree resolution) file includes the area from 180W to 179E longitude and from -70S to 70N latitude and is generated daily. The regional scale (0.5 degree) and local scale (0.125 degree) fields are generated twice weekly. All the fields are generated by analyzing all the SST observations obtained during the period since the last analysis.

As mentioned in the previous section, most SST archive cartridges contain a header file which is usually the first file on the cartridge. The remaining files on the cartridge are field accumulation files.

Before September 2001, all field accumulation files (regardless of resolution) consisted of a Directory Record followed by some number of fields. For field data after September 2001, the individual fields are no longer stored in accumulation files. Therefore, the field accumulation Directory Record was eliminated, and multiple field files are no longer bundled into one big file. Field files are now archived as individual fields and thus the rest of the format (field documentation record and field data records) remains the same. Each field consists of a Field Documentation Record, followed by a Field Data Record for each latitude row in the field. The accumulation file Directory Record (which exists prior to September 2001 only) includes, among other things, the starting record number (i.e., the record number of the Field Documentation Record) for each field in the accumulation file. Details of the Directory Record, Field Documentation Record and Field Data Records are contained in Sections 9.1.1.1, 9.1.1.2 and 9.1.1.3, respectively. Data records (latitude rows) in the fields are ordered from south to north.

The fields will generally be arranged in chronological order. A field for a particular time period may be missing or repeated so one should examine the Field Documentation Record for each field in the file to find that field spanning the time of interest. The Field Documentation Record (the first record of each field) should be used in referencing the data records for the field, since it

provides information concerning the organization, size, and time period of the field.

After the Directory Record, there are NFIELDS fields. The first record of each field is a Field Documentation Record which is followed by NRECS Field Data Records, one for each latitudinal row in the field. Each row (logical record) consists of 28 bytes of information for each longitude or column forming a grid intersection, plus 28 bytes at the end of the record (the Latitudinal Row Identifier) containing the row number identification and the date and time of the last analysis made for the field.

The 100-km SST field cartridge is generated monthly (on the second day of the month). The cartridge contains two files: File 1 is the Header File (Table 9.1-1). File 2 is the 100-km SST field accumulation file. In File 2, after the Directory Record, there are 35 fields, 142 logical records per field. These fields are produced daily. Each field contains the Field Documentation Record followed by 141 Field Data Records, one for each 1 degree latitudinal row from -70S to 70N. There are 360 grid intersections in each row, one for each 1 degree of longitude from -180 W eastward to 179E. Each Field Data Record (logical record) contains 10,108 bytes ((360 x 28) + 28 for row identification).

The 50 km gridded SST field accumulation files are archived to cartridge once a month (on the second day of each month) for the previous month. File 1 is a Header File (Table 9.1-1), while files 2-6 contain the field accumulation files for regions 1 through 5 respectively (one geographic region per file). Each field accumulation file contains 10 fields. These fields are produced twice a week by analyzing all the SST observations obtained since the last analysis. The five regions are defined as follows:

Region 1:	5N through 53N latitude -100W through -52W longitude
Region 2:	15N through 63N latitude -145W through -97W longitude
Region 3:	15N through 63N latitude +170E through -142W longitude
Region 4:	-35S through 20N latitude -150W through -70W longitude
Region 5:	-35S through 20N latitude +155E through -145W longitude

The 14-km (0.125 degree) gridded SST fields (Local-Scale Analyses) are archived monthly on two cartridges. There are eight 0.125 degree resolution fields which cover the following areas:

Region 2:	18N through 31N latitude -98W through -80W longitude
Region 4:	39N through 52N latitude -136W through -123W longitude
Region 5:	28N through 41N latitude +155E through -145W longitude
Region 6:	30N through 36N latitude -82W through -60W longitude
Region 7:	18N through 32N latitude -85W through -70W longitude
Region 10:	50N through 62N latitude (Seasonal) -160W through -126W longitude
Region 11:	50N through 70N latitude (Seasonal) -180W through -157W longitude
Region 12:	20N through 32N latitude -136W through -105W longitude

The first cartridge of the 14-km gridded SST field data contains Regions 2, 4, 5, 6, and 7 which cover the Gulf of Mexico, Northwest Pacific coast, Southwest Pacific coast, Northeast Atlantic coast, and Southeast Atlantic coast, respectively. This cartridge contains six files, the first file being the Header File. Files two through six contain the 14-km field accumulation files for Regions 2,4,5,6, and 7, respectively. Each accumulation file contains twelve fields (2 per week) ordered chronologically.

The second cartridge of the 14-km gridded SST data contains Regions 10, 11 and 12 which cover the Gulf of Alaska, Bering Sea and the Gulf of California, respectively. This cartridge contains four files, the first file being the Header File (Table 9.1-1). The second, third and fourth files contain the 14-km field accumulation files for Regions 10, 11 and 12, respectively. Each accumulation file contains twelve fields (2 per week) ordered chronologically.

Beginning with data from NOAA-16 on February 21, 2001, a new 14-km SST Field encompasses all but Regions 10 and 11, listed above. This is considered the new North American field (14 km NA ETA Field). This region corresponds to the ETA model's grid for North America and should be very useful for modeling and Climatological purposes. The region itself consists of an area that extends from 15N to 60N and 50W to 140W. This field is produced

on odd days of the year by analyzing all the SST observations obtained in the previous two days. The 14 km NA ETA Field contains 18 files organized chronologically. The first physical record of the file is a directory record pointing to the beginning of each of the 18 fields. Each field of the file contains $1 + (18 \times 361) = 6499$ logical records blocked into 6499 physical records in the file.

The original SST field formats were not Year 2000 (Y2K) compliant, but have been changed to meet the four-digit year requirement. These changes are noted in the appropriate locations in the format records.

Starting with data generated on or about September 2, 2001, all the field accumulation files will be discontinued. They will be replaced by individual field data files (as opposed to bundling several fields' files into accumulation files). Specifically: the 100-km field accumulation file that is archived monthly will be replaced by a 100-km field file archived daily; the 50-km field accumulation Regional files that are archived monthly will be replaced by the new 50-km global field file which will be archived twice weekly; the 14-km field accumulation data for Regions 10 and 11 that are archived monthly will be replaced by 14-km field data including a new Hawaii region (between 10N and 30N latitude and 170W and 150W longitude) archived twice weekly; and the 14-km field accumulation data for Region 12 that are archived monthly will be replaced (encompassed) by 14-km field data archived every 48 hours or on all odd Julian days.

9.1.1.1 Directory Record Format

A Directory Record is always the first record of each SST Field Accumulation File (not counting the Header File and for data generated after September 2001 which are not accumulation files but are individual field files). It has a variable length with zero fill to the logical record size of the type of field, and serves as a pointer to the beginning of each field. Table 9.1.1.1-1 contains the format of the Directory Record.

Table 9.1.1.1-1. Format of the Directory Record for any SST Field Accumulation File.	
Full Word #	Content
1	Number of records in the data set
2	Number of records in each field (NRECS)
3	Number of fields in the accumulation file (NFIELDSD)
4	Field number of latest field entered in accumulation file
5	Record number of first record of Field #1
6	Record number of first record of Field #2

...	...
4+NFIELDS	Record number of first record of Field #NFIELDS

9.1.1.2 Field Documentation Record Format

The format of the Field Documentation Record is described in this section. There are 158 words of information in the Field Documentation Record with blank fill to the end of the logical record (logical record size is dependent on number of longitude columns in the field). The minimum size is 158 words (632 bytes) and the maximum size is 2,527 words (10,108 bytes). Table 9.1.1.2-1 contains the format (where R or I indicate real or integer words, respectively) of the Field Documentation Record.

Unfortunately, the SST fields were developed when the format for IBM real numbers were thought to be the standard. Many platforms cannot read IBM real numbers and so the following variables in the Field Documentation Record: SMGLAT, AXLAT, SMLONG, ASLONG, RES, SMHOUR, HOURS, TIMGAP, SMREL, AXREL, SORC, OBTYPE, GRDWTS, MKM, H, EXP, FDX, XCLASS, DEL, BDEL and FCWT (defined in Table 9.1.1.2-1) will be unavailable without conversions. The values of the most used parameters for the 14 km NA ETA field are listed specifically in Table 9.1.1.2-1. The general user will not need the rest of the values, but for the advanced user a conversion program from IBM real numbers to IEEE real numbers is included in Appendix N.

Table 9.1.1.2-1. Format of the Field Documentation Record.			
Word #	Parameter	R or I	Description
1	LDBGN	I	Record number of the first row of the field (currently 2 for all fields since the documentation record requires only one record).
2	SMGLAT	R	Minimum latitude included in field which is the bottom edge and first row of field (-South; + North). 15.0 for 14 km NA ETA field.
3	AXLAT	R	Maximum latitude included in field which is the top edge and last row of field (-South; + North). 60.0 for 14 km NA ETA field.
4	SMLONG	R	Minimum longitude included in field which is the left edge and first column of field (-West; + East). -140.0 for 14 km NA ETA field.

5	AXLONG	R	Maximum longitude included in field which is the right edge and last column of field (excluding the I.D. column) (-West; +East). -50.0 for 14 km NA ETA field.
6	RES	R	Number of latitude-longitude degrees between each grid point. 0.125 for 14 km NA ETA field.
7	SMHOUR	R	Youngest time, in hours of the year, of observations used during last analysis, which becomes the oldest time allowed for the next analysis.
8	HOURS	R	Oldest time, in hours of the year, of observations used during last analysis.
9	TIMGAP	R	Number of hours between youngest and oldest times of observations used in analysis.
10	MAXDAT	I	Maximum number of hours allowed in time period for observation times to be included in analysis.
11	SMREL	R	Minimum reliability of observations to be used in analysis.
12	AXREL	R	Maximum reliability of observations to be used in analysis.
13-22	SORC(10)	R	List of source codes of observations to be used in analysis. (See Table 9.1.2-5)
23-32	OBTYPE (10)	R	List of observation types allowed to be used in analysis. (See Table 9.1.2-4)
33	NROWS	I	Number of rows (latitudinal parallels) included in field, excluding documentation record.
34	NCOLS	I	Number of columns (longitudinal meridians) in field, including the I.D. column.
35	IBLK	I	Number of rows or logical records per physical block.
36	NWRDS	I	Number of full words (32 bits) allocated to each grid point.
37	ISZ	I	Number of rows to be maintained in an array in core for temperature analysis and calculation of gradients.
38	ICENT	I	Center line within the array of ISZ rows upon which calculations will be performed.

39-41	LWT, LNT, LBT	I	Word number, length in bits, and starting bit location of analysis temperature within a grid intersection information unit of an SST field.
42-44	LWG, LNG,LBG	I	Word number, length in bits, and starting bit location of average gradient.
45-47	LWGXP, LNGXP, LBGXP	I	Word number, length in bits, and starting LBGXP bit location of gradient X+ direction.
48-50	LWGYN, LNGYN, LBGYN	I	Word number, length of bits, and starting LBGYN bit location of gradient X- direction.
51-53	LWGYP, LNGYP, LBGYP	I	Word number, length in bits, and starting LBGYP bit location of gradient Y+ direction.
54-56	LWGYN, LNGYN, LBGYN	I	Word number, length in bits, and starting LBGYN bit location of gradient Y- direction.
57-59	LWPD, LNPB, LBPB	I	Word number, length in bits, and starting LBPB bit location of Physiographic Description.
60-62	LWNO, LNN, OLBNO	I	Word number, length in bits, and starting LBNO bit location of Number Observations.
63-65	LWAGE, LNAGE, LBAGE	I	Word number, length in bits, and starting LBAGE bit location of Age of most Recent Observations.
66-68	LWREL, LNREL, LBREL	I	Word number, length in bits, and starting LBREL bit location of Reliability.
69-71	LWCLS, LNCLS, LBCLS	I	Word number, length in bits, and starting LBCLS bit location of Class 1 coverage.

72-74	LWSXP, LNSXP, LBSXP	I	Word number, length in bits, and starting LBSXP bit location of Spatial Covariance X+.
75-77	LWSXN, LNSXN, LBSXN	I	Word number, length in bits, and starting LBSXN bit location of Spatial Covariance X-.
78-80	LWSYP, LNSYP, LBSYP	I	Word number, length in bits, and starting LBSYP bit location of Spatial Covariance Y+.
81-83	LWSYN, LNSYN, LBSYN	I	Word number, length of bits, and starting LBSYN bit location of Spatial Covariance Y-.
84-86	LWIND, LNIND, LBIND	I	Word number, length in bits, and starting LBIND bit location of Independent Temperature.
87-96	GRDWTS (10)	R	Weight assigned to each grid unit, according to its distance from the grid intersection for which gradients are being calculated.
97	NP	I	Number of grid points to be used in calculation of gradients.
98-117	KMDST (10,2)	I	Look up table of gradient values and corresponding distances to be used in determining the search area for analysis.
118	MKM	R	Number of paired entries in KMDST.
119-138	H(10,2)	R	Look up table of gradient values and corresponding factors to be used in determining the new weight assigned to the observation temperature analysis.
139	MH	I	Number of paired entries in H.
140	EXP	R	Exponent used in temperature analysis.
141	FDX	R	Factor used in determining new weight assigned to the observation temperature for analysis.
142	XCLASS	R	Factor used to place gradients into a class for Gradient Class Summary.

143	DEL	R	Maximum number of degrees centigrade (x 10) that the new analysis temperature may differ from the previous SST field temperature.
144	MF	I	Factor applied to the previous field temperature and reliability to determine the final analysis temperature and its reliability.
145	MSTAR	I	Factor applied to the combined observation temperature and weight in determining the new analysis temperature.
146	MNSRCH	I	Minimum distance in kilometers to be searched for analysis observations.
147	MXSRCH	I	Maximum distance in kilometers to be searched for analysis observations.
148	BDEL	R	Maximum distance in kilometers to be searched for analysis observations. Maximum difference allowed between new analysis temperature and the previous one for Class 1 coverage bit to be set to 1.
149	FCWT	R	Maximum value that can be assigned as the reliability of the new analysis temperature.
150	IYYY	I	Year of youngest time of observation data used (0-99).
151	IYMM	I	Month of youngest time of observation data used (1-12).
152	IYDD	I	Day of youngest time of observation data used (1-31).
153	IYHH	I	Hour of youngest time of observation data used (0-23).
154	IOYY	I	Year of oldest time of observation data used (0-99).
155	IOMM	I	Month of oldest time of observation data used (1-12).
156	IODD	I	Day of oldest time of observation data used (1-31).
157	IOHH	I	Hour of oldest time of observation data used (0-23).
158	ICURTM	I	Last time used in analysis (in Julian days from Jan. 1, 4713 BC).

9.1.1.3 Field Data Record Format

Each Field Data Record (latitudinal row) consists of a series of grid intersection points. These points are 28 bytes in length. Each longitude (column) reflects one grid intersection. At the end

of the data record (i.e., immediately following the last column) is the 28-byte Latitudinal Row Identifier. All parameters in the grid intersection are stored as integer values and have the format shown in Table 9.1.1.3-1.

Table 9.1.1.3-1. Format of the Parameters in the Grid Intersection.				
Word #	Byte #	Description	Units	Range
1	1-2	Analysis Temperature	C x 10	-850 to +610
1	3-4	Average Gradient	C/100 km (x 10)	0 to 300
2	5-6	Gradient X+	C/100 km (x 10)	0 to 300
2	7-8	Gradient X-	C/100 km (x 10)	0 to 300
3	9-10	Gradient Y+	C/100 km (x 10)	0 to 300
3	11-12	Gradient Y-	C/100 km (x 10)	0 to 300
4	13	Physiographic Descriptor	0 = sea; 1=land	0 to 15
4	14	Ice Field	Percent sea ice for 50 km SST field, otherwise, undefined.	0 to 100 for 50 km SST field. Set to 100 for all other fields.
4	15	Number of Observations	Integer	0 to 255
4	16	Age of Most Recent Observation	Hours	0 to 255
5	17-18	Reliability	Integer	0 to 32767
5	19-20	Class 1 Coverage	Bits	0 or 1
6	21	Spatial Covariance X+	Grid units	0 to 10
6	22	Spatial Covariance X-	Grid units	0 to 10
6	23	Spatial Covariance Y+	Grid units	0 to 10
6	24	Spatial Covariance Y-	Grid units	0 to 10
7	25-26	Climatological Temperature (for 100 km field file only)	C (x 10)	-850 to +610
7	27-28	Spare	Undefined	Blank

The format of the Latitudinal Row Identifier (last 28 bytes of a row) is contained in Table 9.1.1.3-2. All parameters in the table are stored as integer values.

Table 9.1.1.3-2. Format of the Latitudinal Row Identifier.				
Word #	# Bytes	Description	Units	Range
1	4	Row	Integer	1-141
2	4	Spare	Undefined	0 to 32767
3	4	Spare	Undefined	0 to 32767
4	1	Physiographic Descriptor	Integer	Always 255
4	3	Spare	Undefined	0 to 32767
Date and time at which analysis was performed:				
5	4	Hour of Day, Minutes of hour	100 x hours + minutes	100 x (0-23) + (0-59)
6	4	Day of Year	Days	1-366
7	4	Year (2-digits before 3/3/99; 4-digits after 3/3/99)	Years	0-99 (1999-2100 after 3/3/1999)

The terms used to describe the grid intersection points are defined as follows:

ANALYSIS TEMPERATURE - The latest sea surface temperature calculated based on the previous analysis temperature, weighted according to its reliability, combined with a weighted average of current observations within a surrounding area of the grid point. The surrounding area is determined according to the gradient in each direction.

AVERAGE GRADIENT - The average of the gradients in all four directions (N, S, E, and W) from the grid intersection.

GRADIENT IN X+ DIRECTION - Change in temperature between the grid point and neighbor points within the field in the positive direction along the X axis.

GRADIENT IN X- DIRECTION - Change in temperature in the negative direction along the X axis.

GRADIENT IN Y+ DIRECTION - Change in temperature in the positive direction along the Y axis.

GRADIENT IN Y- DIRECTION - Change in temperature in the negative direction along the Y axis.

PHYSIOGRAPHIC DESCRIPTOR - The land/sea tag indicating whether a grid intersection is a land or sea point.

SPARE - Unused parameter.

NUMBER OF OBSERVATIONS - The total number of current observations used in the analysis of the new temperature for the grid intersection.

AGE OF MOST RECENT OBSERVATION - The age, in hours before the time of the analysis, of the most recent observation used to determine the new temperature for a grid intersection.

RELIABILITY - New reliability associated with the new temperature, based on the previous reliability combined with the weighted reliability of all observations used in the last analysis. Larger values are more reliable.

CLASS 1 TEMPORAL COVERAGE - Set of bits (0-15) of which Bit 1 is set to 1 for each analysis which included observations with a reliability greater than or equal to a specific minimum reliability considered as Class 1. Bit 0 always remains a 0, and all bits are shifted right during each analysis leaving Bit 1 to 0 when no Class 1 reliability observations are used for a grid intersection.

SPATIAL COVARIANCE X+ - The distance in grid units from the grid intersection to the nearest land mass in the positive direction along the X axis.

SPATIAL COVARIANCE X- - The distance in grid units from the grid intersection to the nearest land mass in the negative direction along the X axis.

SPATIAL COVARIANCE Y+ - The distance in grid units from the grid intersection to the nearest land mass in the positive direction along the Y axis.

SPATIAL COVARIANCE Y- - The distance in grid units from the grid intersection to the nearest land mass in the negative direction along the Y axis.

CLIMATOLOGICAL GRID TEMPERATURE - The average sea surface temperature of a grid intersection for a particular month over a number of years, taken from the global climatology file (for 100 km field file only).

9.1.2 EIGHT-DAY SST OBSERVATION FILE

The current operational technique for calculating SSTs is a multichannel technique with separate

algorithms for day and night observations. This multichannel technique yields an improved resolution of 8 km. The SST Observation File contains eight days of SST observations, which are organized in 5 x 5 degree blocks. These 5 x 5 degree blocks are further subdivided into 1 x 1 degree subblocks. Global coverage requires 2,592 blocks. The block number IBLOCK for an observation located at ILAT latitude (+N,-S) and ILONG longitude (+E,-W) can be calculated using the following equation:

$$IBLOCK = \frac{(ILATA - LA)}{LAO} \times INBL + \frac{(ILONG - LO)}{LOO} + 1 \quad 9.1.2-1$$

The current operational technique for calculating SSTs is a multichannel technique with separate algorithms for day and night observations. This multichannel technique yields an improved resolution of 8 km. The SST Observation File contains eight days of SST observations, which are organized in 5 x 5 degree blocks. These 5 x 5 degree blocks are further subdivided into 1 x 1 degree subblocks. Global coverage requires 2,592 blocks. The block number IBLOCK for an observation located at ILAT latitude (+N,-S) and ILONG longitude (+E,-W) can be calculated using the following equation:

$$SBN = (ILAT - LLA) \times LOO + ILONG - LLL + 1 \quad 9.1.2-2$$

where LA is the latitude origin of the file (-90 degrees), LO is the longitude origin of the file (-180 degrees), LAO is the size of the block in the latitudinal direction (5 degrees), LOO is the size of the block in the longitudinal direction (5 degrees), and INBC is the number of column blocks (360 degrees/LOO). Each block includes the minimum whole latitude and longitude, and excludes the maximum whole latitude and longitude which borders the block. For example, the limits of Block 1 are: -90.0S to -85.01S and -180.0W to -175.01W. Since all subblocks are degree boxes, the Subblock number *SBN* for a given latitude and longitude can be defined as: where LLA and LLL are respectively the lower left latitude and longitude of the 5 degree block.

The first record in the Eight Day SST Observation File is the Block Directory which contains 13,024 bytes. The format of the Block Directory is contained in Table 9.1.2-1.

Table 9.1.2-1. Format of the Block Directory record.	
Halfword #	Contents
1	LA, the latitude origin of the file (range: -90)
2	LO, the longitude origin of the file (range: -180)
3	LAO, size of block in latitudinal direction (range: +5)

4	LOO, size of block in longitudinal direction (range: +5)
5	First free record pointer (points to record # of first record available as an overflow track, 0 if no more tracks available).
6	Number of records in file (3,100 initially)
7	Start of Block Directory Information in halfwords (11 initially)
8	Day of year of most recent information (range: 1-366)
9	File availability: 0=available, 1=unavailable, update in progress
10	Year of century of last data (range: 0-99)
11	Record number for Block 1 (range: 2-3,100)
12	Record number for Block 2 (0 for no data in block)
...	...

Using the block number, the record number can be calculated and found in the portion of the Block Directory which serves as a lookup table. If the record number entry is zero, there is no data for that corresponding block in the file. The record number points to the Observation Data record, of which the first portion is a subdirectory. The file contains 8,446 records of 13,024 bytes each. The Observation Data record has the format shown in Table 9.1.2-2.

Table 9.1.2-2. Format of Observation Data Record.		
Halfword #	Contents	Range
1	Record number	2 to 8446
2	Block number	1 to 2592
3	Extent number (number of records removed from primary)	0 (if primary)
4	Pointer to succeeding overflow record. Last overflow record points to primary record.	0 if no overflow
5	Pointer to halfword position of start of Observation Unit	61
6	Pointer to start of Subblock Directory	11

7	Lower left latitude of block LLA (+N,-S) in degrees	-90 to +90
8	Lower left longitude of block LLL (+E,-W) in degrees	-180 to +180
9	Pointer to last halfword containing data	1 to 6512
10	Unused	n/a
11	Halfword of start of data for Subblock #1	0 if no data for subblock 61 otherwise
12	Halfword of end of data for Subblock #1 (other extents may or may not contain data for this subblock).	1 to 6512
13-60	Similar to halfwords 11 and 12 for remaining subblocks	1 to 6512
61-6512	Observation data (observation units are variable length but usually they are 56 bytes each)	n/a

If the block size is changed in the future, a block may contain a different number of subblocks, thus changing the number of subblock pointers and the starting halfword of the Observation Unit. If the observations for a block do not fit on one record then as many records (extents) are allocated as needed. Each additional record will include the subdirectory and Observation Unit. If the subblock contains no information, then the start and end positions contain a zero. Subblocks may cross record boundaries. If an entire subblock cannot fit into one record, it will be split and a new record will be allocated for the remainder of the subblock. Unused portions of records and records containing no data will be zero filled.

The Observation Unit for the Eight Day SST Observation File is of variable length, ranging from a minimum of four 4-byte words to a maximum of 24 words. The length must be an even number of full words with no odd full word (except the first word which is always negative). The first three words of an Observation Unit contain identification information including the type of algorithm used, the satellite, date, time, and location. The fourth word contains the actual SST data and the reliability assigned to the observation. The remainder of the Observation Unit is unique to the type of algorithm used. The format of the Eight Day SST Observation Unit is contained in Table 9.1.2-3. Tables' 9.1.2-4 and 9.1.2-5 contain the SST Observation types and source codes, respectively.

Table 9.1.2-3. Format of the Eight Day SST Observation Unit.

Halfword#	Byte #	Contents	Range
1	1	Type of Observation (Table 9.1.2-4)	129 to 255
1	2	Source of Observation (Table 9.1.2-5)	0 to 255
2	3	Year	0 to 99
2	4	Month	1 to 12
3	5-6	Latitude (+N,-S) x 100	-9000 to 9000
4	7-8	Longitude (+E,-W) x 100	-18000 to 17999
5	9	Day	1 to 31
5	10	Hour	0 to 23
6	11	Minute	0 to 59
6	12	Second	0 to 59
7	13-14	SST (degrees C x 10)	-20 to 350
8	15-16	Reliability	0 to 32,767
9	17-18	Solar zenith angle (degrees x 10)	0 to 1800
10	19-20	Satellite zenith angle (degrees x 10)	-600 to 600
11	21-22	Analyzed Field SST (degrees C x 10)	-20 to 350
12	23-24	Internal Error (RMS x 100)	0 to 1000
13	25-26	Solar azimuth angle (degrees x 10)	0 to 1800
14	27-28	Climatological SST (degrees C x 10)	-20 to 350
15	29	Beginning Row if unit array	1 to 11
15	30	Beginning Column of unit array	1 to 11
16	31-32	AVHRR Ch. 1 average (% x 100)	0 to 10,000
17	33-34	AVHRR Ch. 2 average (% x 100)	0 to 10,000
18	35-36	AVHRR Ch. 3 average (K x 100)	0 to 32,767

19	37-38	AVHRR Ch. 4 average (K x 100)	0 to 32,767
20	39-40	AVHRR Ch. 5 average (K x 100)	0 to 32,767
21	41-42	Space View sigma Ch. 1 (% x 100)	0 to 10,000
22	43-44	Space View sigma Ch. 2 (% x 100)	0 to 10,000
23	45-46	Space View sigma Ch. 3 (K x 100)	0 to 32,767
24	47-48	Ch. 4 Blackbody temperature (K x 100)	0 to 32,767
25	49-50	Ch. 5 Blackbody temperature (K x 100)	0 to 32,767
26	51-52	Algorithm number	1 to 32767
27	53-56	Spares	n/a

Table 9.1.2-4. SST Observation Types.

Code	Type
151	AVHRR-only day operational
152	AVHRR-only night operational
153	HIRS-only day operational
154	HIRS-only night operational
155	AVHRR + HIRS day operational
156	AVHRR + HIRS night operational
157	Aerosol Retrieval - (AVHRR-only day operational)
158	Aerosol Retrieval - (AVHRR-only day operational - warm spot mode)
159	AVHRR-only day operational warm spot mode (relaxed visible cloud test)
160	Reserved
161	AVHRR-only day test
162	AVHRR-only night test
163	HIRS-only day test

164	HIRS-only night test
165	AVHRR + HIRS day test
166	AVHRR + HIRS night test
167-168	Reserved
169	AVHRR-only day test - warm spot mode (relaxed visible cloud test)
170-178	Reserved
179	ITOS SST
180-199	Reserved
200	Independent SST (Ship or buoy)
201-254	Reserved
255	Erroneous Data - Do not use this Observation
Note: Codes having values between 151 and 169 (inclusive) indicate a multichannel technique in use at the present time.	

Table 9.1.2-5. SST Observation Source Codes.	
Source code	Source
128	No source
129	TIROS-N
130	NOAA-6 ¹
131	Not Used
132	NOAA-7
133	Not Used
134	NOAA-8 ¹
135,7 ²	NOAA-9
8	NOAA-10 ¹
1	NOAA-11

5	NOAA-12
2	NOAA-13 ³
3	NOAA-14
4	NOAA-15
5-20	TBD
21-50	Reserved
51	ITOS NOAA 1 Sensor # 1
52	ITOS NOAA 1 Sensor #2
53	ITOS NOAA 2 Sensor # 1
54	ITOS NOAA 2 Sensor #2
55-58	ITOS NOAA 3 and 4
59-62	ITOS NOAA 5
63-127	Reserved
<p>1. No SSTs were archived for these satellites. 2. NOAA-9 source code was 135 prior to August 4, 1986. NOAA-9 source code was 7 beginning on August 4, 1986. 3. No SSTs were ever generated for this satellite.</p>	

9.1.3 SST MONTHLY MEAN ARCHIVE

The SST Monthly Mean Archive contains twelve monthly mean SST fields for one year. NESDIS creates this archive cartridge in January of every year, archiving the monthly mean fields for the previous year. The data on this cartridge were derived exclusively from satellite data. The field has a 2.5 degree latitude-longitude resolution or 250-km resolution. For each 2.5 degree box in the field, there is a count of the number of observations in the box, the mean SST, and the standard deviation about the mean, σ .

The SST Monthly Mean archive cartridge contains two files. The first file is a Header File (previously described in Table 9.1-1) which contains information about the data on cartridge. The second file has 72 physical records, each containing 12 logical records consisting of satellite SST monthly mean data. For each month of the year and for each point of its geographical grid, the data consists of 1) the month's mean temperature, T; 2) the standard deviation of a single measure, σ sub T; and 3) the number of observations entering into the mean, N. Each of

these quantities is stored as 2-byte integers: T as degrees C x 10, σ_T as degrees C x 100, and N as itself.

The geographical grid establishes a global field of boxes at 2.5 degree resolution. Boxes are bordered by meridians and parallels which are multiples of 2.5 degrees in latitude and longitude. Four of these boxes can be combined to produce boxes centered on intersections of meridians and parallels which are multiples of 5 degrees in latitude and longitude.

The second file contains 12 fields, the first is January, and the last is December. Each field has 72 logical records grouped into 12 logical records per physical record or each field has 6 physical records. Each logical record is 876 bytes long with 10,512 bytes in a physical record. The first logical record in each field contains data for the 2.5 degree latitude band with southern boundary at 90.0S. The 72nd logical record for a field has data for the 2.5 degree latitude band with southern boundary at 87.5N. Within a latitude band, the first grid box has a westernmost boundary of 180W. The 144th grid box has a westernmost boundary of 177.5E. Each grid box requires three 16-bit halfwords. In addition, the first 12 bytes of each logical record contains the year, month, and latitude of the latitude band. A detailed format description of a Monthly Mean Data Field is contained in Table 9.1.3-1.

Table 9.1.3-1. Format of Monthly Mean Data Field.		
Logical Record #	Bytes	Content (Integer values indicated)
1	1-4	Year of data (e.g., 1978)
1	5-8	Month of data (e.g., 1)
1	9-12	Latitude of southern edge of this 2.5 degree latitude band (real value)
1	13-14	Number of observations N for 2.5 degree box with southwest corner at 90.0S, 180W.
1	15-16	Monthly mean temperature T (degrees C x 10) for same box
1	17-18	σ_T (degrees C x 100) for same box
1	19-20	N for 2.5 degree box with southwest corner at 90.0S, 177.5W.
1	21-22	T for same box
1	23-24	σ_T for same box
...
1	871-872	N for 2.5 degree box with southwest corner at 90.0S, 177.5E.

1	873-874	T for same box
1	875-876	σ_T for same box
...
72	10,507-10,508	N for 2.5 degree box with southwest corner at 87.5N, 177.5E.
72	10,509-10,510	T for same box.
72	10,511-10,512	σ_T for same box.

9.2 MAPPED GAC PRODUCTS

The Mapped GAC products consist of mapped mosaics displayed on polar stereographic and Mercator map projections with both forms available on digital media. The Mapped mosaics consist of daytime visible (VIS) and Infrared (IR), and nighttime IR imagery. The Mapped GAC product in polar stereographic form is described in Section 9.2.1, while the Mapped GAC product in Mercator form is described in Section 9.2.2. For a representative sample of Mapped GAC products, users should link to

URL: <http://www.osdpd.noaa.gov/PSB/IMAGES/mapped.html> .

NESDIS/IPD also produces an operational mapped GAC product which is known as the Global Vegetation Index Product. This product provides a means of monitoring the density and vigor of green vegetation over the growing areas of the Earth. Plate Carreé, polar stereographic and Mercator mosaics of the Global Vegetation Index, derived from AVHRR Channels 1, 2, plus coincident channels 4 and 5, and supporting information are produced weekly. For more information, see the *NOAA Global Vegetation Index User's Guide*, which is available from NCDC. For the latest maps of the various Global Vegetation Index Products, link to URL: <http://www.osdpd.noaa.gov/PSB/IMAGES/gvi.html>.

9.2.1 MAPPED GAC (POLAR STEREOGRAPHIC) PRODUCT

The Mapped GAC (polar stereographic) data are organized as daytime and nighttime for the northern and southern hemispheres. The daytime data contain both visible (Channel 1) and IR (Channel 4) data while the nighttime data contain only the IR data. The data are reported in pairs of files. The first file of each file pair consists of a documentation record for that variable, immediately followed by an EOF and a second file containing the data records for the same variable. All records are 16,384 bytes in length. Both documentation and data records are in binary format and have the same length. A value of zero indicates missing data.

Every day a 3480 cartridge is created which contains one day of data in the polar stereographic projection. Table 9.2.1-1 contains the general file structure of this daily KLM Master map file. Each cartridge contains 12 files arranged as shown in Table 9.2.1-1.

The variables reported in the documentation record are all INTEGER*2 with the exception of the satellite type in the first two bytes of the record, which is CHARACTER*2. Table 9.2.1-2 defines the basic documentation record format.

Each data record (16,384 bytes) consists of four mapped rows, each containing 4096 pixels of data. Each pixel is represented by one byte of data.

Table 9.2.1-1. General structure of the polar stereographic KLM Master Map File.	
File, record #	Contents
DAYTIME NORTHERN HEMISPHERE	
Visible Channels	
F1, rec. 1	Channel 1 documentation record. See Table 9.2.1-2 for format
F2, rec. 1-1024	Channel 1 data records. Consists of 16,384 bytes of data or 4 mapped rows of data. Each row contains 4096 pixels of data. Each pixel is one byte. A value of 0 indicates missing data
IR Channels	
F3, rec. 1	Channel 4 documentation record. See Table 9.2.1-2 for format
F4, rec. 1-1024	Channel 4 data records. Same as F2 data records
DAYTIME SOUTHERN HEMISPHERE	
Visible Channels	
F5, rec. 1	Channel 1 documentation record. See Table 9.2.1-2 for format.
F6, rec. 1-1024	Channel 1 data records. Same as F2 data records
IR Channels	
F7, rec. 1	Channel 4 documentation record. See Table 9.2.1-2 for format.
F8, rec. 1-1024	Channel 4 data records. Same as F2 data records.
NIGHTTIME NORTHERN HEMISPHERE	

	IR Channels
F9, rec. 1	Channel 4 documentation record. See Table 9.2.1-2 for format.
F10, rec. 1-1024	Channel 4 data records. Same as F2 data records
NIGHTTIME SOUTHERN HEMISPHERE	
	IR Channels
F11, rec. 1	Channel 4 documentation record. See Table 9.2.1-2 for format.
F12, rec. 1-1024	Channel 4 data records. Same as F2 data records.

Table 9.2.1-2. Format of documentation record for polar stereographic KLM Master Map data.	
Byte #s	Contents
1-2	Satellite type, e.g., NH=NOAA-H (CHARACTER*2)
3-4	Satellite ID: 0=morning satellite; 1=afternoon sat.
5-6	Data set type: 1=LAC; 2=GAC; 3=HRPT
7-8	Projection type: 0=unmapped; 1=Mercator; 2=Polar; 3=linear lat/lon
IMAGE BOUNDARIES	
9-10	Beginning latitude x 128; North>0; South<0
11-12	Ending latitude x 128
13-14	Beginning longitude x 128; East>0; West<0
15-16	Ending longitude x 128
17-18	Mapped resolution x 100; km for polar and mercator projections; degree/pixel for linear lat/lon projections; sampling interval for unmapped projection
19-22	Spares
POLAR PROJECTION DATA	
23-24	Polar grid mesh size (grid size that corresponds to resolution, e.g., 64 = 1/64 grid)
25-26	Number of grid points (that correspond to grid size, e.g., 1/64 grid corresponds to 4096 points)

27-28	Hemisphere: 1=Northern; -1=Southern
29-30	Prime longitude; East>0; West<0
	GRID OFFSETS
31-32	IOFF; grid coordinates of top left corner of the image. (not applicable for unmapped projections)
33-34	JOFF
	IMAGE SIZE
35-36	Number of rows
37-38	Number of columns
39-42	Spares
43-44	Composite flag: 0=no composite; 1=composite based on minimum nadir angle; 2=retain average value; 3=retain later value; 4=retain warmer value; 5=retain colder value
45-46	Calibration flag: 0=raw counts; 1=radiances; 2= calibrated to albedos and BTs; 3=calibrated to albedos and GOES counts
47-48	Fill-up options: 0=no fill-up; 1=fill-up using averages; 2=fill-up using adjacent pixel values
49-50	Channel number: 1-5=channel number; 101=scan angle; 102 =satellite zenith angle; 103=solar zenith angle; 104 = relative azimuth angle; 105=scan time; 201=SST split window; 202=SST dual window; 203=SST Triple window
51-52	Data ID: 0=visible; 1=infrared; 2=ancillary
	DATA CORRECTION FLAGS
53-54	Sun normalization: 0=not performed; 1=performed
55-56	Limb correction: 0=not performed; 1=performed
57-58	Nonlinearity correction: 0=not performed; 1=performed
59-60	Number of orbits processed
	CHANNEL IMAGES
61-62	Number of channels produced

63-64	Pixel size: 1=1 byte; 2=2 bytes
65-66	Starting block number
67-68	Ending block number
	ANCILLARY DATA
69-70	Number of ancillary parameters produced
71-72	Pixel size: 1=1 byte; 2=2 bytes
73-74	Starting block number
75-76	Ending block number
77-78	Block size of image files
79-80	Compression flag
81-100	Spares
	ORBIT 1 INFORMATION
101-102	Orbital node over region: -1=asc; 1=desc; 2=both
103-104	Day/night flag: 0=day; 1=night
	IMAGE DATA BOUNDARIES
105-106	Start row
107-108	Start column
109-110	End row
111-112	End column
	ORBIT START TIME
113-114	Year of century
115-116	Day of year
117-118	Month and day of month (month x 100) + day
119-120	Hours and minutes (hours x 100) + minutes
121-122	Seconds

123-124	Milliseconds
	ORBIT END TIME
125-126	Year of century
127-128	Day of year
129-130	Month and day of month (month x 100) + day
131-132	Hours and minutes (hours x 100) + minutes
133-134	Seconds
135-136	Milliseconds
137-138	Processing block ID (orbit number)
	QUALITY FLAGS
139-140	Ramp/auto calibration flag
141-142	Number of data gaps
143-144	Sync errors
145-146	TIP parity errors
147-148	Auxiliary errors
149-150	Calibration parameter ID
151-152	DACS status
	CALIBRATION COEFFICIENTS
153-154	Channel 1 slope x 10,000
155-156	Channel 1 intercept x 1,000
157-158	Channel 2 slope x 10,000
159-160	Channel 2 intercept x 1,000
161-166	Spares
	ORBIT 2 INFORMATION
167-232	Same as bytes 102-166

	ORBIT 3 INFORMATION
233-298	Same as bytes 102-166
...	...
	ORBIT n INFORMATION
((n-1) x 66+102) -((n-1)x 66+166)	Same as bytes 102-166

9.2.2 MAPPED GAC (MERCATOR) PRODUCT

The Mapped GAC (Mercator) data are organized as visible (Channel 1), and daytime and nighttime IR (Channel 4). These data are reported in pairs of files, totaling six files. The first file of each file pair consists of a documentation record for that variable, immediately followed by an EOF and a second file containing the data records for the same variable. All records are 4,052 bytes in length. Both documentation and data records are in binary format and have the same length. A value of zero indicates missing data.

Every day a 3480 cartridge is created which contains a day's worth of Mapped GAC data in the mercator projection. Table 9.2.2-1 contains the general file structure of the daily mercator KLM Master Map file. Each file contains 6 files arranged as shown in the table.

The format of the basic documentation record is the same as the polar stereographic KLM Master Map which is contained in Table 9.2.1-2.

Each data record (4,052 bytes) consists of one mapped row, containing 4052 pixels of data. Each pixel is represented by one byte of data.

Table 9.2.2-1. General structure of the Mercator KLM Master Map File.	
File, record #	Contents
	Visible Channels
F1, rec. 1	Channel 1 documentation record. See Table 9.2.1-2 for format.
F2, rec. 1-984	Channel 1 data records. Consists of 4,052 bytes of data or 1 mapped row of data. Each row contains 4052 pixels of data. Each pixel is one byte. A value of 0 indicates missing data.
	IR Channels (Daytime)

F3, rec. 1	Channel 4 documentation record. See Table 9.2.1-2 for format.
F4, rec. 1-984	Channel 4 data records. Same as F2 data records
	IR Channels (Nighttime)
F5, rec. 1	Channel 4 documentation record. See Table 9.2.1-2 for format
F6, rec. 1-984	Channel 4 data records. Same as F2 data records.

9.3 RADIATION BUDGET PRODUCTS

After the launch of NOAA-K, NOAA will be generating all the radiation budget products in the new NOAA KLM one degree equal area format. In addition, the older TIROS-N format for radiation budget products will be available through May 1999. This section contains a description of the NOAA KLM radiation budget products as well as a brief overview of the TIROS-N series products.

9.3.1 NOAA KLM RADIATION BUDGET PRODUCTS

The Radiation Budget Product Generation System (RBP GS) generates four basic output files: the Primary Components File for daily products (Section 9.3.1.1), the Monthly Mean files (Section 9.3.1.2), the Seasonal Mean files (Section 9.3.1.3) and the Annual Mean files (also in Section 9.3.1.3).

9.3.1.1 Primary Components 37 Day File (PC37DF)

This is the basic output file generated by the RBP GS and is known as the Primary Components 37 Day File (PC37DF). It is a revolving file with, at present, one record for a header plus a set of records for each of 37 day bins. The Primary Components File has a logical record size of 23,476 bytes with one record per block. The file format is ASCII for text information and integer (I*2) for the data. Each day bin contains three sets of maps:

1. Nighttime (22 maps),
2. Daylight longwave (22 maps),
3. Daylight shortwave (24 maps).

Each set of maps occurs in pairs, one map for the Northern Hemisphere and one for the Southern Hemisphere (thus the nighttime maps consist of eleven types). Each of these requires two records. The structure of an individual map is based on the Pathfinder Equal Areas/Equal Aspect (EAA) map. The whole RBP GS is set up to, at any time, either add or subtract data from any day bin within the PC37DF. This is done so as to allow reprocessing of poor data. The file is fully

described in Table 9.3.1.1-1. Note, the tabulated Available Solar Energy (ASE) Day Bin Fields are stored contiguously (all 600) in the header and are allocated to each Day Bin.

Table 9.3.1.1-1. Description of the Primary Components 37 Day File (PC37DF) Header.			
Field	Bytes	Type	Description
HEADER	1-100	A100	ASCII Header “NOAA/NESDIS RADIATION BUDGET ARCHIVED 37-DAY PRIMARY COMPONENTS FILE PRD.RADBUD.NOAAXX.ARC.DAY37CMP” where XX indicates the satellite used.
TYPE	101-102	I*2	The type of file (0 for Primary components file).
VER	103-104	I*2	The version number of the file (0 for this version).
SATID	105-106	I*2	The satellite ID.
PCOY	107-108	I*2	The year of the oldest data contained in the file.
PCOM	109-110	I*2	The month of the oldest data contained in the file.
PCOD	111-112	I*2	The day of the month of the oldest data contained in the file.
PCYY	113-114	I*2	The 4 digit year of the youngest (most current) data in the file.
PCYM	115-116	I*2	The month of the youngest (most current) data in the file.
PCYD	117-118	I*2	The day of the month of the youngest (most current) data in the file.
PCDBO	119-120	I*2	The day bin reflecting the oldest data in the file.
PCDBY	121-122	I*2	The day bin reflecting the youngest (most current) data in the file.
PCDBSR	123-124	I*2	The first physical record on this file that contains Primary Components map data for day bin number 1.
PCDBBL	125-126	I*2	The total number of physical records in this file that are required by each day bin.
IDATE	127-132	3 I*2	The creation date of this file (YYYYMMDD).

RECTYP	133-134	I*2	The record type of this (header) record (=1).
EPOCHY	135-136	I*2	The satellite epoch year (launch year).
EPOCHD	137-138	I*2	The satellite epoch day-in-year (launch day).
MAPTYP	139-140	I*2	The map type (0=PSG maps, 1=EAA maps).
ASPECT	141-142	I*2	EAA map aspect ratio x 1000.
AREA	143-144	I*2	EAA map nominal element area (square degrees x 1000).
CSCALE	145-148	I*4	Polar Stereographic (PSG) map scale (grid points x 1000 between pole and equator).
LRC	149-150	I*2	Longitude Rotation Convention (LRC).
PRIMEL	151-152	I*2	PSG map Prime Longitude x 100 (interpreted via the LRC).
PACK	153-154	I*2	Is the map to be packed? If yes, then PACK=1. Note that EAA maps are packed.
NPROWS	155-156	I*2	If so, then number of rows per stored column.
SBOUND (1-5)	157-166	5I*2	GAC 5 shortwave class boundary fluxes for the GAC histograms. These values have to be the same as those held in SF/RF 18 and in the RDAF header (the sixth value is immaterial).
LBOUND (1-5)	167-176	5I*2	GAC 5 longwave class boundary fluxes for the GAC histograms. These values have to be the same as those held in SF/RF 18 and in the RDAF header (the sixth value is immaterial).
TSTAMP	177-188	6I*2	Time stamp written at the end of ANLRET/SUMFRM as YYYYMMDDHHMMSS.
NDHELD	189-190	I*2	Number of days in the 37(!) Day files. This is to be the same as RADANL: DBNX.
PRL	191-194	I*4	Primary Components 37 Day File physical record length (23,476 bytes for this version).
	195-276		Spare.

Tabulated ASE Day Bin Fields			
ABDN	277+ (ABDN-1)*600:2 78+ (ABDN-1)*600	I*2	Permanent Day Bin label. Values 1 to 37 (or RADANL: DBNX the number of day bins in the 37(!) day files).
NCDAY	279+ (ABDN-1)*600:2 80+ (ABDN-1)*600	I*2	Actual Day Number of the contained data relative to the Satellite Epoch.
NARUNS	281+ (ABDN-1)*600:2 82+ (ABDN-1)*600	I*2	Number of RADRET runs involved in the ASETAB average.
IDATIM (1-6)	283+ (ABDN-1)*600:2 94+ (ABDN-1)*600	6 I*2	Time Stamp YYMMDDHHMMSS
ASETAB (1-91)	295+ (ABDN-1)*600:4 76+ (ABDN-1)*600		Contains the Biased Sum of Average Available Solar Energy (ASE) Table for the actual day currently occupying the day bin. There are 91 values (two bytes each) in each field starting at the North Pole and then given at intervals of two degrees. Each value should be divided by the number of pixels in a target (currently 121). Then add the shortwave bias value (currently 270) to retrieve the average unbiased ASE value for each latitude.

	477+ (ADBN-1)*600:8 76+ (ADBN-1)*600		Spare.
	22077- 23476		Spare.

The first map data containing record on the Primary Components file is the first data record of Day Bin 1 and is Record Number PCDBSR (see Table 9.3.1.1-1). If PCDBSR is set higher than 2, then an extended header may be constructed running from record 2 to PCDBSR-1.

Day Bin 1 runs from Record PCDBSR through Record PCDBBL + PCDBSR - 1, i.e., there are PCDBBL records allocated to day bin 1 and, thereafter, to every day bin. The records in each day bin are constructed in exactly the same manner with the only difference being the Permanent Day Bin label, DBN, located in bytes one and two of each record, allocated to the given day bin. Day Bin 2, etc. is structured exactly the same as Day Bin 1 (apart from the value of DBN) and immediately follows Day Bin 1.

In a Day Bin, the records occur in groups of four, all pertaining to the same kind of map field (e.g., GAC OLR at night); two records for the Northern Hemisphere followed directly by two records for the Southern Hemisphere. The format of the first record of a hemisphere pair is described in Table 9.3.1.1-2, while the second record of a hemisphere pair is contained in Table 9.3.1.1-3.

Table 9.3.1.1-2. Format of Record 1 of a Hemisphere Pair in a Day Bin.			
Field	Bytes	Type	Description
DBN	1-2	I*2	Permanent Day Bin label.
BCDAY	3-4	I*2	Actual Day Number, relative to the Satellite Epoch, of the data that is currently stored in the day bin.
YEAR	5-6	I*2	Actual four digit year.
MONTH	7-8	I*2	Actual month.
DAY	9-10	I*2	Actual day of month.

PURGET	11-12	I*2	Last purge date (=100 x month + day, with month and day being the real-time month and day of the first writing of the BCDAY data).
RCTYPE	13-14	I*2	'02' 1st record of a Northern Hemisphere map. '04' 1st record of a Southern Hemisphere map.
DBSECN	15-16	I*2	Day Bin Section Number: 1= Night; 2= Longwave Day; 3= Shortwave Day.
FIELD	17-18	I*2	Field mnemonic. (See Table 9.3.1.1-4).
NORS	19-20	I*2	Hemisphere: North=0, South=1.
TSTAMP	21-32	6 I*2	Time Stamp as 'YYYYMMDDHHMMSS' of most recent data addition or subtraction.
NARUNS	33-34	I*2	Showing the number of RADRET runs contributing to the tabulated Available Solar Energy (ASE). Copied from the PC37DF header.
ASEBYT	35-216		Showing the Biased Sum of Tabulated ASE for the (1-91) actual day, starting at the North Pole and then given for every two degrees latitude. Copied from the PC37DF header.
SPARE	217-276		Spare
I*2MAP	277-23,476		Showing the first 11,600 I*2 elements of the Equal Areas/Equal Aspect Pathfinder Map (of total size 20,626 elements) for the hemisphere. The first set of elements (3) is for the pole. The second latitude band of elements (9) is for -89 in the Southern Hemisphere and 89 for the Northern Hemisphere. This continues toward the equator, where the number of elements in each latitude band is determined by the array NCELL (see second hemisphere pair). The first element in a latitude set is the eastward most longitude (beginning at the Greenwich Meridian). Each element after that is west of the previous element in the latitude set.

Table 9.3.1.1-3. Format of Record 2 of a Hemisphere Pair of a Day Bin.			
Field	Bytes	Type	Description
DBN	1-2	I*2	Permanent Day Bin label.
FIELD	3-4	I*2	Field mnemonic (see Table 9.3.1.1-4).
NORS	5-6	I*2	Hemisphere: North=0; South=1.
NCELL (1-90)	7-186	90 I*2	Each succeeding value represents the number of longitude bins in each of 90 latitude bands of the (current) Equal Areas/Equal Aspect Pathfinder Maps starting at the pole and abutting (to the west) the Greenwich Meridian.
I2MAP	277-18,328		Showing the remaining 9,026 elements (11,601-20,626) of the EAA map stored as 20,626 I*2 integers.
	18,329-22,036		Spare
E2MAP	22,037-23,476		Showing the 720 I*2 elements of the equatorial band data for the hemisphere. Each element is for use with the old-style 144 by 72 LatLon maps, and is of size 1.25 degrees in latitude and 0.5 degrees in longitude with each element abutting the equator and the first element centered on the dateline. Subsequent elements are recorded eastwards.

Table 9.3.1.1-4. Field Mnemonic for radiation budget monthly mean data.	
Data Field	Description
HCN=1	HIRS Count Nighttime
HN=2	HIRS OLR Nighttime
GCN=3	GAC Count Nighttime
GLN=4	GAC Longwave Nighttime
GQN=5	GAC OLR Variance Nighttime

G1N=6	GAC OLR Class 1 Pixel Count
G2N=7	GAC OLR Class 2 Pixel Count
G3N=8	GAC OLR Class 3 Pixel Count
G4N=9	GAC OLR Class 4 Pixel Count
G5N=10	GAC OLR Class 5 Pixel Count
G6N=11	GAC OLR Class 6 Pixel Count
HCD=12	HIRS Count Daytime
HD=13	HIRS OLR Daytime
GCD=14	GAC Count Daytime
GLD=15	GAC OLR Daytime
GQD=16	GAC Variance Daytime
G1D=17	GAC OLR Daytime Class 1 Pixel Count
G2D=18M	GAC OLR Daytime Class 2 Pixel Count
G3D=19	GAC OLR Daytime Class 3 Pixel Count
G4D=20	GAC OLR Daytime Class 4 Pixel Count
G5D=21	GAC OLR Daytime Class 5 Pixel Count
G6D=22	GAC OLR Daytime Class 6 Pixel Count
TC=23	Target Count in Daylight (good retrievals only)
AS=24	Average Available Solar Energy Flux
GC=25	GAC Pixel Count in Daylight
GS=26	Average GAC Absorbed SW Flux
GQ=27	Average GAC Absorbed SW Variance
G1=28	GAC Absorbed SW Class 1 Pixel Count
G2=29	GAC Absorbed SW Class 2 Pixel Count
G3=30	GAC Absorbed SW Class 3 Pixel Count

G4=31	GAC Absorbed SW Class 4 Pixel Count
G5=32	GAC Absorbed SW Class 5 Pixel Count
G6=33	GAC Absorbed SW Class 6 Pixel Count
CP=34	Experimental Cloud Product

9.3.1.2 Monthly Mean Radiation Budget Product

This file contains one month of current monthly mean data. It contains 25 records. The first record is the header. It contains six types of data: HIRS Night OLR, HIRS Day OLR, AVHRR Night OLR, AVHRR Day OLR, Available Solar Energy, and AVHRR SW Absorbed Radiation. Each type of data is associated with four records (The Northern Hemisphere pair and the Southern Hemisphere pair).

The format of the header record for the Monthly Means (and also the Seasonal and Annual Means) data is shown in Table 9.3.1.2-1.

Table 9.3.1.2-1. Format of Header Record for Monthly/Seasonal/Annual Mean Data.			
Field	Bytes	Type	Description
HEADER	1-100	ASCII	Text header
SATID	101-102	I*2	The satellite ID
RPTREQ	103-104	I*2	The type of mean: 0=Monthly; 1=Winter; 2=Spring; 3=Summer; 4=Fall; 5=Annual.
RPTYR	105-106	I*2	The four digit year of the initial data.
RPTMO	107-108	I*2	The month of the initial data.
VER	109-110	I*2	Version number of this file format.
RPTOY	111-112	I*2	The four digit year of the latest data contained in the file.

RPTOM	113-114	I*2	The month of the latest data contained in the file.
RPTOD	115-116	I*2	The day of the month of the latest data contained in the file.
SPARES	117-122	I*2	SPARES
MAXCNT	123-124	I*2	The number of records in the file.
SPARE	125- 126	I*2	SPARE
EPOCHY	127-128	I*2	The four digit satellite epoch year (launch year).
EPOCHD	129-130	I*2	The satellite epoch day-in-year (launch day).
EPOCHT	131-132	I*2	The time of day of the satellite launch: 1=morning 2=afternoon.
TYPREC	133-134	I*2	The record type of this (header) record (=1).
NUMTYP	135-136	I*2	The number of data types in the file. The maximum number of data types is 35. The current number supported is 6.
NUMRECS	137-138	I*2	The number of records per data type is 4.
TYPENAM	139-208	32 I*2	The names of the number of data types currently supported in the file. There is one name for each of the NUMTYP supported. 2=HN, 3=GLN, 13=HD, 15=GLD, 24=AS, 26=GS (See Note 1)
SPARES	209-6447	I*2	The spare bytes in the header record.

Tables' 9.3.1.2-2 and 9.3.1.2-3 contain the format for Records 1 and 2 of the Monthly Mean Data, respectively.

Table 9.3.1.2-2. Format of Monthly Mean Data Record 1 of a Hemisphere Pair.			
Field	Bytes	Type	Description
SPARE	1-2	I*2	SPARE

BCDDAY	3-4	I*2	The actual day number, relative to the satellite Epoch, of the first day in the period covered in the file. (i.e. for monthly means the day is relative to the first day of the month)
SPARES	5-12	I*2	SPARES
RCTYPE1	13-14	I*2	The indicator for the first record of the hemisphere: 02 = Record 1 for the Northern Hemisphere; 04 = Record 1 for the Southern Hemisphere.
SPARE	15-16	I*2	SPARE
FIELD	17-18	I*2	The Field mnemonic. (See Table 9.3.1.1-4)
NORS	19-20	I*2	The hemisphere indicator: 0= North; 1= South
BEGINDATE	21-24	2 I*2	The start time as YYYYMM of the data in the record.
SPARE	25-26	I*2	SPARE
ENDDATEF	27-30	2I*2	The end time as YYYYMM of the data in the record.
SPARES	31-276	I*2	SPARES
I2MAP	277-23476	I*2	The mean values of the first 11600 I*2 elements of the 20626 elements of the Equal Areas/Equal Aspect Map

Table 9.3.1.2-3. Format of Monthly Mean Data Record 2 of a Hemisphere Pair..

Field	Bytes	Type	Description
RECTYP2	1-2	I*2	The indicator for the second record of the hemisphere: 03=Record 2 for the Northern Hemisphere; 05=Record 2 for the Southern Hemisphere.
FIELD	3-4	I*2	The Field mnemonic. (See Note 1)

NORS	5-6	I*2	The hemisphere indicator: 0=North; 1= South.
NCELL	7-186	90 I*2	The number of longitude bins in each of 90 latitude bands of the (current) Equal Areas/Equal Aspect Pathfinder Maps starting at the pole and abutting (to the west) the Greenwich Meridian.
SPARES	187-276	I*2	SPARES
I2MAP	277- 18328	I*2	The mean values of the last 9026 I*2 elements of the 20,626 elements of the Equal Areas/Equal Aspect Map
SPARE	18329-22036	I*2	SPARE
E2MAP	22037-23476	I*2	The 720 I*2 mean elements of the equatorial band data for the hemisphere

9.3.1.3 Seasonal/Annual Mean Radiation Budget Product

This file contains one season or one year of mean radiation budget data. It contains 25 records. The first record is the header. It contains six types of data: HIRS Night OLR, HIRS Day OLR, AVHRR Night OLR, AVHRR Day OLR, Available Solar Energy, and AVHRR SW Absorbed Radiation. Each type of data is associated with four records (the Northern Hemisphere pair and the Southern Hemisphere pair). The format of the header record has already been described in Table 9.3.1.2-1. The first data record of a hemisphere pair is described in Table 9.3.1.3-1, while data record 2 of a hemisphere pair is shown in Table 9.3.1.3-2.

Table 9.3.1.3-1. Format of Seasonal/Annual Mean Data Record 1 of a Hemisphere Pair.			
Field	Bytes	Type	Description
SPARE	1-2	I*2	SPARE
BCDDAY	3-4	I*2	The actual day number, relative to the satellite Epoch, of the first day in the period covered in file 1 (i.e. for monthly means the day is the relative to the first day of the month).
SPARES	5-12	I*2	SPARES

RCTYPE1	13-14	I*2	The indicator for the first record of the hemisphere: 02 = Record 1 for the Northern Hemisphere; 04 = Record 1 for the Southern Hemisphere.
SPARE	15-16	I*2	SPARE
FIELD	17-18	I*2	The Field mnemonic. (See Table 9.3.1.1-4).
NORS	19-20	I*2	The hemisphere indicator: 0= North; 1= South.
BEGINDATE	21-24	2 I*2	The start time as YYYYMM of the data in the record.
SPARE	25-26	I*2	SPARE
ENDDATEF	27-30	2 I*2	The end time as YYYYMM of the data in the record.
SPARES	31-276	I*2	SPARES
I2MAP	277- 23,476	I*2	The mean values of the first 11,600 I*2 elements of the 20,626 elements of the Equal Areas/Equal Aspect Map

Table 9.3.1.3-2. Format of Seasonal/Annual Mean Data Record 2 of a Hemisphere Pair.

Field	Bytes	Type	Description
RECTYP2	1-2	I*2	The indicator for the second record of the hemisphere: 03=Record 2 for the Northern Hemisphere; 05=Record 2 for the Southern Hemisphere.
FIELD	3-4	I*2	The Field mnemonic. (See Table 9.3.1.1-4).
NORS	5-6	I*2	The hemisphere indicator: 0= North; 1= South.

NCELL	7-186	90I*2	The number of longitude bins in each of 90 latitude bands of the (current) Equal Areas/Equal Aspect Pathfinder Maps starting at the pole and abutting (to the west) the Greenwich Meridian.
SPARES	187-276	I*2	SPARES
I2MAP	277-18,328	I*2	The mean values of the last 9026 I*2 elements of the 20626 elements of the Equal Areas/Equal Aspect Map
SPARE	18,329-22,036	I*2	SPARE
E2MAP	22,037-23,476	I*2	The 720 I*2 mean elements of the equatorial band data for the hemisphere

9.3.2 TIROS-N SERIES RADIATION BUDGET PRODUCTS

There are six types of digital Radiation Budget products archived by NOAA/NCDC. All radiation budget products are produced by the NOAA/NESDIS Office of Satellite Data Processing and Distribution's Product Systems Branch (OSDPD/PSB). The six types of Radiation Budget products are: 37 Day file, monthly radiation, seasonal radiation, monthly mean radiation, seasonal mean radiation and annual mean radiation budget products. These are described in the *NOAA Polar Orbiter Data Users Guide*, Section 5.4, which is available online at: <http://www.ncdc.noaa.gov/oa/pod-guide/ncdc/docs/podug/html/c5/sec5-4.htm>. There are seven months of these TIROS-N style products archived for NOAA-K (November 1998 through April 1999) which are available concurrently with the NOAA KLM style products for comparison/continuity purposes.

9.4 SOUNDING PRODUCTS (ATOVS AND AMSU-B)

Beginning with the NOAA-15 satellite, the sounding instrument suite was dramatically changed. The four-channel MSU instrument was replaced with a 20-channel AMSU instrument suite, AMSU-A for temperature and AMSU-B for moisture. The SSU instrument was dropped but AMSU-A essentially replaces its function. The HIRS, AMSU-A and AMSU-B instruments are described in Sections 3.2, 3.3 and 3.4, respectively. The ATOVS system is the 'TOVS' system for NOAA-15 and subsequent satellites. ATOVS uses the HIRS and AMSU-A to generate the retrieved profiles. The AVHRR instrument is used for cloud detection along with the HIRS and AMSU-A. The AMSU-B instrument is currently not part of the ATOVS system, primarily because of resource limitations in the development of the system. Therefore, the AMSU-B is processed independently of ATOVS using a slightly modified version of software developed and used to process the SSM/T-2 on the DMSP satellites. The AMSU-B system became operational

about one year after ATOVS because of satellite antenna interference in the AMSU-B data. NESDIS has expended a great deal of effort to reduce the interference and accurately account for the constant interference which remains. Refer to Appendix M for more details about the AMSU-B Bias Correction Algorithm.

NESDIS currently has the capability of producing a maximum of 370,000 soundings every 24 hours from two operational spacecraft. ATOVS from NOAA-15 generates about 300,000 retrievals every 24 hours with a 60 km resolution (40 km at nadir). AMSU-B from NOAA-15 generates about 1,400,000 moisture retrievals every 24 hours with a 15 km resolution and 15 km spacing between retrievals; the data are sampled to reduce the data volume by half. Section 9.4.1 describes the ATOVS format, while Section 9.4.2 describes the AMSU-B format.

9.4.1 ATOVS SOUNDING PRODUCT (APRIL 27, 1999 - PRESENT)

The ATOVS archive (NOAA KLM series) is substantially different from the TOVS archive (TIROS-N, NOAA-6 through NOAA-14 series). Users that need a description of the format used for the TOVS Sounding Product between January 1979 and March 8, 1992, should refer to Section 5.1 of the *NOAA Polar Orbiter Data User's Guide*. ATOVS retrievals are made at 40 km spacing at nadir and up to 80 km at the limb. The ATOVS archive is actually four separate archive products. The first is the retrieval archive which is the full resolution archive of the ATOVS products, processed orbitally. The second archive is the metadata archive which consists of weekly statistics comparing the ATOVS retrievals to radiosonde data. The third archive is the Radiosonde Match Archive which contains radiosonde and retrieval data collocated in time and space. The final ATOVS archive product is the coefficient data base (CDB). The CDB contains the primary coefficients used in the generation of the ATOVS retrievals. Some coefficients are constants, others are satellite dependent and another set is updated on a weekly basis. The CDB is a very complex file and is not described in this section. Documentation about the CDB will be provided with any CDB product requested.

9.4.1.1 ATOVS Sounding Retrieval Archive Data File

The ATOVS retrieval archive data file contains complete sounding data, retrieval products and data quality flags. The Retrieval Archive Data File is in all integer format with data values scaled by values such as 64 or 128. The file contains records of length 1,000 bytes with a block size of 9,000 bytes. The first record in each file is the header record which is the same size as the data records and is described in Table 9.4.1.1-1. Records 2 through N (the number of records) contain the retrieval records, in that the data frame record N+1 contains the data frame header for the next data frame. A typical orbit has 28 data frames. The format of each ATOVS retrieval data record is described in Table 9.4.1.1-2. The archive product has been filtered for super adiabatic retrievals. Even though there is a super adiabatic flag it will always return no super adiabatic data. Precipitation contaminated data is included in the archive. However it is not advisable to use this data with the same weight as the rest of the product for temperature or moisture retrieval analysis. The ATOVS archive contains parameters that were not archived in TOVS or RTOVS. These are

cloud information (cloud top pressure and temperature, cloud amount) and radiation budget information (outgoing longwave radiation, layer cooling rates), and the sulfur dioxide content. These terms should be used with caution, even though they are archived as part of the ATOVS product, they are very new products and not fully proven for accuracy. The fill value for this file is -32768, missing is typically all I*2 bits set.

Table 9.4.1.1-1. Format of header record for ATOVS retrieval data file.				
Starting Byte	I*4 Location	Length	# of values	Description
1	1	4	1	Number of data records in the file
5	2	4	1	First data record written in file (2)
9	3	4	1	Last data record written
13	4	4	1	Logical record length
17	5	4	1	Spacecraft ID
21	n/a	3	1	File type (RET)
25	n/a	8	1	Satellite name (e.g. NOAA 15)
34	n/a	44	1	File name
79	n/a	10	1	File creation data (YYYYMMDDHH)
89	23	4	1	Beginning orbit number
93	24	4	1	Ending orbit number
97	25	4	1	Time of first retrieval (YYYYMM)
101	26	4	1	Time of first retrieval (DDHH)
105	27	4	1	Time of first retrieval (mmss)
109	28	4	1	Time of last retrieval (YYYYMM)
113	29	4	1	Time of last retrieval (DDHH)
117	30	4	1	Time of last retrieval (mmss)
121	31-67	4	37	Spares

Table 9.4.1.1-2. Format of ATOVS Retrieval Data Record.

Byte #	Integer Index	# of Values	Length	Scale	Description
1	1	1	2	n/a	Record type (2=data record)
3	2	1	2	n/a	Satellite number (XX from "NOAA-XX")
5	3	1	2	n/a	Data frame number from beginning of Level 1b data
7	4	1	2	n/a	Beginning orbit number
9	5	1	2	n/a	Ending orbit number
11	6	5	2	n/a	Spare
21	11	1	2	n/a	Surface elevation (m)
23	12	7	2	n/a	Spare
37	19	1	2	n/a	4-digit retrieval year
39	20	2	2	n/a	Valid forecast date/time (YYMM, DDHH)
43	22	1	2	n/a	Spare
45	23	1	2	n/a	Retrieval grid point number (counter over the retrieval grid of 28 spots by 20 lines)
47	24	1	2	128	Retrieval latitude (-90 to +90 degrees)
49	25	1	2	128	Retrieval longitude (-180 to +180 degrees)
51	26	3	2	n/a	Retrieval time (YYMM, DDHH, mmss)
57	29	1	2	n/a	Precipitation flag: 0=no precipitation; 1=precipitation

59	30	1	2	n/a	Terrain flag: 0=sea; 1=land; 2=coast; 10=sea ice; 11=snow
61	31	1	2	n/a	Day/Night flag: 0=night; 1=day.
63	32	1	2	n/a	Test or production version number
65	33	1	2	n/a	Processing flag: 0=unsuccessful; 1=successfully processed
67	34	1	2	128	Solar zenith angle (degrees)
69	35	1	2	128	Satellite (local) zenith angle (degrees)
71	36	1	2	n/a	Geographical index (bin number 1-23). (See Table 9.4.1.1-3.)
73	37	1	2	128	Solar azimuth angle (degrees)
75	38	1	2	n/a	HIRS spot number (1-56)
77	39	1	2	n/a	Orbital node: 1=ascending; 2=descending
79	40	1	2	n/a	Super adiabatic flag: 0=not super adiabatic; 1=super adiabatic between 700 mb and 1000 mb; 2=super adiabatic between 500 mb and 700 mb; 3=super adiabatic between 100 mb and 500 mb; 4=super adiabatic above 100 mb

81	41	1	2	n/a	Observation quality flag: 0=good; 2=failed gross temperature limits for HIRS and AMSU-A or is polar redundant or is super adiabatic, do not use for distribution, tuning or evaluation)
83	42	1	2	n/a	Retrieval flag: 0=clear; 32=cloudy; 48=no-HIRS (one or more HIRS channel is missing or out of bounds)
85	43	1	2	n/a	Spare
87	44	1	2	n/a	Spare
89	45	42	2	64	Retrieved temperature profile (K). See note 1.
173	87	40	2	64	Adjusted brightness temperatures (limb-corrected and cloud-detection performed) (K). See note 2.
253	127	35	2	64	Bias corrected, limb-corrected, cloud-detection performed brightness temperatures (K). See note 2.
323	162	35	2	64	Non-limb corrected, cloud-detection performed brightness temps (K). See note 2.
393	197	42	2	n/a	Geopotential heights (m). See note 1.
477	239	19	2	1024	Water vapor mixing ratios, ln (g/kg). See note 3.
515	258	1	2	64	Tropopause temperature (K)
517	259	1	2	n/a	Tropopause pressure (mb)
519	260	1	2	128	Total precipitable water (mm)
521	261	15	2	128	Layer precipitable water (mm). See note 4.

551	276	15	2	64	Layer mean virtual temperature (K). See note 4.
581	291	20	2	n/a	Layer thicknesses (m). See note 5.
621	311	1	2	n/a	Spare
623	312	1	2	n/a	Spare
625	313	1	2	n/a	Spare
627	314	9	2	n/a	Spare
645	323	1	2	64	Sea surface temperature from internal map (K) (set to missing when SST map has land but terrain map has sea).
647	324	1	2	64	Derived skin temperature value (K)
649	325	1	2		Surface model level (ATOVS pressure level which is the closest retrieval pressure level to the surface pressure. Always level 40 over sea.)
651	326	1	2	64	Retrieved surface temperature (Bt) (K)
653	327	1	2	64	Water Vapor corrected HIRS channel 8 (Bt) (K)
655	328	1	2	64	Surface temperature estimate for HIRS channel 8 (K)
657	329	1	2	64	Surface temperature estimate for HIRS channel 18 (K)
659	330	1	2	64	Surface temperature estimate for HIRS channel 19 (K)
661	331	42	2	64	First Guess temperature profile (K). See note 1.
743	373	19	2	1024	First Guess water vapor mixing ratio, ln (g/kg). See note 3.
783	392	35	2	64	First Guess radiance temperatures (K). See note 2.

853	427	1	2	64	NCEP forecast potential temperature (K)
855	428	1	2	256	NCEP forecast relative humidity (%)
857	429	1	2	64	NCEP forecast surface temperature (K)
859	430	1	2	10	Adjusted NCEP forecast surface pressure (mb)
861	431	1	2	10	Forecast pressure (mb)
863	432	1	2	100	Potential temperature time minus NCEP forecast time
865	433	1	2	512	Stability departure
867	434	1	2	512	Lower departure
869	435	1	2	512	Upper departure
871	436	1	2	n/a	Time difference (satellite minus forecast)
873	437	1	2	n/a	Stability forecast increment
875	438	1	2	n/a	Cloud liquid water (mm)
877	439	1	2	64	Cloud top temperature (K): 0=clear; -777=missing.
879	440	1	2	n/a	Cloud top pressure (mb): 1250=clear; -777=missing.
881	441	1	2	100	Cloud amount: 0=clear; -777=missing.
883	442	1	2	n/a	Total ozone (dobson units)
885	443	1	2	128	Total precipitable water from 300 mb to 500 mb (mm)
887	444	1	2	128	Total precipitable water from 500 mb to 700 mb (mm)

889	445	1	2	128	Total precipitable water from 700 mb to 1000 mb (mm)
891	446	1	2	n/a	Sulfur Dioxide (ppm or ppb)
893	447	1	2	n/a	Polar redundancy flag: -1=not redundant; 1=redundant.
895	448	1	2	10	Outgoing longwave radiation (W/m^2)
897	449	1	2	1000	Layer cooling rate (240 mb to 10 mb) (W/m^2)
899	450	1	2	1000	Layer cooling rate (500 mb to 240 mb) (W/m^2)
901	451	1	2	1000	Layer cooling rate (700 mb to 500 mb) (W/m^2)
903	452	1	2	1000	Layer cooling rate (1000 to 700 mb) (W/m^2)
905	453	1	2	n/a	Cloud comparison flag (cloud detection vs. cloud products): 0 (good) =clear retrieval + clear cloud algorithm 0 (good) = cloudy retrieval + cloudy cloud algorithm 1 (bad) = clear retrieval +cloudy cloud algorithm 2 (so-so)= cloudy retrieval + clear cloud algorithm
907	454	1	2	n/a	Library search closeness (pho) value
909	455	1	2	n/a	Super adiabatic level (1-42) (level where profile became super adiabatic - set to missing if no super adiabatic levels are found)
911	456	1	2	n/a	HIRS/AMSU-A gross temperature flag: 0=all temperatures within limits; 1=temperatures out of bounds.
913	457	44	2	n/a	Spare

Notes:

1. ATOVS Temperature Levels 1-40 in millibars (0.1, 0.2, 0.5, 1.0, 1.5, 2, 3, 4, 5, 7, 10, 15, 20, 25, 30, 50, 60, 70, 85, 100, 115, 135, 150, 200, 250, 300, 350, 400, 430, 475, 500, 570, 620, 700, 780, 850, 920, 950, 1000,1012, 1030). Geopotential heights are represented in meters from 115 to 1030 mb, and in decimeters from 0.1 through 100mb. Currently, the parameters for the 1012 and 1030 mb levels are not computed, but are planned for the future.

2. Channel ordering - HIRS channels 1-20 are stored first, then AMSU-A 1-15.

3. ATOVS Water Vapor levels 1-19 in millibars (200, 250, 300, 350, 400, 430, 475, 500, 570, 620, 700, 780, 850, 920, 950, 1000, 1012, and 1030). Currently, the parameters for the 1012 and 1030 mb levels are not computed, but are planned for the future.

4. ATOVS Layer temperature and moisture values 1-15 in millibars (7-10, 10-20, 20-30, 30-50, 50-70, 70-100, 100-150, 150-200, 200-250, 250-300, 300-400, 400-500, 500-700, 700-850, 850-1000). Although the moisture array goes to 7mb, moisture is computed to 200 mb, early ATOVS data goes to 300 mb.

5. Layer thicknesses 1-20 in millibars (100-115, 115-135, 135-150, 150-200, 200-250, 250-300, 300-350, 350-400, 400-470, 470-500, 500-570, 570-620, 620-700, 700-780, 780-850, 850-920, 920-950, 950-1000, 1000-1012, 1012-1030). The thickness below 1000mb is not currently computed but is planned for the future.

Table 9.4.1.1-3. Geographical Bins for ATOVS.

Class Number	Latitude Zone	Terrain	Day/Night
1	90N to 60N	Sea	Day/Night
2	60N to 45N	Sea	Day/Night
3	45N to 30N	Sea	Day/Night
4	30N to 15N	Sea	Day/Night
5	15N to 15S	Land/Sea	Day/Night
6	15S to 30S	Sea	Day/Night
7	30S to 45S	Sea	Day/Night
8	45S to 60S	Land/Sea	Day/Night

9	60S to 90S	Sea	Day/Night
10	90N to 60N	Land	Day
11	60N to 45N	Land	Day
12	45N to 30N	Land	Day
13	30N to 15N	Land	Day
14	15S to 30S	Land	Day
15	30S to 45S	Land	Day
16	60S to 90S	Land	Day
17	90N to 60N	Land	Night
18	60N to 45N	Land	Night
19	45N to 30N	Land	Night
20	30N to 15N	Land	Night
21	15S to 30S	Land	Night
22	30S to 45S	Land	Night
23	60S to 90S	Land	Night

9.4.1.2 ATOVS Sounding Quality Information (Metadata Archive) File

This section describes the format for the ATOVS quality information file. Each week, one record of data is written to this file. The data records contain 3380 Integer*2 words. Each record contains data for six latitude zones: 90N to 60N, 60N to 30N, 30N to 0, 0 to 30S, 30S to 60S, and 60S to 90S. The file is a rotating file; the first record (header record) is updated each week and contains the start date (year, month, and date of the next week's data, the next available record and the maximum records on the file). There are four data files for each week of Metadata Statistics: 1) Level Temperature statistics; 2) Layer Temperature statistics; 3) Mixing Ratio statistics; and 4) Brightness Temperature statistics. Table 9.4.1.2-1 contains the format for the header record which is the first record in the metadata archive file. Table's 9.4.1.2-2, 9.4.1.2-3, 9.4.1.2-4 and 9.4.1.2-5 contain the formats of the data records.

Table 9.4.1.2-1. Format of Metadata Archive Header Record.					
Start Byte	Data Type	# of Values	Length (bytes)	Scale	Description
1	Char	1	2	n/a	Spare
3	Char	1	4	I*4	Next beginning year
7	Char	1	2	I*2	Next beginning month
9	Char	1	2	I*2	Next beginning day
11	Char	1	6	I*6	Spare
17	Char	1	2	I*2	Next record on file to write to
19	Char	1	6	I*6	Spare
25	Char	1	2	I*2	Maximum record on file to write to
27	Char	n/a	3853	n/a	Spares

Table 9.4.1.2-2. Format of Data Record 1 of Metadata archive file.				
Data Record 1 - ATOVS Level temperature (40,4,6) 40 - levels 4 - statistics (1-mean, 2-root mean square, 3-standard deviation, and 4-sample size) 6 - zones				
Start Byte	# of Values	Length (bytes)	Scale	Description
1	1	8	I*8	File record number
11	1	4	I*4	Beginning year of data
15	1	2	I*2	Beginning month of data
17	1	2	I*2	Beginning day of data (total of 7 days of data)
19	1	22	A*22	Information Character (i.e. ATOVS LEVEL TEMP STATS)
41	960	3840	(1..40,1..4,1..6)	Level temperatures statistics

41	240	960	(1..40,1,1..6)	Level temps Mean Difference from RAOB
1001	240	960	(1..40,2,1..6)	Root Mean Square
1961	240	960	(1..40,3,1..6)	Standard Deviation
2921	240	959	(1..40,4,1..6)	Sample Size

Table 9.4.1.2-3. Format of Data Record 2 of Metadata archive file.

Data Record 2 - Layer Thickness temperatures (20,4,6)

20 - layers

4 - statistics (1-mean, 2-root mean square, 3-standard deviation, and 4-sample size)

6 - zones

Start Byte	# of Values	Length (bytes)	Scale	Description
1	1	8	I*8	File record number
11	1	4	I*4	Beginning year of data
15	1	2	I*2	Beginning month of data
17	1	2	I*2	Beginning day of data (total of 7 days of data)
19	1	22	A*22	Information Character (i.e. LAYER THICK STATS)
41	480	1920	(1..20,1..4,1..6)	Layer Thickness Statistics
41	120	480	(1..20,1,1..6)	Layer Thickness Mean
521	120	480	(1..20,2,1..6)	Root Mean Square
1001	120	480	(1..20,3,1..6)	Standard Deviation
1481	120	480	(1..20,4,1..6)	Sample Size
1961	n/a	1919	n/a	Spares

Table 9.4.1.2-4. Format of Data Record 3 of Metadata archive file.

Data Record 3 - Level Mixing Ratios (19,4,6) 19 - channels 4 - statistics (1-mean, 2-root mean square, 3-standard deviation, and 4-sample size) 6 - zones				
Start Byte	# of Values	Length (bytes)	Scale	Description
1	1	8	I*8	File record number
11	1	4	I*4	Beginning year of data
15	1	2	I*2	Beginning month of data
17	1	2	I*2	Beginning day of data (total of 7 days of data)
19	1	22	A*22	Information Character (i.e. LEVEL MIXING RATIOS)
41	456	1824	(1..19,1..4,1..6)	Level Mixing Ratios statistics
41	114	456	(1..19,1,1..6)	Level Mixing Ratios
497	114	456	(1..19,2,1..6)	Root Mean Square
953	114	456	(1..19,3,1..6)	Standard Deviation
1409	114	456	(1..19,4,1..6)	Sample Size
1865	n/a	2015	n/a	Spares

Table 9.4.1.2-5. Format of Data Record 4 of Metadata archive file.

Data Record 4 - Brightness temperatures RAOB - Derived (35,4,6) 35 - 20 HIRS & 15 AMSU-A channels 4 - statistics (1-mean, 2-root mean square, 3-standard deviation, and 4-sample size) 6 - zones				
Start Byte	# of Values	Length (bytes)	Scale	Description
1	1	8	I*8	File record number

11	1	4	I*4	Beginning year of data
15	1	2	I*2	Beginning month of data
17	1	2	I*2	Beginning day of data (total of 7 days of data)
19	1	22	A*22	Information Character (i.e. BRI TEMPERATURE STATS)
41	840	3360	(1..35,1..4,1..6)	Layer Thickness Statistics
41	210	840	(1..35,1,1..6)	Layer Thickness Mean
881	210	840	(1..35,2,1..6)	Root Mean Square
1721	210	840	(1..35,3,1..6)	Standard Deviation
2661	210	840	(1..35,4,1..6)	Sample Size
3601	n/a	279	n/a	Spares

9.4.1.3 ATOVS Radiosonde Matchup Archive File

The ATOVS data matched to radiosondes will be added to the suite of archived sounding products. The matchups of retrieval and radiosonde have gone through an extensive screening process. Thus, both profiles in the file are considered as 'good' and used as input to the retrieval process. The records in this file are 3,000 bytes in length. Table 9.4.1.3-1 contains the format of the header record for the radiosonde matchup file. Each bin or class also has a header record which is described in Table 9.4.1.3-2. The radiosonde standard levels (in millibars) are: 5, 7, 10, 20, 30, 50, 70, 100, 150, 200, 250, 300, 400, 500, 700, 850 and 1000.

Table 9.4.1.3-1. Format of Header Record for Radiosonde Matchup File.						
Byte	Integer Index	Data Type	# of Values	Length	Scale	Description
1	1	Int	1	4	n/a	Date of last file update (YYYYMMDD)
5	2	Int	1	4	n/a	Number of records in the file
9	3	Int	1	4	n/a	Last record containing valid data

13	4	Int	1	4	n/a	Data of most recent data (YYYYMMDD)
17	5	Int	1	4	n/a	File Type: 1=clear; 2=cloudy
21	6	Int	1	4	n/a	Satellite ID (i.e., 15 for NOAA-15)
25	7	Int	3	4	n/a	Spare
37	10	Int	1	4	n/a	Number of classes in the file
41	11	Int	1	4	n/a	First record for class 1
45	12	Int	1	4	n/a	First record for class 2
49	13	Int	1	4	n/a	First record for class 3
53	14	Int	1	4	n/a	First record for class 4
57	15	Int	1	4	n/a	First record for class 5
61	16	Int	1	4	n/a	First record for class 6
65	17	Int	1	4	n/a	First record for class 7
69	18	Int	1	4	n/a	First record for class 8
73	19	Int	1	4	n/a	First record for class 9
77	20	Int	1	4	n/a	First record for class 10
81	21	Int	1	4	n/a	First record for class 11
85	22	Int	1	4	n/a	First record for class 12
89	23	Int	1	4	n/a	First record for class 13
93	24	Int	1	4	n/a	First record for class 14
97	25	Int	1	4	n/a	First record for class 15
101	26	Int	1	4	n/a	First record for class 16
105	27	Int	1	4	n/a	First record for class 17
109	28	Int	1	4	n/a	First record for class 18

113	29	Int	1	4	n/a	First record for class 19
117	30	Int	1	4	n/a	First record for class 20
121	31	Int	1	4	n/a	First record for class 21
125	32	Int	1	4	n/a	First record for class 22
129	33	Int	1	4	n/a	First record for class 23
133	34	Int	716	4	n/a	Spare

Table 9.4.1.3-2. Format of Class Header Record for Radiosonde Matchup File.						
Byte	Int Index	Data Type	# of Values	Length (bytes)	Scale	Description
1	1	Int	1	2	n/a	Record type (1=class header record)
3	2	Int	1	2	n/a	Class number
5	3	Int	1	2	n/a	Maximum number of matchups in this class
7	4	Int	1	2	n/a	Actual number of matchups in this class
9	5	Int	1	2	n/a	First data record within this class
11	6	Int	1	2	n/a	Last data record within this class
13	7	Int	1493	2	n/a	Spare

Table 9.4.1.3-3 contains the format of the data records in the radiosonde matchup file.

Table 9.4.1.3-3. Format of Data Records for the Radiosonde Matchup File.					
Start Byte	Int Index	# of Values	Length	Scale	Description
Retrieved Data					

1	1	1	2	n/a	Record type (2=data record)
3	2	1	2	n/a	Satellite number (XX from "NOAA-XX")
5	3	1	2	n/a	Data frame number from beginning of Level 1b data
7	4	1	2	n/a	Beginning orbit number
9	5	1	2	n/a	Ending orbit number
11	6	5	2	n/a	Spares
21	11	1	2	n/a	Surface elevation (m)
23	12	7	2	n/a	Spares
37	19	1	2	n/a	4-digit retrieval year
39	20	2	2	n/a	Valid forecast date/time (YYMM, DDHH)
43	22	1	2	n/a	Spare
45	23	1	2	n/a	Retrieval grid point number (counter over the retrieval grid of 28 spots by 20 lines)
47	24	1	2	128	Retrieval latitude (-90 to +90 degrees)
49	25	1	2	128	Retrieval longitude (-180 to +180 degrees)
51	26	3	2	n/a	Retrieval time (YYMM, DDHH, mmss)
57	29	1	2	n/a	Precipitation flag: 0=no precip; 1=precip
59	30	1	2	n/a	Terrain flag: 0=sea; 1=land; 2=coast; 10= sea ice; 11=snow.

61	31	1	2	n/a	Day/Night flag: 0=night; 1=day.
63	32	1	2	n/a	Test or production version number
65	33	1	2	n/a	Processing flag: 0=unsuccessful; 1=successfully processed.
67	34	1	2	128	Solar zenith angle (degrees)
69	35	1	2	128	Satellite (local) zenith angle (degrees)
71	36	1	2	n/a	Geographical index (bin number 1-23) See Table 9.4.3-2a.
73	37	1	2	128	Solar azimuth angle (degrees)
75	38	1	2	n/a	HIRS spot number (1-56)
77	39	1	2	n/a	Orbital node: 1=ascending; 2=descending.
79	40	1	2	n/a	Super adiabatic flag: 0=not super adiabatic; 1=super adiabatic between 700mb and 1000mb; 2=super adiabatic between 500mb and 700mb; 3=super adiabatic between 100mb and 500mb; 4=super adiabatic above 100mb.
81	41	1	2	n/a	Observation quality flag: 0=good; 2=failed gross temperature limits for HIRS and AMSU-A or is polar redundant or is super adiabatic.

83	42	1	2	n/a	Retrieval flag: 0=clear; 32=cloudy; 48=no HIRS (one or more HIRS channels missing or out of bounds).
85	43	1	2	n/a	Spare
87	44	1	2	n/a	Spare
89	45	42	2	64	Retrieved temperature profile (K)
173	87	40	2	64	Adjusted brightness temperatures (limb-corrected and cloud-detection performed) (K)
253	127	35	2	64	Bias corrected, Limb-corrected, cloud detection performed brightness temperatures (K)
323	162	35	2	64	Non-limb corrected, cloud detection performed brightness temperatures (K)
393	197	42	2	n/a	Geopotential heights (m)
477	239	19	2	1024	Water vapor mixing ratios, ln (g/kg)
515	258	1	2	64	Tropopause temperature (K)
517	259	1	2	n/a	Tropopause pressure (mb)
519	260	1	2	128	Total precipitable water (mm)
521	261	15	2	128	Layer precipitable water (mm)
551	276	15	2	64	Layer mean virtual temperature (K)
581	291	20	2	n/a	Layer thicknesses (m)
621	311	1	2	n/a	Spare
623	312	1	2	n/a	Spare
625	313	1	2	n/a	Spare
627	314	9	2	n/a	Spare

645	323	1	2	64	Sea surface temperature from internal map (K) (Set to missing when SST map has land but terrain map has sea.)
647	324	1	2	64	Derived skin temperature value (K)
649	325	1	2	n/a	Surface model level (ATOVS level closest to surface elevation)
651	326	1	2	64	Retrieved surface temperature (Bt) (K)
653	327	1	2	64	Water Vapor corrected HIRS channel 8 (Bt) (K)
655	328	1	2	64	Surface temperature estimate for HIRS channel 8 (K)
657	329	1	2	64	Surface temperature estimate for HIRS channel 18 (K)
659	330	1	2	64	Surface temperature estimate for HIRS channel 19 (K)
661	331	42	2	64	First Guess temperature profile (K)
745	373	19	2	1024	First Guess water vapor mixing ratio, ln (g/kg)
783	392	35	2	64	First Guess radiance temperatures (K)
853	427	1	2	64	NCEP forecast potential temperature (K)
855	428	1	2	256	NCEP forecast relative humidity (%)
857	429	1	2	64	NCEP forecast surface temperature (K)
859	430	1	2	10	Adjusted NCEP forecast surface pressure (mb)
861	431	1	2	10	Forecast pressure (mb)
863	432	1	2	100	Potential temperature time minus NCEP forecast time
865	433	1	2	512	Stability departure

867	434	1	2	512	Lower departure
869	435	1	2	512	Upper departure
871	436	1	2	n/a	Time difference (satellite minus forecast)
873	437	1	2	n/a	Stability forecast increment
875	438	1	2	n/a	Cloud liquid water (mm)
877	439	1	2	64	Cloud top temperature (K): 0=clear; -777=missing.
879	440	1	2	n/a	Cloud top pressure (mb): 1250=clear; -777 = missing.
881	441	1	2	100	Cloud amount: 0=clear; -777 = missing.
883	442	1	2	n/a	Total ozone (dobson)
885	443	1	2	128	Total precipitable water from 300 to 500mb (mm)
887	444	1	2	128	Total precipitable water from 500 to 700mb (mm)
889	445	1	2	128	Total precipitable water from 700 to 1000mb (mm)
891	446	1	2	n/a	Sulfur Dioxide (ppm or ppb)
893	447	1	2	n/a	Polar redundancy flag: -1=not redundant; 1=redundant.
895	448	1	2	10	Outgoing longwave radiation (W/m^2)
897	449	1	2	1000	Layer cooling rate from 240mb to 10mb (W/m^2)
899	450	1	2	1000	Layer cooling rate from 500mb to 240mb (W/m^2)

901	451	1	2	1000	Layer cooling rate from 700mb to 500mb (W/m ²)
903	452	1	2	1000	Layer cooling rate from 1000mb to 700mb (W/m ²)
905	453	1	2	n/a	Cloud comparison flag (cloud detection vs. cloud products): Clear retrieval + Clear cloud algorithm =0 (good); Cloudy retrieval + cloudy cloud algorithm = 0 (good); Clear retrieval + cloudy cloud algorithm = 1 (bad); Cloudy retrieval + clear cloud algorithm = 2 (so-so).
907	454	1	2	n/a	Library search closeness (pho) value
909	455	1	2	n/a	Super adiabatic level (1-42)
911	456	1	2	n/a	HIRS/AMSU-A gross temperature flag: 0= all temperatures within limits; 1 = one or more temperatures out of bounds.
913	457	44	2	n/a	Spares
Matchup Information					
1001	501	1	2	n/a	Matchup test pass/fail flag: 0=pass; 1=fail.
1003	502	8	2	n/a	Matchup test flags
1019	510	13	2	n/a	Spares
1045	523	1	2	n/a	Archive Flag: 1 = record has been written to Archive (Matchup Database Holding and Archive files only).
1047	524	1	2	n/a	Library flag: 0=not used in library; 1=used in library.

1049	525	1	2	n/a	Difference in time (hours) between RAOB/Retrieval
1051	526	1	2	n/a	Difference in distance (km) between RAOB/Retrieval
1053	527	1	2	64	Closeness parameter
1055	528	1	2	n/a	Matchup Utility Index
Radiosonde Data					
1057	529	1	2	n/a	Radiosonde station ID (ASCII(1st char)*100 + (ASCII(2nd char))
1059	530	1	2	n/a	Radiosonde station ID (ASCII(3rd char)*100 + (ASCII(4th char))
1061	531	1	2	n/a	Radiosonde station ID (ASCII(5th char)*100 + (ASCII(6th char))
1063	532	3	2	n/a	Radiosonde day of synoptic report (YY, MM, DD)
1069	535	3	2	n/a	Radiosonde balloon release date (YY, MM, DD)
1075	538	1	2	100	Radiosonde observation time (hours in UTC)
1077	539	1	2	128	Radiosonde latitude (-90 to +90 degrees)
1079	540	1	2	128	Radiosonde longitude (-180 to +180 degrees)
1081	541	1	2	n/a	Radiosonde station elevation (m)
1083	542	1	2	n/a	Radiosonde instrument type
1085	543	1	2	n/a	Radiosonde report type
1087	544	1	2	n/a	Radiosonde terrain : 0=sea; 1 =land; 2=coast.

1089	545	1	2	64	Lowest reported pressure (mb)
1091	546	1	2	64	Highest reported pressure (mb)
Radiosonde test flags (0=pass, 1=fail)					
1093	547	1	2	n/a	Radiosonde pass/fail flag
1095	548	1	2	n/a	Vertical extent flag
1097	549	1	2	n/a	Data gap flag
1099	550	1	2	n/a	Profile super adiabatic flag
1101	551	1	2	n/a	Profile inversion flag
1103	552	1	2	n/a	Spare
1105	553	1	2	n/a	Profile climatological limits flag
1107	554	1	2	n/a	Spare
Radiosonde quality flags (0=pass, 1=fail)					
1109	555	1	2	n/a	Standard level relative humidity not within limits flag
1111	556	1	2	n/a	Standard level relative humidity missing flag
1113	557	1	2	n/a	Standard level temperature not within limits flag
1115	558	1	2	n/a	Tropopause temperature not within limits flag
1117	559	1	2	n/a	Standard level temperature inaccurate flag
1119	560	1	2	n/a	Tropopause temperature inaccurate flag
1121	561	1	2	n/a	Data gaps in temperature data flag
1123	562	1	2	n/a	Radiosonde vertical extent failure flag
1125	563	1	2	n/a	Standard level relative humidity inaccurate flag

1127	564	1	2	n/a	Significant level relative humidity missing flag
1129	565	1	2	n/a	Significant level relative humidity vertical extent flag
1131	566	1	2	n/a	Tropopause pressure limits flag
1133	567	1	2	n/a	Super adiabatic layers flag
1135	568	1	2	n/a	Temperature inversions flag
1137	569	1	2	n/a	Tropopause data missing flag
1139	570	1	2	n/a	Surface inversion flag
1141	571-612	42	2	64	Radiosonde temperatures (C)
1225	613-631	19	2	1024	Radiosonde water vapor mixing ratios (ln g/kg)
1263	632	1	2	n/a	Radiosonde tropopause temperature (C)
1265	633	1	2	n/a	Radiosonde tropopause pressure (mb)
1267	634	1	2	n/a	Radiosonde surface pressure (mb)
1269	635	1	2	n/a	Radiosonde surface temperature (C)
1271	636	1	2	1024	Radiosonde surface water vapor mixing ratio (ln g/kg)
1273	637	1	2	1024	Water vapor mixing ratio at lowest reported level (ln g/kg)
1275	638	1	2	1024	Water vapor mixing ratio at highest reported level (ln g/kg)
1277	639	3	2	100	Layer precipitable water from reported Radiosonde data (mm)
1283	642	1	2	100	Total precipitable water from reported Radiosonde data (mm)
1285	643	18	2	100	Layer precipitable water from extrapolated RAOB data (mm)

1321	661	16	2	n/a	Spares
Category 1 Radiosonde Data (standard levels)					
1353	677	17	2	n/a	Standard level geopotential heights (m)
1387	694	17	2	10	Standard level temperatures (C)
1421	711	17	2	10	Standard level dewpoint depressions (C)
1455	728	17	2	n/a	Standard level wind direction (degrees)
1489	745	17	2	n/a	Standard level wind speed (knots)
1523	762	17	2	n/a	Standard level geopotential height QC flags (ASCII)
1557	779	17	2	n/a	Standard level temperature QC flags (ASCII)
1591	796	17	2	n/a	Standard level dewpoint depression QC flags (ASCII)
1625	813	17	2	n/a	Standard level wind QC flags (ASCII)
1659	830	17	2	n/a	Standard level "missing" flags (ASCII)
Category 2 Radiosonde Data (significant levels)					
1693	847	1	2	n/a	Number of significant levels
1695	848	50	2	10	Significant level pressure (mb)
1795	898	50	2	10	Significant level temperature (C)
1895	948	50	2	10	Significant level dewpoint depression (C)
1995	998	50	2	n/a	Significant level pressure QC flags (ASCII)
2095	1048	50	2	n/a	Significant level temperature QC flags (ASCII)
2195	1098	50	2	n/a	Significant level dewpoint depression QC flags (ASCII)

2295	1148	50	2	n/a	Significant level spare QC flags (ASCII)
2395	1198	50	2	n/a	Significant level "missing" flags (ASCII)
Category 3 Radiosonde Data (wind data)					
2495	1248	1	2	n/a	Number of wind levels
2497	1249	25	2	10	Wind level pressure (mb)
2547	1274	25	2	n/a	Wind direction (degrees)
2597	1299	25	2	n/a	Wind speed (knots)
2647	1324	25	2	n/a	Wind level pressure QC flags (ASCII)
2697	1349	25	2	n/a	Wind level wind QC flags (ASCII)
2747	1374	25	2	n/a	Wind level spare QC flags (ASCII)
2797	1399	25	2	n/a	Wind level spare QC flags (ASCII)
Category 5 Radiosonde Data (tropopause data)					
2847	1424	2	2	10	Tropopause pressure (mb)
2851	1426	2	2	10	Tropopause temperature (C)
2855	1428	2	2	10	Tropopause dewpoint depression (C)
2859	1430	2	2	n/a	Tropopause wind direction (degrees)
2863	1432	2	2	n/a	Tropopause wind speed (knots)
2867	1434	2	2	n/a	Tropopause level pressure QC flags (ASCII)
2871	1436	2	2	n/a	Tropopause level temperature QC flags (ASCII)
2875	1438	2	2	n/a	Tropopause level dewpoint depression QC flags (ASCII)
2879	1440	2	2	n/a	Tropopause level wind QC flags (ASCII)

2883	1442	2	2	n/a	Tropopause "missing" flags (ASCII)
Category 7 Radiosonde Data (cloud cover)					
2887	1444	1	2	n/a	Number of cloud levels (0 or 1)
2889	1445	1	2	10	Pressure at bottom of clouds (mb)
2891	1446	1	2	n/a	Cloud cover percentage increments of 5, (less than 5% reported as 0)
2893	1447-1500	54	2	n/a	Spares

9.4.2 AMSU-B SOUNDING PRODUCTS

In addition to the ATOVS products, NOAA KLM also generates AMSU-B data from which moisture products are generated. The AMSU-B instrument has a FOV of 15 km. The data generated from the AMSU-B instrument is sampled by skipping every other FOV. This generates a product of about 30 km spacing with a maximum of 100,000 retrievals per orbit.

Each archive file consists of all valid sounding data extracted from the original retrieval file for the most recent AMSU-B orbit. Except for the header record, an orbit archive file has all integer terms with data values scaled by numbers such as 64 and 128. The archive file has a block size of 10,720 bytes with record lengths of 268 bytes. The first record of the database is the header (see Table 9.4.2-1) which provides information such as the last record written and the number of records. The header record uses I*4 words and is the same size as the data records (268 bytes).

Table 9.4.2-1. Header Record Format of Orbit Archive File.				
Starting Byte	I*4 Location	Length (bytes)	# of values	Description
1	1	4	1	Number of data records in the file
5	2	4	1	First data record written in file (2)
9	3	4	1	Last data record written
13	4	4	1	Logical record length
17	5	4	1	Spacecraft ID
21	n/a	3	1	File type (RET)

25	n/a	8	1	Satellite name (NOAA-xx)
34	n/a	44	1	File name
79	n/a	10	1	File creation date (YYYYMMDDHH)
89	23	4	1	Beginning orbit number
93	24	4	1	Ending orbit number
97	25	4	1	Time of first retrieval (YYYYMM)
101	26	4	1	Time of first retrieval (DDHH)
105	27	4	1	Time of first retrieval (mmss)
109	28	4	1	Time of last retrieval (YYYYMM)
113	29	4	1	Time of last retrieval (DDHH)
117	30	4	1	Time of last retrieval (mmss)
121	31-67	4	1	Spares

Records 2 through N (the number of records) contain the retrieval records. Table 9.4.2-2 contains the format of the retrieval data records.

Table 9.4.2-2. Format of Orbit Archive File Retrieval Data Records.					
Starting Byte	I*2 Location	Length (bytes)	# of Values	Scaling Factor	Description
1	1	2	1	1	Record type (2=data record)
3	2	2	1	1	FOV number in the scan line
5	3	2	1	1	Spare
7	4	2	1	1	Orbit number
9	5	2	1	1	FOV time (YYMM)
11	6	2	1	1	FOV (DDHH)
13	7	2	1	1	FOV (mmss)
15	8	2	1	128	FOV latitude (degrees)

17	9	2	1	128	FOV longitude (degrees)
19	10	2	1	128	Solar zenith angle (degrees)
21	11	2	1	128	Satellite zenith angle (degrees)
23	12	2	1	1	Terrain type 0=sea; 1=land; 2=coast; 16=ice; 17=snow.
25	13	2	1	1	Surface elevation (m)
27	14	2	1	1	Surface pressure (mb)
29	15	2	1	64	Skin temperature (K)
31	16	2	1	1	Day/Night indicator 0=night, 1=day.
33	17	2	3	1	Channel combination flag
39	20	2	1	1	Observation quality flag
41	21	2	15	1024	Natural log of AMSU-B water vapor mixing ratios (g/kg)
71	36	2	5	64	Limb corrected AMSU-B temperatures (K)
81	41	2	5	64	Bias Corrected observed AMSU-B temperatures (K)
91	46	2	5	64	First Guess bias corrected AMSU-B temperatures (K)
101	51	2	15	1024	Natural log of first guess water vapor mixing ratios (g/kg)
131	66	2	1	1	First Guess temperature profile flag
133	67	2	40	64	First Guess temperature profile
213	107	2	7	64	Spares

227	114	2	1	1	Forecast increment
229	115	2	1	64	Forecast potential temperature (K)
231	116	2	1	64	Forecast surface air temperature (K)
233	117	2	1	10	Forecast surface pressure (mb)
235	118	2	1	1	Forecast relative humidity (%)
237	119	2	1	1	Retrieval - forecast time difference
239	120	2	1	100	Cloud liquid water (cm)
241	121	2	3	100	Layer precipitable water (cm)
247	124	2	1	64	First Guess skin temperature (K)
249	125	2	1	64	First Guess surface temperature (K)
251	126	2	1	10	First Guess surface pressure (mb)
253	127	2	1	1	First Guess relative humidity (%)
255	128	2	1	1	Scan number
257	129	2	5	64	AMSU-B antenna temperature (K)
267	134	2	1	100	Total precipitable water (cm)

9.4.2.1 AMSU-B Metadata Archive File

The AMSU-B Metadata Archive File is a rotating file. The first record is updated each week and contains the start date (year, month, and day of the next week’s data, the next available record and the maximum records on the file). The metadata archive file consists of a header record (1,000 bytes), followed by two data files for each week of metadata statistics: one file contains mixing ratio statistics, the other file contains brightness temperature statistics. Table 9.4.2.1-1 contains the format for the header record of the AMSU-B metadata archive file. Tables’ 9.4.2.1-2 and 9.4.2.1-3 contain the formats of the data files.

Table 9.4.2.1-1. Format of the Header Record of the AMSU-B Metadata Archive File.					
Start Byte	Data Type	# of values	Length (bytes)	Dimension	Description
1	C	1	1	n/a	Spare

2	C	1	10	I10	Next beginning year
11	C	1	10	I10	Next beginning month
21	C	1	10	I10	Next beginning day
31	C	1	10	I10	Next record on file to write to
41	C	1	10	I10	Maximum record on file to write to
51	C	n/a	950	n/a	Spares

Table 9.4.2.1-2. Format of AMSU-B Metadata Archive File, Data Record A (Mixing Ratios) (15, 4, and 6).

15 levels (300, 350, 400, 430, 475, 500, 570, 620, 670, 700, 780, 850, 920, 950, 1000 mb)
4 statistics (1 - mean, 2 - root mean square, 3 - standard deviation, 4 - sample size)
6 zones (90.0 to 60.0, 60.0 to 30.0, 30.0 to 0.0, 0.0 to -30.0, -30.0 to -60.0 and -60.0 to -90.0 degrees latitude)

Start Byte	# of values	Length (bytes)	Dimension	Description
1	1	6	I*6	File record number
7	1	6	I*6	Beginning year of data
13	1	6	I*6	Beginning month of data
19	1	6	I*6	Beginning day of data (total of 7 days of data)
25	1	36	A*36	Information Character (i.e., MIXING RATIO STATISTICS)
61	360	780	(15,4,6)	Mixing Ratio Statistics
	90	180	(1,1,1)	Mixing ratio mean difference from RAOB
	90	180	(1,2,1)	Root mean square
	90	180	(1,3,1)	Standard Deviation
	90	180	(1,4,1)	Sample Size
781	n/a	220	n/a	Spares

Table 9.4.2.1-3. Format of AMSU-B Metadata Archive File, Data Record B (Brightness Temperatures) (5,4,6).				
5 channels (channels 1 through 5) 4 statistics (1 - mean, 2 - root mean square, 3 - standard deviation, 4 - sample size) 6 zones (90.0 to 60.0, 60.0 to 30.0, 30.0 to 0.0, 0.0 to -30.0, -30.0 to -60.0 and -60.0 to -90.0 degrees latitude)				
Start Byte	# of values	Length (bytes)	Dimension	Description
1	1	6	I*6	File record number
7	1	6	I*6	Beginning year of data
13	1	6	I*6	Beginning month of data
19	1	6	I6	Beginning day of data (total of 7 days of data)
25	1	36	A*36	Information Character (i.e., BRIGHTNESS TEMP STATISTICS)
61	120	300	(5,4,6)	Brightness Temperature Statistics
	30	60	(1,1,1)	Brightness Temperature Mean difference from RAOB derived
	30	60	(1,2,1)	Root mean square
	30	60	(1,3,1)	Standard Deviation
	30	60	(1,4,1)	Sample Size
301	n/a	700	n/a	Spares

9.4.2.2 AMSU-B Radiosonde Match Archive

A new radiosonde match archive file is created once a month. Each archive file consists of all valid retrieval-radiosonde matches extracted from the AMSU-B Match Archive for the previous month. Except for the header record, the radiosonde match archive file is in all integer format with data values either unscaled or scaled by values from 64 to 1024. The header record provides information such as the last record written and the number of records. All integer values in the header are four bytes long. The records are 2,484 bytes in length with a block size of 27,324 bytes. Table 9.4.2.2-1 contains the format of the header record and Table 9.4.2.2-2 contains the format of the data records for the radiosonde match archive file. In the data records, real values have been stored in I*2 format after first multiplying the real value by the scaling factor.

Table 9.4.2.2-1. Format of Header record for AMSU-B Radiosonde Match Archive File.

Starting Byte	I*4 Location	Length (bytes)	# of values	Description
1	1	4	1	Number of data records in the file
5	2	4	1	First data record written in file (2)
9	3	4	1	Last data record written
13	4	4	1	Logical record length
17	5	4	1	Spacecraft ID
21	n/a	3	1	File type ('ARC')
25	n/a	6	1	Satellite name ('NOAA xx')
31	n/a	1	3	Spares
34	n/a	24	1	File name
58	n/a	1	3	Spares
61	n/a	8	1	File creating date (YYYYMMDD)
69	n/a	20	1	Spare
89	23	4	1	Time of first retrieval (YYYYMM)
93	24	4	1	Time of first retrieval (DDHH)
97	25	4	1	Time of first retrieval (mmss)
101	26	4	1	Time of last retrieval (YYYYMM)
105	27	4	1	Time of last retrieval (DDHH)
109	28	4	1	Time of last retrieval (mmss)
113	29-621	4	2368	Spare

Table 9.4.2.2-2. Format of Data record for AMSU-B Radiosonde Match Archive File.

Start Byte	Integer Location	Length (bytes)	# of values	Scale	Description
-------------------	-------------------------	-----------------------	--------------------	--------------	--------------------

1	n/a	6	1	1	Radiosonde station ID
7	4	2	1	128	Station latitude (-90 to 90 degrees)
9	5	2	1	128	Station longitude (-180 to 180 degrees)
11	6	2	1	1	Station elevation (m)
13	n/a	8	1	1	Satellite ID ('NOAA xx')
21	11	2	1	128	Retrieval latitude (-90 to 90 degrees)
23	12	2	1	128	Retrieval longitude (-180 to 180 degrees)
25	13	2	3	1	Retrieval time ¹
31	16	2	1	1	Orbit Number
33	17	2	1	1	Beam position
35	18	2	1	1	Archive flag (1=archived)
37	n/a	1	2	1	Spare
Satellite Observations:					
39	20	2	1	128	Solar Zenith angle (degrees)
41	21	2	1	128	Satellite Zenith angle (degrees)
43	n/a	1	1	1	Terrain flag 0=sea, 1=land, 2=coast, 10=sea ice, 11=snow
44	n/a	1	1	1	Spare
45	23	2	1	1	Surface Elevation (m)
47	24	2	1	1	Surface Pressure (mb)
49	25	2	1	64	Mapped skin temp (NCEP SST) (K)
51	n/a	1	1	1	Day/night flag 0=night, 1=day

52	n/a	1	6	1	Channel combination
58	n/a	1	1	1	Observation quality flag ²
59	30	2	15	1024	Retrieved water vapor mix ratios ³ (g/kg)
89	45	2	5	64	Limb corrected brightness temperatures (K)
99	50	2	5	64	Bias corrected brightness temperatures (K)
109	55	2	5	64	First Guess brightness temperatures (K)
119	60	2	15	1024	First Guess mixing ratios ³ (g/kg)
149	75	1	1	1	First Guess temperature profile flag
150	n/a	1	1	1	Spare
151	76	2	40	64	First Guess atmospheric temperatures (K) (set to missing)
231	116	2	7	1	Spares
245	123	1	1	1	Forecast increment
246	n/a	1	1	1	Extrapolation flag (set to '0')
247	124	2	1	64	Forecast potential temperature (K)
249	125	2	1	64	Forecast surface air temperature (K)
251	126	2	1	10	Forecast surface pressure (mb)
253	127	2	1	1	Forecast relative humidity (%)
255	128	2	1	1	Retrieval-Forecast time difference
257	129	2	1	100	Cloud liquid water (g/cm ²)
259	130	2	3	512	Layer precipitable water (cm)
265	133	2	1	64	First Guess potential temperature/surface air temperature (K)
267	134	2	1	1	First Guess humidity (%)
269	135	2	1	64	First Guess skin temperature (K)
Interpolated Radiosonde Profile:					

271	136	2	40	64	Interpolated atmospheric temperatures (K)
351	176	2	15	1024	Interpolated water vapor mixing ratios ³ (g/kg)
381	191	2	1	64	Interpolated tropopause temperatures (K)
383	192	2	1	1	Interpolated tropopause pressure (mb)
385	193	2	1	1	Interpolated surface pressure (mb)
387	194	2	1	64	Interpolated surface temperature (K)
389	195	2	1	1024	Interpolated surface mixing ratio ³ (g/kg)
391	196	2	1	100	RAOB profile used: 0=preceding RAOB used 1=succeeding RAOB used
393	197	2	5	64	Simulated RAOB brightness temperatures (K)
403	202	2	1	1	Highest level reached by RAOB
405	203	2	1	1	Lowest level reached by RAOB
407	n/a	1	1	1	Primary/secondary matchup flag: 1=primary; 2=secondary.
408	n/a	1	12	1	Screening flags
420	n/a	1	1	1	Spare
421	211	2	3	100	Layer Precipitable Water (cm)
427	214	2	1	100	Total Precipitable Water (cm)
429	n/a	1	8	1	Spare
Preceding Radiosonde Station Report:					
437	n/a	6	1	1	Radiosonde station ID
443	n/a	2	3	1	Day of synoptic report ⁴
449	n/a	2	3	1	Balloon release date ⁵
455	228	2	1	100	Observation time (UTC hours)

457	229	2	1	128	Latitude (-90 to 90 degrees)
459	230	2	1	128	Longitude (-180 to 180 degrees)
461	231	2	1	1	Station elevation (m)
463	232	2	1	1	Instrument type
465	233	2	1	1	Report type
Preceding Radiosonde Station Report Category 1 Data (Standard Levels):					
17 successive levels from 1000 mb of the following information: starting byte = 466 + 14 x (level-1) + starting byte integer position = 233 + 7(level-1) + integer location xx = 01 to 17					
1	n/a	2	1	1	Geopotential height (m)
3	n/a	2	1	10	Temperature (C)
5	n/a	2	1	10	Dewpoint depression (C)
7	n/a	2	1	1	Wind direction (degrees)
9	n/a	2	1	1	Wind speed (knots)
11	n/a	1	1	1	Geopotential height QC flag
12	n/a	1	1	1	NCEP temperature QC flag
13	n/a	1	1	1	NCEP dewpoint QC flag
14	n/a	1	1	1	NCEP wind QC flag
Preceding Radiosonde Station Report Category 2 Data (Significant Levels):					
705	353	2	1	1	Number of significant levels
50 successive levels from the surface of the following information: starting byte = 706 + 10 x (level-1) + starting byte integer position = 353 + 5 x (level-1) + integer location xx = 01 to 50					
1	1	2	1	10	Pressure (mb)
3	2	2	1	10	Temperature (C)

5	3	2	1	10	Dewpoint depression (C)
7	n/a	1	1	1	NCEP Pressure QC flag
8	n/a	1	1	1	NCEP temperature QC flag
9	n/a	1	1	1	NCEP dewpoint QC flag
10	n/a	1	1	1	Spare flag
Preceding Radiosonde Station Report Category 3 Data (Winds):					
1,207	604	2	1	1	Number of significant wind levels
<p>25 successive levels from the surface of the following information: starting byte = 1,208 + 8 x (level -1) + starting byte integer position = 604 + 4 x (level-1) + integer location xx = 01 to 25</p>					
1	1	2	1	10	Pressure (mb)
3	2	2	1	1	Wind direction (degrees)
5	3	2	1	1	Wind speed (knots)
7	n/a	1	1	1	NCEP pressure QC flag
8	n/a	1	1	1	NCEP wind QC flag
Preceding Radiosonde Station Report Category 5 Data (Tropopause):					
<p>2 levels of the following information: starting byte = 1,408 +14 x (level - 1) + starting byte integer position = 704 + 7 x (level-1) + integer location xx = 01 to 02</p>					
1	1	2	1	10	Pressure (mb)
3	2	2	1	10	Temperature (C)
5	3	2	1	10	Dewpoint depression (C)
7	4	2	1	1	Wind direction (degrees)
9	5	2	1	1	Wind speed (knots)
11	n/a	1	1	1	NCEP pressure QC flag

12	n/a	1	1	1	NCEP temperature QC flag
13	n/a	1	1	1	NCEP dewpoint depression QC flag
14	n/a	1	1	1	NCEP wind QC flag
Reconstructed Profile Flags for Preceding Radiosonde:					
1,437	n/a	151	1	1	Reconstructed RAOB report flags
1,452	n/a	3	1	1	Matchup usefulness flags
1,455	n/a	1	1	1	Surface inversion
1,456	n/a	1	1	1	Terrain type
1,457	n/a	1	1	1	Co-location time window
1,458	n/a	3	1	1	Reserved for future use
Succeeding Radiosonde Station Report:					
1,461	n/a	6	1	1	Radiosonde station ID
1,467	n/a	2	3	1	Day of synoptic report ⁴
1,473	n/a	2	3	1	Balloon release date ⁵
1,479	740	2	1	100	Observation time in hours (UTC)
1,481	741	2	1	128	Latitude (-90 to 90 degrees)
1,483	742	2	1	128	Longitude (-180 to 180 degrees)
1,485	743	2	1	1	Station elevation (m)
1,487	744	2	1	1	Instrument type
1,489	745	2	1	1	Report type
Succeeding Radiosonde Station Report Category 1 Data (Standard Levels):					
17 successive levels from 1000 mb of the following information: starting byte = 1,490 + 14 x (level-1) + starting byte integer position = 745 + 7 x (level-1) + integer location xx = 01 to 17					
1	1	2	1	1	Geopotential height (m)

3	2	2	1	10	Temperature (C)
5	3	2	1	10	Dewpoint depression (C)
7	4	2	1	1	Wind direction (degrees)
9	5	2	1	1	Wind speed (knots)
11	n/a	1	1	1	Geopotential height QC flag
12	n/a	1	1	1	NCEP temperature QC flag
13	n/a	1	1	1	NCEP dewpoint QC flag
14	n/a	1	1	1	NCEP wind QC flag
Succeeding Radiosonde Station Report Category 2 Data (Significant Levels):					
1,729	865	2	1	1	Number of significant levels
50 successive levels from the surface of the following information: starting byte = 1,730 + 10 x (level-1) + starting byte integer position = 865 + 5 x (level-1) + integer location xx = 01 to 50					
1	1	2	1	10	Pressure (mb)
3	2	2	1	10	Temperature (C)
5	3	2	1	10	Dewpoint depression (C)
7	n/a	1	1	1	NCEP pressure QC flag
8	n/a	1	1	1	NCEP temperature QC flag
9	n/a	1	1	1	NCEP dewpoint QC flag
10	n/a	1	1	1	Spare flag
Succeeding Radiosonde Station Report Category 3 Data (Winds):					
2,231	1,116	2	1	1	Number of significant wind levels
25 successive levels from the surface of the following information: starting byte = 2,232 + 8 x (level-1) + starting byte integer position = 1,116 + 4 x (level-1) + integer location xx = 01 to 25					

1	1	2	1	10	Pressure (mb)
3	2	2	1	1	Wind direction (degrees)
5	3	2	1	1	Wind speed (knots)
7	n/a	1	1	1	NCEP pressure QC flag
8	n/a	1	1	1	NCEP wind QC flag
Succeeding Radiosonde Station Report Category 5 Data (Tropopause):					
<p>2 levels of the following information: starting byte = 2,432 + 14 x (level-1) + starting byte integer position = 1,216 + 7 x (level-1) + integer location xx = 01 to 02</p>					
1	1	2	1	10	Pressure (mb)
3	2	2	1	10	Temperature (C)
5	3	2	1	10	Dewpoint depression (C)
7	4	2	1	1	Wind direction (degrees)
9	5	2	1	1	Wind speed (knots)
11	n/a	1	1	1	NCEP pressure QC flag
12	n/a	1	1	1	NCEP temperature QC flag
13	n/a	1	1	1	NCEP dewpoint depression QC flag
14	n/a	1	1	1	NCEP wind QC flag
Reconstructed Profile Flags for Succeeding Radiosonde:					
2,461	n/a	15	1	1	Reconstructed RAOB report flags ⁶
2,476	n/a	3	1	1	Matchup usefulness flags ⁶
2,479	n/a	1	1	1	Surface inversion
2,480	n/a	1	1	1	Terrain type
2,481	n/a	1	1	1	Co-location time window
2,482	n/a	3	1	1	Reserved for future use

Notes:

1. YYMM DDHH mmss, where YY is the year, MM is the month, DD is the day, HH is the hour, mm is the minute, and ss is the number of seconds (UTC).
2. 0=good; 1=good, but redundant; 2=questionable; 3=bad; 4=experimental flag; 5=precipitating.
3. Mixing ratios are converted to their natural logs before being scaled.
4. The synoptic day for which the observation was made (YYMMDD).
5. The day that the balloon was actually released (YYMMDD). For observations at 0000z, the balloon is actually released at approximately 2330z. The balloon release time is frequently reported as the observation time, although the synoptic time is more commonly reported. In order to sort observations into chronological order, the balloon release date and time should be used.
6. Each byte represents a different flag, set to a character value "0" if FALSE and to the character value "1", if TRUE.

9.5 COASTWATCH PRODUCTS

The CoastWatch Program mission is to provide and ensure timely access to near real-time satellite data to protect, restore, and manage U.S. coastal ocean resources, and understand climate variability and change to further enhance society's quality of life. Primary users include Federal, State, and local marine scientists, coastal resource managers, and the general public. CoastWatch is comprised of two components: Central Operations and Regional Nodes. Central Operations, managed by NOAA's National Environmental Satellite, Data, and Information Service (NESDIS) coordinates the processing, delivery, quality control and storage of data products. The six regional nodes are made up of other NOAA line offices that participate in the CoastWatch Program. They are located around the country, hosting equipment and personnel to provide near real-time data distribution and regional scientific expertise to the local user community. Together, central operations and the regional nodes provide for the distribution pathway for CoastWatch data products (see Section 9.5.1 for further information on central operations and the regional nodes).

CoastWatch started with only POES/AVHRR SST data for the East Coast in 1987, but now provides a variety of imagery and data from several different platforms covering all U.S. coastal waters. All products are available through the CoastWatch website product search: <http://coastwatch.noaa.gov/interface/interface.html> Note: since this User's Guide deals exclusively with POES data, emphasis will be placed on the POES CoastWatch products. Use this link for additional information on CoastWatch POES/AVHRR data http://coastwatch.noaa.gov/poes_sst_overview.html.

The images displayed on the NOAA CoastWatch website are created from satellite datasets. For many uses, these images provide enough information and are easily viewed over the Internet. However, the datasets are not viewable by Internet browsers and may require specialized

software to view, manipulate, and extract the information as needed. CoastWatch provides software utilities and data primers to assist in using these data products. http://coastwatch.noaa.gov/cw_software.html

Retrospective availability of CoastWatch POES data products are provided through a remotely accessible system at the Comprehensive Large Array-data Stewardship System (CLASS) website: <http://www.class.noaa.gov/nsaa/products/welcome>. CLASS replaces the Satellite Active Archive and their website provides users with data formats and details pertinent to the type of CoastWatch data the user chooses to download.

CoastWatch data products utilize five receiving stations around the country that collect data from the AVHRR sensor on the NOAA KLM polar orbiting spacecrafts. They include Gilmore Creek, AK for the four Alaska regions; Monterey, CA for the West Coast; Miami, FL for the Caribbean and Gulf of Mexico waters; Ewa Beach, HI for Central Pacific; and Wallops Island, VA for the East Coast and Great Lakes. Data are processed on NOAA computers in Suitland, MD using a set of NOAA developed multi-channel atmospherically corrected algorithms for determination of sea surface temperature. Data are then mapped to predefined coordinates specified for each of the CoastWatch regions.

Table 9.5-1. CoastWatch Region Specifications.

Region Code	Region Name	Latitude	Longitude	Res. (km)	Size		Map Projection
					Rows	Cols	
aa	Alaska Sitka	45.949	-179.07	5.0	512	512	Polar Stereographic
ax	Alaska South	55.0	-132.5	1.47	1200	1400	Polar Stereographic
ay	Alaska West	58.0	-159.0	1.47	1200	1400	Polar Stereographic
az	Alaska North	69.5	-159.0	1.47	1024	1024	Polar Stereographic
ce	Caribbean East	15.5	-68.0	1.47	1180	1400	Mercator
cw	Caribbean West	15.5	-85.0	1.47	1180	1400	Mercator
er	East Coast North	39.0	-70.5	1.47	1401	1302	Mercator
gr	Great Lakes	45.04	-84.14	1.8	1024	1024	Mercator
hr	Hawaii	19.808	-157.05	1.47	1394	1394	Mercator
mr	Gulf of Mexico	24.6	-89.0	1.47	1101	1401	Mercator
sb	East Coast Bermuda	27.0	-68.0	1.47	1200	1200	Mercator
sl	Great Salt Lake	41.54	-112.83	1.47	512	512	Mercator
sr	East Coast South	30.0	-80.32	1.47	1248	1140	Mercator
wa	West Coast Acapulco	17.0	-102.0	1.47	1180	1400	Mercator
wj	West Coast Baja	27.25	-113.60	1.47	1024	1024	Mercator

wn	West Coast North	45.0	-128.25	1.47	1024	1024	Mercator
ws	West Coast South	36.5	-121.50	1.47	1024	1024	Mercator
*Note: the Latitude/Longitude coordinates are for the center point of the region.							

Variable Naming Conventions

Each HDF data file contains multiple data variables stored using the HDF Scientific Data Sets (SDS) model. Each variable is named according to the data that it represents as follows:

avhrr_ch1

AVHRR channel 1 albedo (%)

avhrr_ch2

AVHRR channel 2 albedo (%)

avhrr_ch3a

AVHRR channel 3a albedo (%)

avhrr_ch3

AVHRR channel 3 brightness temperature (deg C)

avhrr_ch4

AVHRR channel 4 brightness temperature (deg C)

avhrr_ch5

AVHRR channel 5 brightness temperature (deg C)

sst

Moisture corrected sea-surface-temperature (deg C)

cloud

8-bit CLAVR ocean cloud mask:

Daytime

Bit 1: Reflective Gross Cloud Test

Bit 2: Reflectance Uniformity Test

Bit 3: Reflectance Ratio Cloud Test

Bit 4: Channel 3 Albedo Test

Bit 5: Thermal Uniformity Test

Bit 6: Four Minus Five Test

Bit 7: Thermal Gross Cloud Test

Nighttime

Bit 1: Thermal Gross Cloud Test

Bit 2: Thermal Uniformity Test

Bit 3: Uniform Low Stratus Test

Bit 4: Four Minus Five Test

Bit 5: Cirrus Test

Bit 6: Channel 3B Albedo Test

Bit 7: Channel 3B Albedo Uniformity Test

sat_zenith

Satellite zenith angle (degrees)
sun_zenith
Solar zenith angle (degrees)
rel_azimuth
Relative azimuth angle (degrees)
graphics
8-bit graphics layers:
Bit 1: Fill flag
Bit 2: Latitude/longitude grid
Bit 3: Coastline and political geography lines
Bit 4: Land/water flag
Bits 5-8: Unused

*Note: AVHRR channels 1 and 2, solar zenith, and relative azimuth angles are only useful for daytime data; therefore these variables are omitted from the nighttime data files.

9.5.1 HOW TO OBTAIN COASTWATCH DATA

9.5.1.1 CoastWatch Regional Nodes

Alaska - Gary Hufford
NOAA/NWS - Alaska Region
222 W. 7th Avenue #23, Room 517
Anchorage, AK 99513-7575
Phone: (907) 271-3886
Fax: (907) 271-3711
E-mail: Gary.Hufford@noaa.gov
URL: <http://cwatch.arh.noaa.gov>

Caribbean/Gulf of Mexico – Thomas Leming
NOAA/NMFS Southeast Fisheries Science Center
Bldg. 1103, Room 218
Stennis Space Center, MS 39529-6000
Phone: (228) 688-1214
Fax: (228) 688-1151
E-mail: Thomas.D.Leming@noaa.gov
URL: <http://cwcarribbean.aoml.noaa.gov>

Central Pacific (Hawaii) - Dr. Jeffrey J. Polovina
NOAA/NMFS Southwest Fisheries Science Center
Honolulu Laboratory
2570 Dole Street
Honolulu, HI 96822-2396
Phone: (808) 983-5390

Fax: (808) 983-2902
E-mail: Jeffrey.Polovina@noaa.gov
URL: <http://oceanwatch.pifsc.noaa.gov>

East Coast Node
410 Severn Avenue
Annapolis, MD 21403
Phone: (410) 267-5660
Fax: (410) 267-5666
URL <http://coastwatch.chesapeakebay.noaa.gov>

Great Lakes – George A. Leshkevich
NOAA/OAR/Great Lakes Environmental Laboratory
2205 Commonwealth Blvd.
Ann Arbor, MI 48105-1593
Phone: (734) 741-2265
Fax: (734) 741-2055
E-mail: George.Leshkevich@noaa.gov
URL: <http://coastwatch.glerl.noaa.gov>

West Coast - Dr. Cara Wilson
NOAA/NMFS Southwest Fisheries Science Center
8604 La Jolla Shores Drive (P.O. Box 271)
La Jolla, Ca 92038-0271
Phone: (831) 648-5337
Fax: (831) 648-8440
E-mail: Cara.Wilson@noaa.gov
URL: <http://coastwatch.pfel.noaa.gov/>

9.5.1.2 CoastWatch Central Operations

Program Manager - Kent H. Hughes
NOAA/NESDIS/ Office of Research and Applications
Phone: (301) 763-8102 X171
Fax: (301) 763-8572
E-mail: kent.hughes@noaa.gov
URL: <http://coastwatch.noaa.gov>

CoastWatch Help Desk -
SP Systems, Inc. for NOAA/NESDIS/ Office of Research and Applications
Phone: (301) 763-8102 X349
Fax: (301) 763-8572
Email: Shawna.Karlson@noaa.gov
URL: <http://coastwatch.noaa.gov>

Central Support:

Central Processing- John Sapper

NOAA/NESDIS/ Office of Satellite Data Processing and Distribution

Phone: (301) 763-8142 ex 103

Fax: (301) 899-9196

E-mail: John.Sapper@noaa.gov

URL: <http://www.osdpd.noaa.gov/PSB/EPS/EPS.html>

POES SST Validation – William Pichel

NOAA/NESDIS/ Office of Research and Applications

Phone: (301) 763-8231 X166

Fax: (301) 763-8020

E-mail: William.G.Pichel@noaa.gov

URL: <http://www.orbit.nesdis.noaa.gov/sod/orad/sod/>

Comprehensive Large Array-data Stewardship System (CLASS)

NOAA/NESDIS

Phone: (301) 763-8598 X349

Fax: (301) 763-8838

URL: <http://www.class.noaa.gov>

9.6 INTEGRATED SURFACE AND PRECIPITATION PRODUCTS

The following sections describe the newest operational products using a variety of sensors flown on NOAA's satellites. Many of the products are created by integrating data from several sensors, which creates instrument/spectrum-independent, parameter-independent, and platform-independent timely products to help meteorologists and climatologists monitor and forecast changes in surface and atmospheric conditions.

NESDIS has an extensive history of monitoring snow and ice coverage. Accurate monitoring of global snow/ice cover is a key component in the study of climate and global change as well as daily weather forecasting. NESDIS has been creating maps showing the extent of snow and ice cover for the Northern Hemisphere since 1966. The snow and ice maps were produced weekly at a spatial resolution of 190 km from 1966 to 1999.. The Interactive Multisensor Snow and Ice Mapping System (IMS) replaced the weekly mapping process in June 1999 and improved the snow and ice map by producing daily maps at 23 km resolution, using a consolidated array of new as well as existing satellite and surface imagery products. Another large resolution improvement began in early 2004, when improved technology allowed the creation of a daily 4 km (6144x6144) chart. These charts can be ordered from the [National Climatic Data Center](#).

The Microwave Surface and Precipitation Products System (MSPPS) produced near real-time operational surface and precipitation products from the AMSU-A, AMSU-B and MHS

instruments aboard NOAA and METOP satellites. The operational products included Antenna Temperatures, Total Precipitable Water, Cloud Liquid Water, Sea Ice Concentration, Land Surface Temperature, Land Surface Emissivity at 23.8, 31.4 and 50.3 GHz, Snow Cover, Rain Rate, Snow Water Equivalent and Ice-Water Path. Both Level-II (orbital) and Level-III (grid) products are available. The MSPPS grid products include Snow Cover, Rain Rate and Snow-Water Equivalent from AMSU-B/MHS and Sea Ice Concentration from AMSU-A. These level 3 geophysical products are mapped with the 1/16th-mesh Polar Stereographic projection and updated daily. They are available in HDF-EOS format for the period from 1998 to 2007 in CLASS.

The MSPPS was replaced by the Microwave Integrated Retrieval System (MIRS) in August 2007. The MIRS has an end to end capability of calibrating and characterizing the radiances measured from satellite-based microwave instruments, and retrieving the environmental data records with state-of-the-art algorithm science. It is a one-stop resource for microwave-derived products from various polar-orbiting satellite instrument configurations. The MIRS strength is derived from being instrument/spectrum-independent, parameter-independent, and platform-independent.

9.6.1 WEEKLY SNOW AND ICE MAPPING

During the 1966 to 1999 weekly snow and ice mapping era, the primary data source was Advanced Very High Resolution Radiometer (AVHRR) hardcopy visible imagery acquired from NOAA Polar Operational Environmental Satellite (POES, United States). Secondary data sources included on-line visible imagery from Geostationary Operational Environmental Satellite (GOES, U.S.), Geostationary Meteorological Satellite (GMS, Japan), and European Meteorological Satellite (METEOSAT, European Organization for the Exploitation of Meteorological Satellites), hardcopy National Ice Center (NIC, U.S.) sea ice edge maps, the United States Air Force (USAF) three-dimensional (3-D) Nephanalysis snow product, and surface observations. These products became available at various times in subsequent years. The two crucial problems with the weekly product when used for short-term forecasting were its temporal and spatial resolution. The infrequency of the weekly product created significant errors in the near surface temperature forecasts when the map was used for initialization of the National Weather Service's (NWS) Numerical Weather Prediction (NWP) models, and the grid used in the models had a higher resolution than the weekly snow and ice map.

Snow and ice cover identification was made by the manual inspection of hardcopy polar orbiting satellite imagery and graphics products, on-line video loops of multiple geostationary satellite images, and the previous week's analysis. The former process was largely manual and time consuming, and took up to ten hours to produce a map during the snow season. Map quality was dependent upon the availability of clear sky visible satellite imagery and the meteorologist's experience. The analysis from the previous week was carried forward when cloud cover obstructed the view of the snow/ice boundary during the entire week. The final hardcopy 190 kilometer resolution snow and ice chart was prepared by the analyst by manually transferring the

observed boundary lines to the map after all snow and ice boundaries were identified. The polar stereographic base map displayed coastlines, seas and large lakes, international and U.S. state political boundaries, and a latitude-longitude grid. Snow cover was indicated by the irregular solid black lines contiguous with the stippling. Ice cover was delineated by the base map's coastlines and contiguous open circles. The map's key listed the satellites from which imagery was used in preparing the final map. Each week the analyst drew a new map by hand, then digitized the extent of snow and ice cover through the use of an 89x89 line grid overlaid on a polar stereographic map of the Northern Hemisphere which created an electronic version for archival storage at the National Climate Data Center (NCDC). Quality control was either self-imposed by the meteorologist performing the analysis or by the focal point meteorologist. Upon completion, the hardcopy snow and ice chart was faxed to users in the NWS National Centers for Environmental Prediction (NCEP) which included the Environmental Modeling Center and the Climate Prediction Center, the U.S. Department of Agriculture, universities, foreign governments, and other customers.

9.6.2 INTERACTIVE MULTISENSOR SNOW AND ICE MAPPING SYSTEM: 1999 - PRESENT

The Interactive Multisensor Snow and Ice Mapping System (IMS) was designed and built to improve the previously produced weekly snow and ice map by producing a more accurate, timely product. Clear sky imagery from both the NOAA POES and GOES show the snow line very well. The problem is that current visible and infrared analysis techniques suffer from persistent cloud cover near the snow boundary. This makes daily observations difficult and infrequent. Microwave snow products are generally independent of cloud cover. However, snow and ice analyses based on visible, infrared, or microwave satellite imagery have varying accuracies under certain environmental conditions or over specific types of terrain. It's therefore advantageous to allow a meteorologist to assess satellite imagery and derived snow maps from multiple remote sensing instruments and data sources, and from them interactively produce a composite that is more accurate than the individual snow cover maps.

IMS is a UNIX-based workstation application. It provides the capability for an analyst to create, save, edit, and distribute maps showing the extent of snow and ice cover over the Earth's Northern Hemisphere with a resolution of 23 kilometers. Snow and ice mapping is performed daily in approximately one to two hours. New data sources available on the workstation, in addition to the data sets used in producing the former weekly snow and ice map (see Section 9.6.1), include the Special Sensor Microwave/Imager (SSM/I) snow map from Defense Meteorological Satellite Program (DMSP) satellites, daily snow maps from the NWS National Operational Hydrologic Remote Sensing Center (NOHRSC), and NOAA-15's Advanced Microwave Sounding Unit (AMSU) snow cover map. Imagery from the AVHRR/3 1.6 micron channel, selected for its ability to discriminate snow cover from clouds, will be provided by NOAA-16. Data overlays of elevation contours, coastlines and rivers, and geopolitical boundaries are also available. IMS editing features allow toggling between two or more snow maps and other mapped data sets, such as land cover maps. The software produces a final snow map with appropriate header information and with an ancillary map containing information about

data sources and quality flags.

The IMS workstation's graphical user interface (GUI) is able to display an entire Northern Hemisphere daily snow and ice map or portions thereof. The snow and ice map depicts snow in white, ice in yellow, land in beige, and water in dark blue. The GUI provides pull down menus in the upper left corner of the screen for file retrieval and storage, access to editing tools, image display, annotation of images, and access to help text. A tool palette of draw and edit icons is located on the upper right side of the screen. These icons provide the means for map rotation in 90 degree units, undoing the last action taken, the exclusive drawing and erasure of snow and ice, zooming in on a given area, reversion from zoom mode to a normal view (a 1024x1024 pixel matrix), clearing the screen of snow or ice, and fine detail addition or deletion of snow or ice in non-contiguous snow or ice areas. Static overlay buttons provide data layers consisting of coastlines, elevation at 500 meter intervals, land use, latitude-longitude grid, international boundaries, U.S. state and Canadian provincial political boundaries, rivers and lakes, climatological snow maps and vegetation indices. Other available functions include the option to clear the overlays or imagery from the screen as well as toggling between two images or maps. The command line of buttons at the bottom of the GUI provides access to a variety of imagery and derived products including visible imagery from AVHRR, GOES, GMS, and METEOSAT, microwave products derived from SSM/I and AMSU data, snow and ice maps from NOHRSC, NIC, and USAF daily snow analyses, as well as surface observations from manual and automated weather stations. Production of a daily Northern Hemisphere experimental product began in February 1997. Operational implementation of IMS was completed in November 1997 and formally replaced the weekly product in June 1999. The current daily digital product is in ASCII format and archived at the National Snow and Ice Data Center (NSIDC: <http://nsidc.org/index.html>). A 15 month validation, funded by NOAA's Office of Global Programs, was conducted over two snow seasons in which the weekly and daily products were produced in parallel. A digital weekly snow and ice map will be derived from the daily digital products for comparison with the current weekly product and for continuation into the future of the satellite derived weekly snow and ice map climatological record begun in 1966. The results of the validation will be published. Feedback from the snow and ice community on the IMS daily product is welcome and encouraged. It is routinely posted on the NOAA/NESDIS Office of Satellite Data Processing and Distribution's (OSDPD) home page (<http://www.osdpd.noaa.gov>) and on the NOAA/NESDIS/OSDPD Satellite Services Division's home page at (<http://www.ssd.noaa.gov/>).

In summary, digital snow and ice map products archived at NSIDC (<http://nsidc.org/noaa/>) consist or will consist of the following:

- 1024x1024 daily snow and ice map
- 1024x1024 weekly snow and ice map (to be derived from the daily product)
- 89x89 weekly snow and ice map (derived from the weekly snow and ice map)

9.6.3 Microwave Surface and Precipitation Products System (MSPPS) Day-2 System

The first AMSU-A and -B instruments were launched on NOAA-15 on May 13, 1998. These instruments provided a new opportunity to produce microwave surface and precipitation products from NOAA polar orbiter satellites similar to the microwave surface and precipitation products [known as Environmental Data Records (EDRs)] produced by Fleet Numerical Meteorology and Oceanography Center (FNMOC) from the Defense Meteorological Satellite Program's (DMSP) Special Sensor Microwave/Imager (SSM/I) instrument. The Special Sensor Microwave/ Temperature (SSM/T) and Special Sensor Microwave/moisture (SSM/T-2) sounders (both cross-track instruments), along with the SSM/I (conical scanner), provided valuable data to expedite both sounding and MSPPS algorithm development. The commonality of the AMSU-A and -B instrument suite with the current DMSP SSM/T/I/T-2 suite of instruments, as well as the future DMSP Special Sensor Microwave/Imager-Sounder (SSM-IS) (conical scanner) is illustrated in Table 9.6.3-1. AMSU-A is a 15-channel cross-track scanning passive microwave radiometer. An AMSU-A scan takes eight seconds and is comprised of 30 Earth views. AMSU-B is a five channel cross-track scanning passive microwave radiometer. An AMSU-B scan takes 8/3 seconds and is comprised of 90 Earth views.

AMSU-A/B		SSM/I/T/T2		SSM-IS	
Frequency (MHz)	Footprint (km)	Frequency (MHz/ Polarization - see note 1)	Footprint (km)	Frequency (MHz/ Polarization - see note 1)	Footprint (km)
		19,350 / H & V	43 x 69	19,350 / H & V	73 x 47
23,800	45 x 45 - 86 x 172	22,235 / V	40 x 60	22,235 / V	73 x 47
31,400	45 x 45 - 86 x 172	37,000 / H & V	28 x 37	37,000 / H & V	41 x 31
50,300	45 x 45 - 86 x 172	50,500 / H	175 x 175 - 305 x 313	50,300 / H	38 x 38
52,800	45 x 45 - 86 x 172	53,200 / H	175 x 175 - 305 x 313	52,800 / H	38 x 38
53,596 ± 115	45 x 45 - 86 x 172			53,596 / H	38 x 38
54,400	45 x 45 - 86 x 172	54,350 / H	175 x 175 - 305 x 313	54,400 / H	38 x 38
54,940	45 x 45 - 86 x 172	54,900 / H	175 x 175 - 305 x 313		
55,500	45 x 45 - 86 x 172			55,500 / H	38 x 38
57,900.344 (f _{lo})	45 x 45 - 86 x 172			57,290 / See Note 2	38 x 38

$f_{10} \pm 217$	45 x 45 - 86 x 172				
$f_{10} \pm 322.2 \pm 48$	45 x 45 - 86 x 172			59,400 / See Note 2	38 x 38
$f_{10} \pm 322.2 \pm 22$	45 x 45 - 86 x 172	58,400 / V	175 x 175 - 305 x 313		
$f_{10} \pm 322.2 \pm 10$	45 x 45 - 86 x 172	58,825 / V	175 x 175 - 305 x 313		
$f_{10} \pm 322.2 \pm 4.5$	45 x 45 - 86 x 172	59,400 / V	175 x 175 - 305 x 313		
89,000	45 x 45 - 86 x 172	85,500 / H & V	13 x 15	91,655 / V	14 x 13 (imager)
89,000	15 x 15 - 26 x 52	91,655 / V	84 x 84	91,655 / H	14 x 13 (imager)
15,700	15 x 15 - 26 x 52	150,000 / V	54 x 54	150,000 / H	14 x 13 (imager)
$183,310 \pm 1,000$	15 x 15 - 26 x 52	$183,310 \pm 1000 / V$	48 x 48	$183,310 \pm 1,000/H$	14 x 13 (imager)
$183,310 \pm 3,000$	15 x 15 - 26 x 52	$183,310 \pm 3000 / V$	48 x 48	$183,310 \pm 3,000/H$	14 x 13 (imager)
$183,310 \pm 7,000$	15 x 15 - 26 x 52	$183,310 \pm 7000 / V$	48 x 48	$183,310 \pm 7,000/H$	14 x 13 (imager)
				See Note 3	75 x 75
Notes:					
1. H and V refer to horizontal and vertical polarization, respectively.					
2. These SSM-IS channels are not polarization dependent.					
3. SSM-IS has 6 additional narrow band channels in the frequency range of 60,000 to 63,000 MHz.					

The lineage of MSPPS at NOAA/NESDIS includes the generation of orbital and gridded (Mastermap) products from SSM/I "raw" data transmitted via the Shared Processing Network (SPN) from Air Force Global Weather Central (AFGWC). Both of these systems were intended to produce experimental products until FNMOC was ready to begin transmission of the official SSM/I operational products over SPN. In 1992, FNMOC began transmitting Temperature Data Records (TDR), Sensor Data Records (SDR), and Environmental Data Records (EDRs) to NESDIS via SPN. NESDIS processed the SDRs and EDRs into 30-orbit files and mapped the EDRs and SDRs into Mastermap files (eighth-mesh polar stereographic maps). Under the auspices of the NOAA Climate and Global Change Program, a prototype Microwave Climate System (MCS) was developed. MCS entailed the production of orbital Brightness Temperatures (BTs) from the seven SSM/I channels as well as total precipitable water and rain rate products from the EDRs and from the BTs using experimental algorithms. Besides the orbital files, daily,

pentad (five-day), and monthly climate products were generated and archived. The design and development of MCS provided the foundation and fundamental "building blocks" for the design of MSPPS.

The design philosophy of MSPPS is to maintain commonality with MCS to the extent possible realizing that the generation of real-time and climate products have much in common, as do the generation of products from different microwave instruments such as SSM/I, AMSU-A and AMSU-B.

MSPPS produces near real-time operational surface and precipitation products from the AMSU-A and AMSU-B instruments. The products are listed in Table 9.6.3-2.

Table 9.6.3-2. AMSU-A and -B Products.		
Product	AMSU-A	AMSU-B
Antenna Temperatures (AT)	X	X
Total Precipitable Water (TPW)	X	
Cloud Liquid Water (CLW)	X	
Sea Ice Concentration	X	
Surface Emissivity at 23.8 GHz	X	
Surface Emissivity at 31.4 GHz	X	
Surface Emissivity at 50.3 GHz	X	
Surface (skin) Temperature	X	
Snow Cover (Yes or No)		X
Rain Rate		X
Ice Water Path		X

Operational MSPPS includes three integrated subsystems:

- 1) AMSU-A Orbital Products Generation (OPG);
- 2) AMSU-B OPG; and
- 3) AMSU-A/B Mapped Orbital Products (MOP).

AMSU-A OPG processing is initiated by converting the Level 1b* AMSU-A data (Level 1b* is a centralized database which contains the basic elements of the Level 1b and the associated supporting ancillary data) from IBM MVS to IEEE format; then antenna temperatures and geophysical products are computed and stored in HDF-EOS Swath files (with compression). The MSU-A OPG data are available on an orbital basis. An AMSU-A Snow Cover Product can be computed but is not currently being done since the AMSU-B product is available and improved with respect to the AMSU-A product. Likewise, the AMSU-A Rain Rate Product is

not computed since the superior AMSU-B product is available. The AMSU-A products would be turned on for output if the AMSU-B processing stream fails. The AMSU-A Swath output is available as NPR.AAOP.

AMSU-B OPG processing first converts the AMSU-B Level 1b* data from IBM MVS to IEEE format, then computes the AMSU-B antenna temperatures (ATs), and stores the AMSU-B antenna temperatures and ancillary data in AMSU-B HDF-EOS Swath files (with compression). Then, the relevant AMSU-A ATs and geophysical products from the AMSU-A Swath file and the AMSU-B Swath file from the previous step are read; the AMSU-B geophysical products are computed and appended to AMSU-B HDF-EOS Swath files (with compression). The AMSU-B OPG data are available on an orbital basis. The AMSU-B Swath output is available as NPR.ABOP.

AMSU-B MOP processing generates mapped geophysical products on an orbit-by-orbit basis. These mapped AMSU surface and precipitation products are written into a rotating file so that portions of the file are overwritten orbitally. In this manner, the MOP satisfies the requirements that necessitate the mapped products to be updated orbitally. The output from the AMSU-A OPG and the AMSU-B OPG serve as the input to the AMSU-B product mapping. Currently, sea-ice, snow and the rain rate products are written to a 1/16th-mesh Polar Stereographic (1024x1024) projection. For a complete description of the mapping algorithm see the NOAA KLM User's Guide - Appendix C (URL:

<http://www.ncdc.noaa.gov/oa/pod-guide/ncdc/docs/klm/html/c/app-c.htm>).

The rain rate was added to the MOP file on January 10, 2002. The snow and sea ice products are composited from descending orbital data only, while the rain rate is composited from both descending and ascending data. The AMSU-B MOP output files, NPR.ABMP, are in HDF-EOS Grid format (with compression).

As part of Product Validation on the Research System version of MSPPS, selected Mapped Daily Products (MDP) are created. The MSPPS has been extended to meet climate requirements, climate subsystems for Daily, Pentad, and Monthly product generation have been created.

HDF-EOS was chosen as the standard output format for MSPPS for a variety of reasons. First, there are the inherent attributes of HDF-EOS forming the basis for its selection as the standard format for EOS. Some of these are: support for multiple data objects; coupling of geolocation with the data, resulting in subsetting capabilities; self defining (self documented); supports internal compression; portable; non-proprietary; and widespread use. Second, because of its widespread use and being a standard, an extremely large suite of tools for HDF-EOS and applications that support HDF-EOS are anticipated

MSPPS Level-2 and Level-3 data are stored in the HDF-EOS format, an extension of National Center for Supercomputing Application's (NCSA) HDF (URL: <http://www.hdfgroup.org/>)

developed by NASA to support its Earth Observing System (EOS). Among other attributes, the multi-object HDF-EOS format that supports compression is portable, flexible, and self-defining. For an overview of HDF and HDF-EOS, refer to the excellent Primer at URL: <http://edhs1.gsfc.nasa.gov/waisdata/sdp/pdf/wp1750102.pdf>. HDF-EOS enhances the flexibility of HDF by permitting temporal and spatial subsetting. Traditionally, product files have been in a fixed format requiring up-to-date external documentation describing the format. To accommodate changes in format, spares are often included. If additional changes in format are required, users must rewrite their data-read modules. The self-defining nature of HDF-EOS greatly reduces the impact of any change in format on the user. The HDF_EOS tools can be downloaded from the library found at URL: <http://www.hdfgroup.org/hdf/tools.html>

Currently, MSPPS files “NPR.AAOP”, “NPR.ABOP”, and “NPR.ABMP” are archived at NCDC and are available from the CLASS at URL: <http://www.class.noaa.gov>. Although the MSPPS Day-2 files have the same type of naming convention as the Day-1 files, the formats are slightly different. The change-over to Day-2 files for archive occurred in August 2001.

The major differences between the Day-1 and Day-2 file are parameter names. Several parameters appear in the Day-1 Data Sets that should not be used and were only included as either potential parameters or spare fields. These include a QC field and a surface elevation field. In the Day-1 AMSU-A Swath file the surface type parameter is not valid; whereas the surface type is valid for the Day-1 AMSU-B swath data. The major differences between the Day-1 and Day-2 file are delineated in Table 9.6.3-3.

Table 9.6.3-3. Difference between Day-1 and Day-2 Files.	
Day-1	Day-2
AMSU-A and AMSU-B Swath Files	
Surface_type (not a valid parameter - AMSU-A only)	Sfc_type (valid)
Antenna Temperatures assigned to variable - Chan_xBT (x is channel number) Note: incorrectly named variable	Antenna Temperatures - Chanx_AT (x is channel number)
AMSU-A Swath Files	
Full set of products	As listed in Table 9.6.3-2
AMSU-B Swath Files	
Channel Temperatures only	As listed in Table 9.6.3-2
Mapped Data File	

1/8th mesh (512 x 512) Polar Stereographic	1/16th mesh (1024 x 1024) Polar Stereographic
TPW, CLW, Sea Ice, Snow Cover and Rain Rate	Snow and Sea Ice (rain rate added January 2002)

Access routines for the HDF-EOS AMSU-A and AMSU-B swath files and the HDF-EOS MSPPS Polar Stereographic Mapped file are available for download at URL: <ftp://ftp2.ncdc.noaa.gov/pub/doc/klmguide/meta/>. There are three directories called: AMSU-A, AMSU-B, and PSmap. Each of these directories contains three sub-directories: input, output, and src. Refer to the “README” file in the “src” sub-directory for instructions about retrieving data from the designated file type.

For general information about the Microwave Surface and Precipitation Products System, see the MSPPS home page at URL: <http://www.orbit.nesdis.noaa.gov/corp/scsb/mspps/main.html>. There are links to discussions of the product algorithms, case studies, product monitoring, presentations, MSPPS documentation, and more.

Tables 9.6.3-3 and 9.6.3-4 contain the format of AMSU-A HDF-EOS swath for NPR.AAOP files and attributes, respectively. Tables 9.6.3-5, 9.6.3-6 and 9.6.3-7 contain the format of AMSU-B HDF-EOS swath for NPR.ABOP files, attributes and polar stereographic grid for NPR.ABMP files.

Table 9.6.3-4. AMSU-A HDF-EOS Swath: NPR.AAOP files on DDS.				
Parameter Name	Data Type	Missing Data	Scale	Explanation
ScanTime_year	I*2	0 (See Note 1)	1	Four digit calendar year (e.g., 1999)
ScanTime_month	I*1	0 (See Note 1)	1	Month of year (e.g., 1-12)
ScanTime_dom	I*1	0 (See Note 1)	1	Day of month (e.g., 1-31)
ScanTime_hour	I*1	0 (See Note 1)	1	Hour of day (e.g., 0-23)
ScanTime_minute	I*1	0 (See Note 1)	1	Minute of hour (e.g., 0-59)
ScanTime_second	I*1	0 (See Note 1)	1	Second of minute (e.g., 0-59)
ScanTime_doy	I*2	0 (See Note 1)	1	Day of year (e.g., 1-366)
Latitude	R*4	0 (See Note 1)	1	Latitude (degrees, e.g., -90 to 90)
Longitude	R*4	0 (See Note 1)	1	Longitude (degrees, e.g., -180 to 180)
Time	R*8	0 (See Note 1)	1	Number of seconds and fractions since 0000 UTC Jan. 1, 1993 (TAI93)
Sfc_type	I*1	255	1	Surface Type: 0=ocean; 1=land; 2=coast.

Orbit_mode	I*1	0 (See Note 1)	1	Orbit direction: 1=ascending; 2=descending.
LZ_angle	R*4	0 (See Note 1)	1	Local zenith angle range (degrees) range 0 - 57
SZ_angle	R*4	0 (See Note 1)	1	Solar zenith angle range (degrees) range 1 - 180
Chan1_AT	I*2	-99	100	Channel 1 Antenna Temperature (K) range 125.0-310.0
Chan2_AT	I*2	-99	100	Channel 2 Antenna Temperature (K) range 125.0-310.0
Chan3_AT	I*2	-99	100	Channel 3 Antenna Temperature (K) range 150.0-310.0
Chan4_AT	I*2	-99	100	Channel 4 Antenna Temperature (K) range 170.0-295.0
Chan5_AT	I*2	-99	100	Channel 5 Antenna Temperature (K) range 190.0-280.0
Chan6_AT	I*2	-99	100	Channel 6 Antenna Temperature (K) range 190.0-260.0
Chan7_AT	I*2	-99	100	Channel 7 Antenna Temperature (K) range 190.0-250.0
Chan8_AT	I*2	-99	100	Channel 8 Antenna Temperature (K) range 180.0-245.0
Chan9_AT	I*2	-99	100	Channel 9 Antenna Temperature (K) range 175.0-250.0
Chan10_AT	I*2	-99	100	Channel 10 Antenna Temperature (K) range 170.0-250.0
Chan11_AT	I*2	-99	100	Channel 11 Antenna Temperature (K) range 175.0-255.0
Chan12_AT	I*2	-99	100	Channel 12 Antenna Temperature (K) range 180.0- 265.0
Chan13_AT	I*2	-99	100	Channel 13 Antenna Temperature (K) range 190.0- 280.0
Chan14_AT	I*2	-99	100	Channel 14 Antenna Temperature (K) range 195.0-290.0
Chan15_AT	I*2	-99	100	Channel 15 Antenna Temperature (K) range 130.0- 315.0
TPW	I*2	See Table 9.6.3.1-9	10	Total Precipitable Water (mm x 10) range 0.0 - 75.0

CLW	I*2	See Table 9.6.3.1-9	100	Cloud Liquid Water (mm x 100) range 0.0 - 6.0
SIce	I*2	See Table 9.6.3.1-9	1	Sea Ice Concentration (%) range 0.0 - 100.0
T_sfc	I*2	See Table 9.6.3.1-9	100	Surface Temperature (K) range 150.0 - 350.0
Emis_23	I*2	See Table 9.6.3.1-9	100	Emissivity at 23.8 GHz (unit less) range 0.3 - 1.0
Emis_31	I*2	See Table 9.6.3.1-9	100	Emissivity at 31.4 GHz (unit less) range 0.3 - 1.0
Emis_50	I*2	See Table 9.6.3.1-9	100	Emissivity at 50.3 GHz (unit less) range 0.3 - 1.0

Note:

1. The initialization value is zero. No missing scan lines should be encountered, but verification can be made by using product parameters.

Table 9.6.3-5. AMSU-A HDF-EOS Swath Attributes.

Parameter Name	Data Type	Explanation
AT_Limits	R*4	Lower and upper limits of AMSU-A antenna temperatures (K)
TPW_Limits	R*4	Lower and upper limits of total precipitable water (mm)
CLW_Limits	R*4	Lower and upper limits of cloud liquid water (mm)
SIce_Limits	R*4	Lower and upper limits of sea ice concentration (%)
TS_Limits	R*4	Lower and upper limits of surface temperature (K)
EM23_Limits	R*4	Lower and upper limits of emissivity at 23.8 GHz (unit less)
EM31_Limits	R*4	Lower and upper limits of emissivity at 31.4 GHz (unit less)
EM50_Limits	R*4	Lower and upper limits of emissivity at 50.3 GHz (unit less)
Rain_Limits	R*4	Lower and upper limits of rain rate (mm/hr)
SNOWC_Limits	R*4	Lower and upper limits of snow cover (unit less)
AT_SCAL	R*4	Scaling factor of antenna temperature
TPW_SCAL	R*4	Scaling factor of total precipitable water
CLW_SCAL	R*4	Scaling factor of cloud liquid water
SICE_SCAL	R*4	Scaling factor of sea ice concentration
TS_SCAL	R*4	Scaling factor of surface temperature

EM_SCAL	R*4	Scaling factor of emissivity
RR_SCAL	R*4	Scaling factor of rain rate
SNOWC_SCAL	R*4	Scaling factor of snow cover
Epoch_year	I*2	Epoch Year for Orbit Vector (e.g., 2003)
Epoch_day	I*2	Day of Epoch Year for Orbit Vector (e.g., 365)
Epoch_time	I*4	Epoch UTC Time of Day for Orbit Vector (milliseconds)
semimajor_axis	R*4	Semi-major Axis (kilometers)
eccentricity	R*4	Eccentricity (unit less)
inclination	R*4	Inclination (degrees)
argument_of_perigee	R*4	Argument of Perigee (degrees)
right_ascension	R*4	Right Ascension of the Ascending Node (degrees)
mean_anomaly	R*4	Mean Anomaly (degrees)

Table 9.6.3-6. Format of AMSU-B HDF-EOS Swath: NPR.ABOP files on DDS.

Parameter Name	Data Type	Missing Data	Scale	Explanation
ScanTime_year	I*2	0 (See Note 1)	1	Four digit calendar year (e.g., 1999)
ScanTime_month	I*1	0 (See Note 1)	1	Month of year (e.g., 1-12)
ScanTime_dom	I*1	0 (See Note 1)	1	Day of month (e.g., 1-31)
ScanTime_hour	I*1	0 (See Note 1)	1	Hour of day (e.g., 0-23)
ScanTime_minute	I*1	0 (See Note 1)	1	Minute of hour (e.g., 0-59)
ScanTime_second	I*1	0 (See Note 1)	1	Second of minute (e.g., 0-59)
ScanTime_doy	I*2	0 (See Note 1)	1	Day of year (e.g., 1-366)
Latitude	R*4	0 (See Note 1)	1	Latitude (degrees, range: -90.0 to 90.0)
Longitude	R*4	0 (See Note 1)	1	Longitude (degrees, range: -180.0 to 180.0)
Time	R*8	0 (See Note 1)	1	Number of seconds and fractions since 0000 UTC Jan. 1, 1993 (TAI93)
Sfc_type	I*1	255	1	Surface Type: 0=ocean; 1=land; 2=coast.
Orbit_mode	I*1	0 (See Note 1)	1	Orbit direction: 1=ascending; 2=descending.

LZ_angle	R*4	0 (See Note 1)	1	Local zenith angle range (degrees)
SZ_angle	R*4	0 (See Note 1)	1	Solar zenith angle range (degrees)
Chan1_AT	I*2	-99	100	Channel 1 Antenna Temperature (K) range 75.0 - 325.0
Chan2_AT	I*2	-99	100	Channel 2 Antenna Temperature (K) range 75.0 - 325.0
Chan3_AT	I*2	-99	100	Channel 3 Antenna Temperature (K) range 75.0 - 325.0
Chan4_AT	I*2	-99	100	Channel 4 Antenna Temperature (K) range 75.0 - 325.0
Chan5_AT	I*2	-99	100	Channel 5 Antenna Temperature (K) range 75.0 - 325.0
RR	I*2	See Table 9.6.3.1-9	100	Rain Rate (mm/hr) range 0.0 - 30.0
Snow	I*2	See Table 9.6.3.1-9	1	Snow Cover (0 or 100; 100 = snow) range 0.0 -100.0
IWP	I*2	See Table 9.6.3.1-9	100	Ice Water Path (kg/m ²) range 0.0 - 2.0

Note:

1. The initialization value is zero. No missing scan lines should be encountered, but verification can be made by using product parameters.

Table 9.6.3-7. AMSU-B HDF-EOS Swath Attributes.

Parameter Name	Data Type	Explanation
AT_Limits	R*4	Lower and upper limits of AMSU-B antenna temperatures (K)
RR_Limits	R*4	Lower and upper limits of rain rate (mm/hr)
SNOW_Limits	R*4	Lower and upper limits of snow cover (percent)
IWP_Limits	R*4	Lower and upper limits of ice water path (kg/m ²)
AT_SCAL	R*4	Scaling factor of antenna temperature
RR_SCAL	R*4	Scaling factor of rain rate
SNOW_SCAL	R*4	Scaling factor of snow cover
IWP_SCAL	R*4	Scaling factor of ice water path
Epoch_year	I*2	Epoch Year for Orbit Vector (e.g., 1999)
Epoch_day	I*2	Day of Epoch Year for Orbit Vector (e.g., 365)

Epoch_time	I*4	Epoch UTC Time of Day in Milliseconds for Orbit Vector
semimajor_axis	R*4	Semi-major Axis (kilometers)
eccentricity	R*4	Eccentricity (unit less)
inclination	R*4	Inclination (degrees)
argument_of_perigee	R*4	Argument of Perigee (degrees)
right_ascension	R*4	Right Ascension of the Ascending Node (degrees)
mean_anomaly	R*4	Mean Anomaly (degrees)

Table 9.6.3-8. AMSU-B HDF-EOS PS Grid: NPR.ABMP files on DDS.

Parameter Name	Data Type	Missing Data	Explanation
Northern Hemisphere			
North_year	I*2	-99	Four digit calendar year (e.g., 1999)
North_moy	I*1	255	Month of year (e.g., 1-12)
North_dom	I*1	255	Day of month (e.g., 1-31)
North_hour	I*1	255	Hour of day (e.g., 1-24)
North_minute	I*1	255	Minute of hour (e.g., 1-60)
North_second	I*1	255	Second of minute (e.g., 1-60)
North_doy	I*2	-99	Day of year (e.g., 1-366)
North_lat	R*4	-999.0	Latitude (degrees, 0 to 90)
North_lon	R*4	-999.0	Longitude (degrees, -180 to 180)
North_RR	I*2	See Table 9.6.3.1-9	Rain Rate (mm/hr; 0.0 - 30.0 with a scaling factor of 10, negative values are flags)
North_Snow	I*2	See Table 9.6.3.1-9	Snow Cover (%; 0 or 100; 100 = snow, negative values are flags)
North_Sice	I*2	See Table 9.6.3.1-9	Sea ice concentration (%; 0 -100)
Southern Hemisphere			
South_year	I*2	-99	Four digit calendar year 4 digits (e.g., 1999)
South_moy	I*1	255	Month of year (e.g., 1-12)
South_dom	I*1	255	Day of month (e.g., 1-31)

South_hour	I*1	255	Hour of day (e.g., 1-24)
South_minute	I*1	255	Minute of hour (e.g., 1-60)
South_second	I*1	255	Second of minute (e.g., 1-60)
South_doy	I*2	-99	Day of year (e.g., 1-366)
South_lat	R*4	-999.0	Latitude (degrees, -90 to 0)
South_lon	R*4	-999.0	Longitude (degrees, -180 to 180)
South_RR	I*2	See Table 9.6.3.1-9	Rain Rate (mm/hr; 0.0 - 30.0 with a scaling factor of 10, negative values are flags)
South_Snow	I*2	See Table 9.6.3.1-9	Snow Cover (%; 0 or 100; 100 = snow, negative values are flags)
South_Sice	I*2	See Table 9.6.3.1-9	Sea ice concentration (%; 0 -100, negative values are flags)

Table 9.6.3-9 contains an explanation of the product error flags used for MSPPS data.

Table 9.6.3-9. Product Error Flags.	
Flag Value	Explanation
-1	Calculated product value larger than its upper limit.
-2	Calculated product value less than its lower limit.
-3	Calculated antenna temperature larger than its upper limit.
-4	Calculated antenna temperature less than its lower limit.
-5	Undetermined because of undetermined cloud liquid water.
-6	Undetermined because of possible rain.
-7	Undetermined because of possible snow.
-8	Undetermined because of possible sea ice.
-9	Undetermined because of coast.
-10	Undetermined because of unknown reasons.
-11	Undetermined because of possible desert.

-12	Undetermined because of elevation (> 3000 m).
-----	---

9.6.4 Microwave Integrated Retrieval System Products

The Microwave Integrated Retrieval System (MIRS) was developed with an end to end capability of calibrating and characterizing the radiances measured from satellite-based microwave instruments, and retrieving the environmental data records with state-of-the-art algorithm science. The MIRS replaced the MSPPS on August 30, 2007. There are currently no plans to reprocess the MSPPS data into the MIRS format. This system is an upgrade from the NESDIS operational MSPPS and is a one-stop resource for microwave-derived products from various polar-orbiting satellite instrument configurations. The MIRS is capable of optimally retrieving atmospheric and surface state parameters and provides physical-based retrievals/products in a consistent fashion. The MIRS is also designed to be instrument/spectrum-independent, parameter-independent, and platform-independent. MIRS produces advanced near-real-time operational surface and precipitation products in all-weather and over all-surface conditions using brightness temperatures from multiple microwave instruments.

These instruments include the Advanced Microwave Sounding Unit-A (AMSU-A) and Microwave Humidity Sounder (MHS) on board the Initial Joint Polar-orbiting Operational Satellite (JPoS) System (NOAA-N, -N', MetOp-1, -2, -3), the Special Sensor Microwave Imager/Sounder (SSMIS) on Defense Meteorological Satellite Program (DMSP) F-16, F-17, F-18, F-19 and F-20 polar satellites, and the Advanced Technology Microwave Sounder (ATMS) that will fly on National Polar-orbiting Operational Environmental Satellite System (NPOESS) and on NPOESS Preparatory Project (NPP).

Operational products currently and will include: vertical profiles of temperature, moisture and hydrometeors, and also rain rate, total precipitable water, cloud liquid water, falling snow, snow cover, snow water equivalent, sea ice concentration, ice water path, surface emissivity spectra and land surface temperature.

The following table shows the current delivery schedule to CLASS and the available operational products from each version.

POES & MetOp Deliverables	Delivery Time/MIRS version
<ul style="list-style-type: none"> - Temperature Profiles (T(z)) (over ocean) - Moisture Profiles (q(z)) (over ocean) - Total Precipitable Water (TPW) (over ocean) - Land Surface Emissivity (LSE) - Land Surface Temperature (LST) 	Version 1.0 August/September 2007

- Cloud Liquid Water (CLW) (over ocean) - Snow Water Equivalent (SWE) - Snow Cover - Sea Ice Concentration - T(z) (extension to non-oceanic surfaces) - q(z) (extension to non-oceanic surfaces) - TPW (extension to non-oceanic surfaces)	Version 2.0 February 2008
- Hydrometeor Profiles (Hy(z)) (includes profiles of mixing ratio of cloud, rain, graupel, snow and ice particles) from NOAA-18 and MetOp-A - Ice Water Path (IWP)	Version 3.0 August 2008
- Rainfall Rate (RR)	Version 4.0 February 2009

Additional products will be added as they become operational.

9.6.4.1 MIRS File Naming Convention

The MIRS file naming convention is similar to the standard Level 1b file naming convention. There are significant differences. The filename has the following format:

<PROCESSING-CENTER>.<PROJECT-ID>.<VERSION>.<PRODUCT-TYPE>.<SENEOR-ID>.<SPACECRAFT_ID>.<YEAR-DAY>.<START-TIME>.<STOP-TIME>.<PROCESSING-BLOCK-ID>.<SOURCE>.<FILE-TYPE>

Where:

PROCESSING-CENTER = Processing-Center where the data were created. **Length:** 3 char. **Domain:**

“NPR” = NOAA/NESDIS Product – Suitland, Maryland, USA

PROJECT-ID = Identifies the project name. **Length:** 4 char. **Domain:**

“MIRS” = Microwave Integrated Retrieval System (fixed)

VERSION = The product’s algorithm version number **Length:** 2 char. **Domain:** “V1”

PRODUCT-TYPE = Identifies the type of product. **Length:** 3 char. **Domain:**

“SND” = 3-dimensional sounding-type products.

“IMG” = 2-dimensional surface and precipitation type products.

Note that the filename convention covers two types of products, and each type includes a suite of individual products. For example, the “SND” file will contain three sounding profiles: T(z), Q(z) and hydrometeor(Z), and the “IMG” file will contain 9 integrated precipitation and surface products: TPW, CLW, RR, SWE, Snow Cover, Sea Ice, LSE, LST and IWP. This approach allows one file to store duplicate geolocation and other auxiliary data for each individual product type.

SENSOR-ID = Short name for the instrument used to derive the product. **Length:** 4 to 5 char.

Domain:

“AAMH”= derived from combined AMSU-A and MHS data on POES/MetOp spacecraft.

“SSMIS” = derived from SSMIS data on DMSP.

“ATMS”= derived from ATMS data on NPP

SPACECRAFT_ID = Spacecraft-Unique-ID. **Length:** 2 char. **Domain:**

“NN” = NOAA-18 (NOAA-N)

“SA” = DMSP Air Force F16

“SB” = DMSP Air Force F17

“M2” = MetOp-2

YEAR-DAY = Year-Day. E.g. “D79104”, where “D” identifies this group as a Julian day delimiter, “79” identifies the year in which the spacecraft began recording the data set and “104” identifies the Julian day on which the spacecraft began recording the data set. **Length:** 6 char. (5 characters for the date string, plus one for the “D” at the beginning). **Domain:** “D”+”YYJJJ”

START-TIME = e.g. “S1355”, where “S” identifies this group as a start time delimiter. “1355” denotes 13 hours 55 minutes UTC (to the nearest minute) and represents the time at which spacecraft recording began. **Length:** 5 char. (4 characters for the time string, plus one for the “S” at the beginning). **Domain:** “S”+”HHMM”

STOP-TIME = e.g. “E1456”, where “E” identifies this group as an end time delimiter. “1456” denotes 14 hours 56 minutes UTC (to the nearest minute) and denotes the time of spacecraft recording of the last usable data in the data set. **Length:** 5 char. (4 characters for the time string, plus one for the “E” at the beginning). **Domain:** “E”+”HHMM”

PROCESSING-BLOCK-ID = e.g. “B0016465”, where “B” identifies this group as a processing block ID delimiter. “0016465” is a seven digit number identifying the spacecraft revolution (orbit) in which recording of this data set began and the revolution in which the recording of the data set ended (the first five digits identifying the beginning revolution and the last two being the two least significant digits of the ending revolution). **Length:** 8 char. (7 characters for the orbit number, plus one for the “B” at the beginning). **Domain:** “B”+”XXXXXXX”

SOURCE = Identifies the data acquisition source. **Length:** 2 char. **Domain:**

“NS” = Fixed field designating No Station.

FILE-TYPE = File extension that indicates file type. **Length:** variable. **Domain:** “hdf”, “he4”, “netcdf”, “bin”, etc.

Filename example:

NPR.MIRS.V0.SND.AAMH.NN.D07077.S0855.E1030.B0940405.NS.he4

9.6.4.2 Dynamic Metadata to be Captured

This section identifies the subset of granule (dynamic) metadata attributes to be used by the Archive and the valid range of values that will be used for validation of these attributes. Listed below are the metadata items to be utilized by the Archive. The “Source” column indicates the location of a particular metadata element. The “Use” column indicates how the metadata item will be utilized within the Archive: “S” for searching; “D” for displaying in the search results; or “SD” for both searching and displaying.

Table 9.6.4.2-1 Dynamic Metadata

Field Name	Source	Data Type	Description	Range of Values	Use
Data Type	Filename	String	The MIRS product type refers to whether the product file contains 3-dimensional sounding-type products or 2-dimensional surface/precip-type products. This is determined from three characters in the filename. The MIRS products suite contains the following products: Temperature profiles, moisture profiles, hydrometeor profiles, Rain Rate, Total Precipitable Water or TPW, Cloud Liquid Water or CLW, Snow Cover, Sea Ice, Snow Water Equivalent or SWE, Skin Temperature or LST, Land Surface Emissivity or LSE. All products are 2-dimensional surface/precip-type products except Temperature, Moisture and Hydrometeor profiles, which are 3-dimensional sounding-type products.	Product type: "SND", "IMG" Sensor: "AAMH", "SSMIS", and "ATMS"	SD
MIRS Version	Filename	String	The product's algorithm version number.	Currently "V1"	SD
Sensor	Filename	String	The instrument used to derive the product	Sensors: "AAMH", "SSMIS", "ATMS"	SD

Spacecraft-Unique-Id	Filename	String	Two characters identifying the platform.	"NN" = NOAA-18 "SA" = DMSP Air Force F16 "SB" = DMSP Air Force F17 "M2" = MetOp-2	SD
Start / Stop Time delimiter	Filename	String	Denotes to the nearest minute the time at which instrument recording began and ended.	"S"+"HHMM" "E"+"HHMM"	SD
Orbit / Processing Block ID	Filename	String	A seven digit number, preceded by "B", identifying the spacecraft revolution (orbit) in which recording of this data set began and the revolution in which the recording of the data set ended (the first five digits identifying the beginning revolution and the last two being the two least significant digits of the ending revolution).	N/A	D
File Format	Filename	String	Note that initial format will be HDF-EOS 4, yet BUFR and NetCDF formats should be available later during the FY09 time frame when the full suite of MIRS products is available. This may occur earlier if there is a strong user request.	"he4", for HDF-EOS 4	SD

9.6.4.3 MIRS Swath Data Fields and Attributes

Tables 9.6.4.3-1 and 9.6.4.3-2 list the attributes and Tables 9.6.4.3-3 and 9.6.4.3-4 list the retrieved products in the HDF_EOS data files that will be archived at CLASS in the first phase.

Table 9.6.4.3-1. MIRS HDF-EOS Sounding Swath Attributes		
Parameter Name	Data Type	Explanation
Temp_Limits	R*4	Lower and upper limits of temperatures (K)
PTemp_SCAL	R*4	Scaling factor of layer temperature
PLayer_SCAL	R*4	Scaling factor for layer pressure
PVapor_SCAL	R*4	Scaling factor of layer water vapor amount
PCloud_SCAL	R*4	Scaling factor of cloud amount
PRain_SCAL	R*4	Scaling factor of rain amount
PSnow_SCAL	R*4	Scaling factor of snow amount
Pice_SCAL	R*4	Scaling factor of ice amount
PGrpl_SCAL	R*4	Scaling factor of graupel amount
SurfP_SCAL	R*4	Scaling factor of surface pressure
Level_pres	R*4 (1:101)	Pressures of the levels between the products profile layers
Total_scan	I*2	Total number of scans in the data
Num_fov	I*2	Number of FOVs in the orbit data
Num_layer	I*2	Number of layers for profiles
Num_qcatm	I*2	Number of atmosphere QC parameters
Num_qcsfc	I*2	Number of surface QC parameters

Table 9.6.4.3-2. MIRS HDF-EOS Sounding Swath Data Fields				
Parameter Name	Data Type and Dimension	Missing Data Value	Scale	Explanation
ScanTime_year	I*2 (1)	-999	1	Four digit calendar year (e.g., 1999)
ScanTime_doy	I*2 (1)	-999	1	Day of year (e.g., 1-366)
Latitude	R*4 (2)	-999	1	Latitude (degrees, e.g., -90 to 90)
Longitude	R*4 (2)	-999	1	Longitude (degrees, e.g., -180 to 180)
TimeUTC	R*8 (1)	-999	1	Number of seconds and fractions since 0000 UTC Jan. 1, 1993 (TAI93)
Atm_type	I*2 (2)	-999	1	Atmosphere type: 1=global
Sfc_type	I*2 (2)	-999	1	Surface Type: 0=ocean, 1=sea-ice, 2=land and 3 =snow cover.

Qc_atm	I*2 (2)	-999	1	Quality flag for retrievals: 0=retrieval; 1=no retrieval (default to background value).
Qc_sfc	I*2 (2)	-999	1	Quality flag for retrievals: 0=retrieval; 1=no retrieval (default to background value).
Chisqr	R*4 (2)	-999	1	Convergence rate: good retrievals with Chisqr <= 3; less reliable retrievals with 3< Chisqr <=10; unreliable retrieval with Chisqr > 10.
Orbit_mode	I*2 (1)	-999	1	Orbit direction: 0=ascending; 1=descending.
LZ_angle	R*4 (2)	-999	1	Local zenith angle range (degrees) Ranges from -59 to 59
PLayer	R*4(1)	N/A	1	Pressure of profile products layers in mbar
PTemp	R*4 (3)	bkv	1	Temperature profiles containing layer temperature in Kelvin
PVapor	R*4 (3)	bkv	1	Water Vapor profiles containing mixing ratio of absorbents for each layer in g/kg
PClw**	R*4 (3)	bkv	1	Cloud profiles containing mixing ratio of cloud particles for each layer in g/kg.
PRain**	R*4 (3)	bkv	1	Cloud profiles containing mixing ratio of rain particles for each layer in g/kg.
PGraupel**	R*4 (3)	bkv	1	Cloud profiles containing: mixing ratio of graupel particles for each layer in g/kg.
PSnow**	R*4 (3)	bkv	1	Cloud profiles containing: mixing ratio of snow particles for each layer in g/kg.
PIce**	R*4 (3)	bkv	1	Cloud profiles containing: mixing ratio of ice particles for each layer in g/kg.
SurfP***	I*2(2)	bkv	10	Surface Pressure in mbar
Note 1 : For Dimensions 1 : scan (retrieval layers for Player) ; 2: scan*spot ; 3: scan*spot*layer				

Note 2: Error Flags

Flag Value	Explanation
-999	Missing product
-888	Products not available
bkv	Background values used when no retrievals available

** : The arrays are only place holders at the Version 1, and the actual values will be filled in and available to users following the timeline listed in Table 1 & 2.

*** : Any values for pressure layers below the reported surface pressure should not be used.

Table 9.6.4.3-3: MIRS Image Swath Attributes

Parameter Name	Data Type	Explanation
Total_scan	I*2	Total number of scans in the data
Num_fov	I*2	Number of FOVs in the orbit data
Num_qcatm	I*2	Number of atmosphere QC parameters
Num_qcsfc	I*2	Number of surface QC parameters
BT_SCAL	R*4	Scale of Brightness Temperature
TPW_SCAL	R*4	Scale of TPW(Total Precipitable Water)
CLW_SCAL	R*4	Scale of CLW(Cloud Liquid Water)
RWP_SCAL	R*4	Scale of RWP(Rain Water Path)
SWP_SCAL	R*4	Scale of SWP(Snow Water Path)
IWP_SCAL	R*4	Scale of IWP(Ice Water Path)
GWP_SCAL	R*4	Scale of GWP(Graupel Water Path)
CLDTOP_SCAL	R*4	Scale of Cloud Top
CLDBASE_SCAL	R*4	Scale of Cloud Base
CLDTHICK_SCAL	R*4	Scale of Cloud Thickness
RR_SCAL	R*4	Scale of Rain Rate
SFR_SCAL	R*4	Scale of SFR (Snow Falling Rate)
SWE_SCAL	R*4	Scale of Snow Water Equivalent
SNOW_SCAL	R*4	Scale of Snow Cover
SICE_SCAL	R*4	Scale of Sea Ice
SURFM_SCAL	R*4	Scale of Surface Moisture
WINDSP_SCAL	R*4	Scale of Wind Speed
WINDDIR_SCAL	R*4	Scale of Wind Vector
WINDU_SCAL	R*4	Scale of Wind Speed in U direction
WINDV_SCAL	R*4	Scale of Wind Speed in V direction
TSKIN_SCAL	R*4	Scale of Skin Temperature
SURFP_SCAL	R*4	Scale of Surface Pressure

EMIS_SCAL	R*4	Scale of Emissivity
-----------	-----	---------------------

Table 9.6.4.3-4: MIRS Image Swath Data Fields				
Parameter Name	Data Type and (Dimension)	Missing Data Value	Scale	Explanation
ScanTime_year	I*2 (1)	-999	1	Four digit calendar year (e.g., 1999)
ScanTime_doy	I*2 (1)	-999	1	Day of year (e.g., 1-366)
Latitude	R*4 (2)	-999	1	Latitude (degrees, e.g., -90 to 90)
Longitude	R*4 (2)	-999	1	Longitude (degrees, e.g., -180 to 180)
TimeUTC	R*8 (1)	-999	1	Number of seconds and fractions since 0000 UTC Jan. 1, 1993 (TAI93)
Atm_type	I*2 (2)	-999	1	Atmosphere type: 1=global
Sfc_type	I*2 (2)	-999	1	Surface Type: 0=ocean, 1=sea-ice, 2=land and 3 =snow cover.
Qc_atm	I*2 (2)	-999	1	Quality flag for retrievals: 0=retrieval; 1=no retrieval (default to background value).
Qc_sfc	I*2 (2)	-999	1	Quality flag for retrievals: 0=retrieval; 1=no retrieval (default to background value).
Chisqr	R*4 (2)	-999	1	Convergence rate: good retrievals with Chisqr <= 3; less reliable retrievals with 3< Chisqr <=10; unreliable retrieval with Chisqr > 10.
Orbit_mode	I*2 (1)	-999	1	Orbit direction: 0=ascending; 1=descending.
LZ_angle	R*4 (2)	-999	1	Local zenith angle range (degrees) Ranges from -59 to 59
BT	I*2(3)	-999	100	Brightness temperatures in K at each frequency channels
TPW	I*2 (2)	bkv	10	Total Precipitable Water (in mm)
CLW**	I*2 (2)	bkv	100	Cloud Liquid Water (in mm)
RWP**	I*2 (2)	bkv	100	Integrated Rain Water Path (in

				mm)
SWP**	I*2 (2)	bkv	100	Integrated Snow Water Path (in mm)
IWP**	I*2 (2)	bkv	100	Integrated Ice Water Path (in mm)
GWP**	I*2 (2)	bkv	100	Integrated Graupel Water Path (in mm)
CldTop**	I*2 (2)	bkv	100	Cloud Top (in mbar)
CldBase**	I*2(2)	bkv	100	Cloud Base (in mbar)
CldThick**	I*2(2)	bkv	100	Cloud Thick (in mbar)
RR**	I*2(2)	bkv	10	Rain Rate (in mm/hr)
Rflag**	I*2(2)	bkv	1	Rain Flag (0/1)
SFR**	I*2(2)	bkv	10	Snow Falling Rate (in mm/hr)
PrecipType**	I*2(2)	bkv	1	Precipitation type
Snow**	I*2(2)	bkv	1	Snow Cover (0/1)
SWE**	I*2(2)	bkv	100	Snow Water Equivalent (cm)
SIce**	I*2(2)	bkv	1	Sea Ice Concentration (%)
SurfM**	I*2(2)	bkv	100	Surface Soil Moisture (mm)
WindSP**	I*2(2)	bkv	100	Wind Speed (in m/s)
WindDir**	I*2(2)	bkv	100	Wind Direction (in degree)
WindU**	I*2(2)	bkv	100	Wind Speed in U direction (m/s)
WindV**	I*2(2)	bkv	100	Wind Speed in V direction (m/s)
TSkin	I*2(2)	bkv	100	Skin Temperature (in Kelvin)
SurfP	I*2(2)	bkv	100	Surface Pressure (in mbar)
Emis	I*2(3)	bkv	100	Emissivity Vector

Note 1 : For Dimensions

1 : scan ; 2: scan*spot ; 3: scan*spot*channel

Note 2: Error Flags

Flag Value Explanation

-999 Missing product

-888 Operational products not available

bkv Background values used when no retrievals available

** : The arrays are only place holders at the Version 1, and the actual values will be filled in and available to users following the MIRS operational delivery timeline. Some of them will be only available as experimental products. Operational products can be referred to MIRS deliverables in

9.6.4.4 Data Access

The MIRS data sets are able to be accessed via class. The URLs to access the data are listed below:

<http://www.class.noaa.gov>

<http://www.class.ncdc.noaa.gov>

<http://www.class.ngdc.noaa.gov>

9.7 OZONE PRODUCTS

This section describes in detail the three operational ozone products based on the data collected from the SBUV/2 instrument. The three products are:

- o 1b Data Set
- o Product Master File - Original Format and BUFR Format

9.7.1 1b DATA SET

The 1b dataset is an operational product of the SBUV/2 instrument and should not be confused with the Level 1b database described in Section 8. (The SBUV/2 1b dataset does not meet the Level 1b definition.)

9.7.1.1 Overview

The 1b data set contains:

- (1) All SBUV/2 sensor data (except boost mode data [first several minutes after launch]; data with unreasonable year, day or time of day; and data within an orbit that is not time ascending) and support data necessary for the derivation of atmospheric ozone and solar flux;
- (2) Instrument in-flight calibration data and housekeeping functions for monitoring post-launch instrument changes; and
- (3) Prelaunch calibration factors, computed current-day instrument calibration and albedo correction factors to adjust the ozone algorithm for actual instrument performance. Initially, only prelaunch calibration adjustments will be made until the Instrument Support Subsystem is implemented.

The SBUV/2 sensor data consists of radiance and irradiance measurements taken in both the discrete mode (12 wavelengths) and the sweepmode (1680 wavelengths) at approximately 2 Angstrom (Δ) intervals. The support data includes earth location data derived from predictive ephemeris, cloud and temperature from TOVS, ancillary data to initialize the algorithm, surface pressure data, and (to be added at a later date) snow/ice data.

9.7.1.2 Contents

The following subsections describe the contents of the 1b data set:

- Raw SBUV/2 data
- Cloud and temperature data from TOVS
- Surface pressure data
- Ancillary data set

- Instrument calibration and albedo correction data
- Instrument status and quality flags
- Earth location data
- Fill values on the 1b data set

9.7.1.2.1 Raw SBUV/2 Data

Each major frame (32 seconds) of raw SBUV/2 data received from the satellite results in one discrete or two sweep data records on the 1b data set. Each discrete data record contains SBUV/2 instrument data collected from 12 discrete wavelengths by the monochromator (one wavelength if it is in the position mode) and one wavelength by the CCR plus electronic calibration data. The instrument may be in discrete, sweep, position, wavelength calibration or diffuser decontamination mode and viewing either the Earth, wavelength calibration lamp or diffuser plate. Each sweep data record contains SBUV/2 instrument data collected in the instrument sweep mode. In this mode the instrument will usually be viewing the diffuser plate in order to take solar measurements, however other viewing scenes are possible. For a complete set of 1680 wavelength measurements, twelve 16 second sweep data records are required. These correspond to six 32 second major frames.

All SBUV/2 data are preserved as raw counts on the 1b data set. The only conversions to engineering units are done for the orbital and daily statistics.

The data on the 1b data set are arranged in terms of SBUV/2 orbits. The SBUV/2 orbit definition is different from the standard TIROS-N series (NOAA/NESDIS) orbit definition. Each SBUV/2 orbit begins when the center of the SBUV/2 instrument field of view (FOV) transits the equator on the dark viewing side of the Earth and continues through one satellite revolution about the Earth. Earth location data is used to ascertain equator crossing but is only given for the start time of each TIP major frame's worth of data. Thus, the SBUV/2 orbital designation of each TIP major frame's worth of information is based on the earth location at the start of each major frame.

The orbit definition used on the TIROS-N series satellite has the orbital boundary occurring at northbound equator crossing regardless of the time the satellite views the Earth. By this definition an afternoon satellite's (northbound equator crossing on the sunlit side of the Earth) orbits begin during daylight viewing times (i.e. about 50 minutes out of phase with SBUV/2 orbits). SBUV/2 will fly only on afternoon satellites. The change in the orbit definition is to provide continuity with that used for Nimbus-7 SBUV.

9.7.1.2.2 Major Frame Synchronization

Each major frame contains 32 channels, or groups of 10 minor frames, with each channel containing one second's worth of data. Some of the data stored in a particular channel is data that was actually sampled during the previous second and thus belongs to the previous channel. Data items belonging to the previous channel are synchronized (placed in the proper channel)

before being written to the daily 1b data set on either discrete sweep data records. This means that some of the data arriving in the first channel of a given major frame is placed in the last channel of the previous major frame before being processed.

The following items need synchronization.

- Grating position
- CCR and PMT data
- Status Word 1 of Digital A data - all items
- Status Word 2 of Digital A data - all items

9.7.1.2.3 Cloud and Temperature Data from TOVS

Meteorological data is provided to the SBUV/2 Data Set from the TIROS Operational Vertical Sounder (TOVS) carried aboard the same satellite as the SBUV/2 instrument. When available, the total ozone algorithm uses cloud information to estimate the ozone hidden from the satellite sensor below the clouds. The TOVS utilizes three instruments for the satellites prior to NOAA-K:

- 1) A High Resolution Infrared Radiometric Sounder (HIRS/2),
- 2) A Microwave Sounding Unit (MSU), and
- 3) A Stratospheric Sounding Unit (SSU).

The TOVS products used by SBUV/2 are: cloud amounts, cloud top temperatures, and vertical profiles of atmospheric temperatures.

The vertical temperature profiles are given for up to forty specified pressure levels ranging from 1000 mb (or surface level) to 0.1 mb. These profiles represent one “box” in the current operational TOVS processing system (formerly a “box” in the old TOVS processing system). A “minibox” consists of 63 HIRS/2 fields of view (called spots) from 7 HIRS/2 scan lines (a “box” consisted of 9 spots from 3 scan lines). Certain quality checks are made during TOVS processing to assure the reasonableness of the temperature profiles. If any of these checks indicate a bad sounding, or the data is unavailable the profile is rejected during the SBUV/2 processing and replaced with fill values.

Cloud amounts and cloud top temperatures are provided on a spot by spot basis. The current operational TOVS processing system provides SBUV/2 with cloud data for boxes which are adjacent to nadir. Miniboxes are constructed by selection of the appropriate spots in a box. Cloud top pressures (analogous to cloud top height) are computed for each spot by linear interpolation of the cloud top temperature between adjacent levels in the temperature profile.

Averages of cloud amount, cloud top temperature, and atmospheric temperature profiles are computed to represent the area sampled by those SBUV/2 fields of view (the four longest wavelengths fields of view in the discrete mode) used in the total ozone computation. This area

is equivalent to 30 HIRS/2 spots. Cloud averages are computed using all spots (except fills) lying within the composite SBUV/2 field of view area. Temperature profile averages include only those from miniboxes with two or three HIRS/2 scan lines lying within this composite SBUV/2 field of view area.

Temperatures of 20 pressure levels (more than needed by the ozone algorithms) have been saved on the 1b Data Set for future implementation of temperature dependency of the ozone absorption coefficients.

Meteorological data is collected only when the instrument is in the discrete mode (normal mode for ozone determination), the position mode (rarely if ever used), and wavelength calibration mode. These three modes have in common the same record format, i.e. the discrete data record. As the ancillary data is not time dependent, this data will be written once for each Daily 1b data set. It is not saved for sweep mode data.

9.7.1.2.4 Surface Pressure Data

The source of this data is the same as that used for Nimbus SBUV processing. It was originally derived from a terrain height data set obtained from NOAA. Terrain heights in kilometers (km) were converted to millibars (mb) using the following equation:

$$P = 1013.25(1 - 0.0257H)^{5.256}$$

where H is the terrain height in km.

The entire globe is divided into 2.5 x 2.5 degree latitude and longitude cells with terrain pressure given for each cell. A total of 10,585 values are given. A two-dimensional interpolation procedure using the four closest grid points is used to find the value of terrain pressure at the start of each major frame. Surface pressure is supplied for discrete mode data only.

9.7.1.2.5 Ancillary Data

The Ancillary Data Set contains the thirteen SBUV/2 bandcenter wavelengths, their associated ozone absorption and Rayleigh scattering coefficients, total ozone and multiple scattering correction lookup tables, and the a priori profiling information. This is the data required to initialize the ozone algorithm.

The Multiple Scattering Coefficients data records contain 1700 values (10 solar zenith Angles, 23 standard ozone profiles, five wavelengths and two surface pressures) of Log Q, 1700 values of Log Q (single scattered), 1700 values of reflected fraction and 170 values (for 23 standard ozone profiles, five wavelengths and two surface pressures) of atmospheric-surface backscatter fraction). The Total Ozone Tables data records contain 1700 values of Log I_o, 1700 values of

reflected fraction, and 170 values of atmospheric-surface backscatter fraction. The A-Priori Profile Information data records will contain 180 values of a priori profile coefficients and 144 values for the a priori covariance matrix elements.

As the ancillary data is not time dependent, this data will be written one for each Daily 1b Data set.

9.7.1.2.6 Instrument Calibration and Albedo Correction Data

The Instrument Calibration and Albedo Correction Data contains four sets of values:

- i) Prelaunch radiance and irradiance calibrations
- ii) Day 1 solar irradiance calibrations
- iii) Monochromator interranging ratios
- iv) Albedo Correction Factors

Initially, only prelaunch radiance and irradiance calibrations will be on the 1b Data Set until the Instrument Support Subsystem is implemented. Three sets of prelaunch calibration values are required:

- i) Radiance calibrations - count to W/cm^3 conversion constants
- ii) Irradiance calibrations - count to $W/cm^3/sr$ conversion constants
- iii) Prelaunch diffuser check flux ratios

The radiance and irradiance calibrations each consist of 37 constants: one value for the CCR at 3786.2 Å and 12 values for each of the three monochromator gain ranges at the 12 discrete wavelengths. The ratios of the radiance and irradiance calibrations are used in the computation of I/F ratios in the ozone computation. The prelaunch flux ratios will be used to perform the diffuser calibration in the instrument support subsystem. There will be one ratio for each mercury line chosen which is to be specified.

The monochromator interranging ratios and albedo correction factors are derived from the previous N (to be specified) day's instrument outputs for the current day 1b and ozone processing. There are two interranging ratios for the monochromator, one between gain ranges 1 and 2 (IRR_{21}) and one between gain ranges 2 and 3 (IRR_{32}).

The albedo corrections account for solar flux and instrument changes and are used to adjust the I/F ratios in the ozone processing; there are 13 values for a day, one for the CCR wavelength (3786.2 Å) and twelve for the monochromator discrete wavelengths.

9.7.1.2.7 Instrument Status and Quality Flags

The 1b Data Set contains a comprehensive set of flags that provide instrument status and data quality information. Table 9.7.1.2.7-1 summarizes the types of flags, where in the processing

system they are set and what ranges of data they cover. The flags are defined in the Data Dictionary (Section 9.7.4).

Table 9.7.1.2.7-1. 1b Data Set Instrument Status and Data Quality Flags.		
Data Quality Flags	Where Set*	Data Range Covered
Minor Frame Quality Flags	Decommutation	Channel
Major Frame Quality Flags	Raw TIP/ Decommutation Immediate	Major Frame
Final Channel Quality Flags	1b	Channel
Channel Fill Flags	1b	Channel
Channel Error Flags	1b	Channel
Sample Status Flags	1b	1 discrete sample 10 sweep samples
Summary Status Flags		
Summary Grating Mode	1b	Major Frame**
Summary Grating Memory Mode	1b	Major Frame**
Scene Mode	1b	Major Frame**
Instrument Data Quality Flag	1b	Major Frame**
Channel=10 minor frames=1 second		
Major frame=320 minor frames=32 seconds		
Discrete sample=2 second interval		
10 Sweep samples=1 second interval		
*Refer to Section 1.5 for a discussion of the step for the Operational Ozone Product System **Based on major frames where ECAL/Retrace is off.		

9.7.1.2.8 Earth Location Data

For the start time of each TIP Major Frame (every 32 seconds), using as input the ephemeris (i.e. spacecraft position and velocity vectors) data from GTDS, the following earth location parameters are derived.

- Subsatellite Latitude
- Subsatellite Longitude
- FOV Latitude
- FOV Longitude
- Solar Zenith Angle at FOV
- Solar Azimuth Angle at FOV
- Solar Right Ascension
- Solar Declination
- Spacecraft-centered Solar Elevation Angle
- Spacecraft-centered Solar Azimuth Angle
- Altitude of Satellite

9.7.1.2.9 Fill Values on the 1b Data Set

A fill value may be inserted into an individual data item on the 1b Data Set to indicate that the original data in the input data stream was missing. The Daily Headers and Ancillary Data contain no fill values. The only record types which contain fill values in the Daily Data Records files of the 1b Data Set are the Discrete and Sweep Data Records. Fill values for data items or groups of data items are given in Table 9.7.1.2.9-1.

Table 9.7.1.2.9-1. Fill Values on Data Records.		
Data Items or Group of Data Items	Fill Values	Comment
Attitude Data	-32,767 (Hex Code 8001)	Reason for fill given by Major Frame Quality Dwell Mode, Data Fill or Missing Attitude Flags
Earth Location Data	-32,767	Reason for fill is no Earth Location Data Found by Decommuation Program (Indicated by Major Frame Quality Flag For No Earth Location Data)

Digital B Telemetry & Data and Analog	All Bits set to 1	Reason for fill given in this frame's and possibly next frame's Major Frame Quality Flag: Dwell Mode, or Data Fill Flags
Digital A Instrument Data except Recommended Monochromator Range I. D.		Reason for fill given by Major Frame Quality Flags: Data Fill Flags
Meteorological and Geographical Support Data except for FOV Snow/Ice Flag, Cloud Amount/Cloud Albedo and Cloud Amount for Spots 1-9	-7777	Cloud top pressure set to -7777 when no clouds present in 8 second SBUV/2 FOV (i.e. cloud amount = 0)
Cloud Amount/Cloud Albedo	-1028	
Cloud Amount for Spots 1-9	-8	
FOV Snow/Ice Flag Digital A	-1	
Digital A Analog Housekeeping Data	All bits set to 1	Reason for fill given by Major Frame Quality Flags: Dwell Mode or Data Fill Flags
Total Ozone and Profile	-77.0	Reason given by corresponding Ozone Data Error Flag
Note: this table includes some data items not found in the 1b Data Set.		

9.7.1.3 Data Organization

Each 1b Data Set consists of a file containing a calendar month of data. A data set standard header (the OOPS Standard Header Records for the monthly product) describes the data contained on the tape. This is followed by a series of Daily 1b Data Sets, one for each day of the month. Once a calendar month is completed, the complete monthly data set is made available to CLASS on the second day of the following month.

Each Daily 1b Data Set as described in Table 9.7.1.3-1 begins with OOPS Standard Header Records that describe the current day's data set and all the input data sets used to create it. This includes the ancillary data, the instrument calibration and albedo correction data, each SBUV/2 orbit in the correct day, and the daily statistical summary. All data for an orbit that begins the current day is included in the current day. The contents of these data files are described in Section 9.7.1.4. The organization of the Daily 1b Data Set header records is described in Table

9.7.1.4-1. A schematic overview of the 1b Data Set is shown in Figure 9.7.1.3-1. Data is in time ascending order.

The 1b Data Set has a logical record length (LRECL) of 720 bytes and a physical blocksize (BLKSIZE) of 25,920 bytes (36 logical records/block).

Table 9.7.1.3-1. Daily 1b Standard Header Record Data Set Order.	
Output:	
1.	Daily 1b Data Set
Direct Inputs:	
2.	Ancillary Data Set
3.	Instrument Calibration and Albedo Correction Data Set
4.	Daily Intermediate Data Set
5.	Daily Meteorology and Geographic Data Set
Indirect Inputs:	
6.	Spectral Information Data Set
7.	Bass Coefficients Data Set
8.	Absorption Coefficients Data Set
9.	Ancillary Intermediate Data Set (Oldest)
10.	Ancillary Intermediate Data Set (Latest)
11.	A Priori Data Set
12.	Prelaunch Calibration Data Set
13.	Day 1 Solar Flux Data Set
14.	Interrange Ratios Data Set
15.	Albedo Correction Factor Data Set
16.	Surface Pressure File

Figure 9.7.3-1. 1b Data Table

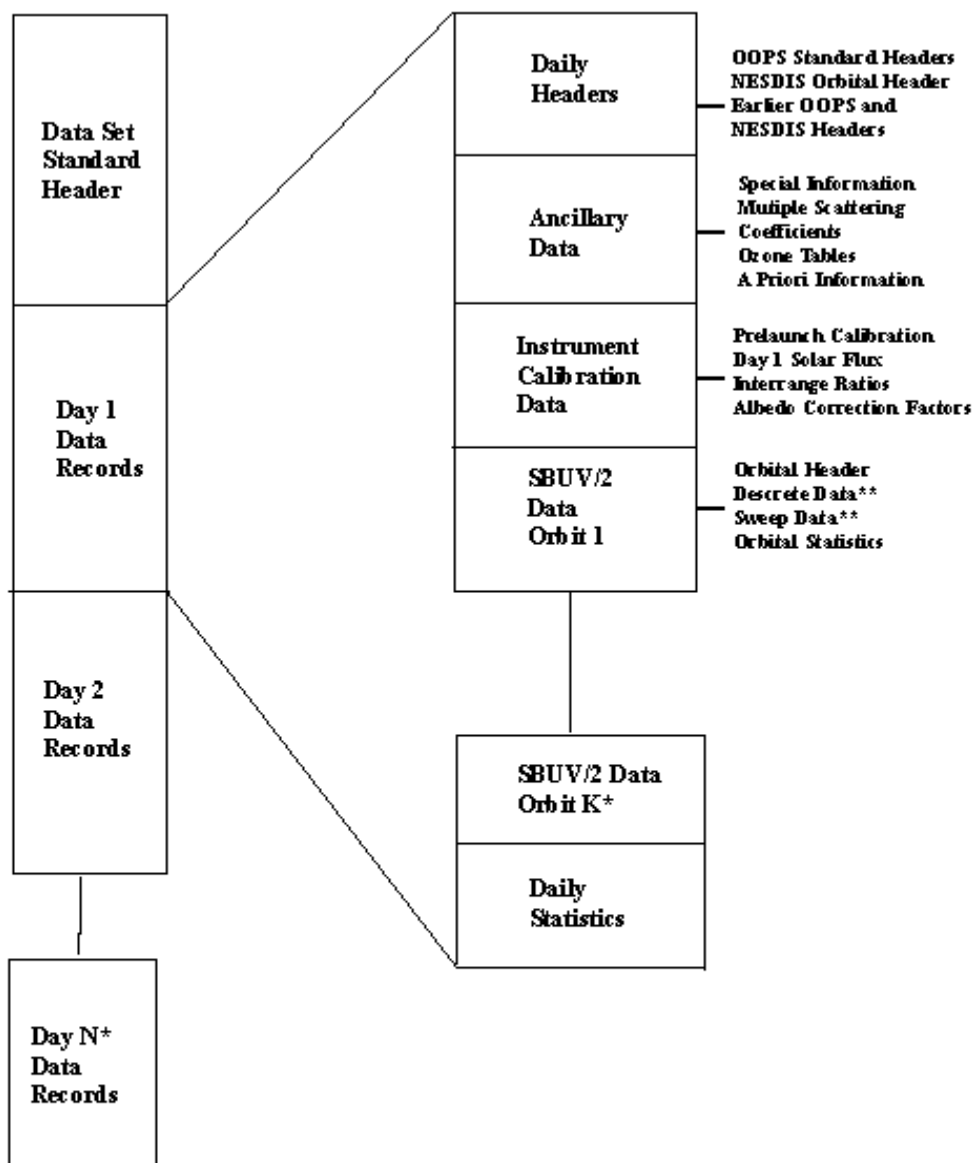

*N < 31, K < 14 (usually)
 ** These record types may be interspersed within a given orbit depending on the instrument command sequence.

Figure 9.7.1.3-1. 1b Data Table

9.7.1.4 Record Layouts

The following pages describe the layout of each record in the 1b Data Set. The OOPS Standard Header record is shown in Section 9.7.3. Individual data items are described in the Data Dictionary (Section 9.7.4). Records appear on the 1b Data Set in the order shown below:

Table 9.7.1.4-0. List of Tables in 1b Data Set		
Standard Record Layout		
9.7.1.3-1	Data Set Standard Header	2/ Data Set (Month)
Daily Headers		
9.7.3-1 and 9.7.3-2	OOPS Standard Header Records NESDIS Orbital Header Records	32/Day Variable
Ancillary Data		
9.7.1.4-3	Spectral Information Data Record (DR)	1/Day
9.7.1.4-4	Multiple Scattering Coefficients DR	40/Day
9.7.1.4-5	Total Ozone Tables DR	33/Day
9.7.1.4-6	A Priori Information DR	2/Day
Calibration Data		
9.7.1.4-7	Prelaunch Calibration DR	1/Day
9.7.1.4-8	Day 1 Solar Flux DR	1/Day
9.7.1.4-9	Interrange Ratios DR	1/Day
9.7.1.4-10	Albedo Correction Factor DR	1/Day
SBUV/2 Data		
9.7.1.4-11	SBUV/2 Orbital Header Record	1/Orbit
9.7.1.4-12	Discrete DR	Variable
9.7.1.4-13	Sweep DR	Variable
9.7.1.4-19	SBUV/2 Orbital Statistical Record	1/Orbit
9.7.1.4-20	Daily SBUV/2 Statistical Record	1/Day

Except where noted in the record layouts, data is stored in signed full word integer (I*4), signed half-word integer (I*2), or unsigned individual byte integers (all 8 bits are used in computing the integer value). All data are stored in UNIX IEEE data type conventions. For flag fields consisting of several individual bit flags, a byte/bit breakdown is included following the record format.

Table 9.7.1.4-1 contains a list of each record type found in the 1b Data Set. Figure 9.7.1.4-1 shows the layout of the 1b Data Set Record.

Figure 9.7.1.4-1. SBUV 1b Data Set Record IDs.	
Record ID	Record Description
Data Set Headers	
241	OOPS Standard Header Record I
242	OOPS Standard Header Record II
250	NESDIS Orbital Header Record
Ancillary Data	
465	Spectral Information Data Record
475	Multiple Scattering coefficients Data Record
485	Total Ozone Tables Data Record
495	A Priori Information Data Record
Instrument Calibration Data	
525	Prelaunch Calibration Data Record
565	Day 1 Solar Flux Data Record
575	Interrange Ratios Data Record
585	Albedo Correction Factor Data Record
SBUV/2 Data	
651	SBUV/2 Orbital Header Record
661	Discrete Mode Data Record (Discrete Record Format)

662	Wavelength Calibration Mode Data Record (Discrete Record Format)
663	Position Mode Data Record (Discrete Record Format)
664	Diffuser Decontamination Data Record
671	Sweep Mode Data Record (Sweep record Format)
681	Conflicting Modes* Record (Discrete Record Format)
682	Conflicting Modes* Record (Sweep Record Format)
691	SBUV/2 Orbital Statistical Record
695	Daily SBUV/2 Statistical Record

Note:

The data format (discrete or sweep) and grating mode (discrete, sweep, wavelength calibration, position, or diffuser decontamination) of a Discrete or Sweep Data Record are determined from each of the 32 channels of the corresponding Major Frame Data Record. If any channel data of a Major Frame Record indicates a record format or grating mode that is different from previous channel data within that major frame, the corresponding Discrete or Sweep Data Record is labeled as an Inconsistent Discrete or Inconsistent Sweep Data Record. If the data format is inconsistent the record is written as an Inconsistent Sweep data Record, regardless of whether or not the grating mode is inconsistent. If only the grating mode is inconsistent, the record is written as an Inconsistent Discrete Data Record if the record format is discrete and as an Inconsistent Sweep Data Record if the record format is sweep.

Table 9.7.1.4-1. SBUV Level 1b Data Set Record Layouts.

NESDIS Orbital Header Record				
	Byte 1	Byte 2	Byte 3	Byte 4
Word	Description			
1	Record ID			
2	S/C ID	Data Type	Start Time	
3				
4	Number of Major Frames		End Time	
5				

6	Processing	Block ID		
7				Spare
8	Number of Data Gaps		DACS Quality	
9				
10	Spare		DACS Status	Spare
11-180	Spare			

Note:

The Start/End Time, Data Type, and DACS Quality, DACS Status of the NESDIS Orbital Header Record are broken down further in Table 9.7.1.4-2.

Processing Block ID: 7 byte field stored in character code (ASCII)

Table 9.7.1.4-2. Byte/bit Breakdown of NESDIS Orbital Header Data.						
Starting				Ending		
Data Item	Word	Byte	Bit*	Word	Byte	Bit
Data Type:						
Type of Data	2	2	1	-	-	4
TIP Source	2	2	5	-	-	8
Start Time:						
Year	2	3	1	-	-	7
Day of Year	2	3	8	-	4	8
Spare	3	1	1	-	-	5
Milliseconds of Day	3	1	6	-	4	8
End Time:						
Year	4	3	1	-	-	7
Day of Year	4	3	8	-	4	8
Spare	5	1	1	-	-	5
Milliseconds of Day	5	1	6	-	4	8

DACS Quality:						
No Frame Synch word Counter	8	3	1	-	4	8
TIP Parity Error Counter	9	1	1	-	2	8
Aux Synch Error Counter	9	3	1	-	4	8
DACS Status:						
P/N Flag	10	3	1	-	-	-
Data Source	10	3	2	-	-	3
Tape Direction	10	3	4	-	-	-
Data Mode	10	3	5	-	-	-
Spare	10	3	6	-	-	8
Notes:						
*Most Significant bit (MSB) = bit 1, Least significant bit (LSB) = bit 8.						
** A dash indicates no change from starting value						

Table 9.7.1.4-3. Ancillary Data Spectral Information Data Record.				
	Byte 1	Byte 2	Byte 3	Byte 4
Word	Description			
1	Record ID			
2	Bandcenter Wavelength of Discrete Channel 1			
3-13	Same as word 2 but for Discrete Channels 2-12			
14	Same as word 2 but for CCR Channel			
15	Effective Ozone Absorption coefficients for Discrete Channel 1			
16-26	Same as word 15 but Discrete Channels 2 12			
27	Same as word 15 but for CCR Channel			
28	Rayleigh Scattering Coefficients for Discrete Channel 1			
29-39	Same as word 28 but for Discrete Channels 2 - 12			
40	Same as word 28 but for CCR Channel			

41-180	Spare
Note: Words 2-40 are stored in floating point (R*4).	

Table 9.7.1.4-4. Ancillary Data Multiple Scattering Coefficients Data Record.				
	Byte 1	Byte 2	Byte 3	Byte 4
Word	Description			
1	Record ID			
2-180	179 entries of Multiple Scattering Coefficients Containing:			
	Values of Log Q			
	Values of Log Q (Single Scattered)			
	Values of Log Reflected Fraction			
	Values of Atmosphere Surface Backscatter Fraction			
(See Section 9.7.1.2.4 for further breakdown)				
Note: Words 2 - 180 are stored in floating point (R*4).				

Table 9.7.1.4-5. Ancillary Data Total Ozone Tables Data Record.				
	Byte 1	Byte 2	Byte 3	Byte 4
Word	Description			
1	Record ID			
2-180	179 Entries of Total Ozone Lookup Table containing:			
	Values of Log I _o			
	Values of Reflected Fractions and			
	Values of Atmosphere Surface Backscatter Fraction			
	(See Section 9.7.1.2.4 for further breakdown)			
Note: Words 2-180 Are Stored in Floating Point (R*4).				

Table 9.7.1.4-6. Ancillary Data A Priori Information Data Record.				
	Byte 1	Byte 2	Byte 3	Byte 4
Word	Description			

1	Record ID
2-180	179 Entries of <i>A Priori</i> information containing:
	Values of <i>A Priori</i> profile coefficients
	Values of <i>A Priori</i> covariance matrix elements
	(See Section 9.7.1.2.4 for further breakdown)
Note: Words 2-180 are stored in floating point (R*4).	

Table 9.7.1.4-7. Prelaunch Calibration Data Record.				
	Byte 1	Byte 2	Byte 3	Byte 4
Word	Description			
1	Record ID			
2	Prelaunch Radiance Calibration for CCR Channel			
3	Prelaunch Radiance Calibration for Discrete Channel 1, PMT Range 1			
4-14	Same as word 3 but for Channels 2-12, PMT Range 1			
15-26	Same as words 3-14 but for PMT Range 2			
27-38	Same as words 3-14 but for PMT Range 3			
39-75	Same as words 3-28 but for Prelaunch Irradiance Calibrations			
76-87	Prelaunch Diffuser Flux Ratios at 12 Possible Mercury Wavelengths			
88	Prelaunch Diffuser Flux Ratios at CCR Wavelength			
89-180	Spare			
Note: Words 2-75 are stored in floating point (R*4).				

Table 9.7.1.4-8. Day 1 Solar Flux Data Record.				
	Byte 1	Byte 2	Byte 3	Byte 4
Word	Description			
1	Record ID			

2	Day 1 Solar Irradiance for Discrete Channel 1
3-13	Same as word 2 but for Channels 2-12
14	Same as word 2 but for CCR Channel
15-180	Spare
Note: Words 2-14 are stored in floating point (R*4).	

Table 9.7.1.4-9. Interrange Ratios Data Record.				
	Byte 1	Byte 2	Byte 3	Byte 4
Word	Description			
1	Record ID			
2	Number of Coefficients for Interrange Ratios between Monochromator Range 1 and 2 (IRR ₂₁)			
3	First Coefficient for IRR ₂₁			
4-14	Same as Word 3 but for Second through possible Twelfth Coefficient			
15	Number of Coefficients for Interrange Ratios between Monochromator Range 2 and Range 3 (IRR ₂₃)			
16	First Coefficient for IRR ₂₃			
17-27	Same as word 16 but for Second through possible Twelfth Coefficient			
28-180	Spare			
Note: Words 3-14 and 16-25 are stored in floating point (R*4). Words 2 and 15 are I*4.				

Table 9.7.1.4-10. Albedo Correction Factor Data Record.				
	Byte 1	Byte 2	Byte 3	Byte 4
Word	Description			
1	Record ID			
2	Albedo Correction Factor for Discrete Channel 1			
3-13	Same as word 2 but for Channels 2-12			

14	Same as word 2 but for CCR Channel
15-180	Spare
Note: Words 2-14 are stored in floating point (R*4).	

Table 9.7.1.4-11. SBUV/2 Orbital Header Record.				
	Byte 1	Byte 2	Byte 3	Byte 4
Word	Description			
1	Record ID			
2	SBUV/2 Orbit Number			
3	SBUV/2 Day Number			
4	Year of first Major Frame in SBUV/2 Orbit			
5	Day of Year of First Major Frame in SBUV/2 Orbit			
6	Seconds of Day at Start of First Major Frame in SBUV/2 Orbit			
7	FOV Latitude at Start of First Major Frame in SBUV/2 Orbit			
8	FOV Longitude at Start of First Major Frame in SBUV/2 Orbit			
9	Year of Last Major Frame in SBUV/2 Orbit			
10	Day of Year at Last Major Frame in SBUV/2 orbit			
11	Seconds of Day at Start of Last Major Frame in SBUV/2 Orbit			
12	FOV Latitude at Start of Last Major Frame in SBUV/2 Orbit			
13	FOV Longitude at Start of Last Major Frame in SBUV/2 Orbit			
14	NESDIS Orbit Number at Start of SBUV/2 Orbit			
15	NESDIS Orbit Number at End of SBUV/2 Orbit			
16-180	Spare			

Table 9.7.1.4-12. Discrete Data Record.
Data Identifiers

	Byte 1	Byte 2	Byte 3	Byte 4
Word	Description			
1	Record I.D.			
2	Major Frame Counter		Discrete/Sweep Indicator Record	
3	Year		Day of Year	
4	Seconds of day (T_0)			
5	SBUV/2 Orbit Number			
6	SBUV/2 Day Number			
7	Major Frame Quality Flags			
8	Minor Frame Quality Flags			
9-10	Spare			
Attitude Data				
11	Yaw Euler Error Angle within 1 st Second		Yaw Euler Error Angle within 9 th Second	
12	Yaw Euler Error Angle within 17 th Second		Yaw Euler Error Angle within 25 th Second	
13-14	Same as 11-12 but for 4 Roll Euler Error Angles			
15-16	Same as 11-12 but for 4 Pitch Euler Error Angles			
Earth Location Data				
17	Spare		Spacecraft altitude	
18	Solar Right Ascension		Solar declination	
19	Subsatellite latitude		Subsatellite longitude	
20	FOV latitude @ T_0		FOV latitude @ $T_0 + 32$ seconds	
21	FOV longitude @ T_0		FOV longitude @ $T_0 + 32$ seconds	
22	Solar Zenith Angle (SZA) @ FOV @ T_0		SZA @ FOV @ $T_0 + 32$ seconds	

23	Solar Azimuth Angle (SAA) @ FOV @ T ₀	SAA @ FOV @ T ₀ + 32 seconds		
24	Spacecraft (S/C) centered Solar Elevation Angle (SEA) @ T ₀	S/C centered SEA @ T ₀ + 32 seconds		
25	S/C centered SAA @ T ₀	S/C centered SAA @ T ₀ + 32 seconds		
26-30	Spare			
Digital B Telemetry				
31-32	Digital B Telemetry			
Status Flags				
33	Instrument Data Quality Flags	Summary Grating Mode	Scene Mode	Summary Grating Memory Mode
34	Channel Fill Flags			
35	Channel Error Flags			
36	Final Channel Quality Flags			
37	Spare			
38	Sample Status Flag #1	Sample Status Flag #2	Sample Status Flag #3	Sample Status Flag #4
Digital A Instrument Data				
39	Monochromator Grating Position	Radiometric DC level	Grating Position Error	
40	Memory Verify	CCR and Monochromator Overrange Flags		
41	CCR Data	Monochromator Range 1 Data		
42	Monochromator Range 2 Data	Monochromator Range 3 Data		
43	Recommended Monochromator Range Data	Recommended Monochromator Range ID		
44-133	Same as Words 38-43 for next 15 samples.			

134-137	Spare			
Meteorological and Geographic Support Data				
138	FOV Surface Pressure	FOV Snow/Ice Flag		
139	FOV Average Cloud Amount	FOV Average Cloud Top Pressure		
140	FOV Average Temperature @ 0.5 mb	FOV Average Temperature @ 1.0 mb		
141-149	Same as word 140 but for FOV Average Temperatures at 1.5, 2, 3, 4, 5, 7, 10, 15, 20, 25, 30, 50, 60, 70, 85, 100, 200, and 400 mb			
150-154	Spare			
Housekeeping Data				
155	Digital A Analog Housekeeping Channel 1A	Digital A Analog Housekeeping Channel 1B	Digital A Analog Housekeeping Channel 2A	Digital A Analog Housekeeping Channel 2B
156-162	Same as Word 155 for Digital A Analog Housekeeping Channels 3A/3B through 16A/16B			
163	Analog Telemetry Point #1	Analog Telemetry Point #2	Analog Telemetry Point #3	Analog Telemetry Point #4
164-167	Same as Word 163 but for Analog Telemetry Points 5-17			
167	Analog Telemetry Point #17	Spare		
168-180	Same as Words 155-167 but for the second 16 second interval			
<p>Notes: T_0 = Time (seconds) at start of Major Frame Major Frame Quality Flags: See Byte/Bit Breakdown *Words 33-36, 38 are individual bit data. For Instrument Data Quality Flag and Sample Status Flags see Byte/bit breakdown. For CCR and Monochromator Overrange Flags: See Byte/Bit Breakdown.</p>				

Table 9.7.1.4-13. Sweep Data Record Data Identification, Attitude, Earth Location Data, Digital B and Status Flags.

	Byte 1	Byte 2	Byte 3	Byte 4
Word	Description			
1-38	Same as Words 1-38 of Discrete Data Record			
Digital A Instrument Record				
39	CCR and Monochromator Overage Flags		Monochromator Range ID	
40	Monochromator Grating Position		CCR Data	
41	Monochromator Data: sample #1		Monochromator Data: sample #2	
42-45	Same as Word 41 but for samples 3-10			
46-165	Same as Words 38-45 but for next 15 one second intervals			
166-167	Spare			
Housekeeping Data				
168-180	Same as words 155-167 of Discrete Data Record but covering appropriate 16 second sweep data record interval.			
Note: CCR and Monochromator Overage Flags, and Monochromator ID: See byte/bit breakdown.				

Table 9.7.1.4-14. Byte/bit Breakdown of Discrete Data.						
Data Item	Starting			Ending**		
	Word	Byte	Bit*	Word	Byte	Bit
Monochromator Grating Position:						
Grating Position	39	1	1	-	2	5
Segment Being Read	39	2	6	-	-	7
Digital lock	39	2	8	-	-	-
CCR and Monochromator Overage Flags:						
CCR Overage Flag	40	3	1	-	-	4

Monochromator Range Number 1 Overrange Flag	40	3	5	-	-	8
Monochromator Range Number 2 Overrange Flag	40	4	1	-	-	4
Monochromator Range Number 3 Overrange Flag	40	4	5	-	-	8

Table 9.7.1.4-15. Byte/bit Breakdown of Discrete/Sweep Data.

Data Item	Starting			Ending**		
	Word	Byte	Bit*	Word	Byte	Bit
Major Frame Quality Flags:						
Bad Quality Major Frame Flag	7	1	1	-	-	-
Time Error Flag	7	1	2	-	-	-
Dwell Mode Flag	7	1	3	-	-	-
Boost Mode Flag	7	1	4	-	-	-
Data Fill Flag	7	1	5	-	-	-
Spare	7	1	6	-	-	-
Missing Attitude Data Flag	7	1	7	-	-	-
No SBUV/2 Earth Location Data Flag	7	1	8	-	-	-
Spare	7	2	1	7	3	8
Unreasonable Date or Time Flag	7	4	1	-	-	-
Non-time Ascending Data Flag	7	4	2	-	-	-
Out of Range Attitude Data Flag	7	4	3	-	-	-
Out of Range Analog Telemetry Data Flag	7	4	4	-	-	-
Out of Range Earth Location Data Flag	7	4	5	-	-	-
Major/Minor Frame Inconsistency Flag	7	4	6	-	-	-
Spare	7	4	7	-	-	8

Table 9.7.1.4-16. Byte/bit Breakdown of Discrete Data.						
	Starting			Ending**		
DIGITAL B TELEMETRY:	Word	Byte	Bit*	Word	Byte	Bit
1st 3.2 second interval						
Telemetry Point 1	31	2	3	-	-	-
Telemetry Point 2	31	2	4	-	-	-
...					-	-
Telemetry Point 22	31	4	8	-	-	-
6th 3.2 second interval						
Telemetry Point 1	32	2	3	-	-	-
Telemetry Point 2	32	2	4	-	-	-
...						
Telemetry Point 22	32	4	8	-	-	-
Instrument Data Quality Flag:						
Master Power ON/OFF	33	1	1	-	-	2
High Voltage ON/OFF	33	1	3	-	-	4
Frame Sync Flag	33	1	5	-	-	6
Data Communications	33	1	7	-	-	8
Sample Status Flag Number 1:						
Discrete/Sweep Flag	38	1	1	-	-	-
Retrace ON/OFF	38	1	2	-	-	-
ECAL Step Number	38	1	3	-	-	5
Grating Mode	38	1	6	-	-	8
Sample Status Flag Number 2:						
Grating Memory	38	2	1	-	-	-

Grating Index	38	2	2	-	-	-
Frame Sync Code	38	2	3	-	-	-
Automated Command	38	2	4	-	-	5
Command Sequence State	38	2	6	-	-	8
* Most significant bit (MSB) = bit 1, Least significant bit (LSB) = bit 8. ** A dash indicates no change from starting value						

Table 9.7.1.4-17. Byte/bit Breakdown of Discrete/Sweep Data.						
Data Item	Starting			Ending**		
	Word	Byte	Bit*	Word	Byte	Bit
Sample Status Flag Number 3:						
Master Power On/Off	38	3	1	-	-	-
Calibration Lamp Timer	38	3	2	-	-	-
Calibration Lamp Position	38	3	3	-	-	4
Diffuser Timer	38	3	5	-	-	-
Diffuser Position	38	3	6	-	-	8
Sample Status Flag Number 4:						
Code Address	38	4	1	-	-	2
Code Data Bits 1 through 6	38	4	3	-	-	8
* Most significant bit (MSB) = bit 1, Least significant bit (LSB) = bit 8. ** A dash indicates no change from starting value.						

Table 9.7.1.4-18. Byte/bit Breakdown of Sweep Data.						
Data Item	Starting			Ending**		
	Word	Byte	Bit*	Word	Byte	Bit
CCR and Monochromator Overrange Flags:						
Spare	39	1	1	-	-	-

CCR Overrange Flag	39	1	2	-	-	-
Monochromator Overrange Flag for Sample 10	39	1	3	-	-	-
One Bit Monochromator Overrange (Flags for Sample 9 through Sample 1)	39	1	4	-	2	4
Monochromator Range for ID:						
Monochromator Range for ID for Sample 10	39	2	5	-	-	6
Two bit Monochromator Range ID for Samples 9 through Sample 1	39	2	7	-	4	8
Monochromator Grating Position:						
Grating Position	40	1	1	-	2	5
Segment Being Read	40	2	6	-	-	7
Digital Lock	40	2	8	-	-	-
* Most significant bit (MSB) = bit 1, Least significant bit (LSB) = bit 8. ** A dash indicates no change from starting value.						

Table 9.7.1.4-19. SBUV/2 Orbital Statistical Record..				
	Byte 1	Byte 2	Byte 3	Byte 4
Word	Description			
1	Record ID			
2-15	Same as words 2-15 of SBUV/2 Orbital Record Header			
16	Number of Discrete Records			
17	Number of Discrete Records with Master Power Off			
18	Number of Discrete Records with High Voltage Off			
19	Number of Discrete Records with Bad Tip Data Quality/Frame Sync Flag Set			
20	Number of Discrete Records with Data Contaminated by Automated Command Sequence			
21	Number of Discrete Records in Earth Scene Mode			

22	Number of Discrete Records in Sun Scene Mode	
23	Number of Discrete Records in Direct Hg Lamp Scene Mode	
24	Number of Discrete Records in Indirect Hg Lamp Scene Mode	
25	Number of Discrete Records in Mixed/Contaminated Scene Modes	
26	Number of Discrete Records with Diffuser Decontamination Data	
27	Number of Discrete Records with Non-Standard Wavelengths	
28	Number of Discrete Records in Discrete Grating Mode	
29	Number of Discrete Records in Wavelength Calibration Mode	
30	Number of Discrete Records in Position Mode	
31	Number of Discrete Records with Grating Mode Indeterminate	
Sweep Record Counters		
32-45	Same as words 16 to 28 and word 31, but for sweep records.	
46-55	Spare	
Digital A Analog Housekeeping Orbital Summary		
56	Orbital Average of Digital A Analog Housekeeping Channel 1A	Orbital Average of Digital A Analog Housekeeping Channel 1B
57-71	Same as word 56 but contains Channels 2A/2B through 16A/16B	
72-87	Same as words 56 to 71 but contains orbital maxima	
88-103	Same as words 56 to 71 but contains orbital minima	
104-119	Same as words 56 to 71 but contains orbital standard deviations	
120-135	Same as words 56 to 71 but contains number of data samples for each housekeeping channel in orbit	
Analog Telemetry Orbital Summary		
136	Orbital Average of Analog Telemetry # 1	Orbital Average of Analog Telemetry Point #2
137-144	Same as word 136 for Points #3 through 17	
144	Orbital Average of Analog Telemetry # 17	Spare

145-153	Same as words 136 through 144 but for orbital maxima
154-162	Same as words 136 through 144 but for orbital minima
163-171	Same as words 136 though 144 but for orbital standard deviations
172-180	Same as words 136 through 144 but contains number of data samples for each point number in orbit.
Note: For scaling factors, see Section 9.7.1.5	

Table 9.7.1.4-20. SBUV/2 Daily Statistical Record.				
	Byte 1	Byte 2	Byte 3	Byte 4
Word	Description			
1	Record ID			
2	SBUV/2 day number			
3	SBUV/2 start orbit number of day			
4	SBUV/2 end orbit number of day			
5	Year of first Major Frame in first SBUV/2 orbit of day			
6	Day of first Major Frame in First SBUV/2 orbit of day			
7	Seconds of day at start of first Major Frame in first SBUV/2 orbit of day			
8	Year of last Major Frame in last SBUV/2 orbit of day			
9	Day of last Major Frame in last SBUV/2 orbit of day			
10	Seconds of day at start of last Major Frame in last SBUV/2 orbit of day			
11-15	Spare			
16-180	Same as SBUV/2 orbital statistical record except for day instead of orbit			

9.7.1.5 Housekeeping Data Ranges and Conversions

The SBUV/2 instrument provides a variety of housekeeping data to monitor the health of the instrument itself. These data are contained in the Digital A Subcom Analog Housekeeping and the Analog Telemetry. On the 1b Data Set these data are stored in the individual data records as raw counts. However, in the orbital and daily statistics records these data have been converted to

engineering units. For discrete data, there are two sets (of 16 seconds each) of Digital A (Subcom) Analog Housekeeping data and two sets of Analog Housekeeping data for each major frame (one record). For sweep data, where one major frame requires 2 data records, both Digital A Subcom and Analog Telemetry data are present for each 16 second interval (i.e. each data record).

Tables 9.7.1.5-1 and 9.7.1.5-2 on the following pages contain the housekeeping data ranges, counts to engineering units conversion methods and, for orbital and daily statistics, the scaling factors of the stored data (e.g., a stored value of 4316 with a scaling factor of 10^2 is really 43.16). The source of this information is the TIROS-N Unique Instrument Interface for SBUV/2. Data ranges are not used in computing orbital and daily statistics (i.e. no data are excluded).

Three conversion methods are used to go from raw counts to Engineering Units (E.U.), depending on the type of housekeeping data:

1. Linear interpolation

$$E.U. = (A \times counts) + B$$

where A and B are given in Table 9.7.1.5-1 or 9.7.1.5-2.

2. SPTEMP: Convert single point temperature to degrees Centigrade using cubic spline interpolation.
 - a. Convert count to voltage in volts.
 - b. Select appropriate temperature-voltage curve for interpolation
 - c. Select closest four points on given curve for interpolation
 - d. Perform cubic spline interpolation/extrapolation
3. DFTEMP: convert differential count to differential temperature.
 - a. Compute Thermistor A count from differential count and reference count
 - b. Obtain Thermistor A temperature in degrees Centigrade (use SPTEMP)
 - c. Compute differential temperature from Thermistor A temperature and reference temperature.

Table 9.7.1.5-1. Digital A Subcom Housing Channels.				
Range*				
Channel Function	Counts	Engineering Units	Conversion Method	Statistical Record Scaling Factor

1A Chopper Motor Current	0-255	0-0.15A	A = .002 N	10 ⁴
1B Spare	spare	spare	A = .002 N	1.0
2A Diffuser Motor Current	0-255	0-1.02 A	A=.004 N	10 ⁴
2B Diffuser Plate Temp.	0-255	0-80° C	SPTEMP	10 ²
3A HVPS volts	0-255	0-1530	V=6 N	10 ¹
3B Baseplate Temp.	0-255	-15 to 45° C	SPTEMP	10 ²
4A Thermistor Bias (+10V REF)	135-165	9-11 V	V=.0667 N	10 ³
4B +25V Power-Volts	113-139	22.5-27.5 V	V=.198 N	10 ²
5A Cal Lamp Temp.	0-255	0-80° C	SPTEMP	10 ²
5B +15V Servo-Volts	135-165	13.5-16.5 V	V=.1 N	10 ³
6A ECAL Ref. Voltage	145-175	5.8-7 V	V=.04 N	10 ³
6B -15V Servo-Volts	147-153	-16.5 to -13.5	V=.5076 N-91.4	10 ³
7A +15V Sensors-Volts	135-165	13.5-16.5 V	V=.1 N	10 ³
7B CCR Diode Temp.	0-255	-5 to 35° C	SPTEMP	10 ²
8A -15V Sensors-Volts	147-153	-16.5 to -13.5	V=.5076 N-91.4	10 ³
8B SM differential Temp. Y	0-255	-5 to 5° C	DFTEMP	10 ³
9A +24V Motor-Volts	95-147	19 to 29 V	V=.198 N	10 ³
9B SM Differential Temp. Z	0-255	-5 to 5° C	DFTEMP	10 ²
10A +5V LED-Volts	120-180	4-6 V	V=.0333 N	10 ³
10B Differential Ref. Temp Z	57-179	-15 to 45° C	SPTEMP	10 ²
11A +10V Logic-Volts	135-165	9-11 V	V=. 0667 N	10 ³

11B Differential Ref. Temp Y	57-179	-15 to 45° C	SPTEMP	10 ²
12A CAL Lamp Current	0-255	0-1331.1 μ A	A=5.22X10 ⁻⁶ N	10 ⁸
12B PMT Cathode Temp.	0-255	-5 to 35° C	SPTEMP	10 ²
13A Spare	spare	spare	--	1.0
13B Spare	spare	spare	--	1.0
14A Grating Coarse Error(1)	0-255	24 to -25 steps	Step=-.1935 N+24	10 ³
14B Chopper Phase Error	0-255	0-25.12 V	V=.0985 N	10 ³
15A Grating Motor Current(1)	0-255	.73 to -.392 A	A=-.0044 N+.73	10 ⁴
15B Spare	spare	spare	SPTEMP	1.0
16A Lamp Motor Current	0-255	0-1.02 A	A=.004 N	10 ⁴
16B Spare	spare	spare	SPTEMP	1.0
<p>Notes: °C = degrees Centigrade, A = Amperes, V = Volts, μA = microamperes, N = Actual count * Ranges are normal ranges for voltages. For other items, these are maximum ranges. (1) Grating Coarse Error and Grating Motor Current are expected to read 0 to 10 counts for Flight Model #1. These telemetry points were grounded out before launch.</p>				

Table 9.7.1.5-2. Analog Telemetry Points.				
Range*				
Channel Function	Counts	Engineering Units	Conversion Method	Statistical Record Scaling Factor
1 SM Baseplate Temp. #2 (1)	0-255	-15 to 45° C	SPTEMP	100
2 SM Shroud Temp.	0-255	-30 to 80° C	SPTEMP	100

3 Depolarizer Housing Temp.	0-255	-15 to 45° C	SPTEMP	100
4 HVPS Temp.	0-255	-15 to 45° C	SPTEMP	100
5 Diffuser Plate Temp #2(1)	0-255	0 to 80° C	SPTEMP	100
6 Chopper Motor Temp.	0-255	-15 to 45° C	SPTEMP	100
7 Grating Motor Temp.	0-255	-15 to 45° C	SPTEMP	100
8 Diffuser Motor Temp	0-255	-15 to 45° C	SPTEMP	100
9 Cal Lamp Motor Temp.	0-255	-15 to 45° C	SPTEMP	100
10 Electrometer Temp.	0-255	-15 to 45° C	SPTEMP	100
11 Cal Lamp Power Supply Temp.	0-255	-15 to 45° C	SPTEMP	100
12 Diffuser Radiator Temp.	0-255	-15 to 45° C	SPTEMP	100
13 ELM Temp.	0-255	-15 to 45° C	SPTEMP	100
14 LVPS Temp.	0-255	-15 to 45° C	SPTEMP	100
15 Diffuser Heater Current	0-255	0-.459 A	A=.0018 N	10 ⁴
16 Baseplate Heater Current	0-255	0-.459 A	A=.0018 N	10 ⁴
17 28 V Main Power	120-160	24-32 V	V=.2 N	100
<p>Notes: °C = degrees Centigrade, A = Amperes, V = Volts, N = Actual Count * Ranges are normal ranges for voltages. For other items, these are maximum ranges. (1) Powered from the 28 V Analog TM BUS</p>				

9.7.2 PRODUCT MASTER FILE

9.7.2.1 Overview

The Product Master File (PMF) contains the ozone information derived by the ozone algorithm, located in space and time, other meteorological information developed in support of the ozone computation, parameters indicating the validity of the individual ozone retrievals and the radiance information derived from the SBUV/2 measurements.

9.7.2.2 Data Organization

The operational monthly PMF contains one month of data comprised of whole orbits (delimited by night time equator crossing). The last orbit in the file may contain some data from the next day. The information on the file is grouped logically by orbit and by scan. Header and summary information is provided for each orbital group of scan by scan ozone data as well as daily summary information. The orbital group contains the OOPS Standard Header, ancillary data and instrument calibration data.

Figure 9.7.2.2-1 and Table 9.7.2.2-1 provide detailed descriptions of the arrangement of records on the PMF monthly operational file. Each daily record consists of the OOPS standard headers and the daily PMF records. The daily group indicated in the table is repeated for each day of the month. The file has a Logical Record Length (LRECL) of 828 bytes and is blocked at 16560 bytes (20 records). The SBUV/2 algorithm used prior to 2007 was called Version 6. Beginning in 2007, a revised SBUV/2 algorithm was implemented, called Version 8. For a detailed description of the Version 8 algorithm, refer to the Algorithm Theoretical Basis Document located

at ftp://www.orbit.nesdis.noaa.gov/pub/smcd/spb/ozone/docs/SBUV2_V8_ATBD_020207.pdf. At that time, the Version 6 monthly PMF file described here became solely an intermediate file, not for distribution. Users were provided only with daily PMFs. The format for Version 8 daily files is shown in Table 9.7.2.2-9 through 9.7.2.2-12. Since the Version 6 product is an intermediate step in the production of the Version 8 product, users can note the full original Version 6 data record is reproduced at the end of the Version 8 records, in words 1794-2000.

The archive original PMF (Version 6, available for years prior to 2007), available through CLASS, consists of daily files with only PMF data records (see Table 9.7.2.2-5). All other record types have been removed. The daily files are tarred together at the end of the month and available through CLASS on the second day of the next month. For Version 8, the archive format is exactly like the daily operational binary file format. Each daily file has two header records (Tables 9.7.2.2-9 and 9.7.2.2-10), followed by a variable number of data records (Table 9.7.2.2-11), ending with a trailer record (Table 9.7.2.2-12).

Table 9.7.2.2-2 and Table 9.7.2.2-3 lists the pressure layers and levels at which the ozone data is reported. With Version 8, there are 21 layers, instead of 12. In atmospheres, the Layer bottoms are: 1.0, 0.631, 0.398, 0.251, 0.158, 0.100, 0.0631, 0.040, 0.0251, 0.0158, 0.0100, 0.0063, 0.0040, 0.00251, 0.00158, 0.0010, 0.00063, 0.00040, 0.00025, 0.000158, and 0.0001, with top layer extending to infinity.

The PMF is also available in BUFR format (a WMO International format for observed data.).

See Table 9.7.2.2-8 for the PMF BUFR words (Version 6) and Table 9.7.2.2-13 for Version 8. Not all words are included in the Version 8 BUFR files. Including only a subset of words, with modified units, allowed the product to be created in a World Meteorological Organization (WMO) compatible format. Reading the BUFR files requires an input BUFR table that describes the layout of the BUFR subsets. These subsets are combined into BUFR messages of up to 10,000 bytes. Table 9.7.2.2-13 contains the BUFR input table, made up of three sections: Table A, Table B, and Table D.

Table 9.7.2.2-1. PMF Record Layout for Day. (Version 6)	
Record Type	# of Records
OOPS Standard Headers I & II <ul style="list-style-type: none"> ○ Product Master File ○ Daily 1b Data Set 	2
Orbital Header Record	1
Data Records	100 (Nominal)
Repeat last three items each orbit of day	1400 (Nominal)

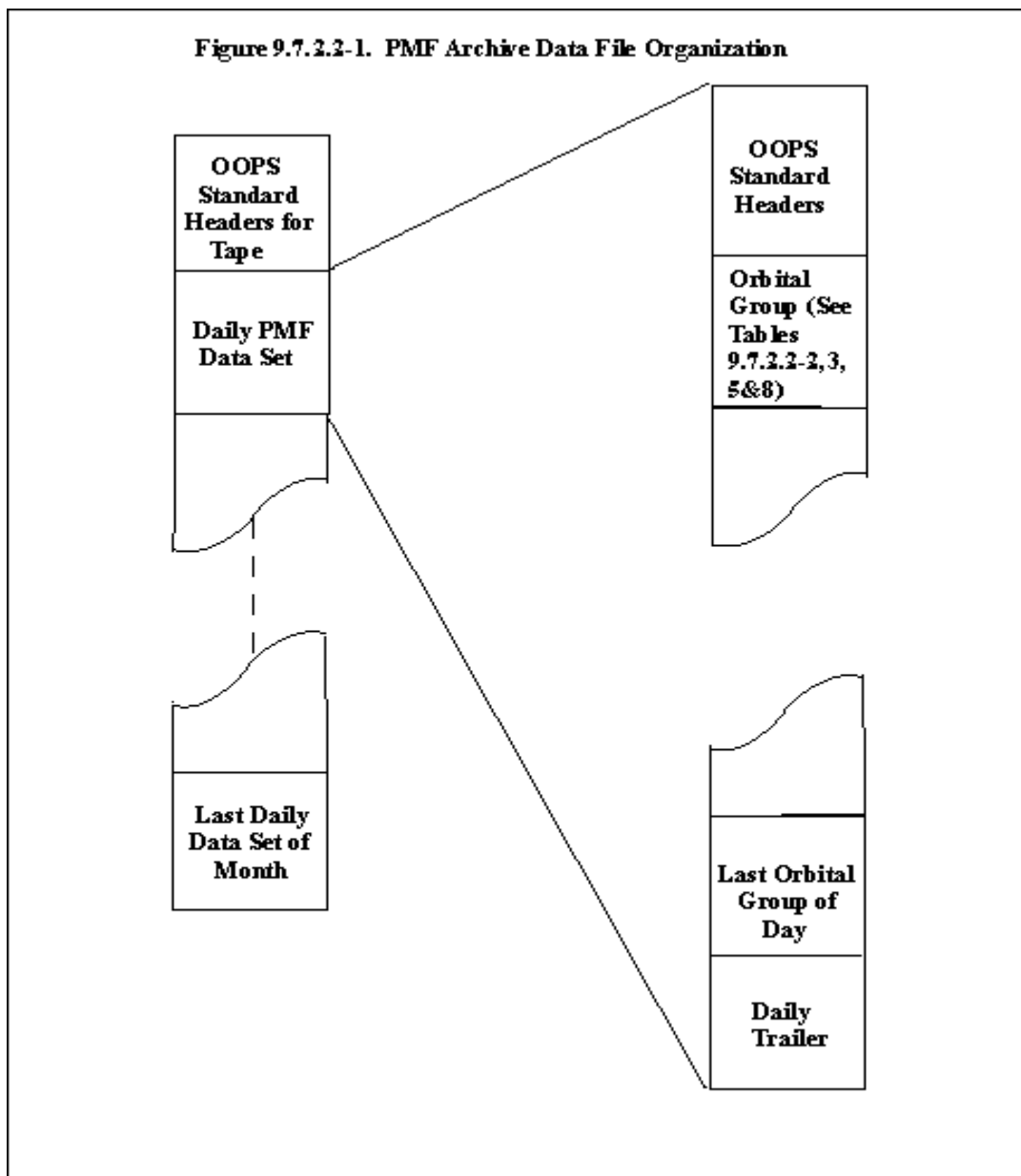

Figure 9.7.2.2-1. PMF Archive Tape Data Set Organization

Table 9.7.2.2-2. Ozone Pressure Levels.

Kilometers	Feet	Miles	Pressure	Level	Layer
63.5	209000	39.6	0.12		-----
					12
58.5	192000	36.4	0.25		-----
57.0	187500	35.5	0.30	1	11
55.0	180500	34.2	0.40	2	
53.5	175000	33.1	0.49		-----
53.0	174500	33.0	0.50	3	10
51.5	166000	31.4	0.70	4	
48.0	157000	29.7	0.99		-----
47.8	156500	29.6	1.00	5	9
44.6	146500	27.7	1.50	6	
42.4	139500	26.4	1.98		-----
42.6	139000	26.3	2.00	7	8
39.4	129500	24.5	3.00	8	
37.4	123000	23.3	3.96		-----
37.2	122500	23.2	4.00	9	
35.6	117500	22.2	5.00	10	7
33.4	110000	20.8	7.00	11	
32.6	107000	20.3	7.92		-----
31.0	101800	19.3	10.00	12	6
28.4	93000	17.6	15.00	13	
28.0	91800	17.4	15.83		-----
26.5	86800	16.4	20.00	14	5

23.8	78200	14.8	30.00	15	
23.5	77200	14.6	31.66		-----
22.0	72200	13.7	40.00	16	4
20.6	67400	12.8	50.00	17	
19.1	62600	11.9	63.33		-----
18.4	60400	11.4	70.00	18	3
16.1	53000	10.0	100.00	19	
14.7	48200	9.1	126.66		-----
13.6	44600	8.5	150.00		2
11.8	38600	7.3	200.00		
10.3	33700	6.4	253.31		-----
9.2	30000	5.7	300.00		
7.2	23500	4.6	400.00		
5.6	18200	3.5	500.00		
4.2	13800	2.6	600.00		
3.0	9900	1.9	700.00		1
2.0	6400	1.2	800.00		
1.5	4800	0.9	850.00		
1.0	3200	0.6	900.00		
.1	400	0.1	1000.00		
0.0	0	0.0	1013.25		-----

Table 9.7.2.2-3. Ozone Pressure Layers (Version 6) and Levels

PMF Word (V6)	UMKEHR	Pressure (Atm)	Pressure (mb)
132	12	.0002-.0001	0.25 - 0.12
133	11	.0005-.0002	0.49 – 0.25
134	10	.0010-.0005	0.99 – 0.49
135	9	.0020-.0010	1.98 – 0.99
136	8	.0039-.0020	3.96 – 1.98
137	7	.0078-.0039	7.92 – 3.96
138	6	.0156-.0078	15.83 - 7.92
139	5	.0313-.0156	31.66 - 15.83
140	4	.0625-.0313	63.33 - 31.66
141	3	.1250-.0625	126.66 - 63.33
142	2	.2500-.1250	253.31- 126.66
143	1	1.0000-.2500	1013.25 – 253.31
Levels			
PMF Word (V6)	Level (mb)	PMF Word (V6)	Level (mb)
160	0.3	169	5.0
161	0.4	170	7.0
162	0.5	171	10.0
163	0.7	172	15.0
164	1.0	173	20.0
165	1.5	174	30.0
166	2.0	175	40.0
167	3.0	176	50.0
168	4.0	177	70.0

-	-	178	100.0
Version 8 Layers			
PMF Word (V8)	Layer Number	Pressure (ATM)	Pressure (mb)
163	21	.0001 – top of atmo	< .1
162	20	.000158-.0001	.16-.1
161	19	.00025-.000158	.25-.16
160	18	.00040-.00025	.41-.25
159	17	.00063-.00040	.64-.41
158	16	.0010-.00063	1.0-.64
157	15	.00158-.0010	1.6-1.0
156	14	.00251-.00158	2.5-1.6
155	13	.0040-.00251	4-2.5
154	12	.0063-.0040	6-4
153	11	.010-.0063	10-6
152	10	.0158-.010	16-10
151	9	.0251-.0158	25-16
150	8	.040-.0251	41-25
149	7	.0631-.040	64-41
148	6	.10-.0631	101-64
147	5	.158-.10	160-101
146	4	.251-.158	255-160
145	3	.398-.251	404-255
144	2	.631-.398	640-404
143	1	1.0-.631	1013-640

Table 9.7.2.2-4. PMF Orbital Header Record. (Version 6)				
	Byte 1	Byte 2	Byte 3	Byte 4
Word	Description			
1	Record ID (Integer)			
2	Logical sequence number (1)			
3	SBUV/2 orbit number			
4-7	Date of job run (EBCDIC)			
8	Julian day of first good scan			
9	Seconds of day of first good scan (seconds)			
10	Year of first good scan (yyy)			
11	Subsatellite latitude of first good scan (degrees)			
12	Subsatellite longitude of first good scan (degrees)			
13	Spare (-77.0)			
14-16	Processing parameters			
17	Spare (-77.0)			
18-30	Day 1 solar irradiance			
31-67	Radiance calibration factors			
68-80	Band center wavelengths			
81-93	Effective ozone absorption coefficients			
94-106	Rayleigh scattering coefficient			
107-126	Processing options 0.0 = false, 1.0 = true			
127-207	Spare (-77.0)			

Table 9.7.2.2-5. PMF Data Record. (Version 6)				
	Byte 1	Byte 2	Byte 3	Byte 4
Word	Description			
1	Record ID (integer)			
2	Logical Sequence Number			
3	SBUV/2 Orbit Number			
4	Year at Start of Scan x 1000 + Day of Year at Start of Scan			
5	Seconds of Day			
6	Subsatellite Latitude at the Beginning of Scan (Degrees)			
7	Subsatellite Longitude at the Beginning of Scan (Degrees)			
Total - Ozone Output				
8	View Latitude - Average for Total Ozone Wavelengths (Degrees)			
9	View Longitude - Average for Total Ozone Wavelengths (Degrees)			
10	Solar Zenith Angle - Average for Total Ozone Wavelengths (Degrees)			
11-14	N-Values (CCR Coincident with 339.8, 331.2, 317.5, 312.5 nm)			
15-18	N-Values (Monochromator 339.8, 331.2, 317.5, 312.5, 305 nm)			
19	Gain Selection code for each of five wavelengths (339.8, 331.2, 317.5, 312.5, 305 nm) (Ex: Integer #33322)			
20	Grating Position Error Offsets for wavelength's 1-6.			
21	Total Ozone - Best Estimate based on TOVS Cloud Height. (m-atm-cm)			
22	FOV Average Cloud Top Pressure (atm) (Reported by TOVS)			
23	Pressure of Reflective Surface (atm) (Estimated using TOVS)			
24	Reflectivity-Average (Estimated using TOVS)			
25	Percent Cloud from CCR			
26	Ozone Error Flag for TOVS Total Ozone			
27	Total A-Pair Ozone (m-atm-cm)			

28	Ozone A-Pair sensitivity (N-Value/m-atm-cm)
29	Reflectivity average for A-Pair
30	Ozone Weight A-Pair
31	Total Ozone B-Pair (m-atm-cm)
32	Ozone Sensitivity B-Pair (N-Value/m-atm-cm)
33	Reflectivity average for B-Pair
34	Ozone Weight B-Pair
35	Total Ozone-Best Estimate Based on Climatological Cloud Height (m-atm-cm)
36	Total Ozone C-Pair (m-atm-cm)
37	Pressure of reflecting Surface (Estimated Without TOVS) (atm)
38	Reflectivity Average
39	Ozone Sensitivity C-Pair (N-Value/m-atm-cm)
40	Ozone Error Flag for Best Ozone
41	FOV Snow Flag * 10 + Table Selection Index 1=Snow 1 = Low Latitude; 0=No Snow 2 = Mid Latitude; -1=No Info. 3 = High Latitude.
42	Grating Position Error Offset for wavelength's 7-12
43	Reflectivity difference (Photometer/monochromator)
44	Terrain Surface Pressure (atm)
45	Total Ozone D-Pair (m-atm-cm)
46	SOI Index
47	Total Ozone B'-Pair (m-atm-cm)
Profile Output	
48	View latitude - Average for profile (degrees)
49	View longitude - Average for profile (degrees)
50	Solar Zenith Angle - Average for profile (degrees)

51-58	N-Values (CCR coincident with Profile wavelengths 252.2, 275.3, 283.0, 287.6, 292.2, 297.5, 301.9, and 305.8 nm)
59-66	N-Values (monochromator profile wavelengths)
67-68	Gain Selection Flags for Each of Eight Wavelengths
69-80	Layer Ozone-first Guess Amounts in 12 Pressure Layers (m-atm-cm)
81	Total Ozone for A Priori profile (m-atm-cm)
82-91	Q-Values Corrected for Multiple Scattering and Surface Reflectivity (252.2 through 317.5 nm)
92-101	Initial Residues (252.2 through 317.5 nm) (%)
102-106	Multiple-Scattering correction to Q for Five Longer Wavelengths Channels (297.5 through 317.5 nm)
107-111	Reflectivities for Five Longer Wavelengths (297.5 through 317.5 nm)
112-116	Multiple-Scattering Sensitivity for Five Longer Wavelengths (297.5 through 317.5 nm) (Q-Value/m-atm-cm)
117-121	Multiple-Scattering Mixing Fraction for Five Longer Wavelengths (297.5 through 317.5 nm)
122-131	Final Residues (252.2 through 317.5 nm) (%)
132-143	Layer Ozone Amounts for Solution Profile in 12 Pressure Layers (m-atm-cm)
144-155	Layer Ozone Standard Deviations for Solution Profile in 12 Pressure Layers (%)
156	Total Ozone for solution profile (m-atm-cm)
157	Ozone Error Flag for Profile
158-159	Upper Level Profile parameters C (m-atm-cm) and Sigma
160-178	Ozone Mixing Ratio at 19 Pressure Levels (micro gm/gm)
179-190	Layer Ozone Standard Deviations for First Guess in 12 Pressure Layers (%)
191-200	Standard Deviations of Q-Values Corrected for Multiple Scattering and Reflectivity (252.2 through 317.5 nm) (%)
201	Number of Iterations for Profile Solution
202	VCI (Volcano Contamination Index)

203	Spare (-77.0) or Solar Azimuth Angle at Field of View at start of scan (degrees)
204	Ozone Sensitivity D-Pair (N_value/m-atm-cm)
205	Ozone Sensitivity B'-Pair (N_value/m-atm-cm)
206	Solar Zenith Angle at Start of Scan (Radians x 10 ⁴)
207	Solar Zenith Angle at End of Scan (Radians x 10 ⁴)

Table 9.7.2.2-6. PMF Orbital Trailer Record. (Version 6)				
	Byte 1	Byte 2	Byte 3	Byte 4
Word	Description			
1	Record ID (Integer)			
2	Logical sequence number -(N+2); N = number of data records			
3	SBUV/2 orbit number			
4	Day of year of last good scan of orbit			
5	Seconds of day of last good scan of orbit			
6	Subsatellite latitude at the end of orbit (degrees)			
7	Subsatellite longitude at the end of orbit (degrees)			
8	View latitude - Average for total ozone on last scan (degrees)			
9	View Longitude - Average for total ozone on last scan (degrees)			
10-39	Processing counters (orbital sub-totals)			
40-207	Spares			

Table 9.7.2.2-7. PMF Daily Trailer Record. (Version 6)				
	Byte 1	Byte 2	Byte 3	Byte 4
Word	Description			
1	Record ID (Integer)			
2	Daily Trailer Identifier (-1.0)			

3	SBUV/2 Orbit Number of Last Orbit of Day
4	Day of Year of Last Scan of Day
5	Seconds of Day of Last Scan of Day
6	Subsatellite Latitude of Last Scan (Degrees)
7	Subsatellite Longitude of Last Scan (Degrees)
8-27	Processing Counters (Daily Totals)
28-207	Spares

Table 9.7.2.2-8. SBUV/2 Ozone - Product Master File (PMF) BUFR Words. (Version 6)					
Word #	Description	Units	Decimal Places	Range of Values	Fill Value
1	Record ID (Integer)	N/A	0	761	N/A
2	Logical Sequence Number	N/A	0	1 to 200	N/A
3	SBUV/2 Orbit Number	N/A	0	1 to 99999	N/A
4	Start of Scan Year	Year	0	96001 to ?????	N/A
5	Day of Year	Day	0	1 to 366	N/A
6	Hour	Hour	0	00 to 24	N/A
7	Minute	Minute	0	00 to 60	N/A
8	Second	Second	0	00 to 60	N/A
9	Subsatellite Latitude	Degrees	2	-90S to 90N	N/A
10	Subsatellite Longitude	Degrees	2	-180W to 180E	N/A
11	View Latitude Total Ozone	Degrees	2	-90S to 90N	N/A
12	View Longitude Total Ozone	Degrees	2	-180W to 180E	N/A
13	Solar Zenith Angle - Average for Total Ozone	Degrees	2	0 to 180	N/A

14	N-value CCR 339.8 nm	N/A	0	0 to 1000	-77
15	N-value CCR 331.2 nm	N/A	0	0 to 1000	-77
16	N-value CCR 317.5 nm	N/A	0	0 to 1000	-77
17	N-value CCR 312.5	N/A	0	0 to 1000	-77
18	N-value Monochromator 339.8 nm	N/A	0	0 to 1000	-77
19	N-value CCR 331.2 nm	N/A	0	0 to 1000	-77
20	N-value CCR 317.5 nm	N/A	0	0 to 1000	-77
21	N-value CCR 312.5 nm	N/A	0	0 to 1000	-77
22	Gain Selection Code for 4 Wavelengths + 305 nm	N/A	0	11111 to 33333	NA
23	Total Ozone Best Estimate TOVS Cloud Height	m-atm-cm	2	0 to 1000	-77
24	FOV Average Cloud Top Pressure	atm	2	0 to 1	-77
25	Pressure of Reflective Surface Estimating Using TOVS	atm	2	0 to 1	-77
26	Reflectivity Avg. For TOVS	N/A	2	0 to 1	-77
27	% Cloud from CCR	%	0	0 to 100	-77
28	Ozone Error Flag for TOVS Total Ozone	N/A	0	0 to 19	NA
29	Total A-pair Ozone	m-atm-cm	2	0 to 1000	-77
30	Ozone A-pair Sensitivity	1/(m-atm- cm)	2	0 to 1	-77
31	Reflectivity Average For A- pair	N/A	2	0 to 1	-77
32	Ozone Weight A-pair	N/A	2	0 to 1	-77
33	Total B-pair Ozone	m-atm-cm	2	0 to 1000	-77

34	Ozone B-Pair Sensitivity	1/(m-atm-cm)	2	0 to 1	-77
35	Reflectivity Average for B-pair	N/A	2	0 to 1	-77
36	Ozone Weight B-pair	N/A	2	0 to 1	-77
37	Total Ozone Best Estimate Based on Climatology Cloud Height	m-atm-cm	2	0 to 1000	-77
38	Total C-pair Ozone	m-atm-cm	2	0 to 1000	-77
39	Pressure of Reflective Surface Estimating Without TOVS	atm	2	0 to 1	-77
40	Reflectivity Average	N/A	2	0 to 1	-77
41	Ozone C-pair Sensitivity	1/(m-atm-cm)	2	0 to 1	-77
42	Ozone Error Flag for Best Ozone	N/A	0	0 to 19	N/A
43	Table Selection Index	N/A	0	1 to 3	N/A
44	FOV Snow Flag	N/A	0	-1 to 1	N/A
45	Reflectivity Difference (Photo/mono)	N/A	2	-10 to 10	-77
46	Terrain Surface Pressure	atm	2	0 to 1	-77
47	Total D-pair Ozone	m-atm-cm	2	0 to 1000	-77
48	Soil Index	N/A	2	-1000 to 1000	-77
49	Total B'-pair Ozone	m-atm-cm	2	0 to 1000	-77
50	View Latitude Profile Ozone	Degrees	2	-90S to 90N	N/A
51	View Longitude Profile Ozone	Degrees	2	-180W to 180E	N/A
52	Solar Zenith Angle - Average for Profile Ozone	Degrees	2	0 to 180	N/A

53	N-value CCR 252.2 nm	N/A	0	0 to 1000	-77
54	N-value CCR 275.3 nm	N/A	0	0 to 1000	-77
55	N-value CCR 283.0 nm	N/A	0	0 to 1000	-77
56	N-value CCR 287.6 nm	N/A	0	0 to 1000	-77
57	N-value CCR 292.2 nm	N/A	0	0 to 1000	-77
58	N-value CCR 297.5 nm	N/A	0	0 to 1000	-77
59	N-value CCR 301.9 nm	N/A	0	0 to 1000	-77
60	N-value CCR 305.8 nm	N/A	0	0 to 1000	-77
61	N-value Monochromator 252.2 nm	N/A	0	0 to 1000	-77
62	N-value Monochromator 275.3 nm	N/A	0	0 to 1000	-77
63	N-value Monochromator 283.0 nm	N/A	0	0 to 1000	-77
64	N-value Monochromator 287.6 nm	N/A	0	0 to 1000	-77
65	N-value Monochromator 292.2 nm	N/A	0	0 to 1000	-77
66	N-value Monochromator 297.5 nm	N/A	0	0 to 1000	-77
67	N-value Monochromator 301.9 nm	N/A	0	0 to 1000	-77
68	N-value Monochromator 305.8 nm	N/A	0	0 to 1000	-77
69	Gain Selection Code for First 4 Wavelengths	N/A	0	1111 to 3333	N/A
70	Gain Selection Code for Last 4 Wavelengths	N/A	0	1111 to 3333	N/A
71	First Guess Layer Ozone 12 .25-.12 mb	m-atm-cm	2	0 to 500	-77

72	First Guess Layer Ozone 11 .5-.25 mb	m-atm-cm	2	0 to 500	-77
73	First Guess Layer Ozone 10 1-.5 mb	m-atm-cm	2	0 to 500	-77
74	First Guess Layer Ozone 9 2-1 mb	m-atm-cm	2	0 to 500	-77
75	First Guess Layer Ozone 8 4-2 mb	m-atm-cm	2	0 to 500	-77
76	First Guess Layer Ozone 7 8-4 mb	m-atm-cm	2	0 to 500	-77
77	First Guess Layer Ozone 6 16-8 mb	m-atm-cm	2	0 to 500	-77
78	First Guess Layer Ozone 5 32-16 mb	m-atm-cm	2	0 to 500	-77
79	First Guess Layer Ozone 4 64-32 mb	m-atm-cm	2	0 to 500	-77
80	First Guess Layer Ozone 3 127-64 mb	m-atm-cm	2	0 to 500	-77
81	First Guess Layer Ozone 2 250-127 mb	m-atm-cm	2	0 to 500	-77
82	First Guess Layer Ozone 1 1013-250 mb	m-atm-cm	2	0 to 500	-77
83	Total Ozone for A-priori Profile	m-atm-cm	2	0 to 1000	-77
84	Q-Values Corrected for Multiple-scattering and Reflectivity. 252.2 nm	N/A	2	0 to 100000	-77
85	Q-values Corrected for Multi- scat. and Reflect. 275.3 nm	N/A	2	0 to 100000	-77
86	Q-values Corrected for Multi- scat. and Reflect. 283.0 nm	N/A	2	0 to 100000	-77

87	Q-values Corrected for Multi-scat. and Reflect. 287.6 nm	N/A	2	0 to 100000	-77
88	Q-values Corrected for Multi-scat. and Reflect. 292.2 nm	N/A	2	0 to 100000	-77
89	Q-values Corrected for Multi-scat. and Reflect. 297.5 nm	N/A	2	0 to 100000	-77
90	Q-values Corrected for Multi-scat. and Reflect. 301.9 nm	N/A	2	0 to 100000	-77
91	Q-values Corrected for Multi-scat. and Reflect. 305.8 nm	N/A	2	0 to 100000	-77
92	Q-values Corrected for Multi-scat. and Reflect. 312.5 nm	N/A	2	0 to 100000	-77
93	Q-values Corrected for Multi-scat. and Reflect. 317.5 nm	N/A	2	0 to 100000	-77
94	Initial Residue 252.2 nm	%	0	0 to 100	-77
95	Initial Residue 275.3 nm	%	0	0 to 100	-77
96	Initial Residue 283.0 nm	%	0	0 to 100	-77
97	Initial Residue 287.6 nm	%	0	0 to 100	-77
98	Initial Residue 292.2 nm	%	0	0 to 100	-77
99	Initial Residue 297.5 nm	%	0	0 to 100	-77
100	Initial Residue 301.9 nm	%	0	0 to 100	-77
101	Initial Residue 305.8 nm	%	0	0 to 100	-77
102	Initial Residue 312.5 nm	%	0	0 to 100	-77
103	Initial Residue 317.5 nm	%	0	0 to 100	-77
104	Multiple Scattering Correction to Q 297.5 nm	N/A	2	0 to 1	-77
105	Multiple Scattering Correction to Q 301.9 nm	N/A	2	0 to 1	-77
106	Multiple Scattering Correction to Q 305.8 nm	N/A	2	0 to 1	-77

107	Multiple Scattering Correction to Q 312.5 nm	N/A	2	0 to 1	-77
108	Multiple Scattering Correction to Q 317.5 nm	N/A	2	0 to 1	-77
109	Reflectivities 297.5 nm	N/A	2	0 to 1	-77
110	Reflectivities 301.9 nm	N/A	2	0 to 1	-77
111	Reflectivities 305.8 nm	N/A	2	0 to 1	-77
112	Reflectivities 312.5 nm	N/A	2	0 to 1	-77
113	Reflectivities 317.5 nm	N/A	2	0 to 1	-77
114	Multiple Scattering Sensitivity 297.5 nm	1/(m-atm-cm)	2	0 to 1	-77
115	Multiple Scattering Sensitivity 301.9 nm	1/(m-atm-cm)	2	0 to 1	-77
116	Multiple Scattering Sensitivity 305.8 nm	1/(m-atm-cm)	2	0 to 1	-77
117	Multiple Scattering Sensitivity 312.5 nm	1/(m-atm-cm)	2	0 to 1	-77
118	Multiple Scattering Sensitivity 317.5 nm	1/(m-atm-cm)	2	0 to 1	-77
119	Multiple Scattering Mixing Fraction 297.5 nm	N/A	2	0 to 100	-77
120	Multiple Scattering Mixing Fraction 301.9 nm	N/A	2	0 to 100	-77
121	Multiple Scattering Mixing Fraction 305.8 nm	N/A	2	0 to 100	-77
122	Multiple Scattering Mixing Fraction 312.5 nm	N/A	2	0 to 100	-77
123	Multiple Scattering Mixing Fraction 317.5 nm	N/A	2	0 to 100	-77
124	Final Residues 252.2 nm	%	0	0 to 100	-77

125	Final Residues 275.3 nm	%	0	0 to 100	-77
126	Final Residues 283.0 nm	%	0	0 to 100	-77
127	Final Residues 287.6 nm	%	0	0 to 100	-77
128	Final Residues 292.2 nm	%	0	0 to 100	-77
129	Final Residues 297.5 nm	%	0	0 to 100	-77
130	Final Residues 301.9 nm	%	0	0 to 100	-77
131	Final Residues 305.8 nm	%	0	0 to 100	-77
132	Final Residues 312.5 nm	%	0	0 to 100	-77
133	Final Residues 317.5 nm	%	0	0 to 100	-77
134	Solution Profile Layer Ozone 12 .25-.12 mb	m-atm-cm	2	0 to 500	-77
135	Solution Profile Layer Ozone 11 .5-.25 mb	m-atm-cm	2	0 to 500	-77
136	Solution Profile Layer Ozone 10 1-.5 mb	m-atm-cm	2	0 to 500	-77
137	Solution Profile Layer Ozone 9 2-1 mb	m-atm-cm	2	0 to 500	-77
138	Solution Profile Layer 8 4-2 mb	m-atm-cm	2	0 to 500	-77
139	Solution Profile Layer Ozone 7 8-4 mb	m-atm-cm	2	0 to 500	-77
140	Solution Profile Layer Ozone 6 16-8 mb	m-atm-cm	2	0 to 500	-77
141	Solution Profile Layer Ozone 5 32-16 mb	m-atm-cm	2	0 to 500	-77
142	Solution Profile Layer Ozone 4 64-32 mb	m-atm-cm	2	0 to 500	-77
143	Solution Profile Layer Ozone 3 127-64 mb	m-atm-cm	2	0 to 500	-77

144	Solution Profile Layer Ozone 2 250-127 mb	m-atm-cm	2	0 to 500	-77
145	Solution Profile Layer Ozone 1 1013-250 mb	m-atm-cm	2	0 to 500	-77
146	Solution Profile Standard Deviation Layer Ozone 12 .25-.12 mb	%	0	0 to 100	-77
147	Solution Profile Standard Deviation Layer Ozone 11 .5-.25 mb	%	0	0 to 100	-77
148	Solution Profile Standard Deviation Layer Ozone 10 1-.5 mb	%	0	0 to 100	-77
149	Solution Profile Standard Deviation Layer Ozone 9 2-1 mb	%	0	0 to 100	-77
150	Solution Profile Standard Deviation Layer Ozone 8 4-2 mb	%	0	0 to 100	-77
151	Solution Profile Standard Deviation Layer Ozone 7 8-4 mb	%	0	0 to 100	-77
152	Solution Profile Standard Deviation Layer Ozone 6 16-8 mb	%	0	0 to 100	-77
153	Solution Profile Standard Deviation Layer Ozone 5 32-16 mb	%	0	0 to 100	-77
154	Solution Profile Standard Deviation Layer Ozone 4 64-32 mb	%	0	0 to 100	-77
155	Solution Profile Standard Deviation Layer Ozone 3 127-64 mb	%	0	0 to 100	-77

156	Solution Profile Standard Deviation Layer Ozone 2 250-127 mb	%	0	0 to 100	-77
157	Solution Profile Standard Deviation Layer Ozone 1 1013-250 mb	%	0	0 to 100	-77
158	Total Ozone for Solution Profile	m-atm-cm	2	0 to 1000	-77
159	Ozone Error Flag for Profile	N/A	0	0 to 9	N/A
160	Upper Level Profile Parameter C	m-atm-cm	2	0 to 1000	-77
161	Upper Level Profile Parameter Sigma	m-atm-cm	2	0 to 1000	-77
162	Ozone Mixing Ratio Level 1 .3 mb	micro-grams /gram	2	0 to 50	-77
163	Ozone Mixing Ratio Level 2 .4 mb	micro-grams /gram	2	0 to 50	-77
164	Ozone Mixing Ratio Level 3 .5 mb	micro-grams /gram	2	0 to 50	-77
165	Ozone Mixing Ratio Level 4 .7 mb	micro-grams /gram	2	0 to 50	-77
166	Ozone Mixing Ratio Level 5 1.0 mb	micro-grams /gram	2	0 to 50	-77
167	Ozone Mixing Ratio Level 6 1.5 mb	micro-grams /gram	2	0 to 50	-77
168	Ozone Mixing Ratio Level 7 2.0 mb	micro-grams /gram	2	0 to 50	-77

169	Ozone Mixing Ratio Level 8 3.0 mb	micro-grams /gram	2	0 to 50	-77
170	Ozone Mixing Ratio Level 9 4.0 mb	micro-grams /gram	2	0 to 50	-77
171	Ozone Mixing Ratio Level 10 5.0 mb	micro-grams /gram	2	0 to 50	-77
172	Ozone Mixing Ratio Level 11 7.0 mb	micro-grams /gram	2	0 to 50	-77
173	Ozone Mixing Ratio Level 12 10.0 mb	micro-grams /gram	2	0 to 50	-77
174	Ozone Mixing Ratio Level 13 15.0 mb	micro-grams /gram	2	0 to 50	-77
175	Ozone Mixing Ratio Level 14 20.0 mb	micro-grams /gram	2	0 to 50	-77
176	Ozone Mixing Ratio Level 15 30.0 mb	micro-grams /gram	2	0 to 50	-77
177	Ozone Mixing Ratio Level 16 40.0 mb	micro-grams /gram	2	0 to 50	-77
178	Ozone Mixing Ratio Level 17 50.0 mb	micro-grams /gram	2	0 to 50	-77
179	Ozone Mixing Ratio Level 18 70.0 mb	micro-grams /gram	2	0 to 50	-77

180	Ozone Mixing Ratio Level 19 100.0 mb	micro-grams /gram	2	0 to 50	-77
181	Layer Ozone Standard Deviations for 1st Guess Layer 12	%	0	0 to 100	-77
182	Layer Ozone Standard Deviations for 1st Guess Layer 11	%	0	0 to 100	-77
183	Layer Ozone Standard Deviations for 1st Guess Layer 10	%	0	0 to 100	-77
184	Layer Ozone Standard Deviations for 1st Guess Layer 9	%	0	0 to 100	-77
185	Layer Ozone Standard Deviations for 1st Guess Layer 8	%	0	0 to 100	-77
186	Layer Ozone Standard Deviations for 1st Guess Layer 7	%	0	0 to 100	-77
187	Layer Ozone Standard Deviations for 1st Guess Layer 6	%	0	0 to 100	-77
188	Layer Ozone Standard Deviations for 1st Guess Layer 5	%	0	0 to 100	-77
189	Layer Ozone Standard Deviations for 1st Guess Layer 4	%	0	0 to 100	-77
190	Layer Ozone Standard Deviations for 1st Guess Layer 3	%	0	0 to 100	-77

191	Layer Ozone Standard Deviations for 1st Guess Layer 2	%	0	0 to 100	-77
192	Layer Ozone Standard Deviations for 1st Guess Layer 1	%	0	0 to 100	-77
193	Standard Deviation of Q-values Corrected for Multiple Scattering and Reflectivity 252.2 nm	%	0	0 to 100	-77
194	Standard Deviation of Q-values Corrected for Multiple Scattering and Reflectivity 275.3 nm	%	0	0 to 100	-77
195	Standard Deviation of Q-values Corrected for Multiple Scattering and Reflectivity 283.0 nm	%	0	0 to 100	-77
196	Standard Deviation of Q-values Corrected for Multiple Scattering and Reflectivity 287.6 nm	%	0	0 to 100	-77
197	Standard Deviation of Q-values Corrected for Multiple Scattering and Reflectivity 292.2 nm	%	0	0 to 100	-77
198	Standard Deviation of Q-values Corrected for Multiple Scattering and Reflectivity 297.5 nm	%	0	0 to 100	-77
199	Standard Deviation of Q-values Corrected for Multiple Scattering and Reflectivity 301.9 nm	%	0	0 to 100	-77

200	Standard Dev. of Q-values Corrected for Multiple Scattering and Reflectivity 305.8 nm	%	0	0 to 100	-77
201	Standard Dev. of Q-values Corrected for Multiple Scattering and Reflectivity 312.5 nm	%	0	0 to 100	-77
202	Standard Deviation of Q-values Corrected for Multiple Scattering and Reflectivity 317.5 nm	%	0	0 to 100	-77
203	Number of Iterations for Profile Solution	N/A	0	0 to 1000	-77
204	Volcano Contamination Index	N/A	2	-10 to 20	-77
205	Solar Azimuth Angle at FOV at Start of Scan	Degrees	2	-180 to 180	-77
206	Ozone Sensitivity D-pair	1/(m-atm-cm)	2	0 to 1	-77
207	Ozone Sensitivity B'-pair	1/(m-atm-cm)	2	0 to 1	-77
208	Solar Zenith Angle at Start of Scan	Radians	4	0 to 30000	-77
209	Solar Zenith Angle at End of Scan	Radians	4	0 to 30000	-77

Table 9.7.2.2-9 Version 8 Header Record I Layout

Byte	Description	Sample
1-5	Spare	
6-13	Satellite name and flight model identifier	'SBUV-N18'
14	Spare	
15-21	Data Level	'LEVEL-2'
22-33	Algorithm	'BY V8SBUV '
34	Spare	
35-47	Version	'VERSION 8.100'
48	Spare	

49-62	Program date	'Feb, 26 2004 '
63	Spare	
64-86	Operating system	'ON OSUNIX GEN'
87	Spare	
88-90	Month of data processing	'APR'
91	Spare	
92-93	Day of data processing	'12'
94	Spare	
95-98	Year of data processing	'2006'
99	Spare	
100-101	Hour of data processing	'16'
102-103	Minute of data processing	'29'
104-105	Second of data processing	'48'
106	Spare	
107-114	'DATA FOR'	
115-116	Spare	
117-119	Month of data	'APR'
120	Spare	
121-122	Day of data	'11'
123	Spare	
124-127	Year of data	'2006'
128	Spare	
129-130	Hour of data	'00'
131-132	Minute of data	'55'
133-134	Second of data	'02'
135-140	Spare	
141-1980	Input Control File (80 characters per input line)	
1981-8000	Spare	

Table 9.7.2.2-10 Version 8 Header Record II Layout

Byte	Description	Sample
1-5	Spare	
6-13	Satellite name and flight model identifier	'SBUV-N18'
14	Spare	
15-21	Level	'LEVEL-2'
22-33	Algorithm	'BY V8SBUV '
34	Spare	
35-47	Version	'VERSION 8.100'
48-60	Spare	
61-1900	Input constant file (80 characters per input line)	

1901-1968	Spare or the first 68 characters of the V6 PMF standard header record I	
1969-8000	Spare	

Table 9.7.2.2-11 Version 8 Data Record Layout

Word (V6 Word No.)	Content	Sample
1	Orbit Number	4590.000000
2	Greenwich Mean Time seconds	4870.000000
3	Logical sequence number	50.00000000
4	Satellite ID	18.00000000
5	Day of year	101.0000000
6	Year	2006.000000
7	Latitude for Total Ozone (318 nm)	21.90064812
8	Longitude for Total Ozone (318 nm)	-177.2539978
9	Solar zenith angle	25.69408035
10	Solar zenith angle at start of scan	25.51954079
11	Solar zenith angle at end of scan	26.11541557
12-23	N252, N274, N283, N288, N292, N298, N302, N306, N313, N318, N331, N340 (Measured n-values from the monochromator)	353.0212097
24-35	N252, N274, N283, N288, N292, N298, N302, N306, N313, N318, N331, N340 (Measured n-values from the photometer)	112.6623688
36	Total Ozone	285.4809875
37	Error flag	0.0000000000E+00
38	Reflectivity	0.1248972490
39	Algorithm flag	1.000000000
40	Step one ozone	283.8000183
41	Step two ozone	284.5615845
42-49	(dN/dΩ)292, (dN/dΩ)298, (dN/dΩ)302, (dN/dΩ)306, (dN/dΩ)313, (dN/dΩ)318, (dN/dΩ)331, (dN/dΩ)340	0.9698080976E-04
50-57	(dN/dR)292, (dN/dR)298, (dN/dR)302, (dN/dR)306, (dN/dR)313, (dN/dR)318, (dN/dR)331, (dN/dR)340	-0.6654153112E-03
58	(dN/dR)CCR (at 331 nm monochromator channel)	-119.6416702
59-66	Res(N292), Res(N298), Res(N302), Res(N306), Res(N313), Res(N318), Res(N331), Res(N340)	-2.646954060
67	Photometer Residual (CCR) at N331	0.3035485744
68	Terrain Pressure (atm)	1.000000000
69	Cloud top pressure (atm)	0.5330700874
70	Effective cloud fraction	0.0000000000E+00
71	Ozone below cloud	0.0000000000E+00
72	Surface category	0.0000000000E+00
73-75	Gain12-9, Gain8-5, Gain4-1	33332.00000 0.0000000000E+00 0.0000000000E+00
76	Aerosol Index	-0.3035485744
77-86	Total ozone <i>a priori</i> profile layer 0-9 Ozone	19.70327759
87	Total ozone <i>a priori</i> profile for layer 10 and above	1.284301281
88-97	Total ozone algorithmic efficiency Layer 0-9	0.6234209538
98	Total ozone algorithmic efficiency for layer 10 and above	1.102117181

99	Latitude for Profile Ozone (292 nm)	21.31681824
100	Longitude for Profile Ozone (292 nm)	-177.1071472
101-121	21 layer A-priori ozone profile (DU)(Layer bottoms are: 1.0,0.631,0.398,0.251,0.158,0.100,0.0631,0.040,0.0251,0.0158,0.010 0,0.0063,0.0040,0.00251,0.00158,0.0010,0.00063,0.00040,0.00025,0. 000158,0.0001, with top layer extending to infinity)	13.76889515
122-142	21 layer First guess ozone profile (DU)	10.63301754
143-163	21 layer Retrieved ozone profile (DU)	13.92403889
164-183	Estimated error of retrieved profile (%) (top layer not included)	6.871080875
184	Profile total ozone (DU)	285.6116943
185	Estimated error of profile total ozone (%)	1.000248790
186-200	Ozone mixing ratio in prescribed levels (ppmv) (0.5, 0.7, 1.0, 1.5, 2.0, 3.0, 4.0, 5.0, 7.0, 10.0, 15.0, 20.0, 30.0, 40.0, 50.0)	1.507388115
201-215	Estimated errors in mixing ratio (%)	8.611349106
216-225	Initial residuals (n-value: short to long wavelength)	-3.654667854
226-235	Final residuals (n-value: short to long wavelength)	-0.4110307395
236-435	10 x 20 Total scattering kernel (top layer not included)	0.000000000E+00
436-445	Computed single-scattering n-values (short to long wavelength)	353.5621033
446-458	Input temperature profile in Umkehr layers 12 - 0	240.9932098
459	Number of iterations for solution convergence	3.000000000
460	Reflectivity Correction	0.3565867373E-03
461-472	Grating drive position for wavelengths of 252, 274, 283, 288, 292, 298, 302, 306, 313, 318, 331, 340	4.000000000
473-480	Photometer reflectivity for wavelengths of 292, 298, 302, 306, 313, 318, 331, 340	0.1403288096
481	Sigma	0.5608523488
482	Error code for profile ozone	0.000000000E+00
483	Index of longest profile channel used	7.000000000
484	TOVS Cloud Pressure (SBUV2 Only)	-77.000000000
485-492	Cloud fraction for wavelengths of 292, 298, 302, 306, 313, 318, 331, 340	0.000000000E+00
493	Quality of Fit Parameter (Average final residual)	0.2619659156E-01
494	Dark Current Flag (Nimbus-04 only)	0.000000000E+00
495	Snow/Ice Indicator	0.000000000E+00
496-499	Photometer reflectivity for wavelengths of 252, 274, 283, 288	0.1389459223
500	Spare	99999.00000
501-900	20 layer averaging kernel	0.2918600850E-01
901	fractional error in radiance/flux	0.9999999776E-02
902	fractional error in profile	0.5000000000
903-1793	Spare	99999.00000
1794 (1)	Record ID (integer)	0.1066388131E-41 (761)
1795 (2)	Logical Sequence Number	55.00000000
1796 (3)	SBUV/2 Orbit Number	4590.000000
1797 (4)	Year at Start of Scan x 1000 + Day of Year at Start of Scan	2006101.000
1798 (5)	Seconds of Day	4870.000000
1799 (6)	Subsatellite Latitude at the Beginning of Scan (Degrees)	20.76972771
1800 (7)	Subsatellite Longitude at the Beginning of Scan (Degrees)	-176.9695282
1801 (8)	View Latitude - Average for Total Ozone Wavelengths (Degrees)	21.90064812
1802 (9)	View Longitude - Average for Total Ozone Wavelengths (Degrees)	-177.2539978
1803 (10)	Solar Zenith Angle - Average for Total Ozone Wavelengths (Degrees)	25.88033295

1804-1807 (11-14)	N-Values (CCR Coincident with 339.8, 331.2, 317.5, 312.5 nm)	114.7022018
1808-1811 (15-18)	N-Values (Monochromator 339.8, 331.2, 317.5, 312.5, 305 nm)	104.7198639
1812 (19)	Gain Selection code for each of five wavelengths (339.8, 331.2, 317.5, 312.5, 305 nm) (Ex: Integer #33322)	33332.00000
1813 (20)	Grating Position Error Offsets for wavelengths 1-6	444444.0000
1814 (21)	Total Ozone - Best Estimate based on TOVS Cloud Height. (m-atm-cm)	-77.00000000
1815 (22)	FOV Average Cloud Top Pressure (atm) (Reported by TOVS)	-77.00000000
1816 (23)	Pressure of Reflective Surface (atm) (Estimated using TOVS)	-77.00000000
1817 (24)	Reflectivity-Average(Estimated using TOVS)	-77.00000000
1818 (25)	Percent Cloud from CCR	-77.00000000
1819(26)	Ozone Error Flag for TOVS Total Ozone	-77.00000000
1820(27)	Total A-Pair Ozone (m-atm-cm)	281.7537842
1821 (28)	Ozone A-Pair sensitivity (N-Value/m-atm-cm)	0.1266763657
1822 (29)	Reflectivity average for A-Pair	0.1436941475
1823 (30)	Ozone Weight A-Pair	0.6520434618
1824 (31)	Total Ozone B-Pair (m-atm-cm)	289.5964661
1825 (32)	Ozone Sensitivity B-Pair (N-Value/m-atm-cm)	0.6523291767E-01
1826 (33)	Reflectivity average for B-Pair	0.1426741332
1827 (34)	Ozone Weight B-Pair	0.3479565382
1828 (35)	Total Ozone-Best Estimate Based on Climatological Cloud Height (m-atm-cm)	282.6184998
1829 (36)	Total Ozone C-Pair (m-atm-cm)	-77.00000000
1830 (37)	Pressure of reflecting Surface (Estimated Without TOVS) (atm)	0.8969467282
1831 (38)	Reflectivity Average	0.1431841403
1832 (39)	Ozone Sensitivity C-Pair (N-Value/m-atm-cm)	-77.00000000
1833 (40)	Ozone Error Flag for Best Ozone	0.0000000000E+00
1834 (41)	FOV Snow Flag * 10 + Table Selection Index 1 = Snow 1=Low Latitude 0 = No Snow 2 = Mid Latitude -1=No Info. 3 = High Latitude	1.230021596
1835 (42)	Grating Position Error Offset for wavelength's 7-12	444444.0000
1836 (43)	Reflectivity difference (Photometer/monochromator)	-0.8263364434E-02
1837 (44)	Terrain Surface Pressure (atm)	1.000000000
1838 (45)	Total Ozone D-Pair (m-atm-cm)	288.6121521
1839 (46)	SOI Index	3.594287157
1840 (47)	Total Ozone B'-Pair (m-atm-cm)	283.5286865
1841 (48)	View latitude – Average for profile (degrees)	21.31681824
1842 (49)	View longitude - Average for profile (degrees)	-177.1071472
1843 (50)	Solar Zenith Angle - Average for profile (degrees)	25.69408035
1844-1851 (51-58)	N-Values (CCR coincident with Profile wavelengths 252.2, 275.3, 283.0, 287.6, 292.2, 297.5, 301.9, and 305.8 nm)	112.6623688
1852-1859 (59-66)	N-Values (monochromator profile wavelengths)	353.0212097
1860-1861 (67-68)	Gain Selection Flags for Each of Eight Wavelengths	15.32454681
1862-1873 (69-80)	Layer Ozone-first Guess Amounts in 12 Pressure Layers (m-atm-cm)	0.9603615850E-01
1874 (81)	Total Ozone for A Priori profile (m-atm-cm)	282.6184998
1875-1884	Q-Values Corrected for Multiple Scattering and Surface Reflectivity	0.1054719673E-02

(82-91)	(252.2 through 317.5 nm)	
1885-1894 (92-101)	Initial Residues (252.2 through 317.5 nm) (%)	-2.375382423
1895-1899 (102-106)	Multiple-Scattering Correction to Q for Five Longer Wavelengths Channels (297.5 through 317.5 nm)	0.2912611817E-03
1900-1904 (107-111)	Reflectivities for Five Longer Wavelengths (297.5 through 317.5 nm)	0.1532480419
1905-1909 (112-116)	Multiple-Scattering Sensitivity for Five Longer Wavelengths (297.5 through 317.5 nm) (Q-Value/m-atm-cm)	-0.3800403094E-02
1910-1914 (117-121)	Multiple-Scattering Mixing Fraction for Five Longer Wavelengths (297.5 through 317.5 nm)	1.873179913
1915-1924 (122-131)	Final Residues (252.2 through 317.5 nm) (%)	-0.1078700796
1925-1936 (132-143)	Layer Ozone Amounts for Solution Profile in 12 Pressure Layers (m-atm-cm)	0.9808807075E-01
1937-1948 (144-155)	Layer Ozone Standard Deviations for Solution Profile in 12 Pressure Layers (%)	11.56864834
1949 (156)	Total Ozone for solution profile (m-atm-cm)	280.3361206
1950 (157)	Ozone Error Flag for Profile	0.0000000000E+00
1951-1952 (158-159)	Upper Level Profile parameters C (m-atm-cm) and Sigma	1.130160093 0.5665833950
1953-1971 (160-178)	Ozone Mixing Ratio at 19 Pressure Levels (micro gm/gm)	1.708832741
1972-1983 (179-190)	Layer Ozone Standard Deviations for First Guess in 12 Pressure Layers (%)	11.99999905
1984-1993 (191-200)	Standard Deviations of Q-Values Corrected for Multiple Scattering and Reflectivity (252.2 through 317.5 nm) (%)	1.039469957
1994 (201)	Number of Iterations for Profile Solution	2.000000000
1995 (202)	VCI (Volcano Contamination Index)	0.2916399837
1996 (203)	Spare (-77.0) or Solar Azimuth Angle at Field of View at start of scan (degrees)	-20265.00000
1997 (204)	Ozone Sensitivity D-Pair (N_value/m-atm-cm)	0.1641995311
1998 (205)	Ozone Sensitivity B'-Pair (N_value/m-atm-cm)	0.7568971068E-01
1999 (206)	Solar Zenith Angle at Start of Scan (Radians x 10 ⁴)	4454.000000
2000 (207)	Solar Zenith Angle at End of Scan (Radians x 10 ⁴)	4558.000000

Table 9.7.2.2.12 Version 8 Trailer record layout

Word	Description	Sample
1	Orbit number	4603.000000
2	GMT of first scan	3302.000000
3	Logical sequence number (negative)	-1206.000000
4	Day of year of first scan	101.0000000
5	GMT of first scan	3302.000000
6	Nadir view latitude of first scan	-68.95317078
7	Nadir view longitude of first scan	-143.5602875
8	Day of year of last scan	101.0000000
9	GMT of last scan	85862.00000
10	Latitude of last scan	76.30832672

11	Longitude of last scan	68.10655975
12	Local equator crossing time	-77.00000000
13	Local day of year at equator crossing	0.0000000000E+00
14	Local year at equator crossing	0.0000000000E+00
15	not used	-77.00000000
16	not used	0.0000000000E+00
17	not used	0.0000000000E+00
18	not used	-77777.00000
19	Ozone minimum for orbit	233.4052734
20	Ozone maximum for orbit	518.6837158
21-41	Daily processing counters	1112.000000
42-60	Spare	99999.00000
61-73	Instrument wavelengths	252.0399933
74-86	N-Value adjustment factors	0.0000000000E+00
87-98	Interpolation factor	0.4289999977E-01
99-152	Raman scattering correction factors	0.5600000173E-01
153	Reflectivity wavelength index	11.00000000
154	Reflectivity wavelength index for hi SZA	12.00000000
155	Ozone wavelength index	10.00000000
156	Ozone wavelength index for high SZA	11.00000000
157	Profile mixing wavelength index	9.000000000
158	F313 coefficient	-8.000000000
159-161	F360 coefficients	4.223000050
162-164	Flag 3 limit	10.00000000
165-167	Flag 4 limit	3.500000000
168	Fractional error in radiance/flux	0.9999999776E-02
169	Fractional error in profile	0.5000000000
170	Correlation length of <i>a priori</i> covariance	12.00000000
171	Ozone interpolation tolerance value	0.1000000047E-02
172-2000	Spare	99999.00000

Table 9.7.2.2-13 BUFR input table

----- USER DEFINITIONS FOR TABLE A, TABLE B, AND TABLE D -----		
MNEMONIC	NUMBER	DESCRIPTION
NC012201	A10019	SBUV/2 OZONE
SAID	001007	SATELLITE IDENTIFIER
SIID	002019	SATELLITE INSTRUMENT 624=SBUV/2
DATE	301011	DATE
TIME	301013	TIME
C08	352015	REPEAT EIGHT TIMES
C15	352016	REPEAT FIFTEEN TIMES
C20	352017	REPEAT TWENTY TIMES
C21	352018	REPEAT TWENTY ONE TIMES
CLAT	005002	LATITUDE (COARSE ACCURACY) FOR TOTAL OZONE
CLON	006002	LONGITUDE
LTLONG	001023	LATITUDE (COARSE ACCURACY) FOR TOTAL OZONE LONGITUDE (COARSE ACCURACY) FOR TOTAL OZONE
SOZA	007025	SOLAR ZENITH ANGLE SOLAR ZENITH ANGLE AT START OF SCAN SOLAR ZENITH ANGLE AT END OF SCAN
TSIG	008021	TIME SIGNIFICANCE
RSST	008029	SURFACE CATEGORY
ORBN	005040	ORBIT NUMBER
STKO	008075	ASCENDING/DESCENDING ORBIT QUALIFIER
OZON	015001	TOTAL OZONE
SBUVTOQ	033070	ERROR CODE FOR PROFILE OZONE
PRES	010004	TERRAIN PRESSURE (PA)
VSAT	008003	VERTICAL SIGNIFICANCE 0=SURFACE
ACIDX	015030	AEROSOL CONTAMINATION INDEX
CLDMNT	020081	CLOUD FRACTION FOR WAVELENGTHS 292,298,302,306,313,318, 331,340 EFFECTIVE CLOUD FRACTION OZONE BELOW CLOUD - SAME AS TOTAL OZONE
TLRFV	033042	TYPE OF LIMIT REPRESENTED
PRLC	007004	CLOUD TOP PRESSURE (PA)
OZOP	015005	21 LAYER A-PRIORI OZONE PROFILE (DU) (21 VALUES) 21 LAYER RETRIEVED OZONE PROFILE (DU) (21 VALUES)
MTXSIG	008026	MATRIX SIGNIFICANCE
LINCOF	025143	20 LAYER AVERAGING KERNEL (400 VALUES)
ATCT	008043	ATMOSPHERIC CHEMICAL TYPE
DSFTV	008090	DECIMAL SCALE
MIXRV	015008	OZONE MIXING RATIO IN PRESCRIBED LEVELS (PPMV) (15 VALUE)
SBUVPOQ	033071	SBUV PROFILE OZONE QUALITY
PCCF	033007	ESTIMATED ERRORS IN MIXING RATIO (15 VALUES)
WAVL	002071	FINAL RESIDUALS (N-VALUE: SHORT TO LONG WAVELENGTH)
YEAR	004001	YEAR
MNTH	004002	MONTH
DAYS	004003	DAYS
HOUR	004004	HOUR
MINU	004005	MINUTE
SECO	004006	SECOND
MNEMONIC	SEQUENCE	
* DEFINITION OF OZONE BUFR FILE		
NC012201	SAID SIID DATE TIME CLAT CLON SOZA TSIG SOZA TSIG SOZA TSIG	
NC012201	RSST ORBN STKO VSAT PRES VSAT 207002 OZON 207000 SBUVTOQ	
NC012201	ACIDX 207002 CLDMNT 207000 VSAT TLRV PRLC 207002 OZON 207000	
NC012201	VSAT "C21"21 ATCT "C15"15 ATCT SBUVPOQ "C08"8	

C21	PRLC PRLC 207002 TSIG OZOP TSIG OZOP PCCF 207000 MTXSIG "C20"20
C21	MTXSIG
C20	LINCOF
C15	PRLC DSFTV 207006 MIXRV 207000 DSFTV 207002 PCCF 207000
C08	202124 201107 WAVL 201000 202000 207002 CLDMNT 207000
DATE	YEAR MNTH DAYS
TIME	HOUR MINU SECO

MNEMONIC	SCAL	REFERENCE	BIT	UNITS
SAID	0	0	10	CODE TABLE
SIID	0	0	11	CODE TABLE
CLAT	2	-9000	15	DEGREE
CLON	2	-18000	16	DEGREE
LTLONC	2	-18000	16	DEGREE
SOZA	2	-9000	15	DEGREE
RSST	0	0	8	CODE TABLE
ORBN	0	0	24	NUMERIC
STKO	0	0	2	CODE TABLE
OZON	0	0	10	DU
SBUVTOQ	0	0	4	CODE TABLE
PRES	-1	0	14	PA
ACIDX	2	-1000	12	NUMERIC
CLDMNT	0	0	7	%
VSAT	0	0	6	CODE TABLE
PRLC	-1	0	14	PA
OZOP	0	0	10	DU
PCCF	0	0	7	%
LINCOF	6	-5000000	24	NUMERIC
MIXRV	0	0	10	PT/PT BY VOL
SBUVPOQ	0	0	4	CODE TABLE
WAVL	13	0	30	M
YEAR	0	0	12	YEAR
MNTH	0	0	4	MONTH
DAYS	0	0	6	DAYS
HOUR	0	0	5	HOUR
MINU	0	0	6	MINUTES
SECO	0	0	6	SECONDS
TSIG	0	0	5	CODE TABLE
TLRFV	0	0	3	CODE TABLE
MTXSIG	0	0	6	CODE TABLE
ATCT	0	0	8	CODE TABLE
DSFTV	0	-127	8	NUMERIC

9.7.3 OOPS STANDARD HEADER

Each monthly and daily SBUV/2 product has a pair of standard header records at the beginning of the data set that describes the contents of that data set. The standard headers include information such as the range of data coverage and the version number of the data set (for those situations where the data is recreated, e.g., due to changes in instrument calibration).

The 1b data set also contains standard headers describing each input data set (e.g. meteorological) used to build the 1b. The Product Master File will have the 1b standard header records in addition to its own standard headers. Starting with Version 8 PMFs in 2007, the 1B datasets is the only externally distributed dataset that will contain the OOPS Standard Header Records.

The format of the OOPS standard header is given on the following pages. Definitions of individual items can be found in the Data Dictionary, Section 9.7.4.

Table 9.7.3-1. OOPS Standard Header Record I.				
	Byte 1	Byte 2	Byte 3	Byte 4
Word	Description			
1	Record ID		Integer number	
2-3	Spacecraft Name		'NOAA - xx'	
4-5	Instrument Name		'SBUV/2'	
6-9	Data Set name		16 character data set name	
10	Data Version Identifier		'VER'	
11-12	Data Version		'bbxxa'	
13	Data Generation Identifier		'GENb'	
14-15	Data Generation Date		('yybmmbdd')	
16-17	Data Generation Time		('hhmmssb')	
18-19	Program Identifier		('PROGRAM:')	
20-21	Program name		('aaaaaa')	
22	Program Version Identifier		('VER')	
23-24	Program Version		('bxx.xxbb')	

25-26	Program Version Date	('yy b mm b dd')
27-28	Spare	(8 ASCII blanks)
29-30	Data Coverage identifier	('DATA:')
31-32	Data Start Date	('19yy b ddd')
33-34	Data Start Time	('`sss<m-kono@tv- asahi.co.jp > sss')
35	'To' Character	('bTO b ')
36-37	Data End Date	('19yy b ddd')
38-39	Data End Time	('ssss b ')
40	Standard/Non-standard Wavelength Flag	(4 ASCII blanks or 'STND' or 'SPEC')
41-180	Spares (ASCII blanks)	
<p>For Data Sets containing a time span of data (e.g. Daily 1b); Otherwise spare words (all ASCII blanks) b = blank, x = numeric character, a = alphabetic character. Note: all words are ASCII characters except word 1.</p>		

Table 9.7.3-2. OOPS Standard Header Record II.				
	Byte 1	Byte 2	Byte 3	Byte 4
Word	Description			
1	Record ID			
2-40	Data or Program Version Change Description			
41-180	Spare (ASCII blanks)			
Note: all words are ASCII characters except word 1				

9.7.4 DATA DICTIONARY

The data dictionary contains an entry for each lowest level data item, and in some cases, group items, found in each of the OOPS data sets. Where the same information occurs on more than

one data set, even if stored in different units (e.g., radians vs. degree), it has been given a common name and only occurs once in the data dictionary. Individual byte/bit breakdowns (e.g. series of 1 bit flags) of these items will not be listed as separate entries in the data dictionary.

The data set name abbreviations used in the data dictionary are given below for reference:

Data Set	Abbreviation in Data Dictionary
Product Master File	PMF
1b	1b

There the data set name given is All-OOPS which means that the associated data occurs on all four of the data products. These data items are part of the OOPS Standard Header (Section 9.7.4).

Data Dictionary			
Data Item	Data Sets	Description	
Analog Telemetry	1b	Seventeen SBUV/2 analog telemetry points, sampled at 16 second intervals. Analog telemetry data are found in word 13 of the TIP minor frames. For all but orbital and daily statistical records on the 1b data set, these data are given in terms of counts. On orbital and daily statistical records these are given in engineering units. For ranges and scaling factors see Section 9.7.1.5.	
		No.	Telemetry Point Name
		1.	SM Baseplate Temp. #2 (1)
		2.	SM Shroud Temp.
		3.	Depolarizer Housing Temp.
		4.	HVPS Temp.
		5.	Diffuser Plate Temp #2 (1)
		6.	Chopper Motor Temp.
		7.	Grating Motor Temp.
		8.	Diffuser Motor Temp.

		9	Cal Lamp Motor Temp.
		10.	Electrometer Temp.
		11.	Cal Lamp Power Supply Temp.
		12.	Diffuser Radiator Temp.
		13.	ELM Temp.
		14.	LVPS Temp.
		15.	Diffuser Heater Current or not applicable (2)
		16.	Baseplate Heater Current or Cal Lamp Heater Current (2)
		17.	28 V Main Power
		Notes: (1) powered from the 28 V analog TM BUS (2) First choice is for NOAA- F and G, second for NOAA- H, I, J, K, L and M	
A priori covariance Matrix	1b	144 elements of covariance matrix	
A priori Profile Coefficients	1b	180 coefficients for computing first guess ozone profiles	
Atmosphere Surface Backscatter Fraction	1b	Ratio used in multiple scattering correction and ozone inversion scheme (170 values)	
Averaging Kernel	PMF	The theoretical responses in the retrieval layer amounts to changes in the true atmospheric profiles. In the Version 8 product, this is a 20x20 array, associated with the 20 layers output in the product.	
Bad Quality Major Frame Flag	1b	Flag indicating one or more of the major frame quality flags has been set to true (i.e. = 1) thereby indicating a problem in the data. Bit set to 0 = no problem, 1 = problem.	
Band Center Wavelengths	1b, PMF	13 standard SBUV/2 wavelengths (Angstroms) ordered from shortest to longest range: 2500-4000 Angstroms	

Boost Mode Flag	1b	Flag indicating spacecraft in boost mode, usually the first 5 minutes following launch, during one or more TIP minor frames, therefore the data should not be used. Bit set to 0 = not boost mode, 1 = boost mode.
CCR Data	1b	Same as Monochromator Range Data, but for Cloud Cover Radiometer
CCR and Mono-chromator overrange Flags	1b	0 = not overrange
		1 = overrange; increase corresponding monochromator range or CCR data by 2^{16} .
		In Discrete Mode, for each monochromator range (1, 2, 3) and CCR.
		For Sweep Mode, flags for selected monochromator range for each of 10 samples, plus CCR.
		WARNING: Flags not set properly by the instrument, thus not to be used in any calculations using range counts.
Channel Error Flags	1b	32 one bit flags set if inconsistent data encountered in a particular channel. Flag set if:
		a) More or less than one grating mode flag is set or
		b) Inconsistent Hg lamp position given or invalid lamp position or
		c) more or less than one diffuser position given or invalid diffuser position or
		d) more than one automated sequence, given MSB represents first channel (second), LSB represents last channel (second) in 32 second major frame.
		Flag settings are:
		0 = no inconsistent data this channel
		1 = inconsistent data this channel
Channel Fill Flags	1b	32 one bit flags set if certain errors encountered in a particular channel.
		0 = no errors encountered
		1 = error encountered this channel.

		<p align="center">Error encountered is:</p> <p>a) data gap (all channel fill flags set in this case) or</p> <p>b) channel frame sync error or</p> <p>c) minor frame quality flag set for this channel.</p> <p>MSB represents first channel (second), LSB represents last channel (second) in 32 second major frame.</p>
DACS Quality	1b	<p>DACS quality for a NESDIS Orbit, containing:</p> <p>a) A count of input TIP minor frames that contain no frame sync word errors,</p> <p>b) A count of the DACS detected TIP parity errors (for embedded TIP, this is the count of minor frames with parity errors. For stored TIP this is the number of minor frame word groups with parity errors).</p> <p>c) A count of all auxiliary synch errors detected.</p>
DACS Status	1b	<p>DACS status information for a NESDIS Orbit, containing:</p> <p>a) P/N Flag</p> <p>0 = Normal Data</p> <p>1 = P/N Data</p> <p>b) Data Source</p> <p>0 = Unused</p> <p>1 = Gilmore</p> <p>2 = Wallops</p> <p>3 = SOCC</p> <p>c) Tape Direction</p> <p>0 = FWD (Time incrementing)</p> <p>1 = REV (Time decrementing)</p> <p>d) Data Mode</p>

		0 = Test Data
		1 = Flight Data
Data End Date And Time	All-OOPS	Year, Julian day, and second of day of last data in the data set. This data is placed in the OOPS standard header.
Data Fill Flag	1b	Flag indicating one or more minor frames of the TIP major frame contain fill data. The data should not be used. Bit set to 0 = no data fill, 1 = contains data fill.
Data Generation Date and Time	All-OOPS	Year, month, day, hour, minute and second for the creation of data in the data set. This data placed in OOPS standard header.
Data or Program Version Change Description	All-OOPS	Explanation of change(s) from previous to current version of data due to data version and/or program version change. This is placed in OOPS standard header.
Data Records Read	PMF	Number of data records from 1b data
Data Records Written	PMF	Number of data records written to PMF
Data Set Name	All-OOPS	Name of data set in OOPS standard header (e.g. Daily 1b Data Set)
Data Start Date and Time	All-OOPS	Year, Julian day, and second of day of first data in the data set. This data is placed in the OOPS standard header.
Data Type	1b	Type of data where:
		1 = LAC
		2 = GAC
		3 = HRPT
		4 = TIP

		5 = HIRS/2
		6 = MSU
		7 = SSU
		8 = DCS
		9 = SEM
		For SBUV/2 data, the source of data can only be 1, 2, or 3.
		TIP Source:
		1 = Embedded TIP
		2 = Stored Tip
		3 = Third CDA TIP
Data Version	All-OOPS	<p>Version number, given by <i>xxa</i>, for data/data set. Given in OOPS standard header (e.g. 01A). Number <i>xx</i> is incremented by 1 for:</p> <p>a) a change in the format of this data set either in the type of logical record types on the data set or the definition or arrangement of the data in a logical record type or</p> <p>b) a change in an algorithm used to generate data on the data set such that the data set generated with this new algorithm is not identical to the previous data version.</p> <p>c) a change in any input data set used to create it. The change may be caused by either an algorithm change in the program that created it or inclusion of updated data into an existing reference data set (e.g., for new ancillary coefficients).</p> <p>Letter <i>a</i> would change when the data set was regenerated with new data replacing old data or data being subtracted from the original data set but the process by which the data is calculated and placed on the data set has not changed. An example of this would be regenerating a data set by replacing missing data with good data. Any change to number <i>xx</i> would cause letter <i>a</i> to be reset to <i>A</i>.</p>
Date of Job Run	PMF	Date of data file production (e.g., MON DEC 10, 1984)

Day 1 Solar Irradiance	1b, PMF	Baseline Solar Irradiance values for each discrete monochromator channel and CCR.	
Day of Year	All-OOPS	Julian day of year. Range: 1-366	
Day of Year of First/Last Major Frame in SBUV Orbit	1b	Day of year of first/last available major frame in SBUV/2 orbit. Range: 1-366	
Digital A (Subcom) Analog House-keeping	1b	Contains the SBUV/2 housekeeping information identified. Each channel sampled twice per major frame (32 seconds). For ranges and scaling factors see Section 9.7.1.5. For all but orbital and daily statistical records on the 1b data set, these data are given in terms of counts. On orbital and daily statistical records these are given in engineering units.	
		Channel	Function
		1A	Chopper Motor Current
		2A	Diffuser Motor Current
		3A	HVPS Volts
		4A	Thermistor Bias (+10 V REF)
		5A	CAL Lamp Temp.
		6A	ECAL Ref. Voltage
		7A	+15 V Sensors-volts
		8A	-15 V Sensors -volts
		9A	+24 V Motor-volts
		10A	+5 V LED-volts
		11A	+10 V Logic-volts
		12A	CAL Lamp Current
		13A	Spare
14A	Grating Coarse Error		

		15A	Grating Motor Current						
		16A	Lamp Motor Current						
		1B	Spare						
		2B	Diffuser Plate Temp.						
		3B	Baseplate Temp.						
		4B	+25V Power (volts)						
		5B	+15 V Servo (volts)						
		6B	-15 V Servo (volts)						
		7B	CCR Diode Temp.						
		8B	SM Differential Temp. Y						
		9B	SM Differential Temp. Z						
		10B	Differential Reference Temperature Y						
		11B	Differential Reference Temperature Z						
		12B	PMT Cathode Temperature						
		13B	Spare						
		14B	Chopper Phase Error						
		15B	Spare						
		16B	Spare						
Digital B Telemetry	1b	<p>Twenty-two Digital B telemetry points which echo the SBUV/2 specific commands sent to the spacecraft. Each point is sampled at 3.2 second intervals. Digital B telemetry data specified to the SBUV/2 instrument are found in word 12 of the TIP minor frames. In order to conserve space on the 1b, only the first and sixth 3.2 second intervals are retained in the 22 least significant bits of the words. The telemetry points comprising Digital B are as follows:</p> <table border="1"> <thead> <tr> <th>No.</th> <th>Telemetry Point Name</th> <th>Logic State(1/0)</th> </tr> </thead> <tbody> <tr> <td>1</td> <td>Instrument Power</td> <td>On/Off</td> </tr> </tbody> </table>		No.	Telemetry Point Name	Logic State(1/0)	1	Instrument Power	On/Off
No.	Telemetry Point Name	Logic State(1/0)							
1	Instrument Power	On/Off							

		2	Discrete Command	Yes/No
		3	Sweep Command	Yes/No
		4	Wavelength Calibrate Command	Yes/No
		5	Position command	Yes/No
		6	High Voltage	Yes/No
		7	Motor Power	On/Off
		8	Lamp	On/Off
		9	Lamp	Enable/Disable
		10	Lamp assembly command	Open Cmd. /Closed Cmd
		11	High voltage	Enable/Disable
		12	Diffuser Stow command	Yes/No
		13	Diffuser Monitor command	Yes/No
		14	Diffuser Sun Command	Yes/No
		15	Diffuser Decontaminate Command	Yes/No
		16	Chopper Encoder Sensors	Primary/Backup
		17	Grating Encoder Sensors	Primary/Backup
		18	Diffuser Position Sensors	Primary/Backup
		19	Lamp Position Sensors	Primary/Backup
		20	Grating Drive Fix/Flex	Fix/Flex
		21	Baseplate Heater (NOAA- F & G) or Cal Lamp (NOAA- HIJKL&M)	On/Off
		22	Diffuser Heater	On/Off

Discrete/ Sweep Record	1b	0: Discrete format indicator
		1-12: Sweep record format. A complete sweep cycle is 6 major frames (2 records per frame, e.g., code 2 = second record of first frame).
		-1: either a) inconsistent data format (discrete or sweep) within major frame or b) inconsistent sweep grating position within major frame.
Dwell Mode Flag	1b	Flag indicating TIP in Dwell mode during one or more minor frames of the TIP major frame. Data in that minor frame(s) has a specific analog channel data and not the normal SBUV/2 data, therefore the data is incorrect. Bit set to 0 = not in dwell mode, 1 = TIP in dwell mode.
Effective Ozone Absorption Coefficients	1b, PMF	Computed (12 discrete + CCR) coefficients corresponding to 13 standard SBUV/2 wavelengths (shortest to longest), range 300-0 ($\text{atm}\cdot\text{cm}^{-1}$).
End time	1b	TIP time code giving year, day and milliseconds of day from the last TIP major frame of data appearing in a given TIROS-N Series orbit.
Final Channel Quality Flags	1b	32 one bit flags, set if any errors encountered for this channel
		0 = No errors
		1 = errors encountered:
		a) channel error flag set this channel or
		b) channel fill flag set this channel or
		c) channel fill flag of next channel set. If current channel is last channel of current major frame, final channel quality flag is set if fill flag of first channel of next major frame is set.
		MSB refers to first two channels (first 2 seconds of major frame 0, LSB refers to last channel (second) of this major frame and first channel (second) of next major frame.

Final Residues	PMF	<p>Computed as:</p> $\frac{(Q_{obs} - Q_{msr} - Q_{ss})}{Q_{ss}}$ <p>where, Q_{obs} = Q-value obtained from the observed radiance; Q_{mar} = Q-value that refers only to the multi-scattered and reflected component of the total intensity (obtained from a lookup table). Q_{ss} = Q-value that refers to the single scattered component of the total intensity (calculated within the program).</p>
FOV Average Cloud Amount	1b	Average cloud amount in percent for the four longest wavelength SBUV/2 FOVs.
FOV Average Cloud Top Pressure	1b, PMF	Averaged cloud top pressure in millibars for the four longest wavelength SBUV/2 FOVs.
FOV Average Cloud Temperature	1b	Averaged temperature profile in Kelvin x 64 for given pressure levels for the four longest wavelength SBUV/2 FOVs. Set to 0 if the Edit Flag indicates a bad sounding.
FOV Latitude	1b	FOV latitude is the geodetic latitude of the FOV at the start of the major frame. Expressed in degrees x 10 ² . Northward latitudes are positive. Latitude range: -90 to 90 degrees
FOV Longitude at Start of First/Last Major Frame in SBUV/2 Orbit	1b	Longitude at start of first/last available major frame in SBUV/2 orbit expressed in degrees x 100. Positive longitudes are eastward. Range: -180 to 180 degrees.
FOV Snow/Ice Flag	1b, PMF	Surface condition flag indicating a frozen surface cover (i.e. snow and/or ice) for the SBUV/2 FOV.
		1 = frozen surface
		0 = non-frozen surface

		-1 = missing		
FOV Surface Pressure	1b	Surface pressure interpolated from surface pressure data set for the center of the SBUV/2 FOV halfway into the major frame (i.e., 16 seconds from TIP time). This time represents the beginning of the data collection for the four longest wavelengths used in the total ozone computation. Pressure given in mb.		
Gain Selection Code	PMF	Indicates recommended gain range for each wavelength.		
Grating Position Error		Note: for flight Model #1 the count value will range between 0 and 10 counts since the telemetry point was grounded out.		
Initial Residues	PMF	Same as final residues except that first guess ozone is used to compute Q_{ss} and Q_{msr}		
Instrument Data Quality Flag	1b	A compilation of 4 quality flags for the time covered by this record.		
		Flag	0	1
		Master Power	On	Off
		High Voltage	On	Off
		Frame Sync	In Sync	Not in Sync
		Data Contamination due to automated command sequence taking place	Not Contaminated	Contaminated
		For each flag, 2 = data unavailable for determination due to fill.		
		For each flag, 3 = Inconsistent status during the 32 seconds.		
		This information pertains to all non-filled 32 seconds of data during both discrete and sweep modes except when E-CAL/Retrace is on (last 8 seconds during discrete mode or last 24 seconds at the end of a six major frame sweep cycle).		

Instrument Name	All-OOPS	Name of instrument (i.e., SBUV/2) in OOPS standard header.		
Interrange Ratio Coefficient Ranges	1b	Ratio of counts minus offset between monochromator gain		
Julian Day	1b, PMF	Day number counted from first day of current year.		
Layer Ozone	PMF	Individual ozone amounts (m-atm-cm) in 12 pressure layers.		
		UMKEHR	LAYER #	mb
		12	.0002-.0001	0.25 - 0.12
		11	.0005-.0002	0.49 - 0.25
		10	.0010-.0005	0.99 - 0.49
		9	.0020-.0010	1.98 - 0.99
		8	.0039-.0020	3.96 - 1.98
		7	.0078-.0039	7.92 - 3.96
		6	.0156-.0078	15.83 - 7.92
		5	.0313-.0156	31.66 - 15.83
		4	.0625-.0313	63.33 - 31.66
		3	.1250-.0625	126.66 - 63.33
			.2500-.1250	253.31 - 126.66
		1	1.0000-.2500	1013.25 - 253.31
Layer Ozone Standard	PMF	Standard deviation for solution profile individual ozone amounts (%) in 12 pressure layers.		
Level Ozone	PMF	Individual ozone amounts at 19 pressure levels.		
		Level #	Level Pressure (mb)	
		1	0.3	
		2	0.4	

		3	0.5
		4	0.7
		5	1.0
		6	1.5
		7	2.0
		8	3.0
		9	4.0
		10	5.0
		11	7.0
		12	10.0
		13	15.0
		14	20.0
		15	30.0
		16	40.0
		17	50.0
		18	70.0
		19	100.0
Log I _o	1b	From total ozone tables, 1700 tabularized values of the natural log of the intensity of atmospheric backscattered radiation	
Log Q (Single Scattered)	1b	From multiple scattering correction tables, 1700 values of the natural log of the single scattered Q-value.	
Logical Sequence Number	PMF	Sequential record number reset to 1 at the beginning of each orbit.	
Major Frame Counter	1b	Counter of available major frames in an orbit, starting with 1.	

Major Frame Quality	1b	Single bit quality flags. Flags covering the duration (32 records) of the major frame.
		0 = no error or given circumstances has not occurred
		1 = Error or given circumstance has occurred.
		See also definitions of the individual major frame quality flags:
		Bad Quality Major Frame Flag
		Time Error Flag
		Dwell Mode Flag
		Boost Mode Flag
		Data Fill Flag
		Missing Attitude Error Flag
		No SBUV/2 Earth Location Flag
		Unreasonable Date or Time Flag
		Non-time Ascending Flag
		Out of Range Attitude Data Flag
		Out of Range Analog telemetry Data Flag
Out of Range Earth Location Data Flag		
Major/Minor Frame Inconsistency Flag		
Note: The MSB (leftmost bit) of the word contains the Quality Summary Flag. It is set to 1 if any other flag is 1; otherwise it is 0.		
Major/Minor Frame Inconsistency Flag	1b	(1) One or more minor frame quality flags are set to 1 (error condition) but the associated major frame quality flags (time error, dwell mode, boost mode, data fill) are not set to 1; or (2) the reverse is true: one or more of these major frame quality flags is set to 1 but no minor frame quality flag is on.
Memory Verify	1b	See TIROS-N Unique Instrument Interface for SBUV/2.

Minor Frame Quality Flags	1b	32 one bit flags, each covering one channel or ten minor frames of the current major frame.
		0 = no error has occurred this channel
		1 = error occurred this channel
		Minor frame quality flags are set during decommutation and indicate one or more of the following occurred in the channel:
		Time error
		Dwell mode
		Boost Mode
		Data Fill
Missing Attitude Data Flag	1b	One or more of roll, pitch or yaw is missing in the major frame (Bit set to 0 = All data present, 1 = missing data).
Monochromator Data	1b	Same as Monochromator Range Data but for Sweep Mode.
Monochromator Grating Position	1b	Item contains position, segment being read and digital lock indicator. Grating position: 13 bit (see byte/bit breakdown) signed integer given in counts. Count range: -4095 to 4095. (Negative numbers given as 2's complement). Note: In sweep mode, samples are taken at 10 grating positions, corresponding to 10 wavelengths, per second. The grating position that is stored in sweep mode corresponds to the last wavelength sampled in this second. See Major Frame Synchronization in Section 9.7.1.2.2 for more details.
		Segment being read: 2 bits indicating which of the four flex mode segments (memories) is being used.
		0 = segment 0 being read
		1 = segment 1 being read
		2 = segment 2 being read
		3 = segment 3 being read

		Digital Lock: 1 bit flag indicating whether the grating position was in its locked position, bit set to 1 or unlocked position bit set to 0. Data collection is valid only when the grating position is locked.
Monochromator Range Data	1b	Discrete Radiance/Irradiance counts measured by the monochromator. Range = 0 to 65,535 counts. If the corresponding Monochromator Overrange Flag is set to on (1) then add 2^{16} to this value. WARNING: Monochromator Overrange Flags are not set properly by the instrument. They should not be used in any calculation using range counts. If the Retrace/ECAL Flag (see Sample Status Flag #1) is on (1), this is electronic calibration data.
Monochromator Range ID	1b	Corresponds to one of the three monochromator ranges.
		1 = Range 2 (0-10 na, discrete mode; 0-125 na, sweep mode)
		2 = Range 1 (0-100 pa, discrete mode; 0-1.25 na, sweep mode)
		3 = Range 3 (0-1 μ a, discrete mode; 0-12.5 μ a sweep mode)
Multiple Scattering Correction	PMF	Multiple scattering and reflectivity correction to Q-value for five longer profile wavelength channels.
Multiple Scattering Mixing Fraction	PMF	Multiple-scattering mixing fraction for five longer profile wavelength channels.
Multiple Scattering Sensitivity	PMF	Sensitivity of multiple-scattering and reflectivity correction to total ozone for five longer profile wavelength channels.
N-value	PMF	Attenuation number computed as: $N = -100 \log_{10} (I/F)$ where I = Backscattered radiance and F = Incident solar flux
NESDIS Orbit Number	1b	The NESDIS orbit number is assigned by NESDIS for one revolution starting/ending at the ascending node equator crossing. For the SBUV/2 borne afternoon satellite the NESDIS orbit number at the start of the SBUV/2 orbit will be the same as the SBUV/2 orbit number. The NESDIS orbit number at the end of the SBUV/2 orbit will be one greater than the SBUV/2 orbit number.

No SBUV/2 Earth Location Data Flag	1b	Flag indicating no Earth location data is available for either the start or end of the TIP major frame data. Bit set to 0 = Earth location present, 1 = missing Earth location data.
Non-Time Ascending Data Flag	1b	Flag indicating major frame date or time precedes previous major frame. Bit set to 0 = no problem, 1 = non-time ascending data.
Number of Coefficients for Interrange Ratios	1b	Number of discrete monochromator channels for which interranging ratios are given.
Number of Data Gaps	1b	Number of data gaps occurring in a given TIROS-N series (NESDIS) Orbit. A data gap that covers one or more consecutive TIP major frames is counted as one data gap. NESDIS orbits, as transmitted, may include some overlap with the previous or subsequent orbit. Data gaps that occur in the overlap will be included in the counters for both NESDIS orbits.
Number of Major Frames	1b	Total number of TIP major frames in a given TIROS-N (NESDIS) Orbit. NESDIS orbits, as transmitted, may include some overlap with the previous or subsequent orbit. Major Frames in the overlap will be included in the counters for both NESDIS orbits.
Number of Iterations	PMF	Number of iterations used by the profiling algorithm in a given retrieval.
OOPS Standard Header	ALL-OOPS	Audit trail information at the beginning of each OOPS data set.
		Required:
		Record ID
		Spacecraft ID
		Instrument name
		Data set name
		Data version
		Data generation date & time
Program name		

		Program version and data
		Optional (when applicable):
		Data start date and time
		Data end date and time
		Version Change description
		Standard/Non-standard
		Wavelength Flag
Out of Range Analog	1b	Flag indicating one or more Telemetry data Flag analog telemetry points is outside the range given in Data Dictionary. Bit set to 0 = all data in range, 1 = one or more points out of range.
Out of Range Attitude Data Flag	1b	Flag indicating one or more attitude quantities (roll, pitch, and yaw) in major frame is outside the range given in the Data Dictionary. Bit set to 0 = all attitude data in range, 1 = values out of range.
Out of Range Earth Location Data Flag	1b	Flag indicating one or more Earth location values is outside the range given in the Data Dictionary. Bit set to 0 = all Earth location data in range, 1 = value(s) out of range.
Ozone Error Flags	PMF	Total Ozone
		0 - Low path length, good scan
		1 - High path length, good scan
		2 - Very high path, good scan
		3 - Spare
		4 - Inconsistency between best ozone and the largest weighted ozone pair
		5 - Difference between best ozone and total ozone for profile greater than three sigma
		6 - Spare
		7 - Photometer Reflectivity and monochromator reflectivity differ by more than 0.15

		8 - Best Reflectivity out of range (less than - 0.05 or greater than 1.05)
		9 - A-pair, B-pair or C-pair ozone exceeds the dynamic range of the tables. The dynamic ranges are:
		Latitude less than 15° : 180 to 350 Dobson Unit (DU)
		Latitude 15° to 45° :180 to 600 DU
		Latitude greater than 45° : 180 to 650 DU
		10-19 Same as above except the data taken in descending mode.
		Profile:
		0 - No error
		1 - Lower level anomaly
		2 - Inconsistency between best ozone and profile total ozone
		3 - Final residue greater than three sigma
		4 - Measured Q-value calculated with a priori profile and multiple-scattering/Reflectivity correction
		5 - C greater than 3.0 DU or less than 0.5
		6 - Sigma greater than 0.8 or less than 0.3
		7 - Reflectivity is less than -0.05, greater than 1.05, or changes by more than 0.05 from wavelength to wavelength
		8 - Total ozone not available or in-band stray light contamination
		9 - Bad radiance or eclipse contamination
		10-19 Same as above except the data taken in descending mode.
Ozone Mixing Ratios	PMF	Solution mixing ratio (micro-gm/gm) at 19 pressure levels
Ozone Sensitivity	PMF	Sensitivity of a pair of wavelengths is defined as dN_p/dO , where N_p is the difference in the N-value of pair wavelengths and O is the total ozone

Percent Cloud	PMF	Percent cloud cover computed by Product Processor using CCR and snow/ice information (0 - 100).
Pitch Euler Error Angle	1b	Pitch Euler error angle of the spacecraft given in radians x 8,192. Expected range: -0.2 to 0.2 degrees (3 sigma).
Prelaunch Radiance /Irradiance Calibration	1b	Instrument specific prelaunch radiance or irradiance counts to engineering units conversion constants for each of 12 discrete wavelengths at each of 3 PMT gain ranges, plus 1 value for CCR. (Irradiance: W/cm ³ , radiance: W/cm ³ /sr).
Pressure of Reflecting Surface	PMF	Effective surface pressure (mb).
Processing Block Identification	1b	Seven digit (ASCII) number identifying the spacecraft revolution (NESDIS orbit number) in which recording of this data set began and the revolution (NESDIS orbit number) in which it terminates (the first 5-digits identify the beginning revolution and the last two identify the concluding revolution).
Processing Counters	PMF	The following counters have been defined for total ozone processing:
		1 - not used (0)
		2 - data records read
		3 - data records written
		4 - output records unprocessed (5+7)
		5 - solar zenith angle greater than limit
		6 - not used (0)
		7 - bad counts and solar eclipse data
		8 - Non-zero total ozone error flag (sum of 9-14)
		9-18 - total ozone error flags 9-0 (reverse order)
		19 - bad radiance (profile wavelength only)
		20 - no total ozone available
21 - records with profile ozone error flag greater than 2		

		22-28- profile ozone error flags 3-9
Processing Options	PMF	There are 20 possible processing options, only four of which are currently implemented (false - disabled, true - enabled):
		6 - Profile processing
		7 - Do not use seventh channel in profile processing
		8 - Do not use first channel in profile processing
		9 - Do not use ninth channel in profile processing
Processing Parameters	PMF	Limiting values used to edit input 1b data. They include:
		Maximum SZA 0-90 degrees
		Minimum latitude -90 to +90 degrees
		Maximum latitude -90 to +90 degrees
		Minimum latitude must be less than maximum latitude (under normal processing conditions, max. SZA = 92°, min. latitude = -90, max. latitude = +90).
Program Name	All-OOPS	Name of program that generated the data. Name in OOPS standard header.
Program Version	All-OOPS	Version number given as xx.yy, for program. This is given in OOPS standard header (e.g., 01.01) Number xx is incremented by 1 when a change in the program alters the format of the output data set(s) or the contents of the output data set(s) other than generation run time, such that if the program was rerun with the same input data sets, it would not generate an identical (except for generation run time) output data set. Number yy is incremented by 1 when a change in the program does not alter the format or content of the output data set. Such changes might be enhancements to printed output, insertion of additional comments to the program, etc. Any change to number xx would cause number yy to be reset to 01.
Program Version Date	All-OOPS	Year, month and day that generating program version was made operational.
Q-Value	PMF	Normalized radiance - irradiance ratio. Given for each profile wavelength.

Radiance Calibration	PMF	Counts to radiance conversion factors used in ozone computation ($W/cm^3/sr/count$).
Radiometric DC Level	1b	TIROS-N Unique Instrument Interface for SBUV/2.
Rayleigh Scattering Coefficients	1b, PMF	Rayleigh scattering coefficients computed for each of the 13 (12 discrete + CCR) SBUV/2 wavelengths, in order from short to long.
Recommended Monochromator Range Data	1b	Actual counts obtained for the recommended monochromator range.
Recommended Monochromator Range ID	1b	One of the three monochromator range ID's, it is chosen as follows:
		If Range 3 data is greater than or equal to 719 counts then Range ID = 3.
		If Range 2 data is greater than or equal to 719 counts and Range 3 data is less than 719 counts the Range ID = 2
		If Range 2 and 3 are less than 719 counts then range ID = 1
Record ID	All-OOPS	Unique record identification number for each record type in the 1b Data Set. See Table 9.7.1.4-1.
Reflected Fraction	1b	1700 values of this ratio used in the multiple scattering correction and ozone inversion scheme.
Reflectivity	PMF	Effective surface reflectivity computed by total ozone algorithm (fraction).
Reflectivity Difference	PMF	Difference between the reflectivity computed using the photometer and that using the monochromator.
Roll Euler Error Angle	1b	Roll Euler error angle of the spacecraft given in radians x 8192. Expected range -0.2 to 0.2 degrees (3 sigma)
SBUV/2 Day Number	1b	The day number of the first major frame of the current SBUV/2 orbit, counted from day of launch.

SBUV/2 Orbit Number	1b, PMF	An SBUV/2 orbit is defined as data collected from one revolution of the Earth starting/ending at the dark side of Earth equator crossing. For an afternoon satellite (the SBUV/2 instrument will only be carried on an afternoon satellite), the dark side equator crossing occurs on the descending node. The SBUV/2 orbit number is based on the NESDIS orbit number in that it will be the same as the NESDIS orbit number for the first half of the SBUV/2 orbit (i.e. from descending node equator crossing to ascending node equator crossing). For the second half of the SBUV/2 orbit the NESDIS orbit number would be one greater.
Sample Status Flag #1	1b	A series of status flags:
		Data format: discrete/Sweep (0/1)
		Retrace (ECAL) Off/On (0/1);
		ECAL Step #A-E (0-7) where:
		Step A = 1 to 4
		B = 5
		C = 6
		D = 7
		E = 0
		Grating Mode:
		0 = Discrete
		1 = Wavelength Calibration
		2 = Position
		3 = Sweep
		4 = Diffuser Decontamination
7 = Inconsistent (i.e., more than one mode set)		
(Differs from Ball Brothers convention) Information pertains to 2 second interval (one discrete sample) in discrete mode; pertains to one second interval for sweep mode (ten sweep samples).		

Sample Status Flag #2	1b	<p>A series of status flags: Grating Memory Mode: Fix/Flex(1/0) Grating Index: Found/Not Found(1/0) Frame Sync Code: In Sync/Not in Sync(0/1) Automated Command: 0 = None enabled 1 = Discrete sun enable 2 = Sweep sun enable 3 = Wavelength-calibration enable Command Sequence state: Step number for one of three Automated Command Sequences, three series of SBUV/2 commands designed to provide for execution of a number of commands with only a single command being sent. These three set sequences, namely Discrete Sun Enable, Sweep Sun Enable and Wavelength Calibration Enable, each have up to eight command sequence states. In each command sequence, a particular SBUV/2 command is executed. Information pertains to two second interval (one discrete sample) in discrete mode; pertains to one second interval for sweep mode (ten sweep samples).</p>
Sample Status Flag #3	1b	A series of status flags:
		Master Power On/Off (0/1)
		Calibration Lamp timer: Not Time Out/Time Out (0/1)
		Cal-Lamp Position: Open(0); Closed (1); Inconsistent or Invalid (3)
		Diffuser Timer: Not Time Out/Time Out (0/1)
		Diffuser Position:
		0 - Stowed
		1 – Sun
		2 - Monitor
		3 - Decontaminate
		7 - Invalid
		Information pertains to two second interval (one discrete sample)

		in discrete mode; pertains to one second interval for sweep mode (ten sweep samples).
Sample Status Flag #4	1b	A series of status flags:
		Code Address A
		Code Address B
		Code Data Bit 1 to 6 (LSB) information pertains to two second interval (one discrete sample) in discrete mode; pertains to one second interval for sweep mode (ten sweep samples).
Scene Mode	1b	Radiance Source to the SBUV/2 instrument
		0 = Earth Scene
		1 = Same as above except for diffuser sun scene.
		2 = Same as above except for direct Hg lamp scene
		3 = Same as above except for diffuser-Hg lamp scene.
		7 = Scene mode unavailable for determination (all channel fill flags set)
		9 = Inconsistent/changing scene mode
		This information pertains to all non-filled 32 seconds of data during both discrete and sweep modes except when E-CAL/Retrace is on (last 8 seconds during discrete mode or last 24 seconds at the end of a six major frame sweep cycle) or fill encountered.
Seconds of Day	All-OOPS	Seconds of day. Range: 0-86,399.
Seconds of Day at Start of First/Last Major Frame in SBUV/2 Orbit	1b	Seconds of day at start of first/last available major frame in SBUV/2 orbit. Range: 0-86,399.

Solar Azimuth Angle at FOV	1b	Solar azimuth angle measured in the tangent plane from a line through the FOV due north to the projection of the sun line into the tangent plane. Measured clockwise as seen from the zenith. Expressed in degrees x 100. Range: -180 to 180 degrees.
Solar Declination	1b	Solar declination (celestial latitude) angle at the start of the major frame. This is an angle between the sun and the inertial equator measured in a plane normal to the inertial equator (meridian) containing the sun. North of the equator is positive. Expressed in degrees x 100. Range: -90 to 90 degrees
Solar Right Ascension	1b, PMF	Solar right ascension (Celestial longitude) angle at the start of the major frame. This angle is measured in the plane of the equator from a fixed inertial axis in space (Vernal Equinox) to a plane normal to the equator (meridian) containing the sun. Eastward from the Vernal Equinox is positive. Expressed in degrees x 100. Range: -180 to 180 degrees.
Solar Zenith Angle at FOV	1b, PMF	Solar zenith angle, measured at the FOV between the zenith normal to the tangent plane (horizon) at the FOV and the sun. Expressed in degrees x 100. Range: 0 to 180 degrees.
Spacecraft Altitude	1b	The spacecraft altitude, in integer kilometers at the start of the major frame. Range: 833 ± 90 km.
Spacecraft Centered Solar Azimuth Angle	1b	Solar azimuth angle in spacecraft centered coordinate system. Expressed in degrees x 100. Range: -180 to 180 degrees.
Spacecraft Centered Solar Elevation Angle	1b	Solar elevation angle in spacecraft centered coordinate system. Expressed in degrees x 100. Range: -180 to 180 degrees.
Spacecraft Identification	1b	The identifier of the spacecraft from which the data was obtained where:
		0 – Spare
		1 - TIROS-N NOAA-H (N-11)
		2 - NOAA-A (N-6) NOAA-I (N-13)

		3 - NOAA -B NOAA-J (N-14)
		4 - NOAA - C(N-7) NOAA-K (N-15)
		5 - NOAA -D (N-12)
		6 - NOAA -E (N-8)
		7 - NOAA -F (N-9)
		8 - NOAA- G (N-10)
Spacecraft Name	All-OOPS	TIROS-N series spacecraft name (e.g., NOAA-8) in OOPS standard header.
Standard/ Non-standard Wavelength Flag	1b	Indicates that (1) one or more of the 12 discrete wavelengths in one or more major frames (determined from grating mode position) does not match the wavelengths in the Ancillary Data Set, and/or (2) the start sweep mode wavelength in one or more scans does not match the preassigned value. This condition is expected to occur when wavelengths are changed using FLEX mode for special scientific studies:
		STND = All wavelengths standard,
		SPEC = One or more non-standard wavelengths detected in this Daily 1b Data Set
Start Time	1b	TIP time code given in year, day, and milliseconds of day from the first TIP major frame of data appearing in a given TIROS-N (NESDIS) orbit.
Subsatellite Latitude	1b, PMF	Subsatellite geodetic latitude at the start of the major frame as expressed as degrees x 100. Positive latitudes are northward, Range: -90 to 90 degrees (expressed as decimal degrees on PMF).
Subsatellite Longitude	1b, PMF	Subsatellite longitude at the start of the major frame expressed as degrees x 100. Positive longitudes are eastward. Range: -180 to 180 degrees (expressed as decimal degrees on PMF).
Summary Grating Memory Wavelength	1b	0 = fix mode; standard wavelength
		1 = flex mode; standard wavelength
		2 = fix mode, non-standard wavelength
		3 = flex mode, non-standard wavelength

		7 = mode unavailable for determination (all channel fill flags set)
		9 = inconsistent/changing mode
		This information pertains to all non-filled 32 seconds of data during both discrete and sweep modes except when E-CAL/Retrace is on (last 8 seconds during discrete mode or last 24 seconds at the end of a six major frame sweep cycle)
Summary Grating Mode	1b	Monochromator Grating Mode:
		0 = Discrete Mode
		1 = Wavelength Calibration Mode
		2 = Position Mode
		3 = Sweep Mode
		4 = Diffuser Decontamination Mode-(based on diffuser position only)
		7 = Grating mode unavailable for determination (all channel fill flags set)
		9 = Inconsistent/changing modes
		This information pertains to all non-filled 32 seconds of data during both discrete and sweep modes except when E-CAL/Retrace is on (last 8 seconds during discrete mode or last 24 seconds at the end of a six major frame sweep cycle).
Table Selection Index	PMF	Indicates standard profile used in profiling algorithm (1-3)
Terrain Surface Pressure	PMF	Terrain surface pressure (atm)
Time Error Flag	1b	Flag indicating a time error has occurred in one or more of the minor frames of the TIP major frame, thus the data is not correctly time matched and should not be used. Bit set to 0 = no time error, 1 = time error.
Total Ozone	PMF	Total ozone (m-atm-cm)

UMKEHR		Procedure to get a vertical ozone profile from the ground up using a Dobson Spectral Photometer
Unreasonable Date or Time Flag	1b	Flag indicating unreasonable major frame year, day of year, or seconds of day, i.e., year less than 0 or greater than 99, day of year less than 0 or greater than 366, seconds of day less than 0 or greater than 86,399. Bit set to 0 = data in range, 1 = data out of range
Upper Profile Parameters	PMF	Parameters C and s determined by assuming an ozone profile of the form: $X(p) = Cp^{1/s}$ where p = pressure in mb, X= cumulative ozone at pressure level p, s = ratio of the atmospheric scale height and ozone scale height, C = ozone at 1 mb (DU).
View Latitude	PMF	Latitude interpreted to the time of measurement of selected wavelengths (-90.0 to 90.0).
View Longitude	PMF	Longitude interpreted to the time of measurement of selected wavelengths (-180.0 to 180.0).
Volcano Contamination Index	PMF	A measure of the amount of aerosols. Ranges from approximately -10 to +20. Uncontaminated data should be approximately zero. +20 represents maximum contamination. Negative numbers are due to noise in the measurements.
Yaw Euler Error Angle	1b	Yaw Euler error angle of the spacecraft given in radians x 8,192. Expected range: -0.2 to 0.2 degrees (3 sigma).
Year	All-OOPS	Year of First/Last Major Frame in SBUV/2 Orbit. Two digit year (e.g., 84) except digit year in PMF.
Year of First/Last Major Frame in SBUV/2 Orbit	1b	2 digit year of first/last available major frame in SBUV/2 orbit.

9.8 AEROSOL/OPTICAL THICKNESS PRODUCTS

NOAA/NESDIS currently produces Aerosol products from NOAA-14 AVHRR data on a weekly basis, using a revised (Phase 2) single channel algorithm for aerosol optical thickness retrieval over oceans from radiances in Channel 1. This algorithm scales the upward satellite radiances in

cloud-free conditions to aerosol optical thickness using an updated radiative transfer model of the ocean and atmosphere. The primary products are a global one degree map of Aerosol Optical Thickness based on a composite of one week's worth of data and the monthly mean product.

These products are archived at the National Climatic Data Center in both hardcopy chart and digital dataset form.

9.8.1 AEROSOL DAILY SUMMARY FILE

The Aerosol Daily Summary File contains statistical information pertaining to aerosol observations in each of the earth's 648 (10 degrees x 10 degrees) Lat/Long boxes.

9.8.1.1 File Structure Description

The first record is a directory record and all other records are data records. There are 41 records in the file.

9.8.1.2 Directory Record Format

The directory record contains information about the time of the data in the file and pointers to the data records for particular Julian Days. Table 9.8.2.2-1 contains the directory record format.

Table 9.8.1.2-1. Aerosol Daily Summary Directory Record Format.		
Halfword	Quantity	Range
1	# of records in the file	41 (initially)
2	Year of most recent data in the file	0-32767
3	Record number updated most recently	1-41
4	Julian day of data in first data record	1-366
5	Julian day of data in second data record	1-366
6 to N + 3	Julian day of data in the 3rd through Nth data record	1-366

9.8.1.3 Data Record Format

Each data record contains all data for a particular day. There are 648 blocks of information (1 block for each 10 degrees x 10 degrees Lat/Long box on the globe). Each block is 20 bytes long and thus each record is 20 x 648 or 12,960 bytes in length. The blocks are organized within each data record sequentially from West to East with the first block containing statistics from the box

enclosed by -90.00 to -80.01 degrees latitude (-S, +N) and -180.00 to -170.01 degrees longitude (-W, -E). The second block has statistics from the next box to the east or the box bounded by -170.00 to -160.01 degrees longitude and -90.00 to -80.01 degrees latitude. The 37th block therefore contains statistics for the box -180.00 to -170.01 degrees longitude and -80.00 to -70.01 degrees latitude.

To calculate the starting byte number for the 20-byte block of statistics for a particular (10 degree x 10 degree) box within a data record, the following formula can be used:

$$StartingByteNo. = \left(36 \times \frac{(LLLA - OLA)}{10} + \frac{(LLLO - OLO)}{10} \right) \times 20 + 1$$

where:

LLLA = Lower left latitude of desired (10 x 10 degrees) box,

LLLO = Lower left longitude of desired box,

OLA = Latitude of file origin = -90.00 and

OLO = Longitude of file origin = -180.00.

The documentation record is contained in a 20-byte block as shown in Table 9.8.2.2-1.

Table 9.8.1.3-1. Aerosol Daily Summary File Documentation Record Format.			
Halfword	# of Bytes	Quantity	Range
1	2	Number of observations in the box	0-32767
2	1	Maximum optical thickness (O.T.) for the box (x 100).	0-244
2	1	Minimum O.T. for the box (x 100)	0-244
3-4	4	UTC of maximum O.T. value. (Hours x 10,000) + (minutes x 100) + seconds.	0-235959
5	2	Latitude of observation with maximum O.T. value. (Degrees x 100)	-9000 to 9000
6	2	Longitude of observation with maximum O.T. value. (Degrees x 100)	-18000 to 18000
7	1	Spare	n/a
7	1	Mean optical thickness for box (x100).	0-244

8	2	# of observations with O.T. above extreme event threshold	0-32767
9-10	4	Spare	n/a

9.8.2 AEROSOL WEEKLY 100 KM ANALYZED FIELD FILE

An aerosol optical thickness 100 km analyzed field file consists of a specific set of information pertaining to global latitude and longitude intersections. The one degree resolution file, includes the area from -180 degrees to +179 degrees longitude and from -70 degrees to +70 degrees latitude.

9.8.2.1 File Structure Description

The file consists of one documentation record (record number one), followed by one record for each latitude or row of the field. Record 2 or the first latitude row is the southernmost row or the 70 degrees South row. Each row consists of seven words (28 bytes) of information for each longitude column forming a grid intersection plus one seven-word unit containing the row number identification and the date and time of the last analysis made for the field. The first grid intersection of each row is the 180 degree west meridian or the date line. Grid points proceed to the east across the record from left to right ending with the 179 degree East meridian. The documentation record is created from a name list dataset and is displayed in name list format, although it is stored as a binary record. The record size is 10,108 bytes.

9.8.2.2 Documentation Record Format

Table 9.8.2.2-1 contains the format for the documentation record of the Aerosol Weekly 100 km analyzed field file.

Word #	Parameter	Description
1	LDBGN	Record number of the first row of the field (currently 2 for all fields since the documentation record requires only one record).
2	SMGLAT	Minimum latitude included in field which is the bottom edge and first row of field
3	AXLAT	Maximum latitude included in field which is the top edge and last row of field.
4	SMLONG	Minimum longitude included in field which is the left edge and first column of field.

5	AXLONG	Maximum longitude included in field which is the right edge and last column of field (excluding the I.D. column).
6	RES	Number of latitude/longitude degrees between each grid point
7	SMHOUR	Youngest time, in hours of the year, of observations used during last analysis, which becomes the oldest time allowed for the next analysis. If the difference between this time and time of next analysis is greater than the maximum time gap allowed, SMHOUR for the beginning of the next analysis is reduced to make the difference equal to the maximum time gap.
8	HOURS	Oldest time, in hours of the year, of observations used during last analysis.
9	TIMGAP	Number of hours between youngest and oldest times of observations used in analysis.
10	MAXDAT	Maximum number of hours allowed in time period for observation times to be included in analysis.
11	SMREL	Minimum reliability of observations to be used in analysis.
12	AXREL	Maximum reliability of observations to be used in analysis.
13-22	SORC(10)	List of source codes of observations to be used in analysis.
23-32	OBTYPE (10)	List of observation types allowed to be used in analysis.
33	NROWS	Number of rows (latitudinal parallels) included in field, excluding documentation record.
34	NCOLS	Number of columns (longitudinal meridians) in field, including the I.D. column.
35	IBLK	Number of rows or logical records per physical block.
36	NWRDS	Number of full words (32 bits) allocated to each grid point.
37	ISZ	Number of rows to be maintained in an array in core for optical thickness and analysis and calculation of gradients.
38	ICENT	Center line within the array upon which calculations will be performed.

39-41	LWT, LNT, LBT	Word number, length in bits, and starting bit location of optical thickness within a grid intersection information unit of an SST Field.
42-44	LWG, LNG, LBG	Word number, length in bits, and starting bit location of Average Gradient.
45-47	LWGXP, LNGXP, LBGXP	Word number, length in bits, and starting bit location of Gradient X+direction.
48-50	LWGXN, WNGXN, LBGXN	Word number, length in bits, and starting bit location of Gradient X+direction.
51-53	LWGYP, LNGYP, LBGYP	Word number, length in bits, and starting bit location of Gradient Y+direction.
54-56	LWGYN, LNGYN, LBGYN	Word number, length in bits, and starting bit location of Gradient Y-direction.
57-59	LWPD, LNPD, LBPD	Word number, length in bits, and starting bit location of Physiographic Descriptor.
60-62	LWNO, LNNO, LBNO	Word number, length in bits, and starting bit location of Number Observations.
63-65	LWAGE, LNAGE, LBAGE	Word number, length in bits, and starting bit location of Age Recent Observation
66-68	LWREL, LNREL, LBREL	Word number, length in bits, and starting bit location of Reliability.
69-71	LWCLS, LNCLS, LBCLS	Word number, length in bits, and starting bit location of Class 1 Coverage.
72-74	LWSXP, LNSXP, LBSXP	Word number, length in bits, and starting bit location of Spatial Covariance in the positive X direction.

75-77	LWSXN, LNSXN, LBSXN	Word number, length in bits, and starting bit location of Spatial Covariance in the negative X direction
78-80	LWSYP, LNSYP, LBSYP	Word number, length in bits, and starting bit location of Spatial Covariance in the positive Y direction.
81-83	LWSYN, LNSYN, LBSYN	Word number, length in bits, and starting bit location of Spatial Covariance in the negative Y direction.
84-86	LWIND, LNIND, LBIND	Word number, length in bits, and starting bit location of Independent Temperature.
87-96	GRDWTS (10).	Weight assigned to each grid unit, according to its distance from the grid intersection for which gradients are being calculated
97	NP	Number of grid points to be used in calculation of gradients.
98-117	KMDST (10,2)	Look up table of gradient values and corresponding distances to be used in determining the search area for analysis.
118	MKM	Number of paired entries in KMDST.
119-138	H(10,2)	Look up table of gradient values and corresponding factors to be used in determining the new weight assigned to the observation temperature for analysis.
139	MH	Number of paired entries in H.
140	EXP	Exponent used in temperature analysis.
141	FDX	Factor used in determining new weight assigned to the optical thickness observation for analysis.
142	XCLASS	Factor used to place gradients into a class for Gradient Class Summary
143	DEL	Maximum number of optical thickness units that the new analysis temperature may differ from the previous optical thickness field value.
144	MF	Factor applied to the previous optical thickness and reliability to determine the final optical thickness and its reliability.

145	MSTAR	Factor applied to the combined observations temperature and weight in determining the new analysis optical thickness
146	MNSRCH	Minimum distance in kilometers to be searched for analysis observations.
47	MXSRCH	Maximum distance in kilometers to be searched for analysis observations.
148	BDEL	Maximum difference allowed between new analysis optical thickness and the previous one for the Class 1 Coverage Bit to be set to 1.
149	FCWT	Maximum value that can be assigned as the reliability of the new analysis optical thickness.
150	IYYY	Year of youngest time of observation data used (0-99).
151	IYMM	Month of youngest time of observation data used (1-12).
152	IYDD	Day of youngest time of observation data used (1-31).
153	IYHH	Hour of youngest time of observation data used (0-23).
154	IOYY	Year of oldest time of observation data used (0-99).
155	IOMM	Month of oldest time of observation data used (1-12).
156	IODD	Day of oldest time of observation data used (1-31).
157	IOHH	Hour of oldest time of observation data used (0-23).
158	ICURTM	Last time used in analysis

Values are stored as real (IBM floating-point) or integer according to the format implied by the first letter of their label. (Parameters beginning with I, J, K, L, M and N are integer values.)

9.8.2.3 Data Record Format

Each data record (latitudinal row) consists of a series of grid intersection points. These points are 28 bytes in length. Each longitude (column) reflects one grid intersection. At the end of the data record (i.e., immediately following the last column) is a 28 byte row identifier. All parameters are stored as integer values.

Table 9.8.2.3-1. Format of Grid Intersection in Data Record.

Word #	Length (bytes)	Description	Units	Comments
1	2	Optical Thickness	x 1000	0 to 2440
1	2	Average Gradient	units/100 km (x 1000)	0 to 300
2	2	Gradient X+	units/100 km (x 1000)	0 to 300
2	2	Gradient X-	units/100 km (x 1000)	0 to 300
3	2	Gradient Y+	units/100 km (x 1000)	0 to 300
3	2	Gradient Y-	units/100 km (x 1000)	0 to 300
4	1	Physiographic Descriptor	0=sea 1=land	0 to 15
4	1	Spare	Undefined	0 to 255
4	1	Number observations	Integer	0 to 255
4	1	Age Recent Observation	Hours	0 to 255
5	2	(Weight) Wxy	Integer	0 to 32767
5	2	Class 1 Coverage	Bits	0 to 1
6	1	Spatial Covariance X+	Grid Units	0 to 10
6	1	Spatial Covariance X-	Grid Units	0 to 10
6	1	Spatial Covariance Y+	Grid Units	0 to 10
6	1	Spatial Covariance Y-	Grid Units	0 to 10
7	2	Climatological Temperature	degrees C (x 10)	-850 to +610
7	2	Spare	Undefined	0 to 32767

DEFINITION OF TERMS IN GRID INTERSECTION

Optical Thickness - The latest Aerosol Optical Thickness calculated based on the previous analysis optical thickness, weighted according to its reliability, combined with a weighted average of current observations within a surrounding area which is determined according to the grid point's gradient.

Average Gradient - The average of the gradients in all four directions (N, S, E, W) from the grid intersection.

Gradient in X+ Direction - Change in optical thickness between the grid point and neighbor points within the field in the positive direction along the X axis.

Gradient in X- Direction - Change in optical thickness in the negative direction along the X axis.

Gradient in Y+ Direction - Change in optical thickness in the positive direction along the Y axis.

Gradient in Y- Direction - Change in optical thickness in the negative direction along the Y axis.

Physiographic Descriptor - The land/sea tag indicating whether a grid intersection is a land or sea point.

Spare - Unused parameter.

Number of Observations - The total number of current observations used in the analysis of the new optical thickness for the grid intersection.

Age of Most Recent Observation - The age, in hours from the time of last analysis, of the most recent observation used to determine the new optical thickness for a grid intersection.

Reliability - New reliability associated with the new optical thickness, based on the previous reliability combined with the weighted reliability of all observations used in the last analysis.

Class 1 Temporal Coverage - Set of bits (0-15) of which bit 1 is set to 1 for each analysis which included observations with a reliability greater than or equal to a specific minimum reliability considered as class 1. Bit 0 always remains a 0, and all bits are shifted right during each analysis leaving bit 1 a 0 when no class 1 reliability observations are used for a grid intersection.

Spatial Covariance X+ - The distance in grid units from the grid intersection to the nearest land mass in the positive direction along the X axis.

Spatial Covariance X- - The distance in grid units from the grid intersection to the nearest land mass in the negative direction along the X axis.

Spatial Covariance Y+ - The distance in grid units from the grid intersection to the nearest land mass in the positive direction along the Y axis.

Spatial Covariance Y- - The distance in grid units from the grid intersection to the nearest land mass in the negative direction along the Y axis.

Independent Grid Temperature - The average sea surface temperature of a grid intersection for a particular month over a number of years, taken from the global climatology file.

Table 9.8.2.2-2 gives the row identification information. NOTE: All parameters are stored as integer values. Words 5 to 7 are the date and time at which analysis was performed.

Table 9.8.2.3-2. Row Identification Information.				
Full Word	Length (bytes)	Description	Units	Comments
1	4	Row	Integer	1-141
2	4	Spare	Undefined	n/a
3	4	Spare	Undefined	n/a
4	1	Marker	Integer	Always 255
4	3	Spare	Undefined	n/a
5	4	Hour of Day, Minutes of Hour	(100 x Hours) + Minutes	0-2359
6	4	Day of Year	Days	1-366
7	4	Year	Years	????

9.8.3 AEROSOL MONTHLY MEAN FIELD FILE

The Aerosol Monthly Mean Field File is a gridded file of optical thicknesses and other information. The optical thickness at each grid point is the average of the optical thicknesses calculated for each week within the month at that grid point. If an analyzed field was updated during the month, then it will be used in the calculation of the monthly mean.

9.8.3.1 File Structure Description

The first record is a header which contains satellite ID, the month, the year, and the number of fields used in the computation of the mean. The remaining records are data records. Each data record contains all data for one latitudinal row. The latitude range is from -70 to 70 degree. The first data record will contain data from the -70 degree latitude row and the second will contain data from the -69 degree row and so on. Each row will begin with information from the -180 degree meridian and progress eastward to the 179 degree meridian. Each grid point will contain 10 bytes of information thus each record will contain 3600 bytes.

9.8.3.2 Header Record Format

The format of the header record is contained in Table 9.8.3.2-1.

Table 9.8.3.2-1. Header Record Format.		
Halfword	Description	Comments
1	Month	1-12
2	Year	1988 - ?
3	Satellite ID	1-8
4	Number of fields used in mean calculation	1-5
5-1800	Spares	n/a

9.8.3.3 Data Record Format

Each data record represents one row of latitude with each 5 halfwords representing a specific grid point or intersection with a meridian. Table 9.8.3.2-2 shows the format of the grid intersections in the data record.

Table 9.8.3.3-1. Grid intersection format.		
Halfword	Description	Comments
1	Average Optical Thickness	0 to2440, -999=land
2	Maximum Weekly Optical Thickness for the Month	0 to2440, 0=land
3	Minimum Weekly Optical Thickness for the Month	0 to2440, 0=land
4	Number of weekly field values which were analyzed from at least 1 retrieval which was less than 8 days old.	0 to 5, 0=land
5	Spare	n/a

9.8.4 AEROSOL OPTICAL THICKNESS 8-DAY OBSERVATION FILE

The Aerosol Observation File contains eight days of Sea Surface Temperature (SST) retrievals containing a single-channel (AVHRR Channel 1) optical thickness parameter τ^A . The SSTs in these retrievals are "aerosol-corrected" SSTs, but the uncorrected SSTs are also contained within the observation. The layout of the file is identical to the SST 8-day observation file with the

exception that the 2-bytes used to store a water vapor parameter in the SST retrieval are used for an aerosol optical thickness value and a spare area is used for the uncorrected SST. This data file consists of 4,002 physical records each with a length of 13,024 bytes.

9.8.4.1 File Structure Description

The organization of the file is as follows: earth is divided into 5 degree by 5 degree blocks and by 1 degree by 1 degree subblocks within each block. The blocks are numbered from 1 to 2592 with the origin or first block at 180 degrees West (or -180) and 90 degrees South (or -90). Block numbers increase by 1 to the east and by 72 to the north. To locate information in an area, the block number is found which corresponds to the block encompassing the area. A table in the directory record points to the record which contains the desired block. After locating the record containing the block, another table at the beginning of the record locates the proper location of the desired subblock.

The file has overflow records and as such expands and contracts as data are available.

The first record is the directory record containing the block directory and other information. All other records are data records, each containing a subblock directory followed by observations.

9.8.4.2 Directory Record Format

This record describes the size, origin and location of the blocks making up the file. To calculate the block number of a location (ILAT, ILON) use the following formula:

$$IBLOCK = \left(\frac{ILAT - LA}{LAO} \times INBC \right) + \left(\frac{ILON - LO}{LOO} \right) + 1$$

where,

INBC = Number of Column Blocks = 360/LOO,

LA = Latitude origin of file = -90,

LO = Longitude origin of file = -180,

LAO = Size of block in latitudinal direction in degrees = 5,

LOO = Size of block in longitudinal direction in degrees = 5,

ILAT = Latitude (+N, -S) and

ILON = Longitude (+E, -W).

To find INTEGER ILAT and ILON, round up if positive and down if negative. Each block includes the minimum whole latitude and longitude and excludes the maximum whole latitude and longitude which border the block. For example: The limits of block 1 are -90.0 to -85.01 and -180.0 to -175.01.

Table 9.8.4.2-1 contains the format of the directory record.

Table 9.8.4.2-1. Format of Directory Record.		
Halfword	Description	Comments
1	Latitude Origin	-90
2	Longitude Origin	-180
3	Size of block in latitudinal direction	in degrees (currently 5)
4	Size of block in longitudinal direction	in degrees (currently 5)
5	First free record pointer	Points to first available record
6	Number of records in file	Currently 4002
7	Halfword number of start of block directory table	Currently 11
8	Day of year of latest data	1-366
9	File availability	0=available 1=unavailable update in progress
10	Year of century of latest data	0-99
11	Record number for block 1	2-4002
12	Record number for block 2	0 if no data in block

9.8.4.3 Data Record Format

Table 9.8.4.3-1 contains the format of the data record.

Table 9.8.4.3-1. Data Record Format.		
Halfword	Description	Comments
1	Record number	2 to 4002
2	Block number	1 to 2592
3	Extent number (# of records) removed from primary	0 if primary

4	Pointer to succeeding overflow record. Last overflow record points to primary.	0 if no overflow.
5	Pointer to halfword position of start of observation data	currently 61
6	Pointer to start of subblock directory	currently 11
7	Lower left latitude of block	degrees
8	Lower left longitude of block	degrees
9	Pointer to last halfword containing data	If no data in the record, this pointer points to the start position of observation data -1
10	Unused	
11	Halfword of start of data for subblock #1	0 if no data for this subblock in this record
12	Halfword of end of data for subblock #1	0 if no data for this subblock in this record. Other extents may or may not contain data for this subblock.
13-60	Similar to halfwords 11 and 12 for remaining subblocks.	Similar to halfwords 11 and 12 for remaining subblocks.
61-6512	Observation data	n/a

If the observations for a block cannot fit in one record, as many additional records (extents) are allocated as needed. Each additional record having the subdirectory and subdocumentation is included. If the subblock is known to be empty for the current record, the start and end position contain a zero. Subblocks may cross record boundaries. If an entire subblock cannot fit into one record, it will be split and a new record is allocated for the remainder of the subblock. Unused portions of the records containing no data are zero filled.

Given IX longitude and IY latitude, the subblock number (SBN) can be calculated as follows:

$$SBN = (IY - LLA) \times LOO + IX - LLL + 1$$

This assumes all subblocks are one degree boxes. Here LLA and LLL are respectively the lower left latitude and longitude for the 5 degree blocks.

Simplifying the above equation:

$$SBN = (IY \times LOO) + IX + C$$

where,

$$C = (-LLA \times LOO) - LLL + 1$$

and has been previously determined.

9.8.4.4 Satellite Aerosol/SST Observation Format

Satellite Aerosol/SST Observations are of variable lengths with a minimum length of 28 halfwords (2-byte integer) and a maximum of 48 halfwords. The observation length must be an even number of halfwords with no odd halfword except the first halfword being negative (i.e. the sign bit is 1). The first odd halfword of an observation is always negative. Table 9.8.4.4-1 gives the format for the observations.

Table 9.8.4.4-1. Satellite Aerosol/SST Observation Format.			
Halfword #	Byte	Quantity	Range
1	1	Type of Observation (see Table 9.8.4.4-2)	129 to 255
1	2	Source of Observation (see Table 9.8.4.4-3)	0 to 255
2	3	Year of Century	0 to 99
2	4	Month of Year	1 to 12
3	5-6	Latitude (+N,-S) x 100	-9000 to 9000
4	7-8	Longitude (+E,-W) x 100	-18000 to 17900
5	9	Day of Month	1 to 31
5	10	Hour of Day	0 to 23
6	11	Minute of Hour	0 to 59
6	12	Second of Minute	0 to 59
7	13-14	Aerosol-corrected SST (degrees C x 10)	-20 to 350
8	15-16	Reliability	0 to 32767
9	17-18	Solar Zenith Angle (degrees x 10)	0 to 1800

10	19-20	Satellite Zenith Angle (degrees x 100) (Negative to left of spacecraft track, positive to right.)	-6000 to 6000
11	21-22	Analyzed Field SST (degrees C x 10)	-20 to 350
12	23-24	Internal Error (RMS x 100)	0 to 1000
13	25-26	Relative Azimuth Angle (degrees x 10)	0 to 1800
14	27-28	Climatological SST (degrees C x 10)	-20 to 350
15	29	Beginning Row of Unit Array	1 to 11
15	30	Beginning column of Unit Array	1 to 11
16	31-32	AVHRR Channel 1 Average (% x 100)	0 to 10000
17	33-34	AVHRR Channel 2 Average (% x 100)	0 to 10000
18	35-36	AVHRR Channel 3 Average (K x 100)	0 to 32767
19	37-38	AVHRR Channel 4 Average (K x 100)	0 to 32767
20	39-40	AVHRR Channel 5 Average (K x 100)	0 to 32767
21	41-42	Space View SDEV Channel 1 (% x 100)	0 to 10000
22	43-44	Space View SDEV Channel 2 (% x 100)	0 to 10000
23	45-46	Space View SDEV Channel 3 (K x 100)	0 to 32767
24	47-48	Channel 4 Blackbody Temperature (K x 100)	0 to 32767
25	49-50	Channel 5 Blackbody Temperature (K x 100)	0 to 32767
26	51-52	Algorithm Number	1011 to ?
27	53-54	Aerosol Optical Thickness x 1000	0 to 2440
28	55-56	Uncorrected SST (K x 100)	27116 to 30816
If HIRS Data is appended:			
29	57-58	HIRS Channel 1 Temperature (K x 100)	0 to 32767
30	59-60	HIRS Channel 2 Temperature (K x 100)	0 to 32767
31	61-62	HIRS Channel 3 Temperature (K x 100)	0 to 32767
32	63-64	HIRS Channel 4 Temperature (K x 100)	0 to 32767

33	65-66	HIRS Channel 5 Temperature (K x 100)	0 to 32767
34	67-68	HIRS Channel 6 Temperature (K x 100)	0 to 32767
35	69-70	HIRS Channel 7 Temperature (K x 100)	0 to 32767
36	71-72	HIRS Channel 8 Temperature (K x 100)	0 to 32767
37	73-74	HIRS Channel 9 Temperature (K x 100)	0 to 32767
38	75-76	HIRS Channel 10 Temperature (K x 100)	0 to 32767
39	77-78	HIRS Channel 11 Temperature (K x 100)	0 to 32767
40	79-80	HIRS Channel 12 Temperature (K x 100)	0 to 32767
41	81-82	HIRS Channel 13 Temperature (K x 100)	0 to 32767
42	83-84	HIRS Channel 14 Temperature (K x 100)	0 to 32767
43	85-86	HIRS Channel 15 Temperature (K x 100)	0 to 32767
44	87-88	HIRS Channel 16 Temperature (K x 100)	0 to 32767
45	89-90	HIRS Channel 17 Temperature (K x 100)	0 to 32767
46	91-92	HIRS Channel 18 Temperature (K x 100)	0 to 32767
47	93-94	HIRS Channel 19 Temperature (K x 100)	0 to 32767
48	95-96	HIRS Channel 20 Temperature (% x 100)	0 to 1000

Table 9.8.4.4-2. Aerosol/SST Observation Type Codes.

Code	Type
157	Day Operational Algorithm
158	Day Operational Algorithm in relaxed cloud mode
167	Day Test Algorithm
168	Day Test Algorithm in relaxed cloud mode

Table 9.8.4.4-3. Aerosol/SST Observation Source Codes.

Code	Source
-------------	---------------

1	NOAA-11 AVHRR
3	NOAA-14 AVHRR
100	Ship data from Navy (FNOC)
101	Buoy data from TIROS collection system
102	Fixed Weather Ship (from NMC)
103	Moving Ship with Name (from NMC)
104	Moving Ship without Name (from NMC)
105	Fixed Buoy (from NMC)
106	Drifting Buoy (from NMC)
107	XBT (from NMC)

9.8.5 AEROSOL OPTICAL THICKNESS 100-KM ANALYZED FIELD ACCUMULATION FILE

Each field accumulation file consists of an archive of one specific type of field (i.e., 100-km aerosol optical thickness). The number of fields archived at any one time depends on the size of the dataset and is given in the directory. In September 2001, the aerosol optical thickness 100-km analyzed field accumulation file which was archived monthly was replaced with an aerosol optical thickness 100-km field file archived weekly. This means that the individual field files are archived and not bundled into an accumulation file for a full month. The format of the individual fields remains the same.

9.8.5.1 File Structure Description

The first record is a directory which points the user to the position of the first record for each field archived. A pointer to the latest field entered in the file is also provided, the user must check each field to find the field for the time period of interest. The fields are concatenated together in one large file after the directory record.

9.8.5.2 Directory Record Format

Table 9.8.5.2-1 contains the format of the Directory Record.

Table 9.8.5.2-1. Directory Record Format.	
Full Word #	Quantity

1	# of records in the dataset
2	# of records in each field (NRECS)
3	# of fields in the accumulation file (NFIELDS)
4	Field number of latest field entered in accumulation file
5	Record # of first record of field #1
6	Record # of first record of field #2
4+NFIELDS	Record # of first record of field # NFIELDS

9.8.5.3 Data Record Format

The first field in the accumulation file begins at record 2. Consult the dataset format description for the aerosol optical thickness 100 km analyzed field to find the format of the field documentation record and data records. The field documentation record (the first record of each field) should be used in referencing the data records for the field since the field documentation record provides information concerning the organization, size and time period of the field. The logical record size for a field is 10,108 bytes.

9.9 **COMPREHENSIVE LARGE ARRAY-DATA STEWARDSHIP SYSTEM (CLASS)**

The Comprehensive Large Array-data Stewardship System (CLASS) is an electronic library of environmental satellite data. CLASS is NOAA's premiere on-line facility for the distribution of NOAA and US Department of Defense (DoD) Polar-orbiting Operational Environmental Satellite (POES) data and derived data products. In addition, CLASS archives and distributes data from NOAA's Geostationary Operational Environmental Satellite (GOES). Note: CLASS has replaced NOAA's Satellite Active Archive (SAA).

The CLASS User Interface is located at: <http://www.class.noaa.gov>

APPENDIX A: APT PREDICT (TBUS) BULLETIN

APT Predict (TBUS) Bulletin Code

The TBUS is a national practice code form used by the United States to transmit information for predicting the path or locating the position of polar orbiting environmental satellites. It is transmitted daily, at about 1900Z, by KWBC Washington, DC, on the Global Telecommunications Service network.

The TBUS-1 code form is used to convey information about satellites that are descending in daylight (i.e., north to south direction of travel in daytime), while the TBUS-2 code form relates to satellites that are ascending in daylight (south to north). Figure A-1 shows a schematic of the information given in TBUS-1 and TBUS-2 bulletins.

This appendix contains the code forms for TBUS-1 and TBUS-2, a list of the satellite identifiers used in TBUS messages, an explanation of code symbols, samples of an APT Predict (TBUS) bulletin and a Two Line Element message, and how they can be decoded properly.

Table A-1 contains the code symbols for the Heading and Parts I-III of the TBUS message.

Figure A-1. Schematic Representation of Information Conveyed in TBUS-1 and TBUS-2.

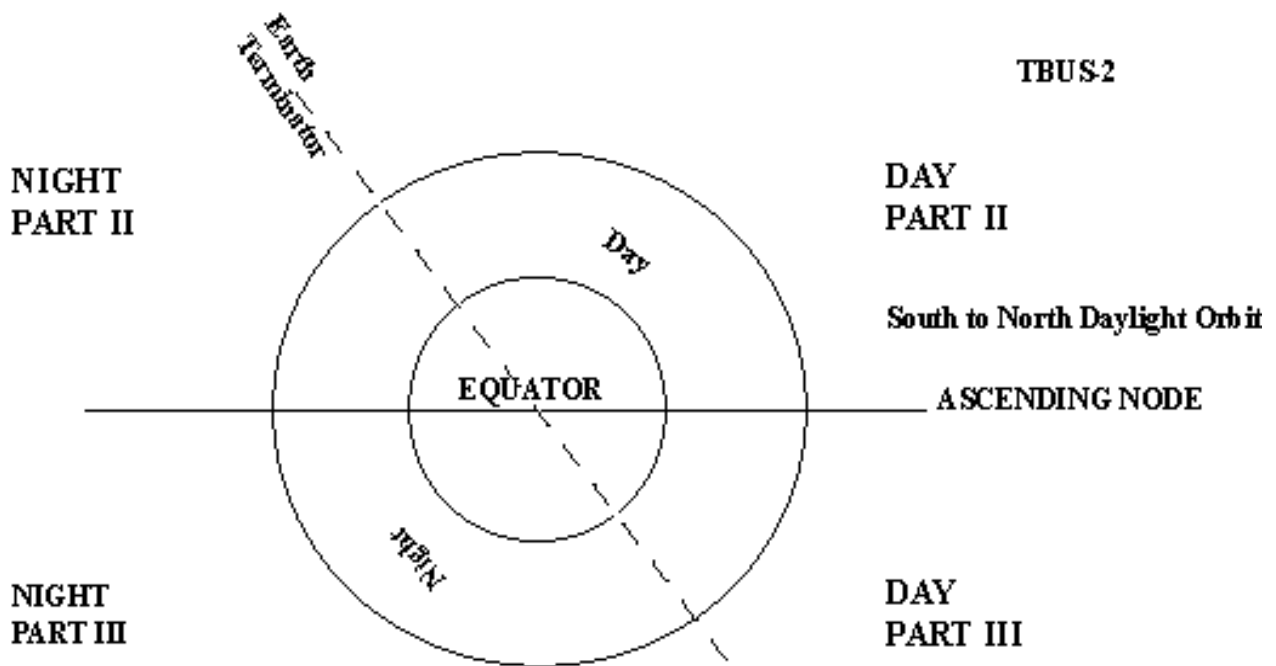
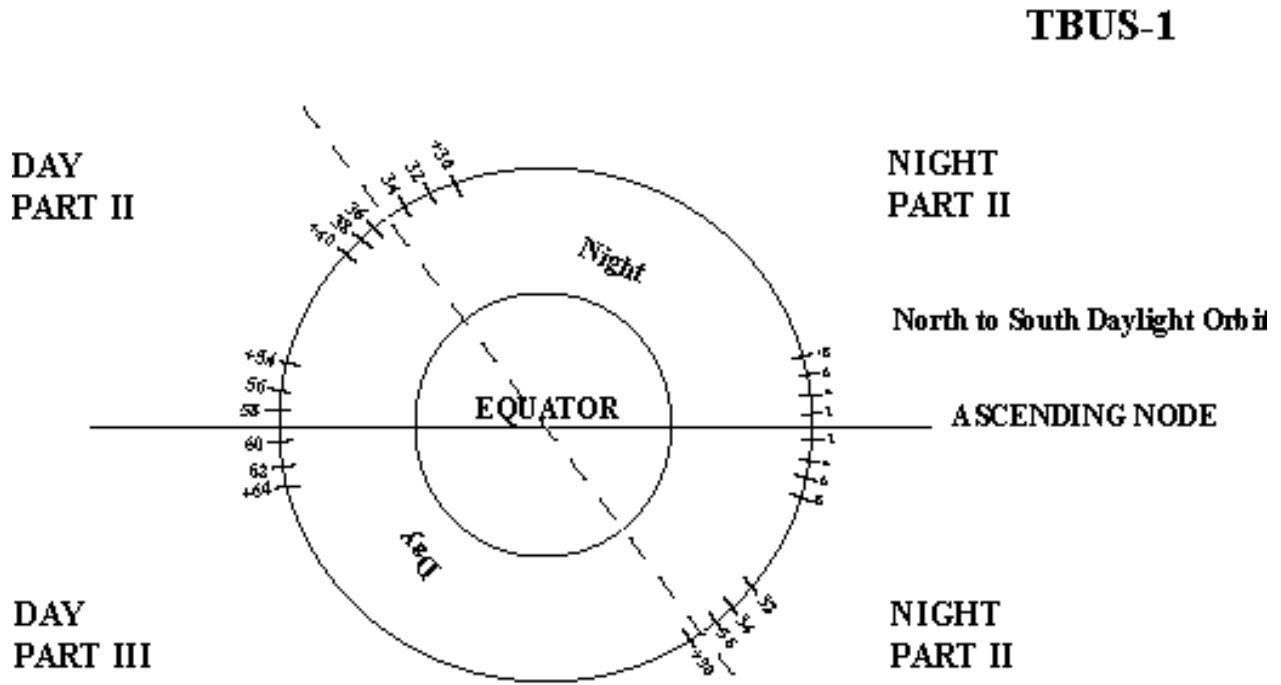

Table A-1. Code Symbols for Heading and Parts I-III.	
Code Symbol	Meaning
MM	Month
DD	Day
SS	Satellite (see Table A-2)
NNNN	Orbit number
HH	Hour
mm	Minutes
ss	Seconds
Q	Octant of Globe (see Figure A.3-1)
LoLo	Longitude (tens and units)
lolo	Longitude (tenths and hundredths)
T	Group indicator (orbital period)
L	Group indicator (nodal period)
aa	Altitude in hundreds and tens of kilometers
La	Latitude (tens)
la	Latitude (tenths)

Table A-2 contains the numbers used in TBUS bulletins to identify the satellite.

Table A-2. Satellite Identifier in TBUS Bulletins.	
Numbers	Meaning
10 - 19	ITOS series satellites
20 - 29	SMS/GOES series satellites
30	TIROS-N
31	NOAA-6
32	NOAA-7
33	NOAA-8
34	NOAA-9
35	NOAA-10
36	NOAA-11
37	NOAA-12
38	NOAA-14
34	NOAA-15
36	NOAA-16
37	NOAA-17
39	NOAA-18
40	NOAA-19

A.1 THE TBUS-1 CODE FORM

U.S. NATIONAL PRACTICE CODE TBUS-1 FOR SATELLITE EPHEMERIS PREDICT MESSAGE (DAYLIGHT DESCENDING SATELLITES)

TBUS 1 KWBC
APT PREDICT
MMDDSS

PART I

0N_rN_rN_rN_r 0D_rD_rH_rH_r 0m_rm_rs_rs_r Q_rL_oL_ol_ol_o Tmmss LL_oL_ol_ol_o

N₄N₄N₄N₄H₄ H₄h₄h₄s₄s₄ Q₄L_oL_ol_ol_o

N₈N₈N₈N₈G₈ H₈h₈h₈s₈s₈ Q₈L_oL_ol_ol_o

N₁₂N₁₂N₁₂N₁₂H₁₂ H₁₂h₁₂h₁₂s₁₂s₁₂ Q₁₂L_oL_ol_ol_o

NIGHT PART II

02a02a02Q02 L_aL_al_aL_oL_ol_o 04a04a04Q04 L_aL_al_aL_oL_ol_o

06a06a06Q06 L_aL_al_aL_oL_ol_o 08a08a08Q08 L_aL_al_aL_oL_ol_o

...and continuing north, at two-minute intervals, to day/night terminator in N. Hemisphere.

NIGHT PART III

02a02a02Q02 L_aL_al_aL_oL_ol_o 04a04a04Q04 L_aL_al_aL_oL_ol_o

06a06a06Q06 L_aL_al_aL_oL_ol_o 08a08a08Q08 L_aL_al_aL_oL_ol_o

...and continuing south, at two-minute intervals, to day/night terminator in S. Hemisphere.

DAY PART II

...begins near day/night terminator in N. Hemisphere, two minutes after last position given in NIGHT PART II, continuing south at two-minute intervals and ending close to and north of the equator, repeating the code form:

.....mma_{mm}a_{mm}Q_{mm} L_aL_al_aL_oL_ol_o

DAY PART III

...begins two minutes after last position given in DAY PART II. First two code groups give

satellite time, altitude, octant, and latitude/longitude of the first position south of the equator; following groups give the same information at two-minute intervals until spacecraft reaches day/night terminator in S. Hemisphere; repeating code form:

.....mma_{mm}a_{mm}Q_{mm} L_aL_al_aL_oL_ol_o

PART IV

AAAAAAAAA BBBB CCCCCCCCCC DDEEFFGGHHIIII JJJJJ
KKKKKKKK LLLLLLLL MMMMMMMM NNNNNNNN OOOOOOOO PPPPPPP
QQQQQQQQ RRRRRRRR SSSSSSSS TTTTTTTTTT UUUUUUUU
VVVVVVVV WWWWWWWW XXXXXXXX YYYYYYYY ZZZaaabb cccc
dddddddd eeeeeeee ffffffff gggggggg hhhhhhhh
iiiiii jjjjjj kkkkkk llllll mmmmmm nnnnnn oooooo
APT TRANSMISSION FREQUENCY XXX.XX MHZ
HRPT TRANSMISSION FREQUENCY XXXX.XX MHZ
BEACON (DSB) TRANSMISSION FREQUENCY XXX.XX MHZ
APT DAY X/X APT NIGHT X/X
DCS CLK TIME YR/DA/TIM XXXX XXX XXXXX.XXX
(ADDITIONAL PLAIN LANGUAGE REMARKS WHEN NEEDED)

A.2 THE TBUS-2 CODE FORM

U.S. NATIONAL CODE TBUS-2 FOR SATELLITE EPHEMERIS PREDICT MESSAGE
(DAYLIGHT ASCENDING SATELLITES)

TBUS 2 KWBC
APT PREDICT
MMDDSS

PART I

0N_rN_rN_rN_r 0D_rD_rH_rH_r 0m_rm_rs_rs_r Q_rL_oL_ol_ol_o Tmmss LL_oL_ol_ol_o

N₄N₄N₄N₄H₄ H₄m₄m₄s₄s₄ Q₄L_oL_ol_ol_o

N₈N₈N₈N₈H₈ H₈m₈m₈s₈s₈ Q₈L_oL_ol_ol_o

N₁₂N₁₂N₁₂N₁₂H₁₂ H₁₂m₁₂m₁₂s₁₂s₁₂ Q₁₂L_oL_ol_ol_o

DAY PART II

02a₀₂a₀₂Q₀₂ L_aL_al_aL_oL_ol_o 04a₀₄a₀₄Q₀₄ L_aL_al_aL_oL_ol_o

06a06a06Q02 LaLa1aLoLo1o 08a08a08Q08 LaLa1aLoLo1o

...and continues north, at two-minute intervals, to day/night terminator in N. Hemisphere.

DAY PART III

02a02a02Q02 LaLa1aLoLo1o 04a04a04Q04 LaLa1aLoLo1o

06a06a06Q02 LaLa1aLoLo1o 08a08a08Q08 LaLa1aLoLo1o

...and continuing south, at two-minute intervals, to day/night terminator in S. Hemisphere.

NIGHT PART II

...beginning near day/night terminator in N. Hemisphere, two minutes after last position given in DAY PART II, continuing at two-minute intervals and ending close to and north of the equator, repeating code form:

... mma_{mm}a_{mm}Q_{mm} LaLa1aLoLo1o

NIGHT PART III

...beginning two minutes after last position given in NIGHT PART II. First two code groups give satellite time, altitude, octant, and latitude/longitude of the first position south of the equator; following groups give the same information at two-minute intervals until spacecraft reaches day/night terminator in S. Hemisphere; repeating code form:

... mma_{mm}a_{mm}Q_{mm} LaLa1aLoLo1o

PART IV

... identical to the TBUS-1 code form

A.3 EXPLANATION OF CODE SYMBOLS

Table A.3-1 contains an explanation of the code symbols used for all parts of the TBUS-1 and TBUS-2 Predict messages.

Table A.3-1. Explanation of Code Symbols.	
Symbol	Explanation
TBUS-1 (or TBUS-2)	APT Bulletin originating in the United States: TBUS-1 is North to South (descending) daylight orbit. TBUS-2 is South to North (ascending) daylight orbit.
KWBC	Traffic entered at Washington, D.C.
APT PREDICT	Identifies message content.
MMDDSS	Message serial number MM - Month DD - Day of Month SS - Number of spacecraft to which predict applies (See Table A-1).
PART I - Equator crossing reference information follows:	
0	Code group indicator for first three groups
NrNrNrNr	Number of reference orbit. (Note: Information in Parts II and III also are related to this reference orbit.)
DrDrHrHrmmrsrs r	Reference orbit equator crossing time (GMT), satellite northbound: DrDr - Day of Month HrHr - Hour mmr - Minute srsr - Second
Note: In TBUS-1, northbound equator crossing takes place on NIGHT side of orbit. In TBUS-2, northbound equator crossing takes place on DAY side of orbit.	
Qr	Octant satellite is entering after crossing equator on reference orbit (See Appendix B).
LoLololo	Reference orbit equator crossing longitude in degrees and hundredths.
T	Indicator: nodal period follows (will always be shown as "T").
mm	Nodal period, minutes
ss	Nodal period, seconds. [Note: Hundreds group will not be included. example: 100 minutes 13 seconds will be coded as 0013.
L	Indicator, nodal longitude increment follows (always shown as "L").
LoLololo	Degrees and hundredths of degrees longitude between successive equator crossings.
N4N4N4N4	Orbit number of fourth orbit following reference orbit.
H4H4	Hour of northbound satellite equator crossing four orbits after reference orbit.
m4m4	Minute
s4s4	Second
Q4	Octant satellite is entering after crossing equator on fourth orbit after reference orbit.
LoLololo	Equator crossing longitude of fourth orbit after reference orbit.
Above information is repeated for eighth (N8N8N8N8) and twelfth (N12N12N12N12) orbits following reference orbit.	
NIGHT PART II (TBUS-1) or DAY PART II (TBUS-2): Contains satellite altitude and	

subpoint coordinates at two-minute intervals after time of equator crossing; satellite northbound.	
02	Indicator; satellite altitude and subpoint coordinates at two minutes after time of equator crossing.
a02a02	Altitude, in hundreds and tens of kilometers, at two minutes after equator crossing. Thousands figure understood; hence 1440 km is encoded as 44.)
Q02	Octant of globe at two minutes after equator crossing.
LaLala	Latitude of satellite subpoint in degrees and tenths of degrees at two minutes after equator crossing.
LoLolo	Longitude of satellite subpoint in degrees and tenths of degrees at two minutes after equator crossing.
Above information is repeated at two-minute intervals over the NIGHT portion of the orbit north of the equator for TBUS-1, and DAY portion of the orbit north of the equator for TBUS-2.) Note: Should the time after ascending node become greater than 99, the hundreds will be assumed (example, minute 102 will be encoded as 02).	
NIGHT PART III (TBUS-1) or DAY PART III (TBUS-2): Satellite altitude and subpoint coordinates at two-minute intervals south or equator on the ascending side of the orbit.	
02	Indicator; satellite altitude and subpoint coordinates at two minutes after time of equator crossing follows.
a02a02	Satellite altitude in hundreds and tens of kilometers at two minutes after equator crossing.
Q02	Octant of globe at two minutes after equator crossing.
LaLala	Latitude of satellite subpoint in degrees and tenths of degrees at two minutes after crossing.
L0L010	Longitude of satellite subpoint in degrees and tenths of degrees at two minutes after equator crossing.
Above information is repeated at two-minute intervals over the night portion of the orbit south of the equator for TBUS-1, and sunlight portion of the orbit north of the equator for TBUS-2.	
DAY PART II (TBUS-2) NIGHT PART II (TBUS-1): Satellite altitude and subpoint coordinates at two-minute intervals after time of equator crossing follows.	
02	Information pertinent to 02 minutes after equator crossing follows.
a02a02	Satellite altitude in hundreds and tens of kilometers at 02 minutes after equator crossing.
Q02	Octant of globe at 02 minutes after equator crossing.
LaLala	Latitude of satellite subpoint in degrees and tenths of degrees at 02 minutes after equator crossing.
L0L010	Longitude of satellite subpoint in degrees and tenths of degrees at 02 minutes after equator crossing.
Above information is repeated at two-minute intervals over the sunlit portion of the orbit north of the equator for TBUS-2, and night portion of the orbit north of the equator for TBUS-1.	
DAY PART III (TBUS-1) or NIGHT PART III (TBUS-2): Satellite altitude and subpoint coordinates at two-minute intervals south of the equator on the descending side of the orbit.	
02	Indicator: satellite altitude and subpoint coordinates at two minutes after

	time of equator crossing.
a02a02	Satellite altitude in tens of kilometers at two minutes after equator crossings.
Q02	Octant of globe at two minutes after equator crossing.
LaLala	Latitude of satellite subpoint in degrees and tenths of degrees at two minutes after equator crossing.
L0L010	Longitude of satellite subpoint in degrees and tenths of degrees at two minutes after equator crossing.
Above information is repeated at two-minute intervals over the sunlit portion of the orbit south of the equator for TBUS-1 and night portion of the orbit south of the equator for TBUS-2. Note: Should the time after ascending node become greater than 99, the hundreds will be assumed (example, minute 102 will be encoded as 02).	
PART IV: Contains high precision orbital elements transmission frequencies, and remarks - See Table A.3-2.	

In Table A.3-2, the classical elements (Keplerian) from MMMMMMMM to RRRRRRRR are Brouwer mean (BM) elements expressed in the form of Keplerian elements. The position and velocity components SSSSSSSS to XXXXXXXX are instantaneous. The Greenwich Hour Angle is apparent sidereal time.

Table A.3-2. Part IV Code Symbols.	
Symbol	Explanation
AAAAAAAAAA	Spacecraft identification (International designator)
BBBBB	Orbit number at epoch.
CCCCCCCCCCC	Time of the first ascending node, in days, from the beginning of the year, to nine decimal places.
DD	Epoch year
EE	Epoch month
FF	Epoch day
GG	Epoch hour
HH	Epoch minute
IIII	Epoch second, to three decimal places
JJJJJJ	Apparent Greenwich Hour Angle at Aries at epoch, to four decimal places.
KKKKKKKK	Anomalistic period (minutes), to four decimal places.
LLLLLLLL	Nodal period (minutes), to four decimal places.
MMMMMMMM	BM Eccentricity, eight decimal places.
NNNNNNNN	BM Argument of perigee (degrees), five decimal places.
OOOOOOOO	BM Right Ascension of the ascending node (degrees), five decimal places.
PPPPPPPP	BM Inclination (degrees), five decimal places.
QQQQQQQQ	BM Mean anomaly (degrees), five decimal places.
RRRRRRRR	BM Semi-major axis (km), three decimal places.
Note: All signed values in Part IV are preceded by a "P" or "M" to denote a plus (+) or minus	

(-) value.	
SSSSSSSSSS	Sign and epoch X position component (km), to four decimal places.
TTTTTTTTTT	Sign and epoch Y position component (km), to four decimal places.
UUUUUUUUUU	Sign and epoch Z position component (km), to four decimal places.
VVVVVVVVVV	Sign and epoch X velocity (Xdot) component (km/sec), to six decimal places.
WWWWWWWW	Sign and epoch Y velocity (Ydot) component (km/sec), to six decimal places.
XXXXXXXXXX	Sign and epoch Z velocity (Zdot) component(km/sec), to six decimal places.
YYYYYYYYYY	Ballistics coefficient CD-A/M (m ² /kg), to eight decimal places.
ZZZ	Daily solar flux value (10.7 cm) 10 ⁻⁷ W/m ² .
aaa	90-day running mean of solar flux 10 ⁻⁷ W/m ² .
bbb	Planetary magnetic index (2x10 ⁻⁵ gauss).
cccc	Drag modulation coefficient, to four decimal places.
dddddddddd	Radiation pressure coefficient (m ² /kg), to ten decimal places.
eeeeeeeee	Sign and perigee motion (degrees/day), to five decimal places.
fffffffff	Sign and motion of Right Ascension of the ascending node (degrees/day), to five decimal places.
gggggggggg	Sign and rate of change of mean anomaly at epoch (degrees/day), to two decimal places.
hhhhhhhh	Equator crossing longitude of the epoch reference orbit measure as East longitude, to five decimal places.
iiiiii	Month, date and year (MMDDYY) of last TIP clock correction.
jjjjj	Sign and clock error after last correction measured in seconds, to three decimal places. *
kkkkkk	Month, date and year (MMDDYY) of current clock error.
lllll	Sign and current clock error measured in seconds, to three decimal places. *
mmmmmm	Month, date and year (MMDDYY) of the measured clock error rate.
nnnnnn	Sign and clock error rate expressed as milliseconds/day. *
oooooo	Month, date and year (MMDDYY) of next TIP clock correction. (000000 if unknown.)
* These will be set to 99999 if the value is unknown. Note: All signed values in Part IV are preceded by a “P” or “M” to denote a plus (+) or minus (-) value.	

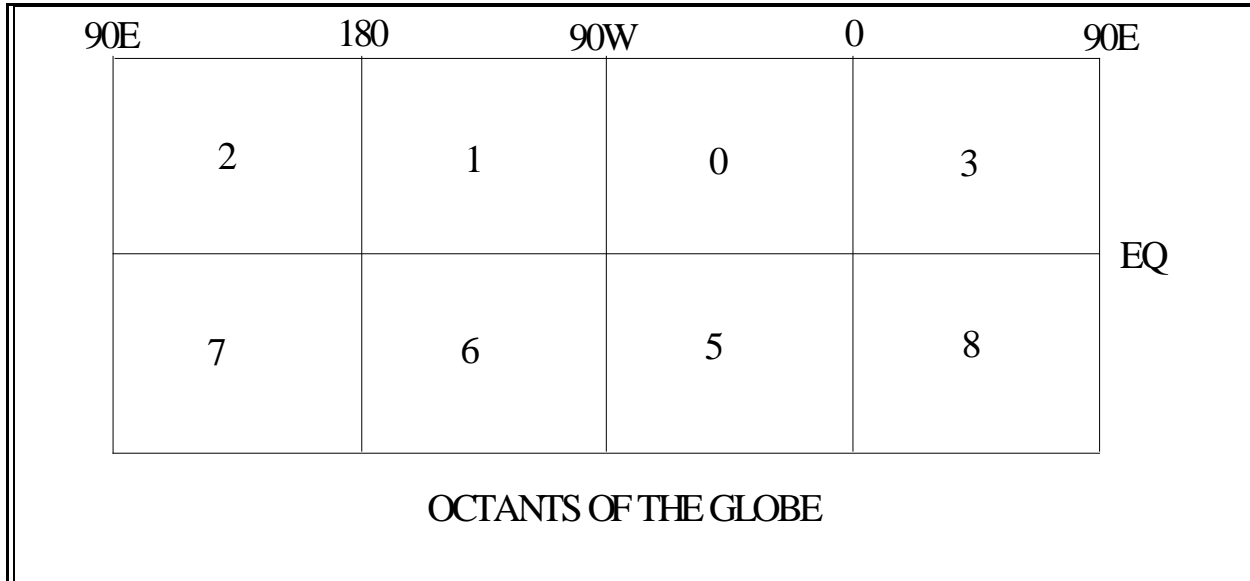

Figure A.3-1. Global Octant Map

A.4 SAMPLE APT PREDICT (TBUS) BULLETIN

The following encoded APT Predict (TBUS) Bulletin example is referred to throughout the remaining sub-appendices. The major features of the message are decoded in Table A.5-1.

```

TBUS 2 KWBC 271900
APT PREDICT
022737 NOAA 12
PART I
05271 02718 05148 01022 T0115 L2531
52750 13652 11149
52790 82156 24723
52831 50700 34596
NIGHT PART II
02810 070117 04820 141133 06820 211150 08820 282168
10820 352187 12820 422210 14830 491236 16830 560270
18830 628316 20830 694386 22830 755511 24830 803772
26831 811225 28831 773557 30831 714712
NIGHT PART III
02815 070086 04815 141070 06825 212054 08825 282036
10825 352016 12828 422005 14828 492032 16838 560066
18838 628112 20838 694182 22838 755307
DAY PART II
32831 649795 34832 582752 36832 514715 38822 444687
40822 375663 42822 304643 44822 234624 46822 164607
48812 093591 50812 022576

```

DAY PART III

52817 048560 54817 118544 56827 189528 58827 259511
 60827 330492 62827 400470 64827 469445 66827 538414
 68837 607373 70837 673312 72837 736211 74837 790006
 76838 815596 78838 788195 80835 734001

PART IV

1991 032A 35260 058012410488 980227001752266 1611059
 01012050 01012668 00124135 27260918 06938332 09853018
 08737459 07191220 P025340217 P067357065 P000000000
 P01033198 M00387576 P07361891 003003246 094096008 9449
 0000500000 M00312884 P00096864 P00512228 26827739
 123195 M00100 020998 M00100 020198 M00002 000000
 APT 137.50 MHZ, HRPT 1698.0 MHZ, BCN DSB 136.77 MHZ. APT DAY/NIGHT
 CH 2,4/3,4. VIS CH 2 /0.725 TO 1.0/ AND IR CH 4 /10.5 TO 11.5/ XMTD
 DURING S/C DAY. IR CH 3 /3.55 TO 3.93/ AND IR CH 4 /10.5 TO 11.5/
 XMTD DURING S/C NIGHT. DCS CLK YR/DAY/TIME 1994 185 69079.016
 LAST TIP CLK CORR 12/31/95 CLK ERR AFTER CORR MINUS 0.1 SEC. CLK ERR AS
 OF 02/09/98 MINUS 0.1 SEC. ERR RATE AS OF 02/01/98
 MINUS 2 MS/DAY(ESTIMATED). NO CLK CORRECTION SCHEDULED.
 NNNN

A.5 DECODING EXERCISE

Table A.5-1. Decoding Exercise of Sample APT Predict (TBUS) Bulletin from Section A.4.	
Line from TBUS	Explanation
TBUS2 KWBC 271900	
TBUS2	Bulletin heading--identifies bulletin for satellite northbound in daylight
KWBC	Bulletin source--Washington, D.C. Communications Center
271900	27 -Day of the month (21st) 1900 -Bulletin time (1900 UTC)
APT PREDICT	Bulletin identifier
022737 NOAA 12	
022737	0227 - Date for which bulletin applies, Feb. 27 37 - Satellite identifier (Table A-2)
NOAA 12	Plain language satellite identifier
PART I	Identifies reference orbit information and the equator crossing time and equator crossing longitude for the fourth, eighth and twelfth orbits after the reference orbit.
05271 02718 05148 01022 T0115 L2531	
05271	0 - Group indicator 5271 - Reference orbit number

02718	0 - Group indicator 27 - Day of month of equator crossing 18 - Hour
05148	0 - Group indicator 51- Minute 48 - Seconds (equator crossing 18:51:48 UTC)
01022	0 - Octant 0 (0 to 90W degrees), N. Hemisphere 1022 - 010.22W (equator crossing)
T0115	T - Group indicator 0115 - Orbital period 101 minutes 15 seconds
L2531	L - Group indicator 2531 - Nodal longitudinal increment 25.31 degrees
52750 13652 11149	
52750 13652	5275 - Orbit number 5275 (4th orbit after reference orbit) 013652 - Time (01:36:52Z) of ascending node for orbit 5275
11149	1 - Octant 1 (90W to 180 degrees) 1149 - 111.49W (equator crossing for orbit 5275 in octant 1)
52790 82156 24723	Decoded in same manner as previous line of data
52831 50700 34596	Decoded in same manner as previous line of data
NIGHT PART II	Satellite altitude and subpoint coordinates at two-minute intervals beginning at the day/night terminator in the N. Hemisphere and continuing southward toward the equator.
02810 070117 04820 141133	
02810	02 - Minute 02 after northbound equator crossing 81 - Spacecraft altitude 810 km 0 - Octant 0 (0 - 90W degrees) N. Hemisphere
070117	070 - Latitude 7.0N 117 - Longitude 11.7E
04820	04- Minute 04 after equator crossing 82 - Spacecraft altitude 820 km 0 - Octant 0 (0 - 90W degrees) N. Hemisphere
141133	141 - Latitude 14.1N 133 - Longitude 13.3E
Remainder of NIGHT PART II decoded in same manner. Data continues at 2 minute intervals.	
NIGHT PART III	Satellite altitude and subpoint coordinates at two-minute intervals south of the equator on the descending side of the orbit.
02815 070086 04815 141070	
02815	02 - Minute 02 after Northbound equator crossing 81 - Spacecraft altitude 810 km 5 - Octant 5 (0 - 90W degrees) S Hemisphere
070086	070 - Latitude 07.0S 086 - Longitude 08.6E

04815	04 - Minute 04 after equator crossing 81 - Spacecraft altitude 810 km 5 - Octant 5 (0 -90W degrees) S Hemisphere	
141070	141 - Latitude 14.1S 070 - Longitude 7.0E	
Remainder decoded in same manner. Data continues at 2-minute intervals from first point South of equator to Southern terminator.		
DAY PART II	Contains satellite altitude and subpoint coordinates at two-minute intervals after time of Northbound (ascending) equator crossing.	
32831 649795 34832 582752		
32831	32 - Minute 32 after Northbound equator crossing 83 - Spacecraft altitude 830 km 1 - Octant 1 (90W to 180W degrees) N. Hemisphere	
649795	649 - Latitude 64.9N 795 - Longitude 079.5W	
34832	34 - Minute 34 after Northbound equator crossing 83 - Spacecraft altitude 830 km 2 - Octant 2 (90E to 180E) N. Hemisphere	
582752	582 - Latitude 058.2N 752 - Longitude 75.2W	
Remainder of DAY PART II decoded in same manner. Data for DAY PART II are continuous at 2-minute intervals from equator North to Northern terminator.		
DAY PART III	Satellite altitude and subpoint coordinates at two-minute intervals south of the equator. Satellite Northbound in the Southern hemisphere (points are plotted Southward from the equator).	
52817 048560 54817 118544		
52817	52 - Minute 52 before Northbound equator crossing 81 - Spacecraft altitude 810 km 7 - Octant 7 (90E to 180E degrees) S. Hemisphere	
048560	048 - Latitude 04.8S 560 - Longitude 056.0W	
54817	54 - Minute 54 after equator crossing 81 - Spacecraft altitude 810 km 7 - Octant 7 (90E to 180E degrees) S. Hemisphere	
118544	118 - Latitude 11.8S 544 - Longitude 54.4W	
Remainder of DAY PART III decoded in same manner		
PART IV	Indicator -- orbital elements, transmission frequencies, and remarks follow.	
AAAAAAAAA	1991 032A	1991-032A International designator for NOAA-12
BBBBB	35260	revolution 35260

CCCCCCCCCCCC	058012410488	058.012410488 days
DDEEFFGGHHIIII	980227001752266	98--1998 year 02-02 months 27-27 days 00-00 hours 17-17 minutes 52266--52.266 seconds
JJJJJJ	1611059	161.1059 degrees
KKKKKKKK	01012050	101.2050 minutes
LLLLLLLL	01012668	101.2668 minutes
MMMMMMMM	00124135	0.00124135 no units
NNNNNNNN	27260918	272.60918 degrees
OOOOOOOO	06938332	69.38332 degrees
PPPPPPP	09853018	98.53018 degrees
QQQQQQQ	08737459	87.37459 degrees
RRRRRRRR	07191220	7191.220 km
SSSSSSSSS	P025340217	+2534.0217 km
TTTTTTTTT	P067357065	+06735.7065 km
UUUUUUUUU	P00000000	+0.0000 km
VVVVVVVVV	P01033198	+1.033198 km/sec
WWWWWWWWW	M00387576	-0.387576 km/sec
XXXXXXXXXX	P07361891	+7.361891 km/sec
YYYYYYYYY	003003246	0.03003246 m2/kg
ZZZaaabbb	094096008	094--94 x 10 ⁻⁷ W/m2 096--96 x 10 ⁻⁷ W/m2 008-- 8 x 10 ⁻⁵ gauss
cccc	9449	0.9449 no units
dddddddddd	0000500000	0.0005000000 m2/kg
eeeeeeee	M00312884	- 3.12884 degrees/day
fffffffff	P00096864	+0.96864 degrees/day
ggggggggg	P00512228	+5122.28 degrees/day
hhhhhhh	26827739	268.27739 degrees East longitude
iiiiii	123195	12-month, 31-date, 95-year
jjjjj	M00100	-0.100 seconds
kkkkkk	020998	02-month, 09-date, 98-year
lllll	M00100	-0.100 seconds
mmmmmm	020198	02-month, 01-date,

		98-year
nnnnnn	M00002	-2 milliseconds/day
oooooo	000000	Date of next clock correction is unknown.
PLAIN LANGUAGE PART OF MESSAGE: APT 137.50 MHZ, HRPT 1698.0 MHZ, BCN DSB 136.77 MHZ. APT DAY/NIGHT CH 2,4/3,4. VIS CH 2 /0.725 TO 1.0/ AND IR CH 4 /10.5 TO 11.5/ XMTD DURING S/C DAY. IR CH 3 /3.55 TO 3.93/ AND IR CH 4 /10.5 TO 11.5/ XMTD DURING S/C NIGHT. DCS CLK YR/DAY/TIME 1994 185 69079.016 LAST TIP CLK CORR 12/31/95 CLK ERR AFTER CORR MINUS 0.1 SEC. CLK ERR AS OF 02/09/98 MINUS 0.1 SEC. ERR RATE AS OF 02/01/98 MINUS 2 MS/DAY(ESTIMATED). NO CLK CORRECTION SCHEDULED.		
NNNN	NNNN	Indicates end of message

A.6 NASA TWO LINE ORBITAL ELEMENTS (TLE)

A description of the NASA prediction bulletin's two line, orbital element set format is explained in the following example.

Data for each satellite consists of three lines (two of which contain actual orbital elements) in the following format:

AAAAAAAAAAAAAAAAAAAAA

1 NNNNNU NNNNNAAA NNNNN.NNNNNNNN +.NNNNNNNN +NNNNN-N +NNNNN-N N
NNNNN

2 NNNNN NNN.NNNN NNN.NNNN NNNNNNN NNN.NNNN NNN.NNNN
NN.NNNNNNNNNNNNNNN

Line 0 is a twenty-two-character name. Lines 1 and 2 are the standard Two-Line Orbital Element Set Format identical to that used by USSC and NASA. The format is described in Table A.6-1.

Table A.6-1. Format of Standard Two-Line Orbital Element Set.	
Column	Description
Line 1	
01-01	Line Number of Element Data
03-07	Satellite Number
10-11	International Designator (Last two digits of launch year). See Table A.6-2.
12-14	International Designator (Launch number of the year). See Table A.6-2.
15-17	International Designator (Piece of launch). See Table A.6-2.
19-20	Epoch Year (Last two digits of year)
21-32	Epoch (Julian Day and fractional portion of the day)
34-43	First Time Derivative of the Mean Motion or Ballistic Coefficient (depending on ephemeris type)
45-52	Second Time Derivative of Mean Motion (decimal point assumed; blank if N/A)
54-61	BSTAR drag term if GP4 general perturbation theory was used. Otherwise, radiation pressure coefficient. (Decimal point assumed)
63-63	Ephemeris type
65-68	Element Number
69-69	Check Sum (Modulo 10)
Line 2	
01-01	Line Number of Element Data
03-07	Satellite Number
09-16	Inclination (degrees)
18-25	Right Ascension of the Ascending Node (degrees)
27-33	Eccentricity (decimal point assumed)
35-42	Argument of Perigee (degrees)
44-51	Mean Anomaly (degrees)
53-63	Mean Motion (revolutions per day)
64-68	Revolution number at epoch (revolutions)
69-69	Check Sum (Modulo 10)
Note: All other columns are blank or fixed.	

Table A.6-2. Definition of Satellite ID and International Designator.		
Satellite name	Satellite ID (USSC)	International Designator (Launch year and day)
NOAA-1	04793	7€1€6
NOAA-2	06235	72€82
NOAA-3	06920	73€86
NOAA-4	07529	74€89
NOAA-5	09057	76€77
TIROS-N	11060	78096
NOAA-6	11416	79057

NOAA-7	12553	81059
NOAA-8	13923	83022
NOAA-9	15427	84123
NOAA-10	16969	86073
NOAA-11	19531	88089
NOAA-12	21263	91032
NOAA-13	22739	93050
NOAA-14	23455	94089
NOAA-15	25338	98030
NOAA-16	26536	00055
NOAA-17	27453	02032
NOAA-18	28654	05018
NOAA-19	33591	09005
€ indicates a blank		

A.7 EXAMPLE OF DECODED TWO LINE ORBITAL ELEMENT MESSAGE

The following is an example of a two-line orbital element message:

```
NOAA 14
1 23455U 94089A 95222.82483495 .00000053 00000-0 53646-4 0 2755
2 23455 98.9047 164.9161 0010620 42.0812 318.1174 14.11526152 31526
```

This example has been decoded in Table A.7-1.

NOAA-14	Satellite name ANOAA-14"
1 23455U	1 - Message line 1 23455 - Satellite number 23455
94089A	94 - Launch year 1994 089 - Launch number 89 A - Launch piece A (not in multiple pieces)
95222.82483495	95 - Epoch year 1995 222.82483495 - Julian day 222 and fraction
.00000053	First time derivative of the mean motion (plus sign implied)
00000-0	Second time derivative of the mean motion
53646-4	BSTAR drag term
0	Ephemeris type zero
2755	Element number 275 5 - Check sum
2 23455	2 - Message line 2 223455 - Satellite number 23455 (repeated)
98.9047	Orbit inclination 98.9047 degrees
164.9161	Right ascension of ascending node 164.9161 degrees

0010620	Eccentricity .0010620
42.0812	Argument of perigee 042.0812 degrees
318.1174	Mean anomaly 318.1174 degrees
14.11526152	Mean motion 14.11526152 revolutions per day
31526	3152 - Satellite revolution 3152 at epoch 6 - Check sum

APPENDIX B: USING BROUWER-MEAN ELEMENTS FROM TBUS PART IV

The Brouwer-mean elements in part IV of the APT predict bulletin (TBUS) can be used in a stand-alone Brouwer-Lyddane orbit prediction package to determine orbit position information at any time $(t-t_0)$ where t_0 represents the time of the Brouwer mean elements in part IV and t represents the user request time. The Brouwer-Lyddane algorithm is an analytical solution of satellite motion for a simplified disturbing potential field limited to zonal harmonic coefficients for J_2 through J_5 . Lyddane modified Brouwer's formulation to obtain algorithms applicable for zero eccentricity and zero inclination.

The Brouwer-Lyddane orbit prediction package contains seven subroutines and one block data subprogram which can be called from a user supplied driver to obtain orbit information in the form desired by the user.

The first subroutine to be called is BROLYD. This subroutine takes as input the Brouwer mean or osculating elements at time t_0 , and outputs the osculating Keplerian and Brouwer mean elements at the time $(t-t_0)$ given in common block BLCNST. The calling sequence for subroutine BROLYD is described below.

If users require output in the form of inertial position and velocity vectors then a second subroutine CELEM can be called. This subroutine takes as input the osculating Keplerian elements for BROLYD and outputs the inertial position and velocity vectors. The calling sequences for subroutine CELEM is also described below.

A third subroutine, BFIXED, transforms the position and velocity vectors from CELEM to earth fixed coordinates. The user must supply the Greenwich hour angle to this subroutine.

Subroutine XYZPLH converts the position vector in the earth fixed coordinates to geodetic latitude, east longitude, and height.

Three other subroutines are included in this prediction package. These are DKEPLR, MA3331, and DATAN0. DKEPLR is a subroutine to solve Kepler's equation. MA3331 computes the product of a 3X3 matrix and a 3X1 matrix. DATAN0 computes a value for the arc-tangent between 0 and 2π .

A block data subprogram for the common block BLCNST includes several constants needed by the stand-alone orbit prediction package. These constants are described below and are presently used in NESDIS's polar navigation system.

CALLING SEQUENCE FOR SUBROUTINE BROLYD:

CALL BROLYD (OSCELE, DPELE, IPERT, IPASS, IDMEAN, ORBEL)

ARGUMENTS:

OSCELE - OUTPUT OSCULATING ELEMENTS AT TIME TTO

OSCELE (1) = SEMI-MAJOR AXIS
OSCELE (2) = ECCENTRICITY
OSCELE (3) = INCLINATION
OSCELE (4) = NODE
OSCELE (5) = ARGUMENT OF PERIGEE
OSCELE (6) = MEAN ANOMALY

DPELE - INPUT IS OSCULATING ELEMENTS AT EPOCH IF IDMEAN = 0
INPUT IS BROUWER MEAN AT EPOCH IF IDMEAN \neq 0
OUTPUT ELEMENTS ARE BROUWER MEAN AT TIME TTO

DPELE (1) = SEMI-MAJOR AXIS
DPELE (2) = ECCENTRICITY
DPELE (3) = INCLINATION
DPELE (4) = NODE
DPELE (5) = ARGUMENT OF PERIGEE
DPELE (6) = MEAN ANOMALY

IDMEAN - DETERMINES WHICH ELEMENTS ARE INPUT IN DPELE
= 0, OSCULATING
 \neq 0, BROUWER MEAN

IPASS =1, COMPUTE CONSTANTS NEEDED IN COMPUTATION OF OSCULATING ELEMENTS
=2, UPDATE OSCULATING ELEMENT TO OBSERVATION TIME WITHOUT UPDATING CONSTANTS

IPERT =0, NO PERTURBATIONS DUE TO OBLATENESS COMPUTED
=1, SECULAR TERMS COMPUTED
=2, SECULAR + LONG PERIODIC + SHORT PERIODIC TERMS

ORBEL - OUTPUT AUXILIARY ORBITAL ELEMENTS

CALLING SEQUENCE FOR SUBROUTINE CELEM:

CALL CELEM (ORBEL, GMC, PV, VV)

ARGUMENTS:

ORBEL - INPUT OSCULATING ELEMENTS

ORBEL (1) = SEMI-MAJOR AXIS

ORBEL (2) = ECCENTRICITY

ORBEL (3) = INCLINATION

ORBEL (4) = NODE

ORBEL (5) = ARGUMENT OF PERIGEE

ORBEL (6) = MEAN ANOMALY

GMC - INPUT GRAVITATIONAL CONSTANT

PV - OUTPUT CARTESIAN POSITION VECTOR

PV (1) = X

PV (2) = Y

PV (3) = Z

VV - OUTPUT CARTESIAN VELOCITY VECTOR

VV (1) = XDOT

VV (2) = YDOT

VV (3) = ZDOT

COMMON BLOCK BLCNST

COMMON/BLCNST/TTO, R, AE, GM, BJ2, BJ3, BJ4, BJ5, FLTINV, XKE, ESQ

VARIABLES USED IN COMMON/BLCNST/:

TTO - INPUT REQUEST TIME IN SECONDS FROM EPOCH

R - OUTPUT MAGNITUDE OF SATELLITE RADIUS VECTOR

AE - INPUT MEAN EQUATORIAL RADIUS OF THE EARTH (KM)

GM - INPUT GRAVITATIONAL CONSTANT OF THE EARTH (KM³/SEC²)

BJ2 - INPUT C_{2,0} ZONAL HARMONIC COEFFICIENT

BJ3 - INPUT C_{3,0} ZONAL HARMONIC COEFFICIENT

BJ4 - INPUT C_{4,0} ZONAL HARMONIC COEFFICIENT

BJ5 - INPUT C_{5,0} ZONAL HARMONIC COEFFICIENT

FLTINV - INPUT INVERSE FLATTENING COEFFICIENT (1/F)

XKE - GRAVITATIONAL CONSTANT (EARTH RADII)^{3/2}/MIN)

ESQ - THE SQUARE OF THE MAJOR ECCENTRICITY CALCULATED FROM
 $e^2=(2f-f^2)$

```

C*****
00000010
C
00000020
C                                NAME                -                AMMSMA
00000030
C                                LANGUAGE    -    FORTRAN                TYPE    -    SUBROUTINE
00000040
C    VERSIONS    -    1.0                DATE    -    07/01/81                PROGRAMMER    -    T.LIU
00000050
C
00000060
C                                FUNCTIONS:
00000070
C                                TO CALCULATE THE AVERAGE MEAN MOTION AND THE SEMIMAJOR
00000080
C                                AXIES.
00000090
C                                INPUT                PARAMETERS:
00000100
C                                COMMON/DATA2/.....
00000110
C                                OUTPUT                PARAMETERS:
00000120
C                                DMEAN    -    AVERAGE    MEAN    MOTION
00000130
C                                BMELMT(1)    -    SEMIMAJOR    AXIES
00000140
C
00000150
C                                SUBROUTINES                CALLED:                NONE
00000160
C*****
00000200
SUBROUTINE                                AMMSMA(DMEAN,BMELMT)
00000210
IMPLICIT                                REAL*8                                (A-H,O-Z)
00000220
COMMON/DATA2/                                DESIGI,EPTIME,DMMDT,D2MDT,
00000230
1                                DRAGT,IETYPE,NELSET,DINCL,RASC,ECC,ARGP,DMEANA,
00000240
2                                DMMOT,IREVNO,ISATNO
00000250
REAL*8                                BMELMT(6)
00000260
COMMON/BLCNST/                                TTO,R,AE,GM,BJ2,BJ3,BJ4,BJ5,FLTINV,XKE,ESQ
00000261
DATA                                TOTHRD,RE,DEGRAD/0.66666667,1.,0.01745329252D0/
00000270
DATA                                TWOPI/6.2831853/
00000290
DATA                                XMNPDA/1440./

```

```

00000295
      XJ2=-BJ2
00000299
      CK2=.5*XJ2*RE**2
00000300
      TEMP=TWOPI/XMNPDA/XMNPDA
00000320
      DMEN=DMMOT*TEMP*XMNPDA
00000350
      RINCL=DINCL*DEGRAD
00000400
      A1=(XKE/DMEN)**TOTHRD
00000500
      COSIO=DCOS(RINCL)
00000600
      THETA2=COSIO*COSIO
00000700
      X3THM1=3.*THETA2-1.
00000800
      EOSQ=ECC*ECC
00000900
      BETAO2=1.-EOSQ
00001000
      BETAO=DSQRT(BETAO2)
00001100
      DEL1=1.5*CK2*X3THM1/(A1*A1*BETAO*BETAO2)
00001200
      AO=A1*(1.-DEL1*(.5*TOTHRD+DEL1*(1.+134./81.*DEL1)))
00001300
      DELO=1.5*CK2*X3THM1/(AO*AO*BETAO*BETAO2)
00001400
      DMEAN=DMEN/(1.+DELO)
00001500
      DSEMI=AO/(1.-DELO)
00001600
      BMELMT(1)=DSEMI*AE
00001650
      RETURN
00001700
      END
00001800

```

```

SUBROUTINE BFIXED(KEY,GHA,PV,VV,POSOUT,VELOUT,B)
IMPLICIT REAL*8 (A-H, O-Z)
C*****C
C NAME - BFIXED
C
C LANGUAGE- FORTHXP TYPE- SUBROUTINE
C
C VERSION- 1.0 DATE- 10/14/77 PROGRAMMER- SACHS, A.
C
C PURPOSE -TRANSFORM THE POSITION AND VELOCITY FROM TOD TO
C PSUEDO BODY FIXED.
C
C INPUT PARAMETERS - KEY= 3 FOR RETURN OF BODY FIXED POSITION
C ONLY, GHA= GREENWICH HOUR ANGLE IN RADIANS, PV= POSITION VECTOR,
C VV= VELOCITY VECTOR (KM/SEC).
C
C OUTPUT PARAMETERS - POSOUT =POSITION VECTOR, VELOUT =VELOCITY
C VECTOR, B =ROTATION MATRIX.
C
C SUBROUTINES CALLED - MA3331
C
C COMMENT- B MATRIX COMPUTATION IS FROM SUBROUTINE EVAL OF GTDS.
C*****C
C
C DIMENSION B(3,3), BDOT(3,3), PV(3), VV(3), VELOUT(3), VOUT(3)
C DIMENSION POSOUT(3)
C DATA OMEGAE, BDOT/7.29211585494D-5, 9*0.D0/
C COMPUTE MATRIX TO ROTATE POSITION FROM TOD TO PSUEDO BODY FIXED.
C SPIN FACTOR IS ZERO.
XP=0.0D0
YP=0.0D0
B(1,1) = DCOS(GHA)
B(1,2) = DSIN(GHA)
B(1,3) = XP
B(2,1) = -B(1,2)
B(2,2) = B(1,1)
B(2,3) = -YP
B(3,1) = -XP*B(1,1)-YP*B(1,2)
B(3,2) = -XP*B(1,2)+YP*B(1,1)
B(3,3) = 1.0D0
C ROTATE THE INPUT POSITION VECTOR.
CALL MA3331 (B,PV.POSOUT)
IF (KEY.EQ.3) GO TO 30
C COMPUTE MATRIX TO ROTATE VELOCITY FROM TOD TO PSUEDO BODY FIXED.
BDOT(1,1) = -B(1,2)
BDOT(1,2) = B(1,1)
BDOT(2,1) = -B(1,1)
BDOT(2,2) = -B(1,2)
C ROTATE THE INPUT VELOCITY VECTOR.
CALL MA3331(B,VV,VOUT)
C ROTATE THE INPUT POSITION VECTOR.
CALL MA3331(BDOT,PV,VELOUT)

```

```
C OBTAIN THE BODY FIXED VELOCITY.  
  DO 20 I=1,3  
 20 VELOUT(I) = VELOUT(I)*OMEGAE + VOUT(I)  
 30 CONTINUE  
    RETURN  
    END
```

```

BLOCK DATA
IMPLICIT REAL*8 (A-H,O-Z)
C*****C
C   NAME- BLCNST
C
C   LANGUAGE- FORTHXP           TYPE- PROGRAM
C
C   THIS COMMON BLOCK WAS UPDATED MARCH 28, 1984 TO INCLUDE XKE
C   AND ESQ BY E. HARROD S/SP12
C   THIS BLOCK DATA IS COMPILED WITH THE ROUTINE PSCEAR, ANY
C   PROGRAM USING PSCEAR DOES NOT NEED TO RECOMPILE THIS BLOCK
C   DATA
C
C*****C
COMMON/BLCNST/ TTO,R,AE,GM,BJ2,BJ3,BJ4,BJ5,FLTINV,XKE,ESQ
DATA TTO,R,GM,AE,BJ2,BJ3,BJ4,BJ5,FLTINV,XKE,ESQ/2*0.D0,
1 398600.8D0,6378.135D0,-0.10826158D-02,0.25388100D-05,
2 0.16559700D-05,0.21848266D-06,298.25D0,0.743669161D-01,
3 0.6994317778266721D-02/
END

```

```

SUBROUTINE BROLYD(OSCELE,DPELE,IPERT,IPASS,IDMEAN,ORBEL)
C*****
C* REF. "BROUWER-LYDDANE ORBIT GENERATOR ROUTINE" *
C* (X-553-70-223) *
C* BY E.A. GALBREATH 1970 *
C*-----*
C* MODIFIED 7/31/74 VIONA BROWN AND R.A. GORDON TO INTERFACE *
C* WITH GTDS *
C*****
IMPLICIT REAL*8(A-H,O-Z)
REAL*8 PI2/6.283185307179586D0/
DIMENSION OSCELE(6), DPELE(6), ORBEL(5)
COMMON /BLCNST/ TTO,R,AE,GM,BJ2,BJ3,BJ4,BJ5,FLTINV,XKE,ESQ
DATA BMU,RE/1.0D0,1.0D0/,BKSUBC/0.01D0/
EK = DSQRT(GM/AE**3)
DELT = EK*TTO
GO TO (10,111), IPASS

C
C EPOCH ELEMENTS AT EPOCH TIME
C
10 ADP = DPELE(1)/AE
EDP = DPELE(2)
BIDP = DPELE(3)
HDP = DPELE(4)
GDP = DPELE(5)
BLDP = DPELE(6)
A0 = ADP
E0 = EDP
BI0 = BIDP
H0 = HDP
G0 = GDP
BL0 = BLDP
IFLG = 0

C
C COMPUTE MEAN MOTION
C
ANU=DSQRT(BMU/A0**3)

C
C COMPUTE FRACTIONS
C
F3D8=3.0D0/8.0D0
F1D2=1.0D0/2.0D0
F3D2=3.0D0/2.0D0
F1D4=1.0D0/4.0D0
F5D4=5.0D0/4.0D0
F1D8=1.0D0/8.0D0
F5D12=5.0D0/12.0D0
F1D16=1.0D0/16.0D0
F15D16=15.0D0/16.0D0
F5D24=5.0D0/24.0D0
F3D32=3.0D0/32.0D0
F15D32=15.0D0/32.0D0
F5D64=5.0D0/64.0D0

```



```

F35384=35.0D0/384.0D0
F35576=35.0D0/576.0D0
F35D52=35.0D0/1152.0D0
F1D3=1.0D0/3.0D0
F5D16=5.0D0/16.0D0
BK2 = -F1D2*(BJ2*RE*RE)
BK3 = BJ3*RE**3
BK4 = F3D8*(BJ4*RE**4)
BK5=BJ5*RE**5
GO TO 153
111 IF(IPERT.EQ.0)GO TO 7
    IF(IDMEAN.NE.0)GO TO 202
    ADP = DPELE(1)/AE
    EDP = DPELE(2)
    BIDP = DPELE(3)
    HDP = DPELE(4)
    GDP = DPELE(5)
    BLDP = DPELE(6)
153 EDP2=EDP*EDP
    CN2=1.0-EDP2
    CN=DSQRT(CN2)
    GM2=BK2/ADP**2
    GMP2=GM2/(CN2*CN2)
    GM4=BK4/ADP**4
    GMP4=GM4/CN**8
    THETA=DCOS(BIDP)
    THETA2=THETA*THETA
    THETA4=THETA2*THETA2
202 IF(IDMEAN.EQ.0)GO TO 155
    IF(IPASS.EQ.2) GO TO 150
C
C COMPUTE LDOT,GDOT,HDOT
C
157 BLDOT=CN*ANU*(GMP2*(F3D2*(3.0*THETA2-1)+GMP2*F3D32*(THETA2
1*(-96.0*CN+30.0-90.0*CN2)+(16.0*CN+25.0*CN2-15.0)+THETA4
2*(144.0*CN+25.0*CN2+105.0)))+EDP2*GMP4*F15D16*(3.0+35.0*THETA4
3-30.0*THETA2))
    GDOT=ANU*(F5D16*GMP4*((THETA2*(126.0*CN2-270.0)+THETA4*(385.0
1-189.0*CN2))-9.0*CN2+21.0)+GMP2*(F3D32*GMP2*(THETA4*(45.0*CN2
2+360.0*CN+385.0)+THETA2*(90.0-192.0*CN-126.0*CN2)+(24.0*CN
3+25.0*CN2-35))+F3D2*(5*THETA2-1)))
    HDOT=ANU*(GMP4*F5D4*THETA*(3.0-7.0*THETA2)*(5.0-3.0*CN2)+GMP2
1*(GMP2*F3D8*(THETA*(12.0*CN+9.0*CN2-5.0)-THETA*THETA2*(5.0*CN2
2+36.0*CN+35.0))-3*THETA))
155 IF(IFLG.EQ.1)GO TO 19
C
C COMPUTE ISUBC TO TEST CRITICAL INCLINATION
C
    BISUBC=((1.0-5.0*THETA2)**(-2))*((25.0*THETA4*THETA)*(GMP2*EDP2))
    IFLG=1
C
C FIRST CHECK FOR CRITICAL INCLINATION
C

```

```

        IF(BISUBC.GT.BKSUBC)GO TO 158
        ASSIGN 163 TO ID8
        GO TO 159
C
C IS THERE CRITICAL INCLINATION?
C
    19 IF(BISUBC.GT.BKSUBC)GO TO 150
159 IF(IPERT.EQ.1)GO TO 150
    GM3=BK3/ADP**3
    GMP3=GM3/(CN2*CN2*CN2)
    GM5=BK5/ADP**5
    GMP5=GM5/CN**10
    G3DG2=GMP3/GMP2
    G4DG2=GMP4/GMP2
    G5DG2=GMP5/GMP2
C
C COMPUTE A1-A8
C
    A1=(F1D8*GMP2*CN2)*(1.0-11.0*THETA2-((40.0*THETA4)/(1.0-5.0*THETA2)))
    A2=(F5D12*G4DG2*CN2)*(1.0-((8.0*THETA4)/(1.0-5.0*THETA2))-3.0*THETA2)
    A3=G5DG2*(3.0*EDP2+4.0)
    A4=G5DG2*(1.0-(24.0*THETA4)/(1.0-5.0*THETA2))-9.0*THETA2)
    A5=(G5DG2*(3.0*EDP2+4.0))*(1.0-(24.0*THETA4)/(1.0-5.0*THETA2))-
9.0*THETA2)
    A6=G3DG2*F1D4
    SINI=DSIN(BIDP)
    A10=CN2*SINI
    A7=A6*A10
    A8P=G5DG2*EDP*(1.0-(16.0*THETA4)/(1.0-5.0*THETA2))-5.0*THETA2)
    A8=A8P*EDP
C
C COMPUTE B13-B15
C
    B13=EDP*(A1-A2)
    B14=A7+F5D64*A5*A10
    B15=A8*A10*F35384
C
C COMPUTE A11-A27
C
    A11=2.0+EDP2
    A12=3.0*EDP2+2.0
    A13=THETA2*A12
    A14=(5.0*EDP2+2.0)*(THETA4/(1.0-5.0*THETA2))
    A17=THETA4/((1.0-5.0*THETA2)*(1.0-5.0*THETA2))
    A15=(EDP2*THETA4*THETA2)/((1.0-5.0*THETA2)*(1.0-5.0*THETA2))
    A16=THETA2/(1.0-5.0*THETA2)
    A18=EDP*SINI
    A19=A18/(1.0+CN)
    A21=EDP*THETA
    A22=EDP2*THETA
    SINI2=DSIN(BIDP/2.0)
    COSI2=DCOS(BIDP/2.0)
    TANI2=DTAN(BIDP/2.0)

```

```

A26=16.0*A16+40.0*A17+3.0
A27=A22*F1D8*(11.0+200.0*A17+80.0*A16)
C
C COMPUTE B1-B12
C
B1=CN*(A1-A2)-((A11-400.0*A15-40.0*A14-11.0*A13)*F1D16+(11.0+200.0
1*A17+80.0*A16)*A22*F1D8)*GMP2+((-80.0*A15-8.0*A14-3.0*A13+A11)
2*F5D24+F5D12*A26*A22)*G4DG2
B2=A6*A19*(2.0+CN-EDP2)+F5D64*A5*A19*CN2-F15D32*A4*A18*CN*CN2
1+(F5D64*A5+A6)*A21*TANI2+(9.0*EDP2+26.0)*F5D64*A4*A18+F15D32*A3*
2A21*A26*SINI*(1.0-THETA)
B3=((80.0*A17+5.0+32.0*A16)*A22*SINI*(THETA-1.0)*F35576 *G5DG2*EDP)
1-((A22*TANI2+(2.0*EDP2+3.0*(1.0-CN2*CN))*SINI)*F35D52*A8P)
B4=CN*EDP*(A1-A2)
B5=((9.0*EDP2+4.0)*A10*A4*F5D64+A7)*CN
B6=F35384*A8*CN2*CN*SINI
B7=((CN2*A18)/(1.0-5.0*THETA2))*(F1D8*GMP2*(1.0-15.0*THETA2)+(1.0
1-7.0*THETA2)*G4DG2*(-F5D12))
B8=F5D64*(A3*CN2*(1.0-9.0*THETA2-(24.0*THETA4/(1.0-5.0*THETA2))))
1+A6*CN2
B9=A8*F35384*CN2
B10=SINI*(A22*A26*G4DG2*F5D12-A27*GMP2)
B11=A21*(A5*F5D64+A6+A3*A26*F15D32*SINI*SINI)
B12=-((80.0*A17+32.0*A16+5.0)*(A22*EDP*SINI*SINI*F35576*G5DG2)+(A8
1*A21*F35D52))
150 IF (IPERT.EQ.0)GO TO 7
IF (IDMEAN.EQ.0)GO TO 4
C
C COMPUTE SECULAR TERMS
C "MEAN" MEAN ANOMALY
C
BLDP = ANU*DELT + BLDOT*DELT+BL0
BLDP = DMOD(BLDP,PI2)
IF(BLDP.LT.0.0D0)BLDP = BLDP + PI2
C
C MEAN ARGUMENT OF PERIGEE
C
GDP = GDOT*DELT + G0
GDP = DMOD(GDP,PI2)
IF(GDP.LT.0.0D0)GDP = GDP + PI2
C
C MEAN LONGITUDE OF ASCENDING NODE
C
HDP = HDOT*DELT + H0
HDP = DMOD(HDP,PI2)
IF(HDP.LT.0.0D0)HDP = HDP + PI2
4 DO 33 NN=1,6
33 OSCELE(NN) = DPELE(NN)
A = ADP
E = EDP
BI = BIDP
H = HDP
G = GDP

```

```

      BL = BLDP
C
C COMPUTE TRUE ANOMALY (DOUBLE PRIMED)
C
      EADP = DKEPLR(BLDP,EDP)
      SINDE = DSIN(EADP)
      COSDE = DCOS(EADP)
      SINFD = CN*SINDE
      COSFD = COSDE - EDP
      FDP = DATAN0(SINFD,COSFD)
      IF(IPERT.EQ.1)GO TO 7
      DADR=(1.0-EDP*COSDE)**(-1)
      SINFD=SINFD*DADR
      COSFD=COSFD*DADR
      CS2GFD=DCOS(2.0*GDP+2.0*FDP)
      DADR2=DADR*DADR
      DADR3=DADR2*DADR
      COSFD2=COSFD*COSFD
C
C COMPUTE A (SEMI-MAJOR AXIS)
C
      A=ADP*(1.0+GM2*((3.0*THETA2-1.0)*(EDP2/(CN2*CN2*CN2))*(CN+(1.0/(1.
1+CN)))+(3.0*THETA2-1.0)/(CN2*CN2*CN2))*(EDP*COSFD)*(3.0+3.0*EDP
2*COSFD+EDP2*COSFD2)+3.0*(1.0-THETA2)*DADR3*CS2GFD))
      SN2GFD=DSIN(2.0*GDP+2.0*FDP)
      SNF2GD=DSIN(2.0*GDP+FDP)
      CSF2GD=DCOS(2.0*GDP+FDP)
      SN2GD=DSIN(2.0*GDP)
      CS2GD=DCOS(2.0*GDP)
      SN3GD=DSIN(3.0*GDP)
      CS3GD=DCOS(3.0*GDP)
      SN3FGD=DSIN(3.0*FDP+2.0*GDP)
      CS3FGD=DCOS(3.0*FDP+2.0*GDP)
      SINGD=DSIN(GDP)
      COSGD=DCOS(GDP)
      GO TO ID8, (163,164)
163 DLT1E=B14*SINGD+B13*CS2GD-B15*SN3GD
C
C COMPUTE (L+G+H) PRIMED
C
      BLGHP=HDP+GDP+BLDP+B3*CS3GD+B1*SN2GD+B2*COSGD
      BLGHP=DMOD(BLGHP,PI2)
      IF(BLGHP.LT.0.0D0)BLGHP=BLGHP+PI2
      EDPDL=B4*SN2GD-B5*COSGD+B6*CS3GD-F1D4*CN2*CN*GMP2*(2.0*(3.0*THETA2
1-1.0)*(DADR2*CN2+DADR+1.0)*SINFD+3.0*(1.0-THETA2)*((-DADR2*CN2
2-DADR+1.0)*SNF2GD+(DADR2*CN2+DADR+F1D3)*SN3FGD))
      DLT1=F1D2*THETA*GMP2*SINI*(EDP*CS3FGD+3.0*(EDP*CSF2GD+CS2GFD))
1-(A21/CN2)*(B8*SINGD+B7*CS2GD-B9*SN3GD)
      SINDH=(1.0/COSI2)*(F1D2*(B12*CS3GD+B11*COSGD+B10*SN2GD-(F1D2*GMP2
1*THETA*SINI*(6.0*(EDP*SINFD-BLDP+FDP)-(3.0*(SN2GFD+EDP*SNF2GD)+EDP
2*SN3FGD))))))
C
C COMPUTE (L+G+H)

```

```

C
164 BLGH=BLGHP+((1.0/(CN+1.0))*F1D4*EDP*GMP2*CN2*(3.0*(1.0-THETA2)*
1(SN3FGD*(F1D3+DADR2*CN2+DADR)+SNF2GD*(1.0-(DADR2*CN2+DADR)))+2.0*
2SINF2*(3.0*THETA2-1.0)*(DADR2*CN2+DADR+1.0))+GMP2*F3D2*((-2.0*
3THETA-1.0+5.0*THETA2)*(EDP*SINF2+FDP-BLDP))+(3.0+2.0*THETA-5.0*
4THETA2)*(GMP2*F1D4*(EDP*SN3FGD+3.0*(SN2GFD+EDP*SNF2GD)))
BLGH=DMOD(BLGH,PI2)
IF(BLGH.LT.0.0D0)BLGH=BLGH+PI2
DLTE=DLT1E+(F1D2*CN2*((3.0*(1.0/(CN2*CN2*CN2))*GM2*(1.0-THETA2)
1*CS2GFD*(3.0*EDP*COSFD2+3.0*COSFD+EDP2*COSFD*COSFD2+EDP))-(GMP2
2*(1.0-THETA2)*(3.0*CSF2GD+CS3FGD))+(3.0*THETA2-1.0)*GM2*(1.0/
3(CN2*CN2*CN2))*(EDP*CN+(EDP/(1.0+CN))+3.0*EDP*COSFD2+3.0*COSFD+
4EDP2*COSFD*COSFD2)))
EDPDL2=EDPDL*EDPDL
EDPDE2=(EDP+DLTE)*(EDP+DLTE)
C
C COMPUTE E (ECCENTRICITY)
C
E=DSQRT(EDPDL2+EDPDE2)
SINDH2=SINDH*SINDH
SQUAR=(DLTI*COSI2*F1D2+SINI2)*(DLTI*COSI2*F1D2+SINI2)
SQRI=DSQRT(SINDH2+SQUAR)
C
C COMPUTE BI (INCLINATION)
C
BI=DARSIN(SQRI)
BI=2.0*BI
BI=DMOD(BI,PI2)
IF(BI.LT.0.0D0)BI=BI+PI2
C
C CHECK FOR E (ECCENTRICITY)=0
C
IF(E.NE.0.0) GO TO 168
BL=0.0
C
C CHECK FOR BI (INCLINATION)=0
C
145 IF(BI.NE.0.0) GO TO 169
H=0.0
C
C COMPUTE G (ARGUMENT OF PERIGEE)
C
146 G=BLGH-BL-H
G=DMOD(G,PI2)
IF(G.LT.0.0D0)G=G+PI2
C
C COMPUTE TRUE ANOMALY
C
EA = DKEPLR(BL,E)
ARG1 = DSIN(EA) * DSQRT(1.0-E**2)
ARG2 = DCOS(EA) - E
IF = DATAN0(ARG1,ARG2)
OSCELE(1) = A*AE

```

```

OSCELE(2) = E
OSCELE(3) = BI
OSCELE(4) = H
OSCELE(5) = G
OSCELE(6) = BL
7 CONTINUE
DPELE(1) = ADP*AE
DPELE(2) = EDP
DPELE(3) = BIDP
DPELE(4) = HDP
DPELE(5) = GDP
DPELE(6) = BLDP
IF(IPERT.EQ.0)BL = DMOD(ANU*DELT,PI2)
ORBEL(1) = EADP
ORBEL(2) = GDP+FDP
ORBEL(3) = GDP
ORBEL(4) = EK*(ANU + BLDOT)
ORBEL(5) = FDP
R = A*AE*(1.0D0 - E*DCOS(EA))
GO TO 45

C
C MODIFICATIONS FOR CRITICAL INCLINATION
C
158 DLT1E=0.0
    BLGHP=0.0
    EDPDL=0.0
    DLT1=0.0
    SINDH=0.0
    ASSIGN 164 TO ID8
    GO TO 150
168 SINLDP=DSIN(BLDP)
    COSLDP=DCOS(BLDP)
    SINHDP=DSIN(HDP)
    COSHDP=DCOS(HDP)

C
C COMPUTE L (MEAN ANOMALY)
C
    ARG1=EDPDL*COSLDP+(EDP+DLTE)*SINLDP
    ARG2=(EDP+DLTE)*COSLDP-(EDPDL*SINLDP)
    BL=DATAN2(ARG1,ARG2)
    BL=DMOD(BL,PI2)
    IF(BL.LT.0.0D0)BL=BL+PI2
    GO TO 145

C
C COMPUTE H (LONGITUDE OF ASCENDING NODE)
169 ARG1=SINDH*COSHDP+SINHDP*(F1D2*DLTI*COSI2+SINI2)
    ARG2=COSHDP*(F1D2*DLTI*COSI2+SINI2)-(SINDH*SINHDP)
    H=DATAN2(ARG1,ARG2)
    H=DMOD(H,PI2)
    IF(H.LT.0.0D0)H=H+PI2
    GO TO 146
45 CONTINUE
    RETURN

```

END

```

SUBROUTINE CELEM (ORBEL,GMC,PV,VV)
C ORIGINAL VERSION...1/22/71...CHARLES K. CAPPS
C PURPOSE:
C THIS ROUTINE CONVERTS CLASSICAL OSCULATING ORBITAL ELEMENTS
C TO
C CARTESIAN ELEMENTS.
C CALLING SEQUENCE:
C CALL CELEM(ORBEL,GMC,PV,VV)
C INPUT THROUGH ARGUMENT LIST:
C ORBEL(1) = SEMI-MAJOR AXIS, A (OSCULATING ELEMENTS)
C ORBEL(2) = ECCENTRICITY, E
C ORBEL(3) = INCLINATION, I
C ORBEL(4) = LONGITUDE OF ASCENDING NODE, CAP OMEGA
C ORBEL(5) = ARGUMENT OF PERIFOCUS, OMEGA
C ORBEL(6) = MEAN ANOMALY, M
C GMC = GRAVITATIONAL CONSTANT
C OUTPUT THROUGH ARGUMENT LIST:
C PV = CARTESIAN POSITION VECTOR
C VV = CARTESIAN VELOCITY VECTOR
C METHOD:
C USES MILES STANDISH ITERATIVE SCHEME FOR SOLUTION TO
C KEPLERS EQN.
C REFERENCES:
C GTDS TASK SPEC FOR CELEM, C.E. VELEZ, 13 JANUARY 1971
C DODS SYSTEM DESCRIPTION, SUBROUTINE KEPLR1
C P. EXCOBAL- "METHODS OF ORBIT DETERMINATION"
C X-552-67-421,"COMPARISON OF ITERATIVE TECHNIQUES FOR THE
C SOLUTION OF
C KEPLERS EQUATION", I.COLE AND R.BORCHERS
C PROGRAMMER:
C CHARLES K. CAPPS, CODE 553.2, GSFC
C
C IMPLICIT REAL*8(A-H,O-Z)
C DATA MAX /10/
C DIMENSION PV(3),VV(3),ORBEL(6)
C DATA TOL /+0.5D-16/
C ITER = 0
C FIND IF THIS IS ELLIPTIC OR HYPERBOLIC ORBIT
C IF (ORBEL (1).LE.0.0D0.AND.ORBEL(2).GT.1.0D0) GO TO 50
C ELLIPTIC ORBIT TAKES THIS ROUTE.
C FIRST FIND ECCENTRIC ANOMALY VIA NEWTONS (MILES STANDISH VERSION)
C E1 = ORBEL(6)
10 F = E1 - (ORBEL(2) * DSIN(E1)) - ORBEL (6)
D = 1.0D0 - (ORBEL (2) * DCOS (E1 - 0.5D0 *F))
E2 = E1 - (F / D)
IF (DABS (E1-E2)-TOL)40,40,20
20 ITER =ITER + 1
E1 = E2
IF(ITER - MAX) 10,10,30
C SET UP ERROR CODE TO RETURN FROM SUBROUTINE
30 NERR = 13
C ECCENTRIC ANOMALY CONVERGED, NOW GET XO, YO, R
40 COSE = DCOS(E2)

```



```

SINE = DSIN (E2)
TEMP = 1.0D0 - ORBEL(2) * ORBEL (2)
XO = ORBEL(1) * (COSE - ORBEL(2))
YO = ORBEL(1) * (DSQRT(TEMP)* SINE)
R = ORBEL(1) * (1.0D0 - ORBEL (2) * COSE)
XOD = (-DSQRT(GMC* ORBEL(1))* SINE)/R
YOD = (DSQRT(GMC*ORBEL(1)*(TEMP))*COSE) /R
GO TO 100
C
HYPERBOLIC ORBITS TAKE THIS ROUTE
50 E1 = ORBEL(6) /2.0D0
60 F = ORBEL(2) * DSINH(E1) - E1 - ORBEL(6)
D = ORBEL(2) * DCOSH(E1 - 0.5D0 * F ) - 1.0D0

```

```

      E2=E1-(F/D)
      IF (DABS (E1-E2)-TOL)90,90,70
70 ITER = ITER + 1
      E1 = E2
      IF (ITER - MAX) 60,60,80
C      SET UP ERROR CODE FOR NON-CONVERGENCE PRIOR TO EXIT.
80 NERR = 14
C      ECCENTRIC ANOMALY COMPUTED, NOW GET XO,YO,R
90 COSE = DCOSH (E2)
      SINE = DSINH(E2)
      TEMP = ORBEL(2) * ORBEL (2) - 1.0D0
      XO = ORBEL(1)*(COSE- ORBEL(2))
      YO = -ORBEL (1)*DSQRT (TEMP) * SINE
      R = ORBEL (1)*(1.0D0 - ORBEL(2) * COSE)
      XOD = (-DSQRT(-GMC*ORBEL(1))*SINE)/R
      YOD = (DSQRT(-GMC*ORBEL(1)*TEMP)*COSE)/R
100 COSO = DCOS(ORBEL(5))
      SINO = DSIN (ORBEL(5))
      COSOM = DCOS (ORBEL(4))
      SINOM = DSIN (ORBEL(4))
      COSI = DCOS(ORBEL(3))
      SINI = DSIN (ORBEL(3))
      B11 = COSO * COSOM - SINO * SINOM * COSI
      B21 = COSO * SINOM + SINO * COSOM * COSI
      B31 = SINO * SINI
      B12 = -SINO * COSOM - COSO * SINOM * COSI
      B22 = -SINO * SINOM + COSO * COSOM * COSI
      B32 = COSO * SINI
C      NOW MULTIPLY 3 X 2 MATRIX BY 2 X 1 VECTORS FOR POSITION, VELOCITY.
      PV(1) = B11 * XO + B12 * YO
      PV(2) = B21 * XO + B22 * YO
      PV(3) = B31 * XO + B32 * YO
      VV(1) = B11*XOD + B12 * YOD
      VV(2) = B21 * XOD + B22 * YOD
      VV(3) = B31 * XOD + B32 * YOD
999 RETURN
      END
      DOUBLE PRECISION FUNCTION DATAN0(ARG1,ARG2)
C          VERSION OF 03/10/71
C
C          FORTRAN IV FUNCTION SUBROUTINE FOR THE IBM-360
C
C          PURPOSE
C              COMPUTE A VALUE FOR THE ARCTAN BETWEEN 0 AND 2
C              PI WHERE THE
C              TANGENT IS DEFINED BY THE TWO INPUT ARGUMENTS AS ARG1/ARG2
C
C          CALLING SEQUENCE
C              NONE
C
C          INPUT
C              ARG1 - FIST ARGUMENT OF THE ARC TANGENT
C              ARG2 - SECOND ARGUMENT OF THE ARC TANGENT
C

```

```

C          OUTPUT
C          A DOUBLE PRECISION ARC TANGENT (+ VALUE BETWEEN
          0 AND 2PI)
C
C          METHOD
C
C          USES FORTRAN MATH SUBROUTINE DATAN2 WHICH
          RETURNS A VALUE
          BETWEEN -PI AND PI, GIVEN TWO ARGUMENTS
C
C          REQUIRED SUBROUTINES
          1- FUNCTION SUBROUTINE DATAN2
C
C          PROGRAMMER
          R. E. GILLIAN - COMPUTING AND SOFTWARE
C
C*****START PROGRAM*****
C
C          COMPUTE ARCTAN BETWEEN -PI AND PI
C
          IMPLICIT REAL*8 (A-H,P-Z)
          50 DATAN0=DATAN2(ARG1,ARG2)
C
C          IF ARCTAN IS NEGATIVE, ADD 2PI TO THE RESULT
C
          100 IF(DATAN0.GE.0) GO TO 999
          DATAN0 = DATAN0 + 6.283185307179586D0
          ARG = DATAN0
          999 RETURN
          END
          FUNCTION DKEPLR(M,E)
          IMPLICIT REAL*8(A-H,O-Z)
          REAL*8 M,PI2/6.283185307179586D0/,TOL/0.5D-15/
C
C SUBROUTINE TO SOLVE KEPLER'S EQUATION
C KEPLER'S EQUATION RELATES GEOMETRY OR POSITION IN ORBIT PLANE TO TIME.
C
C M - MEAN ANOMALY (0<M<2PI)
C E - ECCENTRICITY
C EA - ECCENTRIC ANOMALY
C
          EA=0
          IF(M)1,2,1
          1 EA=M + E*DSIN(M)
          DO 22 I=1,12
          OLDEA=EA
          FE=EA-E*DSIN(EA)-M
          EA=EA-FE/(1-E*DCOS(EA-0.5D0*FE))
C TEST FOR CONVERGENCE
          DELEA=DABS(EA-OLDEA)
          IF(DELEA.LE.TOL)GO TO 2
          22 CONTINUE
          2 EA=DMOD(EA,PI2)

```

```

DKEPLR=EA
RETURN
END
SUBROUTINE MA3331(/A/,/B/,/C/)
C
C
C   PURPOSE
C       TO COMPUTE THE PRODUCT OF A 3X3 MATRIX AND A 3X1 MATRIX
C
C   VERSION OF   JULY 23, 1971
C
C   METHOD
C       WRITE THE EXPLICIT CODE FOR THE MULTIPLICATION OF A 3X3 MATRIX AND
C   A 3X1 MATRIX AND RETURN THE RESULT IN THE 'C' MATRIX
C
C   CALLING SEQUENCE
C       CALL MAT31(A,B,C)
C       A       = INPUT 3X3 MATRIX
C       B       = INPUT 3X1 MATRIX
C       C       = OUTPUT 3X3 MATRIX
C
C   PROGRAMMER
C       N.R. BURTON COMPUTER SCIENCES CORPORATION
C
C   *****START PROGRAM*****
IMPLICIT      REAL*8(A-H,O-Z)
DIMENSION    A(9),B(3),C(3)
C(1)=A(1)*B(1)+A(4)*B(2)+A(7)*B(3)
C(2)=A(2)*B(1)+A(5)*B(2)+A(8)*B(3)
C(3)=A(3)*B(1)+A(6)*B(2)+A(9)*B(3)
RETURN
END

```

```

SUBROUTINE XYZPLH(EQS,XSTA,YSTA,ZSTA,RLAT,RLON,AE,HE,IERR)
C
C          FORTRAN IV SUBROUTINE FOR THE IBM-360, 3/20/74 VERSION
C          PURPOSE
C
C          TO CONVERT STATION COORDINATES FROM THE EARTH-
C          FIXED CARTESIAN
C          COORDINATES TO GEODETIC LATITUDE, EAST LONGITUDE, AND
SPHEROID C          HEIGHT
C          CALLING SEQUENCE
C          CALL
C          XYZPLH(EQS,XSTA,YSTA,ZSTA,RLAT,RLON,HE,IERR,AE)
C          INPUT
C
C          EQS - ECCENTRICITY OF THE BODY SQUARED
C          AE  - SEMI-MAJOR AXIS
C          XSTA - EARTH-FIXED CARTESIAN COORDINATE X
C          YSTA - EARTH-FIXED CARTESIAN COORDINATE Y
C          ZSTA - EARTH-FIXED CARTESIAN COORDINATE Z
C
C          OUTPUT
C
C          RLAT - GEODETIC LATITUDE
C          RLON - EAST LONGITUDE
C          HE  - SPHEROID HEIGHT
C          IERR - ERROR FLAG
C
C          0=HEIGHT CONVERGED
C          1=HEIGHT DID NOT CONVERGE
C          2=LONGITUDE IS UNDEFINED
C
C          REQUIRED SUBPROGRAMS
C          DATAN0
C
C          PROGRAMMER
C          R.E. GILLIAN, COMPUTING AND SOFTWARE
C*****
      IMPLICIT REAL*8(A-H,P-Z)
      IERR=0
      T=EQS*ZSTA
      XYSQ=XSTA**2+YSTA**2
      IF (DABS(ZSTA).GE.1.0D-15) GO TO 5
      HE = DSQRT(XYSQ) - AE
      RLAT = 0.0 D0
      GO TO 21
5 DO 10 J = 1, 25
      ZT=ZSTA+T
      H1=DSQRT(XYSQ+ZT**2)
      SINPHI=ZT/H1
      ESQSP=EQS*SINPHI
      H2=AE/DSQRT(1.0D0-ESQSP*SINPHI)
      T1=H2*ESQSP
      IF(DABS((T1-T)/T1).LT..1D-14) GO TO 20
10 T=T1
      IERR=1
      GO TO 30
20 HE=H1-H2
      RLAT=DARSIN(SINPHI)
21 IF(XSTA.EQ.0.0D0) GO TO 40
      GO TO 25

```

```
40 IF(YSTA.EQ.0.0D0) IERR=IERR+2
   IF(IERR.GT.0) GO TO 30
   IF(YSTA.LT.0.0D0) GO TO 50
   RLON=3.14159265358793/2.0D0
   GO TO 30
50 RLON=3.14159265358793*1.5D0
   GO TO 30
25 RLON=DATAN0(YSTA,XSTA)
30 CONTINUE
   RETURN
   End
```

APPENDIX C: POLAR STEREOGRAPHIC EARTH LOCATION

Two subroutines are provided for Earth location/navigation for NESDIS Operational Products that are mapped onto a polar stereographic map base. These subroutines provide the capability of converting the line, sample location of a data point on the polar stereographic base to latitude and longitude (IJTOLL) or the reverse (LLTOIJ). With proper specification of the input parameters, these subroutines may be used in conjunction with the following:

1. Radiation Budget Products (except Mercator)
2. Mapped GAC Products (except Mercator)
3. Vegetation Index Data

C.1 INTRODUCTION

Subroutines IJTOLL and LLTOIJ are very similar in structure to each other. They are described together where possible to avoid repetition. IJTOLL converts the i and j coordinates of a point to latitude and longitude, whereas LLTOIJ converts the latitude and longitude of a point to the i and j coordinates. Both require the origin of the map to be in the upper left corner. Several parameters must be input in order to tailor IJTOLL and LLTOIJ to a specific user's needs. Both subroutines have identical variables in their argument lists. These variables are defined in Table C-1.

Table C-1. Subroutines IJTOLL and LLTOIJ Argument list.	
Argument	Definition
PRMLON	The prime longitude of the polar stereographic map base. This is defined as the meridian which is perpendicular to the base of the map and which goes from the pole to the bottom of the map. The map may be oriented as desired. The prime longitude can be expressed as either positive 0-360W or positive 0-180W and negative 0-180E.
SCALE	The number of desired grid points between the pole and the equator.
CENTI	The i coordinate representing the center of the array.
CENTJ	The j coordinate representing the center of the array.
RI	The i coordinate of the point to be converted.
RJ	The j coordinate of the point to be converted.
PNTLAT	The latitude of the point written as positive 0-90N or negative 0-90S.
PNTLON	The longitude of the point written as either positive 0-360W or positive 0-180W and negative 0-180E.
Note: IJTOLL has RI and RJ for inputs with the corresponding PNTLAT and PNTLON as outputs, and LLTOIJ uses PNTLAT and PNTLON as inputs to calculate the resultant RI and RJ as outputs.	

C.2 PROGRAM OPERATION

Subroutine IJTOLL computes the angle between the horizontal and a line drawn from the pole to the point. From this angle and the prime longitude, the longitude of the point is obtained. IJTOLL also computes the latitude angle using various ratios and some simple trigonometry.

The equations governing the relation between i and j coordinates and latitude and longitude follow.

The distance from the point to the pole (in units of grid points) was derived from the Pythagorean theorem and is defined as:

$$POLDIS = \sqrt{|CENTRI - RI|^2 + |CENTJ - RJ|^2}$$

The angle (in degrees) governing the latitude can easily be derived using the diagram of the Earth's cross-section in Figure C-1, and is defined as:

$$ANG1 = \theta = \arctan\left(\frac{POLDIS}{SCALE}\right)$$

Figure C-1. Definition of latitude angle.

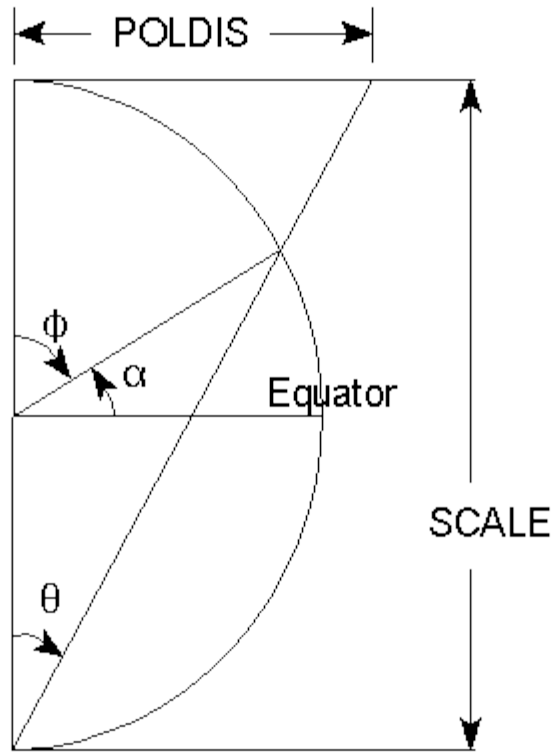

Figure C-1. Definition of latitude angle.

The angle (in degrees) governing the longitude is also easily derived from the diagram of a polar stereographic map and the *i, j* coordinates array in Figure C-2, and is defined as:

$$ANG2 = \arccos\left(\frac{(CENTJ - RJ)}{POLDIS}\right)$$

Figure C-2. Definition of longitude angle.

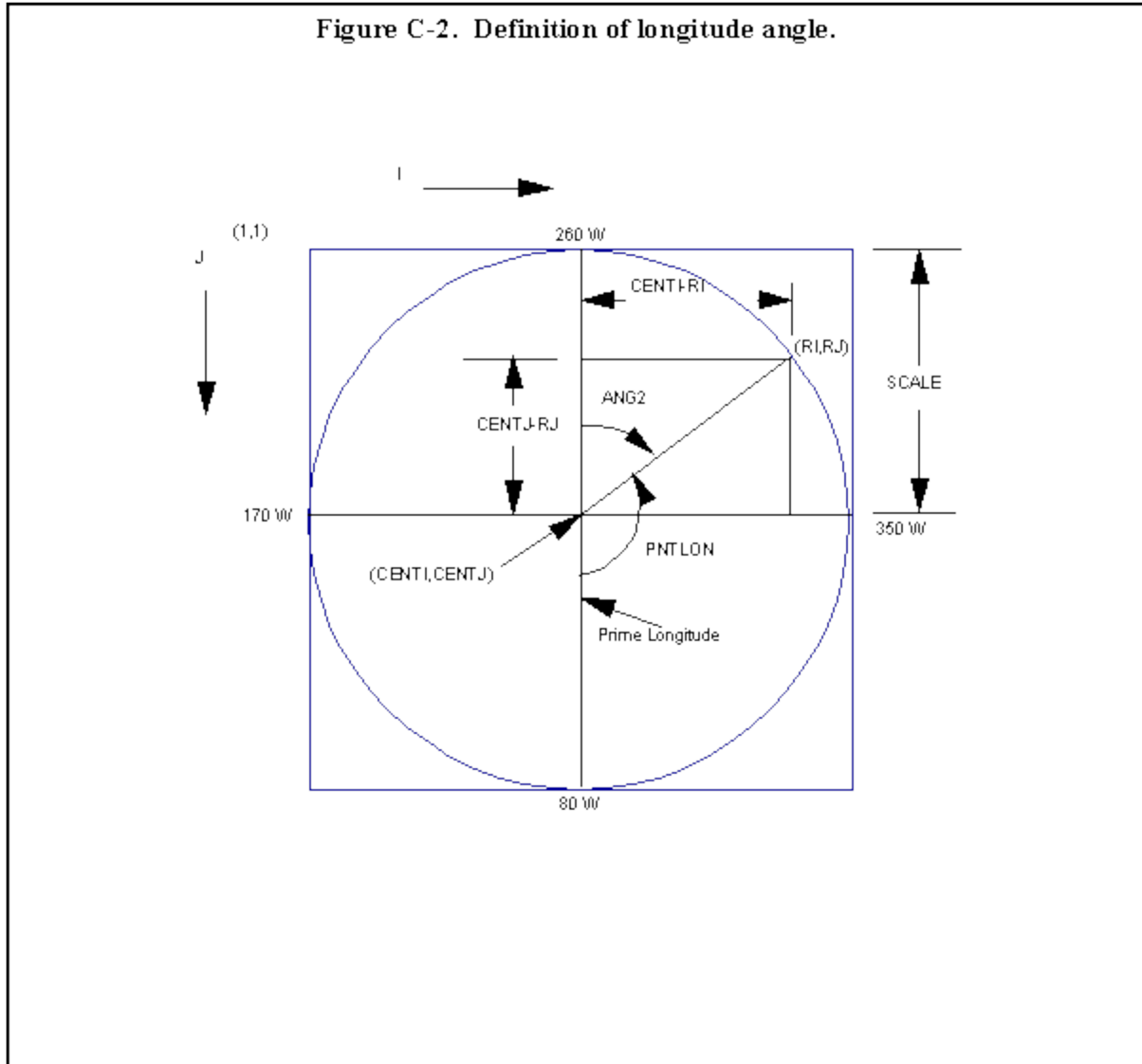

Figure C-2. Definition of longitude angle.

Thus, from Figure C-1, the latitude is:

$$PNTLAT = \alpha = 90^{\circ} - 2\theta = 90^{\circ} - 2 \arctan\left(\frac{POLDIS}{SCALE}\right)$$

From Figure C-2, the longitude is defined as:

$$PNTLON = PRMLON - ANG2$$

Subroutines IJTOLL and LLTOIJ can be used for an array containing one or two hemispheres. For the case of two hemispheres, IJTOLL and LLTOIJ assume that they are arranged as shown in Figure C-3. For purposes of illustration only, the array shown is dimensioned as two 512 x

512s or one 512 x 1024.

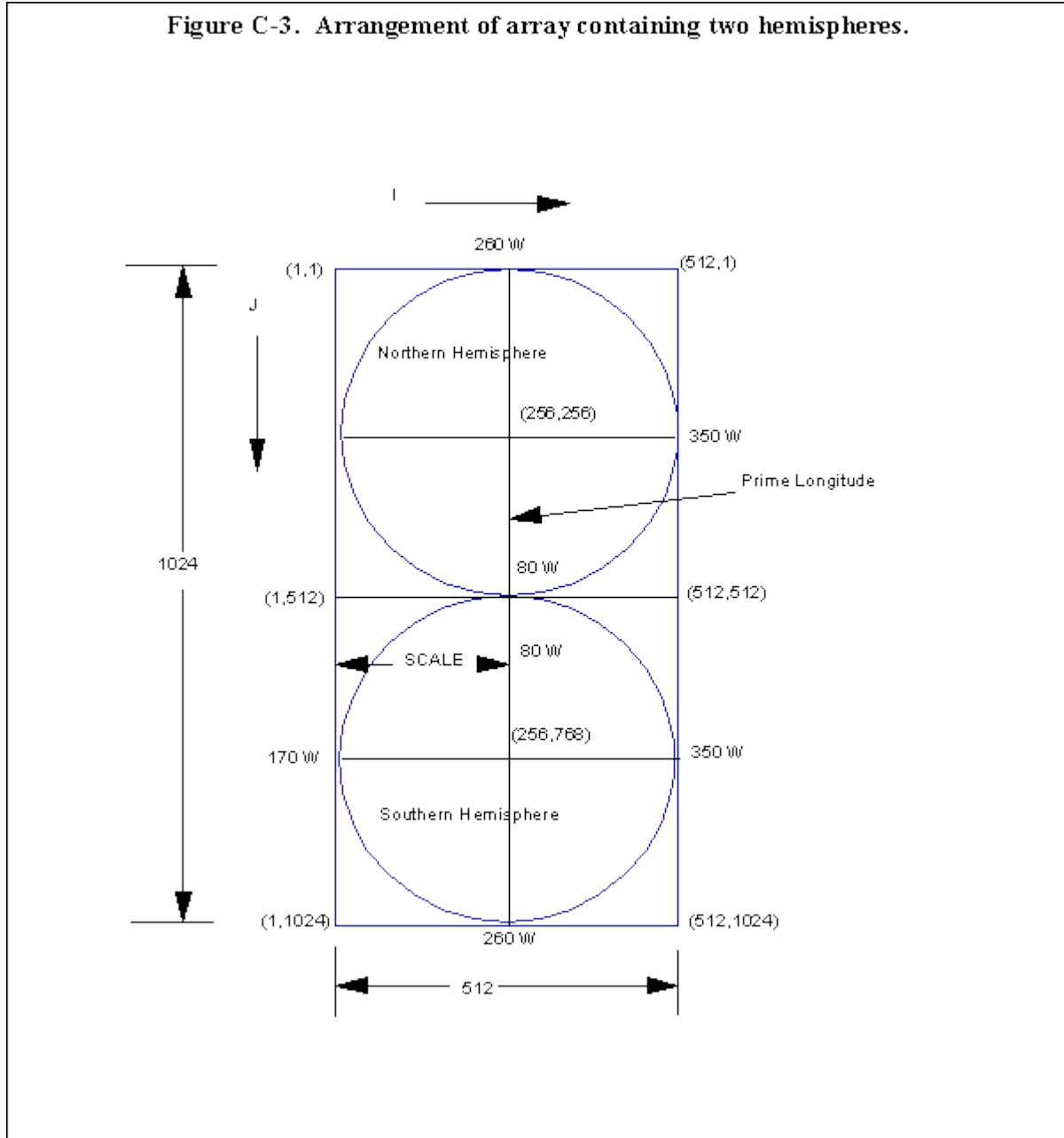

Figure C-3. Arrangement of array containing two hemispheres.

There is one special case where these equations blow up, which happens when the point is at a pole. This makes $POLDIS=0.0$ and is handled by setting the latitude to ± 90 degrees and the longitude to the prime longitude. There are a series of tests in IJTOLL which compensate for the longitude according to which quadrant the point resides. These tests produce the correct longitude for both the Northern and Southern Hemispheres.

If an i, j value is input which falls outside the Earth's disk but inside the array itself, the

algorithm checks whether POLDIS exceeds SCALE. If it does not, then it sets the latitude and longitude to -999.9.

The algorithms which LLTOIJ are based upon can easily be derived by working the IJTOLL equations backwards. LLTOIJ computes the distance of the projected point from the pole using the latitude angle and some simple trigonometry. In addition, LLTOIJ computes the angular difference between the prime longitude and the longitude of the point. These two parameters are then used to compute the i and j coordinates of the point.

In Figure C-3, the upper 512 x 512 array contains the Northern Hemisphere while the lower 512 x 512 array contains the Southern Hemisphere. Subroutine IJTOLL will automatically return the latitude and longitude (or LLTOIJ will return the i and j coordinates) for the Southern Hemisphere although the CENTI and CENTJ input parameters specifically refer to the Northern Hemisphere.

The arrangement shown in Figure C-3 is not mandatory in order for IJTOLL and LLTOIJ to function properly. For example, the data for the Northern Hemisphere could be contained in one 512 x 512 array and the data for the Southern Hemisphere could be contained in an entirely separate 512 x 512 array. For that case, IJTOLL and LLTOIJ could be used for the Northern Hemisphere with the proper input arguments. IJTOLL and LLTOIJ could also be used for the Southern Hemisphere using the same input arguments except the prime longitude which would have to be changed. (It is assumed that the orientation of the Hemispheres with the arrays is the same as in Figure C-3.)

IJTOLL and LLTOIJ represent the i and j coordinates in such a way that the i values represent the columns and the j values represent the rows of the array. Some of the principal points of the Earth's disk have been labeled with their proper i and j coordinates in parentheses in Figure C-3.

For the example in Figure C-3, the input arguments would be set as follows:

PRMLON = +80.0
SCALE = 256.0
CENTI = 256.0
CENTJ = 256.0

The input parameters can be adjusted so that IJTOLL and LLTOIJ can be applied to any case. For example, the array for the Northern Hemisphere is a 512 x 512 array. But unlike the case shown in Figure C-3, the Earth's disk is smaller than the boundary of the array. There are 8 blank-filled rows at the top and 4 at the bottom. Plus, there are 4 blank-filled columns on the left and 8 on the right of the Earth's disk. In this case, SCALE = 256.0.

CENTI = 250.0 + 4.0 = 254.0 and the CENTJ = 250.0 + 8.0 = 258.0. See Figure C-4 for an illustration of this example.

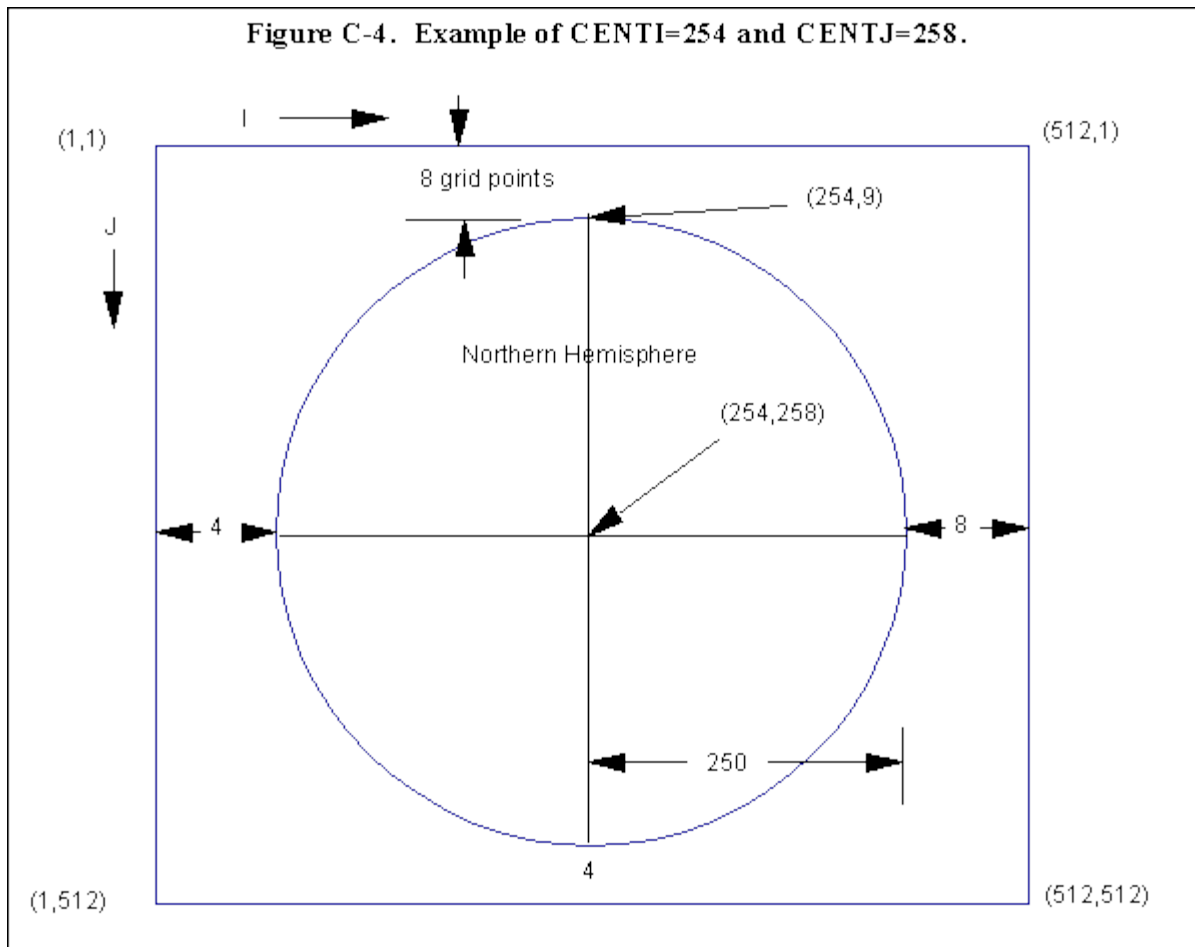

Figure C-4. Example of CENTI=254 and CENTJ=258.

In LLTOIJ, there is a problem with obtaining the proper *i* and *j* coordinates for any point along the equator in the Southern Hemisphere. This is caused by the fact that the computer represents -0.0 as 0.0; therefore, making it impossible to represent the Southern Hemisphere equator. To obtain the approximate *i* and *j* coordinates for the equator in the Southern Hemisphere, input a number between 0.0 and -1.0 for the latitude. Or alternately input the latitude as 0.0, and add the value of 2 x CENTJ to the RJ value obtained. (Adding 2 x CENTJ to RJ would give the RJ the correct value for the Southern Hemisphere.)

C.3 PROGRAM LISTINGS

A listing of the FORTRAN code for subroutines IJTOLL and LLTOIJ follows.

```
      SUBROUTINE IJTOLL (PRMLON, SCALE, CENTI, CENTJ, RI, RJ, PNTLAT, PNTLON)
C THIS SUBROUTINE CONVERTS I AND J COORDINATES OF A POINT ON
C A POLAR STEREOGRAPHIC MAP TO LATITUDE AND LONGITUDE.
C
C INPUT
C PRMLON  PRIME LONGITUDE OF MAP BASE IN DEGREES. CAN BE
C         EITHER POSITIVE 0-360W OR POSITIVE 0-180W AND
C         NEGATIVE 0-180E.
C SCALE   DISTANCE FROM POLE TO EQUATOR IN GRID POINTS.
C CENTI,  CENTER OF THE ARRAY IN I AND J COORDINATES.
C CENTJ
C RI, RJ  THE I AND J COORDINATE OF THE POINT TO BE CONVERTED.
C OUTPUT
C PNTLAT  THE LATITUDE OF THE POINT IN DEGREES (POSITIVE
C         0-90N AND NEGATIVE 0-90S).
C PNTLON  THE LONGITUDE OF THE POINT IN DEGREES WITH SAME
C         SIGN CONVENTION AS PRMLON.
C         SOUTH=2.0*CENTJ
C         RY=RJ
C         RADDEG=0.01745329
C CHECK WHETHER POINT IS IN SOUTHERN HEMISPHERE AND ADJUST
C ACCORDINGLY.
C   IF (RJ.GT.SOUTH) RJ=2.0*SOUTH-RJ
C COMPUTE THE DISTANCE BETWEEN THE POLE AND THE POINT. IF
C POLDIS IS GREATER THAN SCALE, SET PNTLAT AND PNTLON TO
C -999.9 TO INDICATE AREA OUTSIDE OF EARTH'S DISK. IF POLDIS
C EQUALS SCALE SET PNTLAT AND PNTLON EQUAL TO A POLE.
C   POLDIS=SQRT(ABS(CENTI-RI)**2.0+ABS(CENTJ-RJ)**2.0)
C   IF (POLDIS.GT.SCALE) GO TO 50
C   IF (POLDIS.EQ.0) GO TO 30
C COMPUTE PNTLAT AND PNTLON FROM ANG1 AND ANG2, THEN ADJUST
C PNTLAT ACCORDING TO RELATION WITH CENTER OF ARRAY.
C   ANG1=ATAN(POLDIS/SCALE)
C   ANG2=ACOS((CENTJ-RJ)/POLDIS)
C   IF (RJ.GT.CENTJ) ANG2=ACOS((RJ-CENTJ)/POLDIS)
C   PNTLON=PRMLON-ANG2/RADDEG
C   IF (RI.GT.CENTI.AND.RJ.LE.CENTJ) PNTLON=PRMLON+ANG2/RADDEG
C   IF (RI.LT.CENTI.AND.RJ.GE.CENTJ) PNTLON=PRMLON+ANG2/RADDEG
C   PNTLAT=90.0-2.0*ANG1/RADDEG
C   IF (RI.LE.CENTI.AND.RJ.LT.CENTJ) PNTLON=PNTLON+180.0
C   IF (RI.GT.CENTI.AND.RJ.LE.CENTJ) PNTLON=PNTLON+180.0
C   IF (RY.GT.SOUTH) PNTLAT=-PNTLAT
```

```
RJ=RY
RETURN
30 PNTLAT=90.0
  PNTLON=PRMLON
  IF (RY.GT.SOUTH) PNTLAT=-PNTLAT
  RJ=RY
  RETURN
50 PNTLAT=-999.9
  PNTLON=-999.9
  RJ=RY
  RETURN
END
```

```

SUBROUTINE LLTOIJ (PRMLON, SCALE, PNTLAT, PNTLON, CENTI, CENTJ, RI, RJ)
C THIS SUBROUTINE CONVERTS LATITUDE AND LONGITUDE OF A POINT
C ON A POLAR STEREOGRAPHIC MAP TO I AND J COORDINATES.
C
C INPUT
C PRMLON PRIME LONGITUDE OF MAP BASE IN DEGREES. CAN BE
C EITHER POSITIVE 0-360W OR POSITIVE 0-180W AND
C NEGATIVE 0-180E.
C SCALE DISTANCE FROM POLE TO EQUATOR IN GRID POINTS.
C CENTI, CENTER OF THE ARRAY IN I AND J COORDINATES.
C CENTJ
C PNTLAT THE LATITUDE OF THE POINT TO BE CONVERTED
C IN DEGREES (POSITIVE 0-90N AND NEGATIVE 0-90S).
C PNTLON THE LONGITUDE OF THE POINT TO BE CONVERTED
C IN DEGREES WITH SAME SIGN CONVENTION AS PRMLON.
C
C OUTPUT
C RI THE I COORDINATE OF THE POINT.
C RJ THE J COORDINATE OF THE POINT.
C
SOUTH=2.0*CENTJ
RADDEG=0.01745329
C COMPUTE THE DISTANCE OF THE PROJECTED POINT FROM THE
C POLE.
ANG1=(90.0-ABS(PNTLAT))*RADDEG/2.0
POLDIS=SCALE*TAN(ANG1)
C COMPUTE THE DIFFERENCE IN RADIANS BETWEEN THE PRIME
C LONGITUDE AND THE LONGITUDE OF THE POINT.
ANG2=(PRMLON-PNTLON)*RADDEG
C COMPUTE THE I AND J COORDINATES OF THE POINT (RI AND RJ).
RI=CENTI+POLDIS*SIN(ANG2)
IF(PRMLON.LT.0.0) RI=CENTI-POLDIS*SIN(ANG2)
IF(PNTLAT.LT.0.0) GO TO 10
RJ=CENTJ+POLDIS*COS(ANG2)
RETURN
10 RJ=CENTJ-POLDIS*COS(ANG2)
IF(PNTLAT.LT.0.0) RJ=RJ+SOUTH
RETURN
END

```

APPENDIX D: MISCELLANEOUS PARAMETERS FOR THE POLAR ORBITER SATELLITES

This section provides more detailed information for the NOAA KLMNN' series and Metop series, including tables for HIRS/3, AMSU-A and -B channel spectral response and HIRS/3 thermal band-correction coefficients, tables for AVHRR/3 infrared channel central wave numbers as a function of temperature, and the spectral response curves and actual values for the AVHRR/3 instrument. Many of these parameters are needed for calibration purposes.





Up to date information regarding abnormalities on the POES spacecraft and instruments can be found at: <http://www.oso.noaa.gov/poesstatus/>. This website allows a user to search and sort on any POES spacecraft, subsystem or instrument status. Additional details about the various satellites can be obtained by going to the NOAA/NESDIS/Office of Satellite Operations' (OSO) archive of weekly status reports at: <http://noaasis.noaa.gov/NOAASIS/ml/podocs.html>.

The spectral response functions for the POES instruments can be obtained from Global Space-based Inter-Calibration System Coordination Center hosted by NOAA at <http://www.star.nesdis.noaa.gov/smcd/GCC/instrInfo-srf.php>.

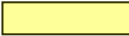

Tables D.1 and D.2 show the launch dates, decommission dates, instrument number and instrument status as of August 8, 2014.

Table D-1. POES Program Instrument Utilization Status						
	EM	NOAA-15 (K)	NOAA-16 (L)	NOAA-17 (M)	NOAA-18 (N)	NOAA-19 (P)
Launch Date	N/A	5/13/1998	9/21/2000	6/24/2002	5/20/2005	02/06/2009
Decommission Date	N/A		6/09/2014	4/10/2013		
AMSU-A1	EM 101 @NG	s/n 103	s/n 102 1	s/n 104	s/n 109	s/n 107
AMSU-A2	EM 101 @ NG	s/n 102	s/n 103	s/n 104	s/n 105	s/n 109 @ LM
AMSU-B		s/n FM1	s/n FM2	s/n FM3	N/A	N/A
AVHRR	EM @ ITT	s/n 302	s/n 301	s/n 304	s/n 306	s/n 308
HIRS	HETM @ ITT	s/n 302	s/n 301	s/n 303	s/n 305	s/n308
SBUV	SBUV @ GSFC	N/A	s/n FM3	s/n FM6	s/n FM7	s/n FM8
SEM	EM @ Pan	s/n PFM	s/n FM1	s/n FM2	s/n FM3	s/n FM7
DTR/SSR	EM @ L3	s/n 408,9,10, 11,13	s/n 403,4,5, 6,12	s/n 401,7,14, 15,452	s/n 451,3,4	s/n 456,7,8
SARR		s/n FM7	s/n FM8	s/n FM9	s/n FM10	s/n FM12
SARP	REM	s/n FM1	s/n FM2	s/n FM3	s/n FM4	s/n FM3

	@ MetOp					
DCS	REM @ MetOp	s/n FM1	s/n FM2	s/n FM3	s/n FM4	s/n FM3
MHS		N/A	N/A	N/A	s/n FM1	s/n FM2

 Not Operational
 Operational
 Limited Operations
 Decommissioned

D-2. MetOp Program Instrument Utilization Status				
	MetOp-1 (B)	MetOp-2 (A)	MetOp-3 (C)	Notes:
Launch Date	9/17/2012	10/19/2006	Planned in 2017	
AMSU-A1	s/n 108 @ NG	s/n 106	s/n 105 @ NG	s/n 202 on Aqua
AMSU-A2	s/n 106 @ NG	s/n 108	s/n 107 @ NG	s/n 202 on Aqua
AVHRR	s/n 307 on Spacecraft	s/n 305	s/n 309 @ IT	Mass Model @ MSS
HIRS	s/n 307 on Spacecraft	s/n 306		Mass Model @ MSS
SEM	s/n FM4 @ MetOp	s/n FM6		
SARR	s/n FM11 @ MetOp	s/n FM13		
SARP	s/n FM 1 @ MetOp	s/n FM2		
MHS		s/n FM3		

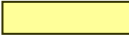
 Not Operational
 Operational
 Limited Operations

In addition, this appendix contains information that was formerly reported in *NOAA Technical Memorandum 107, Appendix B* (Planet, 1988). This information includes coefficients necessary for calibration purposes which are primarily used by High Resolution Picture Transmission (HRPT) and Direct Sounder Broadcast (DSB) service users. Some of the coefficients may also be useful to Automatic Picture Transmission (APT) data users.

D.1 NOAA-15 (K)

Launch date: May 13, 1998

Operational dates: December 15, 1998 to present

Morning orbit: 1930 LST ascending node, 0730 LST descending node

AVHRR instrument: 6 channels (AVHRR/3)

Spacecraft ID: 4

Abnormalities: During NOAA-15 activation and evaluation, it was determined that AMSU-A channels 7 and 15 were switched. This switch should be transparent to Level 1b users as the channels were corrected (switched back) by the ingest software, however, direct readout users should be aware of this problem. Only the radiometric data was affected, the housekeeping temperatures, antenna patterns, beam efficiency and beam widths of channels 15 and 7 oscillators are correct as they are now and were not affected by the switch. Band pass for channels 7 and 15 was also not affected due to extremely broad rf-detectors.

The NOAA-15 AMSU-B instrument is experiencing RFI contamination whose effect is dependent upon channel, geographic location, and current spacecraft antenna configuration. Calculations for generation of corrections for this contamination is an on- going effort. For the latest corrections needed for processing of this data see Appendix M.

On 10 July 2000, there was an apparent failure of the NOAA-15 AVHRR scan motor. HRPT and APT image data was missing through July 12, orbit 11250. On this orbit, AVHRR synchronization was restarted and HRPT and APT image data temporarily resumed. AVHRR synchronization was again lost 22 July on orbit 11395. Tests during December 2000 and January 2001 have shown that lowering the temperature of the instrument has restored a degree of stability. Beginning 20 March 2001, NOAA began to resynchronize the AVHRR once daily at 0730 UTC. The AVHRR has shown the ability to retain synchronization for longer periods with this daily reset. During the time of the resynchronization, there is a very brief disruption on all data in the HRPT transmission. When the AVHRR is in synchronization, usable images may be obtained. When the AVHRR synchronization is out of limits, images are unusable. HRPT transmitter will remain ON; the APT transmitter turned ON at 1611 UTC, 15 March 2001. At 1820 UTC, on 30 October 2000, the NOAA-15 AMSU-A Channel 14 failed and is no longer usable.

Table D.1-1 contains the measured channel characteristics for NOAA-15 AMSU-A (channels 1-15) and AMSU-B (channels 16-20). Detailed information on the terminology used in this table can be found in Section 3.3.2.1.

Table D.1-1. Measured Channel Characteristics for NOAA-15 AMSU-A and AMSU-B.							
Ch #	Instrument/ Serial #	Central Frequency (Ghz)	Central Wavenumber (cm ⁻¹)	I/F Frequencies (GHz)			
				Sideband 1		Sideband 2	
				Begin (f ₁)	End (f ₂)	Begin (f ₃)	End (f ₄)
1*	A2/ PFM	23.800370	0.793894	0.00850	0.13551	N/A	N/A
2*	A2/PFM	31.400420	1.047405	0.00897	0.08957	N/A	N/A
3*	A1-2/FM1	50.299910	1.677824	0.00895	0.08952	N/A	N/A
4*	A1-2/FM1	52.799390	1.761198	0.00890	0.19916	N/A	N/A
5	A1-2/FM1	53.595410	1.787750	0.03110	0.19930	N/A	N/A
6*	A1-1/FM1	54.399530	1.814573	0.00894	0.19921	N/A	N/A

7*	A1-1/FM1	54.940640	1.832622	0.00891	0.19919	N/A	N/A
8*	A1-2/FM1	55.498700	1.851237	0.00891	0.16408	N/A	N/A
9*	A1-1/FM1	57.290329	1.911000	0.00891	0.16412	N/A	N/A
10	A1-1/FM1	57.290329	1.911000	0.17916	0.25574	N/A	N/A
11	A1-1/FM1	57.290329	1.911000	0.257435	0.292545	0.353570	0.387850
12	A1-1/FM1	57.290329	1.911000	0.292745	0.308035	0.337050	0.352130
13	A1-1/FM1	57.290329	1.911000	0.308315	0.316245	0.328320	0.336240
14	A1-1/FM1	57.290329	1.911000	0.316200	0.319120	0.325370	0.328310
15*	A1-1/FM1	88.997000	2.968620	0.49871	1.49820	N/A	N/A
16*	B/PFM	88.992000	2.968453	0.3990	1.4050	N/A	N/A
17*	B/PFM	149.992000	5.003194	0.3980	1.4010	N/A	N/A
18	B/PFM	183.312000	6.114630	0.762	1.243	N/A	N/A
19	B/PFM	183.312000	6.114630	2.512	3.491	N/A	N/A
20	B/PFM	183.312000	6.114630	6.002	7.873	N/A	N/A
* The lower frequency cutoff in these single passband channels is due to the stop band.							

Table D.1-2 contains the Internal Warm Temperature (IWT) PRT count to temperature coefficients for the NOAA-15 HIRS/3 instrument.

Table D.1-2. NOAA-15 IWT PRT Count to Temperature Coefficients for HIRS/3.				
a₀	a₁	a₂	a₃	a₄
301.42859	6.5398670E-03	8.9808960E-08	4.7877130E-11	1.3453590E-15
301.44106	6.5306330E-03	8.7115040E-08	4.7387900E-11	1.4460280E-15
301.43252	6.5332780E-03	8.2485710E-08	4.7301670E-11	1.6099050E-15
301.39868	6.5244370E-03	8.0380230E-08	4.7093000E-11	1.6976440E-15

The slope and intercept for the NOAA-15 HIRS/3 visible channel (Channel 20) are given in Table D.1-3.

Table D.1-3. NOAA-15 HIRS/3 Channel 20 Slope and Intercept (Albedo %).		
Source	Slope	Intercept
Pre-launch calibration	0.02336	36.0500
Post-launch calibration (May 2002)	0.03174	47.1100
Notes:		
1. To retrieve the albedo, use the following equation: $\text{albedo} = (\text{intercept} + \text{slope} \times C) / \cos(z)$ where C=earth view count, z=solar zenith angle. Both C and z vary from pixel to pixel.		
2. Post-launch calibration is traceable to the Libyan desert calibration site, for which the HIRS channel 20 albedo is ~36.1%. Further update to these coefficients may be needed as the instrument degrades over time.		

Table D.1-4 contains the NOAA-15 HIRS/3 central wave numbers and band correction coefficients for the thermal channels.

Table D.1-4. NOAA-15 HIRS/3 Central Wave Numbers and Band Correction Coefficients.			
Channel	λ_c	b	c
1	669.08	-0.008	1.00001
2	678.80	0.019	0.99993
3	690.45	0.025	0.99989
4	703.14	0.019	0.99991
5	715.92	0.023	0.99989
6	731.71	0.015	0.99992
7	747.66	0.024	0.99990
8	897.37	0.092	0.99968
9	1032.11	0.049	0.99985
10	801.12	0.020	0.99993
11	1362.43	0.076	0.99980
12	1529.83	0.108	0.99976
13	2188.20	0.026	0.99996
14	2209.90	0.019	0.99996
15	2235.26	0.020	0.99996
16	2241.96	0.022	0.99995
17	2418.99	0.034	0.99995
18	2518.76	0.046	0.99993
19	2657.26	0.297	0.99959

Table D.1-5 contains the normalized response functions (from 30-point spline fit) for NOAA-15 HIRS/302.

Table D.1-5. Normalized Response Functions for the NOAA-15 HIRS/3 Thermal Channels.				
Channel 1				
Starting Wave #: 0.66175E+03			Increment: 0.56034E+00	
0.00000E+00	0.32939E-02	0.65401E-02	0.96910E-02	0.13817E-01
0.21106E-01	0.30079E-01	0.38578E-01	0.49194E-01	0.70476E-01
0.86165E-01	0.12766E+00	0.18197E+00	0.24632E+00	0.27480E+00
0.23646E+00	0.17394E+00	0.10226E+00	0.57393E-01	0.20909E-01
0.11023E-01	0.94119E-02	0.66969E-02	0.40016E-02	0.20532E-02
0.80436E-03	0.11427E-03	0.00000E+00	0.00000E+00	0.00000E+00
Channel 2				
Starting Wave #: 0.66400E+03			Increment: 0.10138E+01	
0.00000E+00	0.10207E-02	0.17235E-02	0.20523E-02	0.43811E-02
0.70835E-02	0.11622E-01	0.19724E-01	0.31572E-01	0.45854E-01
0.58223E-01	0.67788E-01	0.72957E-01	0.75792E-01	0.76830E-01
0.78435E-01	0.80232E-01	0.81732E-01	0.78889E-01	0.69574E-01
0.50941E-01	0.32111E-01	0.16631E-01	0.98381E-02	0.51098E-02
0.36044E-02	0.16205E-02	0.83029E-03	0.34008E-03	0.76634E-07

Channel 3				
Starting Wave #: 0.67080E+03			Increment: 0.12659E+01	
0.00000E+00	0.52027E-03	0.10972E-02	0.17871E-02	0.22353E-02
0.47390E-02	0.73462E-02	0.12569E-01	0.18867E-01	0.27386E-01
0.36308E-01	0.43376E-01	0.49612E-01	0.52055E-01	0.54682E-01
0.56496E-01	0.60120E-01	0.65654E-01	0.71937E-01	0.71751E-01
0.61023E-01	0.41755E-01	0.23764E-01	0.12027E-01	0.59204E-02
0.34653E-02	0.17967E-02	0.12283E-02	0.60571E-03	0.11662E-06
Channel 4				
Starting Wave #: 0.68400E+03			Increment: 0.14138E+01	
0.00000E+00	0.47826E-03	0.50779E-03	0.87385E-03	0.17929E-02
0.35457E-02	0.74359E-02	0.16299E-01	0.31114E-01	0.46958E-01
0.57202E-01	0.60540E-01	0.62286E-01	0.64244E-01	0.65648E-01
0.64490E-01	0.60302E-01	0.52630E-01	0.42151E-01	0.29385E-01
0.18168E-01	0.97779E-02	0.52378E-02	0.27182E-02	0.17001E-02
0.80046E-03	0.75851E-03	0.15744E-03	0.22634E-03	0.72697E-07
Channel 5				
Starting Wave #: 0.69400E+03			Increment: 0.15172E+01	
0.00000E+00	0.36017E-03	0.62393E-03	0.84348E-03	0.16106E-02
0.30435E-02	0.57733E-02	0.11165E-01	0.20170E-01	0.32399E-01
0.43565E-01	0.50354E-01	0.53723E-01	0.55054E-01	0.55829E-01
0.55752E-01	0.54801E-01	0.52667E-01	0.47555E-01	0.39901E-01
0.29873E-01	0.19693E-01	0.11099E-01	0.64664E-02	0.37347E-02
0.19062E-02	0.10010E-02	0.19575E-03	0.00000E+00	0.00000E+00
Channel 6				
Starting Wave #: 0.71210E+03			Increment: 0.13872E+01	
0.00000E+00	0.56108E-03	0.10017E-02	0.21202E-02	0.36083E-02
0.64333E-02	0.10274E-01	0.16673E-01	0.25322E-01	0.34837E-01
0.43644E-01	0.50434E-01	0.54946E-01	0.57341E-01	0.60137E-01
0.62162E-01	0.65358E-01	0.64877E-01	0.57775E-01	0.42985E-01
0.27057E-01	0.15031E-01	0.78002E-02	0.41595E-02	0.27309E-02
0.13510E-02	0.10760E-02	0.77409E-03	0.40409E-03	0.72294E-07
Channel 7				
Starting Wave #: 0.72180E+03			Increment: 0.16517E+01	
0.00000E+00	0.11752E-03	0.29985E-03	0.33552E-03	0.81506E-03
0.13106E-02	0.25025E-02	0.47308E-02	0.91602E-02	0.16600E-01
0.26658E-01	0.36244E-01	0.42599E-01	0.46187E-01	0.48510E-01
0.50784E-01	0.52325E-01	0.54082E-01	0.54451E-01	0.51305E-01
0.42130E-01	0.28745E-01	0.16861E-01	0.88379E-02	0.47100E-02
0.24444E-02	0.14137E-02	0.87440E-03	0.43745E-03	0.65706E-07
Channel 8				
Starting Wave #: 0.85000E+03			Increment: 0.31034E+01	
0.00000E+00	0.17764E-03	0.20750E-03	0.26786E-03	0.47372E-03

0.78371E-03	0.14746E-02	0.29054E-02	0.57231E-02	0.10946E-01
0.17302E-01	0.22555E-01	0.25152E-01	0.26348E-01	0.26716E-01
0.27017E-01	0.27067E-01	0.26634E-01	0.25446E-01	0.23247E-01
0.19519E-01	0.14199E-01	0.86735E-02	0.46545E-02	0.23776E-02
0.11878E-02	0.64851E-03	0.33283E-03	0.20703E-03	0.35255E-07
Channel 9				
Starting Wave #: 0.99707E+03			Increment: 0.23459E+01	
0.00000E+00	0.18249E-03	0.26350E-03	0.49650E-03	0.56343E-03
0.11279E-02	0.19487E-02	0.37968E-02	0.76415E-02	0.14840E-01
0.24445E-01	0.32611E-01	0.36258E-01	0.36672E-01	0.36529E-01
0.36582E-01	0.36529E-01	0.36116E-01	0.34757E-01	0.31119E-01
0.23545E-01	0.14645E-01	0.80543E-02	0.38586E-02	0.16268E-02
0.10292E-02	0.56249E-03	0.28435E-03	0.22742E-03	0.52460E-07
Channel 10				
Starting Wave #: 0.78380E+03			Increment: 0.11483E+01	
0.00000E+00	0.53843E-03	0.87936E-03	0.96862E-03	0.22315E-02
0.39474E-02	0.88174E-02	0.16599E-01	0.29076E-01	0.41038E-01
0.50637E-01	0.54352E-01	0.57350E-01	0.60208E-01	0.64367E-01
0.67167E-01	0.67241E-01	0.65530E-01	0.62929E-01	0.59337E-01
0.53871E-01	0.42883E-01	0.28035E-01	0.15958E-01	0.85759E-02
0.42317E-02	0.19140E-02	0.14976E-02	0.75413E-03	0.16432E-06
Channel 11				
Starting Wave #: 0.13253E+04			Increment: 0.27241E+01	
0.00000E+00	0.42629E-03	0.81626E-03	0.19941E-02	0.37878E-02
0.57046E-02	0.91031E-02	0.16125E-01	0.23841E-01	0.23980E-01
0.19730E-01	0.18118E-01	0.20461E-01	0.24726E-01	0.28087E-01
0.30322E-01	0.30335E-01	0.28091E-01	0.23934E-01	0.19864E-01
0.15983E-01	0.10964E-01	0.57210E-02	0.24850E-02	0.10926E-02
0.61166E-03	0.39834E-03	0.26156E-03	0.12928E-03	0.11602E-07
Channel 12				
Starting Wave #: 0.14910E+04			Increment: 0.28966E+01	
0.00000E+00	0.34429E-03	0.60979E-03	0.13966E-02	0.38356E-02
0.84802E-02	0.18273E-01	0.22411E-01	0.23474E-01	0.21299E-01
0.20082E-01	0.20215E-01	0.20711E-01	0.21263E-01	0.20354E-01
0.19051E-01	0.17112E-01	0.16175E-01	0.16028E-01	0.15857E-01
0.15328E-01	0.13875E-01	0.11752E-01	0.86461E-02	0.46149E-02
0.29324E-02	0.83218E-03	0.21452E-03	0.78820E-04	0.10960E-07
Channel 13				
Starting Wave #: 0.21630E+04			Increment: 0.18966E+01	
0.00000E+00	0.12787E-03	0.48471E-03	0.12972E-02	0.20185E-02
0.50835E-02	0.11621E-01	0.24603E-01	0.38711E-01	0.47357E-01
0.47539E-01	0.41533E-01	0.35084E-01	0.32180E-01	0.31896E-01
0.32871E-01	0.32882E-01	0.32139E-01	0.29213E-01	0.24118E-01

0.18861E-01	0.13703E-01	0.91581E-02	0.58140E-02	0.39731E-02
0.21066E-02	0.13614E-02	0.10153E-02	0.54376E-03	0.71990E-07
Channel 14				
Starting Wave #: 0.21818E+04			Increment: 0.20241E+01	
0.00000E+00	0.29215E-03	0.60435E-03	0.95656E-03	0.14049E-02
0.27948E-02	0.57713E-02	0.10378E-01	0.17651E-01	0.25929E-01
0.33242E-01	0.39288E-01	0.43209E-01	0.45000E-01	0.45519E-01
0.44696E-01	0.43732E-01	0.41166E-01	0.34622E-01	0.25367E-01
0.15801E-01	0.80419E-02	0.39433E-02	0.17110E-02	0.91773E-03
0.62598E-03	0.54570E-03	0.50838E-03	0.37302E-03	0.61881E-07
Channel 15				
Starting Wave #: 0.22095E+04			Increment: 0.19621E+01	
0.00000E+00	0.50321E-03	0.12518E-02	0.17160E-02	0.37800E-02
0.70577E-02	0.11314E-01	0.17635E-01	0.24260E-01	0.30258E-01
0.36423E-01	0.42021E-01	0.45221E-01	0.47049E-01	0.46477E-01
0.44184E-01	0.41379E-01	0.36396E-01	0.28679E-01	0.19890E-01
0.11547E-01	0.61416E-02	0.31494E-02	0.13120E-02	0.85235E-03
0.47529E-03	0.30542E-03	0.24114E-03	0.18869E-03	0.67652E-07
Channel 16				
Starting Wave #: 0.22110E+04			Increment: 0.21379E+01	
0.00000E+00	0.30985E-03	0.56145E-03	0.70985E-03	0.12772E-02
0.23185E-02	0.42811E-02	0.79867E-02	0.13991E-01	0.21675E-01
0.29291E-01	0.34957E-01	0.38026E-01	0.38618E-01	0.37195E-01
0.35207E-01	0.34838E-01	0.38095E-01	0.43496E-01	0.40893E-01
0.25541E-01	0.10537E-01	0.39553E-02	0.18360E-02	0.94281E-03
0.54048E-03	0.33507E-03	0.23351E-03	0.14916E-03	0.21084E-07
Channel 17				
Starting Wave #: 0.23863E+04			Increment: 0.21034E+01	
0.00000E+00	0.62116E-03	0.11412E-02	0.16829E-02	0.22964E-02
0.27390E-02	0.33570E-02	0.47016E-02	0.10421E-01	0.21479E-01
0.34829E-01	0.41467E-01	0.37632E-01	0.31021E-01	0.27041E-01
0.25477E-01	0.25341E-01	0.26024E-01	0.26945E-01	0.27542E-01
0.27375E-01	0.25892E-01	0.22429E-01	0.17705E-01	0.12907E-01
0.85814E-02	0.54304E-02	0.27359E-02	0.63696E-03	0.00000E+00
Channel 18				
Starting Wave #: 0.24775E+04			Increment: 0.29103E+01	
0.00000E+00	0.25715E-03	0.50880E-03	0.80184E-03	0.13001E-02
0.22387E-02	0.41420E-02	0.79261E-02	0.14461E-01	0.22072E-01
0.26408E-01	0.26942E-01	0.26198E-01	0.25680E-01	0.25531E-01
0.25423E-01	0.24979E-01	0.23817E-01	0.21780E-01	0.18734E-01
0.14972E-01	0.10972E-01	0.73594E-02	0.45943E-02	0.27771E-02
0.16933E-02	0.10453E-02	0.67087E-03	0.34089E-03	0.29415E-07
Channel 19				

Starting Wave #: 0.25460E+04			Increment: 0.75517E+01	
0.00000E+00	0.85182E-04	0.14446E-03	0.16078E-03	0.30641E-03
0.53559E-03	0.10332E-02	0.21893E-02	0.47962E-02	0.87046E-02
0.10621E-01	0.97837E-02	0.87175E-02	0.83014E-02	0.84900E-02
0.89560E-02	0.92338E-02	0.91367E-02	0.88732E-02	0.88140E-02
0.89836E-02	0.75928E-02	0.40372E-02	0.16529E-02	0.68330E-03
0.30815E-03	0.15149E-03	0.89898E-04	0.41749E-04	0.13552E-08

Table D.1-6 contains the pre-launch calibration coefficients (albedo representation) for the AVHRR/3 instrument on NOAA-15.

Table D.1-6. NOAA-15 AVHRR/3 Pre-launch Calibration Coefficients (Albedo Representation).			
Channel #	Contents	Slope	Intercept
1	Low albedo range (0-25%)	0.0568	-2.1874
	High albedo range (26 - 100%)	0.1633	-54.9928
2	Low albedo range (0-25%)	0.0596	-2.4096
	High albedo range (26 - 100%)	0.1629	-55.2436
3A	Low albedo range (0-12.5%)	0.0275	-1.0684
	High albedo range (12.6 - 100%)	0.1846	-78.1691

Note:
The albedo ranges given in parentheses are nominal; the points of intersection of the two regression lines are located at 496, 511, and 491 counts (rounded off to the nearest integer) for Channels 1,2, and 3A, respectively. This information is based on the data in Instruction Manual and Alignment/Calibration Handbook and Optical Data, submitted to NASA/GSFC by ITT Aerospace/Communications (Report 8172836, Rev A), October 1997.

Table D.1-7 contains NOAA-15 AVHRR/3 visible channel information such as equivalent width, w , effective central wavelength, λ_e , and in-band solar irradiance, F .

Table D.1-7. NOAA-15 AVHRR/3 Visible Channel Information.			
Channel	w (μm)	λ_e (μm)	F (W/m^2)
1	0.084	0.632	138.7
2	0.228	0.843	235.4
3A	0.044	1.607	10.6

Note:
These quantities are based on the solar irradiance data of Neckel and Labs (1984), which is a widely used source of such data.

Table D.1-8 contains NOAA-15 coefficients d_0 , d_1 , d_2 , d_3 , and d_4 that relate temperature, T_{PRT} (Kelvin), of each PRT to count value, C_{PRT} , by the equation:

$$T_{\text{PRT}} = d_0 + d_1 C_{\text{PRT}} + d_2 C_{\text{PRT}}^2 + d_3 C_{\text{PRT}}^3 + d_4 C_{\text{PRT}}^4$$

Table D.1-8. NOAA-15 AVHRR/3 Conversion Coefficients					
PRT	d₀	d₁	d₂	d₃	d₄
1	276.60157	0.051045	1.36328E-06	0	0
2	276.62531	0.050909	1.47266E-06	0	0
3	276.67413	0.050907	1.47656E-06	0	0
4	276.59258	0.050966	1.47656E-06	0	0

Table D.1-9 contains the PRT weighting factors for NOAA-15.

Table D.1-9. NOAA-15 PRT Weighting Factors.			
b₁	b₂	b₃	b₄
0.25	0.25	0.25	0.25

Table D.1-10 contains a summary of the spectral response data as a function of wavenumber for all channels of the NOAA-15 AVHRR/3.

Table D.1-10. Summary of NOAA-15 AVHRR Spectral Response Data (as a Function of Wavenumber) for Each Channel.		
Channel 1		
The peak wavenumber was at 15570.00 and had a value of 1.00		
File starting point is at wavenumber = 12050.00		
File ending point is at wavenumber = 23250.00		
Moment Center Wavenumber = 15859.7062		
Percent line at which curve crosses	Wavenumber (cm⁻¹)	Microns
0.10%	14196.6582	0.7044
1.00%	14436.7100	0.6927
5.00%	14573.7559	0.6862

10.00%	14624.1328	0.6838		
20.00%	14671.6406	0.6816		
50.00%	14739.7900	0.6784		
80.00%	14788.2295	0.6762		
80.00%	16680.6641	0.5995		
50.00%	17060.6777	0.5861		
20.00%	17131.7539	0.5837		
10.00%	17175.1855	0.5822		
5.00%	17219.9707	0.5807		
1.00%	17337.4453	0.5768		
0.10%	17584.0098	0.5687		
Area Point Limits	Lower (cm⁻¹)	Upper (cm⁻¹)		
99%	14642.3309	17155.1995		
96%	14744.7150	17049.7751		
70%	15062.9977	16661.1732		
50%	15288.7517	16404.3671		
0% (area center)	15825.7003	15825.7003		
Crossing	Lower (cm⁻¹)	Upper (cm⁻¹)	Width (cm⁻¹)	Center (cm⁻¹)
80%	14788.2295	16680.6641	1892.4346	15734.4473
50%	14739.7900	17060.6777	2320.8877	15900.2344
20%	14671.6406	17131.7539	2460.1133	15901.6973
5%	14573.7559	17219.9707	2646.2148	15896.8633
Channel 2				
The peak wavenumber was at 12135.00 and had a value of 1.00				
File starting point is at wavenumber = 9330.00				
File ending point is at wavenumber = 19995.00				

Moment Center Wavenumber = 12016.4406				
Percent line at which curve crosses		Wavenumber (cm ⁻¹)		Microns
1.00%		9881.1152		1.0120
5.00%		9968.6484		1.0031
10.00%		10019.4678		0.9981
20.00%		10089.9189		0.9911
50.00%		10211.9961		0.9792
80.00%		10646.5342		0.9393
80.00%		13493.4717		0.7411
50.00%		13657.6465		0.7322
20.00%		13993.0322		0.7146
10.00%		14097.4355		0.7093
5.00%		14170.5137		0.7057
1.00%		14317.1592		0.6985
0.10%		14511.1816		0.6891
Area Point Limits	Lower (cm ⁻¹)		Upper (cm ⁻¹)	
99%	10082.9547		14040.9927	
96%	10221.7553		13840.1591	
70%	10794.9054		13213.8136	
50%	11159.5927		12853.9068	
0% (area center)	12023.7506		12023.7506	
Crossing	Lower (cm ⁻¹)	Upper (cm ⁻¹)	Width (cm ⁻¹)	Center (cm ⁻¹)
80%	10646.5342	13493.4717	2846.9375	12070.0029
50%	10211.9961	13657.6465	3445.6504	11934.8213
20%	10089.9189	13993.0322	3903.1133	12041.4756
5%	9968.6484	14170.5137	4201.8652	12069.5811

Channel 3a		
The peak wavenumber was at 6250.00 and had a value of 1.00		
File starting point is at wavenumber = 5785.00		
File ending point is at wavenumber = 6705.00		
Moment Center Wavenumber = 6223.5656		
Percent line at which curve crosses	Wavenumber (cm⁻¹)	Microns
0.10%	6068.5703	1.6478
1.00%	6089.9004	1.6421
5.00%	6106.3730	1.6376
10.00%	6113.0332	1.6358
20.00%	6119.4927	1.6341
50.00%	6129.5625	1.6314
80.00%	6144.6167	1.6274
80.00%	6145.7290	1.6271
80.00%	6177.5620	1.6188
80.00%	6299.9307	1.5873
50.00%	6311.2593	1.5845
20.00%	6323.8169	1.5813
10.00%	6331.4009	1.5794
5.00%	6339.0327	1.5775
Area Point Limits	Lower (cm⁻¹)	Upper (cm⁻¹)
99%	6106.2041	6329.8381
96%	6120.0795	6314.1591
70%	6152.3744	6281.6202
50%	6174.8438	6263.4136
0% (area center)	6220.1445	6220.1445

Crossing	Lower (cm⁻¹)	Upper (cm⁻¹)	Width (cm⁻¹)	Center (cm⁻¹)
80%	6177.5620	6299.9307	122.3687	6238.7466
50%	6129.5625	6311.2593	181.6968	6220.4111
20%	6119.4927	6323.8169	204.3242	6221.6548
5%	6106.3730	6339.0327	232.6597	6222.7031
Channel 3b				
The peak wavenumber was at 2676.20 and had a value of 1.00				
File starting point is at wavenumber = 2222.80				
File ending point is at wavenumber = 3355.50				
Moment Center Wavenumber = 2694.8241				
Percent line at which curve crosses	Wavenumber (cm⁻¹)		Microns	
0.10%	2440.8918		4.0969	
1.00%	2471.0073		4.0469	
5.00%	2497.7480		4.0036	
10.00%	2514.3342		3.9772	
20.00%	2546.5537		3.9269	
50.00%	2587.1865		3.8652	
80.00%	2604.4082		3.8396	
80.00%	2808.4602		3.5607	
50.00%	2822.0723		3.5435	
20.00%	2833.9434		3.5287	
10.00%	2841.1433		3.5197	
5.00%	2848.0925		3.5111	
1.00%	2866.2263		3.4889	
0.10%	2895.4199		3.4537	
Area Point Limits	Lower (cm⁻¹)		Upper (cm⁻¹)	

99%	2503.7638		2840.0060	
96%	2534.1631		2825.0553	
70%	2610.1426		2784.2844	
50%	2635.4594		2757.6612	
0% (area center)	2695.9743		2695.9743	
Crossing	Lower (cm⁻¹)	Upper (cm⁻¹)	Width (cm⁻¹)	Center (cm⁻¹)
80%	2604.4082	2808.4602	204.0520	2706.4343
50%	2587.1865	2822.0723	234.8857	2704.6294
20%	2546.5537	2833.9434	287.3896	2690.2485
5%	2497.7480	2848.0925	350.3445	2672.9204
Channel 4				
The peak wavenumber was at 903.30 and had a value of 1.00				
File starting point is at wavenumber = 781.30				
File ending point is at wavenumber = 1136.10				
Moment Center Wavenumber = 925.7260				
Percent line at which curve crosses		Wavenumber (cm⁻¹)	Microns	
0.10%		859.7016	11.6319	
1.00%		867.3125	11.5299	
5.00%		872.5100	11.4612	
10.00%		874.8829	11.4301	
20.00%		877.6683	11.3938	
50.00%		883.1485	11.3231	
80.00%		888.8125	11.2510	
80.00%		961.7256	10.3980	
50.00%		968.2725	10.3277	
20.00%		974.5762	10.2609	

10.00%	978.2267	10.2226		
5.00%	981.1376	10.1923		
1.00%	987.1260	10.1304		
0.10%	996.2394	10.0377		
Area Point Limits	Lower (cm⁻¹)	Upper (cm⁻¹)		
99%	875.3695	978.2872		
96%	880.8578	971.8187		
70%	895.5374	955.8641		
50%	903.9871	946.9393		
0% (area center)	925.4075	925.4075		
Crossing	Lower (cm⁻¹)	Upper (cm⁻¹)	Width (cm⁻¹)	Center (cm⁻¹)
80%	888.8125	961.7256	72.9131	925.2691
50%	883.1485	968.2725	85.1240	925.7105
20%	877.6683	974.5762	96.9078	926.1223
5%	872.5100	981.1376	108.6276	926.8239
Channel 5				
The peak wavenumber was at 850.30 and had a value of 1.00				
File starting point is at wavenumber = 714.30				
File ending point is at wavenumber = 999.80				
Moment Center Wavenumber = 839.4649				
Percent line at which curve crosses	Wavenumber (cm⁻¹)	Microns		
0.10%	792.1827	12.6234		
1.00%	796.4730	12.5554		
5.00%	799.7806	12.5034		
10.00%	801.1653	12.4818		
20.00%	802.7150	12.4577		

50.00%	805.5098	12.4145		
80.00%	809.2590	12.3570		
80.00%	863.8686	11.5758		
50.00%	873.2330	11.4517		
20.00%	875.5717	11.4211		
10.00%	876.8835	11.4040		
5.00%	878.1039	11.3882		
1.00%	880.8443	11.3527		
0.10%	884.4832	11.3060		
Area Point Limits	Lower (cm⁻¹)	Upper (cm⁻¹)		
99%	801.8588	875.7782		
96%	805.0904	872.9889		
70%	815.6482	862.2832		
50%	823.0201	855.5149		
0% (area center)	839.8979	839.8979		
Crossing	Lower (cm⁻¹)	Upper (cm⁻¹)	Width (cm⁻¹)	Center (cm⁻¹)
80%	809.2590	863.8686	54.6096	836.5638
50%	805.5098	873.2330	67.7233	839.3714
20%	802.7150	875.5717	72.8567	839.1434
5%	799.7806	878.1039	78.3232	838.9423

Table D.1-11 contains the radiance-to-temperature coefficients for NOAA-15 AVHRR/3 Channels 3B, 4 and 5.

Table D.1-11. NOAA-15 AVHRR/3 Thermal Channel Temperature to Radiance Coefficients.			
	ν_c	A	B
Channel 3B	2695.9743	1.621256	0.998015
Channel 4	925.4075	0.337810	0.998719

Channel 5	839.8979	0.304558	0.999024
-----------	----------	----------	----------

Figures D.1-1 through D.1-6 contains the spectral response curves for NOAA-K AVHRR/3 Channels 1, 2, 3A, 3B, 4 and 5, respectively.

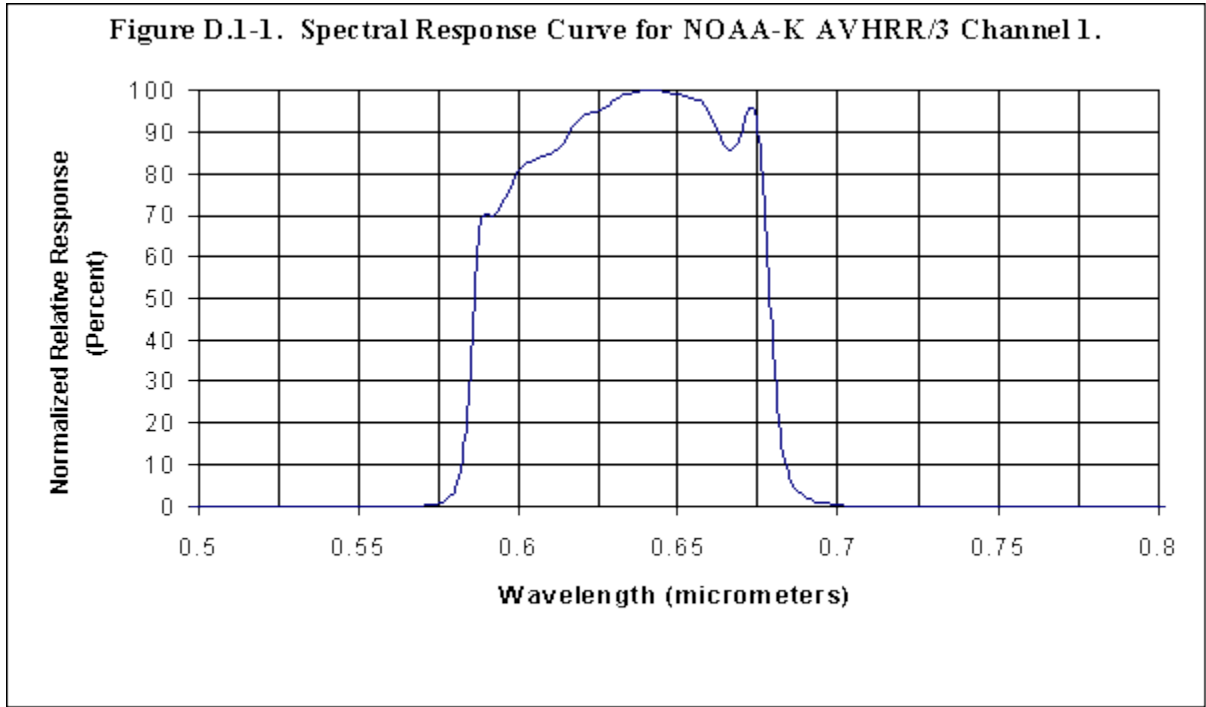

Figure D.1-1. Spectral Response Curve for NOAA-15 Channel 1.

Figure D.1-2. Spectral Response Curve for NOAA-K AVHRR/3 Channel 2.

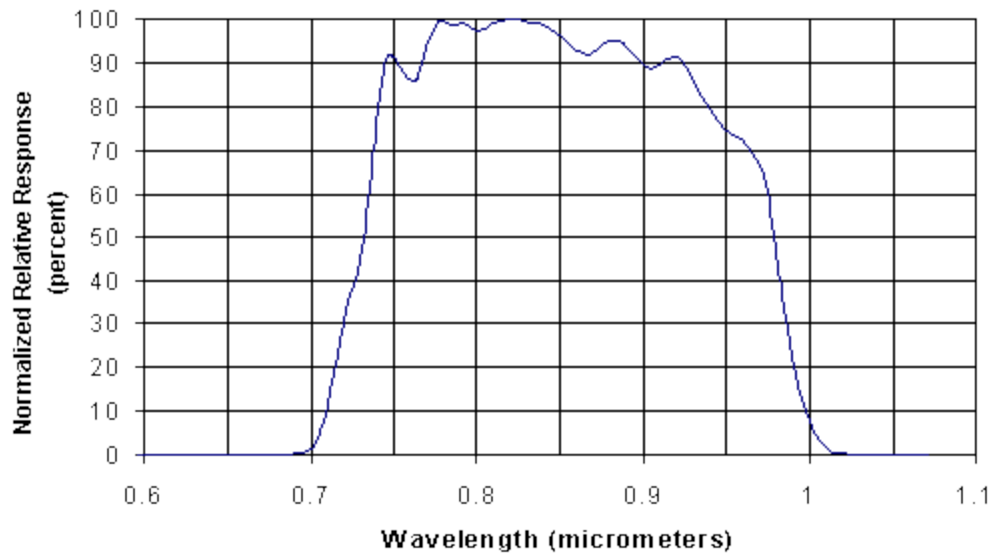

Figure D.1-2. Spectral Response Curve for NOAA-15 Channel 2.

Figure D.1-3. Spectral Response Curve for NOAA-K AVHRR/3 Channel 3A.

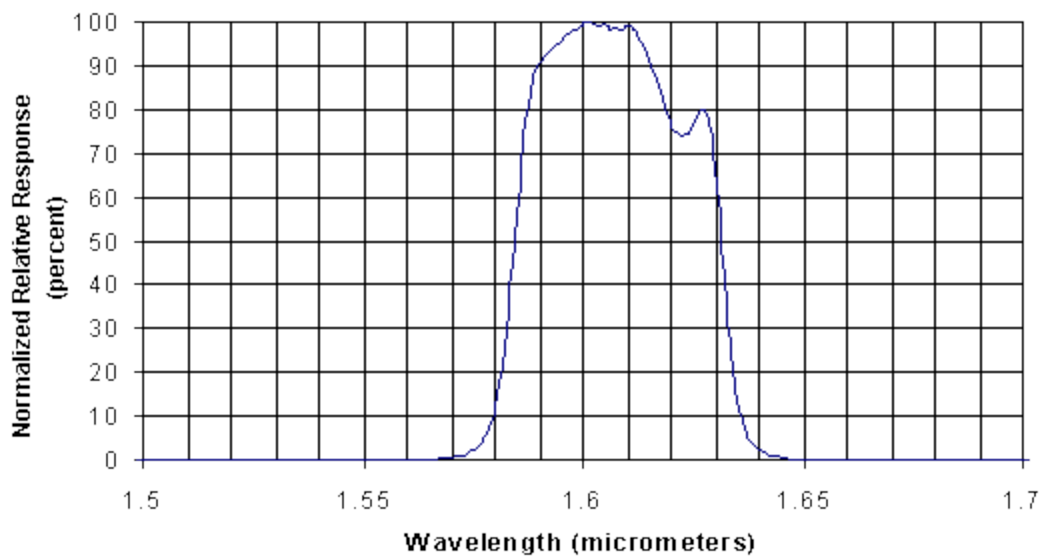

Figure D.1-3. Spectral Response Curve for NOAA-15 Channel 3A.

Figure D.1-4. Spectral Response Curve for NOAA-K AVHRR/3 Channel 3B.

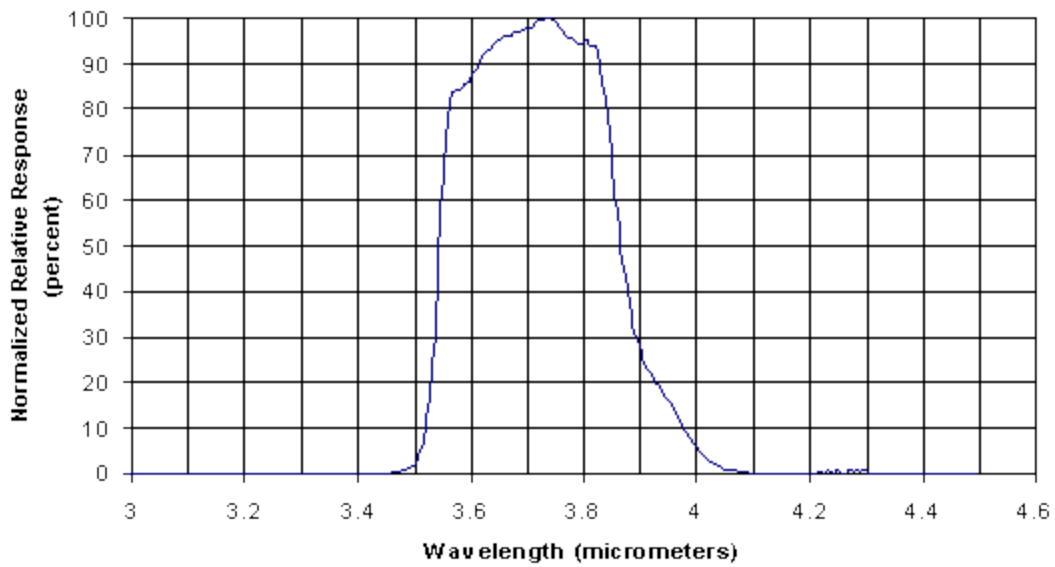

Figure D.1-4. Spectral Response Curve for NOAA-15 Channel 3B.

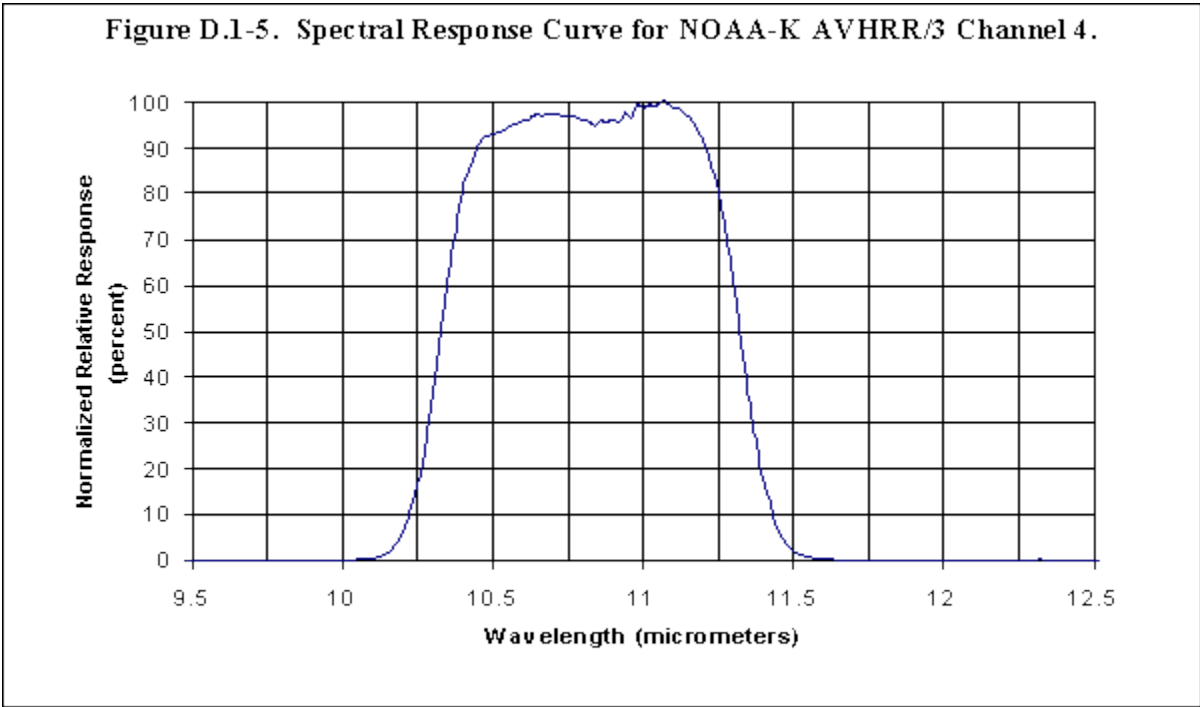

Figure D.1-5. Spectral Response Curve for NOAA-15 Channel 4.

Figure D.1-6. Spectral Response Curve for NOAA-K AVHRR/3 Channel 5.

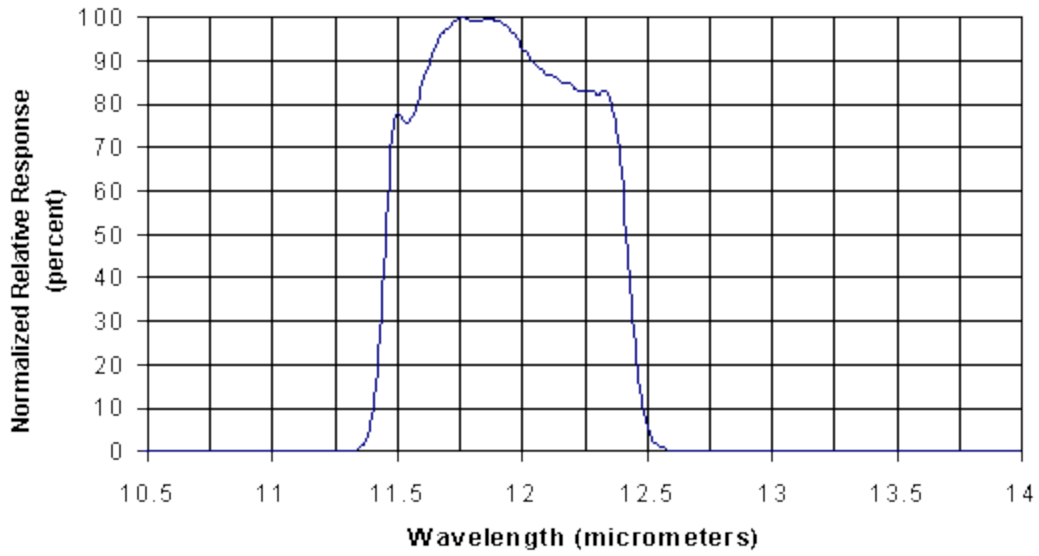

Figure D.1-6. Spectral Response Curve for NOAA-15 Channel 5.

Tables D.1-12 and D.1-13 contain the corresponding spectral response values for NOAA-15 AVHRR/3 Channels 1, 2, 3A and Channels 3B, 4 and 5, respectively. Note: Negative response values were caused by system response noise and are to be ignored but are included in the table for completeness.

Channel 1		Channel 2		Channel 3A	
Wavelength (microns)	Relative Response (percent)	Wavelength (microns)	Relative Response (percent)	Wavelength (microns)	Relative Response (percent)
0.43	5.10E-02	0.5	0.03894	1.49	-1.90E-03
0.432	1.19E-01	0.504	0.01249	1.491	-6.33E-03
0.434	1.40E-01	0.508	0.02187	1.492	5.16E-03
0.436	8.80E-02	0.512	0.02998	1.493	-2.13E-03
0.438	1.21E-01	0.516	0.009488	1.494	3.97E-03
0.44	1.16E-01	0.52	0.01019	1.495	-9.96E-03
0.442	8.49E-02	0.524	-0.00491	1.496	2.93E-02
0.444	5.34E-03	0.528	0.006321	1.497	-3.85E-02
0.446	2.30E-02	0.532	-0.00222	1.498	4.16E-03
0.448	4.66E-02	0.536	-0.01192	1.499	-1.55E-02
0.45	-4.27E-03	0.54	0.002725	1.5	8.48E-03
0.452	8.38E-03	0.544	-0.00512	1.501	2.19E-03
0.454	5.55E-02	0.548	-0.00228	1.502	3.16E-03
0.456	5.63E-02	0.552	0.007246	1.503	-1.23E-02
0.458	6.58E-03	0.556	-0.00127	1.504	-1.86E-02
0.46	4.96E-02	0.56	-0.00189	1.505	1.80E-03
0.462	4.31E-02	0.564	0.001851	1.506	-3.13E-02
0.464	6.03E-02	0.568	0.004808	1.507	-2.31E-03
0.466	5.21E-02	0.572	0.008145	1.508	-2.56E-02
0.468	1.05E-02	0.576	0.001293	1.509	1.62E-03
0.47	1.53E-02	0.58	0.00135	1.51	1.33E-02
0.472	2.08E-03	0.584	-0.00791	1.511	-6.64E-03
0.474	-7.83E-03	0.588	-0.00656	1.512	-2.19E-02
0.476	8.18E-03	0.592	-0.00088	1.513	-6.40E-03
0.478	1.93E-02	0.596	-0.00016	1.514	-2.65E-02
0.48	8.76E-03	0.6	-0.0055	1.515	1.43E-03
0.482	4.02E-02	0.604	-0.00321	1.516	3.86E-05
0.484	6.32E-02	0.608	-0.00324	1.517	-5.34E-03
0.486	2.14E-02	0.612	-0.00591	1.518	-3.34E-03

0.488	-1.29E-02	0.616	-0.00405	1.519	6.82E-03
0.49	2.46E-03	0.62	-0.00119	1.52	1.58E-02
0.492	5.22E-02	0.624	0.001046	1.521	-3.35E-03
0.494	1.48E-02	0.628	-0.00582	1.522	3.24E-02
0.496	-5.59E-03	0.632	-0.00477	1.523	-2.56E-03
0.498	2.90E-02	0.636	-0.00224	1.524	-2.16E-02
0.5	1.06E-02	0.64	0.001095	1.525	3.65E-03
0.502	2.52E-02	0.644	-0.00376	1.526	7.84E-03
0.504	2.47E-02	0.648	-0.00359	1.527	-3.30E-02
0.506	2.50E-02	0.652	-0.00098	1.528	-3.20E-02
0.508	2.76E-02	0.656	0.001316	1.529	3.40E-03
0.51	3.22E-02	0.66	0.000322	1.53	-4.08E-02
0.512	2.13E-02	0.664	0.004031	1.531	2.91E-02
0.514	1.68E-02	0.668	0.006376	1.532	2.81E-03
0.516	9.79E-03	0.672	0.01158	1.533	5.00E-03
0.518	2.84E-02	0.676	0.01339	1.534	8.14E-03
0.52	2.59E-02	0.68	0.02079	1.535	-2.19E-02
0.522	2.30E-02	0.684	0.03213	1.536	-3.05E-02
0.524	1.85E-02	0.688	0.07828	1.537	1.22E-03
0.526	2.49E-02	0.692	0.1949	1.538	-1.67E-02
0.528	1.62E-02	0.696	0.5394	1.539	-5.25E-03
0.53	2.15E-02	0.7	1.438	1.54	7.72E-03
0.532	5.90E-03	0.704	3.501	1.541	1.42E-03
0.534	1.51E-02	0.708	7.841	1.542	-1.08E-02
0.536	3.21E-02	0.712	14.89	1.543	1.34E-02
0.538	2.91E-02	0.716	22.62	1.544	3.64E-02
0.54	1.58E-02	0.72	30.04	1.545	-1.94E-02
0.542	1.83E-02	0.724	36.5	1.546	-2.86E-02
0.544	3.77E-02	0.728	42.02	1.547	-8.45E-03
0.546	2.90E-02	0.732	49.53	1.548	-6.78E-03
0.548	1.84E-02	0.736	61.6	1.549	1.16E-02
0.55	1.64E-02	0.74	76.18	1.55	1.14E-02
0.552	2.24E-02	0.744	88.13	1.551	-1.82E-02
0.554	2.27E-02	0.748	91.97	1.552	-2.77E-02
0.556	3.50E-02	0.752	90.25	1.553	1.66E-02
0.558	2.72E-02	0.756	87.63	1.554	-1.35E-02
0.56	2.23E-02	0.76	85.81	1.555	3.68E-05

0.562	3.61E-02	0.764	86.56	1.556	6.43E-02
0.564	5.43E-02	0.768	91.47	1.557	-2.39E-02
0.566	7.81E-02	0.772	96.24	1.558	-4.24E-03
0.568	8.79E-02	0.776	99.38	1.559	-8.29E-03
0.57	1.38E-01	0.78	99.74	1.56	-1.12E-02
0.572	2.34E-01	0.784	98.89	1.561	1.79E-02
0.574	4.04E-01	0.788	98.94	1.562	3.68E-02
0.576	7.63E-01	0.792	99.01	1.563	3.09E-02
0.578	1.58E+00	0.796	98.11	1.564	4.30E-02
0.58	3.66E+00	0.8	97.27	1.565	8.58E-02
0.582	8.95E+00	0.804	97.56	1.566	9.05E-02
0.584	2.28E+01	0.808	98.59	1.567	1.02E-01
0.586	4.82E+01	0.812	99.47	1.568	2.54E-01
0.588	6.71E+01	0.816	99.85	1.569	3.12E-01
0.59	7.04E+01	0.82	99.88	1.57	3.74E-01
0.592	7.00E+01	0.824	100	1.571	5.61E-01
0.594	7.11E+01	0.828	99.84	1.572	6.92E-01
0.596	7.41E+01	0.832	99.47	1.573	9.77E-01
0.598	7.76E+01	0.836	99.14	1.574	1.47E+00
0.6	8.07E+01	0.84	98.59	1.575	1.99E+00
0.602	8.23E+01	0.844	97.99	1.576	2.87E+00
0.604	8.30E+01	0.848	96.85	1.577	4.01E+00
0.606	8.35E+01	0.852	95.47	1.578	5.91E+00
0.608	8.43E+01	0.856	94.08	1.579	8.52E+00
0.61	8.48E+01	0.86	92.99	1.58	1.20E+01
0.612	8.53E+01	0.864	92.32	1.581	1.76E+01
0.614	8.73E+01	0.868	92.17	1.582	2.46E+01
0.616	9.00E+01	0.872	93.01	1.583	3.43E+01
0.618	9.22E+01	0.876	94.14	1.584	4.50E+01
0.62	9.35E+01	0.88	95.18	1.585	5.59E+01
0.622	9.43E+01	0.884	95.11	1.586	6.89E+01
0.624	9.49E+01	0.888	94.43	1.587	7.78E+01
0.626	9.54E+01	0.892	92.81	1.588	8.44E+01
0.628	9.63E+01	0.896	91.02	1.589	8.93E+01
0.63	9.79E+01	0.9	89.44	1.59	9.10E+01
0.632	9.86E+01	0.904	88.88	1.591	9.23E+01
0.634	9.91E+01	0.908	89.21	1.592	9.30E+01

0.636	9.95E+01	0.912	90.36	1.593	9.44E+01
0.638	9.98E+01	0.916	91.22	1.594	9.49E+01
0.64	9.99E+01	0.92	91.46	1.595	9.57E+01
0.642	1.00E+02	0.924	90.35	1.596	9.73E+01
0.644	9.99E+01	0.928	87.95	1.597	9.79E+01
0.646	9.96E+01	0.932	84.87	1.598	9.86E+01
0.648	9.94E+01	0.936	82.03	1.599	9.89E+01
0.65	9.90E+01	0.94	79.5	1.6	1.00E+02
0.652	9.85E+01	0.944	76.57	1.601	1.00E+02
0.654	9.83E+01	0.948	74.83	1.602	9.97E+01
0.656	9.75E+01	0.952	73.65	1.603	9.94E+01
0.658	9.68E+01	0.956	72.88	1.604	9.93E+01
0.66	9.39E+01	0.96	71.94	1.605	9.97E+01
0.662	9.03E+01	0.964	70.35	1.606	9.86E+01
0.664	8.72E+01	0.968	68.07	1.607	9.89E+01
0.666	8.58E+01	0.972	64.66	1.608	9.85E+01
0.668	8.67E+01	0.976	58.28	1.609	9.87E+01
0.67	9.05E+01	0.98	47.82	1.61	9.93E+01
0.672	9.55E+01	0.984	36.17	1.611	9.88E+01
0.674	9.54E+01	0.988	26.13	1.612	9.80E+01
0.676	8.24E+01	0.992	18.44	1.613	9.56E+01
0.678	5.58E+01	0.996	12.57	1.614	9.41E+01
0.68	3.24E+01	1	7.841	1.615	9.14E+01
0.682	1.75E+01	1.004	4.366	1.616	8.86E+01
0.684	9.41E+00	1.008	2.168	1.617	8.55E+01
0.686	5.24E+00	1.012	1.005	1.618	8.26E+01
0.688	3.02E+00	1.016	0.4644	1.619	7.93E+01
0.69	1.83E+00	1.02	0.2165	1.62	7.60E+01
0.692	1.16E+00	1.024	0.1022	1.621	7.54E+01
0.694	7.53E-01	1.028	0.05075	1.622	7.40E+01
0.696	4.93E-01	1.032	0.02385	1.623	7.44E+01
0.698	3.34E-01	1.036	0.01453	1.624	7.48E+01
0.7	2.23E-01	1.04	0.005131	1.625	7.69E+01
0.702	1.55E-01	1.044	0.000853	1.626	7.87E+01
0.704	1.07E-01	1.048	-0.00134	1.627	8.02E+01
0.706	8.13E-02	1.052	-0.00279	1.628	7.95E+01
0.708	6.94E-02	1.056	-0.00328	1.629	7.57E+01

0.71	4.66E-02	1.06	-0.00467	1.63	6.74E+01
0.712	-1.23E-02	1.064	-0.00314	1.631	5.59E+01
0.714	-1.78E-03	1.068	-0.00288	1.632	4.20E+01
0.716	-8.65E-03	1.072	-0.00421	1.633	2.93E+01
0.718	8.84E-03	-	-	1.634	2.08E+01
0.72	-1.28E-02	-	-	1.635	1.37E+01
0.722	-2.40E-03	-	-	1.636	9.14E+00
0.724	6.13E-04	-	-	1.637	6.02E+00
0.726	-2.98E-03	-	-	1.638	4.28E+00
0.728	-2.89E-03	-	-	1.639	2.91E+00
0.73	-5.70E-04	-	-	1.64	2.02E+00
0.732	-1.17E-02	-	-	1.641	1.42E+00
0.734	-4.32E-03	-	-	1.642	1.02E+00
0.736	-8.49E-03	-	-	1.643	6.95E-01
0.738	-6.29E-03	-	-	1.644	4.96E-01
0.74	-9.01E-03	-	-	1.645	3.40E-01
0.742	-5.32E-03	-	-	1.646	2.34E-01
0.744	-6.18E-03	-	-	1.647	1.41E-01
0.746	-3.80E-03	-	-	1.648	7.98E-02
0.748	-1.09E-02	-	-	1.649	8.64E-02
0.75	-9.46E-03	-	-	1.65	5.40E-02
0.752	-2.65E-03	-	-	1.651	4.02E-02
0.754	-2.55E-03	-	-	1.652	6.80E-02
0.756	-4.70E-03	-	-	1.653	3.55E-02
0.758	1.20E-03	-	-	1.654	2.61E-02
0.76	-8.20E-03	-	-	1.655	2.62E-02
0.762	-2.02E-03	-	-	1.656	4.45E-02
0.764	-9.82E-03	-	-	1.657	-2.44E-02
0.766	-3.92E-03	-	-	1.658	-2.76E-03
0.768	-9.07E-03	-	-	1.659	-1.17E-02
0.77	-2.10E-04	-	-	1.66	-2.16E-02
0.772	-2.13E-04	-	-	1.661	1.84E-02
0.774	-9.64E-03	-	-	1.662	-3.62E-03
0.776	-2.49E-03	-	-	1.663	-1.16E-02
0.778	-9.89E-03	-	-	1.664	-9.81E-03
0.78	-4.03E-03	-	-	1.665	1.43E-03
0.782	-3.63E-03	-	-	1.666	-2.12E-02

0.784	-6.54E-03	-	-	1.667	-8.39E-03
0.786	-5.73E-03	-	-	1.668	1.54E-02
0.788	-9.35E-03	-	-	1.669	6.32E-03
0.79	-1.04E-02	-	-	1.67	3.88E-03
0.792	-6.14E-03	-	-	1.671	-2.05E-02
0.794	-1.16E-02	-	-	1.672	-9.59E-03
0.796	-1.52E-02	-	-	1.673	-2.17E-02
0.798	-3.57E-03	-	-	1.674	2.43E-03
0.8	-2.27E-03	-	-	1.675	4.51E-02
0.802	-7.55E-03	-	-	1.676	-1.45E-02
0.804	-7.29E-03	-	-	1.677	6.86E-03
0.806	-1.15E-02	-	-	1.678	4.28E-04
0.808	-7.96E-04	-	-	1.679	1.91E-02
0.81	4.68E-03	-	-	1.68	-3.03E-02
0.812	-1.71E-03	-	-	1.681	1.51E-02
0.814	-1.43E-02	-	-	1.682	-4.49E-03
0.816	-1.63E-02	-	-	1.683	-2.36E-02
0.818	-3.39E-03	-	-	1.684	2.75E-02
0.82	-3.40E-03	-	-	1.685	2.65E-03
0.822	7.45E-03	-	-	1.686	8.91E-03
0.824	-8.41E-03	-	-	1.687	-2.64E-02
0.826	-1.70E-02	-	-	1.688	-1.55E-02
0.828	-9.74E-03	-	-	1.689	-1.34E-02
0.83	-1.77E-03	-	-	1.69	1.60E-02
-	-	-	-	1.691	1.78E-02
-	-	-	-	1.692	-2.36E-02
-	-	-	-	1.693	9.42E-03
-	-	-	-	1.694	1.47E-03
-	-	-	-	1.695	5.46E-02
-	-	-	-	1.696	-3.36E-02
-	-	-	-	1.697	5.38E-02
-	-	-	-	1.698	-2.11E-02
-	-	-	-	1.699	-1.63E-02
-	-	-	-	1.7	-3.32E-02
-	-	-	-	1.701	3.33E-03
-	-	-	-	1.702	3.37E-02
-	-	-	-	1.703	-1.14E-02

-	-	-	-	1.704	-3.39E-03
-	-	-	-	1.705	-4.02E-03
-	-	-	-	1.706	-3.38E-03
-	-	-	-	1.707	1.66E-03
-	-	-	-	1.708	-1.45E-02
-	-	-	-	1.709	-3.20E-03
-	-	-	-	1.71	1.21E-02
-	-	-	-	1.711	-1.70E-02
-	-	-	-	1.712	-4.39E-03
-	-	-	-	1.713	2.47E-03
-	-	-	-	1.714	2.71E-02
-	-	-	-	1.715	-2.15E-02
-	-	-	-	1.716	-7.65E-04
-	-	-	-	1.717	2.69E-02
-	-	-	-	1.718	-2.53E-02
-	-	-	-	1.719	4.46E-04
-	-	-	-	1.72	3.16E-02
-	-	-	-	1.721	4.28E-02
-	-	-	-	1.722	2.65E-03
-	-	-	-	1.723	-7.66E-03
-	-	-	-	1.724	-1.32E-02
-	-	-	-	1.725	-6.39E-03
-	-	-	-	1.726	-1.15E-02
-	-	-	-	1.727	1.57E-02
-	-	-	-	1.728	-1.23E-02
-	-	-	-	1.729	3.96E-02
-	-	-	-	1.73	4.39E-02

Channel 3B		Channel 4		Channel 5	
Wavelength (microns)	Relative Response (percent)	Wavelength (microns)	Relative Response (percent)	Wavelength (microns)	Relative Response (percent)
2.98	-5.33E-03	8.8	-1.02E-02	10	-0.01718
2.987	6.70E-04	8.82	-2.08E-02	10.02	0.01368
2.994	-2.19E-03	8.84	-1.94E-02	10.04	0.01239

3.001	-5.91E-03	8.86	8.72E-02	10.06	0.02233
3.008	-7.43E-03	8.88	1.54E-02	10.08	0.008345
3.015	-5.05E-03	8.9	5.83E-02	10.1	-0.00312
3.022	1.26E-02	8.92	-2.45E-02	10.12	-0.0178
3.029	-6.29E-03	8.94	-3.48E-02	10.14	-0.00268
3.036	-5.18E-03	8.96	1.00E-02	10.16	0.006425
3.043	7.31E-04	8.98	4.97E-03	10.18	0.005376
3.05	4.23E-03	9	-5.42E-03	10.2	-0.00791
3.057	6.79E-03	9.02	1.39E-03	10.22	-0.00298
3.064	2.79E-03	9.04	5.58E-03	10.24	-0.00534
3.071	1.77E-03	9.06	7.56E-02	10.26	0.006877
3.078	-3.74E-03	9.08	-2.23E-02	10.28	-0.0124
3.085	-5.08E-03	9.1	-1.50E-02	10.3	0.005085
3.092	1.12E-02	9.12	3.81E-02	10.32	-0.00802
3.099	3.22E-03	9.14	5.58E-02	10.34	-0.0091
3.106	5.56E-03	9.16	7.42E-02	10.36	-0.01615
3.113	2.18E-03	9.18	-4.41E-02	10.38	-0.02473
3.12	-3.02E-03	9.2	6.89E-02	10.4	-0.00515
3.127	-1.34E-02	9.22	6.01E-03	10.42	0.001558
3.134	4.65E-03	9.24	1.92E-02	10.44	0.001468
3.141	9.56E-03	9.26	-2.99E-02	10.46	0.003179
3.148	-7.04E-03	9.28	-1.99E-02	10.48	-0.01883
3.155	-2.26E-03	9.3	-1.91E-02	10.5	0.01178
3.162	-1.48E-03	9.32	8.45E-02	10.52	-0.01461
3.169	-9.48E-03	9.34	-2.89E-02	10.54	-0.02997
3.176	1.25E-02	9.36	1.52E-02	10.56	-0.01002
3.183	-1.01E-02	9.38	-3.27E-02	10.58	-0.00657
3.19	1.42E-03	9.4	1.18E-02	10.6	0.04466
3.197	1.28E-02	9.42	-1.70E-02	10.62	-0.00887
3.204	-5.09E-03	9.44	8.85E-02	10.64	-0.02185
3.211	1.63E-03	9.46	5.42E-03	10.66	-0.0152
3.218	-1.25E-02	9.48	4.21E-02	10.68	-0.01477
3.225	-8.72E-03	9.5	-1.03E-02	10.7	-0.00075
3.232	-8.99E-04	9.52	5.79E-02	10.72	-0.01821
3.239	2.38E-03	9.54	3.27E-02	10.74	-0.02578
3.246	3.48E-03	9.56	5.63E-02	10.76	-0.01788
3.253	-8.27E-03	9.58	9.98E-02	10.78	-0.01438

3.26	1.63E-03	9.6	8.70E-03	10.8	-0.01731
3.267	-9.12E-04	9.62	-8.07E-03	10.82	-0.02694
3.274	1.30E-03	9.64	-1.74E-02	10.84	-0.01319
3.281	1.97E-04	9.66	8.32E-02	10.86	-0.02089
3.288	9.65E-03	9.68	6.41E-02	10.88	-0.02905
3.295	-1.65E-02	9.7	-4.69E-02	10.9	-0.01403
3.302	-9.21E-03	9.72	3.17E-02	10.92	-0.03692
3.309	5.35E-03	9.74	3.37E-02	10.94	-0.03885
3.316	6.96E-04	9.76	4.44E-03	10.96	-0.02523
3.323	-6.46E-03	9.78	6.34E-02	10.98	-0.04224
3.33	-4.28E-03	9.8	5.60E-02	11	-0.02871
3.337	-3.65E-03	9.82	1.18E-02	11.02	0.002417
3.344	-3.34E-03	9.84	1.77E-02	11.04	-0.03712
3.351	6.19E-03	9.86	3.17E-02	11.06	-0.03634
3.358	9.95E-03	9.88	-3.60E-02	11.08	-0.03161
3.365	4.28E-03	9.9	4.91E-02	11.1	-0.03004
3.372	-1.10E-03	9.92	4.36E-02	11.12	-0.0221
3.379	2.97E-03	9.94	3.05E-02	11.14	-0.03151
3.386	1.34E-03	9.96	-5.04E-02	11.16	0.09032
3.393	2.06E-02	9.98	8.07E-02	11.18	-0.03302
3.4	5.57E-03	10	-2.51E-02	11.2	-0.00714
3.407	-1.19E-02	10.02	-2.91E-02	11.22	-0.04278
3.414	1.17E-02	10.04	1.16E-01	11.24	-0.03783
3.421	9.20E-03	10.06	1.62E-01	11.26	0.007625
3.428	1.82E-02	10.08	2.94E-01	11.28	0.01115
3.435	2.84E-02	10.1	4.37E-01	11.3	0.06993
3.442	4.85E-02	10.12	7.59E-01	11.32	0.1968
3.449	6.73E-02	10.14	1.31E+00	11.34	0.5368
3.456	1.18E-01	10.16	2.20E+00	11.36	1.365
3.463	1.79E-01	10.18	3.68E+00	11.38	3.396
3.47	2.90E-01	10.2	5.92E+00	11.4	8.206
3.477	4.25E-01	10.22	9.32E+00	11.42	18.79
3.484	7.14E-01	10.24	1.43E+01	11.44	36.95
3.491	1.15E+00	10.26	1.96E+01	11.46	57.99
3.498	1.86E+00	10.28	2.81E+01	11.48	73.26
3.505	3.12E+00	10.3	3.68E+01	11.5	78
3.512	5.37E+00	10.32	4.62E+01	11.52	76.63

3.519	9.45E+00	10.34	5.58E+01	11.54	75.95
3.526	1.64E+01	10.36	6.52E+01	11.56	77.55
3.533	2.72E+01	10.38	7.26E+01	11.58	80.71
3.54	4.18E+01	10.4	8.07E+01	11.6	85.08
3.547	5.81E+01	10.42	8.58E+01	11.62	88.18
3.554	7.20E+01	10.44	8.87E+01	11.64	91.65
3.561	8.02E+01	10.46	9.18E+01	11.66	94.59
3.568	8.34E+01	10.48	9.25E+01	11.68	96.8
3.575	8.40E+01	10.5	9.29E+01	11.7	97.46
3.582	8.43E+01	10.52	9.34E+01	11.72	98.8
3.589	8.52E+01	10.54	9.38E+01	11.74	99.57
3.596	8.60E+01	10.56	9.48E+01	11.76	100
3.603	8.77E+01	10.58	9.53E+01	11.78	99.62
3.61	8.93E+01	10.6	9.60E+01	11.8	99.06
3.617	9.06E+01	10.62	9.62E+01	11.82	99.37
3.624	9.19E+01	10.64	9.72E+01	11.84	99.33
3.631	9.29E+01	10.66	9.69E+01	11.86	99.74
3.638	9.39E+01	10.68	9.72E+01	11.88	99.66
3.645	9.46E+01	10.7	9.76E+01	11.9	99.23
3.652	9.53E+01	10.72	9.73E+01	11.92	98.73
3.659	9.59E+01	10.74	9.67E+01	11.94	98
3.666	9.60E+01	10.76	9.69E+01	11.96	96.31
3.673	9.65E+01	10.78	9.64E+01	11.98	95.28
3.68	9.68E+01	10.8	9.60E+01	12	92.88
3.687	9.70E+01	10.82	9.57E+01	12.02	91.97
3.694	9.73E+01	10.84	9.48E+01	12.04	89.99
3.701	9.78E+01	10.86	9.59E+01	12.06	88.81
3.708	9.81E+01	10.88	9.54E+01	12.08	87.92
3.715	9.89E+01	10.9	9.62E+01	12.1	86.61
3.722	9.96E+01	10.92	9.54E+01	12.12	86.62
3.729	9.98E+01	10.94	9.77E+01	12.14	86.2
3.736	1.00E+02	10.96	9.64E+01	12.16	85.11
3.743	9.98E+01	10.98	9.95E+01	12.18	84.93
3.75	9.89E+01	11	9.84E+01	12.2	84.49
3.757	9.78E+01	11.02	9.95E+01	12.22	83.16
3.764	9.69E+01	11.04	9.89E+01	12.24	83.14
3.771	9.58E+01	11.06	9.99E+01	12.26	82.94

3.778	9.53E+01	11.08	1.00E+02	12.28	83
3.785	9.46E+01	11.1	9.85E+01	12.3	82.29
3.792	9.42E+01	11.12	9.84E+01	12.32	83.04
3.799	9.47E+01	11.14	9.75E+01	12.34	82.64
3.806	9.53E+01	11.16	9.65E+01	12.36	79.33
3.813	9.38E+01	11.18	9.41E+01	12.38	72.05
3.82	9.37E+01	11.2	9.19E+01	12.4	61.43
3.827	9.03E+01	11.22	8.83E+01	12.42	45.85
3.834	8.55E+01	11.24	8.36E+01	12.44	31.29
3.841	7.86E+01	11.26	7.72E+01	12.46	18.96
3.848	7.03E+01	11.28	6.96E+01	12.48	10.67
3.855	6.13E+01	11.3	6.12E+01	12.5	5.644
3.862	5.35E+01	11.32	5.17E+01	12.52	3.004
3.869	4.63E+01	11.34	4.24E+01	12.54	1.614
3.876	4.02E+01	11.36	3.18E+01	12.56	0.872
3.883	3.51E+01	11.38	2.52E+01	12.58	0.4295
3.89	3.10E+01	11.4	1.80E+01	12.6	0.2285
3.897	2.79E+01	11.42	1.24E+01	12.62	0.1242
3.904	2.53E+01	11.44	8.14E+00	12.64	0.01651
3.911	2.33E+01	11.46	5.19E+00	12.66	0.06634
3.918	2.17E+01	11.48	3.20E+00	12.68	-0.00409
3.925	2.03E+01	11.5	1.95E+00	12.7	-0.05798
3.932	1.91E+01	11.52	1.24E+00	12.72	-0.0379
3.939	1.78E+01	11.54	8.38E-01	12.74	-0.03205
3.946	1.66E+01	11.56	6.35E-01	12.76	-0.02114
3.953	1.53E+01	11.58	3.23E-01	12.78	-0.01404
3.96	1.39E+01	11.6	1.57E-01	12.8	-0.05854
3.967	1.23E+01	11.62	2.22E-01	12.82	-0.01372
3.974	1.07E+01	11.64	2.01E-02	12.84	0.00535
3.981	9.18E+00	11.66	2.10E-02	12.86	-0.05936
3.988	7.73E+00	11.68	-1.89E-02	12.88	-0.0092
3.995	6.40E+00	11.7	4.87E-02	12.9	0.03554
4.002	5.24E+00	11.72	7.92E-02	12.92	-0.02829
4.009	4.30E+00	11.74	-2.04E-01	12.94	-0.1382
4.016	3.35E+00	11.76	7.59E-02	12.96	-0.06196
4.023	2.59E+00	11.78	-7.32E-02	12.98	-0.07797
4.03	2.01E+00	11.8	-1.69E-02	13	-0.02167

4.037	1.53E+00	11.82	-2.52E-02	13.02	-0.0807
4.044	1.13E+00	11.84	-8.53E-02	13.04	-0.03203
4.051	8.36E-01	11.86	-5.07E-02	13.06	-0.05031
4.058	6.09E-01	11.88	-1.53E-01	13.08	0.02559
4.065	4.26E-01	11.9	-1.89E-01	13.1	-0.1129
4.072	3.18E-01	11.92	7.63E-02	13.12	-0.06401
4.079	2.29E-01	11.94	1.19E-01	13.14	0.01219
4.086	1.37E-01	11.96	-1.62E-01	13.16	-0.05337
4.093	1.11E-01	11.98	-9.78E-03	13.18	-0.06573
4.1	8.49E-02	12	8.58E-02	13.2	-0.06036
4.107	4.35E-02	12.02	-5.72E-02	13.22	-0.08728
4.114	4.36E-02	12.04	-7.14E-02	13.24	-0.00695
4.121	2.51E-02	12.06	-5.28E-02	13.26	-0.1051
4.128	1.59E-02	12.08	-3.93E-02	13.28	-0.0418
4.135	1.73E-02	12.1	9.50E-02	13.3	0.04034
4.142	-3.35E-03	12.12	-1.63E-02	13.32	-0.04083
4.149	4.29E-03	12.14	-1.55E-01	13.34	-0.03609
4.156	1.28E-02	12.16	-1.52E-01	13.36	0.05117
4.163	5.18E-03	12.18	-9.22E-02	13.38	-0.09669
4.17	-1.21E-02	12.2	-3.10E-02	13.4	-0.04841
4.177	-1.47E-02	12.22	-1.65E-01	13.42	0.06506
4.184	1.84E-03	12.24	-7.64E-03	13.44	-0.02134
4.191	1.67E-02	12.26	5.27E-02	13.46	-0.05594
4.198	-1.43E-02	12.28	7.81E-03	13.48	-0.05692
4.205	2.69E-02	12.3	-2.03E-01	13.5	-0.02644
4.212	-3.97E-02	12.32	1.48E-01	13.52	-0.02655
4.219	1.94E-01	12.34	-2.48E-01	13.54	0.002502
4.226	1.01E-01	12.36	-2.19E-02	13.56	0.01433
4.233	4.07E-01	12.38	7.63E-02	13.58	0.1242
4.24	-5.30E-03	12.4	-1.93E-01	13.6	-0.07373
4.247	3.88E-01	12.42	8.17E-02	13.62	0.009827
4.254	1.59E-01	12.44	-2.46E-01	13.64	0.04414
4.261	-1.64E-01	12.46	3.50E-03	13.66	0.173
4.268	4.84E-01	12.48	-7.85E-02	13.68	-0.00284
4.275	2.28E-01	12.5	-1.37E-01	13.7	-0.03651
4.282	5.08E-01	12.52	-1.83E-01	13.72	-0.04327
4.289	2.41E-01	12.54	-1.98E-01	13.74	-0.06956

4.296	4.42E-01	12.56	3.65E-01	13.76	0.0289
4.303	-2.23E-02	12.58	-1.97E-01	13.78	-0.01799
4.31	9.88E-02	12.6	-7.56E-02	13.8	-0.09179
4.317	-7.26E-03	12.62	-4.45E-03	13.82	-0.01087
4.324	-6.38E-02	12.64	4.34E-02	13.84	0.3827
4.331	6.46E-02	12.66	-5.97E-02	13.86	0.1003
4.338	-3.73E-02	12.68	9.92E-02	13.88	0.08051
4.345	-5.50E-02	12.7	-3.98E-02	13.9	-0.00593
4.352	-9.98E-03	12.72	1.37E-01	13.92	0.08185
4.359	3.11E-02	12.74	-3.37E-01	13.94	-0.06929
4.366	-9.36E-03	12.76	-2.16E-01	13.96	-0.08804
4.373	-6.79E-03	12.78	7.61E-02	13.98	-0.08699
4.38	4.50E-03	12.8	3.69E-02	14	-0.0497
4.387	-1.79E-02	-	-	-	-
4.394	-8.33E-03	-	-	-	-
4.401	2.63E-02	-	-	-	-
4.408	5.88E-03	-	-	-	-
4.415	-1.32E-02	-	-	-	-
4.422	1.09E-02	-	-	-	-
4.429	1.08E-02	-	-	-	-
4.436	-3.89E-03	-	-	-	-
4.443	-2.78E-02	-	-	-	-
4.45	4.33E-03	-	-	-	-
4.457	-1.53E-02	-	-	-	-
4.464	1.13E-02	-	-	-	-
4.471	-8.95E-03	-	-	-	-
4.478	-1.10E-02	-	-	-	-
4.485	-9.98E-03	-	-	-	-
4.492	5.32E-03	-	-	-	-
4.499	6.71E-03	-	-	-	-

Table D.1-14 contains the radiance of space and coefficients for nonlinear radiance correction quadratic for NOAA-15.

Table D.1-14. NOAA-15 Radiance of Space and Coefficients for Nonlinear Radiance Correction Quadratic.				
	N_s	b₀	b₁	b₂

Channel 4	-4.50	4.76	-0.0932	0.0004524
Channel 5	-3.61	3.83	-0.0659	0.0002811

Table D.1-15 gives the PRT temperature conversion coefficients for NOAA-15 AMSU.

Table D.1-15. NOAA-15 AMSU PRT Temperature Conversion Coefficients.				
	Coefficient 0	Coefficient 1	Coefficient 2	Coefficient 3
A1-1 Warm Load 1 Temperature	0.254102E+03	0.168832E-02	0.624164E-08	0.333281E-13
A1-1 Warm Load 2 Temperature	0.254288E+03	0.168747E-02	0.632825E-08	0.320118E-13
A1-1 Warm Load 3 Temperature	0.254081E+03	0.168386E-02	0.640983E-08	0.301406E-13
A1-1 Warm Load 4 Temperature	0.253989E+03	0.168390E-02	0.644731E-08	0.294864E-13
A1-1 Warm Load Center Temperature	0.254100E+03	0.168130E-02	0.655349E-08	0.274291E-13
A1-2 Warm Load 1 Temperature	0.254276E+03	0.168507E-02	0.637018E-08	0.306854E-13
A1-2 Warm Load 2 Temperature	0.253976E+03	0.168490E-02	0.641530E-08	0.299593E-13
A1-2 Warm Load 3 Temperature	0.254038E+03	0.168658E-02	0.614662E-08	0.354148E-13
A1-2 Warm Load 4 Temperature	0.254105E+03	0.168449E-02	0.626281E-08	0.331058E-13
A1-2 Warm Load Center Temperature	0.254142E+03	0.168526E-02	0.631001E-08	0.314208E-13
A2 Warm Load Center Temp. Conv.	0.253999E+03	0.163887E-02	0.600702E-08	0.281246E-13
A2 Warm Load 1 Temp. Conv.	0.254040E+03	0.163678E-02	0.602736E-08	0.282433E-
A2 Warm Load 2 Temp. Conv.	0.253935E+03	0.164220E-02	0.598113E-08	0.291885E-13

A2 Warm Load 3 Temp. Conv.	0.254019E+03	0.163882E-02	0.601815E-08	0.285995E-13
A2 Warm Load 4 Temp. Conv.	0.253992E+03	0.163881E-02	0.604819E-08	0.274072E-13
A2 Warm Load 5 Temp. Conv.	0.253974E+03	0.163862E-02	0.600312E-08	0.279964E-13
A2 Warm Load 6 Temp. Conv.	0.253994E+03	0.163795E-02	0.606631E-08	0.266802E-13
AMSU-B Calibration Target Temperature 1	0.262050E+03	0.765000E-03	0.122400E-08	0.256000E-14
AMSU-B Calibration Target Temperature 2	0.262110E+03	0.765500E-03	0.121900E-08	0.263000E-14
AMSU-B Calibration Target Temperature 3	0.262090E+03	0.765400E-03	0.122500E-08	0.255000E-14
AMSU-B Calibration Target Temperature 4	0.261930E+03	0.766800E-03	0.117200E-08	0.291000E-14
AMSU-B Calibration Target Temperature 5	0.261950E+03	0.764800E-03	0.122500E-08	0.255000E-14
AMSU-B Calibration Target Temperature 6	0.261980E+03	0.765600E-03	0.122600E-08	0.254000E-14
AMSU-B Calibration Target Temperature 7	0.262000E+03	0.765200E-03	0.122100E-08	0.257000E-14

Table D.1-16 contains the secondary telescope count to temperature coefficients for the NOAA-15 HIRS/302 instrument.

Table D.1-16. NOAA-15 HIRS/302 Secondary Telescope Temperature Coefficients (K).				
a₀	a₁	a₂	a₃	a₄
260.29119	1.693469E-02	-2.413170E-06	4.019185E-10	1.175655E-14

D.2 NOAA-16 (L)

Launch date: September 21, 2000

Operational dates: March 20, 2001 - present

Afternoon orbit: 1400 LST ascending node, 0200 LST descending node

AVHRR instrument: 6 channels (AVHRR/3)

Spacecraft ID: 2

Abnormalities:

Up to date information regarding abnormalities on the POES spacecraft and instruments can be found at: <http://www.oso.noaa.gov/poesstatus/>. This website allows a user to search and sort on any POES spacecraft, subsystem or instrument status. Once a user narrows down their window of interest, further details can be obtained by going to the NOAA/NESDIS/Office of Satellite Operations' (OSO) archive of weekly status reports at: <http://noaasis.noaa.gov/NOAASIS/ml/podocs.html>

Table D.2-1 contains the measured channel characteristics for NOAA-16 AMSU-A (channels 1-15) and AMSU-B (channels 16-20). Detailed information on the terminology used in this table can be found in Section 3.3.2.1.

Table D.2-1. Measured Channel Characteristics for NOAA-16 AMSU-A and AMSU-B.							
Ch #	Instrument/ Serial #	Central Frequency (Ghz)	Central Wavenumber (cm⁻¹)	I/F Frequencies (GHz)			
				Sideband 1		Sideband 2	
				Begin (f₁)	End (f₂)	Begin (f₃)	End (f₄)
1*	A2/FM1	23.800110	0.793886	0.00858	0.13403	N/A	N/A
2*	A2/FM1	31.400580	1.047411	0.00887	0.08957	N/A	N/A
3*	A1-2/PFM	50.299700	1.677817	0.00898	0.08956	N/A	N/A
4*	A1-2/PFM	52.800740	1.761243	0.00891	0.19916	N/A	N/A
5	A1-2/PFM	53.595470	1.787752	0.03094	0.19920	N/A	N/A
6*	A1-1/PFM	54.399780	1.814581	0.00892	0.19922	N/A	N/A
7*	A1-1/PFM	54.940770	1.832626	0.00888	0.19919	N/A	N/A
8*	A1-2/PFM	55.499540	1.851265	0.00894	0.16402	N/A	N/A
9*	A1-1/PFM	57.290324	1.910999	0.00887	0.16417	N/A	N/A
10	A1-1/PFM	57.290324	1.910999	0.17876	0.25545	N/A	N/A
11	A1-1/PFM	57.290324	1.910999	0.257140	0.291780	0.353095	0.387585
12	A1-1/PFM	57.290324	1.910999	0.292715	0.308025	0.336865	0.351875
13	A1-1/PFM	57.290324	1.910999	0.308195	0.316165	0.328350	0.336250
14	A1-1/PFM	57.290324	1.910999	0.316325	0.319255	0.325340	0.328240
15	A1-1/PFM	88.999800	2.968713	0.49943	1.49645	N/A	N/A
16	B/FM2	89.005600	2.968907	0.399	1.405	N/A	N/A
17	B/FM2	150.008000	5.003728	0.397	1.397	N/A	N/A
18	B/FM2	183.299000	6.114196	0.751	1.245	N/A	N/A
19	B/FM2	183.299000	6.114196	2.507	3.485	N/A	N/A
20	B/FM2	183.299000	6.114196	6.011	7.989	N/A	N/A

* The lower frequency cutoff in these single passband channels is due to the stop band.

Table D.2-2 contains the Internal Warm Temperature (IWT) PRT count to temperature coefficients for the NOAA-16 HIRS/301 instrument.

Table D.2-2. NOAA-16 IWT PRT Count to Temperature Coefficients for HIRS/301.					
PRT	a₀	a₁	a₂	a₃	a₄
1	301.45076	6.530210E-03	8.326151E-08	4.724724E-11	1.565263E-15
2	301.39565	6.527550E-03	8.417738E-08	4.727738E-11	1.460746E-15
3	301.40733	6.528222E-03	8.314237E-08	4.721744E-11	1.543985E-15
4	301.40280	6.525508E-03	8.269671E-08	4.707211E-11	1.549894E-15

The slope and intercept for the NOAA-16 HIRS/301 visible channel (Channel 20) are given in Table D.2-3.

Table D.2-3. NOAA-16 HIRS/301 Channel 20 Slope and Intercept (Albedo %).		
Source	Slope	Intercept
Pre-launch calibration	0.021354	51.4852
Post-launch calibration (May 2002)	0.02611	62.3307

Notes:

- To retrieve the albedo, use the following equation:

$$\text{albedo} = (\text{intercept} + \text{slope} \times C) / \cos(z)$$
 where C=earth view count and z=solar zenith angle. Both C and z vary from pixel to pixel.
- Post launch calibration is traceable to the Libyan desert calibration site, for which the HIRS channel 20 albedo is ~36.1%. Further update to these coefficients may be needed as the instrument degrades over time.

Table D.2-4 contains the NOAA-16 HIRS/301 central wave numbers and band correction coefficients for the thermal channels.

Table D.2-4. NOAA-16 HIRS/301 Central Wave Numbers and Band Correction Coefficients.			
Channel	ν_c	b	c
1	669.63	-0.20343166E-01	0.10000410E+01
2	679.62	-0.37903808E-01	0.10000601E+01
3	691.34	0.46412162E-01	0.99985170E+00
4	701.21	-0.10939109E+00	0.10001678E+01
5	715.97	-0.93730390E-01	0.10001240E+01
6	731.48	0.46898678E-01	0.99985778E+00
7	748.81	-0.16370463E+00	0.10002537E+01
8	894.57	-0.45792717E+00	0.10003786E+01
9	1031.61	-0.31440780E-01	0.99980080E+00
10	803.03	-0.71182311E-01	0.10000648E+01
11	1362.17	-0.65910578E-01	0.99942523E+00
12	1524.87	0.18643104E-01	0.99923688E+00
13	2184.24	-0.53380642E-01	0.99932522E+00
14	2205.76	0.39597461E-03	0.99979341E+00
15	2234.22	0.43904714E-01	0.10001879E+01
16	2243.77	0.42705547E-01	0.10001974E+01
17	2415.06	-0.26972126E-01	0.99926430E+00
18	2515.56	-0.14948003E-01	0.99946713E+00
19	2663.39	0.22977877E+00	0.99900633E+00

Table D.2-5 contains the secondary telescope count to temperature coefficients for the NOAA-16 HIRS/301 instrument.

Table D.2-5. NOAA-16 HIRS/301 Secondary Telescope Temperature Coefficients.				
a₀	a₁	a₂	a₃	a₄

260.42546	1.659977E-02	-2.118035E-06	3.040075E-10	2.251628E-14
-----------	--------------	---------------	--------------	--------------

Table D.2-6 contains the actual filter functions for NOAA-16 HIRS/301.

Table D.2-6. Normalized Response Functions for the NOAA-16 HIRS/301 Thermal Channels.				
Channel 1				
Wave Number	HIRS Filter Transmittance	Optical Element Transmittance	Product of the HIRS Filter and Optical Element Transmittances	Normalized Value of Col. 4
6.75350E+02	0.00000E+00	1.42260E-01	0.00000E+00	0.00000E+00
6.75280E+02	1.58600E-02	1.42170E-01	2.25470E-03	3.82080E-02
6.75240E+02	2.50420E-02	1.42100E-01	3.55850E-03	6.03010E-02
6.75120E+02	3.17200E-02	1.41940E-01	4.50220E-03	7.62940E-02
6.74920E+02	3.25540E-02	1.41660E-01	4.61170E-03	7.81490E-02
6.74560E+02	3.00500E-02	1.41170E-01	4.24230E-03	7.18900E-02
6.74450E+02	2.08680E-02	1.41010E-01	2.94260E-03	4.98640E-02
6.74360E+02	1.75290E-02	1.40880E-01	2.46950E-03	4.18490E-02
6.74260E+02	2.25380E-02	1.40720E-01	3.17150E-03	5.37440E-02
6.74190E+02	3.67280E-02	1.40610E-01	5.16440E-03	8.75160E-02
6.74090E+02	5.00840E-02	1.40470E-01	7.03520E-03	1.19220E-01
6.74000E+02	4.34060E-02	1.40330E-01	6.09100E-03	1.03220E-01
6.73870E+02	3.17200E-02	1.40130E-01	4.44480E-03	7.53220E-02
6.73780E+02	3.50580E-02	1.39990E-01	4.90770E-03	8.31650E-02
6.73660E+02	4.92490E-02	1.39810E-01	6.88540E-03	1.16680E-01
6.73520E+02	6.26040E-02	1.39600E-01	8.73930E-03	1.48090E-01
6.73330E+02	6.67780E-02	1.39310E-01	9.30290E-03	1.57650E-01
6.73190E+02	7.76290E-02	1.39100E-01	1.07980E-02	1.82980E-01
6.73100E+02	9.09850E-02	1.38950E-01	1.26430E-02	2.14240E-01
6.72920E+02	9.01500E-02	1.38690E-01	1.25030E-02	2.11870E-01
6.72820E+02	8.26380E-02	1.38550E-01	1.14490E-02	1.94010E-01
6.72700E+02	7.17860E-02	1.38300E-01	9.92770E-03	1.68230E-01
6.72590E+02	6.34390E-02	1.38070E-01	8.75880E-03	1.48430E-01
6.72500E+02	7.59600E-02	1.37860E-01	1.04720E-02	1.77460E-01
6.72340E+02	9.68280E-02	1.37530E-01	1.33170E-02	2.25670E-01
6.72190E+02	1.16030E-01	1.37200E-01	1.59190E-02	2.69770E-01
6.72130E+02	1.30220E-01	1.37080E-01	1.78500E-02	3.02480E-01
6.72010E+02	1.41070E-01	1.36820E-01	1.93010E-02	3.27070E-01
6.71860E+02	1.48580E-01	1.36490E-01	2.02800E-02	3.43650E-01
6.71750E+02	1.59430E-01	1.36230E-01	2.17200E-02	3.68070E-01
6.71680E+02	1.73620E-01	1.36080E-01	2.36270E-02	4.00380E-01
6.71600E+02	1.95330E-01	1.35930E-01	2.65510E-02	4.49920E-01

6.71510E+02	2.11180E-01	1.35720E-01	2.86610E-02	4.85690E-01
6.71430E+02	2.22040E-01	1.35530E-01	3.00920E-02	5.09930E-01
6.71300E+02	2.29550E-01	1.35230E-01	3.10410E-02	5.26020E-01
6.71230E+02	2.40400E-01	1.35060E-01	3.24690E-02	5.50220E-01
6.71150E+02	2.59600E-01	1.34870E-01	3.50130E-02	5.93330E-01
6.71100E+02	2.72120E-01	1.34770E-01	3.66730E-02	6.21460E-01
6.70970E+02	2.77960E-01	1.34470E-01	3.73770E-02	6.33390E-01
6.70850E+02	2.87140E-01	1.34200E-01	3.85340E-02	6.53000E-01
6.70780E+02	2.98000E-01	1.34080E-01	3.99550E-02	6.77080E-01
6.70730E+02	3.10520E-01	1.33980E-01	4.16050E-02	7.05030E-01
6.70660E+02	3.30550E-01	1.33870E-01	4.42510E-02	7.49870E-01
6.70530E+02	3.53920E-01	1.33660E-01	4.73040E-02	8.01610E-01
6.70370E+02	3.75630E-01	1.33410E-01	5.01110E-02	8.49180E-01
6.70230E+02	4.04010E-01	1.33180E-01	5.38040E-02	9.11760E-01
6.70100E+02	4.25710E-01	1.32960E-01	5.66040E-02	9.59210E-01
6.69920E+02	4.36560E-01	1.32660E-01	5.79130E-02	9.81390E-01
6.69750E+02	4.45740E-01	1.32390E-01	5.90110E-02	1.00000E+00
6.69590E+02	4.42400E-01	1.32120E-01	5.84500E-02	9.90490E-01
6.69370E+02	4.38230E-01	1.31770E-01	5.77470E-02	9.78580E-01
6.69210E+02	4.27380E-01	1.31510E-01	5.62030E-02	9.52400E-01
6.69060E+02	4.19870E-01	1.31250E-01	5.51090E-02	9.33880E-01
6.68940E+02	3.96490E-01	1.31060E-01	5.19650E-02	8.80590E-01
6.68840E+02	3.68950E-01	1.30910E-01	4.82970E-02	8.18440E-01
6.68780E+02	3.52250E-01	1.30810E-01	4.60780E-02	7.80830E-01
6.68670E+02	3.43070E-01	1.30620E-01	4.48110E-02	7.59360E-01
6.68600E+02	3.50580E-01	1.30510E-01	4.57530E-02	7.75330E-01
6.68480E+02	3.43910E-01	1.30320E-01	4.48180E-02	7.59480E-01
6.68410E+02	3.23870E-01	1.30210E-01	4.21710E-02	7.14620E-01
6.68360E+02	2.98000E-01	1.30130E-01	3.87790E-02	6.57150E-01
6.68300E+02	2.61270E-01	1.30040E-01	3.39750E-02	5.75740E-01
6.68250E+02	2.47080E-01	1.29960E-01	3.21110E-02	5.44150E-01
6.68210E+02	2.32890E-01	1.29890E-01	3.02500E-02	5.12610E-01
6.68120E+02	2.27880E-01	1.29760E-01	2.95700E-02	5.01090E-01
6.68030E+02	2.38730E-01	1.29610E-01	3.09430E-02	5.24350E-01
6.67960E+02	2.49580E-01	1.29500E-01	3.23220E-02	5.47720E-01
6.67860E+02	2.37900E-01	1.29350E-01	3.07730E-02	5.21470E-01
6.67830E+02	2.16190E-01	1.29300E-01	2.79540E-02	4.73700E-01
6.67750E+02	1.93660E-01	1.29170E-01	2.50140E-02	4.23890E-01
6.67680E+02	1.76960E-01	1.29060E-01	2.28380E-02	3.87020E-01
6.67540E+02	1.65270E-01	1.28850E-01	2.12960E-02	3.60890E-01
6.67430E+02	1.52750E-01	1.28670E-01	1.96550E-02	3.33070E-01
6.67260E+02	1.34390E-01	1.28410E-01	1.72580E-02	2.92440E-01
6.67100E+02	1.14360E-01	1.28160E-01	1.46560E-02	2.48350E-01

6.66990E+02	1.03510E-01	1.27990E-01	1.32480E-02	2.24500E-01
6.66890E+02	1.06840E-01	1.27830E-01	1.36580E-02	2.31440E-01
6.66790E+02	1.03510E-01	1.27680E-01	1.32160E-02	2.23950E-01
6.66660E+02	9.34890E-02	1.27480E-01	1.19180E-02	2.01960E-01
6.66530E+02	8.43070E-02	1.27280E-01	1.07300E-02	1.81830E-01
6.66440E+02	7.51250E-02	1.27130E-01	9.55070E-03	1.61850E-01
6.66340E+02	5.92650E-02	1.26970E-01	7.52510E-03	1.27520E-01
6.66260E+02	4.75790E-02	1.26810E-01	6.03370E-03	1.02250E-01
6.66140E+02	4.50750E-02	1.26590E-01	5.70600E-03	9.66930E-02
6.66060E+02	4.92490E-02	1.26430E-01	6.22660E-03	1.05510E-01
6.65980E+02	5.50920E-02	1.26270E-01	6.95670E-03	1.17890E-01
6.65840E+02	5.17530E-02	1.26010E-01	6.52110E-03	1.10510E-01
6.65720E+02	4.50750E-02	1.25780E-01	5.66960E-03	9.60760E-02
6.65540E+02	4.09010E-02	1.25450E-01	5.13130E-03	8.69540E-02
6.65450E+02	3.67280E-02	1.25280E-01	4.60130E-03	7.79730E-02
6.65350E+02	2.92150E-02	1.25110E-01	3.65510E-03	6.19380E-02
6.65190E+02	2.75460E-02	1.24800E-01	3.43780E-03	5.82570E-02
6.65120E+02	3.25540E-02	1.24670E-01	4.05860E-03	6.87770E-02
6.65010E+02	3.08850E-02	1.24460E-01	3.84400E-03	6.51400E-02
6.64900E+02	2.58760E-02	1.24210E-01	3.21410E-03	5.44650E-02
6.64820E+02	2.92150E-02	1.24050E-01	3.62430E-03	6.14160E-02
6.64750E+02	3.75630E-02	1.23790E-01	4.65000E-03	7.87980E-02
6.64680E+02	4.50750E-02	1.23520E-01	5.56750E-03	9.43460E-02
6.64540E+02	4.00670E-02	1.22960E-01	4.92680E-03	8.34890E-02
6.64420E+02	2.67110E-02	1.22510E-01	3.27230E-03	5.54520E-02
6.64330E+02	1.33560E-02	1.22140E-01	1.63130E-03	2.76430E-02
6.64240E+02	0.00000E+00	1.21790E-01	0.00000E+00	0.00000E+00

Channel 2

Wave Number	HIRS Filter Transmittance	Optical Element Transmittance	Product of the HIRS Filter and Optical Element Transmittances	Normalized Value of Col. 4
6.97000E+02	0.00000E+00	1.92340E-01	0.00000E+00	0.00000E+00
6.96340E+02	4.04120E-03	1.90390E-01	7.69430E-04	7.55680E-03
6.95710E+02	5.68980E-03	1.88600E-01	1.07310E-03	1.05390E-02
6.95080E+02	7.33830E-03	1.86830E-01	1.37100E-03	1.34650E-02
6.94410E+02	8.15070E-03	1.84960E-01	1.50760E-03	1.48060E-02
6.93780E+02	8.12980E-03	1.83710E-01	1.49350E-03	1.46680E-02
6.93150E+02	9.77840E-03	1.82450E-01	1.78410E-03	1.75220E-02
6.92440E+02	9.75470E-03	1.81030E-01	1.76590E-03	1.73430E-02
6.91930E+02	1.22420E-02	1.80030E-01	2.20390E-03	2.16450E-02
6.91510E+02	1.47320E-02	1.79200E-01	2.64000E-03	2.59280E-02
6.91090E+02	1.55530E-02	1.78370E-01	2.77420E-03	2.72460E-02

6.90840E+02	1.72140E-02	1.77880E-01	3.06200E-03	3.00730E-02
6.90550E+02	2.05430E-02	1.77300E-01	3.64230E-03	3.57730E-02
6.90290E+02	2.63780E-02	1.76810E-01	4.66390E-03	4.58050E-02
6.90080E+02	3.05450E-02	1.76400E-01	5.38800E-03	5.29170E-02
6.89710E+02	3.13670E-02	1.75610E-01	5.50840E-03	5.41000E-02
6.89450E+02	3.38630E-02	1.75080E-01	5.92870E-03	5.82280E-02
6.89200E+02	3.80280E-02	1.74560E-01	6.63820E-03	6.51960E-02
6.89030E+02	4.21960E-02	1.74210E-01	7.35120E-03	7.21980E-02
6.88870E+02	4.63640E-02	1.73870E-01	8.06130E-03	7.91730E-02
6.88610E+02	4.88600E-02	1.73350E-01	8.46990E-03	8.31860E-02
6.88450E+02	5.05240E-02	1.73010E-01	8.74100E-03	8.58490E-02
6.88400E+02	5.46960E-02	1.72920E-01	9.45820E-03	9.28920E-02
6.88190E+02	6.88790E-02	1.72490E-01	1.18810E-02	1.16690E-01
6.87980E+02	8.38970E-02	1.72070E-01	1.44360E-02	1.41780E-01
6.87810E+02	9.64120E-02	1.71710E-01	1.65550E-02	1.62590E-01
6.87650E+02	1.08090E-01	1.71360E-01	1.85230E-02	1.81920E-01
6.87480E+02	1.23950E-01	1.71010E-01	2.11960E-02	2.08170E-01
6.87230E+02	1.40630E-01	1.70480E-01	2.39750E-02	2.35470E-01
6.87020E+02	1.56490E-01	1.70040E-01	2.66090E-02	2.61330E-01
6.86720E+02	1.83190E-01	1.69430E-01	3.10370E-02	3.04820E-01
6.86640E+02	2.04050E-01	1.69250E-01	3.45360E-02	3.39190E-01
6.86510E+02	2.26590E-01	1.68990E-01	3.82910E-02	3.76070E-01
6.86260E+02	2.45780E-01	1.68470E-01	4.14050E-02	4.06660E-01
6.86050E+02	2.82500E-01	1.68030E-01	4.74680E-02	4.66200E-01
6.8590E+02	3.57610E-01	1.67080E-01	5.97480E-02	5.86800E-01
6.85210E+02	4.12690E-01	1.66290E-01	6.86280E-02	6.74010E-01
6.84870E+02	4.54410E-01	1.65290E-01	7.51090E-02	7.37670E-01
6.84660E+02	4.96140E-01	1.64590E-01	8.16610E-02	8.02020E-01
6.84410E+02	5.32860E-01	1.63790E-01	8.72750E-02	8.57160E-01
6.84030E+02	5.69580E-01	1.62740E-01	9.26940E-02	9.10380E-01
6.83910E+02	5.92110E-01	1.62510E-01	9.62210E-02	9.45020E-01
6.83700E+02	6.05460E-01	1.62110E-01	9.81500E-02	9.63960E-01
6.83610E+02	6.09630E-01	1.61950E-01	9.87300E-02	9.69660E-01
6.83400E+02	6.14630E-01	1.61560E-01	9.92980E-02	9.75240E-01
6.83240E+02	6.19630E-01	1.61240E-01	9.99110E-02	9.81260E-01
6.83150E+02	6.23800E-01	1.61090E-01	1.00490E-01	9.86910E-01
6.82900E+02	6.31310E-01	1.60620E-01	1.01400E-01	9.95860E-01
6.82690E+02	6.35470E-01	1.60230E-01	1.01820E-01	1.00000E+00
6.82480E+02	6.34630E-01	1.59840E-01	1.01440E-01	9.96250E-01
6.82310E+02	6.30450E-01	1.59520E-01	1.00570E-01	9.87760E-01
6.82190E+02	6.27940E-01	1.59290E-01	1.00030E-01	9.82390E-01
6.81980E+02	6.21260E-01	1.58910E-01	9.87210E-02	9.69580E-01
6.81760E+02	6.14570E-01	1.58520E-01	9.74250E-02	9.56840E-01

6.81430E+02	6.11220E-01	1.57910E-01	9.65210E-02	9.47960E-01
6.81130E+02	6.10380E-01	1.57360E-01	9.60480E-02	9.43330E-01
6.81010E+02	6.06200E-01	1.57120E-01	9.52470E-02	9.35460E-01
6.80800E+02	5.98680E-01	1.56730E-01	9.38300E-02	9.21540E-01
6.80420E+02	5.95330E-01	1.56020E-01	9.28830E-02	9.12240E-01
6.80130E+02	5.97830E-01	1.55470E-01	9.29450E-02	9.12840E-01
6.79870E+02	5.99490E-01	1.54960E-01	9.28990E-02	9.12390E-01
6.79710E+02	6.02820E-01	1.54360E-01	9.30500E-02	9.13880E-01
6.79500E+02	6.02810E-01	1.53600E-01	9.25940E-02	9.09400E-01
6.79240E+02	5.99470E-01	1.52690E-01	9.15320E-02	8.98960E-01
6.78990E+02	5.95280E-01	1.51750E-01	9.03340E-02	8.87200E-01
6.78780E+02	5.97780E-01	1.50970E-01	9.02470E-02	8.86350E-01
6.78490E+02	6.00270E-01	1.49880E-01	8.99700E-02	8.83620E-01
6.78320E+02	5.96100E-01	1.49260E-01	8.89750E-02	8.73850E-01
6.78070E+02	5.92750E-01	1.48340E-01	8.79270E-02	8.63560E-01
6.77860E+02	5.92740E-01	1.47570E-01	8.74710E-02	8.59080E-01
6.77770E+02	5.95240E-01	1.47260E-01	8.76580E-02	8.60920E-01
6.77560E+02	5.97740E-01	1.46510E-01	8.75730E-02	8.60080E-01
6.77310E+02	5.97730E-01	1.45630E-01	8.70470E-02	8.54920E-01
6.77060E+02	5.96050E-01	1.44750E-01	8.62820E-02	8.47400E-01
6.76890E+02	5.89370E-01	1.44260E-01	8.50250E-02	8.35060E-01
6.76680E+02	5.81020E-01	1.43990E-01	8.36610E-02	8.21670E-01
6.76470E+02	5.73500E-01	1.43720E-01	8.24220E-02	8.09500E-01
6.76260E+02	5.65980E-01	1.43450E-01	8.11870E-02	7.97370E-01
6.76050E+02	5.57620E-01	1.43170E-01	7.98360E-02	7.84100E-01
6.75920E+02	5.49270E-01	1.43010E-01	7.85510E-02	7.71480E-01
6.75840E+02	5.39250E-01	1.42900E-01	7.70600E-02	7.56830E-01
6.75630E+02	5.33400E-01	1.42630E-01	7.60790E-02	7.47190E-01
6.75460E+02	5.22550E-01	1.42410E-01	7.44170E-02	7.30870E-01
6.75290E+02	5.14190E-01	1.42180E-01	7.31080E-02	7.18020E-01
6.75170E+02	5.05010E-01	1.42010E-01	7.17140E-02	7.04330E-01
6.75040E+02	4.98320E-01	1.41830E-01	7.06790E-02	6.94160E-01
6.74920E+02	4.78290E-01	1.41660E-01	6.77540E-02	6.65430E-01
6.74660E+02	4.59910E-01	1.41310E-01	6.49910E-02	6.38300E-01
6.74500E+02	4.40710E-01	1.41080E-01	6.21760E-02	6.10650E-01
6.74370E+02	4.23180E-01	1.40890E-01	5.96210E-02	5.85560E-01
6.74160E+02	4.05640E-01	1.40570E-01	5.70210E-02	5.60020E-01
6.73990E+02	3.87270E-01	1.40310E-01	5.43390E-02	5.33690E-01
6.73780E+02	3.59720E-01	1.39990E-01	5.03590E-02	4.94590E-01
6.73530E+02	3.36340E-01	1.39610E-01	4.69560E-02	4.61180E-01
6.73320E+02	3.16300E-01	1.39290E-01	4.40580E-02	4.32710E-01
6.73150E+02	2.95420E-01	1.39040E-01	4.10750E-02	4.03410E-01
6.72940E+02	2.74550E-01	1.38720E-01	3.80860E-02	3.74050E-01

6.72690E+02	2.46160E-01	1.38280E-01	3.40390E-02	3.34310E-01
6.72440E+02	2.19440E-01	1.37740E-01	3.02250E-02	2.96850E-01
6.72060E+02	1.91050E-01	1.36920E-01	2.61580E-02	2.56900E-01
6.71680E+02	1.57650E-01	1.36090E-01	2.14550E-02	2.10720E-01
6.71260E+02	1.25910E-01	1.35140E-01	1.70160E-02	1.67120E-01
6.70920E+02	1.07540E-01	1.34360E-01	1.44490E-02	1.41910E-01
6.70590E+02	8.83290E-02	1.33760E-01	1.18150E-02	1.16040E-01
6.70460E+02	7.66380E-02	1.33550E-01	1.02350E-02	1.00520E-01
6.70210E+02	7.16220E-02	1.33140E-01	9.53560E-03	9.36520E-02
6.70000E+02	6.91100E-02	1.32790E-01	9.17750E-03	9.01350E-02
6.69830E+02	6.49310E-02	1.32520E-01	8.60470E-03	8.45100E-02
6.69620E+02	6.24200E-02	1.32180E-01	8.25050E-03	8.10310E-02
6.69450E+02	5.49020E-02	1.31900E-01	7.24170E-03	7.11240E-02
6.69290E+02	4.90530E-02	1.31630E-01	6.45690E-03	6.34150E-02
6.69120E+02	4.65440E-02	1.31350E-01	6.11370E-03	6.00450E-02
6.68910E+02	4.31980E-02	1.31010E-01	5.65940E-03	5.55830E-02
6.68780E+02	3.73510E-02	1.30800E-01	4.88560E-03	4.79830E-02
6.68610E+02	3.23370E-02	1.30530E-01	4.22100E-03	4.14550E-02
6.68400E+02	2.81560E-02	1.30200E-01	3.66590E-03	3.60050E-02
6.68240E+02	2.48120E-02	1.29940E-01	3.22390E-03	3.16630E-02
6.68110E+02	2.73120E-02	1.29740E-01	3.54340E-03	3.48010E-02
6.67940E+02	2.48020E-02	1.29470E-01	3.21120E-03	3.15390E-02
6.67860E+02	2.06260E-02	1.29340E-01	2.66780E-03	2.62010E-02
6.67650E+02	1.81140E-02	1.29010E-01	2.33700E-03	2.29530E-02
6.67560E+02	1.22690E-02	1.28880E-01	1.58120E-03	1.55300E-02
6.67440E+02	1.47690E-02	1.28690E-01	1.90050E-03	1.86660E-02
6.67350E+02	1.72700E-02	1.28560E-01	2.22010E-03	2.18050E-02
6.67140E+02	1.89320E-02	1.28230E-01	2.42770E-03	2.38430E-02
6.67020E+02	1.72590E-02	1.28030E-01	2.20970E-03	2.17020E-02
6.66930E+02	1.39170E-02	1.27900E-01	1.78000E-03	1.74820E-02
6.66760E+02	1.14070E-02	1.27640E-01	1.45600E-03	1.43000E-02
6.66430E+02	1.13960E-02	1.27120E-01	1.44870E-03	1.42280E-02
6.66050E+02	9.71430E-03	1.26410E-01	1.22800E-03	1.20610E-02
6.65340E+02	8.85590E-03	1.25070E-01	1.10760E-03	1.08790E-02
6.64660E+02	7.99880E-03	1.23440E-01	9.87390E-04	9.69750E-03
6.63490E+02	6.29040E-03	1.19530E-01	7.51880E-04	7.38450E-03
6.62600E+02	4.59170E-03	1.17670E-01	5.40310E-04	5.30660E-03
6.62060E+02	2.90410E-03	1.16550E-01	3.38480E-04	3.32430E-03
6.62000E+02	0.00000E+00	1.16440E-01	0.00000E+00	0.00000E+00
Channel 3				

Wave Number	HIRS Filter Transmittance	Optical Element Transmittance	Product of the HIRS Filter and Optical Element Transmittances	Normalized Value of Col. 4
7.09000E+02	0.00000E+00	2.15640E-01	0.00000E+00	0.00000E+00
7.05300E+02	1.16960E-02	2.09970E-01	2.45580E-03	2.10540E-02
7.04930E+02	1.33670E-02	2.09340E-01	2.79820E-03	2.39900E-02
7.04510E+02	1.50380E-02	2.08540E-01	3.13600E-03	2.68860E-02
7.04090E+02	1.83790E-02	2.07710E-01	3.81760E-03	3.27290E-02
7.03580E+02	2.17210E-02	2.06710E-01	4.48990E-03	3.84940E-02
7.03250E+02	2.25560E-02	2.06040E-01	4.64750E-03	3.98450E-02
7.02910E+02	2.67340E-02	2.05380E-01	5.49040E-03	4.70710E-02
7.02540E+02	3.09110E-02	2.04630E-01	6.32530E-03	5.42290E-02
7.02160E+02	4.17710E-02	2.03890E-01	8.51670E-03	7.30170E-02
7.01830E+02	5.01250E-02	2.03230E-01	1.01870E-02	8.73380E-02
7.01450E+02	6.09860E-02	2.02490E-01	1.23490E-02	1.05870E-01
7.01200E+02	7.10110E-02	2.02000E-01	1.43450E-02	1.22980E-01
7.00950E+02	7.85300E-02	2.01520E-01	1.58250E-02	1.35670E-01
7.00660E+02	8.85550E-02	2.00950E-01	1.77950E-02	1.52560E-01
7.00410E+02	1.06100E-01	2.00470E-01	2.12700E-02	1.82360E-01
6.99910E+02	1.38680E-01	1.99540E-01	2.76720E-02	2.37240E-01
6.99410E+02	1.82960E-01	1.98570E-01	3.63290E-02	3.11460E-01
6.99120E+02	2.14700E-01	1.97960E-01	4.25030E-02	3.64400E-01
6.98710E+02	2.66500E-01	1.97100E-01	5.25280E-02	4.50340E-01
6.98130E+02	3.38350E-01	1.95790E-01	6.62460E-02	5.67950E-01
6.97640E+02	4.06010E-01	1.94340E-01	7.89070E-02	6.76500E-01
6.96890E+02	5.00420E-01	1.92000E-01	9.60830E-02	8.23750E-01
6.96520E+02	5.48040E-01	1.90900E-01	1.04620E-01	8.96930E-01
6.96230E+02	5.73930E-01	1.90070E-01	1.09090E-01	9.35240E-01
6.95940E+02	5.93980E-01	1.89240E-01	1.12400E-01	9.63680E-01
6.95730E+02	6.06520E-01	1.88650E-01	1.14420E-01	9.80950E-01
6.95560E+02	6.15710E-01	1.88180E-01	1.15860E-01	9.93340E-01
6.95230E+02	6.21550E-01	1.87240E-01	1.16380E-01	9.97770E-01
6.95020E+02	6.24900E-01	1.86650E-01	1.16640E-01	1.00000E+00
6.94680E+02	6.23220E-01	1.85720E-01	1.15740E-01	9.92320E-01
6.94520E+02	6.19880E-01	1.85250E-01	1.14830E-01	9.84520E-01
6.94220E+02	6.10690E-01	1.84570E-01	1.12720E-01	9.66370E-01
6.93800E+02	5.95660E-01	1.83740E-01	1.09450E-01	9.38340E-01
6.93500E+02	5.83960E-01	1.83160E-01	1.06960E-01	9.17000E-01
6.93120E+02	5.65580E-01	1.82400E-01	1.03160E-01	8.84450E-01
6.92660E+02	5.45530E-01	1.81470E-01	9.89990E-02	8.48760E-01
6.92280E+02	5.27150E-01	1.80720E-01	9.52650E-02	8.16750E-01
6.91820E+02	5.07100E-01	1.79800E-01	9.11760E-02	7.81680E-01

6.91270E+02	4.89560E-01	1.78720E-01	8.74930E-02	7.50110E-01
6.90760E+02	4.78700E-01	1.77730E-01	8.50780E-02	7.29410E-01
6.90340E+02	4.72850E-01	1.76910E-01	8.36500E-02	7.17170E-01
6.89930E+02	4.67840E-01	1.76080E-01	8.23760E-02	7.06240E-01
6.89500E+02	4.64490E-01	1.75180E-01	8.13720E-02	6.97640E-01
6.89040E+02	4.61990E-01	1.74230E-01	8.04940E-02	6.90100E-01
6.88460E+02	4.62820E-01	1.73030E-01	8.00830E-02	6.86580E-01
6.87830E+02	4.61150E-01	1.71740E-01	7.91970E-02	6.78990E-01
6.87570E+02	4.59480E-01	1.71210E-01	7.86670E-02	6.74440E-01
6.87320E+02	4.51960E-01	1.70680E-01	7.71400E-02	6.61350E-01
6.86900E+02	4.43610E-01	1.69800E-01	7.53250E-02	6.45790E-01
6.86560E+02	4.33580E-01	1.69100E-01	7.33180E-02	6.28590E-01
6.86020E+02	4.20220E-01	1.67960E-01	7.05820E-02	6.05120E-01
6.85640E+02	4.11030E-01	1.67180E-01	6.87170E-02	5.89140E-01
6.85260E+02	4.01000E-01	1.66400E-01	6.67260E-02	5.72070E-01
6.85010E+02	3.91810E-01	1.65740E-01	6.49370E-02	5.56730E-01
6.84750E+02	3.78450E-01	1.64890E-01	6.24000E-02	5.34980E-01
6.84420E+02	3.60900E-01	1.63800E-01	5.91150E-02	5.06820E-01
6.84120E+02	3.40020E-01	1.62910E-01	5.53910E-02	4.74890E-01
6.83820E+02	3.24980E-01	1.62350E-01	5.27590E-02	4.52330E-01
6.83570E+02	3.12450E-01	1.61870E-01	5.05770E-02	4.33610E-01
6.83280E+02	2.96580E-01	1.61320E-01	4.78430E-02	4.10180E-01
6.82900E+02	2.78200E-01	1.60610E-01	4.46810E-02	3.83070E-01
6.82390E+02	2.44780E-01	1.59670E-01	3.90830E-02	3.35080E-01
6.81840E+02	2.08850E-01	1.58660E-01	3.31360E-02	2.84090E-01
6.81330E+02	1.75440E-01	1.57730E-01	2.76720E-02	2.37240E-01
6.80950E+02	1.53720E-01	1.57010E-01	2.41360E-02	2.06930E-01
6.80490E+02	1.31160E-01	1.56140E-01	2.04800E-02	1.75580E-01
6.80060E+02	1.13620E-01	1.55360E-01	1.76510E-02	1.51330E-01
6.79690E+02	9.94150E-02	1.54280E-01	1.53380E-02	1.31500E-01
6.79100E+02	8.02000E-02	1.52140E-01	1.22010E-02	1.04610E-01
6.78670E+02	6.68340E-02	1.50570E-01	1.00630E-02	8.62760E-02
6.78300E+02	5.59730E-02	1.49180E-01	8.34990E-03	7.15870E-02
6.78000E+02	4.76190E-02	1.48100E-01	7.05220E-03	6.04610E-02
6.77710E+02	4.34420E-02	1.47020E-01	6.38700E-03	5.47580E-02
6.77410E+02	3.92650E-02	1.45980E-01	5.73200E-03	4.91430E-02
6.77120E+02	3.67590E-02	1.44960E-01	5.32860E-03	4.56840E-02
6.76870E+02	3.17460E-02	1.44230E-01	4.57880E-03	3.92560E-02
6.76490E+02	2.58980E-02	1.43740E-01	3.72260E-03	3.19150E-02
6.76190E+02	2.08850E-02	1.43360E-01	2.99410E-03	2.56700E-02
6.75900E+02	1.92150E-02	1.42980E-01	2.74730E-03	2.35540E-02
6.75690E+02	1.67080E-02	1.42710E-01	2.38440E-03	2.04420E-02
6.74940E+02	1.75440E-02	1.41690E-01	2.48570E-03	2.13110E-02

6.74640E+02	1.50380E-02	1.41280E-01	2.12450E-03	1.82140E-02
6.74470E+02	1.25310E-02	1.41050E-01	1.76750E-03	1.51530E-02
6.71000E+02	0.00000E+00	1.34530E-01	0.00000E+00	0.00000E+00
Channel 4				
Wave Number	HIRS Filter Transmittance	Optical Element Transmittance	Product of the HIRS Filter and Optical Element Transmittances	Normalized Value of Col. 4
7.22000E+02	0.00000E+00	2.36890E-01	0.00000E+00	0.00000E+00
7.21200E+02	3.27650E-03	2.35720E-01	7.72340E-04	5.23100E-03
7.20170E+02	6.43650E-03	2.34240E-01	1.50770E-03	1.02110E-02
7.19290E+02	5.40150E-03	2.32780E-01	1.25740E-03	8.51610E-03
7.18410E+02	7.51110E-03	2.31220E-01	1.73670E-03	1.17630E-02
7.17530E+02	1.06690E-02	2.29630E-01	2.44990E-03	1.65930E-02
7.16720E+02	1.27770E-02	2.28160E-01	2.91530E-03	1.97450E-02
7.15840E+02	2.01280E-02	2.26570E-01	4.56050E-03	3.08880E-02
7.15110E+02	2.95730E-02	2.25310E-01	6.66320E-03	4.51300E-02
7.14080E+02	4.21670E-02	2.23660E-01	9.43130E-03	6.38770E-02
7.13280E+02	5.68540E-02	2.22380E-01	1.26430E-02	8.56300E-02
7.12620E+02	7.57320E-02	2.21330E-01	1.67610E-02	1.13520E-01
7.11670E+02	1.06140E-01	2.19820E-01	2.33330E-02	1.58030E-01
7.10870E+02	1.43890E-01	2.18550E-01	3.14480E-02	2.13000E-01
7.10360E+02	1.81640E-01	2.17750E-01	3.95520E-02	2.67880E-01
7.10000E+02	2.04700E-01	2.17180E-01	4.44580E-02	3.01110E-01
7.09420E+02	2.48740E-01	2.16290E-01	5.37980E-02	3.64370E-01
7.08910E+02	2.94860E-01	2.15500E-01	6.35430E-02	4.30370E-01
7.08410E+02	3.43090E-01	2.14710E-01	7.36650E-02	4.98930E-01
7.07610E+02	4.03900E-01	2.13470E-01	8.62210E-02	5.83970E-01
7.06950E+02	4.58420E-01	2.12460E-01	9.73960E-02	6.59660E-01
7.06230E+02	5.22370E-01	2.11370E-01	1.10410E-01	7.47810E-01
7.05500E+02	5.84220E-01	2.10270E-01	1.22850E-01	8.32040E-01
7.04780E+02	6.25120E-01	2.09050E-01	1.30680E-01	8.85110E-01
7.04270E+02	6.58670E-01	2.08070E-01	1.37050E-01	9.28220E-01
7.03760E+02	6.80690E-01	2.07050E-01	1.40940E-01	9.54560E-01
7.03170E+02	7.01660E-01	2.05890E-01	1.44470E-01	9.78450E-01
7.02810E+02	7.15290E-01	2.05170E-01	1.46760E-01	9.93960E-01
7.02440E+02	7.21590E-01	2.04450E-01	1.47530E-01	9.99180E-01
7.02080E+02	7.24740E-01	2.03720E-01	1.47650E-01	1.00000E+00
7.01710E+02	7.26840E-01	2.03000E-01	1.47550E-01	9.99350E-01
7.01420E+02	7.25800E-01	2.02430E-01	1.46920E-01	9.95100E-01
7.01050E+02	7.19510E-01	2.01710E-01	1.45130E-01	9.82980E-01
7.00610E+02	7.10080E-01	2.00850E-01	1.42620E-01	9.65950E-01
7.00170E+02	6.96460E-01	2.00020E-01	1.39310E-01	9.43500E-01

6.99870E+02	6.83890E-01	1.99460E-01	1.36410E-01	9.23910E-01
6.99500E+02	6.71320E-01	1.98760E-01	1.33430E-01	9.03700E-01
6.99130E+02	6.53500E-01	1.97980E-01	1.29380E-01	8.76300E-01
6.98830E+02	6.33590E-01	1.97370E-01	1.25050E-01	8.46950E-01
6.98390E+02	6.13680E-01	1.96450E-01	1.20560E-01	8.16510E-01
6.98020E+02	5.88530E-01	1.95500E-01	1.15060E-01	7.79280E-01
6.97650E+02	5.63380E-01	1.94390E-01	1.09520E-01	7.41760E-01
6.97210E+02	5.32990E-01	1.92990E-01	1.02860E-01	6.96670E-01
6.96910E+02	5.03640E-01	1.92050E-01	9.67260E-02	6.55120E-01
6.96540E+02	4.79540E-01	1.90950E-01	9.15660E-02	6.20170E-01
6.96240E+02	4.50190E-01	1.90100E-01	8.55790E-02	5.79620E-01
6.95720E+02	4.14560E-01	1.88620E-01	7.81940E-02	5.29610E-01
6.95270E+02	3.72640E-01	1.87370E-01	6.98200E-02	4.72890E-01
6.94680E+02	3.14990E-01	1.85700E-01	5.84960E-02	3.96190E-01
6.94010E+02	2.72030E-01	1.84160E-01	5.00970E-02	3.39310E-01
6.93420E+02	2.20670E-01	1.82990E-01	4.03800E-02	2.73490E-01
6.92820E+02	1.78750E-01	1.81800E-01	3.24970E-02	2.20100E-01
6.92380E+02	1.50460E-01	1.80910E-01	2.72200E-02	1.84360E-01
6.91790E+02	1.27410E-01	1.79740E-01	2.29010E-02	1.55110E-01
6.91270E+02	1.06450E-01	1.78730E-01	1.90250E-02	1.28860E-01
6.90900E+02	9.17800E-02	1.78000E-01	1.63370E-02	1.10650E-01
6.90390E+02	7.50170E-02	1.76990E-01	1.32770E-02	8.99260E-02
6.89870E+02	6.13980E-02	1.75970E-01	1.08040E-02	7.31750E-02
6.89430E+02	4.98740E-02	1.75030E-01	8.72950E-03	5.91240E-02
6.89060E+02	4.04450E-02	1.74270E-01	7.04850E-03	4.77390E-02
6.88770E+02	3.10160E-02	1.73670E-01	5.38650E-03	3.64820E-02
6.88180E+02	2.68320E-02	1.72470E-01	4.62760E-03	3.13420E-02
6.87740E+02	2.26450E-02	1.71550E-01	3.88490E-03	2.63120E-02
6.87150E+02	1.74130E-02	1.70320E-01	2.96580E-03	2.00870E-02
6.86270E+02	1.32330E-02	1.68490E-01	2.22970E-03	1.51010E-02
6.85540E+02	1.32440E-02	1.66970E-01	2.21140E-03	1.49780E-02
6.85020E+02	1.22040E-02	1.65790E-01	2.02330E-03	1.37030E-02
6.84360E+02	5.92450E-03	1.63620E-01	9.69390E-04	6.56560E-03
6.83920E+02	1.73820E-03	1.62530E-01	2.82520E-04	1.91350E-03
6.83410E+02	4.89060E-03	1.61560E-01	7.90140E-04	5.35160E-03
6.83190E+02	6.99030E-03	1.61160E-01	1.12650E-03	7.62990E-03
6.82450E+02	7.00130E-03	1.59790E-01	1.11870E-03	7.57710E-03
6.81500E+02	7.01560E-03	1.58050E-01	1.10880E-03	7.50970E-03
6.80690E+02	4.93120E-03	1.56530E-01	7.71890E-04	5.22790E-03
6.80110E+02	7.03650E-03	1.55430E-01	1.09370E-03	7.40760E-03
6.79670E+02	7.04300E-03	1.54210E-01	1.08610E-03	7.35630E-03
6.79230E+02	7.04960E-03	1.52620E-01	1.07590E-03	7.28700E-03
6.79000E+02	0.00000E+00	1.51780E-01	0.00000E+00	0.00000E+00

Channel 5				
Wave Number	HIRS Filter Transmittance	Optical Element Transmittance	Product of the HIRS Filter and Optical Element Transmittances	Normalized Value of Col. 4
7.38000E+02	0.00000E+00	2.59160E-01	0.00000E+00	0.00000E+00
7.34420E+02	1.15060E-02	2.54500E-01	2.92840E-03	1.87030E-02
7.34290E+02	1.46440E-02	2.54340E-01	3.72470E-03	2.37900E-02
7.34160E+02	1.88280E-02	2.54190E-01	4.78600E-03	3.05680E-02
7.33980E+02	1.77820E-02	2.53960E-01	4.51590E-03	2.88430E-02
7.33350E+02	2.09200E-02	2.53180E-01	5.29660E-03	3.38300E-02
7.32660E+02	2.51050E-02	2.52320E-01	6.33450E-03	4.04590E-02
7.31970E+02	2.82430E-02	2.51350E-01	7.09870E-03	4.53390E-02
7.31400E+02	3.55650E-02	2.50530E-01	8.91000E-03	5.69090E-02
7.30900E+02	4.70710E-02	2.49800E-01	1.17580E-02	7.51020E-02
7.30150E+02	5.96230E-02	2.48720E-01	1.48290E-02	9.47160E-02
7.29460E+02	7.63600E-02	2.47730E-01	1.89160E-02	1.20820E-01
7.29210E+02	9.30960E-02	2.47370E-01	2.30290E-02	1.47090E-01
7.28770E+02	1.04600E-01	2.46740E-01	2.58100E-02	1.64850E-01
7.28270E+02	1.23430E-01	2.46020E-01	3.03660E-02	1.93950E-01
7.27580E+02	1.53770E-01	2.45000E-01	3.76720E-02	2.40610E-01
7.26960E+02	1.92470E-01	2.44070E-01	4.69760E-02	3.00040E-01
7.26210E+02	2.52090E-01	2.43020E-01	6.12650E-02	3.91300E-01
7.25330E+02	3.10670E-01	2.41780E-01	7.51150E-02	4.79760E-01
7.24650E+02	3.69250E-01	2.40770E-01	8.89050E-02	5.67840E-01
7.23900E+02	4.26780E-01	2.39670E-01	1.02280E-01	6.53300E-01
7.23210E+02	4.76990E-01	2.38660E-01	1.13840E-01	7.27080E-01
7.22650E+02	5.13600E-01	2.37830E-01	1.22150E-01	7.80190E-01
7.22150E+02	5.46020E-01	2.37100E-01	1.29470E-01	8.26900E-01
7.21650E+02	5.72180E-01	2.36380E-01	1.35250E-01	8.63840E-01
7.21150E+02	5.89960E-01	2.35650E-01	1.39020E-01	8.87950E-01
7.20650E+02	6.08790E-01	2.34920E-01	1.43020E-01	9.13460E-01
7.20210E+02	6.22380E-01	2.34290E-01	1.45820E-01	9.31340E-01
7.19770E+02	6.34940E-01	2.33610E-01	1.48330E-01	9.47380E-01
7.19460E+02	6.44350E-01	2.33080E-01	1.50180E-01	9.59240E-01
7.19020E+02	6.53770E-01	2.32300E-01	1.51870E-01	9.69990E-01
7.18580E+02	6.59000E-01	2.31520E-01	1.52570E-01	9.74460E-01
7.18260E+02	6.66320E-01	2.30960E-01	1.53890E-01	9.82930E-01
7.17890E+02	6.74690E-01	2.30280E-01	1.55370E-01	9.92350E-01
7.17390E+02	6.79920E-01	2.29370E-01	1.55950E-01	9.96080E-01
7.16880E+02	6.80960E-01	2.28460E-01	1.55570E-01	9.93640E-01
7.16570E+02	6.83050E-01	2.27880E-01	1.55650E-01	9.94160E-01
7.16190E+02	6.86190E-01	2.27190E-01	1.55890E-01	9.95690E-01

7.15880E+02	6.88290E-01	2.26640E-01	1.55990E-01	9.96340E-01
7.15570E+02	6.92470E-01	2.26100E-01	1.56570E-01	1.00000E+00
7.15310E+02	6.90380E-01	2.25670E-01	1.55800E-01	9.95070E-01
7.14880E+02	6.87240E-01	2.24940E-01	1.54590E-01	9.87350E-01
7.14310E+02	6.83050E-01	2.24030E-01	1.53020E-01	9.77370E-01
7.13680E+02	6.77820E-01	2.23020E-01	1.51170E-01	9.65520E-01
7.13180E+02	6.73640E-01	2.22220E-01	1.49690E-01	9.56100E-01
7.12740E+02	6.70500E-01	2.21520E-01	1.48530E-01	9.48650E-01
7.12300E+02	6.63180E-01	2.20820E-01	1.46440E-01	9.35330E-01
7.11990E+02	6.56900E-01	2.20320E-01	1.44730E-01	9.24390E-01
7.11550E+02	6.49580E-01	2.19620E-01	1.42660E-01	9.11190E-01
7.11170E+02	6.39120E-01	2.19030E-01	1.39980E-01	8.94090E-01
7.10980E+02	6.27620E-01	2.18730E-01	1.37280E-01	8.76800E-01
7.10540E+02	6.05650E-01	2.18030E-01	1.32050E-01	8.43420E-01
7.10100E+02	5.76360E-01	2.17340E-01	1.25270E-01	8.00090E-01
7.09530E+02	5.42890E-01	2.16460E-01	1.17510E-01	7.50560E-01
7.09220E+02	5.13600E-01	2.15980E-01	1.10920E-01	7.08480E-01
7.08840E+02	4.79080E-01	2.15390E-01	1.03190E-01	6.59060E-01
7.08270E+02	4.19460E-01	2.14500E-01	8.99730E-02	5.74660E-01
7.07640E+02	3.59830E-01	2.13520E-01	7.68310E-02	4.90730E-01
7.07070E+02	3.03350E-01	2.12640E-01	6.45040E-02	4.11990E-01
7.06690E+02	2.60460E-01	2.12060E-01	5.52320E-02	3.52770E-01
7.06120E+02	2.12340E-01	2.11210E-01	4.48480E-02	2.86450E-01
7.05680E+02	1.76780E-01	2.10540E-01	3.72190E-02	2.37720E-01
7.05300E+02	1.51670E-01	2.09970E-01	3.18470E-02	2.03410E-01
7.04990E+02	1.34940E-01	2.09460E-01	2.82630E-02	1.80520E-01
7.04740E+02	1.20290E-01	2.08980E-01	2.51380E-02	1.60560E-01
7.04360E+02	1.03560E-01	2.08250E-01	2.15650E-02	1.37740E-01
7.04040E+02	8.89120E-02	2.07620E-01	1.84600E-02	1.17900E-01
7.03670E+02	7.42680E-02	2.06870E-01	1.53640E-02	9.81280E-02
7.03410E+02	6.27610E-02	2.06370E-01	1.29520E-02	8.27240E-02
7.03100E+02	5.23010E-02	2.05740E-01	1.07610E-02	6.87280E-02
7.02720E+02	4.70710E-02	2.05000E-01	9.64950E-03	6.16320E-02
7.02220E+02	4.07950E-02	2.04010E-01	8.32240E-03	5.31560E-02
7.01660E+02	3.45190E-02	2.02900E-01	7.00370E-03	4.47330E-02
7.01340E+02	2.92890E-02	2.02280E-01	5.92450E-03	3.78400E-02
7.00780E+02	2.40590E-02	2.01180E-01	4.84000E-03	3.09140E-02
7.00340E+02	2.09200E-02	2.00340E-01	4.19120E-03	2.67690E-02
6.99830E+02	1.67360E-02	1.99400E-01	3.33720E-03	2.13150E-02
6.99520E+02	1.35980E-02	1.98800E-01	2.70330E-03	1.72660E-02
6.99140E+02	1.35980E-02	1.98010E-01	2.69260E-03	1.71980E-02
6.98830E+02	1.25520E-02	1.97350E-01	2.47720E-03	1.58220E-02
6.98390E+02	1.15060E-02	1.96440E-01	2.26030E-03	1.44370E-02

6.94000E+02	0.00000E+00	1.84140E-01	0.00000E+00	0.00000E+00
Channel 6				
Wave Number	HIRS Filter Transmittance	Optical Element Transmittance	Product of the HIRS Filter and Optical Element Transmittances	Normalized Value of Col. 4
7.51000E+02	0.00000E+00	2.94170E-01	0.00000E+00	0.00000E+00
7.47380E+02	1.05830E-02	2.86130E-01	3.02810E-03	1.70140E-02
7.47220E+02	1.26840E-02	2.85760E-01	3.62460E-03	2.03660E-02
7.47060E+02	1.47850E-02	2.85400E-01	4.21960E-03	2.37090E-02
7.46490E+02	1.69030E-02	2.84080E-01	4.80180E-03	2.69800E-02
7.45860E+02	1.79760E-02	2.82640E-01	5.08090E-03	2.85480E-02
7.45330E+02	2.21870E-02	2.81440E-01	6.24430E-03	3.50860E-02
7.44760E+02	2.74460E-02	2.80130E-01	7.68870E-03	4.32010E-02
7.44130E+02	3.48030E-02	2.78190E-01	9.68190E-03	5.44000E-02
7.43500E+02	4.32060E-02	2.76250E-01	1.19350E-02	6.70630E-02
7.42980E+02	5.26520E-02	2.74630E-01	1.44600E-02	8.12460E-02
7.42560E+02	6.20930E-02	2.73340E-01	1.69730E-02	9.53660E-02
7.42140E+02	7.88650E-02	2.72060E-01	2.14560E-02	1.20560E-01
7.41670E+02	9.56380E-02	2.70640E-01	2.58830E-02	1.45430E-01
7.41350E+02	1.11360E-01	2.69690E-01	3.00320E-02	1.68740E-01
7.41040E+02	1.29170E-01	2.68760E-01	3.47160E-02	1.95060E-01
7.40720E+02	1.55360E-01	2.67810E-01	4.16070E-02	2.33780E-01
7.40250E+02	1.89940E-01	2.66320E-01	5.05840E-02	2.84220E-01
7.39830E+02	2.27650E-01	2.64990E-01	6.03260E-02	3.38960E-01
7.39310E+02	2.80030E-01	2.63330E-01	7.37410E-02	4.14340E-01
7.38730E+02	3.40790E-01	2.61490E-01	8.91120E-02	5.00700E-01
7.38260E+02	4.03630E-01	2.59980E-01	1.04940E-01	5.89620E-01
7.37630E+02	4.88480E-01	2.58480E-01	1.26260E-01	7.09440E-01
7.37210E+02	5.34570E-01	2.57970E-01	1.37900E-01	7.74840E-01
7.36690E+02	5.92180E-01	2.57320E-01	1.52380E-01	8.56210E-01
7.36220E+02	6.33040E-01	2.56740E-01	1.62530E-01	9.13220E-01
7.35800E+02	6.59230E-01	2.56220E-01	1.68910E-01	9.49070E-01
7.35530E+02	6.72860E-01	2.55890E-01	1.72180E-01	9.67440E-01
7.35170E+02	6.85440E-01	2.55440E-01	1.75090E-01	9.83770E-01
7.34850E+02	6.93830E-01	2.55040E-01	1.76960E-01	9.94280E-01
7.34590E+02	6.98030E-01	2.54720E-01	1.77800E-01	9.99020E-01
7.34170E+02	7.00140E-01	2.54200E-01	1.77970E-01	1.00000E+00
7.33910E+02	6.98050E-01	2.53870E-01	1.77220E-01	9.95750E-01
7.33540E+02	6.95980E-01	2.53420E-01	1.76370E-01	9.91010E-01
7.33280E+02	6.89700E-01	2.53090E-01	1.74560E-01	9.80820E-01
7.32910E+02	6.81340E-01	2.52640E-01	1.72130E-01	9.67190E-01
7.32500E+02	6.71940E-01	2.52110E-01	1.69400E-01	9.51840E-01

7.31870E+02	6.62540E-01	2.51200E-01	1.66430E-01	9.35120E-01
7.31450E+02	6.56270E-01	2.50590E-01	1.64460E-01	9.24040E-01
7.30870E+02	6.48970E-01	2.49760E-01	1.62080E-01	9.10710E-01
7.30500E+02	6.40610E-01	2.49230E-01	1.59660E-01	8.97070E-01
7.29980E+02	6.29110E-01	2.48470E-01	1.56320E-01	8.78310E-01
7.29400E+02	6.19710E-01	2.47640E-01	1.53470E-01	8.62300E-01
7.28770E+02	6.07170E-01	2.46750E-01	1.49820E-01	8.41790E-01
7.28250E+02	5.95670E-01	2.45990E-01	1.46530E-01	8.23310E-01
7.27730E+02	5.77900E-01	2.45210E-01	1.41700E-01	7.96200E-01
7.27310E+02	5.61160E-01	2.44580E-01	1.37250E-01	7.71180E-01
7.26940E+02	5.44420E-01	2.44040E-01	1.32860E-01	7.46520E-01
7.26470E+02	5.25590E-01	2.43380E-01	1.27920E-01	7.18740E-01
7.26050E+02	5.03620E-01	2.42810E-01	1.22280E-01	6.87080E-01
7.25730E+02	4.84780E-01	2.42370E-01	1.17500E-01	6.60200E-01
7.25310E+02	4.62810E-01	2.41760E-01	1.11890E-01	6.28670E-01
7.25000E+02	4.39790E-01	2.41290E-01	1.06120E-01	5.96260E-01
7.24370E+02	3.98980E-01	2.40370E-01	9.59010E-02	5.38850E-01
7.23790E+02	3.55020E-01	2.39520E-01	8.50340E-02	4.77790E-01
7.23170E+02	3.06880E-01	2.38590E-01	7.32200E-02	4.11410E-01
7.22380E+02	2.50370E-01	2.37440E-01	5.94490E-02	3.34030E-01
7.21910E+02	2.18980E-01	2.36760E-01	5.18440E-02	2.91300E-01
7.21590E+02	1.97000E-01	2.36300E-01	4.65510E-02	2.61560E-01
7.21230E+02	1.78170E-01	2.35770E-01	4.20060E-02	2.36020E-01
7.20960E+02	1.59330E-01	2.35390E-01	3.75040E-02	2.10730E-01
7.20700E+02	1.43640E-01	2.35010E-01	3.37550E-02	1.89660E-01
7.20390E+02	1.27940E-01	2.34550E-01	3.00090E-02	1.68610E-01
7.20070E+02	1.15390E-01	2.34100E-01	2.70120E-02	1.51780E-01
7.19760E+02	1.04930E-01	2.33600E-01	2.45120E-02	1.37730E-01
7.19340E+02	9.13370E-02	2.32870E-01	2.12700E-02	1.19510E-01
7.18920E+02	7.77420E-02	2.32130E-01	1.80460E-02	1.01400E-01
7.18400E+02	6.31040E-02	2.31200E-01	1.45890E-02	8.19750E-02
7.17820E+02	4.95160E-02	2.30160E-01	1.13970E-02	6.40350E-02
7.17240E+02	3.80220E-02	2.29110E-01	8.71120E-03	4.89460E-02
7.16880E+02	3.07070E-02	2.28440E-01	7.01490E-03	3.94150E-02
7.16560E+02	2.65320E-02	2.27860E-01	6.04570E-03	3.39690E-02
7.16140E+02	2.55020E-02	2.27100E-01	5.79150E-03	3.25420E-02
7.15830E+02	2.34210E-02	2.26550E-01	5.30620E-03	2.98140E-02
7.15570E+02	2.13380E-02	2.26100E-01	4.82450E-03	2.71080E-02
7.15250E+02	1.82100E-02	2.25560E-01	4.10740E-03	2.30790E-02
7.14730E+02	1.50910E-02	2.24700E-01	3.39080E-03	1.90520E-02
7.14360E+02	1.51060E-02	2.24110E-01	3.38540E-03	1.90220E-02
7.14050E+02	1.30250E-02	2.23600E-01	2.91240E-03	1.63640E-02
7.13730E+02	9.89660E-03	2.23100E-01	2.20790E-03	1.24060E-02

7.11000E+02	0.00000E+00	2.18760E-01	0.00000E+00	0.00000E+00
Channel 7				
Wave Number	HIRS Filter Transmittance	Optical Element Transmittance	Product of the HIRS Filter and Optical Element Transmittances	Normalized Value of Col. 4
7.74000E+02	0.00000E+00	3.33290E-01	0.00000E+00	0.00000E+00
7.73180E+02	3.03940E-03	3.31810E-01	1.00850E-03	4.53210E-03
7.71720E+02	6.15880E-03	3.28940E-01	2.02590E-03	9.10410E-03
7.70470E+02	6.14020E-03	3.27150E-01	2.00880E-03	9.02720E-03
7.69590E+02	1.03160E-02	3.25960E-01	3.36240E-03	1.51110E-02
7.68420E+02	1.34390E-02	3.24390E-01	4.35960E-03	1.95920E-02
7.67460E+02	2.18020E-02	3.23120E-01	7.04470E-03	3.16590E-02
7.66360E+02	3.12100E-02	3.21660E-01	1.00390E-02	4.51150E-02
7.65410E+02	3.95720E-02	3.18300E-01	1.25960E-02	5.66050E-02
7.64670E+02	5.10800E-02	3.14950E-01	1.60880E-02	7.22970E-02
7.64010E+02	6.78240E-02	3.11950E-01	2.11570E-02	9.50800E-02
7.63350E+02	8.77090E-02	3.08950E-01	2.70980E-02	1.21780E-01
7.62540E+02	1.18060E-01	3.07180E-01	3.62670E-02	1.62980E-01
7.61950E+02	1.40040E-01	3.06480E-01	4.29210E-02	1.92880E-01
7.61730E+02	1.56790E-01	3.06220E-01	4.80140E-02	2.15770E-01
7.60540E+02	2.45780E-01	3.04820E-01	7.49190E-02	3.36680E-01
7.59650E+02	3.16970E-01	3.03770E-01	9.62880E-02	4.32710E-01
7.58830E+02	3.87120E-01	3.02810E-01	1.17220E-01	5.26790E-01
7.58390E+02	4.30040E-01	3.02260E-01	1.29990E-01	5.84150E-01
7.57720E+02	5.01240E-01	3.01440E-01	1.51090E-01	6.79000E-01
7.57050E+02	5.59870E-01	3.00620E-01	1.68300E-01	7.56350E-01
7.56530E+02	5.97550E-01	3.00020E-01	1.79280E-01	8.05660E-01
7.55860E+02	6.36290E-01	2.99330E-01	1.90460E-01	8.55920E-01
7.55270E+02	6.68740E-01	2.98720E-01	1.99770E-01	8.97740E-01
7.54900E+02	6.89680E-01	2.98340E-01	2.05760E-01	9.24660E-01
7.54460E+02	7.01190E-01	2.97880E-01	2.08870E-01	9.38660E-01
7.53650E+02	7.22120E-01	2.97050E-01	2.14510E-01	9.63980E-01
7.52480E+02	7.38860E-01	2.95880E-01	2.18610E-01	9.82430E-01
7.51670E+02	7.51410E-01	2.95050E-01	2.21700E-01	9.96310E-01
7.50720E+02	7.55580E-01	2.93800E-01	2.21990E-01	9.97600E-01
7.49840E+02	7.57660E-01	2.91870E-01	2.21140E-01	9.93790E-01
7.49250E+02	7.66030E-01	2.90490E-01	2.22520E-01	1.00000E+00
7.48510E+02	7.70210E-01	2.88760E-01	2.22410E-01	9.99490E-01
7.48000E+02	7.71250E-01	2.87560E-01	2.21780E-01	9.96680E-01
7.47200E+02	7.73330E-01	2.85700E-01	2.20940E-01	9.92900E-01
7.46610E+02	7.75420E-01	2.84350E-01	2.20490E-01	9.90880E-01
7.45950E+02	7.80640E-01	2.82840E-01	2.20800E-01	9.92250E-01

7.45070E+02	7.73300E-01	2.80840E-01	2.17170E-01	9.75960E-01
7.44630E+02	7.65960E-01	2.79750E-01	2.14280E-01	9.62960E-01
7.44190E+02	7.54440E-01	2.78390E-01	2.10030E-01	9.43850E-01
7.43750E+02	7.41870E-01	2.77030E-01	2.05520E-01	9.23590E-01
7.43460E+02	7.26160E-01	2.76130E-01	2.00510E-01	9.01100E-01
7.43170E+02	7.12540E-01	2.75230E-01	1.96110E-01	8.81320E-01
7.42880E+02	6.98920E-01	2.74340E-01	1.91740E-01	8.61670E-01
7.42590E+02	6.73790E-01	2.73450E-01	1.84240E-01	8.27980E-01
7.42160E+02	6.36080E-01	2.72120E-01	1.73090E-01	7.77850E-01
7.41650E+02	5.90000E-01	2.70590E-01	1.59650E-01	7.17450E-01
7.41440E+02	5.51260E-01	2.69940E-01	1.48810E-01	6.68730E-01
7.40930E+02	4.94700E-01	2.68450E-01	1.32800E-01	5.96810E-01
7.40360E+02	4.19300E-01	2.66650E-01	1.11810E-01	5.02450E-01
7.39560E+02	3.40760E-01	2.64140E-01	9.00090E-02	4.04490E-01
7.39060E+02	2.78970E-01	2.62540E-01	7.32390E-02	3.29130E-01
7.38480E+02	2.17180E-01	2.60690E-01	5.66160E-02	2.54430E-01
7.37830E+02	1.72140E-01	2.58730E-01	4.45380E-02	2.00150E-01
7.37250E+02	1.38630E-01	2.58010E-01	3.57670E-02	1.60740E-01
7.36810E+02	1.12440E-01	2.57480E-01	2.89510E-02	1.30100E-01
7.36230E+02	9.04450E-02	2.56760E-01	2.32230E-02	1.04360E-01
7.35640E+02	6.94940E-02	2.56030E-01	1.77920E-02	7.99580E-02
7.35060E+02	5.37780E-02	2.55300E-01	1.37300E-02	6.17000E-02
7.34400E+02	4.22500E-02	2.54480E-01	1.07520E-02	4.83180E-02
7.33890E+02	3.28180E-02	2.53850E-01	8.33080E-03	3.74380E-02
7.33300E+02	2.96680E-02	2.53120E-01	7.50970E-03	3.37480E-02
7.32720E+02	2.44240E-02	2.52400E-01	6.16450E-03	2.77030E-02
7.32280E+02	1.70870E-02	2.51800E-01	4.30250E-03	1.93350E-02
7.31620E+02	1.28890E-02	2.50840E-01	3.23310E-03	1.45290E-02
7.30810E+02	9.73550E-03	2.49680E-01	2.43070E-03	1.09230E-02
7.29940E+02	8.67520E-03	2.48410E-01	2.15500E-03	9.68440E-03
7.28980E+02	6.56670E-03	2.47040E-01	1.62230E-03	7.29040E-03
7.27960E+02	4.45710E-03	2.45550E-01	1.09440E-03	4.91840E-03
7.27000E+02	4.44290E-03	2.44140E-01	1.08470E-03	4.87440E-03
7.26420E+02	2.33980E-03	2.43310E-01	5.69310E-04	2.55840E-03
7.25980E+02	2.39030E-04	2.42710E-01	5.80150E-05	2.60720E-04
7.25100E+02	2.32010E-03	2.41440E-01	5.60170E-04	2.51740E-03
7.24000E+02	0.00000E+00	2.39820E-01	0.00000E+00	0.00000E+00

Channel 8

Wave Number	HIRS Filter Transmittance	Optical Element Transmittance	Product of the HIRS Filter and Optical Element Transmittances	Normalized Value of Col. 4
9.48000E+02	0.00000E+00	4.72010E-01	0.00000E+00	0.00000E+00

9.47870E+02	5.22470E-03	4.71920E-01	2.46560E-03	6.03420E-03
9.45150E+02	4.17970E-03	4.70090E-01	1.96490E-03	4.80870E-03
9.41590E+02	5.22470E-03	4.67700E-01	2.44360E-03	5.98030E-03
9.39290E+02	6.26960E-03	4.66200E-01	2.92290E-03	7.15330E-03
9.36780E+02	6.26960E-03	4.67470E-01	2.93080E-03	7.17280E-03
9.34270E+02	1.25390E-02	4.69580E-01	5.88820E-03	1.44110E-02
9.31760E+02	1.77640E-02	4.71800E-01	8.38100E-03	2.05110E-02
9.29880E+02	2.71680E-02	4.73410E-01	1.28620E-02	3.14770E-02
9.28000E+02	3.97070E-02	4.73810E-01	1.88140E-02	4.60440E-02
9.26750E+02	5.32910E-02	4.73520E-01	2.52350E-02	6.17590E-02
9.25290E+02	7.10550E-02	4.73190E-01	3.36230E-02	8.22870E-02
9.23620E+02	1.02400E-01	4.72790E-01	4.84150E-02	1.18490E-01
9.21540E+02	1.54650E-01	4.72270E-01	7.30360E-02	1.78740E-01
9.20090E+02	2.13170E-01	4.71610E-01	1.00530E-01	2.46040E-01
9.18840E+02	2.65410E-01	4.70890E-01	1.24980E-01	3.05870E-01
9.16360E+02	3.99160E-01	4.69450E-01	1.87390E-01	4.58600E-01
9.13880E+02	5.37100E-01	4.68590E-01	2.51680E-01	6.15950E-01
9.12230E+02	6.37410E-01	4.69060E-01	2.98980E-01	7.31720E-01
9.09940E+02	7.28320E-01	4.69830E-01	3.42180E-01	8.37440E-01
9.07650E+02	7.85790E-01	4.70530E-01	3.69740E-01	9.04890E-01
9.06410E+02	8.15050E-01	4.70910E-01	3.83810E-01	9.39330E-01
9.05360E+02	8.31770E-01	4.71210E-01	3.91930E-01	9.59200E-01
9.04320E+02	8.44300E-01	4.71500E-01	3.98090E-01	9.74270E-01
9.03070E+02	8.54750E-01	4.71790E-01	4.03260E-01	9.86930E-01
9.01600E+02	8.63110E-01	4.71210E-01	4.06700E-01	9.95350E-01
9.00140E+02	8.68340E-01	4.70560E-01	4.08600E-01	1.00000E+00
8.98680E+02	8.67290E-01	4.69910E-01	4.07550E-01	9.97420E-01
8.97210E+02	8.65200E-01	4.69250E-01	4.06000E-01	9.93630E-01
8.94910E+02	8.58930E-01	4.67950E-01	4.01940E-01	9.83690E-01
8.93230E+02	8.50570E-01	4.66920E-01	3.97150E-01	9.71970E-01
8.91140E+02	8.44300E-01	4.65490E-01	3.93010E-01	9.61840E-01
8.89670E+02	8.33860E-01	4.63850E-01	3.86790E-01	9.46600E-01
8.88420E+02	8.22360E-01	4.62410E-01	3.80270E-01	9.30660E-01
8.87570E+02	8.07730E-01	4.61470E-01	3.72740E-01	9.12230E-01
8.86520E+02	7.91010E-01	4.60250E-01	3.64070E-01	8.91000E-01
8.86100E+02	7.65940E-01	4.59770E-01	3.52150E-01	8.61840E-01
8.85050E+02	7.42950E-01	4.58560E-01	3.40680E-01	8.33770E-01
8.84420E+02	7.19960E-01	4.57830E-01	3.29620E-01	8.06690E-01
8.83580E+02	6.93830E-01	4.56860E-01	3.16980E-01	7.75770E-01
8.82730E+02	6.50990E-01	4.55880E-01	2.96780E-01	7.26320E-01
8.81880E+02	5.97700E-01	4.54930E-01	2.71910E-01	6.65470E-01
8.81040E+02	5.62170E-01	4.53940E-01	2.55190E-01	6.24540E-01
8.80610E+02	5.20380E-01	4.53460E-01	2.35970E-01	5.77500E-01

8.80400E+02	4.86940E-01	4.53220E-01	2.20690E-01	5.40110E-01
8.79340E+02	4.31560E-01	4.52060E-01	1.95090E-01	4.77450E-01
8.78490E+02	4.03340E-01	4.51130E-01	1.81960E-01	4.45320E-01
8.78060E+02	3.21840E-01	4.50650E-01	1.45040E-01	3.54960E-01
8.76790E+02	2.60190E-01	4.49340E-01	1.16910E-01	2.86130E-01
8.75520E+02	2.06900E-01	4.48450E-01	9.27830E-02	2.27070E-01
8.74470E+02	1.67190E-01	4.47720E-01	7.48530E-02	1.83190E-01
8.73630E+02	1.35840E-01	4.47130E-01	6.07380E-02	1.48650E-01
8.72570E+02	1.07630E-01	4.45880E-01	4.79890E-02	1.17450E-01
8.71310E+02	8.35950E-02	4.43900E-01	3.71080E-02	9.08150E-02
8.70260E+02	6.68760E-02	4.42230E-01	2.95750E-02	7.23790E-02
8.69010E+02	5.12020E-02	4.40200E-01	2.25390E-02	5.51610E-02
8.67120E+02	3.55280E-02	4.37080E-01	1.55280E-02	3.80030E-02
8.65650E+02	2.50780E-02	4.34700E-01	1.09020E-02	2.66800E-02
8.64190E+02	1.98540E-02	4.32230E-01	8.58130E-03	2.10010E-02
8.62930E+02	1.67190E-02	4.28980E-01	7.17200E-03	1.75520E-02
8.61470E+02	1.25390E-02	4.23500E-01	5.31030E-03	1.29960E-02
8.59370E+02	1.04490E-02	4.15650E-01	4.34330E-03	1.06300E-02
8.57490E+02	8.35950E-03	4.11440E-01	3.43940E-03	8.41750E-03
8.54560E+02	7.31450E-03	4.07660E-01	2.98180E-03	7.29760E-03
8.51000E+02	4.17970E-03	4.03740E-01	1.68750E-03	4.12990E-03
8.48000E+02	0.00000E+00	4.01530E-01	0.00000E+00	0.00000E+00

Channel 9

Wave Number	HIRS Filter Transmittance	Optical Element Transmittance	Product of the HIRS Filter and Optical Element Transmittances	Normalized Value of Col. 4
1.06600E+03	0.00000E+00	4.46840E-01	0.00000E+00	0.00000E+00
1.06560E+03	3.01220E-03	4.47100E-01	1.34680E-03	3.76820E-03
1.06220E+03	5.07470E-03	4.49100E-01	2.27910E-03	6.37670E-03
1.06030E+03	8.19640E-03	4.49930E-01	3.68780E-03	1.03180E-02
1.05890E+03	1.23680E-02	4.50390E-01	5.57060E-03	1.55860E-02
1.05730E+03	1.75840E-02	4.50980E-01	7.93030E-03	2.21890E-02
1.05580E+03	2.38470E-02	4.51540E-01	1.07680E-02	3.01280E-02
1.05430E+03	3.32480E-02	4.52080E-01	1.50310E-02	4.20560E-02
1.05350E+03	3.95180E-02	4.52350E-01	1.78760E-02	5.00160E-02
1.05260E+03	4.99710E-02	4.52640E-01	2.26190E-02	6.32860E-02
1.05200E+03	6.04250E-02	4.52850E-01	2.73640E-02	7.65630E-02
1.05160E+03	7.40200E-02	4.52980E-01	3.35300E-02	9.38150E-02
1.05100E+03	9.49350E-02	4.53190E-01	4.30240E-02	1.20380E-01
1.05020E+03	1.17940E-01	4.53350E-01	5.34680E-02	1.49600E-01
1.04950E+03	1.50360E-01	4.53450E-01	6.81810E-02	1.90770E-01
1.04860E+03	1.95330E-01	4.53390E-01	8.85620E-02	2.47790E-01

1.04760E+03	2.43440E-01	4.53350E-01	1.10360E-01	3.08800E-01
1.04670E+03	2.93640E-01	4.53320E-01	1.33120E-01	3.72450E-01
1.04440E+03	4.71450E-01	4.53260E-01	2.13690E-01	5.97890E-01
1.04340E+03	5.60350E-01	4.53250E-01	2.53980E-01	7.10620E-01
1.04220E+03	6.34610E-01	4.53240E-01	2.87630E-01	8.04770E-01
1.04120E+03	6.91080E-01	4.53220E-01	3.13210E-01	8.76350E-01
1.04020E+03	7.25590E-01	4.53120E-01	3.28780E-01	9.19910E-01
1.03960E+03	7.44420E-01	4.53130E-01	3.37320E-01	9.43800E-01
1.03870E+03	7.60100E-01	4.53140E-01	3.44430E-01	9.63700E-01
1.03770E+03	7.70550E-01	4.53140E-01	3.49170E-01	9.76960E-01
1.03670E+03	7.77860E-01	4.53150E-01	3.52490E-01	9.86240E-01
1.03560E+03	7.83080E-01	4.53310E-01	3.54980E-01	9.93230E-01
1.03460E+03	7.86210E-01	4.53550E-01	3.56590E-01	9.97720E-01
1.03270E+03	7.87240E-01	4.53990E-01	3.57400E-01	1.00000E+00
1.03130E+03	7.87230E-01	4.53130E-01	3.56720E-01	9.98070E-01
1.02970E+03	7.89310E-01	4.51390E-01	3.56290E-01	9.96870E-01
1.02850E+03	7.91390E-01	4.50160E-01	3.56250E-01	9.96780E-01
1.02730E+03	7.91380E-01	4.50100E-01	3.56200E-01	9.96630E-01
1.02630E+03	7.87190E-01	4.50250E-01	3.54430E-01	9.91690E-01
1.02550E+03	7.79860E-01	4.50370E-01	3.51230E-01	9.82720E-01
1.02490E+03	7.70440E-01	4.50470E-01	3.47060E-01	9.71060E-01
1.02450E+03	7.61020E-01	4.50530E-01	3.42860E-01	9.59310E-01
1.02410E+03	7.45330E-01	4.50590E-01	3.35830E-01	9.39650E-01
1.02350E+03	7.22310E-01	4.50680E-01	3.25530E-01	9.10830E-01
1.02300E+03	6.91970E-01	4.50760E-01	3.11910E-01	8.72720E-01
1.02240E+03	6.53260E-01	4.50860E-01	2.94530E-01	8.24080E-01
1.02110E+03	5.61200E-01	4.51370E-01	2.53310E-01	7.08740E-01
1.02000E+03	4.50310E-01	4.52370E-01	2.03710E-01	5.69970E-01
1.01860E+03	3.38380E-01	4.53610E-01	1.53490E-01	4.29470E-01
1.01740E+03	2.46320E-01	4.54750E-01	1.12010E-01	3.13410E-01
1.01670E+03	2.04470E-01	4.55320E-01	9.30980E-02	2.60480E-01
1.01590E+03	1.56340E-01	4.56110E-01	7.13110E-02	1.99520E-01
1.01510E+03	1.22860E-01	4.56800E-01	5.61250E-02	1.57040E-01
1.01410E+03	9.56600E-02	4.57710E-01	4.37840E-02	1.22510E-01
1.01340E+03	7.36870E-02	4.58390E-01	3.37770E-02	9.45080E-02
1.01230E+03	5.58950E-02	4.59300E-01	2.56730E-02	7.18310E-02
1.01150E+03	4.33360E-02	4.60080E-01	1.99380E-02	5.57850E-02
1.01010E+03	3.07710E-02	4.61280E-01	1.41940E-02	3.97140E-02
1.00890E+03	2.23930E-02	4.60760E-01	1.03180E-02	2.88690E-02
1.00730E+03	1.50570E-02	4.59960E-01	6.92560E-03	1.93770E-02
1.00570E+03	8.76650E-03	4.59180E-01	4.02540E-03	1.12630E-02
1.00470E+03	6.66570E-03	4.58660E-01	3.05730E-03	8.55410E-03
1.00290E+03	5.60430E-03	4.58240E-01	2.56810E-03	7.18550E-03

1.00130E+03	3.49800E-03	4.60090E-01	1.60940E-03	4.50310E-03
1.00000E+03	0.00000E+00	4.61610E-01	0.00000E+00	0.00000E+00
Channel 10				
Wave Number	HIRS Filter Transmittance	Optical Element Transmittance	Product of the HIRS Filter and Optical Element Transmittances	Normalized Value of Col. 4
8.19000E+02	0.00000E+00	3.98750E-01	0.00000E+00	0.00000E+00
8.18120E+02	1.14940E-02	3.98560E-01	4.58120E-03	1.59300E-02
8.17800E+02	1.25390E-02	3.98490E-01	4.99670E-03	1.73750E-02
8.17490E+02	1.77640E-02	3.98410E-01	7.07730E-03	2.46100E-02
8.17120E+02	2.40330E-02	3.98010E-01	9.56560E-03	3.32620E-02
8.16490E+02	2.92580E-02	3.96690E-01	1.16060E-02	4.03580E-02
8.15810E+02	3.44830E-02	3.95130E-01	1.36250E-02	4.73780E-02
8.15190E+02	4.17970E-02	3.93630E-01	1.64530E-02	5.72110E-02
8.14720E+02	5.32910E-02	3.92520E-01	2.09180E-02	7.27370E-02
8.14350E+02	6.47860E-02	3.91680E-01	2.53750E-02	8.82370E-02
8.13930E+02	7.94150E-02	3.91030E-01	3.10530E-02	1.07980E-01
8.13510E+02	9.71790E-02	3.90370E-01	3.79350E-02	1.31910E-01
8.13150E+02	1.20170E-01	3.89790E-01	4.68400E-02	1.62880E-01
8.12780E+02	1.49420E-01	3.89220E-01	5.81590E-02	2.02230E-01
8.12000E+02	2.40330E-01	3.87990E-01	9.32480E-02	3.24250E-01
8.11170E+02	3.49010E-01	3.86690E-01	1.34960E-01	4.69280E-01
8.10700E+02	3.94980E-01	3.85960E-01	1.52450E-01	5.30100E-01
8.10180E+02	4.66040E-01	3.85140E-01	1.79490E-01	6.24140E-01
8.09400E+02	5.44410E-01	3.83930E-01	2.09010E-01	7.26800E-01
8.08770E+02	5.93520E-01	3.82950E-01	2.27290E-01	7.90350E-01
8.08360E+02	6.19640E-01	3.82310E-01	2.36890E-01	8.23740E-01
8.07940E+02	6.40540E-01	3.81670E-01	2.44480E-01	8.50120E-01
8.07210E+02	6.67710E-01	3.80600E-01	2.54130E-01	8.83680E-01
8.06630E+02	6.84430E-01	3.79760E-01	2.59920E-01	9.03800E-01
8.06220E+02	6.96970E-01	3.79140E-01	2.64250E-01	9.18870E-01
8.05800E+02	7.07420E-01	3.78530E-01	2.67780E-01	9.31140E-01
8.05530E+02	7.16820E-01	3.78150E-01	2.71060E-01	9.42560E-01
8.05170E+02	7.33540E-01	3.77610E-01	2.76990E-01	9.63180E-01
8.04650E+02	7.49220E-01	3.76840E-01	2.82340E-01	9.81760E-01
8.04280E+02	7.60710E-01	3.76280E-01	2.86240E-01	9.95320E-01
8.04070E+02	7.63850E-01	3.75950E-01	2.87170E-01	9.98560E-01
8.03760E+02	7.65940E-01	3.75470E-01	2.87580E-01	1.00000E+00
8.03500E+02	7.62800E-01	3.75180E-01	2.86180E-01	9.95140E-01
8.03180E+02	7.56530E-01	3.74840E-01	2.83580E-01	9.86080E-01
8.02710E+02	7.42950E-01	3.74340E-01	2.78120E-01	9.67080E-01
8.02080E+02	7.27270E-01	3.73670E-01	2.71760E-01	9.44980E-01

8.01450E+02	7.09510E-01	3.72990E-01	2.64640E-01	9.20220E-01
8.01080E+02	6.95920E-01	3.72590E-01	2.59300E-01	9.01640E-01
8.00610E+02	6.78160E-01	3.72080E-01	2.52330E-01	8.77420E-01
8.00300E+02	6.62490E-01	3.71740E-01	2.46280E-01	8.56370E-01
7.99930E+02	6.48900E-01	3.71350E-01	2.40970E-01	8.37910E-01
7.99560E+02	6.39500E-01	3.70950E-01	2.37220E-01	8.24890E-01
7.99140E+02	6.28000E-01	3.70490E-01	2.32670E-01	8.09060E-01
7.98670E+02	6.11280E-01	3.69950E-01	2.26140E-01	7.86360E-01
7.98200E+02	5.88300E-01	3.69400E-01	2.17320E-01	7.55660E-01
7.97830E+02	5.68440E-01	3.68970E-01	2.09740E-01	7.29320E-01
7.97520E+02	5.47540E-01	3.68610E-01	2.01830E-01	7.01820E-01
7.97200E+02	5.22470E-01	3.68250E-01	1.92400E-01	6.69010E-01
7.96880E+02	4.90070E-01	3.67880E-01	1.80290E-01	6.26910E-01
7.96520E+02	4.51410E-01	3.67460E-01	1.65870E-01	5.76790E-01
7.95620E+02	3.45870E-01	3.66430E-01	1.26740E-01	4.40700E-01
7.95040E+02	2.68550E-01	3.65760E-01	9.82250E-02	3.41550E-01
7.94570E+02	2.11080E-01	3.65220E-01	7.70890E-02	2.68060E-01
7.94040E+02	1.61960E-01	3.64650E-01	5.90600E-02	2.05370E-01
7.93930E+02	1.41070E-01	3.64560E-01	5.14270E-02	1.78830E-01
7.93670E+02	1.25390E-01	3.64330E-01	4.56850E-02	1.58860E-01
7.93460E+02	1.11810E-01	3.64150E-01	4.07150E-02	1.41580E-01
7.93200E+02	9.71790E-02	3.63930E-01	3.53660E-02	1.22980E-01
7.92990E+02	8.25500E-02	3.63750E-01	3.00270E-02	1.04410E-01
7.92620E+02	7.10550E-02	3.63430E-01	2.58240E-02	8.97970E-02
7.92360E+02	6.06060E-02	3.63210E-01	2.20130E-02	7.65440E-02
7.92100E+02	5.12020E-02	3.62980E-01	1.85850E-02	6.46260E-02
7.91730E+02	4.28420E-02	3.62670E-01	1.55380E-02	5.40280E-02
7.91360E+02	3.55280E-02	3.62200E-01	1.28680E-02	4.47450E-02
7.91000E+02	3.13480E-02	3.61690E-01	1.13380E-02	3.94260E-02
7.90580E+02	2.71680E-02	3.61110E-01	9.81070E-03	3.41140E-02
7.90050E+02	2.40330E-02	3.60390E-01	8.66140E-03	3.01180E-02
7.89640E+02	2.08990E-02	3.59820E-01	7.51970E-03	2.61480E-02
7.89220E+02	1.88090E-02	3.59250E-01	6.75710E-03	2.34960E-02
7.88850E+02	1.56740E-02	3.58630E-01	5.62120E-03	1.95460E-02
7.88690E+02	1.14940E-02	3.58370E-01	4.11920E-03	1.43240E-02
7.88000E+02	0.00000E+00	3.57200E-01	0.00000E+00	0.00000E+00

Channel 11

Wave Number	HIRS Filter Transmittance	Optical Element Transmittance	Product of the HIRS Filter and Optical Element Transmittances	Normalized Value of Col. 4
1.41000E+03	0.00000E+00	1.81590E-01	0.00000E+00	0.00000E+00
1.40710E+03	6.28270E-03	1.85050E-01	1.16260E-03	7.26160E-03

1.40480E+03	8.37700E-03	1.87660E-01	1.57200E-03	9.81880E-03
1.40290E+03	1.15180E-02	1.90850E-01	2.19820E-03	1.37300E-02
1.40050E+03	1.36130E-02	1.94450E-01	2.64700E-03	1.65330E-02
1.39840E+03	1.57070E-02	1.96520E-01	3.08680E-03	1.92800E-02
1.39590E+03	1.88480E-02	1.98990E-01	3.75060E-03	2.34260E-02
1.39390E+03	2.09420E-02	2.00810E-01	4.20540E-03	2.62670E-02
1.39240E+03	2.72250E-02	2.01750E-01	5.49270E-03	3.43070E-02
1.39130E+03	3.45550E-02	2.02510E-01	6.99770E-03	4.37070E-02
1.38990E+03	4.50260E-02	2.03640E-01	9.16930E-03	5.72710E-02
1.38890E+03	5.75920E-02	2.04460E-01	1.17750E-02	7.35480E-02
1.38800E+03	7.53930E-02	2.05190E-01	1.54690E-02	9.66210E-02
1.38720E+03	9.52880E-02	2.05800E-01	1.96110E-02	1.22490E-01
1.38620E+03	1.37170E-01	2.06640E-01	2.83450E-02	1.77040E-01
1.38570E+03	1.60210E-01	2.07050E-01	3.31710E-02	2.07190E-01
1.38450E+03	2.15710E-01	2.08090E-01	4.48860E-02	2.80350E-01
1.38270E+03	3.43460E-01	2.09090E-01	7.18130E-02	4.48540E-01
1.38180E+03	3.89530E-01	2.09440E-01	8.15840E-02	5.09570E-01
1.38080E+03	4.43980E-01	2.09850E-01	9.31710E-02	5.81940E-01
1.38010E+03	4.98430E-01	2.10170E-01	1.04750E-01	6.54280E-01
1.37910E+03	5.32980E-01	2.10580E-01	1.12230E-01	7.01010E-01
1.37830E+03	5.53930E-01	2.10880E-01	1.16810E-01	7.29620E-01
1.37770E+03	5.66490E-01	2.11140E-01	1.19610E-01	7.47080E-01
1.37670E+03	5.83250E-01	2.11550E-01	1.23390E-01	7.70670E-01
1.37570E+03	5.96860E-01	2.11780E-01	1.26400E-01	7.89510E-01
1.37490E+03	6.09420E-01	2.11710E-01	1.29020E-01	8.05840E-01
1.37380E+03	6.31410E-01	2.11600E-01	1.33610E-01	8.34500E-01
1.37270E+03	6.56540E-01	2.11490E-01	1.38860E-01	8.67280E-01
1.37190E+03	6.76440E-01	2.11520E-01	1.43080E-01	8.93660E-01
1.37090E+03	6.95290E-01	2.11910E-01	1.47340E-01	9.20260E-01
1.37030E+03	7.11000E-01	2.12200E-01	1.50870E-01	9.42340E-01
1.36920E+03	7.27750E-01	2.12730E-01	1.54820E-01	9.66970E-01
1.36820E+03	7.38220E-01	2.13200E-01	1.57390E-01	9.83060E-01
1.36730E+03	7.46600E-01	2.13620E-01	1.59490E-01	9.96150E-01
1.36610E+03	7.47640E-01	2.14140E-01	1.60100E-01	1.00000E+00
1.36540E+03	7.45550E-01	2.14450E-01	1.59880E-01	9.98610E-01
1.36450E+03	7.39270E-01	2.14790E-01	1.58790E-01	9.91790E-01
1.36400E+03	7.29840E-01	2.14990E-01	1.56910E-01	9.80040E-01
1.36340E+03	7.18330E-01	2.15240E-01	1.54610E-01	9.65680E-01
1.36290E+03	7.04710E-01	2.15430E-01	1.51820E-01	9.48240E-01
1.36240E+03	6.91100E-01	2.15550E-01	1.48960E-01	9.30420E-01
1.36190E+03	6.75390E-01	2.15040E-01	1.45240E-01	9.07150E-01
1.36150E+03	6.61780E-01	2.14630E-01	1.42040E-01	8.87180E-01
1.36100E+03	6.45030E-01	2.14070E-01	1.38080E-01	8.62450E-01

1.36050E+03	6.26180E-01	2.13520E-01	1.33700E-01	8.35080E-01
1.35970E+03	5.94760E-01	2.13720E-01	1.27110E-01	7.93930E-01
1.35860E+03	5.54970E-01	2.14050E-01	1.18790E-01	7.41980E-01
1.35820E+03	5.35080E-01	2.14170E-01	1.14600E-01	7.15760E-01
1.35750E+03	5.13090E-01	2.14390E-01	1.10000E-01	6.87070E-01
1.35700E+03	4.98430E-01	2.14540E-01	1.06930E-01	6.67900E-01
1.35640E+03	4.84820E-01	2.14750E-01	1.04110E-01	6.50290E-01
1.35590E+03	4.75390E-01	2.14950E-01	1.02180E-01	6.38230E-01
1.35540E+03	4.69110E-01	2.15140E-01	1.00920E-01	6.30370E-01
1.35470E+03	4.68060E-01	2.15390E-01	1.00810E-01	6.29680E-01
1.35410E+03	4.70160E-01	2.15630E-01	1.01380E-01	6.33220E-01
1.35370E+03	4.76440E-01	2.15780E-01	1.02810E-01	6.42120E-01
1.35310E+03	4.86910E-01	2.16020E-01	1.05180E-01	6.56970E-01
1.35270E+03	4.97380E-01	2.16170E-01	1.07520E-01	6.71550E-01
1.35170E+03	5.27750E-01	2.16560E-01	1.14290E-01	7.13830E-01
1.35100E+03	5.47640E-01	2.16850E-01	1.18760E-01	7.41750E-01
1.35050E+03	5.61260E-01	2.17040E-01	1.21820E-01	7.60860E-01
1.35010E+03	5.67540E-01	2.17190E-01	1.23260E-01	7.69890E-01
1.34920E+03	5.67540E-01	2.17520E-01	1.23450E-01	7.71070E-01
1.34890E+03	5.59160E-01	2.17620E-01	1.21680E-01	7.60030E-01
1.34840E+03	5.44500E-01	2.17810E-01	1.18600E-01	7.40760E-01
1.34790E+03	5.24610E-01	2.18010E-01	1.14370E-01	7.14330E-01
1.34740E+03	4.91100E-01	2.18460E-01	1.07290E-01	6.70100E-01
1.34680E+03	4.51310E-01	2.19060E-01	9.88650E-02	6.17500E-01
1.34620E+03	3.98950E-01	2.19690E-01	8.76440E-02	5.47420E-01
1.34570E+03	3.40310E-01	2.20180E-01	7.49310E-02	4.68020E-01
1.34490E+03	2.92150E-01	2.20930E-01	6.45440E-02	4.03140E-01
1.34390E+03	2.16750E-01	2.21920E-01	4.81030E-02	3.00450E-01
1.34340E+03	1.85340E-01	2.22420E-01	4.12230E-02	2.57480E-01
1.34260E+03	1.43450E-01	2.23290E-01	3.20320E-02	2.00070E-01
1.34220E+03	1.21470E-01	2.23660E-01	2.71670E-02	1.69680E-01
1.34160E+03	1.09950E-01	2.24280E-01	2.46600E-02	1.54020E-01
1.34090E+03	9.52880E-02	2.24910E-01	2.14310E-02	1.33860E-01
1.34040E+03	8.37700E-02	2.25410E-01	1.88830E-02	1.17940E-01
1.33970E+03	7.22510E-02	2.26160E-01	1.63400E-02	1.02060E-01
1.33880E+03	6.28270E-02	2.27040E-01	1.42650E-02	8.90950E-02
1.33750E+03	5.54970E-02	2.28290E-01	1.26690E-02	7.91330E-02
1.33630E+03	4.60730E-02	2.29500E-01	1.05740E-02	6.60440E-02
1.33490E+03	4.08380E-02	2.30750E-01	9.42330E-03	5.88570E-02
1.33390E+03	3.24610E-02	2.31660E-01	7.51970E-03	4.69680E-02
1.33250E+03	2.61780E-02	2.32890E-01	6.09670E-03	3.80790E-02
1.33090E+03	1.78010E-02	2.34320E-01	4.17110E-03	2.60530E-02
1.33000E+03	1.25650E-02	2.35080E-01	2.95390E-03	1.84500E-02

1.32890E+03	1.04710E-02	2.36060E-01	2.47180E-03	1.54390E-02
1.32710E+03	8.37700E-03	2.37960E-01	1.99340E-03	1.24500E-02
1.32550E+03	5.23560E-03	2.39770E-01	1.25530E-03	7.84070E-03
1.32340E+03	3.14140E-03	2.42200E-01	7.60820E-04	4.75200E-03
1.32200E+03	0.00000E+00	2.43750E-01	0.00000E+00	0.00000E+00
Channel 12				
Wave Number	HIRS Filter Transmittance	Optical Element Transmittance	Product of the HIRS Filter and Optical Element Transmittances	Normalized Value of Col. 4
1.58200E+03	0.00000E+00	5.01120E-02	0.00000E+00	0.00000E+00
1.58180E+03	4.19290E-03	5.03360E-02	2.11050E-04	2.43570E-03
1.58060E+03	5.24110E-03	5.14480E-02	2.69640E-04	3.11180E-03
1.57770E+03	5.24110E-03	5.40270E-02	2.83160E-04	3.26780E-03
1.57340E+03	6.28930E-03	5.87360E-02	3.69410E-04	4.26320E-03
1.57110E+03	6.28930E-03	6.16760E-02	3.87900E-04	4.47660E-03
1.56940E+03	9.43400E-03	6.34980E-02	5.99030E-04	6.91320E-03
1.56770E+03	1.25790E-02	6.56310E-02	8.25550E-04	9.52730E-03
1.56620E+03	1.57230E-02	6.73840E-02	1.05950E-03	1.22270E-02
1.56520E+03	2.09640E-02	6.85010E-02	1.43610E-03	1.65730E-02
1.56450E+03	2.83020E-02	6.92590E-02	1.96020E-03	2.26210E-02
1.56370E+03	3.66880E-02	7.02450E-02	2.57710E-03	2.97410E-02
1.56290E+03	5.13630E-02	7.12390E-02	3.65900E-03	4.22270E-02
1.56220E+03	6.49890E-02	7.20500E-02	4.68250E-03	5.40380E-02
1.56080E+03	7.33750E-02	7.37560E-02	5.41180E-03	6.24550E-02
1.55900E+03	9.43400E-02	7.62920E-02	7.19730E-03	8.30610E-02
1.55850E+03	1.16350E-01	7.70050E-02	8.95970E-03	1.03400E-01
1.55770E+03	2.10690E-01	7.80890E-02	1.64530E-02	1.89870E-01
1.55680E+03	2.44230E-01	7.92180E-02	1.93480E-02	2.23280E-01
1.55580E+03	2.97690E-01	8.09400E-02	2.40950E-02	2.78070E-01
1.55530E+03	3.24950E-01	8.18310E-02	2.65910E-02	3.06870E-01
1.55460E+03	3.85740E-01	8.26820E-02	3.18940E-02	3.68080E-01
1.55380E+03	4.66460E-01	8.34340E-02	3.89180E-02	4.49140E-01
1.55210E+03	5.02100E-01	8.49400E-02	4.26480E-02	4.92180E-01
1.55080E+03	5.42980E-01	8.61140E-02	4.67580E-02	5.39610E-01
1.54980E+03	5.75470E-01	8.72490E-02	5.02090E-02	5.79440E-01
1.54890E+03	5.97480E-01	8.83190E-02	5.27690E-02	6.08990E-01
1.54790E+03	6.20550E-01	8.97660E-02	5.57040E-02	6.42850E-01
1.54680E+03	6.35220E-01	9.12910E-02	5.79900E-02	6.69230E-01
1.54560E+03	6.45700E-01	9.23950E-02	5.96600E-02	6.88510E-01
1.54460E+03	6.54090E-01	9.32060E-02	6.09650E-02	7.03570E-01
1.54360E+03	6.58280E-01	9.40140E-02	6.18880E-02	7.14220E-01
1.54230E+03	6.50940E-01	9.50010E-02	6.18400E-02	7.13670E-01

1.54090E+03	6.46750E-01	9.59030E-02	6.20250E-02	7.15810E-01
1.53960E+03	6.47800E-01	9.68120E-02	6.27150E-02	7.23760E-01
1.53810E+03	6.42560E-01	9.77080E-02	6.27830E-02	7.24550E-01
1.53670E+03	6.46750E-01	9.84870E-02	6.36960E-02	7.35090E-01
1.53570E+03	6.56180E-01	9.91690E-02	6.50730E-02	7.50980E-01
1.53510E+03	6.71910E-01	9.96260E-02	6.69390E-02	7.72520E-01
1.53370E+03	6.80290E-01	1.00550E-01	6.84030E-02	7.89410E-01
1.53270E+03	6.94970E-01	1.01240E-01	7.03610E-02	8.12000E-01
1.53160E+03	7.04400E-01	1.02070E-01	7.18970E-02	8.29730E-01
1.53050E+03	7.07550E-01	1.02780E-01	7.27250E-02	8.39280E-01
1.52900E+03	7.04400E-01	1.03820E-01	7.31280E-02	8.43930E-01
1.52800E+03	6.97060E-01	1.04400E-01	7.27740E-02	8.39850E-01
1.52740E+03	6.90780E-01	1.04700E-01	7.23220E-02	8.34630E-01
1.52600E+03	6.78200E-01	1.05310E-01	7.14180E-02	8.24200E-01
1.52540E+03	6.63520E-01	1.05630E-01	7.00870E-02	8.08840E-01
1.52440E+03	6.49900E-01	1.06120E-01	6.89650E-02	7.95890E-01
1.52340E+03	6.37320E-01	1.06590E-01	6.79290E-02	7.83930E-01
1.52180E+03	6.31030E-01	1.07260E-01	6.76820E-02	7.81080E-01
1.52080E+03	6.20550E-01	1.07700E-01	6.68330E-02	7.71290E-01
1.51970E+03	6.14260E-01	1.08420E-01	6.66000E-02	7.68600E-01
1.51830E+03	6.17400E-01	1.09370E-01	6.75220E-02	7.79240E-01
1.51680E+03	6.23690E-01	1.10400E-01	6.88530E-02	7.94600E-01
1.51650E+03	6.33120E-01	1.10620E-01	7.00370E-02	8.08260E-01
1.51500E+03	6.49900E-01	1.11660E-01	7.25650E-02	8.37430E-01
1.51400E+03	6.69810E-01	1.12350E-01	7.52550E-02	8.68480E-01
1.51300E+03	6.98110E-01	1.13050E-01	7.89190E-02	9.10760E-01
1.51200E+03	7.22220E-01	1.13740E-01	8.21470E-02	9.48020E-01
1.51110E+03	7.38990E-01	1.14330E-01	8.44890E-02	9.75050E-01
1.51030E+03	7.48430E-01	1.14920E-01	8.60060E-02	9.92560E-01
1.50910E+03	7.47380E-01	1.15940E-01	8.66510E-02	1.00000E+00
1.50810E+03	7.41090E-01	1.16890E-01	8.66290E-02	9.99740E-01
1.50760E+03	7.30610E-01	1.17370E-01	8.57540E-02	9.89640E-01
1.50710E+03	7.11740E-01	1.17860E-01	8.38880E-02	9.68110E-01
1.50660E+03	6.85530E-01	1.18340E-01	8.11290E-02	9.36280E-01
1.50630E+03	6.45700E-01	1.18660E-01	7.66210E-02	8.84250E-01
1.50590E+03	5.92240E-01	1.18990E-01	7.04720E-02	8.13290E-01
1.50540E+03	5.38780E-01	1.19480E-01	6.43720E-02	7.42880E-01
1.50440E+03	4.94760E-01	1.20350E-01	5.95420E-02	6.87150E-01
1.50390E+03	4.30820E-01	1.20770E-01	5.20290E-02	6.00440E-01
1.50290E+03	3.53250E-01	1.21600E-01	4.29540E-02	4.95710E-01
1.50230E+03	2.83020E-01	1.22150E-01	3.45720E-02	3.98980E-01
1.50140E+03	2.04400E-01	1.22850E-01	2.51120E-02	2.89800E-01
1.50060E+03	1.55140E-01	1.23550E-01	1.91670E-02	2.21200E-01

1.49970E+03	1.21590E-01	1.24260E-01	1.51090E-02	1.74370E-01
1.49820E+03	8.90980E-02	1.25520E-01	1.11840E-02	1.29060E-01
1.49720E+03	6.18450E-02	1.26180E-01	7.80360E-03	9.00580E-02
1.49590E+03	3.45910E-02	1.27430E-01	4.40780E-03	5.08690E-02
1.49460E+03	1.78200E-02	1.29150E-01	2.30150E-03	2.65600E-02
1.49320E+03	1.36270E-02	1.30800E-01	1.78240E-03	2.05700E-02
1.49190E+03	1.04820E-02	1.32220E-01	1.38600E-03	1.59950E-02
1.49040E+03	8.38570E-03	1.33830E-01	1.12220E-03	1.29510E-02
1.48700E+03	8.38570E-03	1.37310E-01	1.15150E-03	1.32890E-02
1.48420E+03	7.33750E-03	1.39810E-01	1.02580E-03	1.18390E-02
1.48070E+03	6.28930E-03	1.42090E-01	8.93640E-04	1.03130E-02
1.48000E+03	0.00000E+00	1.42520E-01	0.00000E+00	0.00000E+00

Channel 13

Wave Number	HIRS Filter Transmittance	Optical Element Transmittance	Product of the HIRS Filter and Optical Element Transmittances	Normalized Value of Col. 4
2.21700E+03	0.00000E+00	4.43440E-01	0.00000E+00	0.00000E+00
2.21270E+03	1.04490E-02	4.39650E-01	4.59410E-03	2.08940E-02
2.21160E+03	1.14940E-02	4.38690E-01	5.04250E-03	2.29340E-02
2.21090E+03	1.67190E-02	4.38030E-01	7.32340E-03	3.33080E-02
2.21040E+03	1.98540E-02	4.37440E-01	8.68480E-03	3.94990E-02
2.20970E+03	1.98540E-02	4.36570E-01	8.66760E-03	3.94210E-02
2.20910E+03	2.29880E-02	4.35980E-01	1.00230E-02	4.55830E-02
2.20840E+03	3.03030E-02	4.35130E-01	1.31860E-02	5.99700E-02
2.20800E+03	3.76180E-02	4.34660E-01	1.63510E-02	7.43660E-02
2.20750E+03	4.07520E-02	4.34160E-01	1.76930E-02	8.04690E-02
2.20650E+03	4.70220E-02	4.33200E-01	2.03700E-02	9.26450E-02
2.20590E+03	5.64260E-02	4.32650E-01	2.44130E-02	1.11030E-01
2.20530E+03	6.89650E-02	4.32100E-01	2.98000E-02	1.35530E-01
2.20450E+03	7.83700E-02	4.31490E-01	3.38160E-02	1.53800E-01
2.20390E+03	8.88190E-02	4.31050E-01	3.82860E-02	1.74130E-01
2.20310E+03	1.07630E-01	4.30450E-01	4.63290E-02	2.10710E-01
2.20190E+03	1.36890E-01	4.29530E-01	5.87970E-02	2.67420E-01
2.19970E+03	1.99580E-01	4.27730E-01	8.53660E-02	3.88260E-01
2.19760E+03	2.62280E-01	4.26690E-01	1.11910E-01	5.08980E-01
2.19590E+03	3.07210E-01	4.25770E-01	1.30800E-01	5.94900E-01
2.19500E+03	3.27060E-01	4.25670E-01	1.39220E-01	6.33200E-01
2.19440E+03	3.37510E-01	4.25600E-01	1.43650E-01	6.53320E-01
2.19370E+03	3.46920E-01	4.25340E-01	1.47560E-01	6.71100E-01
2.19300E+03	3.52140E-01	4.24950E-01	1.49640E-01	6.80590E-01
2.19240E+03	3.56320E-01	4.24560E-01	1.51280E-01	6.88040E-01
2.19150E+03	3.57370E-01	4.24070E-01	1.51550E-01	6.89250E-01

2.19060E+03	3.55280E-01	4.23790E-01	1.50560E-01	6.84770E-01
2.19000E+03	3.51100E-01	4.23590E-01	1.48720E-01	6.76400E-01
2.18910E+03	3.50050E-01	4.23480E-01	1.48240E-01	6.74210E-01
2.18810E+03	3.50050E-01	4.23340E-01	1.48190E-01	6.73990E-01
2.18770E+03	3.47960E-01	4.23260E-01	1.47280E-01	6.69840E-01
2.18690E+03	3.45870E-01	4.23080E-01	1.46330E-01	6.65540E-01
2.18640E+03	3.49010E-01	4.22930E-01	1.47610E-01	6.71330E-01
2.18570E+03	3.55280E-01	4.22600E-01	1.50140E-01	6.82850E-01
2.18500E+03	3.68860E-01	4.22220E-01	1.55740E-01	7.08320E-01
2.18410E+03	3.99160E-01	4.21810E-01	1.68370E-01	7.65760E-01
2.18310E+03	4.27380E-01	4.21470E-01	1.80130E-01	8.19240E-01
2.18240E+03	4.58720E-01	4.21320E-01	1.93270E-01	8.79020E-01
2.18190E+03	4.76490E-01	4.21220E-01	2.00710E-01	9.12840E-01
2.18140E+03	4.92160E-01	4.21130E-01	2.07270E-01	9.42670E-01
2.18110E+03	5.02610E-01	4.21060E-01	2.11630E-01	9.62510E-01
2.18060E+03	5.13060E-01	4.20970E-01	2.15980E-01	9.82320E-01
2.18030E+03	5.19330E-01	4.20910E-01	2.18590E-01	9.94170E-01
2.17980E+03	5.22470E-01	4.20830E-01	2.19870E-01	1.00000E+00
2.17930E+03	5.20380E-01	4.20750E-01	2.18950E-01	9.95800E-01
2.17890E+03	5.13060E-01	4.20610E-01	2.15800E-01	9.81480E-01
2.17850E+03	5.03660E-01	4.20580E-01	2.11830E-01	9.63410E-01
2.17810E+03	4.90070E-01	4.20560E-01	2.06100E-01	9.37390E-01
2.17770E+03	4.72310E-01	4.20540E-01	1.98620E-01	9.03360E-01
2.17730E+03	4.49320E-01	4.20520E-01	1.88950E-01	8.59350E-01
2.17690E+03	4.22150E-01	4.20490E-01	1.77510E-01	8.07340E-01
2.17670E+03	4.04390E-01	4.20490E-01	1.70040E-01	7.73360E-01
2.17620E+03	3.72000E-01	4.20470E-01	1.56410E-01	7.11380E-01
2.17590E+03	3.37510E-01	4.20440E-01	1.41900E-01	6.45390E-01
2.17530E+03	2.84220E-01	4.20440E-01	1.19500E-01	5.43490E-01
2.17480E+03	2.39290E-01	4.20450E-01	1.00610E-01	4.57590E-01
2.17410E+03	1.94360E-01	4.20470E-01	8.17220E-02	3.71680E-01
2.17350E+03	1.50470E-01	4.20490E-01	6.32710E-02	2.87760E-01
2.17310E+03	1.20170E-01	4.20500E-01	5.05300E-02	2.29820E-01
2.17260E+03	9.71790E-02	4.20530E-01	4.08660E-02	1.85860E-01
2.17220E+03	8.15050E-02	4.20610E-01	3.42820E-02	1.55920E-01
2.17170E+03	6.79210E-02	4.20730E-01	2.85760E-02	1.29970E-01
2.17130E+03	5.64260E-02	4.20810E-01	2.37450E-02	1.07990E-01
2.17080E+03	4.49320E-02	4.20900E-01	1.89120E-02	8.60140E-02
2.17030E+03	3.55280E-02	4.20900E-01	1.49540E-02	6.80110E-02
2.16980E+03	3.03030E-02	4.20960E-01	1.27560E-02	5.80170E-02
2.16940E+03	2.50780E-02	4.21060E-01	1.05600E-02	4.80260E-02
2.16870E+03	1.88090E-02	4.21060E-01	7.91960E-03	3.60190E-02
2.16830E+03	1.56740E-02	4.21050E-01	6.59960E-03	3.00150E-02

2.16780E+03	1.46290E-02	4.21040E-01	6.15940E-03	2.80140E-02
2.16710E+03	1.35840E-02	4.20990E-01	5.71880E-03	2.60090E-02
2.16660E+03	1.14940E-02	4.20870E-01	4.83760E-03	2.20020E-02
2.16200E+03	0.00000E+00	4.19740E-01	0.00000E+00	0.00000E+00
Channel 14				
Wave Number	HIRS Filter Transmittance	Optical Element Transmittance	Product of the HIRS Filter and Optical Element Transmittances	Normalized Value of Col. 4
2.23370E+03	0.00000E+00	4.69250E-01	0.00000E+00	0.00000E+00
2.22770E+03	1.04710E-02	4.60410E-01	4.82100E-03	1.76990E-02
2.22710E+03	1.04710E-02	4.59460E-01	4.81110E-03	1.76620E-02
2.22640E+03	1.15180E-02	4.58140E-01	5.27690E-03	1.93730E-02
2.22580E+03	1.46600E-02	4.57030E-01	6.69990E-03	2.45960E-02
2.22520E+03	1.98950E-02	4.55940E-01	9.07110E-03	3.33020E-02
2.22450E+03	2.61780E-02	4.54470E-01	1.18970E-02	4.36760E-02
2.22390E+03	3.66490E-02	4.53380E-01	1.66160E-02	6.10010E-02
2.22310E+03	4.60730E-02	4.51780E-01	2.08150E-02	7.64150E-02
2.22240E+03	5.75920E-02	4.50650E-01	2.59540E-02	9.52800E-02
2.22180E+03	7.53930E-02	4.49740E-01	3.39070E-02	1.24480E-01
2.22100E+03	1.01570E-01	4.48670E-01	4.55720E-02	1.67300E-01
2.22030E+03	1.31940E-01	4.47590E-01	5.90540E-02	2.16800E-01
2.21940E+03	1.79060E-01	4.46460E-01	7.99420E-02	2.93480E-01
2.21860E+03	2.24080E-01	4.45340E-01	9.97940E-02	3.66360E-01
2.21770E+03	2.79580E-01	4.44220E-01	1.24190E-01	4.55940E-01
2.21690E+03	3.35080E-01	4.43330E-01	1.48550E-01	5.45360E-01
2.21580E+03	3.97910E-01	4.42460E-01	1.76060E-01	6.46330E-01
2.21510E+03	4.35600E-01	4.41760E-01	1.92430E-01	7.06450E-01
2.21460E+03	4.67020E-01	4.41310E-01	2.06100E-01	7.56630E-01
2.21390E+03	5.02620E-01	4.40640E-01	2.21470E-01	8.13070E-01
2.21310E+03	5.30890E-01	4.39970E-01	2.33580E-01	8.57500E-01
2.21250E+03	5.51830E-01	4.39470E-01	2.42510E-01	8.90310E-01
2.21210E+03	5.66490E-01	4.39080E-01	2.48730E-01	9.13150E-01
2.21180E+03	5.74870E-01	4.38810E-01	2.52260E-01	9.26090E-01
2.21150E+03	5.78010E-01	4.38540E-01	2.53480E-01	9.30580E-01
2.21080E+03	5.86390E-01	4.37950E-01	2.56810E-01	9.42790E-01
2.20980E+03	5.97910E-01	4.36770E-01	2.61150E-01	9.58720E-01
2.20900E+03	6.07330E-01	4.35830E-01	2.64690E-01	9.71730E-01
2.20840E+03	6.15710E-01	4.35090E-01	2.67890E-01	9.83470E-01
2.20790E+03	6.19890E-01	4.34560E-01	2.69380E-01	9.88950E-01
2.20720E+03	6.24080E-01	4.33880E-01	2.70780E-01	9.94070E-01
2.20660E+03	6.28270E-01	4.33320E-01	2.72240E-01	9.99460E-01
2.20610E+03	6.29320E-01	4.32840E-01	2.72390E-01	1.00000E+00

2.20570E+03	6.28270E-01	4.32480E-01	2.71710E-01	9.97510E-01
2.20530E+03	6.26180E-01	4.32120E-01	2.70590E-01	9.93370E-01
2.20490E+03	6.20940E-01	4.31800E-01	2.68120E-01	9.84330E-01
2.20440E+03	6.15710E-01	4.31430E-01	2.65630E-01	9.75180E-01
2.20390E+03	6.05240E-01	4.31050E-01	2.60880E-01	9.57750E-01
2.20310E+03	5.95810E-01	4.30480E-01	2.56490E-01	9.41610E-01
2.20260E+03	5.86390E-01	4.30110E-01	2.52210E-01	9.25910E-01
2.20200E+03	5.71730E-01	4.29610E-01	2.45620E-01	9.01700E-01
2.20120E+03	5.49740E-01	4.28870E-01	2.35770E-01	8.65540E-01
2.20070E+03	5.31940E-01	4.28420E-01	2.27890E-01	8.36640E-01
2.19990E+03	5.02620E-01	4.27830E-01	2.15040E-01	7.89430E-01
2.19920E+03	4.71200E-01	4.27490E-01	2.01440E-01	7.39500E-01
2.19850E+03	4.35600E-01	4.27210E-01	1.86090E-01	6.83180E-01
2.19790E+03	4.10470E-01	4.26880E-01	1.75220E-01	6.43260E-01
2.19730E+03	3.80100E-01	4.26510E-01	1.62120E-01	5.95170E-01
2.19680E+03	3.56020E-01	4.26210E-01	1.51740E-01	5.57070E-01
2.19620E+03	3.30890E-01	4.25890E-01	1.40920E-01	5.17350E-01
2.19580E+03	3.04710E-01	4.25760E-01	1.29730E-01	4.76270E-01
2.19530E+03	2.82720E-01	4.25700E-01	1.20360E-01	4.41840E-01
2.19480E+03	2.56540E-01	4.25650E-01	1.09200E-01	4.00890E-01
2.19410E+03	2.24080E-01	4.25530E-01	9.53540E-02	3.50060E-01
2.19350E+03	1.91620E-01	4.25230E-01	8.14830E-02	2.99140E-01
2.19300E+03	1.71730E-01	4.24930E-01	7.29720E-02	2.67890E-01
2.19260E+03	1.52880E-01	4.24670E-01	6.49230E-02	2.38340E-01
2.19210E+03	1.34030E-01	4.24380E-01	5.68800E-02	2.08810E-01
2.19160E+03	1.19370E-01	4.24100E-01	5.06260E-02	1.85860E-01
2.19120E+03	1.05760E-01	4.23990E-01	4.48410E-02	1.64620E-01
2.19090E+03	9.52880E-02	4.23890E-01	4.03910E-02	1.48280E-01
2.19060E+03	8.58640E-02	4.23790E-01	3.63880E-02	1.33590E-01
2.19010E+03	7.64400E-02	4.23600E-01	3.23800E-02	1.18870E-01
2.18970E+03	6.70160E-02	4.23550E-01	2.83850E-02	1.04210E-01
2.18940E+03	5.75920E-02	4.23510E-01	2.43900E-02	8.95410E-02
2.18900E+03	5.02620E-02	4.23460E-01	2.12840E-02	7.81360E-02
2.18860E+03	4.39790E-02	4.23410E-01	1.86210E-02	6.83610E-02
2.18820E+03	3.76960E-02	4.23350E-01	1.59590E-02	5.85870E-02
2.18750E+03	3.14140E-02	4.23230E-01	1.32950E-02	4.88090E-02
2.18690E+03	2.61780E-02	4.23070E-01	1.10750E-02	4.06590E-02
2.18650E+03	1.98950E-02	4.22960E-01	8.41490E-03	3.08930E-02
2.18600E+03	1.67540E-02	4.22750E-01	7.08260E-03	2.60020E-02
2.18550E+03	1.46600E-02	4.22460E-01	6.19310E-03	2.27360E-02
2.18420E+03	1.36130E-02	4.21850E-01	5.74250E-03	2.10820E-02
2.18390E+03	1.25650E-02	4.21760E-01	5.29960E-03	1.94560E-02
2.18380E+03	9.42410E-03	4.21710E-01	3.97430E-03	1.45900E-02

2.18000E+03	0.00000E+00	4.20870E-01	0.00000E+00	0.00000E+00
Channel 15				
Wave Number	HIRS Filter Transmittance	Optical Element Transmittance	Product of the HIRS Filter and Optical Element Transmittances	Normalized Value of Col. 4
2.25900E+03	0.00000E+00	4.88840E-01	0.00000E+00	0.00000E+00
2.25490E+03	1.06250E-02	4.88320E-01	5.18830E-03	1.69800E-02
2.25420E+03	1.06470E-02	4.88150E-01	5.19720E-03	1.70090E-02
2.25360E+03	1.48550E-02	4.88110E-01	7.25070E-03	2.37300E-02
2.25270E+03	2.22110E-02	4.87960E-01	1.08380E-02	3.54710E-02
2.25200E+03	2.74660E-02	4.87850E-01	1.33990E-02	4.38540E-02
2.25090E+03	4.42530E-02	4.87670E-01	2.15810E-02	7.06300E-02
2.25000E+03	5.58000E-02	4.87780E-01	2.72180E-02	8.90790E-02
2.24900E+03	7.57230E-02	4.87780E-01	3.69360E-02	1.20880E-01
2.24840E+03	9.66830E-02	4.87660E-01	4.71490E-02	1.54310E-01
2.24760E+03	1.30210E-01	4.87460E-01	6.34740E-02	2.07740E-01
2.24710E+03	1.58500E-01	4.87300E-01	7.72400E-02	2.52790E-01
2.24620E+03	1.98320E-01	4.86520E-01	9.64870E-02	3.15780E-01
2.24570E+03	2.21370E-01	4.85960E-01	1.07580E-01	3.52080E-01
2.24490E+03	2.68520E-01	4.85260E-01	1.30300E-01	4.26440E-01
2.24420E+03	3.14610E-01	4.84610E-01	1.52460E-01	4.98980E-01
2.24310E+03	3.70140E-01	4.83230E-01	1.78860E-01	5.85390E-01
2.24230E+03	4.14150E-01	4.81830E-01	1.99550E-01	6.53080E-01
2.24150E+03	4.50820E-01	4.80720E-01	2.16720E-01	7.09270E-01
2.24090E+03	4.80150E-01	4.79880E-01	2.30420E-01	7.54100E-01
2.24020E+03	5.06350E-01	4.79010E-01	2.42550E-01	7.93810E-01
2.23940E+03	5.37790E-01	4.78030E-01	2.57080E-01	8.41370E-01
2.23880E+03	5.60850E-01	4.77180E-01	2.67620E-01	8.75870E-01
2.23820E+03	5.77620E-01	4.76420E-01	2.75190E-01	9.00640E-01
2.23770E+03	5.87060E-01	4.75760E-01	2.79300E-01	9.14080E-01
2.23710E+03	5.97550E-01	4.74710E-01	2.83660E-01	9.28360E-01
2.23660E+03	6.06990E-01	4.73890E-01	2.87640E-01	9.41400E-01
2.23580E+03	6.22720E-01	4.72600E-01	2.94300E-01	9.63170E-01
2.23500E+03	6.31120E-01	4.71410E-01	2.97510E-01	9.73700E-01
2.23420E+03	6.41610E-01	4.70120E-01	3.01630E-01	9.87180E-01
2.23380E+03	6.48950E-01	4.69410E-01	3.04630E-01	9.96980E-01
2.23330E+03	6.52110E-01	4.68550E-01	3.05550E-01	1.00000E+00
2.23290E+03	6.50030E-01	4.67930E-01	3.04170E-01	9.95480E-01
2.23230E+03	6.46900E-01	4.66870E-01	3.02020E-01	9.88450E-01
2.23190E+03	6.42730E-01	4.66220E-01	2.99650E-01	9.80710E-01
2.23140E+03	6.34370E-01	4.65510E-01	2.95310E-01	9.66470E-01
2.23090E+03	6.20770E-01	4.64790E-01	2.88530E-01	9.44280E-01

2.23020E+03	6.02990E-01	4.63870E-01	2.79710E-01	9.15420E-01
2.22940E+03	5.77880E-01	4.62680E-01	2.67380E-01	8.75070E-01
2.22860E+03	5.52770E-01	4.61620E-01	2.55170E-01	8.35120E-01
2.22780E+03	5.18240E-01	4.60530E-01	2.38660E-01	7.81100E-01
2.22690E+03	4.81620E-01	4.59300E-01	2.21210E-01	7.23970E-01
2.22610E+03	4.36620E-01	4.57530E-01	1.99770E-01	6.53800E-01
2.22490E+03	3.86390E-01	4.55380E-01	1.75950E-01	5.75860E-01
2.22340E+03	3.25700E-01	4.52350E-01	1.47330E-01	4.82190E-01
2.22190E+03	2.76530E-01	4.49940E-01	1.24420E-01	4.07210E-01
2.22050E+03	2.23170E-01	4.47930E-01	9.99670E-02	3.27170E-01
2.21900E+03	1.69810E-01	4.45850E-01	7.57120E-02	2.47790E-01
2.21750E+03	1.21690E-01	4.43860E-01	5.40140E-02	1.76780E-01
2.21660E+03	9.86820E-02	4.43100E-01	4.37260E-02	1.43110E-01
2.21560E+03	7.67230E-02	4.42200E-01	3.39270E-02	1.11040E-01
2.21460E+03	5.79040E-02	4.41300E-01	2.55530E-02	8.36290E-02
2.21390E+03	4.53580E-02	4.40710E-01	1.99900E-02	6.54220E-02
2.21330E+03	3.80460E-02	4.40190E-01	1.67470E-02	5.48100E-02
2.21270E+03	3.07340E-02	4.39660E-01	1.35120E-02	4.42240E-02
2.21220E+03	2.34210E-02	4.39140E-01	1.02850E-02	3.36610E-02
2.21170E+03	2.02930E-02	4.38760E-01	8.90390E-03	2.91400E-02
2.21080E+03	1.92750E-02	4.37870E-01	8.43980E-03	2.76220E-02
2.21030E+03	1.61460E-02	4.37360E-01	7.06170E-03	2.31120E-02
2.20990E+03	1.30180E-02	4.36840E-01	5.68690E-03	1.86120E-02
2.20940E+03	1.09370E-02	4.36330E-01	4.77220E-03	1.56180E-02
2.20900E+03	0.00000E+00	4.35800E-01	0.00000E+00	0.00000E+00

Channel 16

Wave Number	HIRS Filter Transmittance	Optical Element Transmittance	Product of the HIRS Filter and Optical Element Transmittances	Normalized Value of Col. 4
2.26800E+03	0.00000E+00	4.86730E-01	0.00000E+00	0.00000E+00
2.26270E+03	1.75630E-02	4.87780E-01	8.56710E-03	2.94340E-02
2.26220E+03	1.85940E-02	4.87870E-01	9.07160E-03	3.11670E-02
2.26160E+03	2.17150E-02	4.88050E-01	1.05980E-02	3.64120E-02
2.26110E+03	2.58830E-02	4.88240E-01	1.26370E-02	4.34180E-02
2.26030E+03	3.31840E-02	4.88490E-01	1.62100E-02	5.56930E-02
2.25960E+03	4.15300E-02	4.88730E-01	2.02970E-02	6.97350E-02
2.25900E+03	5.30190E-02	4.88840E-01	2.59180E-02	8.90460E-02
2.25860E+03	6.45120E-02	4.88780E-01	3.15320E-02	1.08330E-01
2.25820E+03	7.70530E-02	4.88750E-01	3.76600E-02	1.29390E-01
2.25770E+03	8.95900E-02	4.88730E-01	4.37850E-02	1.50430E-01
2.25730E+03	1.12590E-01	4.88720E-01	5.50260E-02	1.89050E-01
2.25690E+03	1.31410E-01	4.88690E-01	6.42180E-02	2.20640E-01

2.25660E+03	1.57550E-01	4.88640E-01	7.69850E-02	2.64500E-01
2.25620E+03	1.84730E-01	4.88600E-01	9.02610E-02	3.10110E-01
2.25580E+03	2.34930E-01	4.88560E-01	1.14780E-01	3.94340E-01
2.25510E+03	3.04990E-01	4.88360E-01	1.48950E-01	5.11740E-01
2.25460E+03	3.56230E-01	4.88220E-01	1.73920E-01	5.97550E-01
2.25400E+03	4.14790E-01	4.88170E-01	2.02490E-01	6.95700E-01
2.25360E+03	4.66040E-01	4.88120E-01	2.27480E-01	7.81560E-01
2.25310E+03	5.13090E-01	4.88030E-01	2.50410E-01	8.60320E-01
2.25280E+03	5.40280E-01	4.87980E-01	2.63650E-01	9.05820E-01
2.25240E+03	5.62240E-01	4.87920E-01	2.74330E-01	9.42510E-01
2.25200E+03	5.82100E-01	4.87850E-01	2.83980E-01	9.75660E-01
2.25150E+03	5.96730E-01	4.87760E-01	2.91060E-01	1.00000E+00
2.25050E+03	5.96700E-01	4.87680E-01	2.90990E-01	9.99780E-01
2.24990E+03	5.75760E-01	4.87800E-01	2.80860E-01	9.64940E-01
2.24930E+03	5.55870E-01	4.87830E-01	2.71170E-01	9.31650E-01
2.24880E+03	5.37020E-01	4.87740E-01	2.61930E-01	8.99920E-01
2.24850E+03	5.23420E-01	4.87690E-01	2.55260E-01	8.77020E-01
2.24800E+03	5.06670E-01	4.87560E-01	2.47030E-01	8.48720E-01
2.24770E+03	4.95150E-01	4.87470E-01	2.41370E-01	8.29270E-01
2.24720E+03	4.85720E-01	4.87360E-01	2.36720E-01	8.13300E-01
2.24680E+03	4.76290E-01	4.87050E-01	2.31980E-01	7.97010E-01
2.24640E+03	4.70010E-01	4.86700E-01	2.28750E-01	7.85930E-01
2.24590E+03	4.65810E-01	4.86200E-01	2.26480E-01	7.78110E-01
2.24540E+03	4.62650E-01	4.85700E-01	2.24710E-01	7.72040E-01
2.24480E+03	4.64730E-01	4.85150E-01	2.25460E-01	7.74630E-01
2.24440E+03	4.66810E-01	4.84820E-01	2.26320E-01	7.77560E-01
2.24400E+03	4.70980E-01	4.84420E-01	2.28150E-01	7.83870E-01
2.24320E+03	4.81420E-01	4.83350E-01	2.32690E-01	7.99460E-01
2.24250E+03	4.93950E-01	4.82170E-01	2.38170E-01	8.18270E-01
2.24160E+03	5.08570E-01	4.80790E-01	2.44510E-01	8.40080E-01
2.24080E+03	5.21090E-01	4.79670E-01	2.49950E-01	8.58770E-01
2.24010E+03	5.31530E-01	4.78790E-01	2.54490E-01	8.74370E-01
2.23930E+03	5.39880E-01	4.77880E-01	2.57990E-01	8.86400E-01
2.23860E+03	5.43000E-01	4.77020E-01	2.59020E-01	8.89920E-01
2.23810E+03	5.45070E-01	4.76260E-01	2.59600E-01	8.91900E-01
2.23760E+03	5.44010E-01	4.75450E-01	2.58650E-01	8.88650E-01
2.23710E+03	5.37720E-01	4.74760E-01	2.55290E-01	8.77090E-01
2.23630E+03	5.28280E-01	4.73450E-01	2.50120E-01	8.59330E-01
2.23590E+03	5.16760E-01	4.72760E-01	2.44310E-01	8.39360E-01
2.23540E+03	5.05240E-01	4.71940E-01	2.38440E-01	8.19220E-01
2.23480E+03	4.88490E-01	4.70990E-01	2.30070E-01	7.90460E-01
2.23410E+03	4.66500E-01	4.69940E-01	2.19230E-01	7.53200E-01
2.23370E+03	4.47660E-01	4.69230E-01	2.10060E-01	7.21690E-01

2.23320E+03	4.26730E-01	4.68490E-01	1.99920E-01	6.86850E-01
2.23250E+03	3.95320E-01	4.67250E-01	1.84720E-01	6.34630E-01
2.23210E+03	3.68110E-01	4.66500E-01	1.71730E-01	5.90000E-01
2.23140E+03	3.32530E-01	4.65600E-01	1.54820E-01	5.31930E-01
2.23040E+03	2.74970E-01	4.64080E-01	1.27610E-01	4.38420E-01
2.22930E+03	2.13220E-01	4.62520E-01	9.86160E-02	3.38820E-01
2.22820E+03	1.66120E-01	4.61070E-01	7.65920E-02	2.63150E-01
2.22780E+03	1.46230E-01	4.60490E-01	6.73360E-02	2.31350E-01
2.22730E+03	1.26340E-01	4.59800E-01	5.80900E-02	1.99580E-01
2.22670E+03	1.05400E-01	4.58850E-01	4.83630E-02	1.66160E-01
2.22580E+03	8.23600E-02	4.56970E-01	3.76360E-02	1.29310E-01
2.22510E+03	6.76960E-02	4.55710E-01	3.08500E-02	1.05990E-01
2.22450E+03	5.61720E-02	4.54570E-01	2.55340E-02	8.77270E-02
2.22380E+03	4.67360E-02	4.53150E-01	2.11790E-02	7.27640E-02
2.22320E+03	3.83500E-02	4.52010E-01	1.73350E-02	5.95580E-02
2.22230E+03	3.10020E-02	4.50550E-01	1.39680E-02	4.79900E-02
2.22190E+03	2.68050E-02	4.49910E-01	1.20600E-02	4.14340E-02
2.22120E+03	2.15530E-02	4.48870E-01	9.67440E-03	3.32390E-02
2.21990E+03	1.41930E-02	4.47100E-01	6.34590E-03	2.18030E-02
2.21900E+03	1.10290E-02	4.45880E-01	4.91770E-03	1.68960E-02
2.21830E+03	8.91520E-03	4.44920E-01	3.96660E-03	1.36280E-02
2.21500E+03	0.00000E+00	4.41660E-01	0.00000E+00	0.00000E+00

Channel 17

Wave Number	HIRS Filter Transmittance	Optical Element Transmittance	Product of the HIRS Filter and Optical Element Transmittances	Normalized Value of Col. 4
2.44800E+03	0.00000E+00	4.88670E-01	0.00000E+00	0.00000E+00
2.44490E+03	1.70510E-02	4.89090E-01	8.33970E-03	2.43620E-02
2.44380E+03	3.17180E-02	4.89100E-01	1.55130E-02	4.53170E-02
2.44290E+03	4.84740E-02	4.89130E-01	2.37100E-02	6.92620E-02
2.44180E+03	6.41860E-02	4.89180E-01	3.13980E-02	9.17220E-02
2.44090E+03	7.98960E-02	4.89360E-01	3.90980E-02	1.14210E-01
2.44020E+03	9.14170E-02	4.89520E-01	4.47500E-02	1.30730E-01
2.43930E+03	1.09220E-01	4.89690E-01	5.34830E-02	1.56240E-01
2.43860E+03	1.24920E-01	4.89680E-01	6.11720E-02	1.78700E-01
2.43780E+03	1.50040E-01	4.89620E-01	7.34650E-02	2.14610E-01
2.43690E+03	1.79350E-01	4.89440E-01	8.77810E-02	2.56430E-01
2.43600E+03	2.10750E-01	4.89250E-01	1.03110E-01	3.01210E-01
2.43510E+03	2.48430E-01	4.89050E-01	1.21490E-01	3.54910E-01
2.43410E+03	2.80870E-01	4.89060E-01	1.37370E-01	4.01280E-01
2.43270E+03	3.35300E-01	4.89080E-01	1.63990E-01	4.79050E-01
2.43160E+03	3.74020E-01	4.89010E-01	1.82900E-01	5.34300E-01

2.43070E+03	3.98100E-01	4.88520E-01	1.94480E-01	5.68120E-01
2.43020E+03	4.13800E-01	4.88210E-01	2.02020E-01	5.90160E-01
2.42950E+03	4.30550E-01	4.87780E-01	2.10020E-01	6.13510E-01
2.42870E+03	4.43120E-01	4.87350E-01	2.15950E-01	6.30850E-01
2.42790E+03	4.50460E-01	4.87070E-01	2.19410E-01	6.40940E-01
2.42710E+03	4.53620E-01	4.87500E-01	2.21140E-01	6.46000E-01
2.42630E+03	4.55720E-01	4.87870E-01	2.22330E-01	6.49490E-01
2.42540E+03	4.52600E-01	4.88340E-01	2.21020E-01	6.45660E-01
2.42440E+03	4.49490E-01	4.88400E-01	2.19530E-01	6.41300E-01
2.42350E+03	4.44280E-01	4.88850E-01	2.17190E-01	6.34450E-01
2.42250E+03	4.34880E-01	4.89070E-01	2.12690E-01	6.21310E-01
2.42160E+03	4.28630E-01	4.89130E-01	2.09650E-01	6.12440E-01
2.42060E+03	4.19230E-01	4.88700E-01	2.04880E-01	5.98500E-01
2.41950E+03	4.11930E-01	4.88210E-01	2.01110E-01	5.87490E-01
2.41880E+03	4.08810E-01	4.87810E-01	1.99420E-01	5.82560E-01
2.41760E+03	4.05700E-01	4.87140E-01	1.97630E-01	5.77320E-01
2.41680E+03	4.08850E-01	4.86740E-01	1.99000E-01	5.81340E-01
2.41630E+03	4.10960E-01	4.86450E-01	1.99910E-01	5.83980E-01
2.41560E+03	4.19340E-01	4.85960E-01	2.03780E-01	5.95300E-01
2.41510E+03	4.26670E-01	4.85640E-01	2.07210E-01	6.05310E-01
2.41430E+03	4.41330E-01	4.85150E-01	2.14110E-01	6.25470E-01
2.41380E+03	4.55990E-01	4.84810E-01	2.21070E-01	6.45790E-01
2.41320E+03	4.75870E-01	4.84400E-01	2.30510E-01	6.73390E-01
2.41280E+03	4.92620E-01	4.84130E-01	2.38490E-01	6.96690E-01
2.41240E+03	5.06230E-01	4.83860E-01	2.44940E-01	7.15530E-01
2.41170E+03	5.33440E-01	4.83450E-01	2.57890E-01	7.53350E-01
2.41120E+03	5.72150E-01	4.83110E-01	2.76410E-01	8.07470E-01
2.41050E+03	6.21330E-01	4.82640E-01	2.99880E-01	8.76010E-01
2.40980E+03	6.60050E-01	4.82120E-01	3.18220E-01	9.29600E-01
2.40960E+03	6.76790E-01	4.81990E-01	3.26200E-01	9.52910E-01
2.40930E+03	6.89340E-01	4.81820E-01	3.32140E-01	9.70260E-01
2.40910E+03	6.95630E-01	4.81710E-01	3.35090E-01	9.78880E-01
2.40860E+03	7.04000E-01	4.81490E-01	3.38970E-01	9.90220E-01
2.40810E+03	7.11340E-01	4.81240E-01	3.42320E-01	1.00000E+00
2.40750E+03	6.94610E-01	4.80930E-01	3.34060E-01	9.75860E-01
2.40720E+03	6.82070E-01	4.80770E-01	3.27920E-01	9.57920E-01
2.40690E+03	6.66380E-01	4.80660E-01	3.20310E-01	9.35690E-01
2.40660E+03	6.45470E-01	4.80510E-01	3.10150E-01	9.06030E-01
2.40630E+03	6.26650E-01	4.80380E-01	3.01030E-01	8.79380E-01
2.40610E+03	6.02590E-01	4.80360E-01	2.89460E-01	8.45590E-01
2.40570E+03	5.62850E-01	4.80320E-01	2.70350E-01	7.89750E-01
2.40560E+03	5.36700E-01	4.80310E-01	2.57780E-01	7.53050E-01
2.40520E+03	5.10560E-01	4.80280E-01	2.45210E-01	7.16320E-01

2.40470E+03	4.57220E-01	4.80220E-01	2.19570E-01	6.41410E-01
2.40430E+03	3.88190E-01	4.80150E-01	1.86390E-01	5.44500E-01
2.40290E+03	2.61650E-01	4.79930E-01	1.25580E-01	3.66840E-01
2.40230E+03	1.99950E-01	4.79830E-01	9.59430E-02	2.80270E-01
2.40160E+03	1.65450E-01	4.79730E-01	7.93700E-02	2.31860E-01
2.40120E+03	1.36170E-01	4.79660E-01	6.53130E-02	1.90800E-01
2.40070E+03	1.12120E-01	4.79570E-01	5.37680E-02	1.57070E-01
2.40010E+03	9.33010E-02	4.79440E-01	4.47320E-02	1.30670E-01
2.39960E+03	7.76220E-02	4.79320E-01	3.72060E-02	1.08690E-01
2.39930E+03	6.71680E-02	4.79240E-01	3.21900E-02	9.40340E-02
2.39890E+03	6.29930E-02	4.79140E-01	3.01830E-02	8.81710E-02
2.39830E+03	5.98680E-02	4.78990E-01	2.86760E-02	8.37710E-02
2.39750E+03	5.77910E-02	4.78830E-01	2.76720E-02	8.08370E-02
2.39680E+03	5.57150E-02	4.79110E-01	2.66940E-02	7.79790E-02
2.39610E+03	5.36380E-02	4.79400E-01	2.57140E-02	7.51170E-02
2.39550E+03	4.94650E-02	4.79600E-01	2.37230E-02	6.93020E-02
2.39480E+03	4.42500E-02	4.79880E-01	2.12350E-02	6.20320E-02
2.39360E+03	3.90460E-02	4.80580E-01	1.87650E-02	5.48160E-02
2.39250E+03	3.38380E-02	4.81390E-01	1.62890E-02	4.75850E-02
2.39070E+03	2.75990E-02	4.83410E-01	1.33420E-02	3.89740E-02
2.38940E+03	2.03050E-02	4.85410E-01	9.85650E-03	2.87930E-02
2.38800E+03	1.40580E-02	4.86700E-01	6.84190E-03	1.99870E-02
2.38710E+03	8.84740E-03	4.87630E-01	4.31420E-03	1.26030E-02
2.38200E+03	0.00000E+00	4.95360E-01	0.00000E+00	0.00000E+00

Channel 18

Wave Number	HIRS Filter Transmittance	Optical Element Transmittance	Product of the HIRS Filter and Optical Element Transmittances	Normalized Value of Col. 4
2.56200E+03	0.00000E+00	4.78340E-01	0.00000E+00	0.00000E+00
2.55530E+03	1.36490E-02	4.77840E-01	6.52190E-03	1.80750E-02
2.55490E+03	1.99290E-02	4.77790E-01	9.52190E-03	2.63890E-02
2.55400E+03	2.41220E-02	4.77680E-01	1.15230E-02	3.19340E-02
2.55300E+03	2.72710E-02	4.77620E-01	1.30250E-02	3.60980E-02
2.55170E+03	3.35600E-02	4.77520E-01	1.60260E-02	4.44130E-02
2.55070E+03	3.98470E-02	4.77300E-01	1.90190E-02	5.27100E-02
2.54990E+03	4.50850E-02	4.77150E-01	2.15130E-02	5.96200E-02
2.54860E+03	5.55600E-02	4.76880E-01	2.64950E-02	7.34280E-02
2.54740E+03	6.70780E-02	4.76670E-01	3.19740E-02	8.86130E-02
2.54630E+03	8.27800E-02	4.76670E-01	3.94590E-02	1.09360E-01
2.54540E+03	9.42950E-02	4.76630E-01	4.49440E-02	1.24560E-01
2.54480E+03	1.04760E-01	4.76600E-01	4.99300E-02	1.38380E-01
2.54410E+03	1.17320E-01	4.76590E-01	5.59140E-02	1.54960E-01

2.54320E+03	1.40340E-01	4.76610E-01	6.68890E-02	1.85380E-01
2.54200E+03	1.68600E-01	4.76610E-01	8.03560E-02	2.22700E-01
2.54090E+03	2.01040E-01	4.76660E-01	9.58280E-02	2.65580E-01
2.53990E+03	2.30340E-01	4.76700E-01	1.09800E-01	3.04300E-01
2.53900E+03	2.60680E-01	4.76700E-01	1.24270E-01	3.44390E-01
2.53810E+03	2.92070E-01	4.76700E-01	1.39230E-01	3.85860E-01
2.53700E+03	3.33920E-01	4.76800E-01	1.59210E-01	4.41240E-01
2.53620E+03	3.65310E-01	4.76910E-01	1.74220E-01	4.82840E-01
2.53490E+03	4.10310E-01	4.77080E-01	1.95750E-01	5.42500E-01
2.53370E+03	4.57390E-01	4.77180E-01	2.18260E-01	6.04880E-01
2.53270E+03	4.90870E-01	4.77230E-01	2.34260E-01	6.49220E-01
2.53170E+03	5.26450E-01	4.77200E-01	2.51220E-01	6.96240E-01
2.53070E+03	5.57840E-01	4.77130E-01	2.66160E-01	7.37640E-01
2.52950E+03	5.91320E-01	4.76990E-01	2.82060E-01	7.81690E-01
2.52860E+03	6.14350E-01	4.76870E-01	2.92960E-01	8.11920E-01
2.52770E+03	6.31090E-01	4.76800E-01	3.00900E-01	8.33920E-01
2.52680E+03	6.45750E-01	4.76780E-01	3.07880E-01	8.53250E-01
2.52570E+03	6.62490E-01	4.76730E-01	3.15830E-01	8.75290E-01
2.52520E+03	6.71910E-01	4.76710E-01	3.20300E-01	8.87690E-01
2.52460E+03	6.78200E-01	4.76680E-01	3.23280E-01	8.95940E-01
2.52410E+03	6.85520E-01	4.76660E-01	3.26760E-01	9.05580E-01
2.52320E+03	6.91810E-01	4.76630E-01	3.29730E-01	9.13820E-01
2.52240E+03	6.97050E-01	4.76600E-01	3.32210E-01	9.20680E-01
2.52150E+03	7.02290E-01	4.76560E-01	3.34680E-01	9.27540E-01
2.52020E+03	7.05440E-01	4.76550E-01	3.36180E-01	9.31670E-01
2.51850E+03	7.08590E-01	4.76970E-01	3.37980E-01	9.36670E-01
2.51690E+03	7.09660E-01	4.77530E-01	3.38880E-01	9.39180E-01
2.51550E+03	7.11760E-01	4.77840E-01	3.40110E-01	9.42580E-01
2.51420E+03	7.13870E-01	4.78090E-01	3.41290E-01	9.45850E-01
2.51310E+03	7.20160E-01	4.78050E-01	3.44270E-01	9.54120E-01
2.51200E+03	7.26440E-01	4.77990E-01	3.47230E-01	9.62310E-01
2.51060E+03	7.36920E-01	4.77510E-01	3.51890E-01	9.75220E-01
2.50990E+03	7.43200E-01	4.77180E-01	3.54640E-01	9.82850E-01
2.50890E+03	7.51580E-01	4.76700E-01	3.58280E-01	9.92930E-01
2.50810E+03	7.55770E-01	4.76360E-01	3.60020E-01	9.97750E-01
2.50750E+03	7.57870E-01	4.76110E-01	3.60830E-01	1.00000E+00
2.50710E+03	7.56830E-01	4.76240E-01	3.60430E-01	9.98910E-01
2.50650E+03	7.53700E-01	4.76490E-01	3.59130E-01	9.95290E-01
2.50590E+03	7.46380E-01	4.76720E-01	3.55820E-01	9.86110E-01
2.50550E+03	7.38020E-01	4.76900E-01	3.51960E-01	9.75430E-01
2.50500E+03	7.25470E-01	4.77130E-01	3.46150E-01	9.59310E-01
2.50460E+03	7.07690E-01	4.77290E-01	3.37770E-01	9.36100E-01
2.50410E+03	6.88870E-01	4.77430E-01	3.28880E-01	9.11470E-01

2.50360E+03	6.65860E-01	4.77540E-01	3.17970E-01	8.81230E-01
2.50320E+03	6.40760E-01	4.77650E-01	3.06060E-01	8.48210E-01
2.50280E+03	6.20890E-01	4.77760E-01	2.96640E-01	8.22090E-01
2.50240E+03	5.90560E-01	4.77870E-01	2.82210E-01	7.82110E-01
2.50190E+03	5.65460E-01	4.77950E-01	2.70260E-01	7.49000E-01
2.50150E+03	5.27810E-01	4.78010E-01	2.52300E-01	6.99220E-01
2.50090E+03	4.84930E-01	4.78070E-01	2.31830E-01	6.42500E-01
2.50050E+03	4.43090E-01	4.78100E-01	2.11840E-01	5.87100E-01
2.49920E+03	3.59420E-01	4.78230E-01	1.71890E-01	4.76370E-01
2.49850E+03	3.08180E-01	4.78300E-01	1.47400E-01	4.08510E-01
2.49780E+03	2.66340E-01	4.78370E-01	1.27410E-01	3.53100E-01
2.49730E+03	2.34970E-01	4.78460E-01	1.12420E-01	3.11560E-01
2.49680E+03	2.11960E-01	4.78670E-01	1.01460E-01	2.81180E-01
2.49590E+03	1.75360E-01	4.79030E-01	8.40010E-02	2.32800E-01
2.49510E+03	1.43980E-01	4.79380E-01	6.90240E-02	1.91290E-01
2.49380E+03	1.09480E-01	4.79970E-01	5.25470E-02	1.45630E-01
2.49280E+03	8.85700E-02	4.80500E-01	4.25570E-02	1.17940E-01
2.49210E+03	7.49790E-02	4.80780E-01	3.60480E-02	9.99040E-02
2.49110E+03	6.13900E-02	4.81140E-01	2.95370E-02	8.18590E-02
2.49030E+03	5.19850E-02	4.81430E-01	2.50270E-02	6.93590E-02
2.48940E+03	4.36250E-02	4.81710E-01	2.10150E-02	5.82410E-02
2.48850E+03	3.84050E-02	4.81870E-01	1.85060E-02	5.12890E-02
2.48760E+03	3.31840E-02	4.81990E-01	1.59940E-02	4.43270E-02
2.48670E+03	2.79640E-02	4.82030E-01	1.34790E-02	3.73560E-02
2.48580E+03	2.37890E-02	4.82010E-01	1.14670E-02	3.17790E-02
2.48480E+03	2.06610E-02	4.81980E-01	9.95830E-03	2.75980E-02
2.48440E+03	1.96200E-02	4.81970E-01	9.45600E-03	2.62060E-02
2.48370E+03	1.64890E-02	4.81950E-01	7.94690E-03	2.20240E-02
2.47200E+03	0.00000E+00	4.83870E-01	0.00000E+00	0.00000E+00

Channel 19

Wave Number	HIRS Filter Transmittance	Optical Element Transmittance	Product of the HIRS Filter and Optical Element Transmittances	Normalized Value of Col. 4
2.77400E+03	0.00000E+00	3.93920E-01	0.00000E+00	0.00000E+00
2.74820E+03	1.15180E-02	4.10010E-01	4.72260E-03	1.56840E-02
2.74630E+03	1.57100E-02	4.10930E-01	6.45570E-03	2.14400E-02
2.74420E+03	1.88570E-02	4.11570E-01	7.76100E-03	2.57750E-02
2.74210E+03	2.51420E-02	4.12270E-01	1.03650E-02	3.44230E-02
2.73970E+03	3.14280E-02	4.12960E-01	1.29780E-02	4.31020E-02
2.73790E+03	3.98040E-02	4.13580E-01	1.64620E-02	5.46700E-02
2.73610E+03	5.02710E-02	4.14200E-01	2.08220E-02	6.91510E-02
2.73450E+03	5.96920E-02	4.14590E-01	2.47480E-02	8.21880E-02

2.73340E+03	7.01570E-02	4.14790E-01	2.91000E-02	9.66440E-02
2.73190E+03	8.27160E-02	4.15340E-01	3.43550E-02	1.14100E-01
2.73050E+03	9.84120E-02	4.15810E-01	4.09200E-02	1.35900E-01
2.72920E+03	1.15150E-01	4.16420E-01	4.79520E-02	1.59250E-01
2.72820E+03	1.37120E-01	4.16890E-01	5.71660E-02	1.89850E-01
2.72630E+03	1.66420E-01	4.17600E-01	6.94970E-02	2.30800E-01
2.72500E+03	1.94670E-01	4.18150E-01	8.14000E-02	2.70330E-01
2.72310E+03	2.41750E-01	4.18920E-01	1.01270E-01	3.36330E-01
2.72180E+03	2.80460E-01	4.19470E-01	1.17640E-01	3.90700E-01
2.72080E+03	3.06610E-01	4.19760E-01	1.28700E-01	4.27430E-01
2.72000E+03	3.31720E-01	4.19910E-01	1.39290E-01	4.62600E-01
2.71890E+03	3.65200E-01	4.20010E-01	1.53390E-01	5.09400E-01
2.71790E+03	4.02860E-01	4.20100E-01	1.69240E-01	5.62050E-01
2.71650E+03	4.41560E-01	4.20220E-01	1.85550E-01	6.16230E-01
2.71490E+03	4.90730E-01	4.20380E-01	2.06290E-01	6.85110E-01
2.71440E+03	5.16890E-01	4.20430E-01	2.17320E-01	7.21720E-01
2.71280E+03	5.45140E-01	4.20570E-01	2.29270E-01	7.61400E-01
2.71180E+03	5.73380E-01	4.20750E-01	2.41250E-01	8.01200E-01
2.71100E+03	5.94310E-01	4.20890E-01	2.50140E-01	8.30710E-01
2.70940E+03	6.11050E-01	4.21170E-01	2.57360E-01	8.54690E-01
2.70860E+03	6.22560E-01	4.21340E-01	2.62310E-01	8.71130E-01
2.70730E+03	6.31980E-01	4.21620E-01	2.66460E-01	8.84920E-01
2.70620E+03	6.38260E-01	4.21720E-01	2.69170E-01	8.93910E-01
2.70410E+03	6.36180E-01	4.21880E-01	2.68390E-01	8.91340E-01
2.70230E+03	6.36180E-01	4.22060E-01	2.68510E-01	8.91720E-01
2.70120E+03	6.32000E-01	4.22210E-01	2.66840E-01	8.86180E-01
2.69970E+03	6.27830E-01	4.22550E-01	2.65290E-01	8.81040E-01
2.69780E+03	6.23650E-01	4.23310E-01	2.64000E-01	8.76760E-01
2.69600E+03	6.20520E-01	4.24020E-01	2.63110E-01	8.73800E-01
2.69360E+03	6.19480E-01	4.24650E-01	2.63070E-01	8.73660E-01
2.69130E+03	6.22630E-01	4.25430E-01	2.64890E-01	8.79700E-01
2.68890E+03	6.25780E-01	4.26350E-01	2.66800E-01	8.86070E-01
2.68710E+03	6.28930E-01	4.26840E-01	2.68450E-01	8.91530E-01
2.68520E+03	6.31030E-01	4.27320E-01	2.69650E-01	8.95530E-01
2.68340E+03	6.35220E-01	4.27540E-01	2.71580E-01	9.01930E-01
2.68100E+03	6.39410E-01	4.27510E-01	2.73360E-01	9.07830E-01
2.67600E+03	6.38390E-01	4.29000E-01	2.73870E-01	9.09530E-01
2.67420E+03	6.33160E-01	4.29420E-01	2.71890E-01	9.02970E-01
2.67260E+03	6.28990E-01	4.29930E-01	2.70420E-01	8.98070E-01
2.67080E+03	6.24810E-01	4.30540E-01	2.69000E-01	8.93380E-01
2.66920E+03	6.15400E-01	4.31060E-01	2.65270E-01	8.80980E-01
2.66690E+03	6.06000E-01	4.31820E-01	2.61680E-01	8.69050E-01
2.66480E+03	5.95550E-01	4.32390E-01	2.57510E-01	8.55200E-01

2.66270E+03	5.85100E-01	4.32990E-01	2.53340E-01	8.41350E-01
2.66110E+03	5.75690E-01	4.33640E-01	2.49640E-01	8.29060E-01
2.65920E+03	5.66280E-01	4.34590E-01	2.46100E-01	8.17300E-01
2.65710E+03	5.60010E-01	4.35810E-01	2.44060E-01	8.10530E-01
2.65530E+03	5.53740E-01	4.36390E-01	2.41650E-01	8.02530E-01
2.65400E+03	5.49570E-01	4.36690E-01	2.39990E-01	7.97010E-01
2.65160E+03	5.49580E-01	4.37640E-01	2.40520E-01	7.98760E-01
2.65030E+03	5.48540E-01	4.38400E-01	2.40480E-01	7.98630E-01
2.64820E+03	5.51680E-01	4.39610E-01	2.42530E-01	8.05440E-01
2.64720E+03	5.55870E-01	4.40220E-01	2.44710E-01	8.12690E-01
2.64560E+03	5.61110E-01	4.40910E-01	2.47400E-01	8.21610E-01
2.64430E+03	5.70530E-01	4.41450E-01	2.51860E-01	8.36440E-01
2.64270E+03	5.80990E-01	4.42110E-01	2.56860E-01	8.53040E-01
2.64010E+03	6.00880E-01	4.43200E-01	2.66310E-01	8.84420E-01
2.63800E+03	6.20760E-01	4.43860E-01	2.75530E-01	9.15050E-01
2.63590E+03	6.38550E-01	4.44500E-01	2.83830E-01	9.42630E-01
2.63400E+03	6.52160E-01	4.45530E-01	2.90550E-01	9.64940E-01
2.63300E+03	6.60530E-01	4.46380E-01	2.94850E-01	9.79210E-01
2.63160E+03	6.68910E-01	4.47350E-01	2.99230E-01	9.93760E-01
2.63030E+03	6.71000E-01	4.48270E-01	3.00790E-01	9.98940E-01
2.62960E+03	6.71010E-01	4.48740E-01	3.01110E-01	1.00000E+00
2.62820E+03	6.65780E-01	4.49510E-01	2.99270E-01	9.93900E-01
2.62720E+03	6.56370E-01	4.50120E-01	2.95440E-01	9.81180E-01
2.62640E+03	6.44870E-01	4.50570E-01	2.90560E-01	9.64960E-01
2.62540E+03	6.30230E-01	4.51030E-01	2.84250E-01	9.44020E-01
2.62460E+03	6.10360E-01	4.51360E-01	2.75490E-01	9.14920E-01
2.62410E+03	5.94670E-01	4.51600E-01	2.68550E-01	8.91870E-01
2.62300E+03	5.82120E-01	4.52080E-01	2.63170E-01	8.73980E-01
2.62250E+03	5.59110E-01	4.52240E-01	2.52850E-01	8.39740E-01
2.62090E+03	5.19370E-01	4.52680E-01	2.35110E-01	7.80800E-01
2.61990E+03	4.75440E-01	4.52960E-01	2.15360E-01	7.15210E-01
2.61860E+03	4.41970E-01	4.53330E-01	2.00360E-01	6.65400E-01
2.61730E+03	4.02230E-01	4.53920E-01	1.82580E-01	6.06350E-01
2.61650E+03	3.65620E-01	4.54270E-01	1.66090E-01	5.51600E-01
2.61550E+03	3.34250E-01	4.54780E-01	1.52010E-01	5.04830E-01
2.61410E+03	3.02870E-01	4.55420E-01	1.37930E-01	4.58090E-01
2.61290E+03	2.69400E-01	4.56060E-01	1.22870E-01	4.08040E-01
2.61150E+03	2.38030E-01	4.56750E-01	1.08720E-01	3.61060E-01
2.61050E+03	2.08740E-01	4.57300E-01	9.54580E-02	3.17020E-01
2.60950E+03	1.90970E-01	4.57860E-01	8.74350E-02	2.90380E-01
2.60810E+03	1.69000E-01	4.58530E-01	7.74940E-02	2.57360E-01
2.60740E+03	1.52270E-01	4.58890E-01	6.98760E-02	2.32060E-01
2.60610E+03	1.37630E-01	4.59490E-01	6.32410E-02	2.10030E-01

2.60530E+03	1.22990E-01	4.59910E-01	5.65650E-02	1.87860E-01
2.60450E+03	1.11490E-01	4.60440E-01	5.13340E-02	1.70480E-01
2.60290E+03	9.78970E-02	4.61540E-01	4.51840E-02	1.50060E-01
2.60160E+03	8.74430E-02	4.62380E-01	4.04310E-02	1.34270E-01
2.60060E+03	7.80330E-02	4.62850E-01	3.61180E-02	1.19950E-01
2.59920E+03	6.96700E-02	4.62930E-01	3.22520E-02	1.07110E-01
2.59790E+03	6.02610E-02	4.63060E-01	2.79050E-02	9.26730E-02
2.59640E+03	5.29460E-02	4.63990E-01	2.45660E-02	8.15860E-02
2.59430E+03	4.35400E-02	4.64730E-01	2.02350E-02	6.72000E-02
2.59270E+03	3.72710E-02	4.65480E-01	1.73490E-02	5.76160E-02
2.59090E+03	3.20480E-02	4.66050E-01	1.49360E-02	4.96040E-02
2.58900E+03	2.68260E-02	4.66910E-01	1.25250E-02	4.15970E-02
2.58740E+03	2.36940E-02	4.67560E-01	1.10780E-02	3.67920E-02
2.58530E+03	2.05650E-02	4.68260E-01	9.62970E-03	3.19810E-02
2.58270E+03	1.63920E-02	4.69320E-01	7.69300E-03	2.55490E-02
2.58010E+03	1.32650E-02	4.70480E-01	6.24070E-03	2.07260E-02
2.55500E+03	0.00000E+00	4.77810E-01	0.00000E+00	0.00000E+00

In April 2002, the post-launch calibration for the reflectance (visible) channels of the NOAA-16 AVHRR was reviewed, based on measurements taken over the radiometrically stable targets of the Libyan and Takla Makan Deserts. It was found that there was little loss of sensitivity immediately following the launch of NOAA-16, even though this has been typical behavior for the AVHRR reflectance channels in the past. There was also little degradation in the NOAA-16 AVHRR reflectance channels and the pre-flight coefficients were in reasonable agreement with the ground based truth. Measurements were also made by MODerate-resolution Imaging Spectro-radiometer (MODIS) which is flown on NASA's Earth Observing Satellites (EOS). The MODIS-based coefficients result in reflectances that are somewhat higher than the truth (Heidinger et al. 2002: Using MODIS to calibrate AVHRR reflectance channels, *J. Geophys. Res. - Atmosphere* in press).

Based on these findings, NOAA is recommending (as of Nov. 6, 2002) that the pre-flight calibration coefficients for NOAA-16 AVHRR Channels 1 and 2 be used. However, because there is no desert-based absolute calibration for Channel 3A, NOAA recommends using the MODIS-based calibration for this channel. Table D.2 -7 contains the pre-launch and MODIS-based calibration coefficients for the AVHRR/3 instrument on NOAA-16. The columns labeled "Reflectance" are the reflectances for the Libyan Desert derived with corresponding coefficients, and the shaded areas indicate the NOAA recommended values.

Table D.2-7. NOAA-16 AVHRR/3 Pre-launch Calibration Coefficients (Albedo Representation).								
		Pre-flight AVHRR			MODIS-based			Truth
Channel		Slope	Intercept	Reflectance	Slope	Intercept	Reflectance	Reflectance
1	Low	0.0523	-2.016	38.3	0.0539	-2.12	39.2	37.8
	High	0.1528	-51.91		0.1656	-58.4		
2	Low	0.0513	-1.943	40.5	0.0603	-2.35	46.0	42.6
	High	0.1510	-51.77		0.1580	-51.3		
3A	Low	0.0287	-2.043	66.7	0.0262	-1.01	64.5	n/a

High	0.1806	-78.03	0.1920	-84.2	
------	--------	--------	--------	-------	--

In summary, NOAA recommends using the following equations for NOAA-16 AVHRR reflectance channels:

Channel 1:

$$A_1 = \begin{cases} 0.0523 \times count - 2.016, & count < 497.5 \\ 0.1528 \times count - 51.91, & count > 497.5 \end{cases}$$

Channel 2:

$$A_2 = \begin{cases} 0.0513 \times count - 1.943, & count \leq 499 \\ 0.1510 \times count - 51.77, & count \geq 500 \end{cases}$$

Channel 3A:

$$A_{3A} = \begin{cases} 0.0262 \times count - 1.010, & count < 498.7 \\ 0.1920 \times count - 84.20, & count > 498.7 \end{cases}$$

where count represents the 10-bit digital count as recorded by the AVHRR instrument and A is the albedo assuming the Sun is at its zenith and the Sun-Earth distance is one astronomical unit (A is also referred to as the reflectance factor or adjusted reflectance).

Table D.2-8 contains NOAA-16 AVHRR/3 visible channel information such as equivalent width, w, effective central wavelength, λ_e , and in-band solar irradiance, F.

Table D.2-8. NOAA-16 AVHRR/3 Visible Channel Information.			
Channel	Equivalent Width w (μm)	Effective Wavelength λ_e (μm)	Extraterrestrial Solar Irradiance in Band F (W/m²)
1	0.081	0.632	133.2
2	0.235	0.843	243.1
3A	0.045	1.605	10.96

Note: These quantities are based on the solar irradiance data of Neckel and Labs (1984), which is a widely used source of such data.

Table D.2-9 contains NOAA-16 coefficients d0, c1, d2, d3 and d4 that relate temperature, TPRT, (degrees Kelvin) of each PRT to count value, CPRT, by the equation:

Table D.2-9. NOAA-16 AVHRR/3 Conversion Coefficients.					
PRT	d₀	d₁	d₂	d₃	d₄
1	276.355	5.562E-02	-1.590E-05	2.486E-08	-1.199E-11
2	276.142	5.605E-02	-1.707E-05	2.595E-08	-1.224E-11
3	275.996	5.486E-02	-1.223E-05	1.862E-08	-0.853E-11
4	276.132	5.494E-02	-1.344E-05	2.112E-08	-1.001E-11

Table D.2-10 contains the PRT weighting factors for NOAA-16.

Table D.2-10. NOAA-16 PRT Weighting Factors.			
b₁	b₂	b₃	b₄
0.25	0.25	0.25	0.25

Table D.2-11 contains a summary of the spectral response data as a function of wavenumber for all channels of the NOAA-16 AVHRR/3.

Table D.2-11. Summary of NOAA-16 AVHRR Spectral Response Data (as a Function of Wavenumber) for Each Channel.		
Channel 1		
The peak wavenumber was at 15495.00 and had a value of 1.00		
File starting point is at wavenumber = 12505.00		
File ending point is at wavenumber = 19995.00		
Moment Center Wavenumber = 15868.2297		
Percent line at which curve crosses	Wavenumber (cm⁻¹)	Microns
0.10%	14338.9326	0.6974
1.00%	14455.5352	0.6918
5.00%	14571.2490	0.6863
10.00%	14618.6641	0.6841

20.00%	14666.0889	0.6818		
50.00%	14734.6602	0.6787		
80.00%	14790.9541	0.6761		
80.00%	14937.1426	0.6695		
80.00%	15137.5205	0.6606		
80.00%	16449.8594	0.6079		
80.00%	16514.5234	0.6055		
80.00%	16720.1543	0.5981		
50.00%	17046.8848	0.5866		
20.00%	17118.5664	0.5842		
10.00%	17161.1230	0.5827		
5.00%	17204.7734	0.5812		
1.00%	17308.8086	0.5777		
0.10%	17430.3379	0.5737		
Area Point Limits	Lower (cm⁻¹)	Upper (cm⁻¹)		
99%	14640.6225	17130.3268		
96%	14736.9099	17036.4162		
70%	15067.0453	16675.5908		
50%	15308.1185	16426.1554		
0% (area center)	15844.1477	15844.1477		
Crossing	Lower (cm⁻¹)	Upper (cm⁻¹)	Width (cm⁻¹)	Center (cm⁻¹)
80%	15137.5205	16449.8594	1312.3389	15793.6904
50%	14734.6602	17046.8848	2312.2246	15890.7725
20%	14666.0889	17118.5664	2452.4775	15892.3281
5%	14571.2490	17204.7734	2633.5244	15888.0117
Channel 2				

The peak wavenumber was at 12830.00 and had a value of 1.00				
File starting point is at wavenumber = 9365.00				
File ending point is at wavenumber = 18240.00				
Moment Center Wavenumber = 11978.5911				
Percent line at which curve crosses		Wavenumber (cm ⁻¹)		Microns
0.10%		9755.1406		1.0251
1.00%		9855.8125		1.0146
5.00%		9940.0352		1.0060
10.00%		9986.9189		1.0013
20.00%		10052.9248		0.9947
50.00%		10175.5215		0.9828
80.00%		10554.2461		0.9475
80.00%		13478.5049		0.7419
50.00%		13655.5918		0.7323
20.00%		13995.7490		0.7145
10.00%		14077.5371		0.7104
5.00%		14111.3711		0.7086
1.00%		14308.4395		0.6989
0.10%		14464.7559		0.6913
Area Point Limits	Lower (cm⁻¹)		Upper (cm⁻¹)	
99%	10051.6258		14018.6292	
96%	10188.2717		13826.0739	
70%	10736.5507		13192.2232	
50%	11099.9196		12831.0097	
0% (area center)	11984.5287		11984.5287	
Crossing	Lower (cm⁻¹)	Upper (cm⁻¹)	Width (cm⁻¹)	Center (cm⁻¹)

80%	10554.2461	13478.5049	2924.2588	12016.3760
50%	10175.5215	13655.5918	3480.0703	11915.5566
20%	10052.9248	13995.7490	3942.8242	12024.3369
5%	9940.0352	14111.3711	4171.3359	12025.7031
Channel 3a				
The peak wavenumber was at 6215.00 and had a value of 1.00				
File starting point is at wavenumber = 5785.00				
File ending point is at wavenumber = 6705.00				
Moment Center Wavenumber = 6228.7638				
Percent line at which curve crosses	Wavenumber (cm⁻¹)		Microns	
0.10%	6087.2456		1.6428	
1.00%	6101.9136		1.6388	
5.00%	6115.6563		1.6351	
10.00%	6121.6675		1.6335	
20.00%	6128.0845		1.6318	
50.00%	6137.9063		1.6292	
80.00%	6146.8833		1.6268	
80.00%	6307.8721		1.5853	
50.00%	6317.9136		1.5828	
20.00%	6328.9731		1.5800	
10.00%	6335.8745		1.5783	
5.00%	6343.1074		1.5765	
1.00%	6358.1548		1.5728	
0.10%	6374.0718		1.5689	
Area Point Limits	Lower (cm⁻¹)		Upper (cm⁻¹)	
99%	6116.3582		6332.4535	

96%	6129.1096	6318.4698
70%	6159.0419	6287.3590
50%	6179.0061	6268.7871
0% (area center)	6224.0787	6224.0787

Crossing	Lower (cm ⁻¹)	Upper (cm ⁻¹)	Width (cm ⁻¹)	Center (cm ⁻¹)
80%	6146.8833	6307.8721	160.9888	6227.3779
50%	6137.9063	6317.9136	180.0073	6227.9102
20%	6128.0845	6328.9731	200.8887	6228.5288
5%	6115.6563	6343.1074	227.4512	6229.3818

Channel 3b

The peak wavenumber was at 2677.94 and had a value of 1.00

File starting point is at wavenumber = 2222.80

File ending point is at wavenumber = 3355.51

Moment Center Wavenumber = 2698.6134

Percent line at which curve crosses	Wavenumber (cm ⁻¹)	Microns
0.10%	2459.3757	4.0661
1.00%	2476.7510	4.0375
5.00%	2503.1777	3.9949
10.00%	2520.3076	3.9678
20.00%	2552.0085	3.9185
50.00%	2589.9917	3.8610
80.00%	2609.0283	3.8328
80.00%	2808.1975	3.5610
50.00%	2824.0134	3.5411
20.00%	2837.7290	3.5239

10.00%	2845.3945	3.5145
5.00%	2852.3850	3.5058
1.00%	2867.6255	3.4872
0.10%	2882.8188	3.4688

Area Point Limits	Lower (cm ⁻¹)		Upper (cm ⁻¹)	
99%	2509.9241		2843.2396	
96%	2540.3278		2828.4874	
70%	2614.0127		2787.0042	
50%	2639.6889		2760.8933	
0% (area center)	2700.1148		2700.1148	
Crossing	Lower (cm ⁻¹)	Upper (cm ⁻¹)	Width (cm ⁻¹)	Center (cm ⁻¹)
80%	2609.0283	2808.1975	199.1692	2708.6130
50%	2589.9917	2824.0134	234.0217	2707.0027
20%	2552.0085	2837.7290	285.7205	2694.8689
5%	2503.1777	2852.3850	349.2073	2677.7815
Channel 4				
The peak wavenumber was at 888.37 and had a value of 1.00				
File starting point is at wavenumber = 781.30				
File ending point is at wavenumber = 1136.11				
Moment Center Wavenumber = 918.0988				
Percent line at which curve crosses	Wavenumber (cm ⁻¹)		Microns	
0.10%	838.0370		11.9326	
1.00%	849.7668		11.7679	
5.00%	860.1144		11.6264	
10.00%	864.0668		11.5732	
20.00%	868.0944		11.5195	

50.00%	874.7200	11.4322		
80.00%	880.2962	11.3598		
80.00%	908.2819	11.0098		
80.00%	924.7404	10.8138		
80.00%	946.7678	10.5623		
50.00%	963.0641	10.3835		
20.00%	972.3547	10.2843		
10.00%	976.4735	10.2409		
5.00%	980.2808	10.2012		
1.00%	989.8929	10.1021		
0.10%	1002.6329	9.9737		
Area Point Limits	Lower (cm⁻¹)	Upper (cm⁻¹)		
99%	861.2554	978.3790		
96%	869.7151	970.3984		
70%	885.6159	951.2598		
50%	893.6577	941.3195		
0% (area center)	917.2289	917.2289		
Crossing	Lower (cm⁻¹)	Upper (cm⁻¹)	Width (cm⁻¹)	Center (cm⁻¹)
80%	880.2962	908.2819	27.9857	894.2891
50%	874.7200	963.0641	88.3441	918.8921
20%	868.0944	972.3547	104.2604	920.2245
5%	860.1144	980.2808	120.1663	920.1976
Channel 5				
The peak wavenumber was at 847.17 and had a value of 1.00				
File starting point is at wavenumber = 714.30				
File ending point is at wavenumber = 999.83				

Moment Center Wavenumber = 835.8113					
Percent line at which curve crosses		Wavenumber (cm ⁻¹)		Microns	
0.10%		781.7126		12.7924	
1.00%		787.1038		12.7048	
5.00%		792.4706		12.6188	
10.00%		794.8277		12.5813	
20.00%		796.8310		12.5497	
50.00%		800.3292		12.4949	
80.00%		835.7595		11.9652	
80.00%		864.6932		11.5648	
50.00%		867.7961		11.5234	
20.00%		870.8019		11.4837	
10.00%		872.4260		11.4623	
5.00%		873.9822		11.4419	
1.00%		877.1592		11.4004	
0.10%		879.9058		11.3649	
Area Point Limits		Lower (cm ⁻¹)		Upper (cm ⁻¹)	
99%		793.7488		871.7234	
96%		798.5004		868.4430	
70%		810.0130		859.0152	
50%		818.3465		853.0479	
0% (area center)		838.1255		838.1255	
Crossing	Lower (cm ⁻¹)	Upper (cm ⁻¹)		Width (cm ⁻¹)	Center (cm ⁻¹)
80%	835.7595	864.6932		28.9338	850.2264
50%	800.3292	867.7961		67.4669	834.0626

20%	796.831 0	870.8019	73.9709	833.8165
5%	792.470 6	873.9822	81.5116	833.2264

Table D.2-12 contains the radiance-to-temperature coefficients for NOAA-16 AVHRR/3 Channels 3B, 4 and 5.

Table D.2-12. NOAA-16 AVHRR/3 Thermal Channel Radiance-to-Temperature Coefficients.			
	ν_c	A	B
Channel 3B	2700.1148	1.592459	0.998147
Channel 4	917.2289	0.332380	0.998522
Channel 5	838.1255	0.674623	0.998363

Figures D.2-1 through D.2-6 contains the spectral response curves for NOAA-16 AVHRR/3 Channels 1, 2, 3A, 3B, 4 and 5, respectively.

Figure D.2-1. Spectral Response Curve for NOAA-16 AVHRR/3 Channel 1.

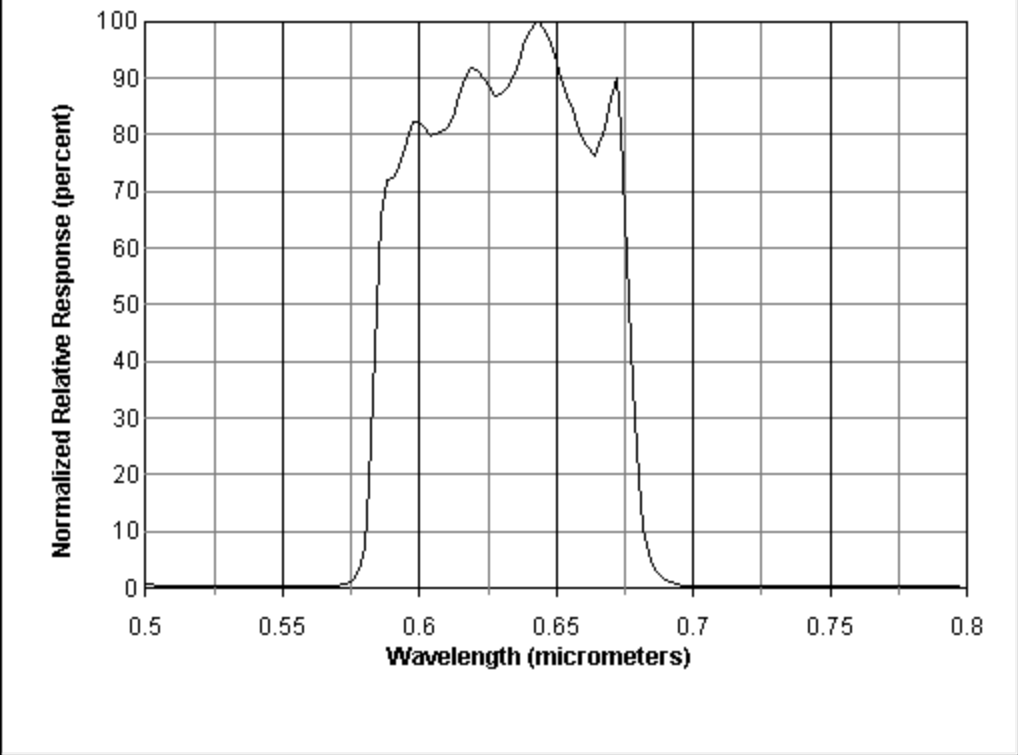

Figure D.2-1. Spectral Response Curve for NOAA-16 Channel 1.

Figure D.2-2. Spectral Response Curve for NOAA-16 AVHRR/3 Channel 2.

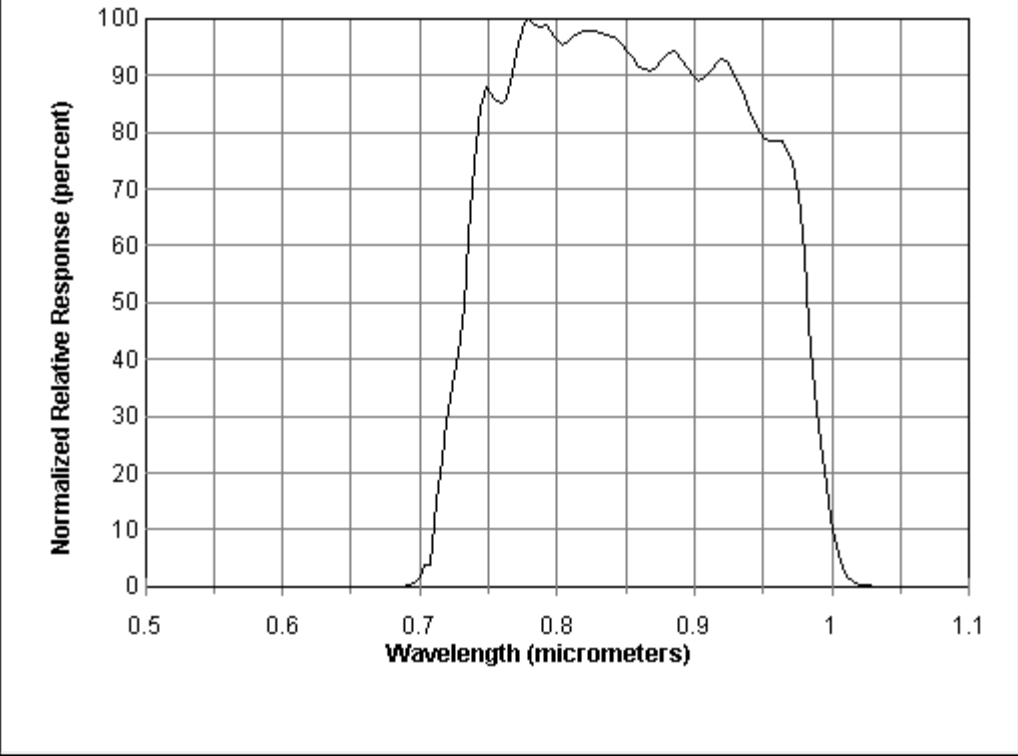

Figure D.2-1. Spectral Response Curve for NOAA-16 Channel 2.

Figure D.2-3. Spectral Response Curve for NOAA-16 AVHRR/3 Channel 3A.

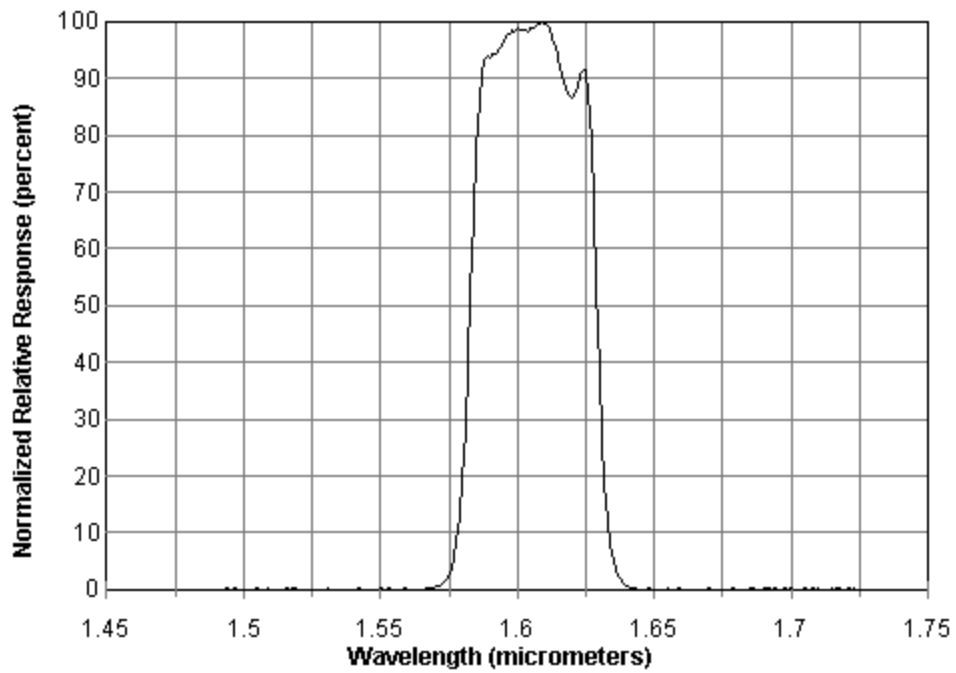

Figure D.2-3. Spectral Response Curve for NOAA-16 Channel 3A.

Figure D.2-4. Spectral Response Curve for NOAA-16 AVHRR/3 Channel 3B.

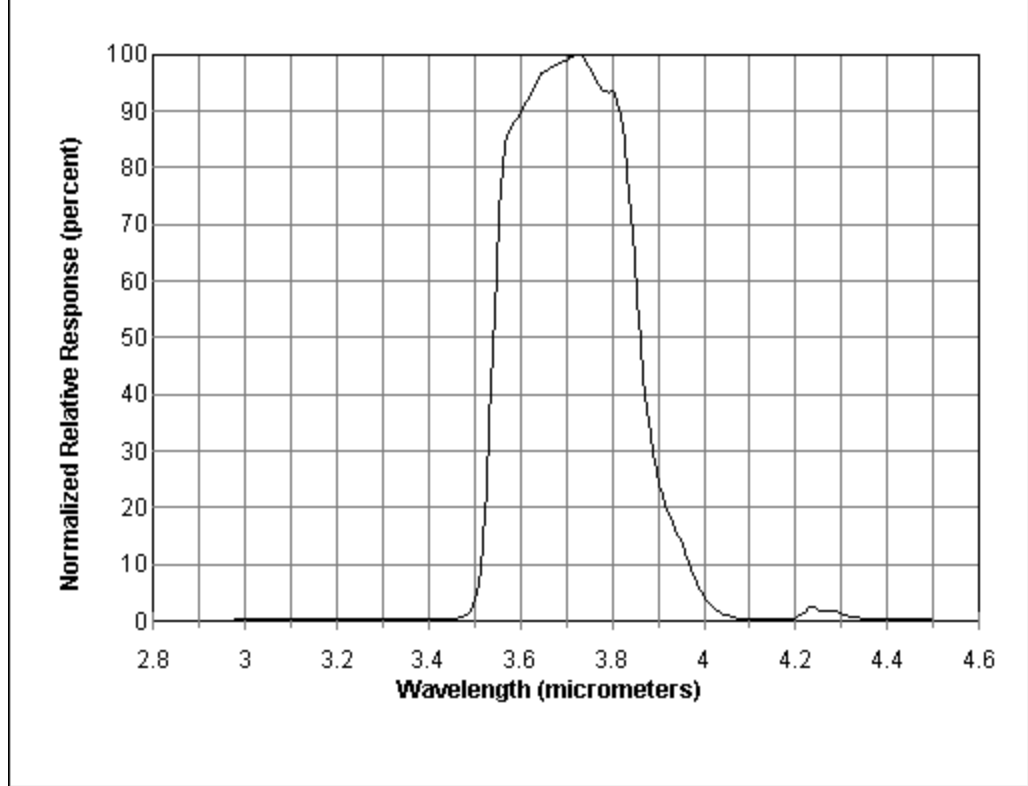

Figure D.2-4. Spectral Response Curve for NOAA-16 Channel 3B.

Figure D.2-5. Spectral Response Curve for NOAA-16 AVHRR/3 Channel 4.

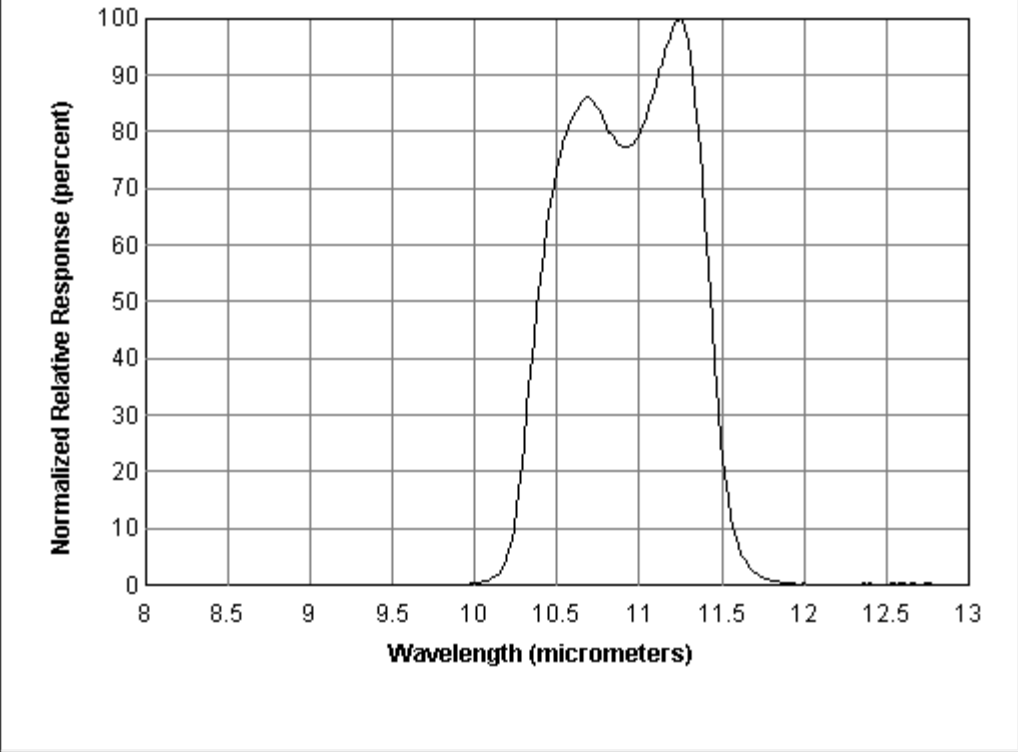

Figure D.2-5. Spectral Response Curve for NOAA-16 Channel 4.

Figure D.2-6. Spectral Response Curve for NOAA-16 AVHRR/3 Channel 5.

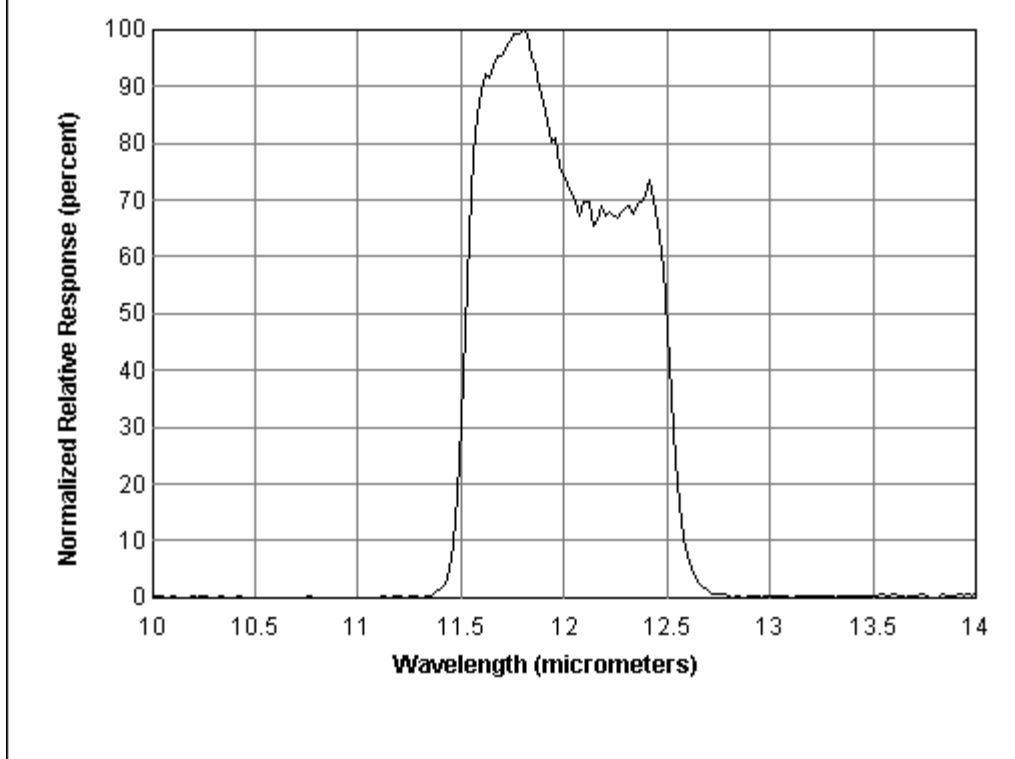

Figure D.2-6. Spectral Response Curve for NOAA-16 Channel 5.

Tables D.2-13 and D.2-14 contain the corresponding spectral response values for NOAA-16 AVHRR/3 Channels 1, 2, 3A and Channels 3B, 4 and 5, respectively. Note: Negative response values were caused by system response noise and are to be ignored but are included in the table for completeness.

Channel 1		Channel 2		Channel 3A	
Wavelength (μm)	Relative Response (percent)	Wavelength (μm)	Relative Response (percent)	Wavelength (μm)	Relative Response (percent)
0.5	0.57	0.548	0.0009217	1.49	0.0537
0.502	0.5206	0.552	0.01275	1.491	0.03852
0.504	0.5348	0.556	0.0008447	1.492	0.008369
0.506	0.4834	0.56	0.0008116	1.493	0.02181
0.508	0.4692	0.564	0.01292	1.494	0.08357
0.51	0.4861	0.568	0.0007645	1.495	0.02326
0.512	0.4745	0.572	0.000738	1.496	0.0382
0.514	0.4578	0.576	0.0007171	1.497	0.08303
0.516	0.4419	0.58	0.0007006	1.498	0.06686

0.518	0.4278	0.584	0.0006858	1.499	0.006636
0.52	0.3882	0.588	0.0006718	1.5	0.06629
0.522	0.3763	0.592	0.0006585	1.501	0.03645
0.524	0.392	0.596	0.0006476	1.502	0.03791
0.526	0.3536	0.6	0.0006352	1.503	0.00827
0.528	0.3196	0.604	0.01026	1.504	0.05147
0.53	0.3579	0.608	0.0006157	1.505	0.08281
0.532	0.3249	0.612	0.0006082	1.506	0.05166
0.534	0.3182	0.616	0.00876	1.507	0.05191
0.536	0.3314	0.62	0.0005934	1.508	0.03824
0.538	0.3212	0.624	0.0005858	1.509	0.08324
0.54	0.3142	0.628	0.009544	1.51	0.02174
0.542	0.3071	0.632	0.008334	1.511	0.06688
0.544	0.2999	0.636	0.0005725	1.512	0.008352
0.546	0.2922	0.64	0.0005683	1.513	0.02179
0.548	0.305	0.644	0.0005659	1.514	0.0369
0.55	0.2798	0.648	0.000564	1.515	0.0384
0.552	0.292	0.652	0.0005628	1.516	0.08207
0.554	0.2701	0.656	0.008232	1.517	0.05348
0.556	0.2647	0.66	0.008239	1.518	0.08352
0.558	0.2599	0.664	0.0005674	1.519	0.1138
0.56	0.2722	0.668	0.0005624	1.52	0.05347
0.562	0.2687	0.672	0.008057	1.521	0.06694
0.564	0.2635	0.676	0.00796	1.522	0.03715
0.566	0.2752	0.68	0.01634	1.523	0.03692
0.568	0.3026	0.684	0.0246	1.524	0.008345
0.57	0.2985	0.688	0.06602	1.525	0.06839
0.572	0.373	0.692	0.1823	1.526	0.008335
0.574	0.5253	0.696	0.5476	1.527	0.03831
0.576	0.8323	0.7	1.547	1.528	0.03682
0.578	1.524	0.704	3.746	1.529	0.02326
0.58	3.252	0.708	3.783	1.53	0.05182
0.582	7.502	0.712	15.15	1.531	0.1138
0.584	18.84	0.716	22.27	1.532	0.02336
0.586	42.18	0.72	29.15	1.533	0.008347
0.588	65.16	0.724	35.49	1.534	0.006673
0.59	71.88	0.728	41.12	1.535	0.06813
0.592	72.23	0.732	49.23	1.536	0.06812
0.594	73.53	0.736	61.62	1.537	0.03812
0.596	76.47	0.74	74.69	1.538	0.02169
0.598	80.02	0.744	84.49	1.539	0.008314
0.6	82.31	0.748	88.08	1.54	0.02322
0.602	82.36	0.752	86.98	1.541	0.03678

0.604	81.26	0.756	85.67	1.542	0.09657
0.606	79.94	0.76	84.96	1.543	0.008359
0.608	80.17	0.764	85.75	1.544	0.008334
0.61	80.68	0.768	90.44	1.545	0.03814
0.612	81.32	0.772	95.88	1.546	0.0367
0.614	82.93	0.776	99.15	1.547	0.02168
0.616	85.74	0.78	100	1.548	0.02322
0.618	88.96	0.784	99	1.549	0.03828
0.62	91.39	0.788	98.48	1.55	0.08308
0.622	91.78	0.792	98.81	1.551	0.006663
0.624	91.13	0.796	97.76	1.552	0.02164
0.626	89.63	0.8	96.26	1.553	0.08114
0.628	88.27	0.804	95.48	1.554	0.03656
0.63	86.96	0.808	95.9	1.555	0.06662
0.632	87.3	0.812	96.92	1.556	0.0528
0.634	88.09	0.816	97.54	1.557	0.008249
0.636	90.09	0.82	97.89	1.558	0.03775
0.638	92.89	0.824	97.95	1.559	0.09681
0.64	95.77	0.828	97.82	1.56	0.05241
0.642	98.28	0.832	97.39	1.561	0.00657
0.644	99.69	0.836	97.17	1.562	0.06564
0.646	100	0.84	96.88	1.563	0.006539
0.648	98.44	0.844	96.5	1.564	0.006557
0.65	96.05	0.848	95.41	1.565	0.06536
0.652	92.96	0.852	94.11	1.566	0.03618
0.654	89.96	0.856	92.82	1.567	0.09521
0.656	87	0.86	91.56	1.568	0.09451
0.658	84.48	0.864	90.99	1.569	0.1528
0.66	80.95	0.868	90.82	1.57	0.2989
0.662	78.94	0.872	91.47	1.571	0.4466
0.664	77.57	0.876	92.42	1.572	0.6958
0.666	76.26	0.88	93.73	1.573	1.149
0.668	78.22	0.884	94.27	1.574	1.679
0.67	81.11	0.888	94	1.575	2.572
0.672	86.61	0.892	92.74	1.576	3.903
0.674	89.93	0.896	91.1	1.577	6.064
0.676	80.94	0.9	89.7	1.578	8.84
0.678	58.36	0.904	89.09	1.579	12.9
0.68	35.61	0.908	89.62	1.58	19.52
0.682	19.35	0.912	90.82	1.581	28.04
0.684	10.54	0.916	92.18	1.582	39.95
0.686	5.841	0.92	92.95	1.583	52.41
0.688	3.33	0.924	92.47	1.584	65.39

0.69	2.067	0.928	90.8	1.585	77.65
0.692	1.327	0.932	88.71	1.586	86.15
0.694	0.8728	0.936	86.23	1.587	91.05
0.696	0.6101	0.94	84.1	1.588	93.34
0.698	0.4574	0.944	81.46	1.589	93.82
0.7	0.3484	0.948	79.88	1.59	93.72
0.702	0.2887	0.952	78.94	1.591	94.3
0.704	0.2651	0.956	78.5	1.592	94.2
0.706	0.2304	0.96	78.63	1.593	94.98
0.708	0.2191	0.964	78.37	1.594	95.39
0.71	0.2069	0.968	77.08	1.595	96.66
0.712	0.4465	0.972	74.46	1.596	97.4
0.714	0.3634	0.976	68.98	1.597	97.85
0.716	0.3416	0.98	58.76	1.598	98.59
0.718	0.3066	0.984	46.04	1.599	98.32
0.72	0.2626	0.988	34.41	1.6	98.75
0.722	0.2623	0.992	25.14	1.601	98.43
0.724	0.2315	0.996	17.91	1.602	98.55
0.726	0.2391	1	11.79	1.603	98.48
0.728	0.2309	1.004	6.935	1.604	98.2
0.73	0.2097	1.008	3.596	1.605	98.96
0.732	0.2215	1.012	1.719	1.606	98.8
0.734	0.2035	1.016	0.8083	1.607	99.37
0.736	0.2015	1.02	0.3846	1.608	99.49
0.738	0.2152	1.024	0.1808	1.609	100
0.74	0.2003	1.028	0.08314	1.61	99.69
0.742	0.1999	1.032	0.03937	1.611	99.36
0.744	0.202	1.036	0.02018	1.612	98.84
0.746	0.2026	1.04	0.006693	1.613	97.28
0.748	0.203	1.044	0.01448	1.614	95.65
0.75	0.2041	1.048	0.0005044	1.615	93.83
0.752	0.2198	1.052	0.008709	1.616	91.84
0.754	0.2068	1.056	0.009167	1.617	89.42
0.756	0.209	1.06	0.008585	1.618	88.24
0.758	0.2272	1.064	0.01021	1.619	86.97
0.76	0.2457	1.068	0.0006362	1.62	86.67
0.762	0.2168	-	-	1.621	87.43
0.764	0.2189	-	-	1.622	88.32
0.766	0.2367	-	-	1.623	90.93
0.768	0.2393	-	-	1.624	91.26
0.77	0.2263	-	-	1.625	91.52
0.772	0.2294	-	-	1.626	87.36
0.774	0.234	-	-	1.627	79.17

0.776	0.2357	-	-	1.628	67.63
0.778	0.2557	-	-	1.629	53.04
0.78	0.2419	-	-	1.63	38.75
0.782	0.2623	-	-	1.631	26.68
0.784	0.2482	-	-	1.632	18.46
0.786	0.2516	-	-	1.633	12.19
0.788	0.2915	-	-	1.634	7.939
0.79	0.2587	-	-	1.635	5.244
0.792	0.2624	-	-	1.636	3.502
0.794	0.2657	-	-	1.637	2.3
0.796	0.25	-	-	1.638	1.465
0.798	0.2935	-	-	1.639	0.9057
0.8	0.2765	-	-	1.64	0.6118
-	-	-	-	1.641	0.3081
-	-	-	-	1.642	0.1917
-	-	-	-	1.643	0.1434
-	-	-	-	1.644	0.05841
-	-	-	-	1.645	0.007548
-	-	-	-	1.646	0.05856
-	-	-	-	1.647	0.009507
-	-	-	-	1.648	0.07618
-	-	-	-	1.649	0.007657
-	-	-	-	1.65	0.007598
-	-	-	-	1.651	0.007659
-	-	-	-	1.652	0.007634
-	-	-	-	1.653	0.02508
-	-	-	-	1.654	0.009623
-	-	-	-	1.655	0.0784
-	-	-	-	1.656	0.06095
-	-	-	-	1.657	0.0258
-	-	-	-	1.658	0.02604
-	-	-	-	1.659	0.09817
-	-	-	-	1.66	0.01011
-	-	-	-	1.661	0.00813
-	-	-	-	1.662	0.04527
-	-	-	-	1.663	0.04573
-	-	-	-	1.664	0.01052
-	-	-	-	1.665	0.04659
-	-	-	-	1.666	0.06697
-	-	-	-	1.667	0.02816
-	-	-	-	1.668	0.04816
-	-	-	-	1.669	0.04809
-	-	-	-	1.67	0.0878

-	-	-	-	1.671	0.048
-	-	-	-	1.672	0.03052
-	-	-	-	1.673	0.06878
-	-	-	-	1.674	0.04947
-	-	-	-	1.675	0.04717
-	-	-	-	1.676	0.008532
-	-	-	-	1.677	0.04646
-	-	-	-	1.678	0.04651
-	-	-	-	1.679	0.103
-	-	-	-	1.68	0.04638
-	-	-	-	1.681	0.02753
-	-	-	-	1.682	0.04659
-	-	-	-	1.683	0.01064
-	-	-	-	1.684	0.02977
-	-	-	-	1.685	0.08817
-	-	-	-	1.686	0.08652
-	-	-	-	1.687	0.008712
-	-	-	-	1.688	0.01086
-	-	-	-	1.689	0.05013
-	-	-	-	1.69	0.165
-	-	-	-	1.691	0.08727
-	-	-	-	1.692	0.08697
-	-	-	-	1.693	0.06952
-	-	-	-	1.694	0.0886
-	-	-	-	1.695	0.0284
-	-	-	-	1.696	0.06929
-	-	-	-	1.697	0.0109
-	-	-	-	1.698	0.06978
-	-	-	-	1.699	0.05048
-	-	-	-	1.7	0.109
-	-	-	-	1.701	0.05027
-	-	-	-	1.702	0.008691
-	-	-	-	1.703	0.02863
-	-	-	-	1.704	0.04805
-	-	-	-	1.705	0.07001
-	-	-	-	1.706	0.02835
-	-	-	-	1.707	0.06795
-	-	-	-	1.708	0.06986
-	-	-	-	1.709	0.01095
-	-	-	-	1.71	0.08892
-	-	-	-	1.711	0.02845
-	-	-	-	1.712	0.01084
-	-	-	-	1.713	0.02853

-	-	-	-	1.714	0.02832
-	-	-	-	1.715	0.08753
-	-	-	-	1.716	0.008721
-	-	-	-	1.717	0.1095
-	-	-	-	1.718	0.1285
-	-	-	-	1.719	0.008791
-	-	-	-	1.72	0.0502
-	-	-	-	1.721	0.1474
-	-	-	-	1.722	0.008758
-	-	-	-	1.723	0.08986
-	-	-	-	1.724	0.06793
-	-	-	-	1.725	0.03057
-	-	-	-	1.726	0.01099
-	-	-	-	1.727	0.01091
-	-	-	-	1.728	0.04823
-	-	-	-	1.729	0.05017

Table D.2-14. NOAA-16 AVHRR/3 Spectral Response Values for Channels 3B, 4 and 5.

Channel 3B		Channel 4		Channel 5	
Wavelength (µm)	Relative Response (percent)	Wavelength (µm)	Relative Response (percent)	Wavelength (µm)	Relative Response (percent)
2.98	0.1654	8.8	0.04117	10	0.02937
2.987	0.1703	8.82	0.01924	10.02	0.07734
2.994	0.1725	8.84	0.04717	10.04	0.07055
3.001	0.1673	8.86	0.003491	10.06	0.04776
3.008	0.1666	8.88	0.04397	10.08	0.02985
3.015	0.1726	8.9	0.002543	10.1	0.09145
3.022	0.1758	8.92	0.048	10.12	0.03551
3.029	0.1739	8.94	0.0442	10.14	0.05787
3.036	0.1746	8.96	0.0145	10.16	0.01822
3.043	0.1707	8.98	0.01618	10.18	0.02887
3.05	0.1769	9	0.02232	10.2	0.1602
3.057	0.1718	9.02	0.001838	10.22	0.0198
3.064	0.167	9.04	0.01864	10.24	0.2532
3.071	0.1775	9.06	3.391E-05	10.26	0.07825
3.078	0.1744	9.08	0.01591	10.28	0.04656
3.085	0.1765	9.1	0.002684	10.3	0.007658
3.092	0.1709	9.12	0.02209	10.32	0.0656
3.099	0.1775	9.14	0.01536	10.34	0.116
3.106	0.1764	9.16	0.01242	10.36	0.05873
3.113	0.17	9.18	0.0138	10.38	0.04152

3.12	0.1755	9.2	0.02595	10.4	0.02858
3.127	0.1767	9.22	0.01551	10.42	0.09357
3.134	0.1717	9.24	0.02575	10.44	0.02663
3.141	0.1726	9.26	0.009519	10.46	0.03183
3.148	0.1738	9.28	0.01208	10.48	0.0302
3.155	0.1722	9.3	0.01669	10.5	0.02125
3.162	0.17	9.32	0.01116	10.52	0.0219
3.169	0.171	9.34	0.02586	10.54	0.01023
3.176	0.1726	9.36	0.02407	10.56	0.02519
3.183	0.1741	9.38	0.02301	10.58	0.02666
3.19	0.1798	9.4	0.02597	10.6	0.05071
3.197	0.1845	9.42	0.03809	10.62	0.003169
3.204	0.184	9.44	0.01726	10.64	0.05413
3.211	0.1847	9.46	0.005527	10.66	0.01799
3.218	0.1812	9.48	0.03188	10.68	0.03836
3.225	0.1882	9.5	0.04163	10.7	0.007837
3.232	0.1895	9.52	0.03399	10.72	0.03617
3.239	0.191	9.54	0.02249	10.74	0.02692
3.246	0.1876	9.56	0.0265	10.76	0.09022
3.253	0.1872	9.58	0.02301	10.78	0.03202
3.26	0.1925	9.6	0.007256	10.8	0.06905
3.267	0.1876	9.62	0.02027	10.82	0.006147
3.274	0.1933	9.64	0.04002	10.84	0.01898
3.281	0.1958	9.66	0.02687	10.86	0.002895
3.288	0.1953	9.68	0.03055	10.88	0.007603
3.295	0.2005	9.7	0.04923	10.9	0.02369
3.302	0.1996	9.72	0.02382	10.92	0.03007
3.309	0.2009	9.74	0.02945	10.94	0.05507
3.316	0.2057	9.76	0.01785	10.96	0.02063
3.323	0.2049	9.78	0.01405	10.98	0.06856
3.33	0.2029	9.8	0.02257	11	0.06138
3.337	0.2008	9.82	0.0008725	11.02	0.05133
3.344	0.2045	9.84	0.005166	11.04	0.03869
3.351	0.1999	9.86	0.0005744	11.06	0.06096
3.358	0.2004	9.88	0.0003771	11.08	0.0183
3.365	0.2072	9.9	0.01965	11.1	0.06192
3.372	0.2034	9.92	0.04839	11.12	0.2351
3.379	0.2057	9.94	0.1108	11.14	0.02473
3.386	0.2038	9.96	0.1252	11.16	0.05452
3.393	0.1999	9.98	0.1882	11.18	0.1064
3.4	0.2032	10	0.2622	11.2	0.1091
3.407	0.2111	10.02	0.3417	11.22	0.007303
3.414	0.2177	10.04	0.4417	11.24	0.02762

3.421	0.2201	10.06	0.6055	11.26	0.1111
3.428	0.2284	10.08	0.7726	11.28	0.1176
3.435	0.2358	10.1	1.034	11.3	0.0568
3.442	0.2556	10.12	1.361	11.32	0.03093
3.449	0.2656	10.14	1.858	11.34	0.402
3.456	0.29	10.16	2.54	11.36	0.1885
3.463	0.3725	10.18	3.555	11.38	0.7873
3.47	0.5539	10.2	4.964	11.4	1.162
3.477	0.7465	10.22	7.043	11.42	2.296
3.484	1.144	10.24	9.908	11.44	4.854
3.491	1.82	10.26	13.82	11.46	9.392
3.498	2.922	10.28	18.91	11.48	18.1
3.505	5.063	10.3	24.58	11.5	30.84
3.512	8.649	10.32	31.33	11.52	47.15
3.519	14.44	10.34	37.76	11.54	64.03
3.526	23.26	10.36	43.5	11.56	77.74
3.533	34.93	10.38	49.17	11.58	85.24
3.54	48.15	10.4	53.99	11.6	89.03
3.547	61.52	10.42	58.97	11.62	92.05
3.554	72.24	10.44	63.41	11.64	91.58
3.561	80.12	10.46	67.3	11.66	93.65
3.568	84.44	10.48	70.68	11.68	95.29
3.575	86.44	10.5	73.39	11.7	95.46
3.582	87.15	10.52	75.81	11.72	96.61
3.589	88.14	10.54	78.03	11.74	97.86
3.596	88.8	10.56	79.84	11.76	99.06
3.603	89.99	10.58	81.75	11.78	99.09
3.61	91.3	10.6	82.57	11.8	100
3.617	92.15	10.62	83.68	11.82	99.04
3.624	93.17	10.64	85.04	11.84	95.43
3.631	94.36	10.66	85.63	11.86	93.53
3.638	95.29	10.68	86.19	11.88	89.68
3.645	96.61	10.7	85.66	11.9	87.2
3.652	96.84	10.72	85.5	11.92	83.84
3.659	97.04	10.74	84.34	11.94	80.32
3.666	97.77	10.76	83.69	11.96	80.98
3.673	97.74	10.78	82.6	11.98	76.1
3.68	98.27	10.8	81.12	12	74.58
3.687	98.51	10.82	79.78	12.02	73.01
3.694	98.87	10.84	79.6	12.04	71.19
3.701	98.99	10.86	78.4	12.06	69.83
3.708	99.64	10.88	77.8	12.08	67.27
3.715	99.66	10.9	77.27	12.1	69.57

3.722	99.73	10.92	77.35	12.12	69.48
3.729	99.86	10.94	77.29	12.14	65.3
3.736	100	10.96	77.8	12.16	66.33
3.743	99	10.98	78.8	12.18	69.04
3.75	97.74	11	79.2	12.2	67.24
3.757	96.7	11.02	81.17	12.22	67.87
3.764	95.66	11.04	82.72	12.24	67.21
3.771	94.58	11.06	84.46	12.26	66.73
3.778	93.66	11.08	86.13	12.28	67.86
3.785	93.55	11.1	88.36	12.3	68.48
3.792	93.33	11.12	91.13	12.32	68.96
3.799	93.42	11.14	91.97	12.34	67.45
3.806	93.25	11.16	94.58	12.36	69.21
3.813	91.57	11.18	95.74	12.38	69.62
3.82	89.14	11.2	98.24	12.4	70.94
3.827	84.82	11.22	99.04	12.42	73.69
3.834	79.09	11.24	99.49	12.44	69.94
3.841	72.07	11.26	100	12.46	66.22
3.848	64.42	11.28	98.23	12.48	58.07
3.855	56.67	11.3	96.21	12.5	47.19
3.862	49.25	11.32	90.57	12.52	35.37
3.869	42.95	11.34	85.84	12.54	24.32
3.876	37.53	11.36	80	12.56	16.42
3.883	32.88	11.38	72.38	12.58	10.46
3.89	29.71	11.4	64.48	12.6	7.235
3.897	26.39	11.42	55.65	12.62	5.045
3.904	23.96	11.44	46.72	12.64	3.299
3.911	22.13	11.46	38.93	12.66	2.273
3.918	20.46	11.48	30.91	12.68	1.526
3.925	18.99	11.5	25.55	12.7	1.296
3.932	17.66	11.52	19.92	12.72	0.685
3.939	16.26	11.54	15.15	12.74	0.4391
3.946	14.82	11.56	11.94	12.76	0.4868
3.953	13.61	11.58	9.191	12.78	0.5813
3.96	12.06	11.6	7.138	12.8	0.07625
3.967	10.55	11.62	5.432	12.82	0.01172
3.974	9.093	11.64	4.445	12.84	0.211
3.981	7.765	11.66	3.482	12.86	0.04112
3.988	6.488	11.68	2.775	12.88	0.01416
3.995	5.391	11.7	2.244	12.9	0.1362
4.002	4.337	11.72	1.764	12.92	0.1941
4.009	3.562	11.74	1.319	12.94	0.1859
4.016	2.834	11.76	1.156	12.96	0.04048

4.023	2.269	11.78	0.9063	12.98	0.234
4.03	1.825	11.8	0.7492	13	0.2721
4.037	1.448	11.82	0.6211	13.02	0.113
4.044	1.11	11.84	0.4987	13.04	0.08682
4.051	0.9136	11.86	0.4415	13.06	0.201
4.058	0.7362	11.88	0.2232	13.08	0.227
4.065	0.5443	11.9	0.286	13.1	0.002984
4.072	0.4453	11.92	0.1861	13.12	0.005483
4.079	0.396	11.94	0.159	13.14	0.1234
4.086	0.3838	11.96	0.06477	13.16	0.2436
4.093	0.3667	11.98	0.01099	13.18	0.2724
4.1	0.3513	12	0.2749	13.2	0.2104
4.107	0.3285	12.02	0.05741	13.22	0.1871
4.114	0.3294	12.04	0.004477	13.24	0.3482
4.121	0.3215	12.06	0.0382	13.26	0.1118
4.128	0.3161	12.08	0.0917	13.28	0.1136
4.135	0.3184	12.1	0.03619	13.3	0.2146
4.142	0.3049	12.12	0.03377	13.32	0.04151
4.149	0.3155	12.14	0.06481	13.34	0.222
4.156	0.3081	12.16	0.00666	13.36	0.1038
4.163	0.3133	12.18	0.03509	13.38	0.2016
4.17	0.3187	12.2	0.06484	13.4	0.2138
4.177	0.3156	12.22	0.04031	13.42	0.1918
4.184	0.3395	12.24	0.09656	13.44	0.1228
4.191	0.3898	12.26	0.09378	13.46	0.1743
4.198	0.4837	12.28	0.03911	13.48	0.4151
4.205	0.6309	12.3	0.09452	13.5	0.1992
4.212	0.9046	12.32	0.08377	13.52	0.2626
4.219	1.491	12.34	0.1116	13.54	0.4243
4.226	2.118	12.36	0.1765	13.56	0.08
4.233	2.581	12.38	0.06529	13.58	0.1626
4.24	2.362	12.4	0.1577	13.6	0.483
4.247	1.987	12.42	0.03291	13.62	0.3594
4.254	1.647	12.44	0.122	13.64	0.1082
4.261	1.682	12.46	0.07161	13.66	0.06156
4.268	1.728	12.48	0.06482	13.68	0.2142
4.275	1.769	12.5	0.06668	13.7	0.3273
4.282	1.753	12.52	0.0806	13.72	0.1629
4.289	1.65	12.54	0.1944	13.74	0.7332
4.296	1.35	12.56	0.1246	13.76	0.1875
4.303	1.187	12.58	0.2207	13.78	0.01638
4.31	0.9481	12.6	0.1404	13.8	0.01017
4.317	0.7979	12.62	0.05396	13.82	0.05905

4.324	0.6702	12.64	0.03767	13.84	0.5814
4.331	0.5792	12.66	0.2027	13.86	0.2973
4.338	0.5311	12.68	0.06821	13.88	0.3569
4.345	0.466	12.7	0.03431	13.9	0.2746
4.352	0.4357	12.72	0.1023	13.92	0.4363
4.359	0.4089	12.74	0.1454	13.94	0.33
4.366	0.3879	12.76	0.2073	13.96	0.5779
4.373	0.3835	12.78	0.09976	13.98	0.4046
4.38	0.3695	12.8	0.08722	14	0.58
4.387	0.3631	-	-	-	-
4.394	0.3728	-	-	-	-
4.401	0.3787	-	-	-	-
4.408	0.378	-	-	-	-
4.415	0.3752	-	-	-	-
4.422	0.3791	-	-	-	-
4.429	0.3714	-	-	-	-
4.436	0.3779	-	-	-	-
4.443	0.3722	-	-	-	-
4.45	0.3683	-	-	-	-
4.457	0.378	-	-	-	-
4.464	0.3687	-	-	-	-
4.471	0.3674	-	-	-	-
4.478	0.3773	-	-	-	-
4.485	0.3738	-	-	-	-
4.492	0.3701	-	-	-	-
4.499	0.3793	-	-	-	-

Table D.2-15. NOAA-16 Radiance of Space and Coefficients for Nonlinear Radiance Correction Quadratic.

	N_s	b_0	b_1	b_2
Channel 4	-2.467	2.96	-0.05411	0.00024532
Channel 5	-2.009	2.25	-0.03665	0.00014854

Table D.2-16. NOAA-16 AMSU PRT Temperature Conversion Coefficients.

	Coefficient 0	Coefficient 1	Coefficient 2	Coefficient 3
A1-1 Warm Load 1 Temperature	0.254013E+03	0.163931E-02	0.584185E-08	0.317000E-13
A1-1 Warm Load 2 Temperature	0.254145E+03	0.163995E-02	0.578292E-08	0.326324E-13
A1-1 Warm Load 3 Temperature	0.253995E+03	0.163895E-02	0.580019E-08	0.324197E-13
A1-1 Warm Load 4 Temperature	0.254049E+03	0.163956E-02	0.575803E-08	0.330704E-13
A1-1 Warm Load Center Temperature	0.254342E+03	0.164056E-02	0.583578E-08	0.318204E-13
A1-2 Warm Load 1 Temperature	0.254040E+03	0.163924E-02	0.582252E-08	0.322464E-13
A1-2 Warm Load 2 Temperature	0.254015E+03	0.164199E-02	0.602700E-08	0.253719E-13
A1-2 Warm Load 3 Temperature	0.253985E+03	0.163733E-02	0.586394E-08	0.309496E-13
A1-2 Warm Load 4 Temperature	0.253963E+03	0.164377E-02	0.556198E-08	0.367514E-13
A1-2 Warm Load Center Temperature	0.254092E+03	0.164010E-02	0.576571E-08	0.327630E-13
A2 Warm Load Center Temp. Conv.	0.254067E+03	0.168755E-02	0.635299E-08	0.314942E-13
A2 Warm Load 1 Temp. Conv.	0.254036E+03	0.168879E-02	0.633452E-08	0.319937E-13

A2 Warm Load 2 Temp. Conv.	0.254065E+03	0.169063E-02	0.626744E-08	0.330192E-13
A2 Warm Load 3 Temp. Conv	0.253925E+03	0.168618E-02	0.637656E-08	0.304957E-13
A2 Warm Load 4 Temp. Conv.	0.254015E+03	0.168923E-02	0.635827E-08	0.315266E-13
A2 Warm Load 5 Temp. Conv.	0.254001E+03	0.168825E-02	0.636131E-08	0.312040E-13
A2 Warm Load 6 Temp. Conv.	0.254025E+03	0.168659E-02	0.642390E-08	0.302105E-13
AMSU-B Calibration Target Temperature 1	0.262010E+03	0.765200E-03	0.122300E-08	0.257000E-14
AMSU-B Calibration Target Temperature 2	0.261970E+03	0.764500E-03	0.122400E-08	0.254000E-14
AMSU-B Calibration Target Temperature 3	0.261950E+03	0.765400E-03	0.123000E-08	0.248000E-14
AMSU-B Calibration Target Temperature 4	0.261920E+03	0.764600E-03	0.122700E-08	0.255000E-14
AMSU-B Calibration Target Temperature 5	0.262150E+03	0.765500E-03	0.123100E-08	0.251000E-14
AMSU-B Calibration Target Temperature 6	0.261910E+03	0.765700E-03	0.116100E-08	0.329000E-14
AMSU-B Calibration Target Temperature 7	0.261900E+03	0.762800E-03	0.131800E-08	0.133000E-14

D.3 NOAA-17 (M)

Launch date: June 24, 2002

Operational dates: October 15, 2002 - present

Morning orbit: 2200 LST ascending node, 1000 LST descending node

AVHRR instrument: 6 channels (AVHRR/3)

Spacecraft ID: 6

Abnormalities:

Up to date information regarding abnormalities on the POES spacecraft and instruments can be found at: <http://www.oso.noaa.gov/poesstatus/>. This website allows a user to search and sort on any POES spacecraft, subsystem or instrument status. Once a user narrows down their window of interest, further details can be obtained by going to the NOAA/NESDIS/Office of Satellite Operations' (OSO) archive of weekly status reports at: <http://noaasis.noaa.gov/NOAASIS/ml/podocs.html>.

AVHRR:

Table D.3-1 contains the PRT weighting factors for NOAA-17.

Table D.3-1. NOAA-17 PRT Weighting Factors			
b₁	b₂	b₃	b₄
.25	.25	.25	.25

Table D.3-2. NOAA-17 Radiance of Space and Coefficients for Nonlinear Radiance Correction Quadratic.				
	N_S	b₀	b₁	b₂
Channel 4	-8.55	8.22	-0.15795	0.00075579
Channel 5	-3.97	4.31	-0.07318	0.00030976

Table D.3-3 contains NOAA-17 coefficients d₀, d₁, d₂, d₃ and d₄ that relate temperature, T_{PRT} (Kelvin) of each PRT to count value, C_{PRT}, by the equation:

$$T_{PRT} = d_0 + d_1 C_{PRT} + d_2 C_{PRT}^2 + d_3 C_{PRT}^3 + d_4 C_{PRT}^4$$

PRT	d₀	d₁	d₂	d₃	d₄
1	276.628	0.05098	1.371 E-06	0	0
2	276.538	0.05098	1.371 E-06	0	0
3	276.761	0.05097	1.369 E-06	0	0
4	276.660	0.05100	1.348 E-06	0	0

Table D.3-4 contains the pre-launch calibration coefficients (albedo representation) for the AVHRR/3 instrument on NOAA-17.

Channel #	Contents	Slope	Intercept
1	Low albedo range (0-25%)	0.0555	-2.2193
	High albedo range (26 - 100%)	0.1627	-55.9635
2	Low albedo range (0-25%)	0.0543	-2.1227
	High albedo range (26 - 100%)	0.1621	-56.2160
3A	Low albedo range (0-12.5%)	0.0265	-1.1153
	High albedo range (12.6 - 100%)	0.1860	-81.2520

Note: The albedo ranges given in parentheses are nominal; the points of intersection of the two regression lines are located at 497.53, 500.32, and 498.66 counts for channels 1,2, and 3A respectively. This information is based on the data in Instruction Manual and Alignment/Calibration Handbook and Optical Data, submitted to NASA/GSFC by ITT Aerospace/Communications (Report 8172845, Rev B), January 2002.

Table D.3-5 contains a summary of the spectral response data as a function of wavenumber for all channels of the NOAA-17 AVHRR/3.

Channel 1		
The peak wavenumber was at 15460.00 and had a value of 1.00		
File starting point is at wavenumber = 12050.00		
File ending point is at wavenumber = 23250.00		
Moment Center Wavenumber = 15815.3133		
Percent line at which curve crosses	Wavenumber (cm⁻¹)	μm
0.10%	14197.7285	0.7043
1.00%	14383.6572	0.6952
5.00%	14505.8613	0.6894
10.00%	14559.2041	0.6869
20.00%	14617.2354	0.6841
50.00%	14703.6748	0.6801
80.00%	14778.9727	0.6766
80.00%	16630.6680	0.6013

50.00%	16968.5859	0.5893		
20.00%	17075.4141	0.5856		
10.00%	17123.4551	0.5840		
5.00%	17168.1836	0.5825		
1.00%	17279.4473	0.5787		
0.10%	17458.8906	0.5728		
Area Point Limits	Lower (cm⁻¹)	Upper (cm⁻¹)		
99%	14576.6921	17106.1116		
96%	14691.0247	16991.0894		
70%	15029.2533	16587.7738		
50%	15261.1488	16345.9996		
0% (area center)	15791.0042	15791.0042		
Crossing	Lower(cm⁻¹)	Upper (cm⁻¹)	Width (cm⁻¹)	Center(cm⁻¹)
80%	14778.9727	16630.6680	1851.6953	15704.8203
50%	14703.6748	16968.5859	2264.9111	15836.1309
20%	14617.2354	17075.4141	2458.1787	15846.3242
0 5%	14505.8613	17168.1836	2662.3223	15837.0225
Channel 2				
The peak wavenumber was at 12150.00 and had a value of 1.00				
File starting point is at wavenumber = 9330.00				
File ending point is at wavenumber = 19995.00				
Moment Center Wavenumber = 11976.9574				
Percent line at which curve crosses	Wavenumber (cm⁻¹)		µm	
0.10%	9447.9365		1.0584	
1.00%	9898.8965		1.0102	
5.00%	9980.9414		1.0019	
10.00%	10007.1953		0.9993	
20.00%	10035.3643		0.9965	
50.00%	10123.3047		0.9878	
80.00%	10618.1885		0.9418	
80.00%	13345.3174		0.7493	
50.00%	13629.8096		0.7337	
20.00%	13978.5986		0.7154	
10.00%	14094.9512		0.7095	
5.00%	14168.0088		0.7058	
1.00%	14298.7021		0.6994	
0.10%	14446.0820		0.6922	
Area Point Limits	Lower (cm⁻¹)	Upper (cm⁻¹)		
99%	10056.6330	14035.3655		
96%	10161.0703	13826.4520		
70%	10748.1875	13159.8549		
50%	11124.8997	12811.5372		
0% (area center)	11984.2653	11984.2653		

Crossing	Lower(cm ⁻¹)	Upper (cm ⁻¹)	Width (cm ⁻¹)	Center (cm ⁻¹)
80%	10618.1885	13345.3174	2727.1289	11981.7529
50%	10123.3047	13629.8096	3506.5049	11876.5566
20%	10035.3643	13978.5986	3943.2344	12006.9814
5%	9980.9414	14168.0088	4187.0674	12074.4746
Channel 3A				
The peak wavenumber was at 6155.00 and had a value of 1.00				
File starting point is at wavenumber = 5785.00				
File ending point is at wavenumber = 6705.00				
Moment Center Wavenumber = 6225.8311				
Percent line at which curve crosses		Wavenumber(cm ⁻¹)		μm
0.10%		6001.4897		1.6663
1.00%		6058.3877		1.6506
5.00%		6087.6611		1.6427
10.00%		6099.3330		1.6395
20.00%		6110.1841		1.6366
50.00%		6125.9956		1.6324
80.00%		6138.5308		1.6291
80.00%		6315.0498		1.5835
50.00%		6327.6074		1.5804
20.00%		6342.7637		1.5766
10.00%		6352.5254		1.5742
5.00%		6362.6411		1.5717
1.00%		6387.6782		1.5655
0.10%		6427.3838		1.5558
Area Point Limits	Lower (cm ⁻¹)		Upper (cm ⁻¹)	
99%	6083.4646		6354.2082	
96%	6107.7390		6333.4053	
70%	6147.6866		6294.6314	
50%	6167.9301		6273.3724	
0% (area center)	6220.9686		6220.9686	
Crossing	Lower (cm ⁻¹)	Upper(cm ⁻¹)	Width (cm ⁻¹)	Center (cm ⁻¹)
80%	6138.5308	6315.0498	176.5190	6226.7900
50%	6125.9956	6327.6074	201.6118	6226.7900
20%	6110.1841	6342.7637	232.5796	6226.4736
5%	6087.6611	6362.6411	274.9800	6225.1514
Channel 3B				
The peak wavenumber was at 2676.00 and had a value of 1.00				
File starting point is at wavenumber = 2222.80				
File ending point is at wavenumber = 3355.50				
Moment Center Wavenumber = 2670.7832				
Percent line at which curve crosses		Wavenumber (cm ⁻¹)		μm

0.10%	2450.6682	4.0805		
1.00%	2484.3210	4.0252		
5.00%	2504.6335	3.9926		
10.00%	2512.8923	3.9795		
20.00%	2521.2141	3.9663		
50.00%	2534.1401	3.9461		
80.00%	2544.8032	3.9296		
80.00%	2790.3733	3.5838		
50.00%	2807.6648	3.5617		
20.00%	2825.8022	3.5388		
10.00%	2837.9299	3.5237		
5.00%	2850.3682	3.5083		
1.00%	2889.1338	3.4612		
0.10%	2928.5266	3.4147		
Area Point Limits	Lower (cm⁻¹)	Upper (cm⁻¹)		
99%	2513.7827	2846.3451		
96%	2530.9986	2818.9999		
70%	2572.8381	2768.3110		
50%	2601.1470	2738.8992		
0% (area center)	2669.3554	2669.3554		
Crossing	Lower (cm⁻¹)	Upper (cm⁻¹)	Width (cm⁻¹)	Center (cm⁻¹)
80%	2544.8032	2790.3733	245.5701	2667.5884
50%	2534.1401	2807.6648	273.5247	2670.9023
20%	2521.2141	2825.8022	304.5881	2673.5083
5%	2504.6335	2850.3682	345.7346	2677.5010
Channel 4				
The peak wavenumber was at 910.60 and had a value of 1.00				
File starting point is at wavenumber = 781.30				
File ending point is at wavenumber = 1136.10				
Moment Center Wavenumber = 927.0246				
Percent line at which curve crosses	Wavenumber (cm⁻¹)		µm	
0.10%	862.2510		11.5976	
1.00%	869.1935		11.5049	
5.00%	874.3738		11.4368	
10.00%	876.7823		11.4053	
20.00%	879.5154		11.3699	
50.00%	884.9008		11.3007	
80.00%	891.0714		11.2224	
80.00%	961.4295		10.4012	
50.00%	969.5510		10.3141	
20.00%	976.7188		10.2384	
10.00%	980.3932		10.2000	

5.00%	983.4320	10.1685		
1.00%	989.3499	10.1076		
0.10%	996.3859	10.0363		
Area Point Limits	Lower (cm⁻¹)	Upper (cm⁻¹)		
99%	877.1614	980.3953		
96%	882.5272	973.9390		
70%	897.1439	957.3432		
50%	905.4768	948.0198		
0% (area center)	926.2947	926.2947		
Crossing	Lower (cm⁻¹)	Upper (cm⁻¹)	Width (cm⁻¹)	Center (cm⁻¹)
80%	891.0714	961.4295	70.3581	926.2505
50%	884.9008	969.5510	84.6501	927.2259
20%	879.5154	976.7188	97.2033	928.1171
5%	874.3738	983.4320	109.0582	928.9029

Channel 5		
The peak wavenumber was at 851.80 and had a value of 1.00		
File starting point is at wavenumber = 714.30		
File ending point is at wavenumber = 999.80		
Moment Center Wavenumber = 839.3771		
Percent line at which curve crosses	Wavenumber (cm⁻¹)	μm
0.10%	791.1701	12.6395
1.00%	795.8210	12.5656
5.00%	799.0394	12.5150
10.00%	800.4374	12.4932
20.00%	801.9744	12.4692
50.00%	804.8924	12.4240
80.00%	809.4222	12.3545
80.00%	870.8118	11.4835
50.00%	872.7117	11.4585
20.00%	874.8072	11.4311
10.00%	876.0613	11.4147
5.00%	877.2944	11.3987
1.00%	880.0529	11.3630
0.10%	883.5798	11.3176

Area Point Limits	Lower (cm⁻¹)	Upper (cm⁻¹)
99%	801.2731	874.9253
96%	804.4629	872.2251
70%	815.4069	862.5390
50%	822.7971	855.8623
0% (area center)	839.8246	839.8246

Crossing	Lower (cm⁻¹)	Upper (cm⁻¹)	Width (cm⁻¹)	Center (cm⁻¹)
-----------------	--------------------------------	--------------------------------	--------------------------------	---------------------------------

80%	809.4222	870.8118	61.3896	840.1171
50%	804.8924	872.7117	67.8193	830.8020
20%	801.9744	874.8072	72.8328	838.3907
5%	799.0394	877.2944	78.2549	838.1669

Table D.3-6 contains NOAA-17 AVHRR/3 visible channel information such as equivalent width, w , effective central wavelength, b_e , and in-band solar irradiance, F .

Table D.3-6. NOAA-17 AVHRR/3 Visible Channel Information.			
Channel	Equivalent Width w (μm)	Effective Wavelength λ_e (μm)	Extraterrestrial Solar Irradiance in Band F (W/m^2)
1	0.0830	0.6343	136.212
2	0.2332	0.8431	240.558
3A	0.0514	1.6062	12.449

Note: These quantities are based on the solar irradiance data of Neckel and Labs (1984), which is a widely used source of such data.

Table D.3-7 contains the temperature-to-radiance coefficients for NOAA-17 AVHRR/3 Channels 3B, 4 and 5.

Table D.3-7. NOAA-17 AVHRR/3 Thermal Channel Temperature-to-Radiance Coefficients.			
	ν_c	A	B
Channel 3B	2669.3554	1.702380	0.997378
Channel 4	926.2947	0.271683	0.998794
Channel 5	839.8246	0.309180	0.999012

Tables D.3-8 and D.3-9 contain the corresponding spectral response values for NOAA-17 AVHRR/3 Channels 1, 2, 3A and Channels 3B, 4 and 5, respectively. Note: Negative response values were caused by system response noise and are to be ignored but are included in the table for completeness.

Table D.3-8. NOAA-17 AVHRR/3 Spectral Response Values for Channels 1, 2 and 3A.

Channel 1		Channel 2		Channel 3A	
Wavelength (µm)	Relative Response (percent)	Wavelength (µm)	Relative Response (percent)	Wavelength (µm)	Relative Response (percent)
0.43	-0.09065	0.5	0.009322	1.49	-0.0008364
0.432	-0.04881	0.504	0.02671	1.491	6.673E-05
0.434	-0.1259	0.508	0.02294	1.492	-0.004932
0.436	-0.09956	0.512	0.01535	1.493	0.001087
0.438	0.1532	0.516	-0.00187	1.494	-0.002084
0.44	-0.004736	0.52	0.003617	1.495	0.01003
0.442	-0.07128	0.524	0.009153	1.496	0.002434
0.444	0.01453	0.528	-0.01047	1.497	-0.000612
0.446	0.1177	0.532	-0.003216	1.498	-0.0127
0.448	0.1547	0.536	-0.003333	1.499	0.0048
0.45	0.2955	0.54	0.003491	1.5	-0.006513
0.452	0.08948	0.544	-0.007124	1.501	-0.001636
0.454	-0.03246	0.548	0.01182	1.502	0.009002
0.456	0.3173	0.552	0.007709	1.503	6.754E-05
0.458	-0.09104	0.556	0.002622	1.504	0.01075
0.46	0.0383	0.56	-0.003375	1.505	0.009945
0.462	0.05126	0.564	0.004387	1.506	0.001097
0.464	-0.0329	0.568	-0.001663	1.507	-0.00938
0.466	-0.009072	0.572	0.0007343	1.508	6.709E-05
0.468	0.01306	0.576	0.0005186	1.509	0.005526
0.47	0.03344	0.58	0.001462	1.51	0.01153
0.472	0.4583	0.584	-0.0005424	1.511	-0.006625
0.474	-0.02025	0.588	0.001769	1.512	-0.001525
0.476	-0.02043	0.592	-0.005231	1.513	0.01017
0.478	-0.04375	0.596	-0.008645	1.514	-0.0002768
0.48	-0.01109	0.6	-0.007108	1.515	0.001795
0.482	-0.03603	0.604	0.002324	1.516	-0.003823
0.484	0.005565	0.608	0.001445	1.517	0.01295
0.486	0.06175	0.612	-0.002213	1.518	0.002135
0.488	-0.03629	0.616	-0.0009627	1.519	-0.003261
0.49	0.09509	0.62	-0.01042	1.52	0.008955
0.492	0.03584	0.624	-0.006464	1.521	0.01916
0.494	0.0716	0.628	0.005096	1.522	0.005964
0.496	-0.0289	0.632	-0.002659	1.523	-0.006381
0.498	0.03873	0.636	-0.002009	1.524	0.00226
0.5	0.02358	0.64	0.002341	1.525	0.008159
0.502	0.02158	0.644	0.001406	1.526	0.002944
0.504	-0.01142	0.648	0.001556	1.527	0.01128

0.506	0.04083	0.652	-0.00129	1.528	0.01743
0.508	0.03875	0.656	-0.002442	1.529	0.000984
0.51	0.009675	0.66	0.001257	1.53	0.01271
0.512	0.01157	0.664	-0.001534	1.531	0.005831
0.514	-0.00469	0.668	-0.0004428	1.532	0.002477
0.516	-0.02658	0.672	0.001227	1.533	0.006758
0.518	-0.02196	0.676	0.004571	1.534	0.003294
0.52	0.0299	0.68	0.003944	1.535	0.01383
0.522	-0.007131	0.684	0.01565	1.536	0.002369
0.524	0.01608	0.688	0.02235	1.537	0.006599
0.526	-0.002306	0.692	0.09222	1.538	0.01308
0.528	0.0143	0.696	0.3542	1.539	0.00433
0.53	-0.01021	0.7	1.204	1.54	0.01518
0.532	0.01961	0.704	3.384	1.541	0.02334
0.534	-0.009284	0.708	7.664	1.542	0.01992
0.536	-0.008635	0.712	14.44	1.543	0.01853
0.538	-0.02106	0.716	20.99	1.544	0.0161
0.54	-0.009967	0.72	27.31	1.545	0.02132
0.542	0.01753	0.724	33.8	1.546	0.0178
0.544	0.009069	0.728	40.76	1.547	0.01388
0.546	0.003909	0.732	47.26	1.548	0.0218
0.548	0.01174	0.736	54.04	1.549	0.01941
0.55	-0.009763	0.74	62.11	1.55	0.03236
0.552	0.01003	0.744	71.01	1.551	0.04262
0.554	-0.003237	0.748	78.17	1.552	0.04452
0.556	0.02122	0.752	83.55	1.553	0.06266
0.558	0.01144	0.756	89.13	1.554	0.07052
0.56	0.001719	0.76	92.28	1.555	0.0763
0.562	-0.0064	0.764	93.7	1.556	0.1061
0.564	0.04224	0.768	93.5	1.557	0.1303
0.566	0.004333	0.772	93.3	1.558	0.1622
0.568	0.05981	0.776	94.68	1.559	0.2167
0.57	0.07691	0.78	96.31	1.56	0.245
0.572	0.07532	0.784	98.14	1.561	0.3337
0.574	0.1785	0.788	99.41	1.562	0.4015
0.576	0.3922	0.792	99.71	1.563	0.5461
0.578	0.7385	0.796	98.75	1.564	0.6786
0.58	1.722	0.8	97.73	1.565	0.8465
0.582	4.033	0.804	97.2	1.566	1.136
0.584	10.02	0.808	97.76	1.567	1.459
0.586	22.9	0.812	98.85	1.568	1.82
0.588	40.91	0.816	99.7	1.569	2.427
0.59	53.35	0.82	99.93	1.57	3.109

0.592	59.08	0.824	100	1.571	4.14
0.594	63.39	0.828	99.52	1.572	5.393
0.596	68.46	0.832	99.22	1.573	6.994
0.598	73.41	0.836	99.23	1.574	9.493
0.6	77.75	0.84	99.21	1.575	12.36
0.602	81.05	0.844	99.46	1.576	16.79
0.604	83.2	0.848	99.14	1.577	21.86
0.606	84.72	0.852	98.44	1.578	29.07
0.608	86.01	0.856	97.64	1.579	37.17
0.61	87.43	0.86	96.76	1.58	45.62
0.612	89.48	0.864	95.21	1.581	56.79
0.614	91.71	0.868	93.92	1.582	66.25
0.616	92.98	0.872	93.21	1.583	75.75
0.618	93.43	0.876	92.46	1.584	83.15
0.62	93.48	0.88	92.33	1.585	87.47
0.622	93.37	0.884	91.84	1.586	92.35
0.624	93.4	0.888	91.64	1.587	92.77
0.626	93.13	0.892	90.75	1.588	94.6
0.628	93.57	0.896	89.52	1.589	93.98
0.63	93.81	0.9	88.22	1.59	93.29
0.632	93.97	0.904	87.53	1.591	94.25
0.634	94.44	0.908	86.98	1.592	92.64
0.636	94.65	0.912	87.11	1.593	94.43
0.638	95.59	0.916	87.1	1.594	94.15
0.64	96.52	0.92	87.16	1.595	93.99
0.642	97.82	0.924	86.02	1.596	94.88
0.644	99.27	0.928	84.43	1.597	94.55
0.646	99.99	0.932	82.87	1.598	95.29
0.648	100	0.936	81.9	1.599	94.25
0.65	99.7	0.94	80.72	1.6	96.05
0.652	98.15	0.944	79.06	1.601	95.94
0.654	96.18	0.948	77.3	1.602	95.79
0.656	93.66	0.952	75.45	1.603	95.34
0.658	91.36	0.956	73.48	1.604	95.45
0.66	88.65	0.96	71.56	1.605	96.74
0.662	86.76	0.964	70.03	1.606	94.23
0.664	85.18	0.968	68.94	1.607	95.3
0.666	83.76	0.972	66.15	1.608	93.68
0.668	83.11	0.976	61.75	1.609	94.42
0.67	83.51	0.98	56.43	1.61	93.75
0.672	85.12	0.984	52.6	1.611	94.12
0.674	86.16	0.988	49.85	1.612	93.65
0.676	83.1	0.992	41.47	1.613	92.48

0.678	70.16	0.996	22.18	1.614	93.28
0.68	51	1	8.212	1.615	92.67
0.682	33.32	1.004	3.117	1.616	93.6
0.684	20.62	1.008	1.42	1.617	93.03
0.686	12.49	1.012	0.7962	1.618	95.29
0.688	7.321	1.016	0.5448	1.619	95.26
0.69	4.202	1.02	0.4234	1.62	95.1
0.692	2.417	1.024	0.3536	1.621	98.08
0.694	1.399	1.028	0.3093	1.622	98.54
0.696	0.8155	1.032	0.27	1.623	100
0.698	0.4956	1.036	0.2362	1.624	99.13
0.7	0.2922	1.04	0.2059	1.625	99.89
0.702	0.1886	1.044	0.1832	1.626	95.76
0.704	0.1099	1.048	0.1548	1.627	94.3
0.706	0.06342	1.052	0.1346	1.628	87.62
0.708	0.03122	1.056	0.1126	1.629	80.74
0.71	0.01844	1.06	0.09284	1.63	72.61
0.712	-0.008994	1.064	0.07759	1.631	63.96
0.714	-0.007811	1.068	0.06402	1.632	54.06
0.716	0.008407	1.072	0.05062	1.633	44.12
0.718	-0.007444	-	-	1.634	37.03
0.72	0.01356	-	-	1.635	29.27
0.722	-0.01925	-	-	1.636	23.33
0.724	-0.0152	-	-	1.637	18.14
0.726	0.0001121	-	-	1.638	14.75
0.728	0.02124	-	-	1.639	11.29
0.73	-0.01858	-	-	1.64	8.97
0.732	-0.008072	-	-	1.641	7.033
0.734	-0.02215	-	-	1.642	5.793
0.736	-0.00762	-	-	1.643	4.561
0.738	-0.004521	-	-	1.644	3.607
0.74	0.007491	-	-	1.645	2.956
0.742	-0.004499	-	-	1.646	2.355
0.744	0.004345	-	-	1.647	1.97
0.746	-0.003188	-	-	1.648	1.613
0.748	-0.008475	-	-	1.649	1.363
0.75	0.00084	-	-	1.65	1.112
0.752	-0.014	-	-	1.651	0.9409
0.754	0.002848	-	-	1.652	0.7443
0.756	-0.005178	-	-	1.653	0.6525
0.758	0.0007404	-	-	1.654	0.5764
0.76	-0.02035	-	-	1.655	0.5095
0.762	-0.02301	-	-	1.656	0.394

0.764	0.002486	-	-	1.657	0.3234
0.766	-0.006276	-	-	1.658	0.3046
0.768	-0.01742	-	-	1.659	0.2577
0.77	0.04229	-	-	1.66	0.2065
0.772	-0.007647	-	-	1.661	0.2024
0.774	-0.01046	-	-	1.662	0.165
0.776	0.003111	-	-	1.663	0.1577
0.778	-0.01578	-	-	1.664	0.1285
0.78	-0.0147	-	-	1.665	0.1173
0.782	-0.01532	-	-	1.666	0.1159
0.784	0.006754	-	-	1.667	0.08093
0.786	0.00242	-	-	1.668	0.08118
0.788	0.001057	-	-	1.669	0.09189
0.79	-0.02534	-	-	1.67	0.04033
0.792	0.02389	-	-	1.671	0.04494
0.794	0.003045	-	-	1.672	0.05669
0.796	-0.02196	-	-	1.673	0.04872
0.798	-0.002512	-	-	1.674	0.0669
0.8	-0.02028	-	-	1.675	0.05297
0.802	-0.01035	-	-	1.676	0.03004
0.804	-0.01985	-	-	1.677	0.01605
0.806	-0.01351	-	-	1.678	0.03327
0.808	-0.01784	-	-	1.679	0.03453
0.81	-0.04077	-	-	1.68	0.02413
0.812	-0.007691	-	-	1.681	0.01612
0.814	-0.006489	-	-	1.682	0.01835
0.816	-0.01069	-	-	1.683	0.001586
0.818	-0.0335	-	-	1.684	0.006575
0.82	-0.02232	-	-	1.685	0.01057
0.822	-0.0005826	-	-	1.686	0.02745
0.824	0.01725	-	-	1.687	0.0141
0.826	-0.02547	-	-	1.688	0.008842
0.828	-0.003171	-	-	1.689	0.01767
0.83	-0.00336	-	-	1.69	0.03035
-	-	-	-	1.691	0.02
-	-	-	-	1.692	-0.01065
-	-	-	-	1.693	0.02238
-	-	-	-	1.694	-0.006386
-	-	-	-	1.695	0.02306
-	-	-	-	1.696	0.004098
-	-	-	-	1.697	0.01304
-	-	-	-	1.698	0.007056
-	-	-	-	1.699	-0.004172

-	-	-	-	1.7	0.007405
-	-	-	-	1.701	0.0207
-	-	-	-	1.702	-0.005615
-	-	-	-	1.703	0.007141
-	-	-	-	1.704	-0.00388
-	-	-	-	1.705	-0.01529
-	-	-	-	1.706	0.0202
-	-	-	-	1.707	0.002258
-	-	-	-	1.708	-0.003412
-	-	-	-	1.709	0.002879
-	-	-	-	1.71	0.00879
-	-	-	-	1.711	-0.01075
-	-	-	-	1.712	-0.01059
-	-	-	-	1.713	-0.0008345
-	-	-	-	1.714	-0.006658
-	-	-	-	1.715	0.01639
-	-	-	-	1.716	-0.006614
-	-	-	-	1.717	-0.01068
-	-	-	-	1.718	9.214E-05
-	-	-	-	1.719	-0.01111
-	-	-	-	1.72	-0.008704
-	-	-	-	1.721	-0.01717
-	-	-	-	1.722	0.001323
-	-	-	-	1.723	-0.003298
-	-	-	-	1.724	-0.01184
-	-	-	-	1.725	-0.01016
-	-	-	-	1.726	-0.004224
-	-	-	-	1.727	-0.01201
-	-	-	-	1.728	-0.01586
-	-	-	-	1.729	-0.003961
-	-	-	-	1.73	-0.003873

Table D.3-9. NOAA-17 AVHRR/3 Spectral Response Values for Channels 3B, 4 and 5.

Channel 3B		Channel 4		Channel 5	
Wavelength (µm)	Relative Response (percent)	Wavelength (µm)	Relative Response (percent)	Wavelength (µm)	Relative Response (percent)
2.98	0.00862	8.8	0.002672	10	0.01355
2.987	0.00502	8.82	0.02292	10.02	0.006598
2.994	-0.00367	8.84	-0.01563	10.04	0.01834
3.001	-0.00586	8.86	0.004889	10.06	0.003044
3.008	0.00642	8.88	-0.008165	10.08	0.01258
3.015	0.00532	8.9	0.02362	10.1	0.008526
3.022	-0.00164	8.92	0.002033	10.12	0.009147
3.029	0.00334	8.94	0.001733	10.14	0.008192
3.036	0.23936	8.96	-0.02323	10.16	0.009166
3.043	0.01145	8.98	0.004445	10.18	0.007965
3.05	0.0037	9	0.01219	10.2	0.01453
3.057	0.00931	9.02	0.01066	10.22	0.008008
3.064	-0.00509	9.04	0.007318	10.24	0.005171
3.071	0.00963	9.06	0.01953	10.26	0.0164
3.078	0.0128	9.08	0.008014	10.28	0.0001844
3.085	0.00164	9.1	-0.0108	10.3	0.003104
3.092	-0.000788	9.12	0.003033	10.32	0.004054
3.099	-0.000611	9.14	-0.02039	10.34	0.002746
3.106	0.000744	9.16	0.004377	10.36	0.001286
3.113	0.00732	9.18	0.01441	10.38	-0.002027
3.12	-0.00625	9.2	0.02069	10.4	0.003154
3.127	-0.00608	9.22	-0.01759	10.42	0.006009
3.134	0.00791	9.24	0.008268	10.44	0.01098
3.141	0.00984	9.26	0.01491	10.46	-0.001819
3.148	0.00534	9.28	0.003987	10.48	0.007332
3.155	-0.00539	9.3	0.0219	10.5	0.0003518
3.162	-0.00811	9.32	0.03947	10.52	0.01032
3.169	0.00174	9.34	0.00307	10.54	0.005165
3.176	0.00766	9.36	4.073	10.56	-0.00526
3.183	0.000822	9.38	0.03279	10.58	0.006168
3.19	-0.00531	9.4	-0.0002071	10.6	-0.003767
3.197	-0.01267	9.42	-0.02613	10.62	-0.01271
3.204	0.000546	9.44	-0.01048	10.64	-0.0005124
3.211	-0.00453	9.46	-0.03739	10.66	0.01172
3.218	-0.00643	9.48	0.0135	10.68	-0.001256
3.225	0.00452	9.5	0.005915	10.7	-0.005604
3.232	0.00351	9.52	-0.01598	10.72	-0.007074

3.239	-0.00506	9.54	0.005028	10.74	-0.003616
3.246	-0.00166	9.56	0.002662	10.76	-0.002295
3.253	0.01368	9.58	0.005559	10.78	-0.0008934
3.26	0.01097	9.6	0.0008341	10.8	0.003314
3.267	0.01132	9.62	0.005991	10.82	-0.001754
3.274	0.00242	9.64	0.02601	10.84	-0.005154
3.281	0.00302	9.66	-0.01446	10.86	0.2539
3.288	0.00416	9.68	-0.005252	10.88	-0.01211
3.295	0.00604	9.7	0.003237	10.9	-0.001179
3.302	0.00734	9.72	-0.01669	10.92	-0.005135
3.309	0.00493	9.74	0.03039	10.94	-0.003307
3.316	0.00171	9.76	-0.02462	10.96	-0.02101
3.323	0.01199	9.78	0.007526	10.98	-0.01332
3.33	0.00297	9.8	-0.004866	11	-0.007008
3.337	0.01801	9.82	0.002393	11.02	-0.004798
3.344	-0.00237	9.84	-0.005776	11.04	-0.003622
3.351	0.02282	9.86	0.001998	11.06	-0.01038
3.358	0.01267	9.88	0.01973	11.08	-0.007724
3.365	0.01237	9.9	0.01316	11.1	0.001618
3.372	0.02087	9.92	-0.01045	11.12	-0.00236
3.379	0.01448	9.94	0.01583	11.14	-0.01986
3.386	0.02723	9.96	-0.001424	11.16	-0.009352
3.393	0.0275	9.98	0.0347	11.18	-0.01705
3.4	0.04912	10	0.0429	11.2	9.495E-05
3.407	0.06245	10.02	0.04086	11.22	-0.01603
3.414	0.09517	10.04	0.122	11.24	0.01562
3.421	0.14846	10.06	0.2474	11.26	0.01996
3.428	0.20819	10.08	0.4577	11.28	0.0005891
3.435	0.32693	10.1	0.8325	11.3	0.02193
3.442	0.45638	10.12	1.406	11.32	0.1102
3.449	0.62833	10.14	2.472	11.34	0.2979
3.456	0.82827	10.16	4.046	11.36	0.8426
3.463	1.06078	10.18	6.435	11.38	2.152
3.47	1.34103	10.2	9.904	11.4	5.175
3.477	1.65788	10.22	14.57	11.42	12.28
3.484	2.08814	10.24	20.38	11.44	27.5
3.491	2.62468	10.26	27.35	11.46	51.25
3.498	3.33055	10.28	34.92	11.48	76.15
3.505	4.37172	10.3	43.49	11.5	89.73
3.512	5.84957	10.32	52.42	11.52	91.09
3.519	8.04378	10.34	60.71	11.54	88.37
3.526	11.1169	10.36	68.71	11.56	87.15

3.533	15.3041	10.38	75.15	11.58	88.19
3.54	21.0809	10.4	79.74	11.6	91.55
3.547	28.6145	10.42	82.83	11.62	93.33
3.554	38.0882	10.44	85.22	11.64	95.74
3.561	48.8709	10.46	86.21	11.66	98.12
3.568	59.8885	10.48	86.44	11.68	98.98
3.575	70.021	10.5	86.71	11.7	99.25
3.582	78.1934	10.52	87.24	11.72	99.76
3.589	84.2581	10.54	88.15	11.74	100
3.596	87.2597	10.56	89.19	11.76	99.8
3.603	89.3534	10.58	90.17	11.78	99.2
3.61	90.7406	10.6	91.01	11.8	98.56
3.617	91.3379	10.62	91.93	11.82	98.89
3.624	91.5169	10.64	92.72	11.84	98.84
3.631	91.75	10.66	93.03	11.86	99.48
3.638	91.7613	10.68	94	11.88	99
3.645	92.2221	10.7	94.93	11.9	99.24
3.652	92.4756	10.72	95.06	11.92	98.56
3.659	92.9641	10.74	94.88	11.94	98.39
3.666	93.6619	10.76	95.72	11.96	97.17
3.673	94.2733	10.78	95.81	11.98	97.13
3.68	95.3461	10.8	95.75	12	94.92
3.687	96.2959	10.82	95.7	12.02	93.97
3.694	97.1352	10.84	96.22	12.04	92.02
3.701	97.9276	10.86	96.07	12.06	91.14
3.708	98.6843	10.88	95.87	12.08	90.44
3.715	99.0706	10.9	96.58	12.1	89.49
3.722	99.6617	10.92	96.05	12.12	88.97
3.729	99.566	10.94	98.8	12.14	88.9
3.736	100	10.96	97.03	12.16	87.95
3.743	99.8084	10.98	100	12.18	87.23
3.75	99.8033	11	98.54	12.2	86.92
3.757	99.5347	11.02	99.45	12.22	85.11
3.764	99.8026	11.04	98.24	12.24	85.06
3.771	99.8291	11.06	99.5	12.26	84.26
3.778	99.9346	11.08	98.6	12.28	84.28
3.785	99.9398	11.1	96.6	12.3	81.96
3.792	99.5834	11.12	95.75	12.32	82.12
3.799	99.5397	11.14	94.33	12.34	81.46
3.806	99.5387	11.16	92.77	12.36	79.11
3.813	98.8389	11.18	89.41	12.38	73.51
3.82	98.3127	11.2	85.9	12.4	65.82

3.827	97.1817	11.22	80.86	12.42	52.99
3.834	96.4223	11.24	74.69	12.44	39.26
3.841	95.8607	11.26	68.01	12.46	25.52
3.848	94.9926	11.28	59.28	12.48	14.98
3.855	94.8302	11.3	50.5	12.5	8.142
3.862	94.5596	11.32	41	12.52	4.306
3.869	95.1009	11.34	32.02	12.54	2.258
3.876	95.5137	11.36	23.75	12.56	1.194
3.883	96.76	11.38	16.76	12.58	0.6585
3.89	97.7527	11.4	11.22	12.6	0.3189
3.897	98.8714	11.42	7.438	12.62	0.1789
3.904	98.8156	11.44	4.669	12.64	0.09845
3.911	97.3622	11.46	3.035	12.66	0.02806
3.918	93.2379	11.48	1.787	12.68	0.02886
3.925	86.2266	11.5	1.15	12.7	-0.01095
3.932	76.0853	11.52	0.624	12.72	-0.01828
3.939	63.1266	11.54	0.4481	12.74	-0.01124
3.946	50.1982	11.56	0.2534	12.76	-0.01459
3.953	37.8329	11.58	0.1732	12.78	0.007384
3.96	27.4364	11.6	0.09704	12.8	-0.01746
3.967	19.3512	11.62	0.121	12.82	-0.01403
3.974	13.3907	11.64	0.03826	12.84	-0.03602
3.981	9.23866	11.66	0.03188	12.86	-0.01261
3.988	6.37943	11.68	0.01518	12.88	-0.06917
3.995	4.42402	11.7	0.0407	12.9	-0.00929
4.002	3.11955	11.72	0.03684	12.92	-0.02175
4.009	2.24388	11.74	-0.01336	12.94	-0.03332
4.016	1.58349	11.76	0.03116	12.96	-0.06208
4.023	1.11447	11.78	-0.03545	12.98	-0.06559
4.03	0.81222	11.8	0.08653	13	-0.01411
4.037	0.59283	11.82	-0.05337	13.02	0.009463
4.044	0.4344	11.84	0.07375	13.04	-0.04154
4.051	0.33028	11.86	0.09694	13.06	-0.03529
4.058	0.24324	11.88	-0.06905	13.08	-0.008764
4.065	0.19363	11.9	-0.0218	13.1	-0.05664
4.072	0.13935	11.92	-0.09451	13.12	-0.02171
4.079	0.10549	11.94	-0.06877	13.14	-0.04043
4.086	0.0798	11.96	-0.1422	13.16	-0.01591
4.093	0.05335	11.98	0.06551	13.18	-0.04614
4.1	0.03807	12	0.1744	13.2	-0.07809
4.107	0.03126	12.02	-0.08561	13.22	-0.04289
4.114	0.01912	12.04	-0.04837	13.24	-0.06797

4.121	0.01471	12.06	-0.08585	13.26	0.004183
4.128	0.00518	12.08	-0.06557	13.28	-0.02505
4.135	0.00805	12.1	0.06829	13.3	-0.02641
4.142	-0.00144	12.12	-0.06915	13.32	-0.04431
4.149	-0.00222	12.14	0.001108	13.34	-0.0253
4.156	-0.00378	12.16	0.009701	13.36	-0.01577
4.163	-0.01117	12.18	1.193	13.38	0.002353
4.17	-0.01339	12.2	0.003084	13.4	-0.07232
4.177	0.00414	12.22	0.03961	13.42	-0.07439
4.184	0.0147	12.24	-0.03443	13.44	-0.1003
4.191	0.00222	12.26	0.05267	13.46	-0.05095
4.198	-0.01467	12.28	-0.04374	13.48	-0.1146
4.205	-0.03354	12.3	0.002715	13.5	-0.04489
4.212	-0.05105	12.32	-0.1214	13.52	-0.0489
4.219	-0.25673	12.34	-0.0655	13.54	-0.06161
4.226	-0.12844	12.36	-0.03179	13.56	-0.0202
4.233	0.11548	12.38	-0.01476	13.58	-0.07926
4.24	0.05306	12.4	-0.06599	13.6	-0.08591
4.247	0.4581	12.42	-0.0003548	13.62	-0.1683
4.254	0.07806	12.44	0.01637	13.64	-0.07274
4.261	-0.01386	12.46	0.1011	13.66	-0.03322
4.268	0.4737	12.48	0.03018	13.68	-0.05523
4.275	-0.22682	12.5	-0.03573	13.7	0.04107
4.282	-0.01468	12.52	0.03382	13.72	-0.04951
4.289	-0.22643	12.54	-0.1379	13.74	-0.02986
4.296	-0.08543	12.56	-0.0453	13.76	0.02535
4.303	0.21533	12.58	-0.1104	13.78	-0.07546
4.31	-0.0332	12.6	-0.01406	13.8	-0.06502
4.317	-0.04098	12.62	-0.04006	13.82	-0.0558
4.324	-0.01558	12.64	-0.1136	13.84	-0.077
4.331	-0.04557	12.66	0.1032	13.86	-0.03247
4.338	0.01453	12.68	0.0002163	13.88	0.02308
4.345	-0.00272	12.7	-0.1079	13.9	-0.1325
4.352	0.01915	12.72	0.0008639	13.92	-0.009476
4.359	-0.02428	12.74	0.04461	13.94	-0.04258
4.366	-0.00233	12.76	-0.1746	13.96	-0.03505
4.373	-0.02559	12.78	0.1333	13.98	-0.05063
4.38	-0.02393	12.8	-0.07272	14	-0.1135
4.387	0.01623	-	-	-	-
4.394	0.01143	-	-	-	-
4.401	-0.02593	-	-	-	-
4.408	0.00504	-	-	-	-

4.415	-0.000963	-	-	-	-
4.422	-0.01117	-	-	-	-
4.429	-0.0111	-	-	-	-
4.436	0.00514	-	-	-	-
4.443	0.00436	-	-	-	-
4.45	-0.02916	-	-	-	-
4.457	-0.00297	-	-	-	-
4.464	0.00981	-	-	-	-
4.471	-0.01084	-	-	-	-
4.478	-0.0273	-	-	-	-
4.485	-0.00805	-	-	-	-
4.492	0.01625	-	-	-	-
4.499	0.01175	-	-	-	-

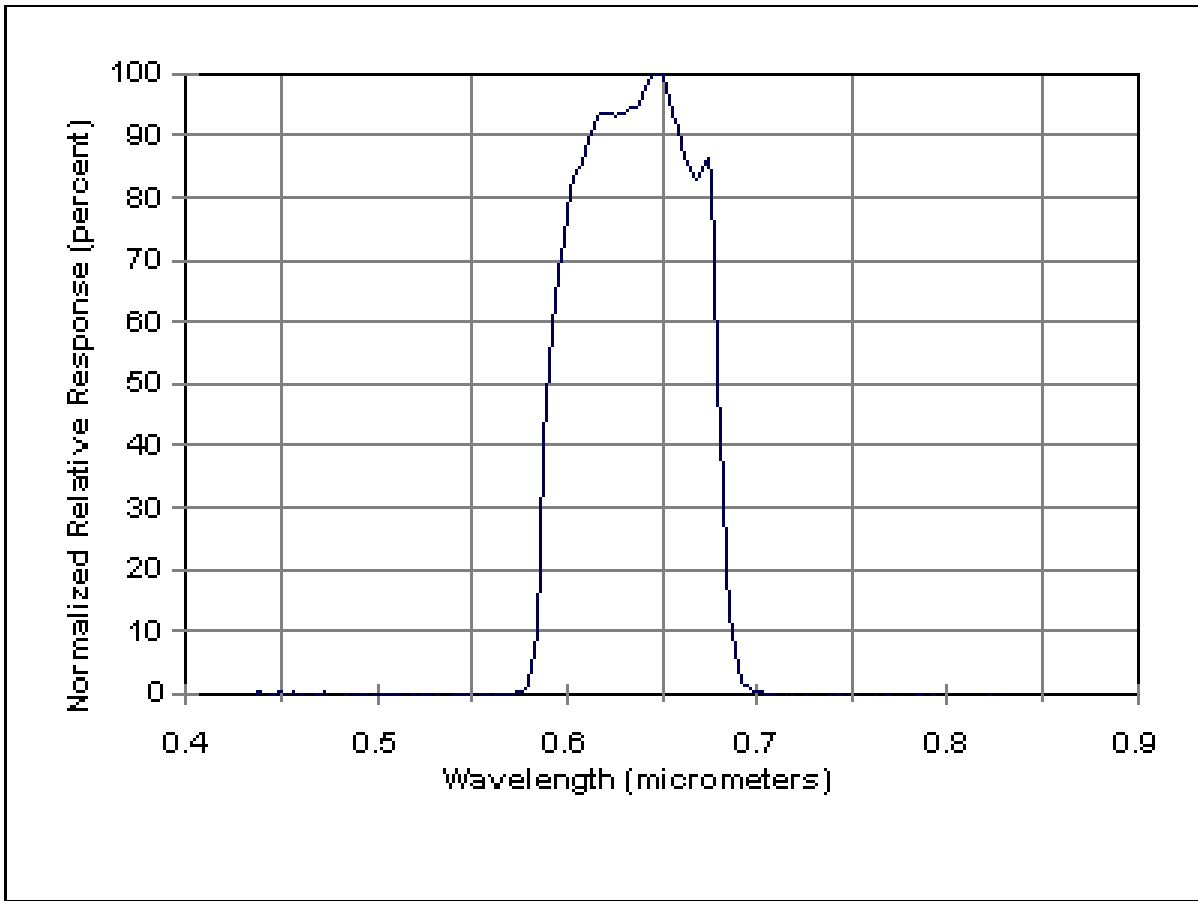

Figure D.3-1. Spectral Response Curve for NOAA-17 Channel 1

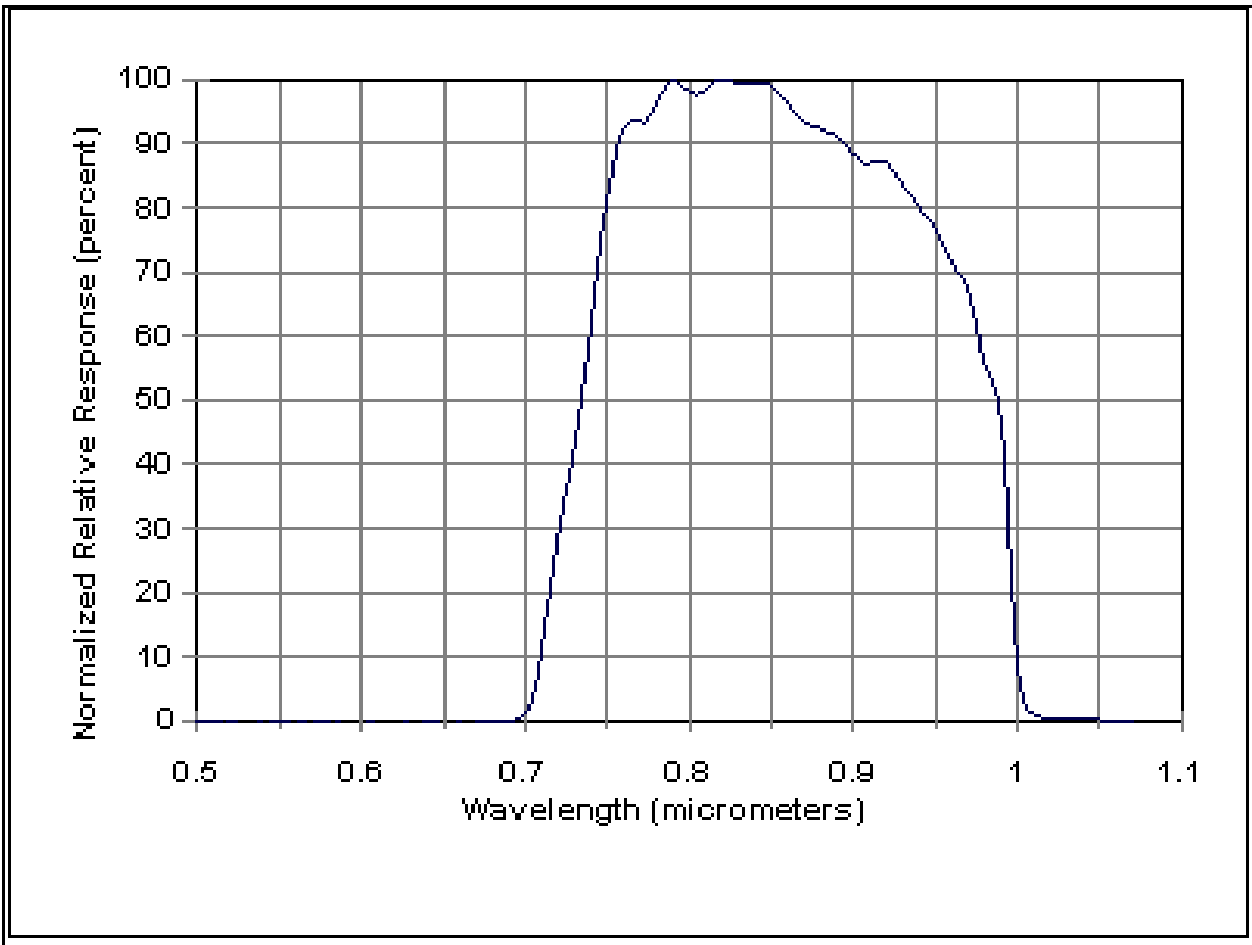

Figure D.3-2. Spectral Response Curve for NOAA-17 Channel 2

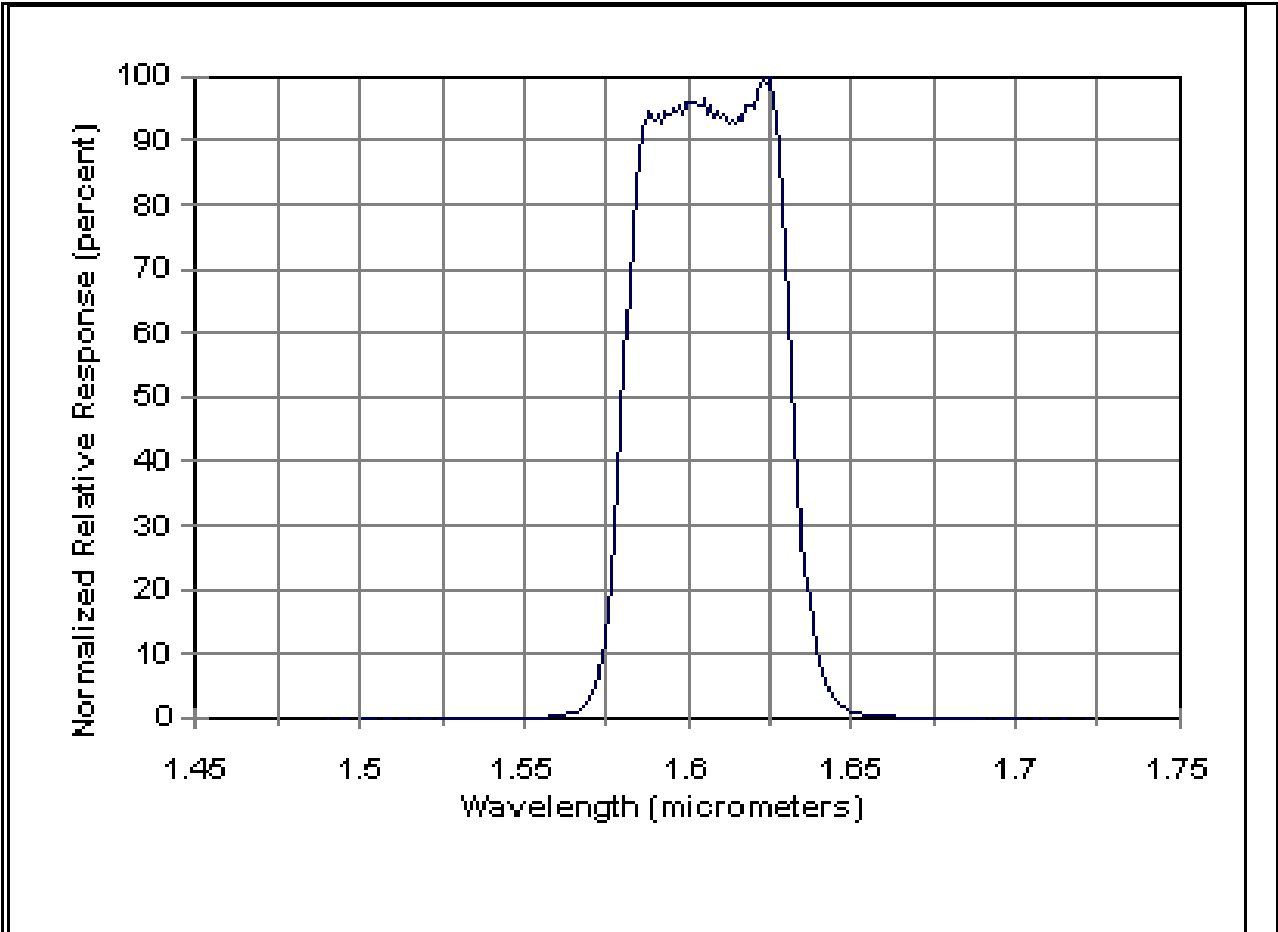

Figure D.3-3 Spectral Response Curve for NOAA-17 Channel 3A

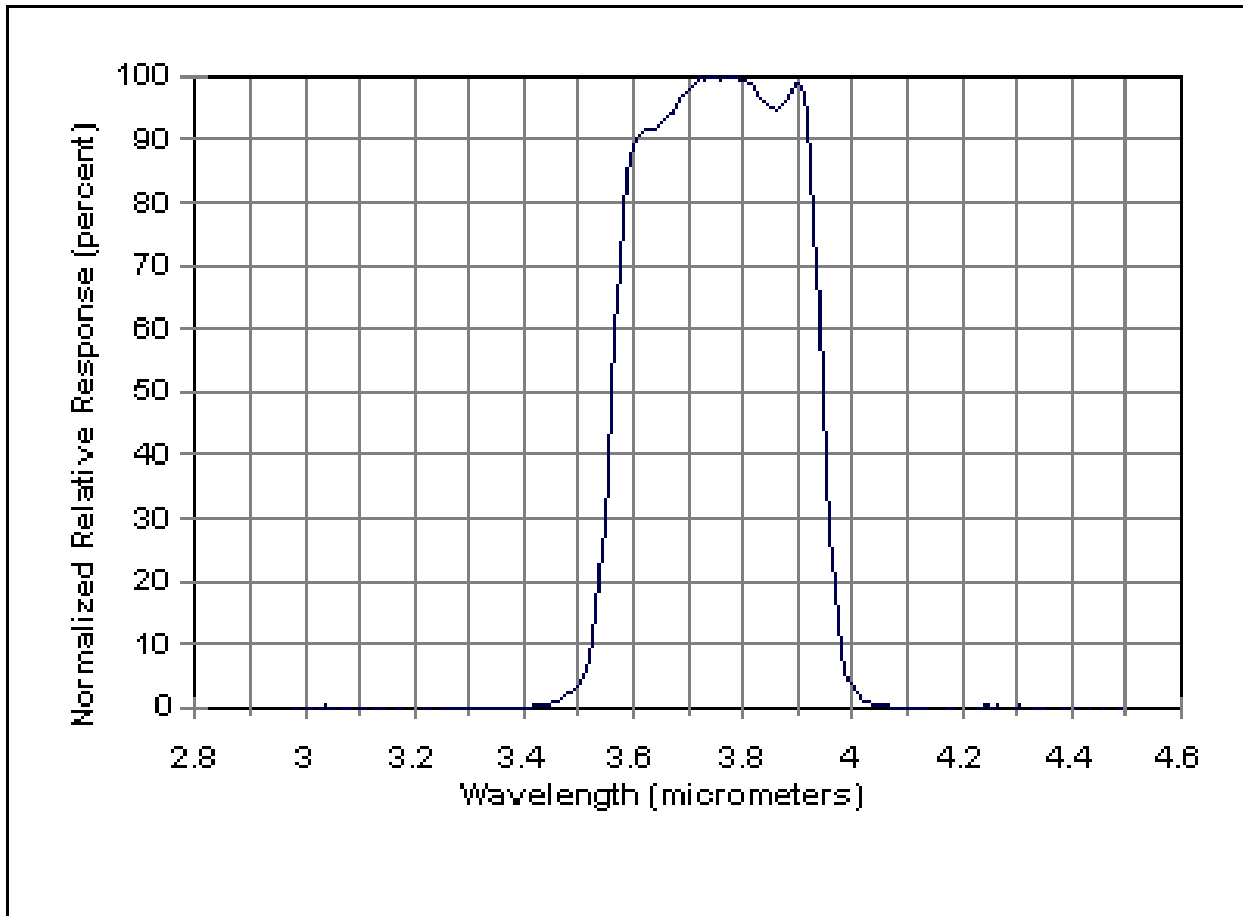

Figure D.3-4. Spectral Response Curve for NOAA-17 Channel 3B

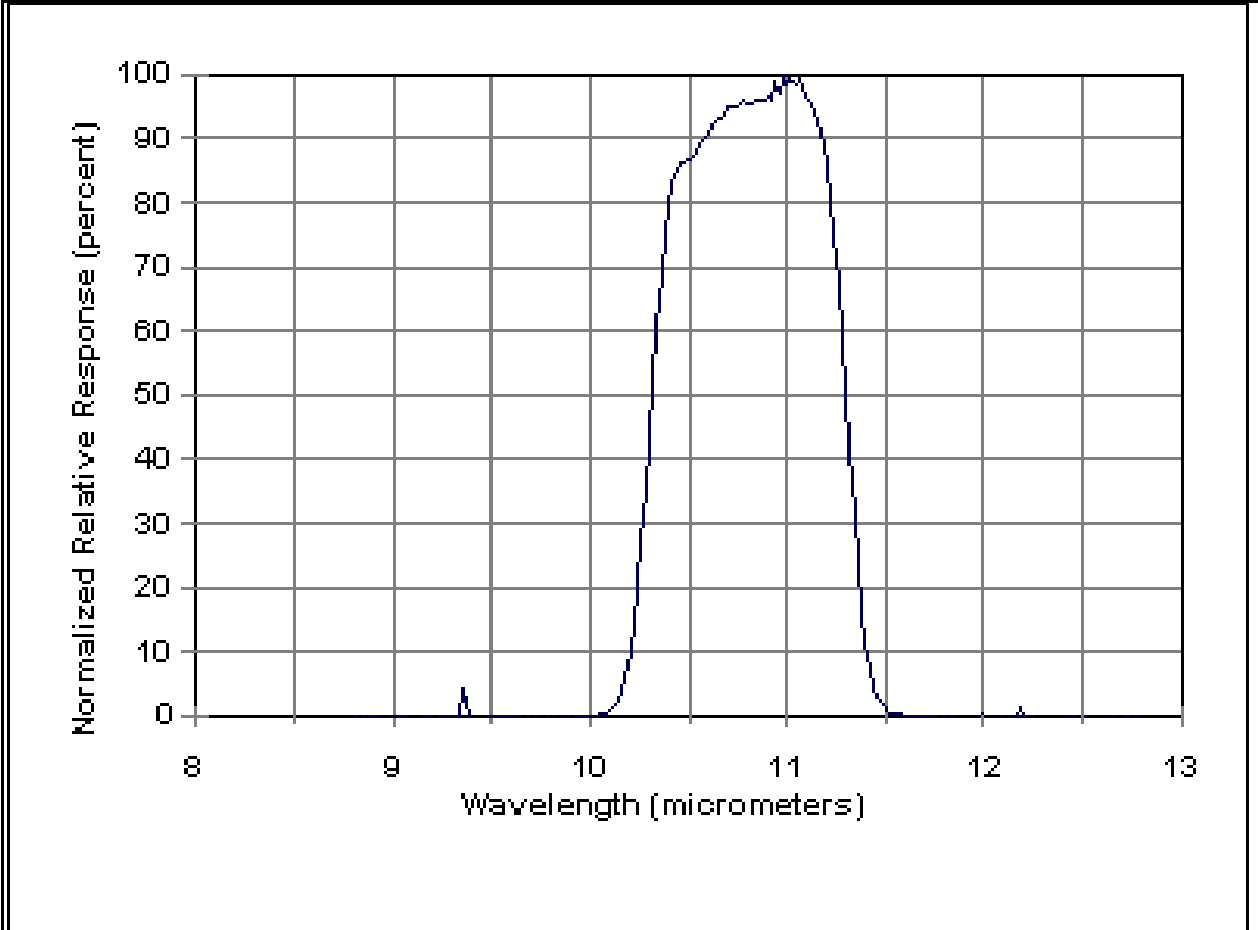

Figure D.3-5. Spectral Response Curve for NOAA-17 Channel 4

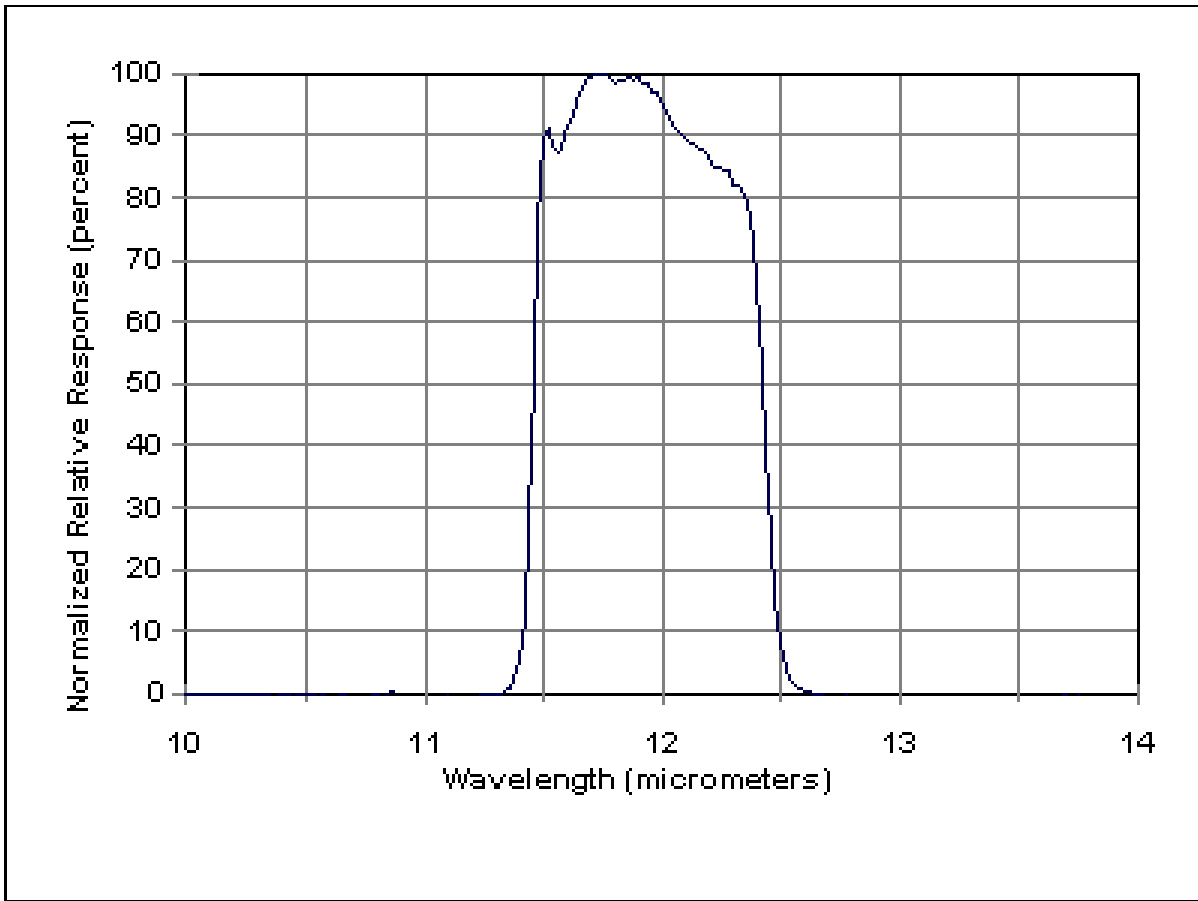

Figure D.3-6. Spectral Response Curve for NOAA-17 Channel 5

HIRS:

Table D.3-10 contains the NOAA-17 HIRS/303 central wave numbers and band correction coefficients for the thermal channels.

Table D.3-10. NOAA-17 HIRS/303 Central Wave Numbers (ν_c) and Band Correction Coefficients (b and c).			
Channel	ν_c	b	c
1	668.87	-0.00024757	0.99999
2	679.96	-0.0012648	0.99997
3	691.41	0.014711	0.99992
4	702.73	0.18566	0.99992
5	715.70	0.019572	0.99990
6	731.82	0.020049	0.99991
7	748.04	0.027390	0.99989
8	899.91	0.096078	0.99966
9	1029.25	0.045279	0.99987
10	801.48	0.016530	0.99993
11	1365.25	0.072529	0.99982
12	1527.77	0.11069	0.99975
13	2185.43	0.021412	0.99992
14	2210.98	0.020369	0.99997
15	2232.98	0.021565	0.99996
16	2240.36	0.020399	0.99996
17	2417.09	0.038640	0.99999
18	2519.18	0.052706	0.99994
19	2657.70	0.31592	0.99960

Table D.3-11 contains the Internal Warm Temperature (IWT) PRT count to temperature coefficients for the NOAA-17 HIRS/303 instrument.

Table D.3-11. NOAA-17 IWT PRT Count to Temperature Coefficients for HIRS/303.					
PRT	a₀	a₁	a₂	a₃	a₄
1	301.41859	0.006539867	8.909E-08	4.78771E-11	1.34536E-15
2	301.43106	0.006530633	8.7115E-08	4.73879E-11	1.44603E-15
3	301.42252	0.006533278	8.24857E-08	4.73017E-11	1.60991E-15
4	301.38868	0.006524437	8.03802E-08	4.7093E-11	1.69764E-15

Table D.3-12 contains the secondary telescope temperature coefficients for the NOAA-17 HIRS/303 instrument.

Table D.3-12. NOAA-17 HIRS/303 Secondary Telescope Temperature Coefficients.				
a₀	a₁	a₂	a₃	a₄

260.29119	0.01693469	-2.41317E-06	4.01919E-10	1.17566E-14
-----------	------------	--------------	-------------	-------------

Table D.3-13 contains the actual filter functions for NOAA-17 HIRS/303. This information may also be downloaded at the following website: <http://www.orbit.nesdis.noaa.gov/smcd/spb/calibration/hirs/srf/hirssrf.html>.

Table D.3-13. Normalized Response Functions for the NOAA-17 HIRS/303 Thermal Channels.				
Channel 1				
Wave Number	HIRS Filter Transmittance	Optical Element Transmittance	Product of the HIRS Filter and Optical Element Transmittances	Normalized Value of Column 4
6.76800E+02	0.00000E+00	9.68610E-02	0.00000E+00	0.00000E+00
6.76600E+02	1.00000E-03	9.61950E-02	9.61950E-05	3.76110E-03
6.76050E+02	3.25000E-03	9.43910E-02	3.06770E-04	1.19940E-02
6.75500E+02	5.50000E-03	9.26050E-02	5.09330E-04	1.99140E-02
6.74950E+02	7.75000E-03	9.08370E-02	7.03990E-04	2.75250E-02
6.74400E+02	1.00000E-02	8.90860E-02	8.90860E-04	3.48310E-02
6.73200E+02	1.24000E-02	8.53060E-02	1.05780E-03	4.13580E-02
6.73000E+02	1.68000E-02	8.46830E-02	1.42270E-03	5.56240E-02
6.72800E+02	1.80000E-02	8.40380E-02	1.51270E-03	5.91440E-02
6.72600E+02	1.73000E-02	8.33960E-02	1.44280E-03	5.64090E-02
6.72400E+02	2.30000E-02	8.27560E-02	1.90340E-03	7.44190E-02
6.72200E+02	3.35000E-02	8.21190E-02	2.75100E-03	1.07560E-01
6.72000E+02	4.54000E-02	8.14850E-02	3.69940E-03	1.44640E-01
6.71800E+02	5.35000E-02	8.08530E-02	4.32570E-03	1.69130E-01
6.71600E+02	6.16000E-02	8.02240E-02	4.94180E-03	1.93220E-01
6.71400E+02	7.30000E-02	7.95970E-02	5.81060E-03	2.27190E-01
6.71200E+02	9.55000E-02	7.89730E-02	7.54190E-03	2.94880E-01
6.71000E+02	1.24300E-01	7.83520E-02	9.73920E-03	3.80790E-01
6.70800E+02	1.56200E-01	7.77330E-02	1.21420E-02	4.74730E-01
6.70600E+02	1.86200E-01	7.71170E-02	1.43590E-02	5.61420E-01
6.70400E+02	2.17600E-01	7.65030E-02	1.66470E-02	6.50870E-01
6.70200E+02	2.47300E-01	7.58920E-02	1.87680E-02	7.33800E-01
6.70000E+02	2.77200E-01	7.52830E-02	2.08680E-02	8.15930E-01
6.69800E+02	3.07100E-01	7.47650E-02	2.29600E-02	8.97710E-01
6.69600E+02	3.32100E-01	7.42490E-02	2.46580E-02	9.64090E-01
6.69400E+02	3.45100E-01	7.37340E-02	2.54460E-02	9.94880E-01
6.69200E+02	3.49300E-01	7.32220E-02	2.55760E-02	1.00000E+00
6.69000E+02	3.46700E-01	7.27120E-02	2.52090E-02	9.85650E-01
6.68800E+02	3.38200E-01	7.22000E-02	2.44180E-02	9.54710E-01
6.68600E+02	3.23500E-01	7.16910E-02	2.31920E-02	9.06770E-01
6.68400E+02	3.04600E-01	7.11830E-02	2.16820E-02	8.47750E-01
6.68200E+02	2.79800E-01	7.06780E-02	1.97760E-02	7.73200E-01
6.68000E+02	2.50900E-01	7.01750E-02	1.76070E-02	6.88400E-01
6.67800E+02	2.18900E-01	6.95950E-02	1.52340E-02	5.95640E-01
6.67600E+02	1.88500E-01	6.90180E-02	1.30100E-02	5.08660E-01

6.67400E+02	1.70400E-01	6.84430E-02	1.16630E-02	4.55990E-01
6.67200E+02	1.61000E-01	6.78720E-02	1.09270E-02	4.27250E-01
6.67000E+02	1.44900E-01	6.73040E-02	9.75240E-03	3.81300E-01
6.66800E+02	1.23700E-01	6.67400E-02	8.25570E-03	3.22790E-01
6.66600E+02	1.09600E-01	6.61780E-02	7.25310E-03	2.83590E-01
6.66400E+02	1.01300E-01	6.56190E-02	6.64720E-03	2.59890E-01
6.66200E+02	8.87000E-02	6.50630E-02	5.77110E-03	2.25640E-01
6.66000E+02	7.55000E-02	6.45110E-02	4.87050E-03	1.90430E-01
6.65800E+02	6.68000E-02	6.39610E-02	4.27260E-03	1.67050E-01
6.65600E+02	5.94000E-02	6.34150E-02	3.76680E-03	1.47280E-01
6.65400E+02	5.50000E-02	6.28700E-02	3.45790E-03	1.35200E-01
6.65200E+02	5.23000E-02	6.23300E-02	3.25980E-03	1.27460E-01
6.65000E+02	5.00000E-02	6.17920E-02	3.08960E-03	1.20800E-01
6.64800E+02	4.20000E-02	6.12580E-02	2.57280E-03	1.00590E-01
6.64600E+02	3.46000E-02	6.07260E-02	2.10110E-03	8.21500E-02
6.64400E+02	2.83000E-02	6.01960E-02	1.70360E-03	6.66070E-02
6.64200E+02	2.57000E-02	5.96710E-02	1.53350E-03	5.99590E-02
6.64000E+02	2.25000E-02	5.91480E-02	1.33080E-03	5.20330E-02
6.63800E+02	1.91000E-02	5.86250E-02	1.11970E-03	4.37800E-02
6.63600E+02	1.34000E-02	5.81050E-02	7.78600E-04	3.04420E-02
6.62800E+02	1.00000E-02	5.60230E-02	5.60230E-04	2.19040E-02
6.62050E+02	7.75000E-03	5.39960E-02	4.18470E-04	1.63620E-02
6.61300E+02	5.50000E-03	5.20180E-02	2.86100E-04	1.11860E-02
6.60550E+02	3.25000E-03	5.00870E-02	1.62780E-04	6.36460E-03
6.59800E+02	1.00000E-03	4.82030E-02	4.82030E-05	1.88470E-03
6.59600E+02	0.00000E+00	4.77090E-02	0.00000E+00	0.00000E+00

Channel 2

Wave Number	HIRS Filter Transmittance	Optical Element Transmittance	Product of the HIRS Filter and Optical Element Transmittances	Normalized Value of Column 4
6.97800E+02	0.00000E+00	1.90310E-01	0.00000E+00	0.00000E+00
6.97700E+02	1.00000E-03	1.89890E-01	1.89890E-04	2.46560E-03
6.96230E+02	3.25000E-03	1.83440E-01	5.96180E-04	7.74120E-03
6.94750E+02	5.50000E-03	1.76640E-01	9.71490E-04	1.26150E-02
6.93270E+02	7.75000E-03	1.69980E-01	1.31730E-03	1.71050E-02
6.91800E+02	1.00000E-02	1.63400E-01	1.63400E-03	2.12170E-02
6.90900E+02	1.20000E-02	1.59450E-01	1.91340E-03	2.48450E-02
6.90700E+02	1.60000E-02	1.58580E-01	2.53730E-03	3.29460E-02
6.90500E+02	1.76000E-02	1.57720E-01	2.77580E-03	3.60430E-02
6.90300E+02	1.58000E-02	1.56850E-01	2.47830E-03	3.21790E-02
6.90100E+02	1.50000E-02	1.55990E-01	2.33990E-03	3.03830E-02
6.89900E+02	1.55000E-02	1.55090E-01	2.40390E-03	3.12140E-02
6.89700E+02	1.87000E-02	1.54190E-01	2.88330E-03	3.74390E-02
6.89500E+02	2.44000E-02	1.53290E-01	3.74020E-03	4.85650E-02
6.89300E+02	2.72000E-02	1.52390E-01	4.14490E-03	5.38210E-02
6.89100E+02	3.00000E-02	1.51490E-01	4.54480E-03	5.90130E-02
6.88900E+02	3.90000E-02	1.50600E-01	5.87330E-03	7.62630E-02

6.88700E+02	5.09000E-02	1.49700E-01	7.61990E-03	9.89420E-02
6.88500E+02	5.44000E-02	1.48810E-01	8.09540E-03	1.05120E-01
6.88300E+02	5.62000E-02	1.47930E-01	8.31340E-03	1.07950E-01
6.88100E+02	6.41000E-02	1.47040E-01	9.42530E-03	1.22380E-01
6.87900E+02	7.52000E-02	1.46090E-01	1.09860E-02	1.42650E-01
6.87700E+02	8.69000E-02	1.45080E-01	1.26070E-02	1.63700E-01
6.87500E+02	9.89000E-02	1.44070E-01	1.42490E-02	1.85020E-01
6.87300E+02	1.11100E-01	1.43070E-01	1.58950E-02	2.06390E-01
6.87100E+02	1.25400E-01	1.42070E-01	1.78160E-02	2.31340E-01
6.86900E+02	1.45900E-01	1.41080E-01	2.05840E-02	2.67270E-01
6.86700E+02	1.66900E-01	1.40090E-01	2.33810E-02	3.03600E-01
6.86500E+02	1.84800E-01	1.39110E-01	2.57070E-02	3.33800E-01
6.86300E+02	2.01900E-01	1.38130E-01	2.78880E-02	3.62120E-01
6.86100E+02	2.22900E-01	1.37150E-01	3.05710E-02	3.96960E-01
6.85900E+02	2.50000E-01	1.36180E-01	3.40450E-02	4.42070E-01
6.85700E+02	2.84200E-01	1.35220E-01	3.84280E-02	4.98980E-01
6.85500E+02	3.22000E-01	1.34250E-01	4.32300E-02	5.61320E-01
6.85300E+02	3.56800E-01	1.33300E-01	4.75600E-02	6.17550E-01
6.85100E+02	3.91200E-01	1.32340E-01	5.17730E-02	6.72250E-01
6.84900E+02	4.25500E-01	1.31390E-01	5.59080E-02	7.25950E-01
6.84700E+02	4.60000E-01	1.30450E-01	6.00070E-02	7.79170E-01
6.84500E+02	4.88500E-01	1.29510E-01	6.32660E-02	8.21490E-01
6.84300E+02	5.13900E-01	1.28570E-01	6.60750E-02	8.57960E-01
6.84100E+02	5.38300E-01	1.27640E-01	6.87110E-02	8.92190E-01
6.83900E+02	5.63000E-01	1.26710E-01	7.13390E-02	9.26320E-01
6.83700E+02	5.84900E-01	1.25780E-01	7.35710E-02	9.55300E-01
6.83500E+02	6.02300E-01	1.24860E-01	7.52030E-02	9.76490E-01
6.83300E+02	6.15400E-01	1.23930E-01	7.62660E-02	9.90290E-01
6.83100E+02	6.25000E-01	1.22990E-01	7.68710E-02	9.98140E-01
6.82900E+02	6.30900E-01	1.22070E-01	7.70140E-02	1.00000E+00
6.82700E+02	6.32800E-01	1.21160E-01	7.66700E-02	9.95540E-01
6.82500E+02	6.31900E-01	1.20260E-01	7.59900E-02	9.86700E-01
6.82300E+02	6.30900E-01	1.19360E-01	7.53010E-02	9.77760E-01
6.82100E+02	6.27200E-01	1.18460E-01	7.42970E-02	9.64730E-01
6.81900E+02	6.22400E-01	1.17570E-01	7.31730E-02	9.50120E-01
6.81700E+02	6.16000E-01	1.16680E-01	7.18730E-02	9.33250E-01
6.81500E+02	6.14800E-01	1.15790E-01	7.11890E-02	9.24370E-01
6.81300E+02	6.13900E-01	1.14910E-01	7.05450E-02	9.16000E-01
6.81100E+02	6.10800E-01	1.14040E-01	6.96540E-02	9.04430E-01
6.80900E+02	5.99700E-01	1.13160E-01	6.78650E-02	8.81200E-01
6.80700E+02	5.93200E-01	1.12300E-01	6.66140E-02	8.64970E-01
6.80500E+02	5.91000E-01	1.11430E-01	6.58570E-02	8.55130E-01
6.80300E+02	5.93700E-01	1.10570E-01	6.56480E-02	8.52410E-01
6.80100E+02	5.94000E-01	1.09720E-01	6.51730E-02	8.46250E-01
6.79900E+02	5.96200E-01	1.08870E-01	6.49060E-02	8.42780E-01
6.79700E+02	5.98400E-01	1.08020E-01	6.46380E-02	8.39310E-01
6.79500E+02	5.99800E-01	1.07180E-01	6.42840E-02	8.34700E-01
6.79300E+02	5.96800E-01	1.06340E-01	6.34610E-02	8.24020E-01
6.79100E+02	5.91500E-01	1.05500E-01	6.24040E-02	8.10290E-01

6.78900E+02	5.89100E-01	1.04670E-01	6.16590E-02	8.00620E-01
6.78700E+02	5.90100E-01	1.03830E-01	6.12720E-02	7.95590E-01
6.78500E+02	5.92600E-01	1.03000E-01	6.10400E-02	7.92590E-01
6.78300E+02	5.93500E-01	1.02180E-01	6.06440E-02	7.87440E-01
6.78100E+02	5.96500E-01	1.01360E-01	6.04610E-02	7.85060E-01
6.77900E+02	6.01500E-01	1.00610E-01	6.05140E-02	7.85760E-01
6.77700E+02	6.01000E-01	9.99190E-02	6.00520E-02	7.79750E-01
6.77500E+02	5.98600E-01	9.92360E-02	5.94020E-02	7.71320E-01
6.77300E+02	5.98200E-01	9.85540E-02	5.89550E-02	7.65510E-01
6.77100E+02	5.99900E-01	9.78750E-02	5.87150E-02	7.62400E-01
6.76900E+02	5.96600E-01	9.71980E-02	5.79880E-02	7.52960E-01
6.76700E+02	5.91500E-01	9.65240E-02	5.70940E-02	7.41350E-01
6.76500E+02	5.86100E-01	9.58650E-02	5.61870E-02	7.29560E-01
6.76300E+02	5.79700E-01	9.52090E-02	5.51920E-02	7.16660E-01
6.76100E+02	5.69200E-01	9.45550E-02	5.38200E-02	6.98840E-01
6.75900E+02	5.55500E-01	9.39020E-02	5.21630E-02	6.77310E-01
6.75700E+02	5.46600E-01	9.32520E-02	5.09720E-02	6.61850E-01
6.75500E+02	5.41100E-01	9.26050E-02	5.01090E-02	6.50650E-01
6.75300E+02	5.31200E-01	9.19600E-02	4.88490E-02	6.34290E-01
6.75100E+02	5.13700E-01	9.13180E-02	4.69100E-02	6.09110E-01
6.74900E+02	4.95500E-01	9.06770E-02	4.49300E-02	5.83410E-01
6.74700E+02	4.80500E-01	9.00390E-02	4.32640E-02	5.61770E-01
6.74500E+02	4.65300E-01	8.94030E-02	4.15990E-02	5.40150E-01
6.74300E+02	4.45300E-01	8.87700E-02	3.95290E-02	5.13270E-01
6.74100E+02	4.21200E-01	8.81390E-02	3.71240E-02	4.82040E-01
6.73900E+02	4.01200E-01	8.75060E-02	3.51080E-02	4.55860E-01
6.73700E+02	3.83300E-01	8.68750E-02	3.32990E-02	4.32380E-01
6.73500E+02	3.65600E-01	8.62460E-02	3.15310E-02	4.09430E-01
6.73300E+02	3.43600E-01	8.56190E-02	2.94190E-02	3.81990E-01
6.73100E+02	3.22400E-01	8.49940E-02	2.74020E-02	3.55810E-01
6.72900E+02	2.99800E-01	8.43600E-02	2.52910E-02	3.28400E-01
6.72700E+02	2.76400E-01	8.37160E-02	2.31390E-02	3.00460E-01
6.72500E+02	2.49200E-01	8.30760E-02	2.07020E-02	2.68810E-01
6.72300E+02	2.26900E-01	8.24380E-02	1.87050E-02	2.42880E-01
6.72100E+02	2.11100E-01	8.18020E-02	1.72680E-02	2.24220E-01
6.71900E+02	1.96400E-01	8.11680E-02	1.59410E-02	2.07000E-01
6.71700E+02	1.76900E-01	8.05380E-02	1.42470E-02	1.85000E-01
6.71500E+02	1.57900E-01	7.99100E-02	1.26180E-02	1.63840E-01
6.71300E+02	1.42900E-01	7.92850E-02	1.13300E-02	1.47110E-01
6.71100E+02	1.31900E-01	7.86630E-02	1.03760E-02	1.34720E-01
6.70900E+02	1.22100E-01	7.80420E-02	9.52890E-03	1.23730E-01
6.70700E+02	1.10300E-01	7.74240E-02	8.53990E-03	1.10890E-01
6.70500E+02	9.60000E-02	7.68100E-02	7.37370E-03	9.57450E-02
6.70300E+02	8.33000E-02	7.61970E-02	6.34720E-03	8.24170E-02
6.70100E+02	7.75000E-02	7.55870E-02	5.85800E-03	7.60650E-02
6.69900E+02	7.19000E-02	7.50230E-02	5.39420E-03	7.00420E-02
6.69700E+02	6.28000E-02	7.45060E-02	4.67900E-03	6.07550E-02
6.69500E+02	5.39000E-02	7.39910E-02	3.98810E-03	5.17840E-02
6.69300E+02	5.33000E-02	7.34780E-02	3.91640E-03	5.08530E-02

6.69100E+02	5.20000E-02	7.29670E-02	3.79430E-03	4.92680E-02
6.68900E+02	4.42000E-02	7.24560E-02	3.20250E-03	4.15840E-02
6.68700E+02	3.63000E-02	7.19450E-02	2.61160E-03	3.39110E-02
6.68500E+02	3.47000E-02	7.14370E-02	2.47890E-03	3.21870E-02
6.68300E+02	3.14000E-02	7.09300E-02	2.22720E-03	2.89200E-02
6.68100E+02	2.54000E-02	7.04260E-02	1.78880E-03	2.32270E-02
6.67900E+02	1.86000E-02	6.98840E-02	1.29980E-03	1.68780E-02
6.67700E+02	1.42000E-02	6.93050E-02	9.84140E-04	1.27790E-02
6.67500E+02	1.37000E-02	6.87300E-02	9.41600E-04	1.22260E-02
6.67300E+02	2.11000E-02	6.81580E-02	1.43810E-03	1.86740E-02
6.67100E+02	2.53000E-02	6.75880E-02	1.71000E-03	2.22040E-02
6.66900E+02	1.87000E-02	6.70210E-02	1.25330E-03	1.62740E-02
6.66600E+02	1.54000E-02	6.61780E-02	1.01910E-03	1.32330E-02
6.66400E+02	1.00000E-02	6.56190E-02	6.56190E-04	8.52040E-03
6.64770E+02	7.75000E-03	6.11910E-02	4.74230E-04	6.15770E-03
6.63150E+02	5.50000E-03	5.69500E-02	3.13220E-04	4.06710E-03
6.61520E+02	3.25000E-03	5.26060E-02	1.70970E-04	2.22000E-03
6.59900E+02	1.00000E-03	4.84510E-02	4.84510E-05	6.29130E-04
6.59800E+02	0.00000E+00	4.82030E-02	0.00000E+00	0.00000E+00
Channel 3				
Wave Number	HIRS Filter Transmittance	Optical Element Transmittance	Product of the HIRS Filter and Optical Element Transmittances	Normalized Value of Column 4
7.12070E+02	0.00000E+00	2.40200E-01	0.00000E+00	0.00000E+00
7.11570E+02	1.00000E-03	2.39180E-01	2.39180E-04	2.33720E-03
7.09920E+02	3.25000E-03	2.35510E-01	7.65400E-04	7.47940E-03
7.08270E+02	5.50000E-03	2.30370E-01	1.26710E-03	1.23810E-02
7.06620E+02	7.75000E-03	2.24360E-01	1.73880E-03	1.69910E-02
7.04970E+02	1.00000E-02	2.18280E-01	2.18280E-03	2.13300E-02
7.04570E+02	1.16000E-02	2.16820E-01	2.51510E-03	2.45770E-02
7.04070E+02	1.34000E-02	2.15010E-01	2.88110E-03	2.81530E-02
7.03570E+02	1.62000E-02	2.13190E-01	3.45380E-03	3.37490E-02
7.03070E+02	2.11000E-02	2.11230E-01	4.45690E-03	4.35520E-02
7.02570E+02	2.94000E-02	2.09200E-01	6.15040E-03	6.01010E-02
7.02070E+02	3.93000E-02	2.07170E-01	8.14180E-03	7.95600E-02
7.01570E+02	4.96000E-02	2.05160E-01	1.01760E-02	9.94360E-02
7.01070E+02	6.09000E-02	2.03160E-01	1.23720E-02	1.20900E-01
7.00570E+02	7.81000E-02	2.01170E-01	1.57110E-02	1.53530E-01
7.00070E+02	1.04100E-01	1.99190E-01	2.07360E-02	2.02630E-01
6.99570E+02	1.39500E-01	1.97230E-01	2.75130E-02	2.68850E-01
6.99070E+02	1.83200E-01	1.95270E-01	3.57740E-02	3.49580E-01
6.98570E+02	2.34300E-01	1.93340E-01	4.52990E-02	4.42660E-01
6.98070E+02	2.91900E-01	1.91420E-01	5.58740E-02	5.45990E-01
6.97570E+02	3.53400E-01	1.89340E-01	6.69130E-02	6.53860E-01
6.97070E+02	4.16400E-01	1.87250E-01	7.79730E-02	7.61930E-01
6.96570E+02	4.75100E-01	1.85050E-01	8.79190E-02	8.59120E-01
6.96070E+02	5.22700E-01	1.82720E-01	9.55060E-02	9.33270E-01

6.95570E+02	5.55800E-01	1.80400E-01	1.00270E-01	9.79770E-01
6.95070E+02	5.74600E-01	1.78100E-01	1.02340E-01	1.00000E+00
6.94570E+02	5.79800E-01	1.75820E-01	1.01940E-01	9.96120E-01
6.94070E+02	5.74800E-01	1.73550E-01	9.97570E-02	9.74810E-01
6.93570E+02	5.64300E-01	1.71300E-01	9.66640E-02	9.44590E-01
6.93070E+02	5.49400E-01	1.69060E-01	9.28840E-02	9.07650E-01
6.92570E+02	5.30000E-01	1.66820E-01	8.84160E-02	8.63980E-01
6.92070E+02	5.09500E-01	1.64590E-01	8.38610E-02	8.19470E-01
6.91570E+02	4.94800E-01	1.62380E-01	8.03480E-02	7.85140E-01
6.91070E+02	4.85500E-01	1.60190E-01	7.77730E-02	7.59990E-01
6.90570E+02	4.77600E-01	1.58020E-01	7.54700E-02	7.37470E-01
6.90070E+02	4.70500E-01	1.55860E-01	7.33310E-02	7.16580E-01
6.89570E+02	4.65500E-01	1.53600E-01	7.15010E-02	6.98700E-01
6.89070E+02	4.65200E-01	1.51360E-01	7.04120E-02	6.88050E-01
6.88570E+02	4.66500E-01	1.49120E-01	6.95660E-02	6.79790E-01
6.88070E+02	4.63000E-01	1.46910E-01	6.80180E-02	6.64660E-01
6.87570E+02	4.53300E-01	1.44430E-01	6.54680E-02	6.39740E-01
6.87070E+02	4.42900E-01	1.41920E-01	6.28580E-02	6.14240E-01
6.86570E+02	4.35200E-01	1.39450E-01	6.06890E-02	5.93040E-01
6.86070E+02	4.26000E-01	1.37010E-01	5.83650E-02	5.70330E-01
6.85570E+02	4.10900E-01	1.34590E-01	5.53030E-02	5.40410E-01
6.85070E+02	3.87400E-01	1.32200E-01	5.12150E-02	5.00460E-01
6.84570E+02	3.60600E-01	1.29840E-01	4.68200E-02	4.57510E-01
6.84070E+02	3.35900E-01	1.27500E-01	4.28290E-02	4.18510E-01
6.83570E+02	3.11300E-01	1.25180E-01	3.89700E-02	3.80800E-01
6.83070E+02	2.85200E-01	1.22850E-01	3.50380E-02	3.42380E-01
6.82570E+02	2.54600E-01	1.20570E-01	3.06980E-02	2.99970E-01
6.82070E+02	2.20100E-01	1.18320E-01	2.60430E-02	2.54490E-01
6.81570E+02	1.87300E-01	1.16100E-01	2.17460E-02	2.12500E-01
6.81070E+02	1.60700E-01	1.13910E-01	1.83050E-02	1.78870E-01
6.80570E+02	1.37200E-01	1.11740E-01	1.53300E-02	1.49800E-01
6.80070E+02	1.14900E-01	1.09590E-01	1.25920E-02	1.23050E-01
6.79570E+02	9.53000E-02	1.07470E-01	1.02420E-02	1.00080E-01
6.79070E+02	7.80000E-02	1.05380E-01	8.21930E-03	8.03170E-02
6.78570E+02	6.41000E-02	1.03290E-01	6.62120E-03	6.47010E-02
6.78070E+02	5.48000E-02	1.01240E-01	5.54770E-03	5.42110E-02
6.77570E+02	4.91000E-02	9.94750E-02	4.88420E-03	4.77280E-02
6.77070E+02	4.13000E-02	9.77740E-02	4.03800E-03	3.94590E-02
6.76570E+02	2.88000E-02	9.60960E-02	2.76760E-03	2.70440E-02
6.76070E+02	1.78000E-02	9.44570E-02	1.68130E-03	1.64300E-02
6.75570E+02	1.39000E-02	9.28320E-02	1.29040E-03	1.26090E-02
6.75070E+02	1.51000E-02	9.12220E-02	1.37740E-03	1.34600E-02
6.74570E+02	1.57000E-02	8.96260E-02	1.40710E-03	1.37500E-02
6.74070E+02	1.00000E-02	8.80440E-02	8.80440E-04	8.60350E-03
6.72220E+02	7.75000E-03	8.21830E-02	6.36920E-04	6.22380E-03
6.70370E+02	5.50000E-03	7.64110E-02	4.20260E-04	4.10670E-03
6.68520E+02	3.25000E-03	7.14880E-02	2.32330E-04	2.27030E-03
6.66670E+02	1.00000E-03	6.63740E-02	6.63740E-05	6.48590E-04
6.66570E+02	0.00000E+00	6.60940E-02	0.00000E+00	0.00000E+00

Channel 4				
Wave Number	HIRS Filter Transmittance	Optical Element Transmittance	Product of the HIRS Filter and Optical Element Transmittances	Normalized Value of Column 4
7.22100E+02	0.00000E+00	2.52810E-01	0.00000E+00	0.00000E+00
7.21800E+02	2.00000E-03	2.52590E-01	5.05180E-04	3.15480E-03
7.21500E+02	3.00000E-03	2.52370E-01	7.57110E-04	4.72800E-03
7.21200E+02	5.00000E-03	2.52150E-01	1.26070E-03	7.87320E-03
7.20900E+02	6.00000E-03	2.51930E-01	1.51160E-03	9.43960E-03
7.20600E+02	6.00000E-03	2.51710E-01	1.51030E-03	9.43140E-03
7.20300E+02	6.00000E-03	2.51490E-01	1.50890E-03	9.42310E-03
7.20000E+02	6.00000E-03	2.51270E-01	1.50760E-03	9.41490E-03
7.19700E+02	6.00000E-03	2.51050E-01	1.50630E-03	9.40670E-03
7.19400E+02	6.00000E-03	2.50830E-01	1.50500E-03	9.39850E-03
7.19100E+02	6.00000E-03	2.50620E-01	1.50370E-03	9.39030E-03
7.18800E+02	7.00000E-03	2.50390E-01	1.75270E-03	1.09460E-02
7.18500E+02	9.00000E-03	2.50170E-01	2.25150E-03	1.40600E-02
7.18200E+02	1.20000E-02	2.49940E-01	2.99930E-03	1.87300E-02
7.17900E+02	1.30000E-02	2.49710E-01	3.24620E-03	2.02720E-02
7.17600E+02	1.50000E-02	2.49470E-01	3.74200E-03	2.33680E-02
7.17300E+02	1.60000E-02	2.49230E-01	3.98760E-03	2.49020E-02
7.17000E+02	1.80000E-02	2.48980E-01	4.48170E-03	2.79880E-02
7.16700E+02	2.00000E-02	2.48550E-01	4.97110E-03	3.10440E-02
7.16400E+02	2.40000E-02	2.48030E-01	5.95280E-03	3.71740E-02
7.16100E+02	2.70000E-02	2.47510E-01	6.68280E-03	4.17330E-02
7.15800E+02	3.10000E-02	2.46990E-01	7.65660E-03	4.78150E-02
7.15500E+02	3.60000E-02	2.46470E-01	8.87280E-03	5.54090E-02
7.15200E+02	4.20000E-02	2.45950E-01	1.03300E-02	6.45080E-02
7.14900E+02	4.80000E-02	2.45430E-01	1.17810E-02	7.35680E-02
7.14600E+02	5.50000E-02	2.44910E-01	1.34700E-02	8.41180E-02
7.14300E+02	6.30000E-02	2.44390E-01	1.53970E-02	9.61500E-02
7.14000E+02	7.00000E-02	2.43870E-01	1.70710E-02	1.06610E-01
7.13700E+02	7.80000E-02	2.43350E-01	1.89810E-02	1.18530E-01
7.13400E+02	9.30000E-02	2.42820E-01	2.25820E-02	1.41020E-01
7.13100E+02	1.07000E-01	2.42300E-01	2.59260E-02	1.61900E-01
7.12800E+02	1.20000E-01	2.41710E-01	2.90050E-02	1.81130E-01
7.12500E+02	1.39000E-01	2.41090E-01	3.35120E-02	2.09270E-01
7.12200E+02	1.52000E-01	2.40470E-01	3.65520E-02	2.28260E-01
7.11900E+02	1.79000E-01	2.39850E-01	4.29340E-02	2.68120E-01
7.11600E+02	2.00000E-01	2.39240E-01	4.78480E-02	2.98800E-01
7.11300E+02	2.23000E-01	2.38620E-01	5.32130E-02	3.32310E-01
7.11000E+02	2.44000E-01	2.38010E-01	5.80740E-02	3.62670E-01
7.10700E+02	2.75000E-01	2.37400E-01	6.52840E-02	4.07690E-01
7.10400E+02	2.99000E-01	2.36790E-01	7.07990E-02	4.42130E-01
7.10100E+02	3.27000E-01	2.36070E-01	7.71940E-02	4.82070E-01
7.09800E+02	3.55000E-01	2.35140E-01	8.34730E-02	5.21280E-01
7.09500E+02	3.83000E-01	2.34200E-01	8.97000E-02	5.60160E-01

7.09200E+02	4.18000E-01	2.33270E-01	9.75080E-02	6.08920E-01
7.08900E+02	4.49000E-01	2.32340E-01	1.04320E-01	6.51470E-01
7.08600E+02	4.73000E-01	2.31400E-01	1.09450E-01	6.83520E-01
7.08300E+02	4.99000E-01	2.30470E-01	1.15000E-01	7.18180E-01
7.08000E+02	5.31000E-01	2.29530E-01	1.21880E-01	7.61140E-01
7.07700E+02	5.51000E-01	2.28400E-01	1.25850E-01	7.85910E-01
7.07400E+02	5.71000E-01	2.27270E-01	1.29770E-01	8.10420E-01
7.07100E+02	6.03000E-01	2.26150E-01	1.36370E-01	8.51610E-01
7.06800E+02	6.21000E-01	2.25030E-01	1.39740E-01	8.72680E-01
7.06500E+02	6.40000E-01	2.23910E-01	1.43300E-01	8.94920E-01
7.06200E+02	6.58000E-01	2.22800E-01	1.46600E-01	9.15510E-01
7.05900E+02	6.74000E-01	2.21690E-01	1.49420E-01	9.33110E-01
7.05600E+02	6.87000E-01	2.20590E-01	1.51540E-01	9.46360E-01
7.05300E+02	7.03000E-01	2.19480E-01	1.54300E-01	9.63570E-01
7.05000E+02	7.16000E-01	2.18390E-01	1.56360E-01	9.76470E-01
7.04700E+02	7.26000E-01	2.17290E-01	1.57750E-01	9.85150E-01
7.04400E+02	7.34000E-01	2.16200E-01	1.58690E-01	9.91000E-01
7.04100E+02	7.43000E-01	2.15110E-01	1.59830E-01	9.98120E-01
7.03800E+02	7.48000E-01	2.14030E-01	1.60090E-01	9.99750E-01
7.03500E+02	7.52000E-01	2.12940E-01	1.60130E-01	1.00000E+00
7.03200E+02	7.55000E-01	2.11750E-01	1.59870E-01	9.98350E-01
7.02900E+02	7.58000E-01	2.10540E-01	1.59590E-01	9.96620E-01
7.02600E+02	7.57000E-01	2.09320E-01	1.58460E-01	9.89530E-01
7.02300E+02	7.56000E-01	2.08100E-01	1.57320E-01	9.82470E-01
7.02000E+02	7.55000E-01	2.06890E-01	1.56200E-01	9.75450E-01
7.01700E+02	7.54000E-01	2.05680E-01	1.55080E-01	9.68470E-01
7.01400E+02	7.51000E-01	2.04480E-01	1.53560E-01	9.58960E-01
7.01100E+02	7.49000E-01	2.03280E-01	1.52250E-01	9.50800E-01
7.00800E+02	7.47000E-01	2.02080E-01	1.50950E-01	9.42690E-01
7.00500E+02	7.44000E-01	2.00890E-01	1.49460E-01	9.33370E-01
7.00200E+02	7.41000E-01	1.99700E-01	1.47980E-01	9.24110E-01
6.99900E+02	7.40000E-01	1.98520E-01	1.46910E-01	9.17400E-01
6.99600E+02	7.37000E-01	1.97340E-01	1.45440E-01	9.08270E-01
6.99300E+02	7.33000E-01	1.96170E-01	1.43790E-01	8.97970E-01
6.99000E+02	7.30000E-01	1.95000E-01	1.42350E-01	8.88970E-01
6.98700E+02	7.26000E-01	1.93840E-01	1.40730E-01	8.78830E-01
6.98400E+02	7.18000E-01	1.92680E-01	1.38350E-01	8.63950E-01
6.98100E+02	7.12000E-01	1.91530E-01	1.36370E-01	8.51610E-01
6.97800E+02	7.03000E-01	1.90310E-01	1.33780E-01	8.35470E-01
6.97500E+02	6.91000E-01	1.89050E-01	1.30630E-01	8.15780E-01
6.97200E+02	6.72000E-01	1.87790E-01	1.26200E-01	7.88090E-01
6.96900E+02	6.53000E-01	1.86550E-01	1.21820E-01	7.60720E-01
6.96600E+02	6.25000E-01	1.85190E-01	1.15750E-01	7.22820E-01
6.96300E+02	6.00000E-01	1.83790E-01	1.10270E-01	6.88640E-01
6.96000E+02	5.65000E-01	1.82390E-01	1.03050E-01	6.43540E-01
6.95700E+02	5.34000E-01	1.81000E-01	9.66530E-02	6.03590E-01
6.95400E+02	4.90000E-01	1.79610E-01	8.80110E-02	5.49610E-01
6.95100E+02	4.48000E-01	1.78240E-01	7.98500E-02	4.98650E-01
6.94800E+02	4.14000E-01	1.76860E-01	7.32220E-02	4.57260E-01

6.94500E+02	3.72000E-01	1.75500E-01	6.52850E-02	4.07700E-01
6.94200E+02	3.33000E-01	1.74140E-01	5.79880E-02	3.62130E-01
6.93900E+02	2.93000E-01	1.72780E-01	5.06260E-02	3.16150E-01
6.93600E+02	2.52000E-01	1.71430E-01	4.32010E-02	2.69790E-01
6.93300E+02	2.22000E-01	1.70090E-01	3.77600E-02	2.35810E-01
6.93000E+02	1.93000E-01	1.68750E-01	3.25690E-02	2.03390E-01
6.92700E+02	1.63000E-01	1.67400E-01	2.72870E-02	1.70400E-01
6.92400E+02	1.40000E-01	1.66060E-01	2.32490E-02	1.45180E-01
6.92100E+02	1.20000E-01	1.64730E-01	1.97670E-02	1.23440E-01
6.91800E+02	1.02000E-01	1.63400E-01	1.66670E-02	1.04080E-01
6.91500E+02	8.90000E-02	1.62080E-01	1.44250E-02	9.00800E-02
6.91200E+02	7.50000E-02	1.60760E-01	1.20570E-02	7.52940E-02
6.90900E+02	6.30000E-02	1.59450E-01	1.00450E-02	6.27320E-02
6.90600E+02	5.40000E-02	1.58150E-01	8.54000E-03	5.33310E-02
6.90300E+02	4.50000E-02	1.56850E-01	7.05830E-03	4.40780E-02
6.90000E+02	3.80000E-02	1.55550E-01	5.91070E-03	3.69120E-02
6.89700E+02	3.20000E-02	1.54190E-01	4.93400E-03	3.08120E-02
6.89400E+02	2.90000E-02	1.52840E-01	4.43220E-03	2.76790E-02
6.89100E+02	2.90000E-02	1.51490E-01	4.39330E-03	2.74350E-02
6.88800E+02	2.70000E-02	1.50150E-01	4.05410E-03	2.53170E-02
6.88500E+02	2.40000E-02	1.48810E-01	3.57150E-03	2.23030E-02
6.88200E+02	1.90000E-02	1.47480E-01	2.80220E-03	1.74990E-02
6.87900E+02	1.30000E-02	1.46090E-01	1.89920E-03	1.18600E-02
6.87600E+02	1.00000E-02	1.44580E-01	1.44580E-03	9.02860E-03
6.87300E+02	7.00000E-03	1.43070E-01	1.00150E-03	6.25420E-03
6.87000E+02	6.00000E-03	1.41580E-01	8.49460E-04	5.30470E-03
6.86700E+02	5.00000E-03	1.40090E-01	7.00460E-04	4.37420E-03
6.86400E+02	6.00000E-03	1.38620E-01	8.31700E-04	5.19380E-03
6.86100E+02	8.00000E-03	1.37150E-01	1.09720E-03	6.85200E-03
6.85800E+02	1.00000E-02	1.35700E-01	1.35700E-03	8.47410E-03
6.85500E+02	9.00000E-03	1.34250E-01	1.20830E-03	7.54550E-03
6.85200E+02	7.00000E-03	1.32820E-01	9.29730E-04	5.80600E-03
6.84900E+02	3.00000E-03	1.31390E-01	3.94180E-04	2.46160E-03
6.84600E+02	2.00000E-03	1.29980E-01	2.59960E-04	1.62340E-03
6.84300E+02	2.00000E-03	1.28570E-01	2.57150E-04	1.60590E-03
6.84000E+02	1.00000E-03	1.27180E-01	1.27180E-04	7.94220E-04
6.83700E+02	1.00000E-03	1.25780E-01	1.25780E-04	7.85500E-04
6.83400E+02	1.00000E-03	1.24400E-01	1.24400E-04	7.76850E-04
6.83100E+02	5.00000E-03	1.22990E-01	6.14970E-04	3.84040E-03
6.82800E+02	6.00000E-03	1.21620E-01	7.29690E-04	4.55680E-03
6.82500E+02	5.00000E-03	1.20260E-01	6.01280E-04	3.75490E-03
6.82200E+02	2.00000E-03	1.18910E-01	2.37810E-04	1.48510E-03
6.81900E+02	0.00000E+00	1.17570E-01	0.00000E+00	0.00000E+00
Channel 5				
Wave Number	HIRS Filter Transmittance	Optical Element Transmittance	Product of the HIRS Filter and Optical Element Transmittances	Normalized Value of Column 4

7.43500E+02	0.00000E+00	2.94260E-01	0.00000E+00	0.00000E+00
7.43260E+02	1.00000E-03	2.93600E-01	2.93600E-04	1.79100E-03
7.41100E+02	3.25000E-03	2.87730E-01	9.35130E-04	5.70450E-03
7.38940E+02	5.50000E-03	2.81940E-01	1.55070E-03	9.45950E-03
7.36770E+02	7.75000E-03	2.76490E-01	2.14280E-03	1.30710E-02
7.34610E+02	1.00000E-02	2.70870E-01	2.70870E-03	1.65240E-02
7.33710E+02	1.20000E-02	2.68560E-01	3.22270E-03	1.96590E-02
7.33210E+02	1.27000E-02	2.67280E-01	3.39450E-03	2.07070E-02
7.32710E+02	1.56000E-02	2.66030E-01	4.15010E-03	2.53160E-02
7.32210E+02	1.93000E-02	2.64800E-01	5.11060E-03	3.11760E-02
7.31710E+02	2.33000E-02	2.63570E-01	6.14120E-03	3.74620E-02
7.31210E+02	3.04000E-02	2.62340E-01	7.97530E-03	4.86510E-02
7.30710E+02	3.84000E-02	2.61120E-01	1.00270E-02	6.11680E-02
7.30210E+02	4.48000E-02	2.60010E-01	1.16480E-02	7.10570E-02
7.29710E+02	5.14000E-02	2.59370E-01	1.33310E-02	8.13240E-02
7.29210E+02	6.10000E-02	2.58730E-01	1.57830E-02	9.62780E-02
7.28710E+02	7.17000E-02	2.58100E-01	1.85060E-02	1.12890E-01
7.28210E+02	8.44000E-02	2.57470E-01	2.17310E-02	1.32560E-01
7.27710E+02	1.03500E-01	2.56990E-01	2.65980E-02	1.62260E-01
7.27210E+02	1.26700E-01	2.56610E-01	3.25120E-02	1.98330E-01
7.26710E+02	1.53100E-01	2.56230E-01	3.92290E-02	2.39300E-01
7.26210E+02	1.83100E-01	2.55850E-01	4.68460E-02	2.85770E-01
7.25710E+02	2.16800E-01	2.55470E-01	5.53860E-02	3.37870E-01
7.25210E+02	2.53800E-01	2.55090E-01	6.47430E-02	3.94940E-01
7.24710E+02	2.94300E-01	2.54720E-01	7.49630E-02	4.57290E-01
7.24210E+02	3.36500E-01	2.54340E-01	8.55850E-02	5.22090E-01
7.23710E+02	3.78100E-01	2.53960E-01	9.60210E-02	5.85750E-01
7.23210E+02	4.18800E-01	2.53610E-01	1.06210E-01	6.47920E-01
7.22710E+02	4.57900E-01	2.53260E-01	1.15970E-01	7.07420E-01
7.22210E+02	4.93300E-01	2.52890E-01	1.24750E-01	7.61010E-01
7.21710E+02	5.25900E-01	2.52520E-01	1.32800E-01	8.10120E-01
7.21210E+02	5.53600E-01	2.52160E-01	1.39590E-01	8.51550E-01
7.20710E+02	5.76500E-01	2.51790E-01	1.45160E-01	8.85490E-01
7.20210E+02	5.96300E-01	2.51430E-01	1.49920E-01	9.14580E-01
7.19710E+02	6.13000E-01	2.51060E-01	1.53900E-01	9.38820E-01
7.19210E+02	6.24600E-01	2.50700E-01	1.56580E-01	9.55200E-01
7.18710E+02	6.33400E-01	2.50320E-01	1.58560E-01	9.67220E-01
7.18210E+02	6.45100E-01	2.49950E-01	1.61240E-01	9.83610E-01
7.17710E+02	6.53100E-01	2.49560E-01	1.62990E-01	9.94250E-01
7.17210E+02	6.55900E-01	2.49150E-01	1.63420E-01	9.96900E-01
7.16710E+02	6.58900E-01	2.48570E-01	1.63780E-01	9.99120E-01
7.16210E+02	6.61800E-01	2.47700E-01	1.63930E-01	1.00000E+00
7.15710E+02	6.60100E-01	2.46830E-01	1.62930E-01	9.93930E-01
7.15210E+02	6.58300E-01	2.45960E-01	1.61920E-01	9.87740E-01
7.14710E+02	6.62100E-01	2.45100E-01	1.62280E-01	9.89940E-01
7.14210E+02	6.65100E-01	2.44240E-01	1.62440E-01	9.90930E-01
7.13710E+02	6.65100E-01	2.43370E-01	1.61860E-01	9.87400E-01
7.13210E+02	6.65100E-01	2.42490E-01	1.61280E-01	9.83850E-01
7.12710E+02	6.67900E-01	2.41520E-01	1.61310E-01	9.84050E-01

7.12210E+02	6.72200E-01	2.40490E-01	1.61660E-01	9.86160E-01
7.11710E+02	6.73600E-01	2.39460E-01	1.61300E-01	9.83980E-01
7.11210E+02	6.67800E-01	2.38440E-01	1.59230E-01	9.71340E-01
7.10710E+02	6.56200E-01	2.37420E-01	1.55790E-01	9.50370E-01
7.10210E+02	6.40500E-01	2.36400E-01	1.51410E-01	9.23660E-01
7.09710E+02	6.18000E-01	2.34860E-01	1.45140E-01	8.85390E-01
7.09210E+02	5.89600E-01	2.33300E-01	1.37560E-01	8.39120E-01
7.08710E+02	5.55300E-01	2.31750E-01	1.28690E-01	7.85030E-01
7.08210E+02	5.12200E-01	2.30190E-01	1.17900E-01	7.19230E-01
7.07710E+02	4.60500E-01	2.28440E-01	1.05200E-01	6.41720E-01
7.07210E+02	4.06600E-01	2.26560E-01	9.21200E-02	5.61950E-01
7.06710E+02	3.52300E-01	2.24700E-01	7.91600E-02	4.82890E-01
7.06210E+02	2.95400E-01	2.22840E-01	6.58260E-02	4.01550E-01
7.05710E+02	2.42800E-01	2.20990E-01	5.36570E-02	3.27320E-01
7.05210E+02	1.98900E-01	2.19150E-01	4.35900E-02	2.65910E-01
7.04710E+02	1.62800E-01	2.17330E-01	3.53810E-02	2.15830E-01
7.04210E+02	1.30500E-01	2.15510E-01	2.81240E-02	1.71560E-01
7.03710E+02	1.03400E-01	2.13700E-01	2.20970E-02	1.34790E-01
7.03210E+02	8.19000E-02	2.11780E-01	1.73450E-02	1.05810E-01
7.02710E+02	6.56000E-02	2.09770E-01	1.37610E-02	8.39430E-02
7.02210E+02	5.51000E-02	2.07740E-01	1.14460E-02	6.98250E-02
7.01710E+02	4.67000E-02	2.05720E-01	9.60710E-03	5.86060E-02
7.01210E+02	4.00000E-02	2.03710E-01	8.14860E-03	4.97080E-02
7.00710E+02	3.28000E-02	2.01720E-01	6.61650E-03	4.03620E-02
7.00210E+02	2.67000E-02	1.99740E-01	5.33310E-03	3.25330E-02
6.99710E+02	2.06000E-02	1.97780E-01	4.07420E-03	2.48530E-02
6.99210E+02	1.59000E-02	1.95820E-01	3.11350E-03	1.89930E-02
6.98710E+02	1.42000E-02	1.93880E-01	2.75310E-03	1.67940E-02
6.98210E+02	1.33000E-02	1.91950E-01	2.55300E-03	1.55740E-02
6.97710E+02	1.38000E-02	1.89930E-01	2.62100E-03	1.59890E-02
6.97210E+02	1.31000E-02	1.87840E-01	2.46070E-03	1.50110E-02
6.96710E+02	1.20000E-02	1.85710E-01	2.22850E-03	1.35940E-02
6.96110E+02	1.00000E-02	1.82900E-01	1.82900E-03	1.11580E-02
6.93950E+02	7.75000E-03	1.73000E-01	1.34070E-03	8.17880E-03
6.91780E+02	5.50000E-03	1.63330E-01	8.98320E-04	5.48000E-03
6.89620E+02	3.25000E-03	1.53840E-01	4.99970E-04	3.04990E-03
6.87460E+02	1.00000E-03	1.43870E-01	1.43870E-04	8.77650E-04
6.87000E+02	0.00000E+00	1.41580E-01	0.00000E+00	0.00000E+00

Channel 6

Wave Number	HIRS Filter Transmittance	Optical Element Transmittance	Product of the HIRS Filter and Optical Element Transmittances	Normalized Value of Column 4
7.56000E+02	0.00000E+00	3.18450E-01	0.00000E+00	0.00000E+00
7.55600E+02	1.00000E-03	3.17590E-01	3.17590E-04	1.66790E-03
7.53480E+02	3.25000E-03	3.13000E-01	1.01730E-03	5.34230E-03
7.51350E+02	5.50000E-03	3.09070E-01	1.69990E-03	8.92720E-03
7.49230E+02	7.75000E-03	3.04960E-01	2.36340E-03	1.24120E-02

7.47100E+02	1.00000E-02	3.00830E-01	3.00830E-03	1.57990E-02
7.46800E+02	1.08000E-02	3.00290E-01	3.24320E-03	1.70320E-02
7.46300E+02	1.50000E-02	2.99400E-01	4.49110E-03	2.35860E-02
7.45800E+02	2.14000E-02	2.98520E-01	6.38820E-03	3.35490E-02
7.45300E+02	2.72000E-02	2.97630E-01	8.09550E-03	4.25150E-02
7.44800E+02	3.19000E-02	2.96750E-01	9.46620E-03	4.97130E-02
7.44300E+02	3.72000E-02	2.95860E-01	1.10060E-02	5.78000E-02
7.43800E+02	4.71000E-02	2.94980E-01	1.38940E-02	7.29660E-02
7.43300E+02	6.01000E-02	2.93710E-01	1.76520E-02	9.27030E-02
7.42800E+02	7.50000E-02	2.92340E-01	2.19260E-02	1.15150E-01
7.42300E+02	9.41000E-02	2.90980E-01	2.73820E-02	1.43800E-01
7.41800E+02	1.19800E-01	2.89630E-01	3.46980E-02	1.82220E-01
7.41300E+02	1.51500E-01	2.88280E-01	4.36740E-02	2.29360E-01
7.40800E+02	1.87300E-01	2.86930E-01	5.37420E-02	2.82240E-01
7.40300E+02	2.31100E-01	2.85590E-01	6.59990E-02	3.46610E-01
7.39800E+02	2.85300E-01	2.84250E-01	8.10960E-02	4.25890E-01
7.39300E+02	3.45400E-01	2.82910E-01	9.77190E-02	5.13190E-01
7.38800E+02	4.07300E-01	2.81580E-01	1.14690E-01	6.02310E-01
7.38300E+02	4.72800E-01	2.80260E-01	1.32510E-01	6.95880E-01
7.37800E+02	5.36500E-01	2.78990E-01	1.49680E-01	7.86060E-01
7.37300E+02	5.89600E-01	2.77800E-01	1.63790E-01	8.60170E-01
7.36800E+02	6.31300E-01	2.76560E-01	1.74590E-01	9.16910E-01
7.36300E+02	6.65300E-01	2.75260E-01	1.83130E-01	9.61730E-01
7.35800E+02	6.87800E-01	2.73950E-01	1.88430E-01	9.89550E-01
7.35300E+02	6.98100E-01	2.72660E-01	1.90340E-01	9.99610E-01
7.34800E+02	7.01700E-01	2.71360E-01	1.90410E-01	1.00000E+00
7.34300E+02	7.00400E-01	2.70070E-01	1.89160E-01	9.93400E-01
7.33800E+02	6.95000E-01	2.68790E-01	1.86810E-01	9.81060E-01
7.33300E+02	6.86700E-01	2.67510E-01	1.83700E-01	9.64740E-01
7.32800E+02	6.78400E-01	2.66250E-01	1.80630E-01	9.48590E-01
7.32300E+02	6.69700E-01	2.65020E-01	1.77480E-01	9.32090E-01
7.31800E+02	6.61200E-01	2.63790E-01	1.74420E-01	9.15990E-01
7.31300E+02	6.54800E-01	2.62560E-01	1.71930E-01	9.02910E-01
7.30800E+02	6.48600E-01	2.61340E-01	1.69510E-01	8.90200E-01
7.30300E+02	6.39500E-01	2.60120E-01	1.66350E-01	8.73620E-01
7.29800E+02	6.28900E-01	2.59480E-01	1.63190E-01	8.57010E-01
7.29300E+02	6.18800E-01	2.58850E-01	1.60170E-01	8.41190E-01
7.28800E+02	6.09300E-01	2.58220E-01	1.57330E-01	8.26250E-01
7.28300E+02	5.97100E-01	2.57590E-01	1.53810E-01	8.07740E-01
7.27800E+02	5.79700E-01	2.57060E-01	1.49020E-01	7.82590E-01
7.27300E+02	5.58200E-01	2.56680E-01	1.43280E-01	7.52450E-01
7.26800E+02	5.34500E-01	2.56300E-01	1.36990E-01	7.19440E-01
7.26300E+02	5.09000E-01	2.55920E-01	1.30260E-01	6.84100E-01
7.25800E+02	4.77300E-01	2.55540E-01	1.21970E-01	6.40540E-01
7.25300E+02	4.41800E-01	2.55160E-01	1.12730E-01	5.92020E-01
7.24800E+02	4.03500E-01	2.54780E-01	1.02810E-01	5.39900E-01
7.24300E+02	3.63300E-01	2.54410E-01	9.24260E-02	4.85390E-01
7.23800E+02	3.22400E-01	2.54030E-01	8.18980E-02	4.30100E-01
7.23300E+02	2.84900E-01	2.53670E-01	7.22710E-02	3.79540E-01

7.22800E+02	2.50000E-01	2.53320E-01	6.33310E-02	3.32590E-01
7.22300E+02	2.14500E-01	2.52960E-01	5.42590E-02	2.84950E-01
7.21800E+02	1.79400E-01	2.52590E-01	4.53140E-02	2.37980E-01
7.21300E+02	1.48500E-01	2.52220E-01	3.74550E-02	1.96700E-01
7.20800E+02	1.24800E-01	2.51860E-01	3.14320E-02	1.65070E-01
7.20300E+02	1.05600E-01	2.51490E-01	2.65570E-02	1.39470E-01
7.19800E+02	8.82000E-02	2.51130E-01	2.21490E-02	1.16320E-01
7.19300E+02	7.26000E-02	2.50760E-01	1.82050E-02	9.56080E-02
7.18800E+02	5.97000E-02	2.50390E-01	1.49480E-02	7.85040E-02
7.18300E+02	4.81000E-02	2.50020E-01	1.20260E-02	6.31560E-02
7.17800E+02	3.81000E-02	2.49630E-01	9.51090E-03	4.99480E-02
7.17300E+02	3.10000E-02	2.49230E-01	7.72600E-03	4.05750E-02
7.16800E+02	2.74000E-02	2.48730E-01	6.81520E-03	3.57910E-02
7.16300E+02	2.48000E-02	2.47860E-01	6.14690E-03	3.22810E-02
7.15800E+02	2.12000E-02	2.46990E-01	5.23610E-03	2.74990E-02
7.15300E+02	1.72000E-02	2.46120E-01	4.23330E-03	2.22320E-02
7.14800E+02	1.57000E-02	2.45250E-01	3.85050E-03	2.02220E-02
7.14500E+02	1.00000E-02	2.44740E-01	2.44740E-03	1.28530E-02
7.12370E+02	7.75000E-03	2.40830E-01	1.86650E-03	9.80200E-03
7.10250E+02	5.50000E-03	2.36480E-01	1.30060E-03	6.83060E-03
7.08120E+02	3.25000E-03	2.29920E-01	7.47250E-04	3.92430E-03
7.06000E+02	1.00000E-03	2.22060E-01	2.22060E-04	1.16620E-03
7.05500E+02	0.00000E+00	2.20220E-01	0.00000E+00	0.00000E+00
Channel 7				
Wave Number	HIRS Filter Transmittance	Optical Element Transmittance	Product of the HIRS Filter and Optical Element Transmittances	Normalized Value of Column 4
7.74000E+02	0.00000E+00	3.67050E-01	0.00000E+00	0.00000E+00
7.73000E+02	1.89900E-03	3.64470E-01	6.92130E-04	3.05230E-03
7.72000E+02	2.41300E-03	3.61750E-01	8.72910E-04	3.84960E-03
7.71000E+02	3.40200E-03	3.59050E-01	1.22150E-03	5.38690E-03
7.70000E+02	4.01000E-03	3.56440E-01	1.42930E-03	6.30340E-03
7.69000E+02	6.72800E-03	3.53790E-01	2.38030E-03	1.04970E-02
7.68000E+02	7.50400E-03	3.51130E-01	2.63490E-03	1.16200E-02
7.67000E+02	1.24070E-02	3.48110E-01	4.31890E-03	1.90470E-02
7.66000E+02	1.64300E-02	3.45100E-01	5.67010E-03	2.50050E-02
7.65000E+02	2.04350E-02	3.42120E-01	6.99130E-03	3.08320E-02
7.64000E+02	3.14380E-02	3.39160E-01	1.06630E-02	4.70230E-02
7.63000E+02	4.50900E-02	3.36550E-01	1.51750E-02	6.69220E-02
7.62000E+02	6.37090E-02	3.33840E-01	2.12690E-02	9.37960E-02
7.61000E+02	9.77890E-02	3.31150E-01	3.23830E-02	1.42810E-01
7.60000E+02	1.42470E-01	3.28480E-01	4.67980E-02	2.06380E-01
7.59000E+02	2.08300E-01	3.25830E-01	6.78710E-02	2.99310E-01
7.58000E+02	2.99470E-01	3.23190E-01	9.67880E-02	4.26840E-01
7.57000E+02	4.05920E-01	3.20620E-01	1.30150E-01	5.73940E-01
7.56000E+02	5.10190E-01	3.18450E-01	1.62470E-01	7.16510E-01
7.55000E+02	6.06250E-01	3.16290E-01	1.91750E-01	8.45630E-01

7.54000E+02	6.72000E-01	3.14140E-01	2.11100E-01	9.30970E-01
7.53000E+02	7.10240E-01	3.11970E-01	2.21580E-01	9.77150E-01
7.52000E+02	7.28200E-01	3.10210E-01	2.25890E-01	9.96200E-01
7.51000E+02	7.33790E-01	3.08450E-01	2.26340E-01	9.98170E-01
7.50000E+02	7.38680E-01	3.06580E-01	2.26460E-01	9.98700E-01
7.49000E+02	7.43360E-01	3.04490E-01	2.26340E-01	9.98180E-01
7.48000E+02	7.47940E-01	3.02430E-01	2.26200E-01	9.97560E-01
7.47000E+02	7.53480E-01	3.00650E-01	2.26530E-01	9.99020E-01
7.46000E+02	7.58710E-01	2.98870E-01	2.26760E-01	1.00000E+00
7.45000E+02	7.62310E-01	2.97100E-01	2.26480E-01	9.98790E-01
7.44000E+02	7.59620E-01	2.95330E-01	2.24340E-01	9.89350E-01
7.43000E+02	7.48900E-01	2.92890E-01	2.19340E-01	9.67310E-01
7.42000E+02	7.17630E-01	2.90170E-01	2.08240E-01	9.18320E-01
7.41000E+02	6.58850E-01	2.87470E-01	1.89400E-01	8.35260E-01
7.40000E+02	5.71370E-01	2.84780E-01	1.62720E-01	7.17590E-01
7.39000E+02	4.61630E-01	2.82120E-01	1.30230E-01	5.74330E-01
7.38000E+02	3.49900E-01	2.79470E-01	9.77850E-02	4.31240E-01
7.37000E+02	2.48650E-01	2.77080E-01	6.88960E-02	3.03830E-01
7.36000E+02	1.70790E-01	2.74470E-01	4.68760E-02	2.06730E-01
7.35000E+02	1.13560E-01	2.71880E-01	3.08740E-02	1.36160E-01
7.34000E+02	7.71700E-02	2.69300E-01	2.07820E-02	9.16490E-02
7.33000E+02	5.17400E-02	2.66750E-01	1.38010E-02	6.08650E-02
7.32000E+02	3.57040E-02	2.64280E-01	9.43590E-03	4.16130E-02
7.31000E+02	2.58880E-02	2.61830E-01	6.77830E-03	2.98920E-02
7.30000E+02	1.78890E-02	2.59730E-01	4.64640E-03	2.04910E-02
7.29000E+02	1.25610E-02	2.58470E-01	3.24660E-03	1.43180E-02
7.28000E+02	8.62800E-03	2.57210E-01	2.21920E-03	9.78680E-03
7.27000E+02	6.18600E-03	2.56450E-01	1.58640E-03	6.99610E-03
7.26000E+02	5.25200E-03	2.55690E-01	1.34290E-03	5.92220E-03
7.25000E+02	4.06100E-03	2.54930E-01	1.03530E-03	4.56560E-03
7.24000E+02	1.30700E-03	2.54180E-01	3.32210E-04	1.46510E-03
7.23000E+02	3.30100E-03	2.53470E-01	8.36700E-04	3.68990E-03
7.22000E+02	0.00000E+00	2.52740E-01	0.00000E+00	0.00000E+00

Channel 8

Wave Number	HIRS Filter Transmittance	Optical Element Transmittance	Product of the HIRS Filter and Optical Element Transmittances	Normalized Value of Column 4
9.53000E+02	0.00000E+00	6.02580E-01	0.00000E+00	0.00000E+00
9.52000E+02	5.00000E-04	6.01740E-01	3.00870E-04	6.00570E-04
9.51000E+02	2.59700E-03	6.00940E-01	1.56070E-03	3.11520E-03
9.50000E+02	4.14800E-03	6.00200E-01	2.48960E-03	4.96960E-03
9.49000E+02	4.44800E-03	5.99490E-01	2.66650E-03	5.32270E-03
9.48000E+02	4.39500E-03	5.98760E-01	2.63150E-03	5.25280E-03
9.47000E+02	3.74600E-03	5.97970E-01	2.24000E-03	4.47130E-03
9.46000E+02	4.34500E-03	5.97190E-01	2.59480E-03	5.17950E-03
9.45000E+02	4.44400E-03	5.96410E-01	2.65050E-03	5.29060E-03
9.44000E+02	4.79200E-03	5.95600E-01	2.85410E-03	5.69710E-03

9.43000E+02	4.74900E-03	5.94790E-01	2.82470E-03	5.63840E-03
9.42000E+02	5.69200E-03	5.94300E-01	3.38280E-03	6.75240E-03
9.41000E+02	6.64300E-03	5.93810E-01	3.94470E-03	7.87400E-03
9.40000E+02	6.54900E-03	5.93320E-01	3.88570E-03	7.75620E-03
9.39000E+02	8.84300E-03	5.92830E-01	5.24240E-03	1.04640E-02
9.38000E+02	9.94400E-03	5.92360E-01	5.89040E-03	1.17580E-02
9.37000E+02	1.09090E-02	5.91850E-01	6.45650E-03	1.28880E-02
9.36000E+02	1.28540E-02	5.91340E-01	7.60110E-03	1.51730E-02
9.35000E+02	1.47990E-02	5.90830E-01	8.74360E-03	1.74530E-02
9.34000E+02	1.74070E-02	5.90320E-01	1.02760E-02	2.05110E-02
9.33000E+02	2.22640E-02	5.89810E-01	1.31310E-02	2.62120E-02
9.32000E+02	2.64190E-02	5.89410E-01	1.55720E-02	3.10830E-02
9.31000E+02	3.21590E-02	5.88990E-01	1.89410E-02	3.78090E-02
9.30000E+02	3.89340E-02	5.88500E-01	2.29130E-02	4.57360E-02
9.29000E+02	4.85000E-02	5.88070E-01	2.85210E-02	5.69310E-02
9.28000E+02	6.04770E-02	5.87640E-01	3.55390E-02	7.09390E-02
9.27000E+02	7.50890E-02	5.87390E-01	4.41060E-02	8.80410E-02
9.26000E+02	9.33770E-02	5.87130E-01	5.48250E-02	1.09440E-01
9.25000E+02	1.16330E-01	5.86880E-01	6.82730E-02	1.36280E-01
9.24000E+02	1.44930E-01	5.86670E-01	8.50280E-02	1.69730E-01
9.23000E+02	1.76080E-01	5.86470E-01	1.03260E-01	2.06130E-01
9.22000E+02	2.15450E-01	5.86250E-01	1.26300E-01	2.52120E-01
9.21000E+02	2.61340E-01	5.86020E-01	1.53150E-01	3.05700E-01
9.20000E+02	3.10190E-01	5.85800E-01	1.81710E-01	3.62700E-01
9.19000E+02	3.65420E-01	5.85570E-01	2.13980E-01	4.27120E-01
9.18000E+02	4.23610E-01	5.85310E-01	2.47940E-01	4.94920E-01
9.17000E+02	4.82390E-01	5.85040E-01	2.82220E-01	5.63340E-01
9.16000E+02	5.37980E-01	5.84780E-01	3.14600E-01	6.27970E-01
9.15000E+02	5.92580E-01	5.84510E-01	3.46370E-01	6.91400E-01
9.14000E+02	6.42500E-01	5.84250E-01	3.75380E-01	7.49290E-01
9.13000E+02	6.87450E-01	5.83970E-01	4.01450E-01	8.01330E-01
9.12000E+02	7.25440E-01	5.83610E-01	4.23370E-01	8.45090E-01
9.11000E+02	7.57600E-01	5.83280E-01	4.41900E-01	8.82070E-01
9.10000E+02	7.84550E-01	5.83120E-01	4.57480E-01	9.13190E-01
9.09000E+02	8.08350E-01	5.82890E-01	4.71180E-01	9.40530E-01
9.08000E+02	8.27810E-01	5.82650E-01	4.82330E-01	9.62780E-01
9.07000E+02	8.41010E-01	5.82160E-01	4.89610E-01	9.77310E-01
9.06000E+02	8.50530E-01	5.81670E-01	4.94730E-01	9.87530E-01
9.05000E+02	8.58400E-01	5.81180E-01	4.98890E-01	9.95830E-01
9.04000E+02	8.61670E-01	5.80670E-01	5.00340E-01	9.98740E-01
9.03000E+02	8.63550E-01	5.80130E-01	5.00980E-01	1.00000E+00
9.02000E+02	8.61280E-01	5.79660E-01	4.99250E-01	9.96560E-01
9.01000E+02	8.59960E-01	5.79180E-01	4.98070E-01	9.94210E-01
9.00000E+02	8.57610E-01	5.78710E-01	4.96300E-01	9.90670E-01
8.99000E+02	8.53740E-01	5.78230E-01	4.93660E-01	9.85390E-01
8.98000E+02	8.50920E-01	5.77750E-01	4.91620E-01	9.81320E-01
8.97000E+02	8.48400E-01	5.76900E-01	4.89440E-01	9.76970E-01
8.96000E+02	8.45050E-01	5.76040E-01	4.86780E-01	9.71670E-01
8.95000E+02	8.43920E-01	5.75190E-01	4.85410E-01	9.68940E-01

8.94000E+02	8.40640E-01	5.74340E-01	4.82820E-01	9.63750E-01
8.93000E+02	8.37230E-01	5.73490E-01	4.80140E-01	9.58410E-01
8.92000E+02	8.30650E-01	5.72200E-01	4.75300E-01	9.48750E-01
8.91000E+02	8.24550E-01	5.70900E-01	4.70730E-01	9.39630E-01
8.90000E+02	8.13080E-01	5.69360E-01	4.62940E-01	9.24070E-01
8.89000E+02	7.95750E-01	5.67700E-01	4.51750E-01	9.01740E-01
8.88000E+02	7.70440E-01	5.66060E-01	4.36120E-01	8.70540E-01
8.87000E+02	7.39360E-01	5.64240E-01	4.17170E-01	8.32720E-01
8.86000E+02	6.99020E-01	5.62420E-01	3.93140E-01	7.84760E-01
8.85000E+02	6.53410E-01	5.60600E-01	3.66300E-01	7.31180E-01
8.84000E+02	6.07580E-01	5.58590E-01	3.39390E-01	6.77450E-01
8.83000E+02	5.43200E-01	5.56260E-01	3.02160E-01	6.03140E-01
8.82000E+02	4.78010E-01	5.53510E-01	2.64590E-01	5.28140E-01
8.81000E+02	4.13140E-01	5.50780E-01	2.27550E-01	4.54220E-01
8.80000E+02	3.49050E-01	5.48050E-01	1.91300E-01	3.81850E-01
8.79000E+02	2.89910E-01	5.45340E-01	1.58100E-01	3.15590E-01
8.78000E+02	2.36280E-01	5.42640E-01	1.28220E-01	2.55930E-01
8.77000E+02	1.83760E-01	5.39750E-01	9.91820E-02	1.97980E-01
8.76000E+02	1.48670E-01	5.36780E-01	7.98060E-02	1.59300E-01
8.75000E+02	1.19300E-01	5.33830E-01	6.36860E-02	1.27120E-01
8.74000E+02	9.66120E-02	5.30890E-01	5.12900E-02	1.02380E-01
8.73000E+02	7.69650E-02	5.27940E-01	4.06330E-02	8.11080E-02
8.72000E+02	6.19760E-02	5.24730E-01	3.25210E-02	6.49150E-02
8.71000E+02	5.10150E-02	5.21530E-01	2.66060E-02	5.31080E-02
8.70000E+02	4.11700E-02	5.18240E-01	2.13360E-02	4.25890E-02
8.69000E+02	3.33860E-02	5.15050E-01	1.71950E-02	3.43240E-02
8.68000E+02	2.78050E-02	5.11860E-01	1.42320E-02	2.84090E-02
8.67000E+02	2.47350E-02	5.08660E-01	1.25820E-02	2.51140E-02
8.66000E+02	1.89890E-02	5.05480E-01	9.59850E-03	1.91600E-02
8.65000E+02	1.59050E-02	5.02310E-01	7.98930E-03	1.59470E-02
8.64000E+02	1.43890E-02	4.99150E-01	7.18220E-03	1.43360E-02
8.63000E+02	1.24550E-02	4.95960E-01	6.17710E-03	1.23300E-02
8.62000E+02	1.09950E-02	4.91470E-01	5.40380E-03	1.07860E-02
8.61000E+02	9.01700E-03	4.87020E-01	4.39140E-03	8.76570E-03
8.60000E+02	6.81400E-03	4.82580E-01	3.28830E-03	6.56380E-03
8.59000E+02	6.75600E-03	4.78170E-01	3.23050E-03	6.44840E-03
8.58000E+02	7.65300E-03	4.73770E-01	3.62570E-03	7.23740E-03
8.57000E+02	6.69700E-03	4.70040E-01	3.14790E-03	6.28350E-03
8.56000E+02	5.99600E-03	4.66370E-01	2.79640E-03	5.58180E-03
8.55000E+02	5.35500E-03	4.62720E-01	2.47780E-03	4.94600E-03
8.54000E+02	6.45100E-03	4.59080E-01	2.96150E-03	5.91150E-03
8.53000E+02	5.59300E-03	4.55460E-01	2.54740E-03	5.08480E-03
8.52000E+02	3.80100E-03	4.53200E-01	1.72260E-03	3.43850E-03
8.51000E+02	4.49600E-03	4.50950E-01	2.02750E-03	4.04700E-03
8.50000E+02	3.99400E-03	4.48960E-01	1.79310E-03	3.57930E-03
8.49000E+02	2.99700E-03	4.46940E-01	1.33950E-03	2.67370E-03
8.48000E+02	3.69700E-03	4.44940E-01	1.64490E-03	3.28350E-03
8.47000E+02	3.54800E-03	4.42290E-01	1.56930E-03	3.13240E-03
8.46000E+02	1.89900E-03	4.39660E-01	8.34910E-04	1.66660E-03

8.45000E+02	3.14600E-03	4.37030E-01	1.37490E-03	2.74440E-03
8.44000E+02	4.08700E-03	4.34420E-01	1.77550E-03	3.54410E-03
8.43000E+02	4.24200E-03	4.31910E-01	1.83220E-03	3.65720E-03
8.42000E+02	3.09500E-03	4.30720E-01	1.33310E-03	2.66100E-03
8.41000E+02	8.50000E-04	4.29520E-01	3.65090E-04	7.28770E-04
8.40000E+02	0.00000E+00	4.28330E-01	0.00000E+00	0.00000E+00
Channel 9				
Wave Number	HIRS Filter Transmittance	Optical Element Transmittance	Product of the HIRS Filter and Optical Element Transmittances	Normalized Value of Column 4
1.06300E+03	0.00000E+00	5.94580E-01	0.00000E+00	0.00000E+00
1.06230E+03	1.00000E-03	5.95020E-01	5.95020E-04	1.23440E-03
1.05190E+03	1.00000E-02	6.01520E-01	6.01520E-03	1.24790E-02
1.05100E+03	1.13000E-02	6.01760E-01	6.79990E-03	1.41070E-02
1.05000E+03	1.65000E-02	6.02020E-01	9.93340E-03	2.06080E-02
1.04900E+03	2.33000E-02	6.02110E-01	1.40290E-02	2.91050E-02
1.04800E+03	3.25000E-02	6.02180E-01	1.95710E-02	4.06010E-02
1.04700E+03	4.71000E-02	6.01750E-01	2.83430E-02	5.87990E-02
1.04600E+03	6.69000E-02	6.01310E-01	4.02280E-02	8.34560E-02
1.04500E+03	9.52000E-02	6.00830E-01	5.71990E-02	1.18660E-01
1.04400E+03	1.39200E-01	6.00170E-01	8.35440E-02	1.73320E-01
1.04300E+03	1.99400E-01	5.99490E-01	1.19540E-01	2.47990E-01
1.04200E+03	2.72600E-01	5.98880E-01	1.63250E-01	3.38690E-01
1.04100E+03	3.58100E-01	5.98270E-01	2.14240E-01	4.44460E-01
1.04000E+03	4.54600E-01	5.97670E-01	2.71700E-01	5.63670E-01
1.03900E+03	5.52100E-01	5.97070E-01	3.29640E-01	6.83870E-01
1.03800E+03	6.38800E-01	5.96440E-01	3.81000E-01	7.90430E-01
1.03700E+03	7.09200E-01	5.95790E-01	4.22530E-01	8.76580E-01
1.03600E+03	7.59800E-01	5.95140E-01	4.52180E-01	9.38100E-01
1.03500E+03	7.92300E-01	5.94480E-01	4.71010E-01	9.77150E-01
1.03400E+03	8.08200E-01	5.93830E-01	4.79940E-01	9.95670E-01
1.03300E+03	8.12600E-01	5.93190E-01	4.82020E-01	1.00000E+00
1.03200E+03	8.10700E-01	5.92640E-01	4.80460E-01	9.96750E-01
1.03100E+03	8.05200E-01	5.92250E-01	4.76880E-01	9.89330E-01
1.03000E+03	7.97100E-01	5.91900E-01	4.71800E-01	9.78790E-01
1.02900E+03	7.87100E-01	5.91650E-01	4.65690E-01	9.66120E-01
1.02800E+03	7.76000E-01	5.91430E-01	4.58950E-01	9.52130E-01
1.02700E+03	7.63000E-01	5.91320E-01	4.51180E-01	9.36010E-01
1.02600E+03	7.48500E-01	5.91220E-01	4.42530E-01	9.18060E-01
1.02500E+03	7.33800E-01	5.91120E-01	4.33770E-01	8.99890E-01
1.02400E+03	7.15500E-01	5.91230E-01	4.23030E-01	8.77600E-01
1.02300E+03	6.88400E-01	5.91300E-01	4.07050E-01	8.44460E-01
1.02200E+03	6.51300E-01	5.91610E-01	3.85310E-01	7.99370E-01
1.02100E+03	6.02800E-01	5.91920E-01	3.56810E-01	7.40230E-01
1.02000E+03	5.43100E-01	5.92230E-01	3.21640E-01	6.67280E-01
1.01900E+03	4.73600E-01	5.92550E-01	2.80630E-01	5.82190E-01
1.01800E+03	4.00000E-01	5.92850E-01	2.37140E-01	4.91970E-01

1.01700E+03	3.26700E-01	5.93130E-01	1.93780E-01	4.02000E-01
1.01600E+03	2.58600E-01	5.93410E-01	1.53460E-01	3.18360E-01
1.01500E+03	1.99100E-01	5.93690E-01	1.18200E-01	2.45230E-01
1.01400E+03	1.50900E-01	5.93970E-01	8.96310E-02	1.85950E-01
1.01300E+03	1.13900E-01	5.94240E-01	6.76840E-02	1.40420E-01
1.01200E+03	8.52000E-02	5.94940E-01	5.06890E-02	1.05160E-01
1.01100E+03	6.30000E-02	5.95930E-01	3.75430E-02	7.78870E-02
1.01000E+03	4.72000E-02	5.97050E-01	2.81810E-02	5.84630E-02
1.00900E+03	3.58000E-02	5.98150E-01	2.14140E-02	4.44250E-02
1.00800E+03	2.70000E-02	5.99260E-01	1.61800E-02	3.35670E-02
1.00700E+03	2.05000E-02	6.00260E-01	1.23050E-02	2.55280E-02
1.00600E+03	1.59000E-02	6.01250E-01	9.55990E-03	1.98330E-02
1.00500E+03	1.24000E-02	6.02240E-01	7.46780E-03	1.54930E-02
1.00300E+03	1.00000E-02	6.04960E-01	6.04960E-03	1.25500E-02
9.91640E+02	1.00000E-03	6.17870E-01	6.17870E-04	1.28180E-03
9.91500E+02	0.00000E+00	6.17930E-01	0.00000E+00	0.00000E+00
Channel 10				
Wave Number	HIRS Filter Transmittance	Optical Element Transmittance	Product of the HIRS Filter and Optical Element Transmittances	Normalized Value of Column 4
8.23000E+02	0.00000E+00	4.24490E-01	0.00000E+00	0.00000E+00
8.22920E+02	1.00000E-03	4.24440E-01	4.24440E-04	1.33470E-03
8.16320E+02	1.00000E-02	4.19230E-01	4.19230E-03	1.31830E-02
8.15320E+02	1.29000E-02	4.18110E-01	5.39360E-03	1.69600E-02
8.14320E+02	2.37000E-02	4.16990E-01	9.88270E-03	3.10770E-02
8.13320E+02	4.49000E-02	4.15870E-01	1.86730E-02	5.87170E-02
8.12320E+02	8.56000E-02	4.14630E-01	3.54920E-02	1.11610E-01
8.11320E+02	1.58400E-01	4.13330E-01	6.54710E-02	2.05880E-01
8.10320E+02	2.68200E-01	4.12100E-01	1.10530E-01	3.47560E-01
8.09320E+02	4.02400E-01	4.11010E-01	1.65390E-01	5.20090E-01
8.08320E+02	5.34800E-01	4.09930E-01	2.19230E-01	6.89380E-01
8.07320E+02	6.37300E-01	4.08570E-01	2.60380E-01	8.18790E-01
8.06320E+02	6.96900E-01	4.07090E-01	2.83700E-01	8.92130E-01
8.05320E+02	7.20600E-01	4.05620E-01	2.92290E-01	9.19120E-01
8.04320E+02	7.28900E-01	4.04150E-01	2.94580E-01	9.26330E-01
8.03320E+02	7.39000E-01	4.03380E-01	2.98100E-01	9.37390E-01
8.02320E+02	7.56600E-01	4.03140E-01	3.05020E-01	9.59150E-01
8.01320E+02	7.75300E-01	4.03000E-01	3.12440E-01	9.82500E-01
8.00320E+02	7.86900E-01	4.02850E-01	3.17000E-01	9.96830E-01
7.99320E+02	7.89700E-01	4.02700E-01	3.18010E-01	1.00000E+00
7.98320E+02	7.82500E-01	4.02530E-01	3.14980E-01	9.90470E-01
7.97320E+02	7.57700E-01	4.02280E-01	3.04810E-01	9.58500E-01
7.96320E+02	7.04900E-01	4.01920E-01	2.83310E-01	8.90900E-01
7.95320E+02	6.13500E-01	4.01550E-01	2.46350E-01	7.74670E-01
7.94320E+02	4.86300E-01	4.01180E-01	1.95090E-01	6.13480E-01
7.93320E+02	3.45000E-01	4.00800E-01	1.38280E-01	4.34820E-01
7.92320E+02	2.18700E-01	4.00450E-01	8.75790E-02	2.75400E-01

7.91320E+02	1.26000E-01	4.00120E-01	5.04150E-02	1.58530E-01
7.90320E+02	6.89000E-02	3.99570E-01	2.75310E-02	8.65720E-02
7.89320E+02	3.74000E-02	3.98500E-01	1.49040E-02	4.68660E-02
7.88320E+02	2.13000E-02	3.97410E-01	8.46480E-03	2.66180E-02
7.87320E+02	1.32000E-02	3.96210E-01	5.23000E-03	1.64460E-02
7.86120E+02	1.00000E-02	3.94720E-01	3.94720E-03	1.24120E-02
7.80520E+02	1.00000E-03	3.83820E-01	3.83820E-04	1.20700E-03
7.80000E+02	0.00000E+00	3.82560E-01	0.00000E+00	0.00000E+00
Channel 11				
Wave Number	HIRS Filter Transmittance	Optical Element Transmittance	Product of the HIRS Filter and Optical Element Transmittances	Normalized Value of Column 4
1.41200E+03	0.00000E+00	2.36490E-01	0.00000E+00	0.00000E+00
1.41100E+03	1.00000E-03	2.38520E-01	2.38520E-04	1.09460E-03
1.40320E+03	1.00000E-02	2.53890E-01	2.53890E-03	1.16520E-02
1.40240E+03	1.40000E-02	2.55410E-01	3.57580E-03	1.64100E-02
1.40140E+03	1.65000E-02	2.57310E-01	4.24570E-03	1.94840E-02
1.40040E+03	1.92000E-02	2.59230E-01	4.97720E-03	2.28410E-02
1.39940E+03	2.24000E-02	2.61110E-01	5.84890E-03	2.68420E-02
1.39840E+03	2.50000E-02	2.63020E-01	6.57550E-03	3.01760E-02
1.39740E+03	2.66000E-02	2.64830E-01	7.04450E-03	3.23280E-02
1.39640E+03	2.75000E-02	2.66580E-01	7.33090E-03	3.36420E-02
1.39540E+03	2.86000E-02	2.68330E-01	7.67420E-03	3.52180E-02
1.39440E+03	3.10000E-02	2.70090E-01	8.37280E-03	3.84240E-02
1.39340E+03	3.38000E-02	2.71860E-01	9.18890E-03	4.21690E-02
1.39240E+03	3.78000E-02	2.73500E-01	1.03380E-02	4.74440E-02
1.39140E+03	4.33000E-02	2.75040E-01	1.19090E-02	5.46520E-02
1.39040E+03	5.17000E-02	2.76570E-01	1.42990E-02	6.56190E-02
1.38940E+03	6.43000E-02	2.78120E-01	1.78830E-02	8.20680E-02
1.38840E+03	8.38000E-02	2.79670E-01	2.34370E-02	1.07550E-01
1.38740E+03	1.11400E-01	2.81020E-01	3.13060E-02	1.43670E-01
1.38640E+03	1.49300E-01	2.82200E-01	4.21320E-02	1.93350E-01
1.38540E+03	1.98700E-01	2.83350E-01	5.63020E-02	2.58380E-01
1.38440E+03	2.61000E-01	2.84510E-01	7.42560E-02	3.40770E-01
1.38340E+03	3.34700E-01	2.85660E-01	9.56120E-02	4.38780E-01
1.38240E+03	4.13200E-01	2.86640E-01	1.18440E-01	5.43530E-01
1.38140E+03	4.87000E-01	2.87480E-01	1.40000E-01	6.42500E-01
1.38040E+03	5.48500E-01	2.88330E-01	1.58150E-01	7.25780E-01
1.37940E+03	5.94300E-01	2.89220E-01	1.71890E-01	7.88810E-01
1.37840E+03	6.22800E-01	2.90130E-01	1.80690E-01	8.29220E-01
1.37740E+03	6.38300E-01	2.90790E-01	1.85610E-01	8.51800E-01
1.37640E+03	6.47100E-01	2.91290E-01	1.88500E-01	8.65030E-01
1.37540E+03	6.53800E-01	2.91790E-01	1.90780E-01	8.75490E-01
1.37440E+03	6.61400E-01	2.92290E-01	1.93320E-01	8.87180E-01
1.37340E+03	6.71800E-01	2.92810E-01	1.96710E-01	9.02720E-01
1.37240E+03	6.84900E-01	2.93220E-01	2.00830E-01	9.21620E-01
1.37140E+03	6.98700E-01	2.93530E-01	2.05090E-01	9.41170E-01

1.37040E+03	7.11300E-01	2.93830E-01	2.09000E-01	9.59130E-01
1.36940E+03	7.21200E-01	2.94130E-01	2.12120E-01	9.73460E-01
1.36840E+03	7.28300E-01	2.94400E-01	2.14410E-01	9.83960E-01
1.36740E+03	7.33800E-01	2.94580E-01	2.16160E-01	9.91990E-01
1.36640E+03	7.37600E-01	2.94690E-01	2.17360E-01	9.97510E-01
1.36540E+03	7.39200E-01	2.94790E-01	2.17910E-01	1.00000E+00
1.36440E+03	7.36100E-01	2.94880E-01	2.17060E-01	9.96120E-01
1.36340E+03	7.27500E-01	2.94960E-01	2.14580E-01	9.84750E-01
1.36240E+03	7.11500E-01	2.95030E-01	2.09920E-01	9.63330E-01
1.36140E+03	6.90000E-01	2.95100E-01	2.03620E-01	9.34450E-01
1.36040E+03	6.62500E-01	2.95170E-01	1.95550E-01	8.97410E-01
1.35940E+03	6.30800E-01	2.95200E-01	1.86210E-01	8.54560E-01
1.35840E+03	5.97900E-01	2.95260E-01	1.76530E-01	8.10140E-01
1.35740E+03	5.68300E-01	2.95410E-01	1.67880E-01	7.70420E-01
1.35640E+03	5.46300E-01	2.95600E-01	1.61490E-01	7.41090E-01
1.35540E+03	5.35500E-01	2.95790E-01	1.58400E-01	7.26910E-01
1.35440E+03	5.38400E-01	2.95980E-01	1.59360E-01	7.31310E-01
1.35340E+03	5.53300E-01	2.96160E-01	1.63860E-01	7.51990E-01
1.35240E+03	5.75200E-01	2.96420E-01	1.70500E-01	7.82460E-01
1.35140E+03	5.94000E-01	2.96790E-01	1.76300E-01	8.09040E-01
1.35040E+03	5.97500E-01	2.97160E-01	1.77560E-01	8.14830E-01
1.34940E+03	5.74200E-01	2.97530E-01	1.70840E-01	7.84010E-01
1.34840E+03	5.18000E-01	2.97890E-01	1.54310E-01	7.08130E-01
1.34740E+03	4.35200E-01	2.98320E-01	1.29830E-01	5.95800E-01
1.34640E+03	3.39900E-01	2.98790E-01	1.01560E-01	4.66060E-01
1.34540E+03	2.49800E-01	2.99210E-01	7.47430E-02	3.43010E-01
1.34440E+03	1.75800E-01	2.99640E-01	5.26760E-02	2.41740E-01
1.34340E+03	1.23400E-01	3.00060E-01	3.70280E-02	1.69920E-01
1.34240E+03	8.83000E-02	3.00760E-01	2.65570E-02	1.21870E-01
1.34140E+03	6.60000E-02	3.01650E-01	1.99090E-02	9.13640E-02
1.34040E+03	5.01000E-02	3.02540E-01	1.51570E-02	6.95580E-02
1.33940E+03	3.94000E-02	3.03420E-01	1.19550E-02	5.48630E-02
1.33840E+03	3.33000E-02	3.04310E-01	1.01340E-02	4.65050E-02
1.33740E+03	3.05000E-02	3.05270E-01	9.31060E-03	4.27280E-02
1.33640E+03	2.75000E-02	3.06260E-01	8.42210E-03	3.86500E-02
1.33540E+03	2.47000E-02	3.07250E-01	7.58920E-03	3.48280E-02
1.33440E+03	2.22000E-02	3.08250E-01	6.84320E-03	3.14040E-02
1.33340E+03	2.02000E-02	3.09260E-01	6.24700E-03	2.86680E-02
1.33240E+03	1.85000E-02	3.10540E-01	5.74490E-03	2.63640E-02
1.33140E+03	1.64000E-02	3.11980E-01	5.11650E-03	2.34800E-02
1.33040E+03	1.33000E-02	3.13430E-01	4.16860E-03	1.91300E-02
1.32940E+03	1.03000E-02	3.14850E-01	3.24300E-03	1.48830E-02
1.32870E+03	1.00000E-02	3.15850E-01	3.15850E-03	1.44950E-02
1.32150E+03	1.00000E-03	3.26200E-01	3.26200E-04	1.49700E-03
1.32100E+03	0.00000E+00	3.26930E-01	0.00000E+00	0.00000E+00
Channel 12				

Wave Number	HIRS Filter Transmittance	Optical Element Transmittance	Product of the HIRS Filter and Optical Element Transmittances	Normalized Value of Column 4
1.57900E+03	0.00000E+00	8.35430E-02	0.00000E+00	0.00000E+00
1.57800E+03	5.25000E-03	8.48370E-02	4.45390E-04	3.60550E-03
1.57700E+03	5.65000E-03	8.63940E-02	4.88120E-04	3.95140E-03
1.57600E+03	5.60100E-03	8.79690E-02	4.92720E-04	3.98850E-03
1.57500E+03	6.75500E-03	8.95640E-02	6.05000E-04	4.89750E-03
1.57400E+03	7.00500E-03	9.11560E-02	6.38550E-04	5.16900E-03
1.57300E+03	7.05200E-03	9.27440E-02	6.54030E-04	5.29440E-03
1.57200E+03	8.20200E-03	9.42910E-02	7.73380E-04	6.26050E-03
1.57100E+03	8.10600E-03	9.58520E-02	7.76980E-04	6.28960E-03
1.57000E+03	8.16600E-03	9.74280E-02	7.95590E-04	6.44030E-03
1.56900E+03	1.00820E-02	9.90040E-02	9.98150E-04	8.08010E-03
1.56800E+03	1.36190E-02	1.00600E-01	1.37010E-03	1.10910E-02
1.56700E+03	1.50130E-02	1.02290E-01	1.53570E-03	1.24320E-02
1.56600E+03	1.98810E-02	1.04000E-01	2.06760E-03	1.67370E-02
1.56500E+03	2.74460E-02	1.05720E-01	2.90160E-03	2.34880E-02
1.56400E+03	4.19980E-02	1.07460E-01	4.51300E-03	3.65330E-02
1.56300E+03	6.08560E-02	1.09210E-01	6.64580E-03	5.37980E-02
1.56200E+03	7.53550E-02	1.10980E-01	8.36270E-03	6.76960E-02
1.56100E+03	8.69610E-02	1.12770E-01	9.80680E-03	7.93860E-02
1.56000E+03	1.01770E-01	1.14630E-01	1.16660E-02	9.44390E-02
1.55900E+03	1.52830E-01	1.16510E-01	1.78060E-02	1.44140E-01
1.55800E+03	2.76940E-01	1.18370E-01	3.27820E-02	2.65370E-01
1.55700E+03	3.12800E-01	1.20000E-01	3.75370E-02	3.03860E-01
1.55600E+03	3.49580E-01	1.21650E-01	4.25260E-02	3.44250E-01
1.55500E+03	4.26520E-01	1.23310E-01	5.25930E-02	4.25740E-01
1.55400E+03	5.03270E-01	1.24980E-01	6.28980E-02	5.09160E-01
1.55300E+03	5.17970E-01	1.26670E-01	6.56120E-02	5.31130E-01
1.55200E+03	5.35940E-01	1.28290E-01	6.87570E-02	5.56590E-01
1.55100E+03	5.62910E-01	1.29930E-01	7.31370E-02	5.92050E-01
1.55000E+03	5.78550E-01	1.31580E-01	7.61250E-02	6.16230E-01
1.54900E+03	5.94960E-01	1.33210E-01	7.92540E-02	6.41570E-01
1.54800E+03	6.05340E-01	1.34830E-01	8.16190E-02	6.60710E-01
1.54700E+03	6.11920E-01	1.36100E-01	8.32810E-02	6.74160E-01
1.54600E+03	6.14700E-01	1.37400E-01	8.44570E-02	6.83680E-01
1.54500E+03	6.13770E-01	1.38700E-01	8.51310E-02	6.89140E-01
1.54400E+03	6.14690E-01	1.40020E-01	8.60670E-02	6.96710E-01
1.54300E+03	6.15990E-01	1.41310E-01	8.70450E-02	7.04630E-01
1.54200E+03	6.14190E-01	1.42380E-01	8.74480E-02	7.07890E-01
1.54100E+03	6.10480E-01	1.43450E-01	8.75750E-02	7.08920E-01
1.54000E+03	6.12230E-01	1.44590E-01	8.85230E-02	7.16600E-01
1.53900E+03	6.14920E-01	1.45740E-01	8.96160E-02	7.25440E-01
1.53800E+03	6.20280E-01	1.46860E-01	9.10930E-02	7.37400E-01
1.53700E+03	6.32490E-01	1.47810E-01	9.34860E-02	7.56770E-01
1.53600E+03	6.51020E-01	1.48760E-01	9.68460E-02	7.83970E-01
1.53500E+03	6.76640E-01	1.49720E-01	1.01310E-01	8.20070E-01

1.53400E+03	6.84070E-01	1.50670E-01	1.03070E-01	8.34360E-01
1.53300E+03	7.02840E-01	1.51570E-01	1.06530E-01	8.62360E-01
1.53200E+03	7.16870E-01	1.52340E-01	1.09210E-01	8.84040E-01
1.53100E+03	7.24340E-01	1.53110E-01	1.10900E-01	8.97760E-01
1.53000E+03	7.33920E-01	1.53880E-01	1.12940E-01	9.14230E-01
1.52900E+03	7.34050E-01	1.54690E-01	1.13550E-01	9.19170E-01
1.52800E+03	7.28320E-01	1.55460E-01	1.13230E-01	9.16570E-01
1.52700E+03	7.18070E-01	1.56090E-01	1.12080E-01	9.07290E-01
1.52600E+03	7.08230E-01	1.56700E-01	1.10980E-01	8.98380E-01
1.52500E+03	6.94260E-01	1.57320E-01	1.09220E-01	8.84110E-01
1.52400E+03	6.78580E-01	1.57930E-01	1.07170E-01	8.67540E-01
1.52300E+03	6.69650E-01	1.58530E-01	1.06160E-01	8.59340E-01
1.52200E+03	6.63180E-01	1.59160E-01	1.05550E-01	8.54420E-01
1.52100E+03	6.47190E-01	1.59790E-01	1.03410E-01	8.37140E-01
1.52000E+03	6.40400E-01	1.60460E-01	1.02760E-01	8.31840E-01
1.51900E+03	6.35420E-01	1.61140E-01	1.02390E-01	8.28850E-01
1.51800E+03	6.31810E-01	1.61770E-01	1.02210E-01	8.27380E-01
1.51700E+03	6.34370E-01	1.62500E-01	1.03080E-01	8.34460E-01
1.51600E+03	6.41030E-01	1.63230E-01	1.04640E-01	8.47020E-01
1.51500E+03	6.53080E-01	1.63960E-01	1.07080E-01	8.66810E-01
1.51400E+03	6.77650E-01	1.64700E-01	1.11610E-01	9.03460E-01
1.51300E+03	6.99270E-01	1.65430E-01	1.15680E-01	9.36430E-01
1.51200E+03	7.17350E-01	1.66280E-01	1.19280E-01	9.65570E-01
1.51100E+03	7.36640E-01	1.67130E-01	1.23110E-01	9.96620E-01
1.51000E+03	7.35370E-01	1.67990E-01	1.23530E-01	1.00000E+00
1.50900E+03	7.29970E-01	1.68860E-01	1.23260E-01	9.97800E-01
1.50800E+03	7.13370E-01	1.69730E-01	1.21080E-01	9.80150E-01
1.50700E+03	6.78250E-01	1.70820E-01	1.15860E-01	9.37870E-01
1.50600E+03	5.32380E-01	1.72000E-01	9.15680E-02	7.41240E-01
1.50500E+03	4.62830E-01	1.73180E-01	8.01540E-02	6.48850E-01
1.50400E+03	3.95890E-01	1.74370E-01	6.90330E-02	5.58820E-01
1.50300E+03	2.89800E-01	1.75570E-01	5.08790E-02	4.11870E-01
1.50200E+03	1.88220E-01	1.76860E-01	3.32880E-02	2.69470E-01
1.50100E+03	1.49000E-01	1.78160E-01	2.65460E-02	2.14890E-01
1.50000E+03	1.15420E-01	1.79460E-01	2.07130E-02	1.67670E-01
1.49900E+03	9.18500E-02	1.80770E-01	1.66040E-02	1.34410E-01
1.49800E+03	6.70570E-02	1.82090E-01	1.22100E-02	9.88430E-02
1.49700E+03	4.38700E-02	1.83450E-01	8.04800E-03	6.51490E-02
1.49600E+03	2.98300E-02	1.84820E-01	5.51320E-03	4.46290E-02
1.49500E+03	1.72720E-02	1.86200E-01	3.21600E-03	2.60330E-02
1.49400E+03	1.60500E-02	1.87550E-01	3.01020E-03	2.43680E-02
1.49300E+03	1.32790E-02	1.88690E-01	2.50560E-03	2.02830E-02
1.49200E+03	8.38800E-03	1.89750E-01	1.59160E-03	1.28840E-02
1.49100E+03	8.24800E-03	1.90810E-01	1.57380E-03	1.27400E-02
1.49000E+03	8.67100E-03	1.91880E-01	1.66380E-03	1.34680E-02
1.48900E+03	8.06900E-03	1.92910E-01	1.55660E-03	1.26010E-02
1.48800E+03	6.95400E-03	1.93940E-01	1.34870E-03	1.09170E-02
1.48700E+03	6.04900E-03	1.94920E-01	1.17910E-03	9.54450E-03
1.48600E+03	5.90100E-03	1.95780E-01	1.15530E-03	9.35230E-03

1.48500E+03	6.20100E-03	1.96650E-01	1.21940E-03	9.87120E-03
1.48400E+03	0.00000E+00	1.97520E-01	0.00000E+00	0.00000E+00
Channel 13				
Wave Number	HIRS Filter Transmittance	Optical Element Transmittance	Product of the HIRS Filter and Optical Element Transmittances	Normalized Value of Column 4
2.22250E+03	0.00000E+00	2.19080E-01	0.00000E+00	0.00000E+00
2.21750E+03	5.50000E-03	2.18230E-01	1.20030E-03	1.05710E-02
2.21450E+03	7.75000E-03	2.17290E-01	1.68400E-03	1.48310E-02
2.21150E+03	1.00000E-02	2.16450E-01	2.16450E-03	1.90630E-02
2.21090E+03	1.40000E-02	2.16300E-01	3.02830E-03	2.66700E-02
2.21040E+03	1.46000E-02	2.16180E-01	3.15620E-03	2.77970E-02
2.20990E+03	1.42000E-02	2.16060E-01	3.06800E-03	2.70200E-02
2.20940E+03	1.35000E-02	2.15940E-01	2.91510E-03	2.56740E-02
2.20890E+03	1.36000E-02	2.15820E-01	2.93510E-03	2.58500E-02
2.20840E+03	1.64000E-02	2.15700E-01	3.53740E-03	3.11540E-02
2.20790E+03	2.19000E-02	2.15580E-01	4.72110E-03	4.15790E-02
2.20740E+03	2.79000E-02	2.15460E-01	6.01130E-03	5.29410E-02
2.20690E+03	3.24000E-02	2.15340E-01	6.97690E-03	6.14460E-02
2.20640E+03	3.67000E-02	2.15220E-01	7.89850E-03	6.95620E-02
2.20590E+03	4.20000E-02	2.15100E-01	9.03430E-03	7.95650E-02
2.20540E+03	4.76000E-02	2.14990E-01	1.02340E-02	9.01270E-02
2.20490E+03	5.31000E-02	2.14880E-01	1.14100E-02	1.00490E-01
2.20440E+03	5.92000E-02	2.14770E-01	1.27140E-02	1.11970E-01
2.20390E+03	6.41000E-02	2.14650E-01	1.37590E-02	1.21180E-01
2.20340E+03	7.01000E-02	2.14540E-01	1.50390E-02	1.32450E-01
2.20290E+03	7.93000E-02	2.14430E-01	1.70040E-02	1.49760E-01
2.20240E+03	9.00000E-02	2.14300E-01	1.92870E-02	1.69860E-01
2.20190E+03	1.00300E-01	2.14070E-01	2.14720E-02	1.89100E-01
2.20140E+03	1.11700E-01	2.13850E-01	2.38870E-02	2.10380E-01
2.20090E+03	1.24000E-01	2.13630E-01	2.64900E-02	2.33300E-01
2.20040E+03	1.36500E-01	2.13410E-01	2.91300E-02	2.56550E-01
2.19990E+03	1.50700E-01	2.13190E-01	3.21270E-02	2.82940E-01
2.19940E+03	1.66400E-01	2.12960E-01	3.54370E-02	3.12100E-01
2.19890E+03	1.81900E-01	2.12770E-01	3.87030E-02	3.40860E-01
2.19840E+03	1.96500E-01	2.12700E-01	4.17950E-02	3.68090E-01
2.19790E+03	2.10200E-01	2.12620E-01	4.46930E-02	3.93610E-01
2.19740E+03	2.23400E-01	2.12550E-01	4.74830E-02	4.18180E-01
2.19690E+03	2.37500E-01	2.12470E-01	5.04620E-02	4.44420E-01
2.19640E+03	2.53400E-01	2.12400E-01	5.38210E-02	4.74000E-01
2.19590E+03	2.70500E-01	2.12320E-01	5.74330E-02	5.05810E-01
2.19540E+03	2.86200E-01	2.12270E-01	6.07520E-02	5.35040E-01
2.19490E+03	3.00000E-01	2.12310E-01	6.36930E-02	5.60950E-01
2.19440E+03	3.14000E-01	2.12350E-01	6.66770E-02	5.87230E-01
2.19390E+03	3.27600E-01	2.12390E-01	6.95780E-02	6.12770E-01
2.19340E+03	3.38400E-01	2.12420E-01	7.18850E-02	6.33090E-01
2.19290E+03	3.45800E-01	2.12460E-01	7.34700E-02	6.47050E-01

2.19240E+03	3.51100E-01	2.12500E-01	7.46090E-02	6.57080E-01
2.19190E+03	3.54800E-01	2.12500E-01	7.53960E-02	6.64010E-01
2.19140E+03	3.58100E-01	2.12370E-01	7.60490E-02	6.69760E-01
2.19090E+03	3.60900E-01	2.12230E-01	7.65950E-02	6.74570E-01
2.19040E+03	3.62700E-01	2.12100E-01	7.69280E-02	6.77500E-01
2.18990E+03	3.63600E-01	2.11960E-01	7.70700E-02	6.78760E-01
2.18940E+03	3.63500E-01	2.11840E-01	7.70040E-02	6.78180E-01
2.18890E+03	3.63000E-01	2.11720E-01	7.68530E-02	6.76850E-01
2.18840E+03	3.62500E-01	2.11600E-01	7.67070E-02	6.75560E-01
2.18790E+03	3.61900E-01	2.11520E-01	7.65510E-02	6.74180E-01
2.18740E+03	3.61200E-01	2.11440E-01	7.63740E-02	6.72620E-01
2.18690E+03	3.59300E-01	2.11360E-01	7.59430E-02	6.68830E-01
2.18640E+03	3.56600E-01	2.11280E-01	7.53440E-02	6.63550E-01
2.18590E+03	3.55400E-01	2.11200E-01	7.50610E-02	6.61070E-01
2.18540E+03	3.57400E-01	2.11120E-01	7.54550E-02	6.64540E-01
2.18490E+03	3.61400E-01	2.11060E-01	7.62760E-02	6.71760E-01
2.18440E+03	3.67400E-01	2.11030E-01	7.75330E-02	6.82840E-01
2.18390E+03	3.76000E-01	2.11010E-01	7.93390E-02	6.98740E-01
2.18340E+03	3.87100E-01	2.10980E-01	8.16710E-02	7.19280E-01
2.18290E+03	4.00100E-01	2.10960E-01	8.44040E-02	7.43340E-01
2.18240E+03	4.15900E-01	2.10930E-01	8.77260E-02	7.72610E-01
2.18190E+03	4.34600E-01	2.10910E-01	9.16600E-02	8.07250E-01
2.18140E+03	4.55100E-01	2.10870E-01	9.59650E-02	8.45170E-01
2.18090E+03	4.76300E-01	2.10770E-01	1.00390E-01	8.84120E-01
2.18040E+03	4.96900E-01	2.10670E-01	1.04680E-01	9.21930E-01
2.17990E+03	5.14300E-01	2.10570E-01	1.08300E-01	9.53760E-01
2.17940E+03	5.26500E-01	2.10470E-01	1.10810E-01	9.75920E-01
2.17890E+03	5.35000E-01	2.10370E-01	1.12550E-01	9.91210E-01
2.17840E+03	5.40000E-01	2.10270E-01	1.13550E-01	1.00000E+00
2.17790E+03	5.38100E-01	2.10170E-01	1.13090E-01	9.95990E-01
2.17740E+03	5.27700E-01	2.10040E-01	1.10840E-01	9.76170E-01
2.17690E+03	5.10900E-01	2.09920E-01	1.07250E-01	9.44540E-01
2.17640E+03	4.89500E-01	2.09800E-01	1.02700E-01	9.04460E-01
2.17590E+03	4.62300E-01	2.09680E-01	9.69340E-02	8.53700E-01
2.17540E+03	4.29000E-01	2.09560E-01	8.99000E-02	7.91750E-01
2.17490E+03	3.91300E-01	2.09430E-01	8.19520E-02	7.21750E-01
2.17440E+03	3.49800E-01	2.09310E-01	7.32150E-02	6.44810E-01
2.17390E+03	3.04100E-01	2.09160E-01	6.36050E-02	5.60170E-01
2.17340E+03	2.58300E-01	2.09010E-01	5.39870E-02	4.75460E-01
2.17290E+03	2.16800E-01	2.08860E-01	4.52800E-02	3.98790E-01
2.17240E+03	1.79500E-01	2.08710E-01	3.74630E-02	3.29940E-01
2.17190E+03	1.45400E-01	2.08560E-01	3.03250E-02	2.67070E-01
2.17140E+03	1.15900E-01	2.08410E-01	2.41550E-02	2.12730E-01
2.17090E+03	9.31000E-02	2.08280E-01	1.93900E-02	1.70770E-01
2.17040E+03	7.59000E-02	2.08180E-01	1.58010E-02	1.39160E-01
2.16990E+03	6.08000E-02	2.08090E-01	1.26520E-02	1.11430E-01
2.16940E+03	4.69000E-02	2.08010E-01	9.75570E-03	8.59180E-02
2.16890E+03	3.69000E-02	2.07930E-01	7.67260E-03	6.75730E-02
2.16840E+03	3.05000E-02	2.07850E-01	6.33940E-03	5.58310E-02

2.16790E+03	2.54000E-02	2.07770E-01	5.27730E-03	4.64770E-02
2.16740E+03	2.08000E-02	2.07690E-01	4.31990E-03	3.80460E-02
2.16690E+03	1.81000E-02	2.07630E-01	3.75800E-03	3.30970E-02
2.16640E+03	1.69000E-02	2.07560E-01	3.50780E-03	3.08930E-02
2.16590E+03	1.55000E-02	2.07500E-01	3.21630E-03	2.83260E-02
2.16540E+03	1.35000E-02	2.07440E-01	2.80040E-03	2.46630E-02
2.16510E+03	1.00000E-02	2.07400E-01	2.07400E-03	1.82660E-02
2.16390E+03	0.00000E+00	2.07240E-01	0.00000E+00	0.00000E+00
Channel 14				
Wave Number	HIRS Filter Transmittance	Optical Element Transmittance	Product of the HIRS Filter and Optical Element Transmittances	Normalized Value of Column 4
2.24200E+03	0.00000E+00	2.21380E-01	0.00000E+00	0.00000E+00
2.24160E+03	1.00000E-03	2.21320E-01	2.21320E-04	1.54120E-03
2.23920E+03	3.25000E-03	2.20610E-01	7.16990E-04	4.99280E-03
2.23690E+03	5.50000E-03	2.19940E-01	1.20970E-03	8.42370E-03
2.23460E+03	7.75000E-03	2.19770E-01	1.70320E-03	1.18600E-02
2.23220E+03	1.00000E-02	2.19950E-01	2.19950E-03	1.53160E-02
2.23180E+03	1.33000E-02	2.19990E-01	2.92590E-03	2.03750E-02
2.23130E+03	1.78000E-02	2.20060E-01	3.91700E-03	2.72760E-02
2.23080E+03	2.00000E-02	2.20120E-01	4.40230E-03	3.06560E-02
2.23030E+03	2.00000E-02	2.20130E-01	4.40260E-03	3.06580E-02
2.22980E+03	2.20000E-02	2.20080E-01	4.84180E-03	3.37160E-02
2.22930E+03	2.62000E-02	2.20040E-01	5.76490E-03	4.01440E-02
2.22880E+03	3.11000E-02	2.19990E-01	6.84160E-03	4.76420E-02
2.22830E+03	3.77000E-02	2.19940E-01	8.29180E-03	5.77400E-02
2.22780E+03	4.55000E-02	2.19890E-01	1.00050E-02	6.96700E-02
2.22730E+03	5.40000E-02	2.19850E-01	1.18720E-02	8.26690E-02
2.22680E+03	6.48000E-02	2.19780E-01	1.42420E-02	9.91730E-02
2.22630E+03	8.06000E-02	2.19680E-01	1.77060E-02	1.23300E-01
2.22580E+03	1.00000E-01	2.19570E-01	2.19570E-02	1.52900E-01
2.22530E+03	1.20700E-01	2.19470E-01	2.64900E-02	1.84460E-01
2.22480E+03	1.41600E-01	2.19360E-01	3.10620E-02	2.16300E-01
2.22430E+03	1.64700E-01	2.19260E-01	3.61120E-02	2.51460E-01
2.22380E+03	1.93400E-01	2.19150E-01	4.23840E-02	2.95140E-01
2.22330E+03	2.26700E-01	2.19080E-01	4.96660E-02	3.45850E-01
2.22280E+03	2.60300E-01	2.19080E-01	5.70260E-02	3.97100E-01
2.22230E+03	2.93100E-01	2.19070E-01	6.42100E-02	4.47130E-01
2.22180E+03	3.27200E-01	2.19070E-01	7.16790E-02	4.99130E-01
2.22130E+03	3.62700E-01	2.19060E-01	7.94540E-02	5.53270E-01
2.22080E+03	3.97500E-01	2.19060E-01	8.70750E-02	6.06340E-01
2.22030E+03	4.31500E-01	2.19050E-01	9.45190E-02	6.58180E-01
2.21980E+03	4.63600E-01	2.18980E-01	1.01520E-01	7.06920E-01
2.21930E+03	4.92300E-01	2.18820E-01	1.07720E-01	7.50130E-01
2.21880E+03	5.17900E-01	2.18650E-01	1.13240E-01	7.88550E-01
2.21830E+03	5.41700E-01	2.18490E-01	1.18360E-01	8.24180E-01
2.21780E+03	5.63600E-01	2.18330E-01	1.23050E-01	8.56860E-01

2.21730E+03	5.82500E-01	2.18170E-01	1.27080E-01	8.84940E-01
2.21680E+03	5.97500E-01	2.18000E-01	1.30260E-01	9.07050E-01
2.21630E+03	6.09400E-01	2.17840E-01	1.32750E-01	9.24430E-01
2.21580E+03	6.20200E-01	2.17690E-01	1.35010E-01	9.40160E-01
2.21530E+03	6.28900E-01	2.17540E-01	1.36810E-01	9.52670E-01
2.21480E+03	6.34400E-01	2.17380E-01	1.37910E-01	9.60330E-01
2.21430E+03	6.38800E-01	2.17230E-01	1.38770E-01	9.66310E-01
2.21380E+03	6.43600E-01	2.17080E-01	1.39710E-01	9.72880E-01
2.21330E+03	6.48300E-01	2.16920E-01	1.40630E-01	9.79290E-01
2.21280E+03	6.52600E-01	2.16780E-01	1.41470E-01	9.85120E-01
2.21230E+03	6.56900E-01	2.16650E-01	1.42320E-01	9.91040E-01
2.21180E+03	6.61000E-01	2.16530E-01	1.43130E-01	9.96660E-01
2.21130E+03	6.63600E-01	2.16400E-01	1.43610E-01	1.00000E+00
2.21080E+03	6.63800E-01	2.16280E-01	1.43570E-01	9.99730E-01
2.21030E+03	6.62600E-01	2.16160E-01	1.43220E-01	9.97340E-01
2.20980E+03	6.62200E-01	2.16030E-01	1.43060E-01	9.96170E-01
2.20930E+03	6.61200E-01	2.15910E-01	1.42760E-01	9.94120E-01
2.20880E+03	6.56000E-01	2.15790E-01	1.41560E-01	9.85750E-01
2.20830E+03	6.46500E-01	2.15670E-01	1.39430E-01	9.70940E-01
2.20780E+03	6.36200E-01	2.15550E-01	1.37130E-01	9.54940E-01
2.20730E+03	6.27300E-01	2.15430E-01	1.35140E-01	9.41050E-01
2.20680E+03	6.17400E-01	2.15310E-01	1.32930E-01	9.25690E-01
2.20630E+03	6.05300E-01	2.15190E-01	1.30260E-01	9.07050E-01
2.20580E+03	5.90700E-01	2.15080E-01	1.27050E-01	8.84700E-01
2.20530E+03	5.74000E-01	2.14970E-01	1.23390E-01	8.59240E-01
2.20480E+03	5.55500E-01	2.14860E-01	1.19350E-01	8.31110E-01
2.20430E+03	5.36200E-01	2.14740E-01	1.15150E-01	8.01820E-01
2.20380E+03	5.15500E-01	2.14630E-01	1.10640E-01	7.70460E-01
2.20330E+03	4.92600E-01	2.14520E-01	1.05670E-01	7.35850E-01
2.20280E+03	4.68000E-01	2.14410E-01	1.00340E-01	6.98740E-01
2.20230E+03	4.41600E-01	2.14250E-01	9.46140E-02	6.58840E-01
2.20180E+03	4.14000E-01	2.14030E-01	8.86090E-02	6.17030E-01
2.20130E+03	3.85700E-01	2.13810E-01	8.24660E-02	5.74250E-01
2.20080E+03	3.57800E-01	2.13590E-01	7.64210E-02	5.32160E-01
2.20030E+03	3.29000E-01	2.13360E-01	7.01970E-02	4.88810E-01
2.19980E+03	2.99100E-01	2.13140E-01	6.37510E-02	4.43930E-01
2.19930E+03	2.69700E-01	2.12920E-01	5.74250E-02	3.99880E-01
2.19880E+03	2.42900E-01	2.12760E-01	5.16790E-02	3.59870E-01
2.19830E+03	2.19100E-01	2.12680E-01	4.65990E-02	3.24490E-01
2.19780E+03	1.95700E-01	2.12610E-01	4.16070E-02	2.89730E-01
2.19730E+03	1.70900E-01	2.12530E-01	3.63220E-02	2.52930E-01
2.19680E+03	1.46400E-01	2.12460E-01	3.11040E-02	2.16590E-01
2.19630E+03	1.25100E-01	2.12380E-01	2.65690E-02	1.85010E-01
2.19580E+03	1.06700E-01	2.12310E-01	2.26530E-02	1.57750E-01
2.19530E+03	9.04000E-02	2.12280E-01	1.91900E-02	1.33630E-01
2.19480E+03	7.68000E-02	2.12320E-01	1.63060E-02	1.13550E-01
2.19430E+03	6.54000E-02	2.12360E-01	1.38880E-02	9.67100E-02
2.19380E+03	5.55000E-02	2.12390E-01	1.17880E-02	8.20850E-02
2.19330E+03	4.61000E-02	2.12430E-01	9.79310E-03	6.81950E-02

2.19280E+03	3.78000E-02	2.12470E-01	8.03140E-03	5.59270E-02
2.19230E+03	3.38000E-02	2.12510E-01	7.18280E-03	5.00170E-02
2.19180E+03	3.21000E-02	2.12480E-01	6.82040E-03	4.74940E-02
2.19130E+03	2.73000E-02	2.12340E-01	5.79690E-03	4.03670E-02
2.19080E+03	2.01000E-02	2.12210E-01	4.26530E-03	2.97020E-02
2.19030E+03	1.62000E-02	2.12070E-01	3.43550E-03	2.39230E-02
2.18980E+03	1.55000E-02	2.11940E-01	3.28510E-03	2.28760E-02
2.18930E+03	1.35000E-02	2.11820E-01	2.85950E-03	1.99120E-02
2.18850E+03	1.00000E-02	2.11620E-01	2.11620E-03	1.47360E-02
2.18600E+03	7.75000E-03	2.11220E-01	1.63700E-03	1.13990E-02
2.18360E+03	5.50000E-03	2.10990E-01	1.16040E-03	8.08070E-03
2.18110E+03	3.25000E-03	2.10800E-01	6.85110E-04	4.77070E-03
2.17860E+03	1.00000E-03	2.10310E-01	2.10310E-04	1.46450E-03
2.17800E+03	0.00000E+00	2.10190E-01	0.00000E+00	0.00000E+00

Channel 15

Wave Number	HIRS Filter Transmittance	Optical Element Transmittance	Product of the HIRS Filter and Optical Element Transmittances	Normalized Value of Column 4
2.26400E+03	0.00000E+00	2.25540E-01	0.00000E+00	0.00000E+00
2.26380E+03	1.00000E-03	2.25480E-01	2.25480E-04	1.55230E-03
2.26160E+03	3.25000E-03	2.24950E-01	7.31080E-04	5.03310E-03
2.25940E+03	5.50000E-03	2.24590E-01	1.23520E-03	8.50400E-03
2.25720E+03	7.75000E-03	2.24210E-01	1.73770E-03	1.19630E-02
2.25500E+03	1.00000E-02	2.23820E-01	2.23820E-03	1.54080E-02
2.25420E+03	1.04000E-02	2.23540E-01	2.32490E-03	1.60050E-02
2.25370E+03	1.39000E-02	2.23370E-01	3.10490E-03	2.13750E-02
2.25320E+03	1.88000E-02	2.23200E-01	4.19620E-03	2.88890E-02
2.25270E+03	2.22000E-02	2.23030E-01	4.95130E-03	3.40870E-02
2.25220E+03	2.22000E-02	2.22860E-01	4.94760E-03	3.40610E-02
2.25170E+03	2.37000E-02	2.22700E-01	5.27790E-03	3.63350E-02
2.25120E+03	3.04000E-02	2.22530E-01	6.76500E-03	4.65730E-02
2.25070E+03	3.92000E-02	2.22370E-01	8.71690E-03	6.00110E-02
2.25020E+03	4.80000E-02	2.22210E-01	1.06660E-02	7.34290E-02
2.24970E+03	5.72000E-02	2.22050E-01	1.27010E-02	8.74410E-02
2.24920E+03	6.76000E-02	2.21890E-01	1.50000E-02	1.03270E-01
2.24870E+03	8.06000E-02	2.21730E-01	1.78720E-02	1.23040E-01
2.24820E+03	9.65000E-02	2.21580E-01	2.13820E-02	1.47210E-01
2.24770E+03	1.15300E-01	2.21530E-01	2.55430E-02	1.75850E-01
2.24720E+03	1.37300E-01	2.21560E-01	3.04200E-02	2.09430E-01
2.24670E+03	1.62100E-01	2.21590E-01	3.59200E-02	2.47290E-01
2.24620E+03	1.89000E-01	2.21620E-01	4.18850E-02	2.88360E-01
2.24570E+03	2.18400E-01	2.21640E-01	4.84070E-02	3.33250E-01
2.24520E+03	2.50300E-01	2.21670E-01	5.54840E-02	3.81980E-01
2.24470E+03	2.82300E-01	2.21700E-01	6.25850E-02	4.30870E-01
2.24420E+03	3.14400E-01	2.21670E-01	6.96930E-02	4.79800E-01
2.24370E+03	3.47000E-01	2.21600E-01	7.68960E-02	5.29390E-01
2.24320E+03	3.78900E-01	2.21540E-01	8.39400E-02	5.77880E-01

2.24270E+03	4.09300E-01	2.21470E-01	9.06480E-02	6.24060E-01
2.24220E+03	4.37900E-01	2.21400E-01	9.69520E-02	6.67460E-01
2.24170E+03	4.64600E-01	2.21340E-01	1.02830E-01	7.07940E-01
2.24120E+03	4.89300E-01	2.21270E-01	1.08270E-01	7.45350E-01
2.24070E+03	5.12100E-01	2.21130E-01	1.13240E-01	7.79610E-01
2.24020E+03	5.33300E-01	2.20950E-01	1.17830E-01	8.11220E-01
2.23970E+03	5.52200E-01	2.20770E-01	1.21910E-01	8.39290E-01
2.23920E+03	5.68200E-01	2.20600E-01	1.25340E-01	8.62910E-01
2.23870E+03	5.81600E-01	2.20420E-01	1.28190E-01	8.82550E-01
2.23820E+03	5.93500E-01	2.20240E-01	1.30710E-01	8.99870E-01
2.23770E+03	6.04500E-01	2.20060E-01	1.33030E-01	9.15810E-01
2.23720E+03	6.14500E-01	2.19970E-01	1.35170E-01	9.30570E-01
2.23670E+03	6.23300E-01	2.19930E-01	1.37080E-01	9.43730E-01
2.23620E+03	6.30000E-01	2.19890E-01	1.38530E-01	9.53720E-01
2.23570E+03	6.36200E-01	2.19860E-01	1.39870E-01	9.62940E-01
2.23520E+03	6.43100E-01	2.19820E-01	1.41360E-01	9.73220E-01
2.23470E+03	6.49800E-01	2.19780E-01	1.42810E-01	9.83190E-01
2.23420E+03	6.55000E-01	2.19740E-01	1.43930E-01	9.90880E-01
2.23370E+03	6.58100E-01	2.19760E-01	1.44620E-01	9.95660E-01
2.23320E+03	6.59900E-01	2.19820E-01	1.45060E-01	9.98660E-01
2.23270E+03	6.60600E-01	2.19880E-01	1.45260E-01	1.00000E+00
2.23220E+03	6.59600E-01	2.19950E-01	1.45080E-01	9.98770E-01
2.23170E+03	6.55600E-01	2.20010E-01	1.44240E-01	9.92990E-01
2.23120E+03	6.48200E-01	2.20070E-01	1.42650E-01	9.82060E-01
2.23070E+03	6.38300E-01	2.20130E-01	1.40510E-01	9.67320E-01
2.23020E+03	6.26600E-01	2.20120E-01	1.37930E-01	9.49560E-01
2.22970E+03	6.14200E-01	2.20070E-01	1.35170E-01	9.30560E-01
2.22920E+03	6.00100E-01	2.20030E-01	1.32040E-01	9.09000E-01
2.22870E+03	5.83200E-01	2.19980E-01	1.28290E-01	8.83210E-01
2.22820E+03	5.64800E-01	2.19930E-01	1.24220E-01	8.55160E-01
2.22770E+03	5.45800E-01	2.19880E-01	1.20010E-01	8.26220E-01
2.22720E+03	5.25900E-01	2.19840E-01	1.15610E-01	7.95940E-01
2.22670E+03	5.05400E-01	2.19760E-01	1.11070E-01	7.64630E-01
2.22620E+03	4.85000E-01	2.19660E-01	1.06530E-01	7.33420E-01
2.22570E+03	4.63900E-01	2.19550E-01	1.01850E-01	7.01180E-01
2.22520E+03	4.41900E-01	2.19450E-01	9.69730E-02	6.67610E-01
2.22470E+03	4.19300E-01	2.19340E-01	9.19700E-02	6.33160E-01
2.22420E+03	3.96500E-01	2.19240E-01	8.69270E-02	5.98450E-01
2.22370E+03	3.74600E-01	2.19130E-01	8.20860E-02	5.65120E-01
2.22320E+03	3.53200E-01	2.19080E-01	7.73800E-02	5.32720E-01
2.22270E+03	3.30500E-01	2.19080E-01	7.24050E-02	4.98470E-01
2.22220E+03	3.06400E-01	2.19070E-01	6.71240E-02	4.62110E-01
2.22170E+03	2.83100E-01	2.19070E-01	6.20180E-02	4.26960E-01
2.22120E+03	2.61700E-01	2.19060E-01	5.73280E-02	3.94670E-01
2.22070E+03	2.41200E-01	2.19050E-01	5.28360E-02	3.63750E-01
2.22020E+03	2.20900E-01	2.19050E-01	4.83870E-02	3.33120E-01
2.21970E+03	2.00100E-01	2.18940E-01	4.38110E-02	3.01610E-01
2.21920E+03	1.79400E-01	2.18780E-01	3.92500E-02	2.70210E-01
2.21870E+03	1.60200E-01	2.18620E-01	3.50230E-02	2.41110E-01

2.21820E+03	1.43100E-01	2.18460E-01	3.12610E-02	2.15220E-01
2.21770E+03	1.27400E-01	2.18300E-01	2.78110E-02	1.91460E-01
2.21720E+03	1.11500E-01	2.18130E-01	2.43220E-02	1.67440E-01
2.21670E+03	9.63000E-02	2.17970E-01	2.09910E-02	1.44510E-01
2.21620E+03	8.42000E-02	2.17810E-01	1.83400E-02	1.26260E-01
2.21570E+03	7.39000E-02	2.17660E-01	1.60850E-02	1.10740E-01
2.21520E+03	6.34000E-02	2.17510E-01	1.37900E-02	9.49360E-02
2.21470E+03	5.32000E-02	2.17350E-01	1.15630E-02	7.96060E-02
2.21420E+03	4.51000E-02	2.17200E-01	9.79580E-03	6.74380E-02
2.21370E+03	3.95000E-02	2.17050E-01	8.57340E-03	5.90230E-02
2.21320E+03	3.43000E-02	2.16890E-01	7.43940E-03	5.12160E-02
2.21270E+03	2.87000E-02	2.16750E-01	6.22080E-03	4.28270E-02
2.21220E+03	2.38000E-02	2.16630E-01	5.15580E-03	3.54950E-02
2.21170E+03	2.08000E-02	2.16500E-01	4.50330E-03	3.10030E-02
2.21120E+03	1.89000E-02	2.16380E-01	4.08960E-03	2.81540E-02
2.21070E+03	1.59000E-02	2.16250E-01	3.43850E-03	2.36720E-02
2.21020E+03	1.27000E-02	2.16130E-01	2.74490E-03	1.88970E-02
2.20960E+03	1.00000E-02	2.15980E-01	2.15980E-03	1.48690E-02
2.20720E+03	7.75000E-03	2.15420E-01	1.66950E-03	1.14940E-02
2.20490E+03	5.50000E-03	2.14880E-01	1.18180E-03	8.13620E-03
2.20260E+03	3.25000E-03	2.14350E-01	6.96650E-04	4.79600E-03
2.20020E+03	1.00000E-03	2.13320E-01	2.13320E-04	1.46860E-03
2.20000E+03	0.00000E+00	2.13230E-01	0.00000E+00	0.00000E+00

Channel 16

Wave Number	HIRS Filter Transmittance	Optical Element Transmittance	Product of the HIRS Filter and Optical Element Transmittances	Normalized Value of Column 4
2.26400E+03	0.00000E+00	2.25540E-01	0.00000E+00	0.00000E+00
2.26370E+03	6.00000E-03	2.25460E-01	1.35270E-03	9.96440E-03
2.26340E+03	6.00000E-03	2.25380E-01	1.35230E-03	9.96090E-03
2.26310E+03	4.00000E-03	2.25300E-01	9.01200E-04	6.63830E-03
2.26280E+03	5.00000E-03	2.25220E-01	1.12610E-03	8.29490E-03
2.26250E+03	6.00000E-03	2.25140E-01	1.35090E-03	9.95040E-03
2.26220E+03	7.00000E-03	2.25070E-01	1.57550E-03	1.16050E-02
2.26190E+03	8.00000E-03	2.25000E-01	1.80000E-03	1.32590E-02
2.26160E+03	8.00000E-03	2.24950E-01	1.79960E-03	1.32560E-02
2.26130E+03	9.00000E-03	2.24900E-01	2.02410E-03	1.49090E-02
2.26100E+03	1.00000E-02	2.24850E-01	2.24850E-03	1.65620E-02
2.26070E+03	1.00000E-02	2.24800E-01	2.24800E-03	1.65590E-02
2.26040E+03	1.20000E-02	2.24750E-01	2.69700E-03	1.98660E-02
2.26010E+03	1.50000E-02	2.24700E-01	3.37060E-03	2.48280E-02
2.25980E+03	1.60000E-02	2.24650E-01	3.59450E-03	2.64770E-02
2.25950E+03	1.60000E-02	2.24610E-01	3.59370E-03	2.64710E-02
2.25920E+03	1.90000E-02	2.24560E-01	4.26660E-03	3.14280E-02
2.25890E+03	2.20000E-02	2.24510E-01	4.93920E-03	3.63820E-02
2.25860E+03	2.40000E-02	2.24460E-01	5.38710E-03	3.96810E-02
2.25830E+03	2.70000E-02	2.24410E-01	6.05910E-03	4.46310E-02

2.25800E+03	3.00000E-02	2.24360E-01	6.73070E-03	4.95780E-02
2.25770E+03	3.60000E-02	2.24300E-01	8.07490E-03	5.94800E-02
2.25740E+03	3.90000E-02	2.24250E-01	8.74570E-03	6.44210E-02
2.25710E+03	4.20000E-02	2.24200E-01	9.41620E-03	6.93600E-02
2.25680E+03	5.00000E-02	2.24140E-01	1.12070E-02	8.25520E-02
2.25650E+03	5.60000E-02	2.24090E-01	1.25490E-02	9.24360E-02
2.25620E+03	6.30000E-02	2.24030E-01	1.41140E-02	1.03970E-01
2.25590E+03	7.10000E-02	2.23980E-01	1.59030E-02	1.17140E-01
2.25560E+03	8.50000E-02	2.23930E-01	1.90340E-02	1.40200E-01
2.25530E+03	9.70000E-02	2.23870E-01	2.17160E-02	1.59960E-01
2.25500E+03	1.12000E-01	2.23820E-01	2.50670E-02	1.84650E-01
2.25470E+03	1.33000E-01	2.23710E-01	2.97540E-02	2.19170E-01
2.25440E+03	1.51000E-01	2.23610E-01	3.37650E-02	2.48720E-01
2.25410E+03	1.75000E-01	2.23510E-01	3.91140E-02	2.88110E-01
2.25380E+03	2.03000E-01	2.23410E-01	4.53520E-02	3.34060E-01
2.25350E+03	2.36000E-01	2.23310E-01	5.27000E-02	3.88190E-01
2.25320E+03	2.59000E-01	2.23200E-01	5.78100E-02	4.25830E-01
2.25290E+03	2.93000E-01	2.23100E-01	6.53690E-02	4.81510E-01
2.25260E+03	3.28000E-01	2.23000E-01	7.31440E-02	5.38780E-01
2.25230E+03	3.63000E-01	2.22900E-01	8.09120E-02	5.96000E-01
2.25200E+03	3.96000E-01	2.22800E-01	8.82270E-02	6.49880E-01
2.25170E+03	4.35000E-01	2.22700E-01	9.68730E-02	7.13560E-01
2.25140E+03	4.62000E-01	2.22600E-01	1.02840E-01	7.57520E-01
2.25110E+03	4.97000E-01	2.22500E-01	1.10580E-01	8.14550E-01
2.25080E+03	5.18000E-01	2.22400E-01	1.15200E-01	8.48600E-01
2.25050E+03	5.41000E-01	2.22310E-01	1.20270E-01	8.85890E-01
2.25020E+03	5.65000E-01	2.22210E-01	1.25550E-01	9.24780E-01
2.24990E+03	5.84000E-01	2.22110E-01	1.29710E-01	9.55470E-01
2.24960E+03	5.95000E-01	2.22020E-01	1.32100E-01	9.73050E-01
2.24930E+03	6.03000E-01	2.21920E-01	1.33820E-01	9.85710E-01
2.24900E+03	6.12000E-01	2.21830E-01	1.35760E-01	1.00000E+00
2.24870E+03	6.12000E-01	2.21730E-01	1.35700E-01	9.99570E-01
2.24840E+03	6.08000E-01	2.21640E-01	1.34760E-01	9.92620E-01
2.24810E+03	6.06000E-01	2.21550E-01	1.34260E-01	9.88950E-01
2.24780E+03	6.00000E-01	2.21530E-01	1.32920E-01	9.79070E-01
2.24750E+03	5.91000E-01	2.21550E-01	1.30930E-01	9.64450E-01
2.24720E+03	5.82000E-01	2.21560E-01	1.28950E-01	9.49840E-01
2.24690E+03	5.72000E-01	2.21580E-01	1.26740E-01	9.33590E-01
2.24660E+03	5.61000E-01	2.21590E-01	1.24310E-01	9.15700E-01
2.24630E+03	5.50000E-01	2.21610E-01	1.21890E-01	8.97810E-01
2.24600E+03	5.41000E-01	2.21630E-01	1.19900E-01	8.83180E-01
2.24570E+03	5.32000E-01	2.21640E-01	1.17910E-01	8.68550E-01
2.24540E+03	5.24000E-01	2.21660E-01	1.16150E-01	8.55550E-01
2.24510E+03	5.16000E-01	2.21670E-01	1.14380E-01	8.42550E-01
2.24480E+03	5.11000E-01	2.21690E-01	1.13280E-01	8.34460E-01
2.24450E+03	5.06000E-01	2.21710E-01	1.12190E-01	8.26360E-01
2.24420E+03	5.02000E-01	2.21670E-01	1.11280E-01	8.19680E-01
2.24390E+03	4.99000E-01	2.21630E-01	1.10590E-01	8.14630E-01
2.24360E+03	4.97000E-01	2.21590E-01	1.10130E-01	8.11220E-01

2.24330E+03	4.94000E-01	2.21550E-01	1.09450E-01	8.06180E-01
2.24300E+03	4.96000E-01	2.21510E-01	1.09870E-01	8.09290E-01
2.24270E+03	4.96000E-01	2.21470E-01	1.09850E-01	8.09150E-01
2.24240E+03	4.98000E-01	2.21430E-01	1.10270E-01	8.12260E-01
2.24210E+03	5.01000E-01	2.21390E-01	1.10920E-01	8.17010E-01
2.24180E+03	5.04000E-01	2.21350E-01	1.11560E-01	8.21750E-01
2.24150E+03	5.07000E-01	2.21310E-01	1.12200E-01	8.26490E-01
2.24120E+03	5.11000E-01	2.21270E-01	1.13070E-01	8.32860E-01
2.24090E+03	5.16000E-01	2.21200E-01	1.14140E-01	8.40760E-01
2.24060E+03	5.20000E-01	2.21100E-01	1.14970E-01	8.46870E-01
2.24030E+03	5.25000E-01	2.20990E-01	1.16020E-01	8.54600E-01
2.24000E+03	5.29000E-01	2.20880E-01	1.16850E-01	8.60690E-01
2.23970E+03	5.35000E-01	2.20770E-01	1.18110E-01	8.70030E-01
2.23940E+03	5.39000E-01	2.20670E-01	1.18940E-01	8.76110E-01
2.23910E+03	5.43000E-01	2.20560E-01	1.19760E-01	8.82180E-01
2.23880E+03	5.48000E-01	2.20450E-01	1.20810E-01	8.89870E-01
2.23850E+03	5.52000E-01	2.20350E-01	1.21630E-01	8.95930E-01
2.23820E+03	5.54000E-01	2.20240E-01	1.22010E-01	8.98740E-01
2.23790E+03	5.59000E-01	2.20130E-01	1.23050E-01	9.06410E-01
2.23760E+03	5.60000E-01	2.20020E-01	1.23210E-01	9.07590E-01
2.23730E+03	5.63000E-01	2.19970E-01	1.23850E-01	9.12250E-01
2.23700E+03	5.63000E-01	2.19950E-01	1.23830E-01	9.12150E-01
2.23670E+03	5.65000E-01	2.19930E-01	1.24260E-01	9.15300E-01
2.23640E+03	5.66000E-01	2.19910E-01	1.24470E-01	9.16830E-01
2.23610E+03	5.66000E-01	2.19890E-01	1.24450E-01	9.16740E-01
2.23580E+03	5.66000E-01	2.19860E-01	1.24440E-01	9.16640E-01
2.23550E+03	5.63000E-01	2.19840E-01	1.23770E-01	9.11690E-01
2.23520E+03	5.62000E-01	2.19820E-01	1.23540E-01	9.09980E-01
2.23490E+03	5.60000E-01	2.19800E-01	1.23090E-01	9.06650E-01
2.23460E+03	5.55000E-01	2.19770E-01	1.21970E-01	8.98460E-01
2.23430E+03	5.50000E-01	2.19750E-01	1.20860E-01	8.90270E-01
2.23400E+03	5.46000E-01	2.19720E-01	1.19970E-01	8.83690E-01
2.23370E+03	5.39000E-01	2.19760E-01	1.18450E-01	8.72510E-01
2.23340E+03	5.31000E-01	2.19800E-01	1.16710E-01	8.59700E-01
2.23310E+03	5.23000E-01	2.19830E-01	1.14970E-01	8.46890E-01
2.23280E+03	5.15000E-01	2.19870E-01	1.13230E-01	8.34080E-01
2.23250E+03	5.03000E-01	2.19910E-01	1.10610E-01	8.14780E-01
2.23220E+03	4.94000E-01	2.19950E-01	1.08650E-01	8.00340E-01
2.23190E+03	4.83000E-01	2.19980E-01	1.06250E-01	7.82650E-01
2.23160E+03	4.70000E-01	2.20020E-01	1.03410E-01	7.61710E-01
2.23130E+03	4.57000E-01	2.20060E-01	1.00570E-01	7.40770E-01
2.23100E+03	4.42000E-01	2.20090E-01	9.72810E-02	7.16570E-01
2.23070E+03	4.27000E-01	2.20130E-01	9.39950E-02	6.92370E-01
2.23040E+03	4.11000E-01	2.20140E-01	9.04780E-02	6.66460E-01
2.23010E+03	3.95000E-01	2.20110E-01	8.69440E-02	6.40430E-01
2.22980E+03	3.80000E-01	2.20080E-01	8.36320E-02	6.16030E-01
2.22950E+03	3.62000E-01	2.20050E-01	7.96600E-02	5.86770E-01
2.22920E+03	3.47000E-01	2.20030E-01	7.63490E-02	5.62390E-01
2.22890E+03	3.29000E-01	2.20000E-01	7.23790E-02	5.33150E-01

2.22860E+03	3.10000E-01	2.19970E-01	6.81900E-02	5.02290E-01
2.22830E+03	2.95000E-01	2.19940E-01	6.48820E-02	4.77920E-01
2.22800E+03	2.79000E-01	2.19910E-01	6.13550E-02	4.51940E-01
2.22770E+03	2.62000E-01	2.19880E-01	5.76090E-02	4.24350E-01
2.22740E+03	2.44000E-01	2.19860E-01	5.36450E-02	3.95150E-01
2.22710E+03	2.28000E-01	2.19830E-01	5.01220E-02	3.69200E-01
2.22680E+03	2.14000E-01	2.19780E-01	4.70330E-02	3.46450E-01
2.22650E+03	1.98000E-01	2.19720E-01	4.35040E-02	3.20450E-01
2.22620E+03	1.84000E-01	2.19660E-01	4.04170E-02	2.97710E-01
2.22590E+03	1.70000E-01	2.19590E-01	3.73310E-02	2.74980E-01
2.22560E+03	1.56000E-01	2.19530E-01	3.42470E-02	2.52260E-01
2.22530E+03	1.45000E-01	2.19470E-01	3.18230E-02	2.34410E-01
2.22500E+03	1.32000E-01	2.19400E-01	2.89610E-02	2.13330E-01
2.22470E+03	1.21000E-01	2.19340E-01	2.65400E-02	1.95500E-01
2.22440E+03	1.12000E-01	2.19280E-01	2.45590E-02	1.80900E-01
2.22410E+03	1.01000E-01	2.19220E-01	2.21410E-02	1.63090E-01
2.22380E+03	9.40000E-02	2.19150E-01	2.06000E-02	1.51740E-01
2.22350E+03	8.50000E-02	2.19090E-01	1.86220E-02	1.37170E-01
2.22320E+03	7.80000E-02	2.19080E-01	1.70880E-02	1.25870E-01
2.22290E+03	7.10000E-02	2.19080E-01	1.55550E-02	1.14580E-01
2.22260E+03	6.50000E-02	2.19080E-01	1.42400E-02	1.04890E-01
2.22230E+03	6.00000E-02	2.19070E-01	1.31440E-02	9.68210E-02
2.22200E+03	5.40000E-02	2.19070E-01	1.18300E-02	8.71380E-02
2.22170E+03	4.90000E-02	2.19070E-01	1.07340E-02	7.90680E-02
2.22140E+03	4.60000E-02	2.19060E-01	1.00770E-02	7.42260E-02
2.22110E+03	4.10000E-02	2.19060E-01	8.98140E-03	6.61570E-02
2.22080E+03	3.70000E-02	2.19060E-01	8.10510E-03	5.97020E-02
2.22050E+03	3.60000E-02	2.19050E-01	7.88590E-03	5.80870E-02
2.22020E+03	3.20000E-02	2.19050E-01	7.00950E-03	5.16320E-02
2.21990E+03	2.90000E-02	2.19010E-01	6.35130E-03	4.67830E-02
2.21960E+03	2.60000E-02	2.18910E-01	5.69170E-03	4.19250E-02
2.21930E+03	2.50000E-02	2.18820E-01	5.47040E-03	4.02950E-02
2.21900E+03	2.10000E-02	2.18720E-01	4.59310E-03	3.38330E-02
2.21870E+03	1.80000E-02	2.18620E-01	3.93520E-03	2.89870E-02
2.21840E+03	1.70000E-02	2.18520E-01	3.71490E-03	2.73640E-02
2.21810E+03	1.70000E-02	2.18430E-01	3.71330E-03	2.73520E-02
2.21780E+03	1.60000E-02	2.18330E-01	3.49330E-03	2.57310E-02
2.21750E+03	1.60000E-02	2.18230E-01	3.49170E-03	2.57200E-02
2.21720E+03	1.50000E-02	2.18130E-01	3.27200E-03	2.41020E-02
2.21690E+03	1.30000E-02	2.18040E-01	2.83450E-03	2.08790E-02
2.21660E+03	1.20000E-02	2.17940E-01	2.61530E-03	1.92640E-02
2.21630E+03	1.00000E-02	2.17840E-01	2.17840E-03	1.60460E-02
2.21600E+03	9.00000E-03	2.17750E-01	1.95980E-03	1.44360E-02
2.21570E+03	9.00000E-03	2.17660E-01	1.95890E-03	1.44300E-02
2.21540E+03	8.00000E-03	2.17570E-01	1.74050E-03	1.28210E-02
2.21510E+03	7.00000E-03	2.17480E-01	1.52230E-03	1.12140E-02
2.21480E+03	7.00000E-03	2.17380E-01	1.52170E-03	1.12090E-02
2.21450E+03	6.00000E-03	2.17290E-01	1.30380E-03	9.60350E-03
2.21420E+03	5.00000E-03	2.17200E-01	1.08600E-03	7.99950E-03

2.21390E+03	4.00000E-03	2.17110E-01	8.68440E-04	6.39690E-03
2.21360E+03	4.00000E-03	2.17020E-01	8.68070E-04	6.39420E-03
2.21330E+03	2.00000E-03	2.16920E-01	4.33850E-04	3.19570E-03
2.21300E+03	0.00000E+00	2.16830E-01	0.00000E+00	0.00000E+00
Channel 17				
Wave Number	HIRS Filter Transmittance	Optical Element Transmittance	Product of the HIRS Filter and Optical Element Transmittances	Normalized Value of Column 4
2.45800E+03	0.00000E+00	2.53840E-01	0.00000E+00	0.00000E+00
2.45710E+03	1.00000E-03	2.53720E-01	2.53720E-04	1.38540E-03
2.45370E+03	3.25000E-03	2.53220E-01	8.22960E-04	4.49360E-03
2.45040E+03	5.50000E-03	2.52500E-01	1.38870E-03	7.58280E-03
2.44710E+03	7.75000E-03	2.51900E-01	1.95220E-03	1.06590E-02
2.44370E+03	1.00000E-02	2.51630E-01	2.51630E-03	1.37400E-02
2.44220E+03	2.72100E-02	2.51270E-01	6.83710E-03	3.73320E-02
2.44120E+03	4.51500E-02	2.51030E-01	1.13340E-02	6.18860E-02
2.44020E+03	6.27400E-02	2.50870E-01	1.57390E-02	8.59420E-02
2.43920E+03	8.00000E-02	2.50900E-01	2.00720E-02	1.09600E-01
2.43820E+03	1.01240E-01	2.50940E-01	2.54050E-02	1.38720E-01
2.43720E+03	1.27650E-01	2.50970E-01	3.20370E-02	1.74930E-01
2.43620E+03	1.58360E-01	2.50870E-01	3.97280E-02	2.16920E-01
2.43520E+03	1.92760E-01	2.50730E-01	4.83310E-02	2.63900E-01
2.43420E+03	2.30910E-01	2.50590E-01	5.78640E-02	3.15950E-01
2.43320E+03	2.72500E-01	2.50420E-01	6.82400E-02	3.72610E-01
2.43220E+03	3.16620E-01	2.50160E-01	7.92060E-02	4.32480E-01
2.43120E+03	3.60470E-01	2.49900E-01	9.00800E-02	4.91860E-01
2.43020E+03	4.01650E-01	2.49630E-01	1.00270E-01	5.47480E-01
2.42920E+03	4.38370E-01	2.49420E-01	1.09340E-01	5.97020E-01
2.42820E+03	4.69640E-01	2.49220E-01	1.17040E-01	6.39080E-01
2.42720E+03	4.94510E-01	2.49020E-01	1.23140E-01	6.72380E-01
2.42620E+03	5.12530E-01	2.48840E-01	1.27540E-01	6.96400E-01
2.42520E+03	5.22330E-01	2.48730E-01	1.29920E-01	7.09380E-01
2.42420E+03	5.26550E-01	2.48610E-01	1.30900E-01	7.14770E-01
2.42320E+03	5.26920E-01	2.48490E-01	1.30940E-01	7.14940E-01
2.42220E+03	5.23300E-01	2.48470E-01	1.30020E-01	7.09970E-01
2.42120E+03	5.16320E-01	2.48470E-01	1.28290E-01	7.00500E-01
2.42020E+03	5.07530E-01	2.48470E-01	1.26110E-01	6.88580E-01
2.41920E+03	4.97880E-01	2.48450E-01	1.23700E-01	6.75430E-01
2.41820E+03	4.91830E-01	2.48340E-01	1.22140E-01	6.66920E-01
2.41720E+03	4.90460E-01	2.48230E-01	1.21750E-01	6.64770E-01
2.41620E+03	4.92520E-01	2.48120E-01	1.22210E-01	6.67270E-01
2.41520E+03	4.99030E-01	2.48080E-01	1.23800E-01	6.75990E-01
2.41420E+03	5.11460E-01	2.48060E-01	1.26870E-01	6.92760E-01
2.41320E+03	5.32540E-01	2.48040E-01	1.32090E-01	7.21250E-01
2.41220E+03	5.64140E-01	2.48030E-01	1.39920E-01	7.64020E-01
2.41120E+03	6.05600E-01	2.48070E-01	1.50230E-01	8.20290E-01
2.41020E+03	6.54780E-01	2.48110E-01	1.62450E-01	8.87040E-01

2.40920E+03	7.02760E-01	2.48160E-01	1.74400E-01	9.52260E-01
2.40820E+03	7.35760E-01	2.48090E-01	1.82540E-01	9.96700E-01
2.40720E+03	7.38490E-01	2.47990E-01	1.83140E-01	1.00000E+00
2.40620E+03	6.98850E-01	2.47900E-01	1.73240E-01	9.45950E-01
2.40520E+03	6.17180E-01	2.47840E-01	1.52960E-01	8.35230E-01
2.40420E+03	5.08370E-01	2.47900E-01	1.26030E-01	6.88140E-01
2.40320E+03	3.91260E-01	2.47960E-01	9.70180E-02	5.29740E-01
2.40220E+03	2.85060E-01	2.48020E-01	7.07010E-02	3.86050E-01
2.40120E+03	2.00440E-01	2.48080E-01	4.97250E-02	2.71510E-01
2.40020E+03	1.38850E-01	2.48130E-01	3.44530E-02	1.88120E-01
2.39920E+03	9.67700E-02	2.48180E-01	2.40170E-02	1.31140E-01
2.39820E+03	6.89100E-02	2.48180E-01	1.71020E-02	9.33830E-02
2.39700E+03	5.50000E-02	2.48050E-01	1.36430E-02	7.44930E-02
2.39520E+03	4.00000E-02	2.47850E-01	9.91400E-03	5.41330E-02
2.39340E+03	2.70000E-02	2.47390E-01	6.67960E-03	3.64730E-02
2.39160E+03	2.00000E-02	2.46900E-01	4.93800E-03	2.69630E-02
2.38980E+03	1.50000E-02	2.46090E-01	3.69130E-03	2.01560E-02
2.38800E+03	1.20000E-02	2.45290E-01	2.94350E-03	1.60720E-02
2.38720E+03	1.41300E-02	2.45120E-01	3.46350E-03	1.89110E-02
2.38580E+03	1.00000E-02	2.44800E-01	2.44800E-03	1.33670E-02
2.38220E+03	7.75000E-03	2.44480E-01	1.89470E-03	1.03460E-02
2.37860E+03	5.50000E-03	2.44600E-01	1.34530E-03	7.34570E-03
2.37490E+03	3.25000E-03	2.44580E-01	7.94890E-04	4.34030E-03
2.37130E+03	1.00000E-03	2.44740E-01	2.44740E-04	1.33630E-03
2.37100E+03	0.00000E+00	2.44760E-01	0.00000E+00	0.00000E+00

Channel 18

Wave Number	HIRS Filter Transmittance	Optical Element Transmittance	Product of the HIRS Filter and Optical Element Transmittances	Normalized Value of Column 4
2.57800E+03	0.00000E+00	5.01670E-01	0.00000E+00	0.00000E+00
2.57720E+03	1.00000E-03	5.01830E-01	5.01830E-04	1.28930E-03
2.57210E+03	3.25000E-03	5.03490E-01	1.63640E-03	4.20420E-03
2.56690E+03	5.50000E-03	5.04830E-01	2.77650E-03	7.13360E-03
2.56180E+03	7.75000E-03	5.05260E-01	3.91570E-03	1.00610E-02
2.55670E+03	1.00000E-02	5.07410E-01	5.07410E-03	1.30360E-02
2.55560E+03	2.19300E-02	5.08060E-01	1.11420E-02	2.86260E-02
2.55460E+03	2.54000E-02	5.08490E-01	1.29160E-02	3.31830E-02
2.55360E+03	2.96100E-02	5.08920E-01	1.50690E-02	3.87160E-02
2.55260E+03	3.47000E-02	5.09340E-01	1.76740E-02	4.54090E-02
2.55160E+03	4.09600E-02	5.09230E-01	2.08580E-02	5.35890E-02
2.55060E+03	4.85900E-02	5.09060E-01	2.47350E-02	6.35500E-02
2.54960E+03	5.77500E-02	5.08880E-01	2.93880E-02	7.55050E-02
2.54860E+03	6.86700E-02	5.09010E-01	3.49540E-02	8.98040E-02
2.54760E+03	8.16200E-02	5.09590E-01	4.15930E-02	1.06860E-01
2.54660E+03	9.68700E-02	5.10170E-01	4.94200E-02	1.26970E-01
2.54560E+03	1.14870E-01	5.10750E-01	5.86700E-02	1.50740E-01
2.54460E+03	1.35960E-01	5.10940E-01	6.94680E-02	1.78480E-01

2.54360E+03	1.60290E-01	5.11090E-01	8.19230E-02	2.10480E-01
2.54260E+03	1.88020E-01	5.11250E-01	9.61240E-02	2.46970E-01
2.54160E+03	2.18890E-01	5.11390E-01	1.11940E-01	2.87600E-01
2.54060E+03	2.52520E-01	5.11450E-01	1.29150E-01	3.31820E-01
2.53960E+03	2.88390E-01	5.11510E-01	1.47510E-01	3.79000E-01
2.53860E+03	3.25650E-01	5.11580E-01	1.66600E-01	4.28030E-01
2.53760E+03	3.63500E-01	5.11660E-01	1.85990E-01	4.77850E-01
2.53660E+03	4.01410E-01	5.11740E-01	2.05420E-01	5.27770E-01
2.53560E+03	4.38650E-01	5.11810E-01	2.24510E-01	5.76810E-01
2.53460E+03	4.74700E-01	5.11730E-01	2.42920E-01	6.24110E-01
2.53360E+03	5.09310E-01	5.11440E-01	2.60480E-01	6.69240E-01
2.53260E+03	5.41690E-01	5.11150E-01	2.76890E-01	7.11390E-01
2.53160E+03	5.71390E-01	5.10870E-01	2.91900E-01	7.49970E-01
2.53060E+03	5.98410E-01	5.10680E-01	3.05600E-01	7.85150E-01
2.52960E+03	6.22370E-01	5.10510E-01	3.17730E-01	8.16310E-01
2.52860E+03	6.43210E-01	5.10340E-01	3.28250E-01	8.43360E-01
2.52760E+03	6.61040E-01	5.10360E-01	3.37370E-01	8.66780E-01
2.52660E+03	6.75820E-01	5.10730E-01	3.45160E-01	8.86800E-01
2.52560E+03	6.87740E-01	5.11100E-01	3.51500E-01	9.03090E-01
2.52460E+03	6.97110E-01	5.11470E-01	3.56550E-01	9.16060E-01
2.52360E+03	7.03890E-01	5.11540E-01	3.60070E-01	9.25100E-01
2.52260E+03	7.08300E-01	5.11580E-01	3.62350E-01	9.30970E-01
2.52160E+03	7.10980E-01	5.11620E-01	3.63750E-01	9.34560E-01
2.52060E+03	7.12590E-01	5.11850E-01	3.64740E-01	9.37110E-01
2.51960E+03	7.13750E-01	5.12400E-01	3.65720E-01	9.39630E-01
2.51860E+03	7.14710E-01	5.12940E-01	3.66600E-01	9.41900E-01
2.51760E+03	7.15670E-01	5.13490E-01	3.67490E-01	9.44170E-01
2.51660E+03	7.17250E-01	5.13930E-01	3.68620E-01	9.47070E-01
2.51560E+03	7.20050E-01	5.14360E-01	3.70360E-01	9.51550E-01
2.51460E+03	7.24360E-01	5.14780E-01	3.72890E-01	9.58040E-01
2.51360E+03	7.30080E-01	5.14990E-01	3.75980E-01	9.65990E-01
2.51260E+03	7.37140E-01	5.14870E-01	3.79530E-01	9.75110E-01
2.51160E+03	7.44690E-01	5.14750E-01	3.83330E-01	9.84870E-01
2.51060E+03	7.51680E-01	5.14640E-01	3.86840E-01	9.93900E-01
2.50960E+03	7.56230E-01	5.14680E-01	3.89220E-01	1.00000E+00
2.50860E+03	7.55830E-01	5.14750E-01	3.89060E-01	9.99590E-01
2.50760E+03	7.47180E-01	5.14810E-01	3.84660E-01	9.88270E-01
2.50660E+03	7.26790E-01	5.14940E-01	3.74260E-01	9.61550E-01
2.50560E+03	6.91650E-01	5.15170E-01	3.56320E-01	9.15460E-01
2.50460E+03	6.40920E-01	5.15390E-01	3.30330E-01	8.48690E-01
2.50360E+03	5.76700E-01	5.15610E-01	2.97350E-01	7.63970E-01
2.50260E+03	5.03440E-01	5.15940E-01	2.59740E-01	6.67350E-01
2.50160E+03	4.27330E-01	5.16280E-01	2.20620E-01	5.66830E-01
2.50060E+03	3.54060E-01	5.16620E-01	1.82920E-01	4.69950E-01
2.49960E+03	2.88080E-01	5.16760E-01	1.48870E-01	3.82480E-01
2.49860E+03	2.31730E-01	5.16640E-01	1.19720E-01	3.07590E-01
2.49760E+03	1.85510E-01	5.16520E-01	9.58190E-02	2.46180E-01
2.49660E+03	1.48250E-01	5.16390E-01	7.65540E-02	1.96690E-01
2.49560E+03	1.18680E-01	5.15860E-01	6.12230E-02	1.57300E-01

2.49460E+03	9.53400E-02	5.15300E-01	4.91280E-02	1.26220E-01
2.49360E+03	7.70100E-02	5.14730E-01	3.96390E-02	1.01840E-01
2.49260E+03	6.26500E-02	5.14310E-01	3.22220E-02	8.27850E-02
2.49160E+03	5.13800E-02	5.14090E-01	2.64140E-02	6.78630E-02
2.49060E+03	4.24900E-02	5.13860E-01	2.18340E-02	5.60970E-02
2.48960E+03	3.54200E-02	5.13640E-01	1.81930E-02	4.67420E-02
2.48860E+03	2.97800E-02	5.13830E-01	1.53020E-02	3.93140E-02
2.48760E+03	2.52000E-02	5.14070E-01	1.29550E-02	3.32830E-02
2.48660E+03	2.14400E-02	5.14310E-01	1.10270E-02	2.83300E-02
2.48560E+03	1.83300E-02	5.14430E-01	9.42940E-03	2.42260E-02
2.48460E+03	1.58800E-02	5.14370E-01	8.16810E-03	2.09860E-02
2.48360E+03	1.39100E-02	5.14310E-01	7.15400E-03	1.83800E-02
2.47760E+03	1.00000E-02	5.15770E-01	5.15770E-03	1.32510E-02
2.47270E+03	7.75000E-03	5.15150E-01	3.99240E-03	1.02570E-02
2.46780E+03	5.50000E-03	5.15550E-01	2.83550E-03	7.28510E-03
2.46290E+03	3.25000E-03	5.15670E-01	1.67590E-03	4.30590E-03
2.45800E+03	1.00000E-03	5.16180E-01	5.16180E-04	1.32620E-03
2.45700E+03	0.00000E+00	5.16180E-01	0.00000E+00	0.00000E+00
Channel 19				
Wave Number	HIRS Filter Transmittance	Optical Element Transmittance	Product of the HIRS Filter and Optical Element Transmittances	Normalized Value of Column 4
2.79400E+03	0.00000E+00	3.91440E-01	0.00000E+00	0.00000E+00
2.79310E+03	1.00000E-03	3.91720E-01	3.91720E-04	1.19170E-03
2.78090E+03	3.25000E-03	3.97160E-01	1.29080E-03	3.92690E-03
2.76880E+03	5.50000E-03	4.03550E-01	2.21950E-03	6.75230E-03
2.75660E+03	7.75000E-03	4.09710E-01	3.17530E-03	9.66000E-03
2.74450E+03	1.00000E-02	4.16260E-01	4.16260E-03	1.26640E-02
2.74040E+03	1.26000E-02	4.18790E-01	5.27680E-03	1.60530E-02
2.73940E+03	1.45100E-02	4.19230E-01	6.08300E-03	1.85060E-02
2.73840E+03	1.63100E-02	4.19660E-01	6.84470E-03	2.08230E-02
2.73740E+03	1.80800E-02	4.20310E-01	7.59910E-03	2.31180E-02
2.73640E+03	1.99500E-02	4.21110E-01	8.40110E-03	2.55580E-02
2.73540E+03	2.20900E-02	4.21910E-01	9.32010E-03	2.83540E-02
2.73440E+03	2.45100E-02	4.22660E-01	1.03590E-02	3.15160E-02
2.73340E+03	2.70300E-02	4.22810E-01	1.14290E-02	3.47690E-02
2.73240E+03	2.97100E-02	4.22970E-01	1.25660E-02	3.82300E-02
2.73140E+03	3.27200E-02	4.23120E-01	1.38450E-02	4.21190E-02
2.73040E+03	3.61900E-02	4.23710E-01	1.53340E-02	4.66500E-02
2.72940E+03	4.02400E-02	4.24610E-01	1.70860E-02	5.19810E-02
2.72840E+03	4.49900E-02	4.25510E-01	1.91440E-02	5.82400E-02
2.72740E+03	5.03400E-02	4.26360E-01	2.14630E-02	6.52950E-02
2.72640E+03	5.63600E-02	4.26760E-01	2.40520E-02	7.31730E-02
2.72540E+03	6.32000E-02	4.27170E-01	2.69970E-02	8.21320E-02
2.72440E+03	7.09300E-02	4.27580E-01	3.03280E-02	9.22660E-02
2.72340E+03	7.97400E-02	4.27730E-01	3.41070E-02	1.03760E-01
2.72240E+03	8.97800E-02	4.27680E-01	3.83970E-02	1.16810E-01

2.72140E+03	1.01110E-01	4.27630E-01	4.32380E-02	1.31540E-01
2.72040E+03	1.13810E-01	4.27660E-01	4.86720E-02	1.48070E-01
2.71940E+03	1.28230E-01	4.28290E-01	5.49200E-02	1.67080E-01
2.71840E+03	1.44560E-01	4.28930E-01	6.20060E-02	1.88640E-01
2.71740E+03	1.63020E-01	4.29570E-01	7.00280E-02	2.13040E-01
2.71640E+03	1.83840E-01	4.30270E-01	7.91010E-02	2.40650E-01
2.71540E+03	2.07050E-01	4.31020E-01	8.92440E-02	2.71500E-01
2.71440E+03	2.32430E-01	4.31780E-01	1.00360E-01	3.05310E-01
2.71340E+03	2.60110E-01	4.32510E-01	1.12500E-01	3.42260E-01
2.71240E+03	2.90160E-01	4.33140E-01	1.25680E-01	3.82350E-01
2.71140E+03	3.22180E-01	4.33770E-01	1.39750E-01	4.25160E-01
2.71040E+03	3.55710E-01	4.34390E-01	1.54520E-01	4.70080E-01
2.70940E+03	3.90090E-01	4.34730E-01	1.69580E-01	5.15910E-01
2.70840E+03	4.24570E-01	4.34860E-01	1.84630E-01	5.61690E-01
2.70740E+03	4.58470E-01	4.35000E-01	1.99430E-01	6.06720E-01
2.70640E+03	4.91120E-01	4.35230E-01	2.13750E-01	6.50280E-01
2.70540E+03	5.21040E-01	4.36150E-01	2.27250E-01	6.91360E-01
2.70440E+03	5.47770E-01	4.37070E-01	2.39420E-01	7.28370E-01
2.70340E+03	5.70930E-01	4.38000E-01	2.50070E-01	7.60770E-01
2.70240E+03	5.89590E-01	4.38740E-01	2.58680E-01	7.86960E-01
2.70140E+03	6.04000E-01	4.39370E-01	2.65380E-01	8.07350E-01
2.70040E+03	6.15060E-01	4.40000E-01	2.70630E-01	8.23320E-01
2.69940E+03	6.23190E-01	4.40620E-01	2.74590E-01	8.35360E-01
2.69840E+03	6.28070E-01	4.41020E-01	2.76990E-01	8.42680E-01
2.69740E+03	6.29930E-01	4.41420E-01	2.78070E-01	8.45950E-01
2.69640E+03	6.29080E-01	4.41830E-01	2.77940E-01	8.45580E-01
2.69540E+03	6.26950E-01	4.42360E-01	2.77340E-01	8.43720E-01
2.69440E+03	6.24650E-01	4.42990E-01	2.76710E-01	8.41830E-01
2.69340E+03	6.22520E-01	4.43620E-01	2.76160E-01	8.40150E-01
2.69240E+03	6.20800E-01	4.44270E-01	2.75800E-01	8.39060E-01
2.69140E+03	6.19350E-01	4.45240E-01	2.75760E-01	8.38930E-01
2.69040E+03	6.17920E-01	4.46210E-01	2.75720E-01	8.38820E-01
2.68940E+03	6.16100E-01	4.47190E-01	2.75510E-01	8.38170E-01
2.68840E+03	6.13910E-01	4.47700E-01	2.74850E-01	8.36160E-01
2.68740E+03	6.11850E-01	4.47900E-01	2.74050E-01	8.33730E-01
2.68640E+03	6.11120E-01	4.48100E-01	2.73850E-01	8.33110E-01
2.68540E+03	6.11420E-01	4.48310E-01	2.74100E-01	8.33890E-01
2.68440E+03	6.12160E-01	4.48600E-01	2.74610E-01	8.35440E-01
2.68340E+03	6.13340E-01	4.48890E-01	2.75320E-01	8.37590E-01
2.68240E+03	6.14810E-01	4.49170E-01	2.76160E-01	8.40140E-01
2.68140E+03	6.16370E-01	4.49690E-01	2.77170E-01	8.43230E-01
2.68040E+03	6.18050E-01	4.50350E-01	2.78340E-01	8.46780E-01
2.67940E+03	6.20040E-01	4.51020E-01	2.79650E-01	8.50760E-01
2.67840E+03	6.22210E-01	4.51680E-01	2.81040E-01	8.54990E-01
2.67740E+03	6.24300E-01	4.52330E-01	2.82390E-01	8.59090E-01
2.67640E+03	6.25890E-01	4.52970E-01	2.83510E-01	8.62510E-01
2.67540E+03	6.26380E-01	4.53620E-01	2.84140E-01	8.64420E-01
2.67440E+03	6.25920E-01	4.54180E-01	2.84280E-01	8.64860E-01
2.67340E+03	6.25490E-01	4.54690E-01	2.84400E-01	8.65230E-01

2.67240E+03	6.26320E-01	4.55200E-01	2.85100E-01	8.67340E-01
2.67140E+03	6.28780E-01	4.55700E-01	2.86530E-01	8.71710E-01
2.67040E+03	6.31980E-01	4.56190E-01	2.88300E-01	8.77090E-01
2.66940E+03	6.34290E-01	4.56680E-01	2.89670E-01	8.81250E-01
2.66840E+03	6.35110E-01	4.57180E-01	2.90360E-01	8.83340E-01
2.66740E+03	6.34470E-01	4.57530E-01	2.90290E-01	8.83130E-01
2.66640E+03	6.33020E-01	4.57770E-01	2.89780E-01	8.81580E-01
2.66540E+03	6.30960E-01	4.58020E-01	2.88990E-01	8.79180E-01
2.66440E+03	6.28250E-01	4.58270E-01	2.87910E-01	8.75880E-01
2.66340E+03	6.24720E-01	4.58530E-01	2.86450E-01	8.71450E-01
2.66240E+03	6.20790E-01	4.58780E-01	2.84810E-01	8.66460E-01
2.66140E+03	6.16690E-01	4.59040E-01	2.83090E-01	8.61220E-01
2.66040E+03	6.12640E-01	4.59300E-01	2.81380E-01	8.56040E-01
2.65940E+03	6.08400E-01	4.59540E-01	2.79590E-01	8.50570E-01
2.65840E+03	6.03870E-01	4.59790E-01	2.77650E-01	8.44690E-01
2.65740E+03	5.99310E-01	4.60070E-01	2.75730E-01	8.38830E-01
2.65640E+03	5.94730E-01	4.60610E-01	2.73940E-01	8.33400E-01
2.65540E+03	5.90620E-01	4.61160E-01	2.72370E-01	8.28610E-01
2.65440E+03	5.87060E-01	4.61700E-01	2.71050E-01	8.24590E-01
2.65340E+03	5.82930E-01	4.62240E-01	2.69450E-01	8.19740E-01
2.65240E+03	5.77820E-01	4.62770E-01	2.67400E-01	8.13490E-01
2.65140E+03	5.72370E-01	4.63300E-01	2.65180E-01	8.06740E-01
2.65040E+03	5.67080E-01	4.63820E-01	2.63020E-01	8.00190E-01
2.64940E+03	5.62720E-01	4.64450E-01	2.61360E-01	7.95110E-01
2.64840E+03	5.59640E-01	4.65080E-01	2.60280E-01	7.91830E-01
2.64740E+03	5.57230E-01	4.65710E-01	2.59510E-01	7.89480E-01
2.64640E+03	5.55420E-01	4.66340E-01	2.59020E-01	7.87990E-01
2.64540E+03	5.54300E-01	4.66990E-01	2.58850E-01	7.87490E-01
2.64440E+03	5.53840E-01	4.67630E-01	2.58990E-01	7.87920E-01
2.64340E+03	5.54090E-01	4.68250E-01	2.59450E-01	7.89320E-01
2.64240E+03	5.55340E-01	4.68740E-01	2.60310E-01	7.91930E-01
2.64140E+03	5.57610E-01	4.69230E-01	2.61650E-01	7.95990E-01
2.64040E+03	5.60890E-01	4.69710E-01	2.63460E-01	8.01510E-01
2.63940E+03	5.64810E-01	4.70100E-01	2.65520E-01	8.07760E-01
2.63840E+03	5.69210E-01	4.70430E-01	2.67770E-01	8.14630E-01
2.63740E+03	5.74310E-01	4.70760E-01	2.70360E-01	8.22520E-01
2.63640E+03	5.80490E-01	4.71100E-01	2.73470E-01	8.31960E-01
2.63540E+03	5.87800E-01	4.71470E-01	2.77130E-01	8.43100E-01
2.63440E+03	5.96070E-01	4.71830E-01	2.81250E-01	8.55620E-01
2.63340E+03	6.04710E-01	4.72200E-01	2.85540E-01	8.68700E-01
2.63240E+03	6.13580E-01	4.72810E-01	2.90110E-01	8.82580E-01
2.63140E+03	6.22910E-01	4.73570E-01	2.94990E-01	8.97440E-01
2.63040E+03	6.32630E-01	4.74330E-01	3.00080E-01	9.12910E-01
2.62940E+03	6.42630E-01	4.75090E-01	3.05310E-01	9.28830E-01
2.62840E+03	6.52560E-01	4.75770E-01	3.10470E-01	9.44530E-01
2.62740E+03	6.61970E-01	4.76450E-01	3.15400E-01	9.59520E-01
2.62640E+03	6.70420E-01	4.77130E-01	3.19880E-01	9.73150E-01
2.62540E+03	6.77600E-01	4.77530E-01	3.23570E-01	9.84390E-01
2.62440E+03	6.83020E-01	4.77760E-01	3.26320E-01	9.92740E-01

2.62340E+03	6.86460E-01	4.77990E-01	3.28120E-01	9.98230E-01
2.62240E+03	6.87320E-01	4.78240E-01	3.28700E-01	1.00000E+00
2.62140E+03	6.85190E-01	4.78870E-01	3.28120E-01	9.98210E-01
2.62040E+03	6.79570E-01	4.79500E-01	3.25850E-01	9.91320E-01
2.61940E+03	6.69350E-01	4.80130E-01	3.21370E-01	9.77700E-01
2.61840E+03	6.54010E-01	4.80820E-01	3.14460E-01	9.56670E-01
2.61740E+03	6.33820E-01	4.81540E-01	3.05210E-01	9.28530E-01
2.61640E+03	6.09440E-01	4.82260E-01	2.93910E-01	8.94150E-01
2.61540E+03	5.82060E-01	4.82980E-01	2.81120E-01	8.55250E-01
2.61440E+03	5.52190E-01	4.83590E-01	2.67040E-01	8.12390E-01
2.61340E+03	5.19970E-01	4.84210E-01	2.51770E-01	7.65960E-01
2.61240E+03	4.86360E-01	4.84830E-01	2.35800E-01	7.17360E-01
2.61140E+03	4.52350E-01	4.85440E-01	2.19590E-01	6.68040E-01
2.61040E+03	4.18400E-01	4.86050E-01	2.03360E-01	6.18680E-01
2.60940E+03	3.84960E-01	4.86660E-01	1.87350E-01	5.69950E-01
2.60840E+03	3.51900E-01	4.87300E-01	1.71480E-01	5.21690E-01
2.60740E+03	3.19810E-01	4.87940E-01	1.56050E-01	4.74740E-01
2.60640E+03	2.89620E-01	4.88590E-01	1.41510E-01	4.30490E-01
2.60540E+03	2.61640E-01	4.89230E-01	1.28000E-01	3.89420E-01
2.60440E+03	2.35800E-01	4.89760E-01	1.15490E-01	3.51330E-01
2.60340E+03	2.12200E-01	4.90220E-01	1.04030E-01	3.16470E-01
2.60240E+03	1.90800E-01	4.90690E-01	9.36240E-02	2.84830E-01
2.60140E+03	1.71530E-01	4.91200E-01	8.42550E-02	2.56330E-01
2.60040E+03	1.54390E-01	4.91950E-01	7.59520E-02	2.31070E-01
2.59940E+03	1.39150E-01	4.92710E-01	6.85600E-02	2.08580E-01
2.59840E+03	1.25480E-01	4.93460E-01	6.19200E-02	1.88380E-01
2.59740E+03	1.13250E-01	4.94020E-01	5.59480E-02	1.70210E-01
2.59640E+03	1.02300E-01	4.94450E-01	5.05820E-02	1.53880E-01
2.59540E+03	9.24300E-02	4.94880E-01	4.57420E-02	1.39160E-01
2.59440E+03	8.35900E-02	4.95300E-01	4.14020E-02	1.25960E-01
2.59340E+03	7.56900E-02	4.95830E-01	3.75290E-02	1.14170E-01
2.59240E+03	6.86300E-02	4.96350E-01	3.40650E-02	1.03630E-01
2.59140E+03	6.23500E-02	4.96880E-01	3.09800E-02	9.42500E-02
2.59040E+03	5.67400E-02	4.97160E-01	2.82090E-02	8.58180E-02
2.58940E+03	5.16700E-02	4.97290E-01	2.56950E-02	7.81700E-02
2.58840E+03	4.71500E-02	4.97420E-01	2.34540E-02	7.13520E-02
2.58740E+03	4.31200E-02	4.97600E-01	2.14570E-02	6.52760E-02
2.58640E+03	3.95500E-02	4.98290E-01	1.97070E-02	5.99540E-02
2.58540E+03	3.63400E-02	4.98970E-01	1.81330E-02	5.51640E-02
2.58440E+03	3.34200E-02	4.99660E-01	1.66990E-02	5.08020E-02
2.58340E+03	3.08000E-02	5.00140E-01	1.54040E-02	4.68640E-02
2.58240E+03	2.84200E-02	5.00490E-01	1.42240E-02	4.32730E-02
2.58140E+03	2.62300E-02	5.00840E-01	1.31370E-02	3.99660E-02
2.58040E+03	2.42800E-02	5.01170E-01	1.21680E-02	3.70200E-02
2.57940E+03	2.25200E-02	5.01380E-01	1.12910E-02	3.43500E-02
2.57840E+03	2.08900E-02	5.01590E-01	1.04780E-02	3.18770E-02
2.57740E+03	1.93900E-02	5.01790E-01	9.72980E-03	2.96000E-02
2.57640E+03	1.80100E-02	5.02080E-01	9.04240E-03	2.75090E-02
2.57540E+03	1.67700E-02	5.02410E-01	8.42540E-03	2.56320E-02

2.57440E+03	1.53600E-02	5.02750E-01	7.72220E-03	2.34930E-02
2.57340E+03	1.38200E-02	5.03070E-01	6.95240E-03	2.11510E-02
2.57240E+03	1.22000E-02	5.03390E-01	6.14140E-03	1.86840E-02
2.56710E+03	1.00000E-02	5.04790E-01	5.04790E-03	1.53570E-02
2.55410E+03	7.75000E-03	5.08700E-01	3.94240E-03	1.19940E-02
2.54110E+03	5.50000E-03	5.11420E-01	2.81280E-03	8.55730E-03
2.52810E+03	3.25000E-03	5.10240E-01	1.65830E-03	5.04490E-03
2.51510E+03	1.00000E-03	5.14570E-01	5.14570E-04	1.56550E-03
2.51400E+03	0.00000E+00	5.15030E-01	0.00000E+00	0.00000E+00

Table D.3-14 contains the pre- and post-launch calibration slope and intercept values for NOAA-17 HIRS/303 Channel 20.

Table D.3-14. NOAA-17 HIRS/303 Channel 20 Slope and Intercept (Albedo %)		
Source	Slope	Intercept
Pre-launch calibration	0.02621	53.80783
Post-launch calibration	TBD	TBD

AMSU:

Table D.3-15. NOAA-17 AMSU PRT Temperature Conversion Coefficients.					
	PRT #	Coefficient 0	Coefficient 1	Coefficient 2	Coefficient 3
Scan Motor A1-1	1	262.9264	1.782879E-03	4.651285E-09	3.016453E-15
Scan Motor A1-2	2	262.9457	1.794984E-03	4.014630E-09	1.178214E-14
Feedhorn A1-1	3	262.9824	1.787421E-03	4.479284E-09	4.003862E-15
Feedhorn A1-2	4	262.9480	1.796941E-03	3.990959E-09	1.213830E-14
RF Mux A1-1	5	262.9930	1.791427E-03	4.562482E-09	3.258688E-15
RF Mux A1-2	6	262.9876	1.783315E-03	4.549435E-09	2.993637E-15
L.O. CH 3	7	263.0508	1.796300E-03	4.093929E-09	1.079970E-14
L.O. CH 4	8	262.9266	1.789260E-03	4.554566E-09	3.049904E-15
L.O. CH 5	9	263.0612	1.798046E-03	3.986979E-09	1.268962E-14
L.O. CH 6	10	263.2208	1.786634E-03	4.517242E-09	3.021994E-15
L.O. CH 7	11	263.0943	1.710871E-03	1.525857E-08	-2.792764E-13
L.O. CH 8	12	263.1941	1.725553E-03	1.463346E-08	-2.700232E-13
L.O. CH 15	13	262.9590	1.787082E-03	4.553521E-09	2.961741E-15
PLLO #2 CH9-14	14	263.1783	1.716766E-03	1.514877E-08	-2.787102E-13
PLLO #1 CH9-14	15	263.1875	1.722912E-03	1.469318E-08	-2.706999E-13
PLLO (Ref.Osc.)	16	263.0786	1.786833E-03	4.551711E-09	2.707090E-15
Mixer/IF CH 3	17	262.9888	1.796020E-03	3.998485E-09	1.186256E-14
Mixer/IF CH 4	18	263.0844	1.784899E-03	4.506407E-09	3.640704E-15
Mixer/IF CH 5	19	262.9594	1.797137E-03	3.954086E-09	1.269160E-14
Mixer/IF CH 6	20	262.9237	1.785977E-03	4.526986E-09	3.482820E-15
Mixer/IF CH 7	21	263.0457	1.797253E-03	3.976505E-09	1.255832E-14
Mixer/IF CH 8	22	263.2087	1.788848E-03	4.534624E-09	2.771589E-15
Mixer/IF CH9/14	23	263.0331	1.794866E-03	4.119775E-09	9.785078E-15
Mixer/IF CH 15	24	263.1179	1.787349E-03	4.578916E-09	2.215207E-15
IF Amp.CH11/14	25	263.2372	1.797438E-03	4.062329E-09	1.139440E-14
IF Amp. CH 9	26	263.1272	1.785720E-03	4.583279E-09	2.127480E-15
IF Amp. Ch.10	27	262.9736	1.794427E-03	4.114111E-09	1.029068E-14
IF Amp. Ch.11	28	262.8804	1.782688E-03	4.604669E-09	1.871548E-15
DC/DC Converter	29	263.1144	1.789528E-03	4.503099E-09	4.160511E-15
IF Amp. Ch.13	30	262.9494	1.790211E-03	4.469882E-09	4.827499E-15
IF Amp. Ch.14	31	262.9767	1.798895E-03	3.948966E-09	1.244464E-14
IF Amp. Ch.12	32	263.0209	1.796938E-03	3.970665E-09	1.284796E-14
RF Shelf A1-1	33	262.9493	1.795960E-03	4.021378E-09	1.165849E-14
RF Shelf A1-2	34	263.2218	1.790430E-03	4.457330E-09	4.806016E-15
Detector/PreAmp	35	263.1320	1.786115E-03	4.444591E-09	5.163805E-15
A1-1WarmLoad#1	36	254.1414	1.689477E-03	6.344681E-09	3.193697E-14
A1-1WarmLoad#2	37	254.1487	1.691693E-03	6.341322E-09	3.225776E-14
A1-1WarmLoad#3	38	254.2609	1.688383E-03	6.366155E-09	3.285827E-14

A1-1WarmLoad#4	39	254.0264	1.691223E-03	6.366102E-09	3.158980E-14
A1-1WmLd Center	40	254.1180	1.687154E-03	6.324558E-09	3.341569E-14
A1-2WarmLoad#1	41	254.0312	1.689809E-03	6.276867E-09	3.309316E-14
A1-2WarmLoad#2	42	254.0746	1.689391E-03	6.330238E-09	3.196075E-14
A1-2WarmLoad#3	43	253.9810	1.688747E-03	6.415529E-09	3.026252E-14
A1-2WarmLoad#4	44	254.0501	1.691363E-03	6.261909E-09	3.320902E-14
A1-2WmLd Center	45	254.1199	1.690609E-03	6.336316E-09	3.169356E-14

Table D.3-16 contains the measured channel characteristics for the NOAA-17 AMSU-A and -B instruments. Detailed information on the terminology used in this table can be found in Section 3.3.2.1.

Table D.3-16. Measured Channel Characteristics for NOAA-17 AMSU-A and AMSU-B.							
Ch #	Instrument / Serial #	Central Frequency (GHz)	Central Wavenumber (cm ⁻¹)	I/F Frequencies (GHz)			
				Sideband 1		Sideband 2	
				Begin (f ₁)	End (f ₂)	Begin (f ₃)	End (f ₄)
1*	A2/FM2	23.799210	0.793856	0.00845	0.13396	N/A	N/A
2*	A2/FM2	31.399660	1.047380	0.00893	0.08951	N/A	N/A
3*	A1-2/FM2	50.291801	1.677553	0.00894	0.08952	N/A	N/A
4*	A1-2/FM2	52.800800	1.761245	0.00894	0.19915	N/A	N/A
5	A1-2/FM2	53.596001	1.787770	0.03108	0.19923	N/A	N/A
6*	A1-1/FM2	54.400242	1.814596	0.00894	0.19920	N/A	N/A
7*	A1-1/FM2	54.939819	1.832595	0.00893	0.19923	N/A	N/A
8*	A1-2/FM2	55.499199	1.851253	0.00890	0.16400	N/A	N/A
9*	A1-1/FM2	57.290344	1.911000	0.00897	0.16388	N/A	N/A
10	A1-1/FM2	57.290344	1.911000	0.17901	0.25566	N/A	N/A
11	A1-1/FM2	57.290344	1.911000	0.25711	0.291785	0.353100	0.387960
12	A1-1/FM2	57.290344	1.911000	0.292805	0.308095	0.337015	0.352085
13	A1-1/FM2	57.290344	1.911000	0.308190	0.316110	0.328305	0.336195
14	A1-1/FM2	57.290344	1.911000	0.316300	0.319240	0.325260	0.328120
15	A1-1/FM2	88.999802	2.968713	0.49978	1.49921	N/A	N/A
16	B/FM3	89.002	2.968786	0.399	1.406	N/A	N/A
17	B/FM3	149.984	5.002926	0.398	1.402	N/A	N/A
18	B/FM3	183.299	6.114195	0.751	1.248	N/A	N/A
19	B/FM3	183.299	6.114195	2.511	3.267	N/A	N/A
20	B/FM3	183.299	6.114195	6.016	7.971	N/A	N/A

* The lower frequency cutoff in these single passband channels is due to the stop band.

D.4 NOAA-18 (N)

Launch date: May 20, 2005

Operational dates: August 30, 2005 - present

Afternoon orbit: 1400 LST ascending node, 0200 LST descending node

AVHRR instrument: 6 channels (AVHRR/3)

Spacecraft ID (PACS): 7

- AVHRR: 13
- TIP 1 (TIP side 1): 13
- TIP 2 (TIP side 2): 14

Abnormalities:

Up to date information regarding abnormalities on the POES spacecraft and instruments can be found at: <http://www.oso.noaa.gov/poesstatus/>. This website allows a user to search and sort on any POES spacecraft, subsystem or instrument status. Once a user narrows down their window of interest, further details can be obtained by going to the NOAA/NESDIS/Office of Satellite Operations' (OSO) archive of weekly status reports at: <http://noaasis.noaa.gov/NOAASIS/ml/podocs.html>.

AVHRR:

Table D.4-1 contains the PRT weighting factors for NOAA-18 and Table D.4-2 contains the radiance of space and the coefficients for nonlinear radiance correction quadratic for NOAA-18.

Table D.4-1. NOAA-18 PRT Weighting Factors.			
b₁	b₂	b₃	b₄
0.25	0.25	0.25	0.25

Table D.4-2. NOAA-18 Radiance of Space and Coefficients for Nonlinear Radiance Correction Quadratic.				
	N_S	b₀	b₁	b₂
Channel 4	-5.53	5.82	-0.11069	0.00052337
Channel 5	-2.22	2.67	-0.04360	0.00017715

Table D.4-3 contains NOAA-18 coefficients d₀, d₁, d₂, d₃ and d₄ that relate temperature, T_{PRT} (Kelvin) of each PRT to count value, C_{PRT}, by the equation:

$$T_{PRT} = d_0 + d_1 C_{PRT} + d_2 C_{PRT}^2 + d_3 C_{PRT}^3 + d_4 C_{PRT}^4$$

Table D.4-3. NOAA-18 AVHRR/3 Conversion Coefficients.					
PRT	d₀	d₁	d₂	d₃	d₄
1	276.601	0.05090	1.657 E-06	0	0

2	276.683	0.05101	1.482 E-06	0	0
3	276.565	0.05117	1.313 E-06	0	0
4	276.615	0.05103	1.484 E-06	0	0

Table D.4-4 contains the pre-launch calibration coefficients (albedo representation) for the AVHRR/3 instrument on NOAA-18.

Table D.4-4. NOAA-18 AVHRR/3 Pre-launch Calibration Coefficients (Albedo Representation).			
Channel #	Contents	Slope	Intercept
1	Low albedo range (0-25%)	0.05400	-2.130
	High albedo range (26 - 100%)	0.16100	-55.37
2	Low albedo range (0-25%)	0.05290	-2.084
	High albedo range (26 - 100%)	0.15873	-55.31
3A	Low albedo range (0-12.5%)	0.02618	-0.982
	High albedo range (12.6 - 100%)	0.18492	-80.88

Note: The albedo ranges given in parentheses are nominal; the points of intersection of the two regression lines are located at 500.54, 500.40 and 500.56 counts for channels 1, 2, and 3A respectively. This information is based on the data in AVHRR S/N A306 Alignment/Calibration Handbook (Report 8172845, Rev B), January 2002.

Table D.4-5 contains a summary of the spectral response data as a function of wavenumber for all channels of the NOAA-18 AVHRR/3.

Table D.4-5. Summary of NOAA-18 AVHRR Spectral Response Data (as a Function of Wavenumber) for Each Channel.		
Channel 1		
The peak wavenumber was at 15701.18 and had a value of 0.81.		
File starting point is at wavenumber =12714.03.		
File ending point is at wavenumber = 19620.54		
Moment Center Wavenumber = 15941.6541		
Percent line at which curve crosses	Wavenumber (cm ⁻¹)	μm
0.10%	14089.7734	0.7097
1.00%	14457.1582	0.6917
5.00%	14553.6104	0.6871
10.00%	14632.5156	0.6834
20.00%	14677.5566	0.6813
50.00%	14744.2832	0.6782
80.00%	14785.3281	0.6763
80.00%	16966.7227	0.5894
50.00%	17139.9453	0.5834
20.00%	17301.6289	0.5780
10.00%	17368.2383	0.5758
5.00%	17435.7070	0.5735

1.00%		17589.3066		0.5685	
Area Point Limits	Lower (cm⁻¹)		Upper (cm⁻¹)		
99%	14467.2768		17670.4722		
96%	14666.7269		16958.4975		
70%	15012.3942		16690.8667		
50%	15271.5236		15744.4590		
0% (area center)	16439.5047		15744.4590		
Crossing	Lower (cm⁻¹)	Upper (cm⁻¹)	Width (cm⁻¹)	Center (cm⁻¹)	
80%	14785.3281	16966.7227	2181.3945	15876.0254	
50%	14744.2832	17139.9453	2395.6621	15942.1143	
20%	14677.5566	17301.6289	2624.0723	15989.5928	
5%	14553.6104	17435.7070	2882.0967	15994.6582	
Channel 2					
The peak wavenumber was at 11684.97 and had a value of 0.91					
File starting point is at wavenumber = 7092.20					
File ending point is at wavenumber = 20000.00					
Moment Center Wavenumber = 11988.0283					
Percent line at which curve crosses		Wavenumber (cm⁻¹)		µm	
0.10%		9818.8145		1.0185	
1.00%		9886.4424		1.0115	
5.00%		9947.6836		1.0053	
10.00%		9973.0430		1.0027	
20.00%		9998.5127		1.0001	
50.00%		10038.6396		0.9962	
80.00%		10081.3926		0.9919	
80.00%		13710.9160		0.7293	
50.00%		13966.1904		0.7160	
20.00%		14168.7910		0.7058	
10.00%		14257.7217		0.7014	
5.00%		14327.4346		0.6980	
1.00%		14470.6230		0.6911	
0.10%		14623.8984		0.6838	
Area Point Limits	Lower (cm⁻¹)		Upper (cm⁻¹)		
99%	10015.8719		14147.8789		
96%	10093.8178		13962.6042		
70%	10604.1633		13304.1368		
50%	10985.5068		12906.3968		
0% (area center)	11944.4640		11944.4640		
Crossing	Lower (cm⁻¹)	Upper (cm⁻¹)	Width (cm⁻¹)	Center (cm⁻¹)	
80%	10081.3926	13710.9160	3629.5234	11896.1543	
50%	10038.6396	13966.1904	3927.5508	12002.4150	
20%	9998.5127	14168.7910	4170.2783	12083.6523	
5%	9947.6836	14327.4346	4379.7510	12137.5586	

Channel 3A				
The peak wavenumber was at 6158.01 and had a value of 0.82				
File starting point is at wavenumber = 5780.35				
File ending point is at wavenumber = 6711.41				
Moment Center Wavenumber = 6225.4721				
Percent line at which curve crosses	Wavenumber (cm⁻¹)		μm	
0.10%	6008.3208		1.6644	
1.00%	6056.2271		1.6512	
5.00%	6087.3457		1.6428	
10.00%	6098.4351		1.6398	
20.00%	6109.2563		1.6369	
50.00%	6124.6333		1.6328	
80.00%	6137.1987		1.6294	
80.00%	6312.1401		1.5842	
50.00%	6328.3516		1.5802	
20.00%	6345.6738		1.5759	
10.00%	6356.4141		1.5732	
5.00%	6369.1279		1.5701	
1.00%	6397.9434		1.5630	
0.10%	6453.6514		1.5495	
Area Point Limits	Lower (cm⁻¹)		Upper (cm⁻¹)	
99%	6082.8294		6363.4179	
96%	6107.7351		6339.2353	
70%	6147.3047		6295.9093	
50%	6167.1275		6273.7096	
0% (area center)	6219.6270		6219.6270	
Crossing	Lower (cm⁻¹)	Upper (cm⁻¹)	Width (cm⁻¹)	Center (cm⁻¹)
80%	6137.1987	6312.1401	174.9414	6224.6694
50%	6124.6333	6328.3516	203.7183	6226.4922
20%	6109.2563	6345.6738	236.4175	6227.4648
5%	6087.3457	6369.1279	281.7822	6228.2368
Channel 3B				
The peak wavenumber was at 2674.00 and had a value of 0.93				
File starting point is at wavenumber = 2222.00				
File ending point is at wavenumber = 356.00				
Moment Center Wavenumber = 2663.5665				
Percent line at which curve crosses	Wavenumber (cm⁻¹)		μm	
0.10%	2451.9922		4.0783	
1.00%	2474.3142		4.0415	
5.00%	2500.1025		3.9998	
10.00%	2507.6941		3.9877	
20.00%	2515.6975		3.9750	
50.00%	2528.6841		3.9546	

80.00%	2539.9021	3.9372		
80.00%	2779.7910	3.5974		
50.00%	2795.4414	3.5773		
20.00%	2813.4771	3.5543		
10.00%	2826.0476	3.5385		
5.00%	2840.7441	3.5202		
1.00%	2881.5820	3.4703		
0.10%	2930.8359	3.4120		
Area Point Limits	Lower (cm⁻¹)	Upper (cm⁻¹)		
99%	2505.5415	2839.0646		
96%	2524.0561	2807.4954		
70%	2566.4555	2757.2934		
50%	2594.7136	2729.7172		
0% (area center)	2662.1654	2662.1654		
Crossing	Lower (cm⁻¹)	Upper (cm⁻¹)	Width (cm⁻¹)	Center (cm⁻¹)
80%	2539.9021	2779.7910	239.8889	2659.8467
50%	2528.6841	2795.4414	66.7573	2662.0627
20%	2515.6975	2813.4771	297.7795	2664.5874
5%	2500.1025	2840.7441	340.6416	2670.4233
Channel 4				
The peak wavenumber was at 939.00 and had a value of 0.91				
File starting point is at wavenumber = 788.00				
File ending point is at wavenumber = 5000.00				
Moment Center Wavenumber = 927.0246				
Percent line at which curve crosses	Wavenumber (cm⁻¹)		µm	
0.10%	844.1467		11.8463	
1.00%	862.2675		11.5973	
5.00%	872.0961		11.4666	
10.00%	875.3697		11.4237	
20.00%	878.8188		11.3789	
50.00%	884.8935		11.3008	
80.00%	890.8615		11.2251	
80.00%	966.4460		10.3472	
50.00%	972.7415		10.2802	
20.00%	979.3073		10.2113	
10.00%	982.9404		10.1736	
5.00%	986.2397		10.1395	
1.00%	993.7721		10.0627	
0.10%	1000.7292		9.9927	
Area Point Limits	Lower (cm⁻¹)	Upper (cm⁻¹)		
99%	625.2569	983.7659		
96%	877.9976	975.7423		
70%	896.0601	959.0131		

50%	905.1626		949.9709	
0% (area center)	927.8059		927.8059	
Crossing	Lower (cm⁻¹)	Upper (cm⁻¹)	Width (cm⁻¹)	Center (cm⁻¹)
80%	890.8615	966.4460	75.5845	928.6537
50%	884.8935	972.7415	87.8480	928.8175
20%	878.8188	979.3073	100.4884	929.0630
5%	872.0961	986.2397	114.1437	929.1679
Channel 5				
The peak wavenumber was at 830.43 and had a value of 0.85				
File starting point is at wavenumber = 710.38				
File ending point is at wavenumber = 1005.41				
Moment Center Wavenumber = 839.1349				
Percent line at which curve crosses	Wavenumber (cm⁻¹)		µm	
1.00%	770.5272		12.9781	
1.00%	786.4213		12.7158	
5.00%	771.9020		12.9550	
5.00%	771.9152		12.9548	
5.00%	796.2563		12.5588	
10.00%	798.3840		12.5253	
20.00%	800.4968		12.4922	
50.00%	803.0125		12.4531	
80.00%	805.4152		12.4160	
80.00%	870.3591		11.4895	
50.00%	871.8143		11.4703	
20.00%	873.8174		11.4440	
10.00%	875.6295		11.4204	
5.00%	878.3108		11.3855	
5.00%	1005.4026		9.9463	
1.00%	891.6301		11.2154	
0.10%	996.0803		10.0394	
Area Point Limits	Lower (cm⁻¹)		Upper (cm⁻¹)	
99%	798.2174		874.2559	
96%	802.6562		870.9916	
70%	812.7241		860.9028	
50%	819.5603		853.8218	
0% (area center)	836.6823		836.6823	
Crossing	Lower (cm⁻¹)	Upper (cm⁻¹)	Width (cm⁻¹)	Center (cm⁻¹)
80%	805.4152	870.3591	64.9439	837.8871
50%	803.0125	871.8143	68.8018	837.4134
20%	800.4968	873.8174	73.3207	837.1571
5%	796.2563	878.3108	82.0545	837.2836

Table D.4-6 contains NOAA-18 AVHRR/3 solar reflectance channel information such as equivalent width, w , effective central wavelength, λ_e , and in-band solar irradiance, F .

Channel	Equivalent Width w (μm)	Effective Wavelength λ_e (μm)	Extraterrestrial Solar Irradiance in Band F (W/m^2)
1	0.0793	0.634	130.3
2	0.2465	0.849	246.0
3A	0.0552	1.608	13.53

Note: These quantities are based on the solar irradiance data of *Neckel and Labs* (1984), which is a widely used source of such data.

Table D.4-7 contains the temperature-to-radiance coefficients for NOAA-18 AVHRR/3 Channels 3B, 4 and 5.

	ν_c	A	B
Channel 3B	2659.7952	1.698704	0.996960
Channel 4	928.1460	0.436645	0.998607
Channel 5	833.2532	0.253179	0.999057

Tables D.4-8 and D.4-9 contain the corresponding spectral response values for NOAA-18 AVHRR/3 Channels 1, 2, 3A and Channels 3B, 4 and 5, respectively. Note: Negative response values were caused by system response noise and are to be ignored but are included in the table for completeness.

Channel 1		Channel 2		Channel 3A	
Wavelength (μm)	Relative Response (percent)	Wavelength (μm)	Relative Response (percent)	Wavelength (μm)	Relative Response (percent)
0.43	0.5482	0.5	0.2065	1.49	-0.01126
0.432	-0.4991	0.504	0.1214	1.491	-3.204E-05
0.434	-0.4453	0.508	0.02394	1.492	-0.003608
0.436	-0.4408	0.512	0.1665	1.493	-0.002937
0.438	0.6435	0.516	-0.02392	1.494	0.01482
0.44	-0.05732	0.52	0.01931	1.495	0.0004862
0.442	-0.1989	0.524	0.04631	1.496	-0.006259
0.444	-0.1398	0.528	-0.06858	1.497	-0.005706
0.446	-0.0632	0.532	0.007583	1.498	-0.001863
0.448	-0.08214	0.536	-0.02613	1.499	-0.008933

0.45	-0.0334	0.54	0.03611	1.5	-0.0002507
0.452	0.00343	0.544	-0.01834	1.501	0.002086
0.454	-0.09572	0.548	-0.02654	1.502	-0.01278
0.456	-0.1688	0.552	-0.01448	1.503	-0.005848
0.458	-0.3403	0.556	-0.01198	1.504	0.008775
0.46	0.1185	0.56	-0.01418	1.505	-0.006214
0.462	-0.03081	0.564	0.02179	1.506	0.003444
0.464	-0.09683	0.568	-0.001807	1.507	0.0004027
0.466	-0.1251	0.572	0.0002855	1.508	-0.00329
0.468	-0.06288	0.576	0.002649	1.509	-0.002108
0.47	-0.2463	0.58	0.008655	1.51	4.13E-05
0.472	0.0278	0.584	-0.01562	1.511	0.002915
0.474	-0.05636	0.588	0.002513	1.512	-0.007551
0.476	-0.07515	0.592	0.006055	1.513	-0.003986
0.478	-0.01259	0.596	-0.006155	1.514	-0.01098
0.48	-0.0111	0.6	-0.00424	1.515	0.004049
0.482	-0.02637	0.604	-0.006426	1.516	-0.008353
0.484	-0.09252	0.608	-0.006754	1.517	-0.007597
0.486	-0.05576	0.612	-0.01511	1.518	-0.004678
0.488	-0.03224	0.616	0.01155	1.519	-3.044E-05
0.49	-0.06114	0.62	-0.004929	1.52	-0.002242
0.492	-0.0702	0.624	0.01059	1.521	0.01076
0.494	0.09047	0.628	-0.02405	1.522	-0.005945
0.496	0.02123	0.632	-0.01059	1.523	0.000183
0.498	0.06577	0.636	-0.006757	1.524	0.001962
0.5	-0.07033	0.64	-0.007715	1.525	0.00555
0.502	-0.009833	0.644	-0.003008	1.526	-0.001514
0.504	-0.0752	0.648	0.008143	1.527	-0.001711
0.506	-0.01647	0.652	0.009704	1.528	-0.0004498
0.508	0.04744	0.656	0.01493	1.529	0.005482
0.51	0.002296	0.66	-0.01255	1.53	0.008844
0.512	0.02039	0.664	-0.01785	1.531	-0.001761
0.514	-0.02391	0.668	-0.01165	1.532	-0.004349
0.516	-0.04522	0.672	0.01187	1.533	0.003296
0.518	-0.03861	0.676	0.0009694	1.534	0.002396
0.52	-0.04376	0.68	-0.008144	1.535	-0.003642
0.522	0.06484	0.684	-0.004853	1.536	0.0002447
0.524	-0.04392	0.688	0.002021	1.537	-0.001821
0.526	0.05376	0.692	0.00856	1.538	0.006159
0.528	0.03719	0.696	0.1755	1.539	-0.0001661
0.53	-0.0104	0.7	1.507	1.54	-0.001402
0.532	0.01659	0.704	5.171	1.541	0.01059
0.534	0.0001955	0.708	9.39	1.542	0.0151

0.536	0.02057	0.712	12.99	1.543	0.01423
0.538	-0.04047	0.716	17.12	1.544	0.02244
0.54	0.02254	0.72	21.63	1.545	0.01666
0.542	-0.0184	0.724	27.39	1.546	0.02094
0.544	0.01197	0.728	35.51	1.547	0.03062
0.546	-0.01396	0.732	51.4	1.548	0.04164
0.548	0.005773	0.736	71.72	1.549	0.05266
0.55	0.02533	0.74	76.38	1.55	0.06308
0.552	0.01019	0.744	79.23	1.551	0.08367
0.554	0.02255	0.748	82.73	1.552	0.1095
0.556	0.01334	0.752	86.47	1.553	0.1344
0.558	0.01509	0.756	91.26	1.554	0.1822
0.56	-0.002716	0.76	94.43	1.555	0.215
0.562	0.02062	0.764	95.95	1.556	0.2759
0.564	0.009632	0.768	95.84	1.557	0.3457
0.566	0.04595	0.772	95.25	1.558	0.4404
0.568	0.04264	0.776	95.15	1.559	0.551
0.57	0.07186	0.78	95.89	1.56	0.6884
0.572	0.08527	0.784	97.43	1.561	0.8552
0.574	0.131	0.788	98.47	1.562	1.095
0.576	0.211	0.792	98.71	1.563	1.41
0.578	0.6492	0.796	97.7	1.564	1.758
0.58	1.845	0.8	96.3	1.565	2.232
0.582	4.599	0.804	95.46	1.566	2.811
0.584	11.51	0.808	95.98	1.567	3.554
0.586	25.72	0.812	97	1.568	4.721
0.588	42.72	0.816	98.36	1.569	5.997
0.59	51.3	0.82	99.48	1.57	7.692
0.592	54.72	0.824	99.89	1.571	10.23
0.594	57.82	0.828	100	1.572	13.13
0.596	62.24	0.832	99.63	1.573	17.63
0.598	67.47	0.836	99.13	1.574	22.58
0.6	71.98	0.84	98.71	1.575	29.27
0.602	75.49	0.844	98.44	1.576	38.42
0.604	77.65	0.848	98.14	1.577	48.23
0.606	79.16	0.852	97.58	1.578	62.45
0.608	80.67	0.856	97.13	1.579	75.13
0.61	82.19	0.86	96.44	1.58	83.09
0.612	83.44	0.864	96.17	1.581	85.04
0.614	84.03	0.868	96.13	1.582	86.97
0.616	85.11	0.872	96.13	1.583	89.63
0.618	86.35	0.876	96.54	1.584	90.32
0.62	87.14	0.88	96.98	1.585	92.55

0.622	87.76	0.884	97.28	1.586	92.86
0.624	88.65	0.888	96.68	1.587	94
0.626	89.49	0.892	96.3	1.588	94.44
0.628	90.21	0.896	95.08	1.589	93.81
0.63	90.81	0.9	93.8	1.59	94.93
0.632	90.81	0.904	92.77	1.591	93.64
0.634	92.12	0.908	92.52	1.592	94.64
0.636	93.14	0.912	93.35	1.593	93.8
0.638	94.23	0.916	94.36	1.594	94.22
0.64	95.61	0.92	95.1	1.595	94.37
0.642	97.06	0.924	95.05	1.596	93.67
0.644	98.38	0.928	94.9	1.597	94.75
0.646	99.65	0.932	94.1	1.598	93.49
0.648	100	0.936	94.07	1.599	94.79
0.65	99.52	0.94	95.22	1.6	94
0.652	98.43	0.944	94.3	1.601	94.53
0.654	96.79	0.948	93.92	1.602	95.12
0.656	94.03	0.952	92.37	1.603	94
0.658	92.75	0.956	91	1.604	95.46
0.66	90.41	0.96	90.01	1.605	93.96
0.662	88.63	0.964	89.5	1.606	95.02
0.664	87.11	0.968	89.38	1.607	94.15
0.666	86.74	0.972	88.08	1.608	94.57
0.668	87.69	0.976	84.09	1.609	94.62
0.67	89.95	0.98	78.21	1.61	93.73
0.672	93.34	0.984	72.91	1.611	94.35
0.674	95.35	0.988	70.26	1.612	93.16
0.676	89.57	0.992	63.66	1.613	94.43
0.678	71.41	0.996	40	1.614	92.61
0.68	47.92	1	15.65	1.615	94.13
0.682	28.54	1.004	5.466	1.616	93.09
0.684	16.15	1.008	2.097	1.617	93.36
0.686	9.081	1.012	0.9229	1.618	93.44
0.688	5.125	1.016	0.471	1.619	93.12
0.69	2.97	1.02	0.2807	1.62	94.01
0.692	1.796	1.024	0.1864	1.621	92.98
0.694	1.088	1.028	0.1385	1.622	94.32
0.696	0.6681	1.032	0.1013	1.623	93.05
0.698	0.4033	1.036	0.08116	1.624	100
0.7	0.2331	1.04	0.06362	1.625	93.56
0.702	0.1275	1.044	0.05126	1.626	93.39
0.704	0.07413	1.048	0.03825	1.627	95.56
0.706	0.0412	1.052	0.02733	1.628	92.1

0.708	0.029	1.056	0.02058	1.629	89.69
0.71	0.02537	1.06	0.01907	1.63	87.36
0.712	-0.01369	1.064	0.0112	1.631	86.5
0.714	0.008909	1.068	0.01003	1.632	82.9
0.716	-0.01376	1.072	0.009464	1.633	82.16
0.718	-0.001914	-	-	1.634	78.24
0.72	-0.004212	-	-	1.635	72.23
0.722	-0.01787	-	-	1.636	58.89
0.724	0.0011	-	-	1.637	47.8
0.726	0.001362	-	-	1.638	37.41
0.728	0.00199	-	-	1.639	29.66
0.73	-0.007353	-	-	1.64	23.93
0.732	0.007324	-	-	1.641	18.76
0.734	4.853E-05	-	-	1.642	14.92
0.736	0.003495	-	-	1.643	11.66
0.738	-0.007934	-	-	1.644	9.685
0.74	0.01028	-	-	1.645	7.643
0.742	-0.001353	-	-	1.646	6.282
0.744	0.00312	-	-	1.647	5.004
0.746	-0.004181	-	-	1.648	4.144
0.748	0.0004726	-	-	1.649	3.379
0.75	0.008602	-	-	1.65	2.875
0.752	-9.348E-05	-	-	1.651	2.38
0.754	0.008985	-	-	1.652	1.977
0.756	0.0012	-	-	1.653	1.668
0.758	0.001857	-	-	1.654	1.39
0.76	0.001879	-	-	1.655	1.19
0.762	0.009218	-	-	1.656	0.9964
0.764	0.006994	-	-	1.657	0.8589
0.766	0.005242	-	-	1.658	0.7168
0.768	-0.006815	-	-	1.659	0.6288
0.77	0.005009	-	-	1.66	0.5247
0.772	-0.004104	-	-	1.661	0.4752
0.774	0.009178	-	-	1.662	0.3974
0.776	0.01019	-	-	1.663	0.3486
0.778	0.004144	-	-	1.664	0.3085
0.78	-0.007043	-	-	1.665	0.2679
0.782	0.00225	-	-	1.666	0.2313
0.784	0.002506	-	-	1.667	0.2033
0.786	0.007953	-	-	1.668	0.1823
0.788	0.004954	-	-	1.669	0.1619
0.79	0.003137	-	-	1.67	0.1408
0.792	-0.002639	-	-	1.671	0.1326

0.794	0.008037	-	-	1.672	0.1234
0.796	0.01802	-	-	1.673	0.1114
0.798	0.003976	-	-	1.674	0.1007
0.8	-0.002712	-	-	1.675	0.08638
0.802	0.005298	-	-	1.676	0.0796
0.804	-0.005222	-	-	1.677	0.0762
0.806	0.004339	-	-	1.678	0.06907
0.808	0.007625	-	-	1.679	0.06739
0.81	0.001873	-	-	1.68	0.05652
0.812	0.006123	-	-	1.681	0.05379
0.814	-0.004213	-	-	1.682	0.0533
0.816	0.009167	-	-	1.683	0.0516
0.818	0.001116	-	-	1.684	0.04725
0.82	0.01765	-	-	1.685	0.04468
0.822	0.00647	-	-	1.686	0.03846
0.824	0.008867	-	-	1.687	0.03259
0.826	0.001118	-	-	1.688	0.03191
0.828	-0.0002036	-	-	1.689	0.03388
0.83	0.0007624	-	-	1.69	0.04858
-	-	-	-	1.691	0.02507
-	-	-	-	1.692	0.02033
-	-	-	-	1.693	0.02351
-	-	-	-	1.694	0.02156
-	-	-	-	1.695	0.02583
-	-	-	-	1.696	0.02525
-	-	-	-	1.697	0.02323
-	-	-	-	1.698	0.02113
-	-	-	-	1.699	0.01867
-	-	-	-	1.7	0.02431
-	-	-	-	1.701	0.002693
-	-	-	-	1.702	0.01483
-	-	-	-	1.703	0.01512
-	-	-	-	1.704	0.01155
-	-	-	-	1.705	0.008663
-	-	-	-	1.706	0.007095
-	-	-	-	1.707	0.006973
-	-	-	-	1.708	0.002238
-	-	-	-	1.709	0.006505
-	-	-	-	1.71	-0.001229
-	-	-	-	1.711	0.001694
-	-	-	-	1.712	-0.001285
-	-	-	-	1.713	-0.00546
-	-	-	-	1.714	0.002052

-	-	-	-	1.715	0.0009516
-	-	-	-	1.716	0.002313
-	-	-	-	1.717	0.001935
-	-	-	-	1.718	-2.684E-05
-	-	-	-	1.719	-0.00279
-	-	-	-	1.72	0.004054
-	-	-	-	1.721	-0.009511
-	-	-	-	1.722	0.001225
-	-	-	-	1.723	0.0007064
-	-	-	-	1.724	0.001214
-	-	-	-	1.725	-0.01182
-	-	-	-	1.726	0.0004621
-	-	-	-	1.727	-0.008961
-	-	-	-	1.728	-0.004333
-	-	-	-	1.729	-0.004064
-	-	-	-	1.73	0.006525

Table D.4-9. NOAA-18 AVHRR/3 Spectral Response Values for Channels 3B, 4 and 5.

Channel 3B		Channel 4		Channel 5	
Wavelength (μm)	Relative Response (percent)	Wavelength (μm)	Relative Response (percent)	Wavelength (μm)	Relative Response (percent)
2.98	0.005821	8.8	0.1664	10	-0.03539
2.987	0.00561	8.82	0.3266	10.02	0.009362
2.994	0.002355	8.84	0.1765	10.04	-0.03535
3.001	-1.529E-05	8.86	0.1904	10.06	-0.0293
3.008	0.0004373	8.88	0.0145	10.08	0.0295
3.015	0.002535	8.9	0.08326	10.1	0.07683
3.022	0.001323	8.92	0.2341	10.12	-0.04549
3.029	0.0001636	8.94	0.1932	10.14	-0.02886
3.036	3.501E-05	8.96	0.2334	10.16	0.001643
3.043	0.001975	8.98	0.1628	10.18	-0.04027
3.05	0.002208	9	0.06109	10.2	0.04544
3.057	0.002149	9.02	0.1955	10.22	-0.01036
3.064	0.002497	9.04	0.261	10.24	0.009124
3.071	0.00311	9.06	0.1657	10.26	-0.02651
3.078	0.003457	9.08	0.2374	10.28	0.05153
3.085	0.004767	9.1	0.1182	10.3	-0.05612
3.092	0.004772	9.12	0.1036	10.32	0.03368
3.099	0.001163	9.14	0.1938	10.34	-0.05408
3.106	0.0005487	9.16	0.05562	10.36	0.0223
3.113	0.001447	9.18	0.0903	10.38	0.02301
3.12	0.002405	9.2	0.1095	10.4	-0.009716
3.127	0.001675	9.22	0.01739	10.42	-0.02414
3.134	0.002932	9.24	0.09689	10.44	-0.0637
3.141	5.941E-05	9.26	0.05051	10.46	-0.0008269
3.148	0.00345	9.28	0.06581	10.48	-0.04951
3.155	0.001651	9.3	0.08589	10.5	0.06151
3.162	0.003187	9.32	0.05129	10.52	-0.01731
3.169	0.001797	9.34	0.1091	10.54	-0.03997
3.176	0.004379	9.36	0.08176	10.56	-0.01921
3.183	0.003722	9.38	0.1259	10.58	0.03774
3.19	0.002581	9.4	0.01984	10.6	0.02313
3.197	0.001678	9.42	0.1111	10.62	-0.03246
3.204	0.005527	9.44	0.1688	10.64	-0.03007
3.211	0.0002406	9.46	0.1304	10.66	0.06583
3.218	0.00132	9.48	-0.09623	10.68	0.01592
3.225	0.006236	9.5	0.0599	10.7	-0.05888
3.232	0.004785	9.52	-0.02466	10.72	-0.06153
3.239	0.002852	9.54	-0.01773	10.74	0.03855

3.246	0.000298	9.56	-0.001286	10.76	-0.03731
3.253	0.00556	9.58	-0.0394	10.78	0.004311
3.26	0.005595	9.6	-0.0406	10.8	0.04331
3.267	0.004846	9.62	-0.02805	10.82	-0.01564
3.274	0.005526	9.64	-0.1551	10.84	0.06147
3.281	0.002007	9.66	-0.08078	10.86	-0.02778
3.288	-0.0004339	9.68	-0.0552	10.88	0.02984
3.295	0.003932	9.7	-0.05489	10.9	-0.0221
3.302	0.009059	9.72	0.0202	10.92	0.03233
3.309	0.005778	9.74	-0.05128	10.94	0.06169
3.316	0.01257	9.76	-0.01781	10.96	0.05259
3.323	0.008382	9.78	-0.1544	10.98	-0.01183
3.33	0.009695	9.8	-0.06868	11	-0.01661
3.337	0.0043	9.82	-0.102	11.02	-0.002161
3.344	0.01084	9.84	-0.1521	11.04	0.1169
3.351	0.01195	9.86	-0.1032	11.06	-0.05575
3.358	0.01725	9.88	-0.1164	11.08	0.02142
3.365	0.01695	9.9	-0.09603	11.1	0.06993
3.372	0.02007	9.92	-0.1049	11.12	-0.0166
3.379	0.0251	9.94	-0.1887	11.14	0.07442
3.386	0.03252	9.96	-0.1412	11.16	-0.03891
3.393	0.04612	9.98	-0.1042	11.18	0.04464
3.4	0.06196	10	-0.1022	11.2	0.02668
3.407	0.08595	10.02	-0.127	11.22	-0.0183
3.414	0.119	10.04	0.02737	11.24	0.04568
3.421	0.1649	10.06	0.1489	11.26	-0.00688
3.428	0.1976	10.08	0.3211	11.28	0.02574
3.435	0.3627	10.1	0.6807	11.3	0.09864
3.442	0.4956	10.12	1.229	11.32	0.1962
3.449	0.6263	10.14	2.121	11.34	0.3741
3.456	0.8734	10.16	3.478	11.36	0.7868
3.463	1.028	10.18	5.523	11.38	1.571
3.47	1.321	10.2	8.297	11.4	2.875
3.477	1.579	10.22	12.01	11.42	5.23
3.484	1.956	10.24	16.59	11.44	8.925
3.491	2.343	10.26	21.82	11.46	15.32
3.498	2.728	10.28	28.04	11.48	24.65
3.505	3.498	10.3	36.11	11.5	36.17
3.512	4.298	10.32	45.15	11.52	48.31
3.519	6.077	10.34	54.89	11.54	58.85
3.526	7.809	10.36	65.02	11.56	67.67
3.533	10.8	10.38	74.83	11.58	73.48
3.54	15.23	10.4	83.64	11.6	77.85

3.547	21.18	10.42	89.46	11.62	79.85
3.554	29.14	10.44	94.95	11.64	82.47
3.561	36.85	10.46	97.2	11.66	83.31
3.568	49.22	10.48	97.76	11.68	85.39
3.575	58.74	10.5	98.31	11.7	86.94
3.582	70.04	10.52	97.18	11.72	88.47
3.589	77.15	10.54	98.26	11.74	90.35
3.596	79.57	10.56	99.08	11.76	92.79
3.603	81.86	10.58	98.26	11.78	93.14
3.61	81.4	10.6	99.65	11.8	93.71
3.617	84.25	10.62	100	11.82	95.72
3.624	81.43	10.64	99.38	11.84	98.03
3.631	84.86	10.66	98.96	11.86	97.78
3.638	82.78	10.68	98.7	11.88	99.09
3.645	83.16	10.7	98.34	11.9	97.98
3.652	83.36	10.72	97.68	11.92	99.45
3.659	85	10.74	97.32	11.94	99.56
3.666	95.38	10.76	96.96	11.96	99.83
3.673	93.76	10.78	96.52	11.98	100
3.68	84.9	10.8	95.47	12	99.15
3.687	88.73	10.82	94.86	12.02	98.48
3.694	89.76	10.84	95.06	12.04	98.44
3.701	89.21	10.86	95.04	12.06	95.09
3.708	86.22	10.88	94.44	12.08	93.53
3.715	89.46	10.9	93.75	12.1	92.95
3.722	85.68	10.92	92.68	12.12	90.8
3.729	90.26	10.94	94.39	12.14	90.82
3.736	89.67	10.96	92.52	12.16	89.38
3.743	93.6	10.98	94.14	12.18	88.33
3.75	92.67	11	92.27	12.2	88.71
3.757	91.65	11.02	92.15	12.22	86.41
3.764	92.49	11.04	90.55	12.24	88.33
3.771	94.58	11.06	90.11	12.26	89.27
3.778	92.4	11.08	88.31	12.28	89.95
3.785	92.22	11.1	87.36	12.3	91.59
3.792	95.55	11.12	87.15	12.32	93.14
3.799	97	11.14	84.44	12.34	94.25
3.806	94.28	11.16	83.06	12.36	94.16
3.813	94.47	11.18	79.52	12.38	92.34
3.82	94.82	11.2	77.08	12.4	96.56
3.827	95.15	11.22	72.44	12.42	95.37
3.834	95.26	11.24	69.35	12.44	97.64
3.841	96.1	11.26	63.02	12.46	93.88

3.848	97.23	11.28	57.15	12.48	82.69
3.855	98.11	11.3	50.13	12.5	63.53
3.862	95.69	11.32	43.17	12.52	42.87
3.869	95.4	11.34	35.73	12.54	26.33
3.876	97.07	11.36	27.99	12.56	14.92
3.883	93.86	11.38	21.5	12.58	8.684
3.89	100	11.4	15.3	12.6	4.974
3.897	99.77	11.42	10.68	12.62	2.797
3.904	99.52	11.44	7.159	12.64	1.742
3.911	99.16	11.46	4.722	12.66	1.017
3.918	98.94	11.48	3.078	12.68	0.5638
3.925	96.26	11.5	1.982	12.7	0.3322
3.932	91	11.52	1.159	12.72	0.144
3.939	86.68	11.54	0.6558	12.74	0.0605
3.946	71.67	11.56	0.4008	12.76	-0.05995
3.953	55.73	11.58	0.07971	12.78	-0.0385
3.96	41.3	11.6	0.008586	12.8	-0.06778
3.967	29.33	11.62	-0.1254	12.82	0.1887
3.974	20.65	11.64	-0.21	12.84	0.2857
3.981	14.13	11.66	-0.1972	12.86	0.04413
3.988	9.936	11.68	-0.3574	12.88	0.1186
3.995	6.924	11.7	-0.3092	12.9	0.02591
4.002	4.856	11.72	-0.3359	12.92	-0.1105
4.009	3.513	11.74	-0.5355	12.94	0.1204
4.016	2.442	11.76	-0.4984	12.96	-0.06407
4.023	1.889	11.78	-0.4807	12.98	0.1746
4.03	1.269	11.8	-0.3643	13	0.1595
4.037	1.087	11.82	-0.4365	13.02	0.1376
4.044	0.7584	11.84	-0.5022	13.04	-0.1519
4.051	0.6058	11.86	-0.4786	13.06	0.05289
4.058	0.4821	11.88	-0.4761	13.08	0.05021
4.065	0.3838	11.9	-0.4715	13.1	0.08246
4.072	0.3136	11.92	-0.5192	13.12	0.2107
4.079	0.248	11.94	-0.2958	13.14	0.03574
4.086	0.2115	11.96	-0.6285	13.16	-0.01452
4.093	0.1635	11.98	-0.5023	13.18	0.06603
4.1	0.1403	12	-0.1587	13.2	-0.004502
4.107	0.1133	12.02	-0.4732	13.22	0.02938
4.114	0.08231	12.04	-0.3381	13.24	-0.04886
4.121	0.06583	12.06	-0.469	13.26	0.0832
4.128	0.05304	12.08	-0.4146	13.28	0.2739
4.135	0.0337	12.1	-0.6317	13.3	-0.03366
4.142	0.02065	12.12	-0.6343	13.32	0.1177

4.149	0.01889	12.14	-0.4281	13.34	0.2025
4.156	0.01196	12.16	-0.6491	13.36	0.008849
4.163	0.004455	12.18	-0.2293	13.38	0.02656
4.17	0.007121	12.2	-0.4266	13.4	-0.01216
4.177	0.002943	12.22	-0.6318	13.42	0.3052
4.184	-0.0007016	12.24	-0.4505	13.44	-0.002972
4.191	-0.002028	12.26	-0.4623	13.46	0.01109
4.198	-0.003898	12.28	-0.5168	13.48	-0.1169
4.205	-0.0139	12.3	-0.6779	13.5	0.509
4.212	-0.04703	12.32	-0.5929	13.52	-0.1562
4.219	-0.05257	12.34	-0.8243	13.54	0.2066
4.226	-0.07508	12.36	-0.5347	13.56	0.1686
4.233	-0.02801	12.38	-0.3443	13.58	-0.09293
4.24	-0.03737	12.4	-0.5403	13.6	-0.007727
4.247	-0.1056	12.42	-0.5	13.62	-0.09775
4.254	-0.07546	12.44	-0.7121	13.64	-0.07847
4.261	-0.06858	12.46	-0.7646	13.66	0.04921
4.268	-0.1266	12.48	-0.5827	13.68	-0.1566
4.275	-0.0527	12.5	-0.725	13.7	-0.1099
4.282	-0.04364	12.52	-0.7138	13.72	0.3277
4.289	-0.0431	12.54	-0.6647	13.74	-0.08578
4.296	-0.009898	12.56	-8.718	13.76	-0.003167
4.303	-0.01734	12.58	-0.8265	13.78	0.07112
4.31	-0.03678	12.6	-0.7906	13.8	-0.07199
4.317	0.01129	12.62	-0.4469	13.82	-0.05294
4.324	-0.002634	12.64	-0.4937	13.84	0.2021
4.331	0.002679	12.66	-0.8176	13.86	0.03029
4.338	0.002191	12.68	-0.6362	13.88	0.02452
4.345	0.00577	12.7	-0.7739	13.9	-0.1051
4.352	0.01104	12.72	-0.6734	13.92	0.4075
4.359	-0.008302	12.74	-0.9375	13.94	-0.1286
4.366	-0.009341	12.76	-0.4207	13.96	0.07785
4.373	-0.005425	12.78	-0.6681	13.98	0.07564
4.38	-0.005811	12.8	-0.4439	14	-0.1319
4.387	-0.005233	-	-	-	-
4.394	-0.001638	-	-	-	-
4.401	-0.005789	-	-	-	-
4.408	-0.004191	-	-	-	-
4.415	-0.004848	-	-	-	-
4.422	-0.005277	-	-	-	-
4.429	-0.003116	-	-	-	-
4.436	-0.004228	-	-	-	-
4.443	-0.0102	-	-	-	-

4.45	-0.01022	-	-	-	-
4.457	-0.008099	-	-	-	-
4.464	-0.0053	-	-	-	-
4.471	-0.01029	-	-	-	-
4.478	-0.003282	-	-	-	-
4.485	-0.00695	-	-	-	-
4.492	-0.005923	-	-	-	-
4.499	-0.001851	-	-	-	-

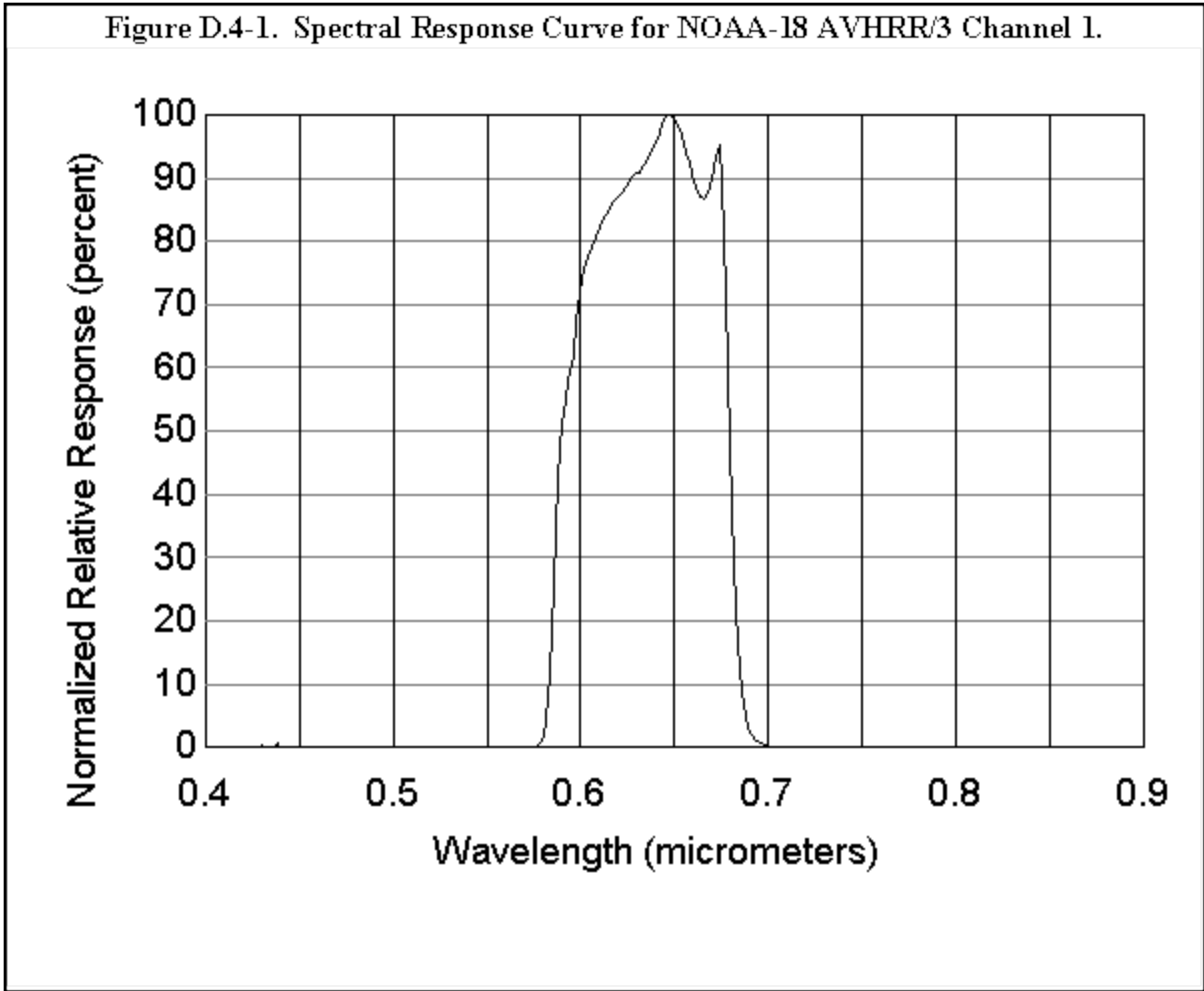

Figure D.4-1. Spectral Response Curve for NOAA-18 Channel 1.

Figure D.4-2. Spectral Response Curve for NOAA-18 AVHRR/3 Channel 2.

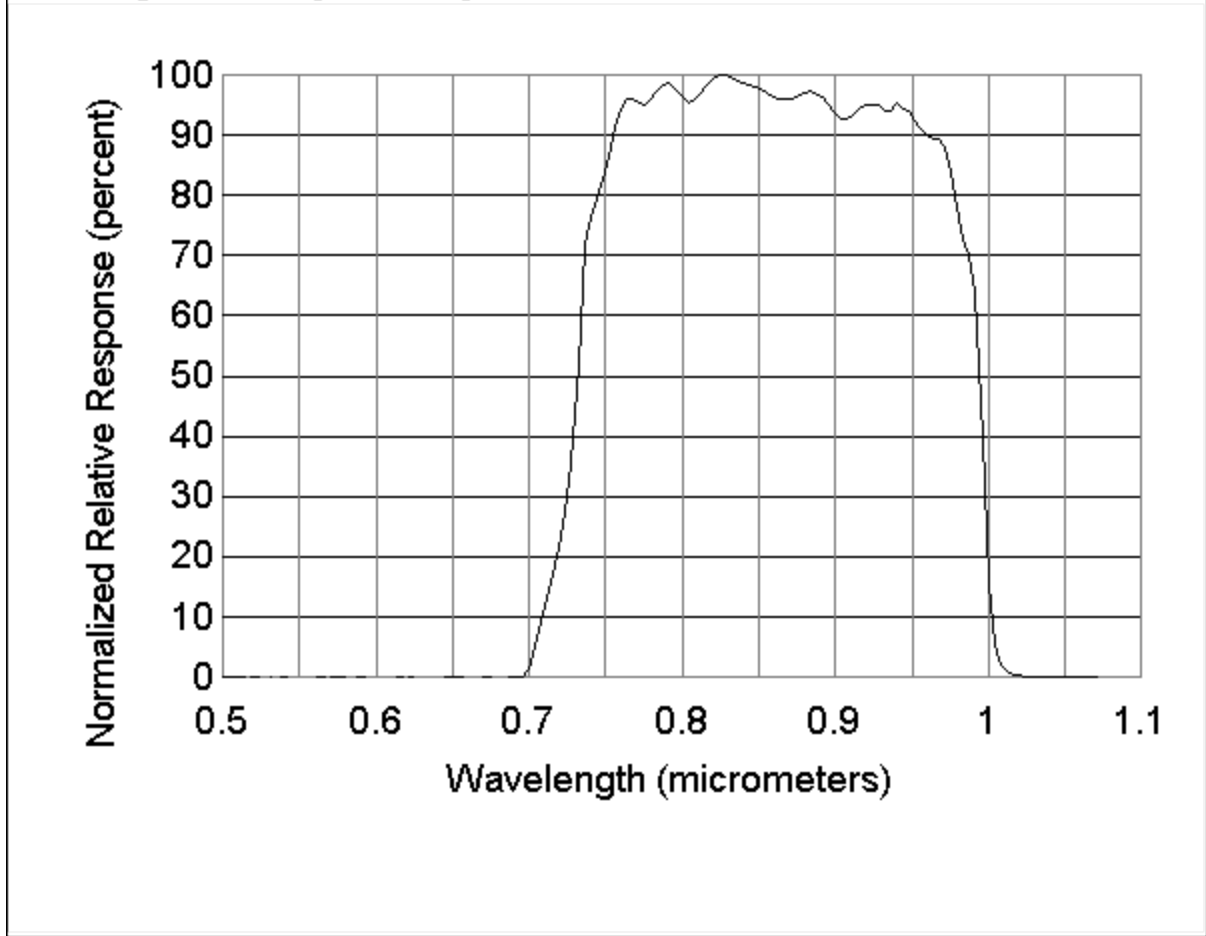

Figure D.4-2. Spectral Response Curve for NOAA-18 Channel 2.

Figure D.4-3. Spectral Response Curve for NOAA-18 AVHRR/3 Channel 3A.

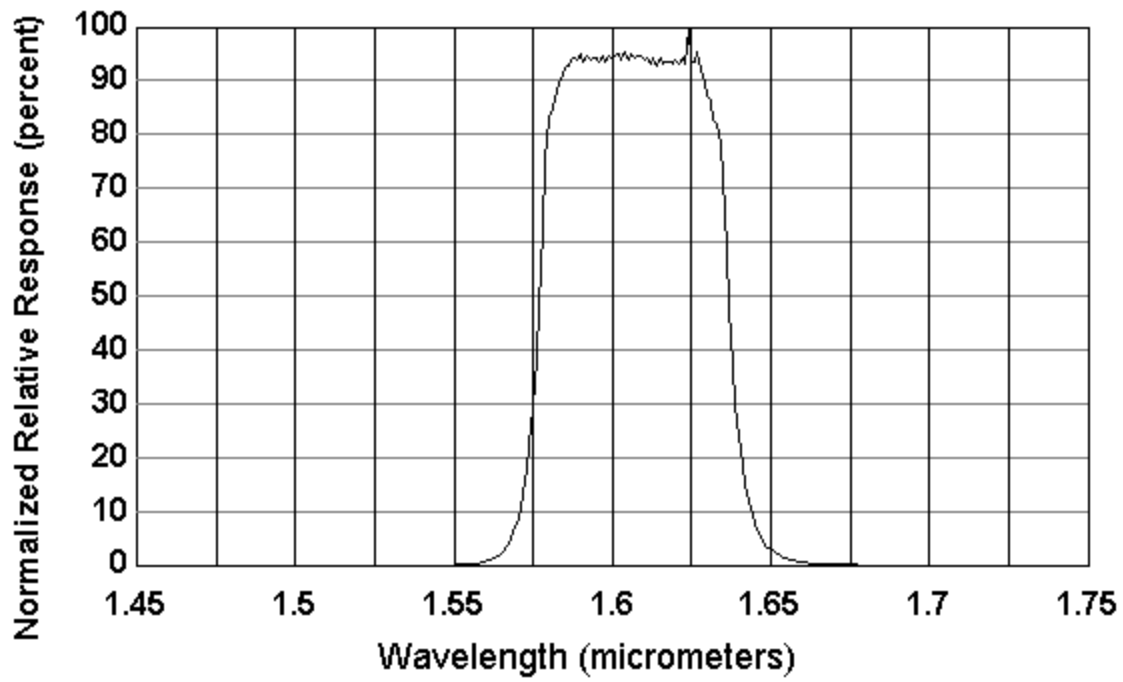

Figure D.4-3. Spectral Response Curve for NOAA-18 Channel 3A.

Figure D.4-4. Spectral Response Curve for NOAA-18 AVHRR/3 Channel 3B.

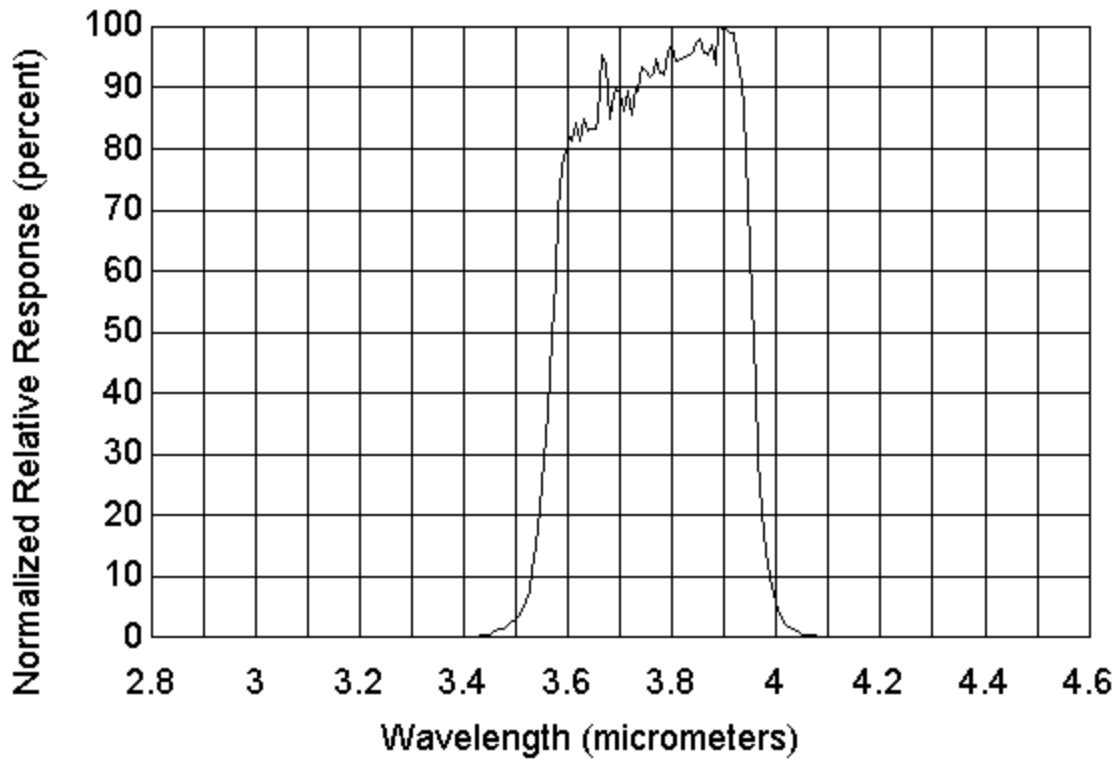

Figure D.4-4. Spectral Response Curve for NOAA-18 Channel 3B.

Figure D.4-5. Spectral Response Curve for NOAA-18 AVHRR/3 Channel 4.

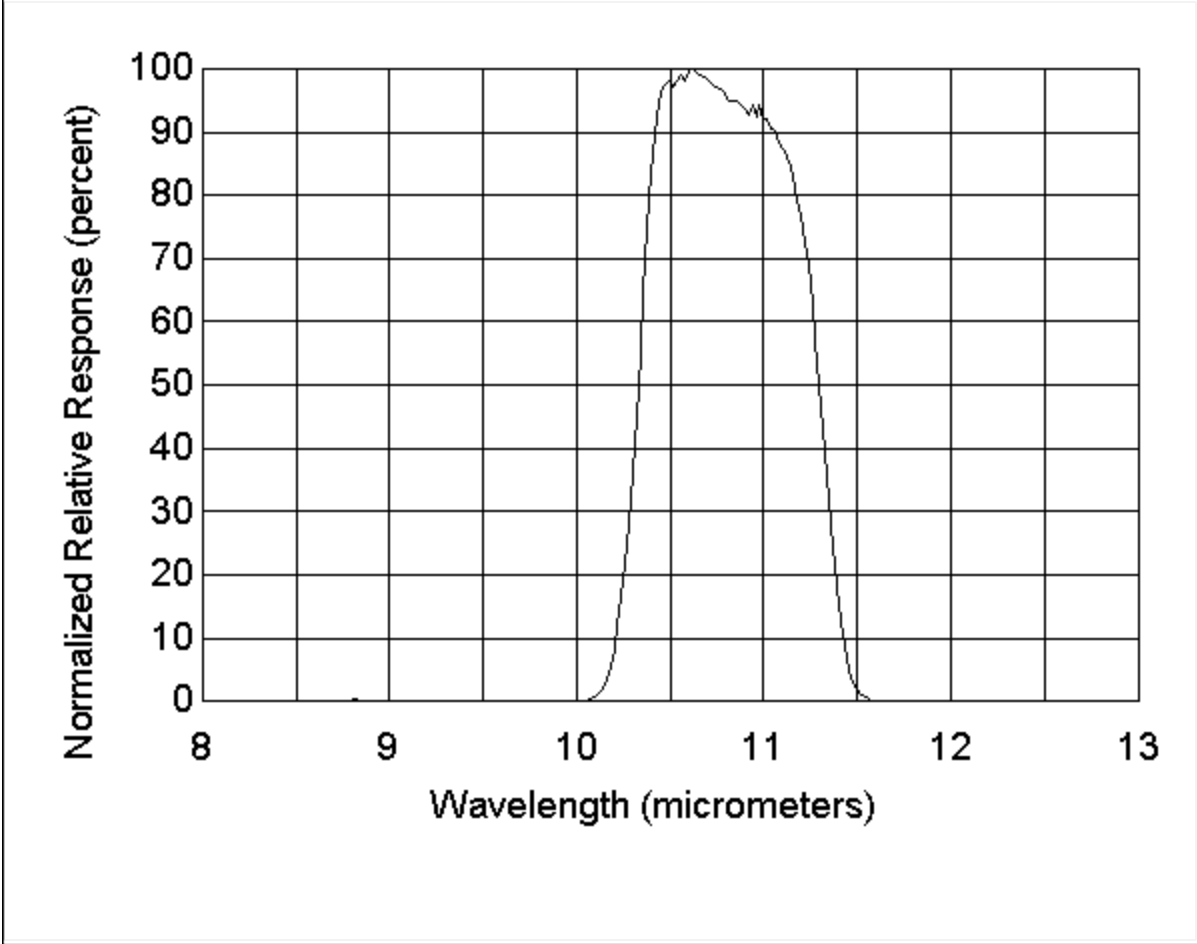

Figure D.4-5. Spectral Response Curve for NOAA-18 Channel 4.

Figure D.4-6. Spectral Response Curve for NOAA-18 AVHRR/3 Channel 5.

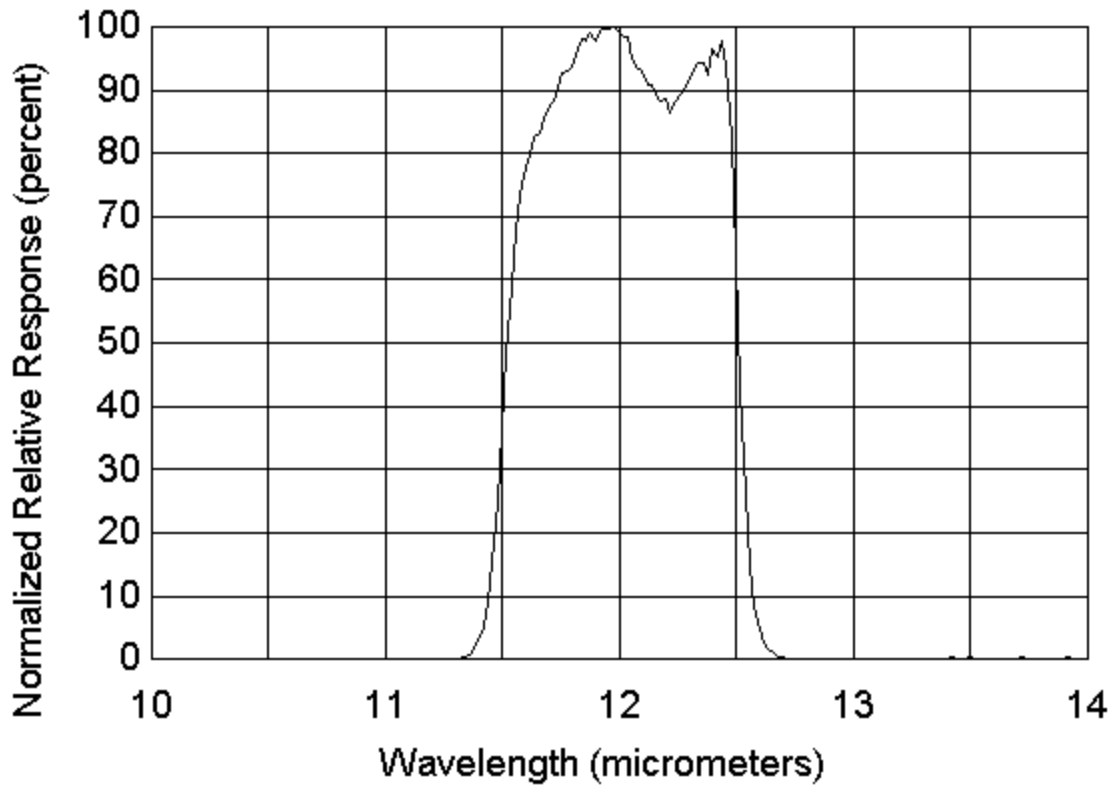

Figure D.4-6. Spectral Response Curve for NOAA-18 Channel 5.

HIRS:

Table D.4-10 contains the NOAA-18 HIRS H305 central wave numbers, half power bandwidth and band correction coefficients for the thermal channels.

Table D.4-10. NOAA-18 HIRS (H305) Central Wave Numbers (ν_c), Half power Bandwidth and Band Correction Coefficients (b and c).				
Channel #	ν_c (cm⁻¹)	Half power bandwidth (cm⁻¹)	b	c
1	668.18	3.81	0.001128	0.99999
2	680.94	10.45	0.008162	0.99996
3	689.68	14.68	0.019228	0.99991
4	703.81	15.91	0.017887	0.99992
5	714.34	16.86	0.019409	0.99991
6	731.54	17.00	0.019968	0.99991
7	750.56	19.26	0.109210	0.99973
8	900.46	34.88	0.065734	0.99977
9	1029.10	22.07	0.043472	0.99986
10	800.73	14.83	0.016207	0.99994
11	1364.70	39.12	0.071179	0.99982
12	1532.20	53.44	0.110780	0.99975
13	2189.20	20.69	0.017224	0.99997
14	2208.40	22.05	0.018594	0.99997
15	2238.40	21.65	0.019559	0.99997
16	2246.70	21.44	0.017640	0.99997
17	2419.20	27.78	0.029872	0.99995
18	2515.40	32.42	0.048696	0.99993
19	2666.10	101.30	0.280120	0.99962

Table D.4-11 contains the Internal Warm Temperature (IWT) PRT count to temperature coefficients for the NOAA-18 HIRS/305 instrument.

Table D.4-11. NOAA-18 IWT PRT Count to Temperature Coefficients for HIRS/305.						
PRT	A	B	C	D	E	F
1	2.818913E+01	6.571395E-03	8.918025E-08	3.469261E-11	8.789154E-16	6.667266E-19
2	2.823452E+01	6.556452E-03	8.791554E-08	3.575126E-11	1.010300E-15	5.881786E-19
3	2.821351E+01	6.574104E-03	9.044518E-08	3.422432E-11	8.675638E-16	6.772438E-19
4	2.818215E+01	6.571375E-03	8.890512E-08	3.598827E-11	1.001696E-15	5.830618E-19
5	2.823273E+01	6.569930E-03	8.772601E-08	3.383069E-11	1.044107E-15	6.888075E-19

This information is based on the data in HIRS/4 H305 Alignment/Calibration Handbook, Revision E, May 2003.

Table D.4-12 contains the primary, secondary and tertiary telescope temperature coefficients for the NOAA-18 HIRS/H305 instrument.

Table D.4-12. NOAA-17 HIRS/305 Primary, Secondary and Tertiary Telescope Temperature Coefficients.						
	A	B	C	D	E	F
Primary	-1.297930 E+01	1.760107 E-02	-3.801217 E-06	1.395499E -09	-2.765677 E-13	2.919796 E-17
Secondary	-1.294181 E+01	1.768703E -02	-3.910969 E-06	1.447734E -09	-2.868346 E-13	2.985872 E-17
Tertiary	-1.294164 E+01	1.758273E -02	-3.788286 E-06	1.385381E -09	-2.722860 E-13	2.857689 E-17

This information is based on the data in HIRS/4 H305 Alignment/Calibration Handbook, Revision E, May 2003.

Table D.4-13 contains the actual filter functions for NOAA-18 HIRS/H305

Table D.4-13. Normalized Response Functions for the NOAA-18 HIRS H305 Thermal Channels.				
Channel 1				
Wavenumber	HIRS Filter Transmittance	Optical Element Transmittance	Product of the HIRS Filter and Optical Element Transmittances	Normalized Value of Column 4
6.63800E+02	0.00000E+00	2.57520E-01	0.00000E+00	0.00000E+00
6.63900E+02	1.73210E-04	2.57730E-01	4.46420E-05	2.98770E-04
6.64000E+02	2.40900E-04	2.57950E-01	6.21400E-05	4.15880E-04
6.64100E+02	1.59840E-03	2.58190E-01	4.12690E-04	2.76200E-03
6.64200E+02	3.03690E-03	2.58440E-01	7.84850E-04	5.25270E-03
6.64300E+02	4.89460E-03	2.58690E-01	1.26620E-03	8.47400E-03
6.64400E+02	7.72030E-03	2.58930E-01	1.99900E-03	1.33790E-02
6.64500E+02	1.12160E-02	2.59180E-01	2.90690E-03	1.94550E-02
6.64600E+02	1.56170E-02	2.59420E-01	4.05150E-03	2.71150E-02
6.64700E+02	2.12960E-02	2.59670E-01	5.53000E-03	3.70100E-02
6.64800E+02	2.81220E-02	2.59910E-01	7.30920E-03	4.89180E-02
6.64900E+02	3.62850E-02	2.60160E-01	9.43980E-03	6.31780E-02
6.65000E+02	4.60360E-02	2.60400E-01	1.19880E-02	8.02300E-02
6.65100E+02	5.72580E-02	2.60640E-01	1.49240E-02	9.98790E-02
6.65200E+02	7.00530E-02	2.60880E-01	1.82760E-02	1.22310E-01
6.65300E+02	8.45300E-02	2.61120E-01	2.20730E-02	1.47730E-01
6.65400E+02	1.00510E-01	2.61370E-01	2.62690E-02	1.75810E-01

6.65500E+02	1.17960E-01	2.61610E-01	3.08600E-02	2.06540E-01
6.65600E+02	1.36850E-01	2.61880E-01	3.58380E-02	2.39850E-01
6.65700E+02	1.56890E-01	2.62160E-01	4.11300E-02	2.75270E-01
6.65800E+02	1.77960E-01	2.62430E-01	4.67020E-02	3.12560E-01
6.65900E+02	1.99900E-01	2.62700E-01	5.25120E-02	3.51450E-01
6.66000E+02	2.22370E-01	2.62970E-01	5.84760E-02	3.91360E-01
6.66100E+02	2.45180E-01	2.63320E-01	6.45610E-02	4.32090E-01
6.66200E+02	2.68130E-01	2.63680E-01	7.06990E-02	4.73170E-01
6.66300E+02	2.90910E-01	2.64030E-01	7.68090E-02	5.14060E-01
6.66400E+02	3.13350E-01	2.64390E-01	8.28450E-02	5.54450E-01
6.66500E+02	3.35280E-01	2.64740E-01	8.87620E-02	5.94060E-01
6.66600E+02	3.56480E-01	2.65100E-01	9.45020E-02	6.32470E-01
6.66700E+02	3.76850E-01	2.65460E-01	1.00040E-01	6.69520E-01
6.66800E+02	3.96310E-01	2.65820E-01	1.05350E-01	7.05040E-01
6.66900E+02	4.14740E-01	2.66180E-01	1.10390E-01	7.38830E-01
6.67000E+02	4.32120E-01	2.66530E-01	1.15180E-01	7.70840E-01
6.67100E+02	4.48450E-01	2.66930E-01	1.19700E-01	8.01140E-01
6.67200E+02	4.63660E-01	2.67320E-01	1.23950E-01	8.29540E-01
6.67300E+02	4.77780E-01	2.67720E-01	1.27910E-01	8.56060E-01
6.67400E+02	4.90810E-01	2.68110E-01	1.31590E-01	8.80690E-01
6.67500E+02	5.02700E-01	2.68530E-01	1.34990E-01	9.03420E-01
6.67600E+02	5.13440E-01	2.68950E-01	1.38090E-01	9.24170E-01
6.67700E+02	5.22980E-01	2.69370E-01	1.40880E-01	9.42830E-01
6.67800E+02	5.31260E-01	2.69790E-01	1.43330E-01	9.59250E-01
6.67900E+02	5.38200E-01	2.70210E-01	1.45430E-01	9.73290E-01
6.68000E+02	5.43700E-01	2.70630E-01	1.47140E-01	9.84760E-01
6.68100E+02	5.47640E-01	2.70900E-01	1.48360E-01	9.92920E-01
6.68200E+02	5.49920E-01	2.71180E-01	1.49130E-01	9.98070E-01
6.68300E+02	5.50410E-01	2.71460E-01	1.49420E-01	1.00000E+00
6.68400E+02	5.49010E-01	2.71740E-01	1.49190E-01	9.98490E-01
6.68500E+02	5.45630E-01	2.72020E-01	1.48420E-01	9.93350E-01
6.68600E+02	5.40180E-01	2.72310E-01	1.47090E-01	9.84450E-01
6.68700E+02	5.32630E-01	2.72590E-01	1.45190E-01	9.71690E-01
6.68800E+02	5.22960E-01	2.72870E-01	1.42700E-01	9.55040E-01
6.68900E+02	5.11180E-01	2.73160E-01	1.39630E-01	9.34510E-01
6.69000E+02	4.97380E-01	2.73440E-01	1.36000E-01	9.10230E-01
6.69100E+02	4.81640E-01	2.73720E-01	1.31830E-01	8.82320E-01
6.69200E+02	4.64080E-01	2.74000E-01	1.27160E-01	8.51030E-01
6.69300E+02	4.44900E-01	2.74280E-01	1.22030E-01	8.16700E-01
6.69400E+02	4.24260E-01	2.74590E-01	1.16500E-01	7.79680E-01
6.69500E+02	4.02390E-01	2.74910E-01	1.10620E-01	7.40350E-01
6.69600E+02	3.79550E-01	2.75230E-01	1.04460E-01	6.99150E-01
6.69700E+02	3.55960E-01	2.75550E-01	9.80850E-02	6.56450E-01

6.69800E+02	3.31870E-01	2.75880E-01	9.15550E-02	6.12750E-01
6.69900E+02	3.07570E-01	2.76200E-01	8.49520E-02	5.68560E-01
6.70000E+02	2.83260E-01	2.76530E-01	7.83310E-02	5.24240E-01
6.70100E+02	2.59200E-01	2.76820E-01	7.17530E-02	4.80220E-01
6.70200E+02	2.35640E-01	2.77110E-01	6.53000E-02	4.37030E-01
6.70300E+02	2.12730E-01	2.77400E-01	5.90120E-02	3.94940E-01
6.70400E+02	1.90660E-01	2.77700E-01	5.29450E-02	3.54340E-01
6.70500E+02	1.69630E-01	2.77990E-01	4.71550E-02	3.15590E-01
6.70600E+02	1.49700E-01	2.78280E-01	4.16570E-02	2.78800E-01
6.70700E+02	1.31000E-01	2.78570E-01	3.64920E-02	2.44230E-01
6.70800E+02	1.13660E-01	2.78860E-01	3.16950E-02	2.12120E-01
6.70900E+02	9.76350E-02	2.79150E-01	2.72550E-02	1.82410E-01
6.71000E+02	8.30080E-02	2.79440E-01	2.31960E-02	1.55240E-01
6.71100E+02	6.98340E-02	2.79720E-01	1.95340E-02	1.30740E-01
6.71200E+02	5.79800E-02	2.80010E-01	1.62350E-02	1.08660E-01
6.71300E+02	4.74910E-02	2.80300E-01	1.33120E-02	8.90920E-02
6.71400E+02	3.83730E-02	2.80610E-01	1.07680E-02	7.20660E-02
6.71500E+02	3.04180E-02	2.80920E-01	8.54490E-03	5.71880E-02
6.71600E+02	2.36590E-02	2.81230E-01	6.65370E-03	4.45310E-02
6.71700E+02	1.80760E-02	2.81540E-01	5.08900E-03	3.40590E-02
6.71800E+02	1.33890E-02	2.81850E-01	3.77360E-03	2.52560E-02
6.71900E+02	9.65750E-03	2.82160E-01	2.72490E-03	1.82370E-02
6.72000E+02	6.85290E-03	2.82470E-01	1.93570E-03	1.29550E-02
6.72100E+02	4.61150E-03	2.82770E-01	1.30400E-03	8.72740E-03
6.72200E+02	3.06700E-03	2.83080E-01	8.68210E-04	5.81070E-03
6.72300E+02	2.20910E-03	2.83390E-01	6.26020E-04	4.18980E-03
6.72400E+02	1.50690E-03	2.83690E-01	4.27510E-04	2.86120E-03
6.72500E+02	1.29130E-03	2.84000E-01	3.66730E-04	2.45440E-03
6.72600E+02	1.68100E-03	2.84300E-01	4.77910E-04	3.19850E-03
6.72700E+02	1.29810E-03	2.84600E-01	3.69450E-04	2.47260E-03
6.72800E+02	0.00000E+00	2.84910E-01	0.00000E+00	0.00000E+00

Channel 2

Wavenumber	HIRS Filter Transmittance	Optical Element Transmittance	Product of the HIRS Filter and Optical Element Transmittances	Normalized Value of Column 4
6.69200E+02	0.00000E+00	2.74000E-01	0.00000E+00	0.00000E+00
6.69250E+02	2.58780E-04	2.74140E-01	7.09430E-05	4.50390E-04
6.69300E+02	6.45400E-04	2.74280E-01	1.77020E-04	1.12390E-03
6.69350E+02	1.71160E-03	2.74430E-01	4.69720E-04	2.98210E-03
6.69400E+02	2.80200E-03	2.74590E-01	7.69400E-04	4.88460E-03
6.69450E+02	2.80700E-03	2.74750E-01	7.71220E-04	4.89620E-03
6.69500E+02	2.90200E-03	2.74910E-01	7.97790E-04	5.06490E-03

6.69550E+02	2.90700E-03	2.75070E-01	7.99630E-04	5.07660E-03
6.69600E+02	3.00200E-03	2.75230E-01	8.26250E-04	5.24550E-03
6.69650E+02	3.00700E-03	2.75390E-01	8.28110E-04	5.25740E-03
6.69700E+02	3.10200E-03	2.75550E-01	8.54770E-04	5.42660E-03
6.69750E+02	3.10700E-03	2.75720E-01	8.56650E-04	5.43860E-03
6.69800E+02	3.20200E-03	2.75880E-01	8.83360E-04	5.60820E-03
6.69850E+02	3.20700E-03	2.76040E-01	8.85270E-04	5.62020E-03
6.69900E+02	3.30200E-03	2.76200E-01	9.12030E-04	5.79010E-03
6.69950E+02	3.30700E-03	2.76370E-01	9.13950E-04	5.80230E-03
6.70000E+02	3.40200E-03	2.76530E-01	9.40760E-04	5.97250E-03
6.70050E+02	3.40700E-03	2.76680E-01	9.42630E-04	5.98450E-03
6.70100E+02	3.50200E-03	2.76820E-01	9.69430E-04	6.15460E-03
6.70150E+02	3.50700E-03	2.76970E-01	9.71320E-04	6.16660E-03
6.70200E+02	3.60200E-03	2.77110E-01	9.98160E-04	6.33700E-03
6.70250E+02	3.60700E-03	2.77260E-01	1.00010E-03	6.34910E-03
6.70300E+02	3.70200E-03	2.77400E-01	1.02690E-03	6.51970E-03
6.70350E+02	3.70700E-03	2.77550E-01	1.02890E-03	6.53200E-03
6.70400E+02	3.80200E-03	2.77700E-01	1.05580E-03	6.70290E-03
6.70450E+02	3.80700E-03	2.77840E-01	1.05770E-03	6.71520E-03
6.70500E+02	3.90200E-03	2.77990E-01	1.08470E-03	6.88640E-03
6.70550E+02	3.90700E-03	2.78130E-01	1.08670E-03	6.89880E-03
6.70600E+02	4.10210E-03	2.78280E-01	1.14150E-03	7.24720E-03
6.70650E+02	4.11080E-03	2.78420E-01	1.14450E-03	7.26630E-03
6.70700E+02	4.19640E-03	2.78570E-01	1.16900E-03	7.42140E-03
6.70750E+02	4.35960E-03	2.78710E-01	1.21510E-03	7.71420E-03
6.70800E+02	4.59540E-03	2.78860E-01	1.28150E-03	8.13570E-03
6.70850E+02	4.87410E-03	2.79000E-01	1.35990E-03	8.63340E-03
6.70900E+02	5.11010E-03	2.79150E-01	1.42650E-03	9.05620E-03
6.70950E+02	5.31550E-03	2.79290E-01	1.48460E-03	9.42510E-03
6.71000E+02	5.50920E-03	2.79440E-01	1.53950E-03	9.77360E-03
6.71050E+02	5.71480E-03	2.79580E-01	1.59770E-03	1.01440E-02
6.71100E+02	5.95740E-03	2.79720E-01	1.66640E-03	1.05790E-02
6.71150E+02	6.26050E-03	2.79870E-01	1.75210E-03	1.11240E-02
6.71200E+02	6.59480E-03	2.80010E-01	1.84660E-03	1.17230E-02
6.71250E+02	6.90130E-03	2.80150E-01	1.93340E-03	1.22750E-02
6.71300E+02	7.18240E-03	2.80300E-01	2.01320E-03	1.27810E-02
6.71350E+02	7.44380E-03	2.80460E-01	2.08760E-03	1.32540E-02
6.71400E+02	7.69280E-03	2.80610E-01	2.15870E-03	1.37050E-02
6.71450E+02	7.93820E-03	2.80770E-01	2.22880E-03	1.41500E-02
6.71500E+02	8.18870E-03	2.80920E-01	2.30040E-03	1.46040E-02
6.71550E+02	8.45270E-03	2.81070E-01	2.37580E-03	1.50830E-02
6.71600E+02	8.73710E-03	2.81230E-01	2.45710E-03	1.55990E-02
6.71650E+02	9.04760E-03	2.81380E-01	2.54590E-03	1.61630E-02

6.71700E+02	9.38820E-03	2.81540E-01	2.64310E-03	1.67800E-02
6.71750E+02	9.76140E-03	2.81690E-01	2.74970E-03	1.74570E-02
6.71800E+02	1.01690E-02	2.81850E-01	2.86610E-03	1.81960E-02
6.71850E+02	1.06130E-02	2.82000E-01	2.99290E-03	1.90010E-02
6.71900E+02	1.10940E-02	2.82160E-01	3.13040E-03	1.98740E-02
6.71950E+02	1.16150E-02	2.82310E-01	3.27890E-03	2.08170E-02
6.72000E+02	1.21750E-02	2.82470E-01	3.43890E-03	2.18320E-02
6.72050E+02	1.27760E-02	2.82620E-01	3.61080E-03	2.29240E-02
6.72100E+02	1.34230E-02	2.82770E-01	3.79570E-03	2.40980E-02
6.72150E+02	1.41200E-02	2.82930E-01	3.99480E-03	2.53620E-02
6.72200E+02	1.48700E-02	2.83080E-01	4.20950E-03	2.67240E-02
6.72250E+02	1.56800E-02	2.83230E-01	4.44120E-03	2.81960E-02
6.72300E+02	1.65550E-02	2.83390E-01	4.69160E-03	2.97850E-02
6.72350E+02	1.75010E-02	2.83540E-01	4.96210E-03	3.15030E-02
6.72400E+02	1.85200E-02	2.83690E-01	5.25410E-03	3.33560E-02
6.72450E+02	1.96190E-02	2.83840E-01	5.56870E-03	3.53540E-02
6.72500E+02	2.08000E-02	2.84000E-01	5.90700E-03	3.75010E-02
6.72550E+02	2.20650E-02	2.84150E-01	6.26970E-03	3.98040E-02
6.72600E+02	2.34160E-02	2.84300E-01	6.65710E-03	4.22640E-02
6.72650E+02	2.48530E-02	2.84450E-01	7.06950E-03	4.48820E-02
6.72700E+02	2.63750E-02	2.84600E-01	7.50640E-03	4.76550E-02
6.72750E+02	2.79790E-02	2.84760E-01	7.96730E-03	5.05820E-02
6.72800E+02	2.96630E-02	2.84910E-01	8.45130E-03	5.36540E-02
6.72850E+02	3.14230E-02	2.85060E-01	8.95740E-03	5.68670E-02
6.72900E+02	3.32550E-02	2.85210E-01	9.48460E-03	6.02140E-02
6.72950E+02	3.51560E-02	2.85360E-01	1.00320E-02	6.36900E-02
6.73000E+02	3.71240E-02	2.85510E-01	1.05990E-02	6.72900E-02
6.73050E+02	3.91570E-02	2.85660E-01	1.11860E-02	7.10130E-02
6.73100E+02	4.12580E-02	2.85810E-01	1.17920E-02	7.48630E-02
6.73150E+02	4.34310E-02	2.85960E-01	1.24190E-02	7.88460E-02
6.73200E+02	4.56820E-02	2.86110E-01	1.30700E-02	8.29760E-02
6.73250E+02	4.80220E-02	2.86240E-01	1.37460E-02	8.72690E-02
6.73300E+02	5.04640E-02	2.86380E-01	1.44520E-02	9.17510E-02
6.73350E+02	5.30240E-02	2.86520E-01	1.51920E-02	9.64520E-02
6.73400E+02	5.57200E-02	2.86660E-01	1.59730E-02	1.01400E-01
6.73450E+02	5.85700E-02	2.86800E-01	1.67980E-02	1.06640E-01
6.73500E+02	6.15910E-02	2.86930E-01	1.76720E-02	1.12200E-01
6.73550E+02	6.48000E-02	2.87070E-01	1.86020E-02	1.18100E-01
6.73600E+02	6.82080E-02	2.87210E-01	1.95900E-02	1.24370E-01
6.73650E+02	7.09750E-02	2.87340E-01	2.03940E-02	1.29480E-01
6.73700E+02	7.40140E-02	2.87480E-01	2.12780E-02	1.35080E-01
6.73750E+02	7.67740E-02	2.87620E-01	2.20820E-02	1.40190E-01
6.73800E+02	7.92550E-02	2.87760E-01	2.28060E-02	1.44790E-01

6.73850E+02	8.15190E-02	2.87890E-01	2.34690E-02	1.48990E-01
6.73900E+02	8.36870E-02	2.88030E-01	2.41040E-02	1.53030E-01
6.73950E+02	8.59320E-02	2.88170E-01	2.47630E-02	1.57210E-01
6.74000E+02	8.84640E-02	2.88300E-01	2.55040E-02	1.61920E-01
6.74050E+02	9.15050E-02	2.88460E-01	2.63960E-02	1.67580E-01
6.74100E+02	9.52610E-02	2.88620E-01	2.74940E-02	1.74550E-01
6.74150E+02	9.98970E-02	2.88780E-01	2.88480E-02	1.83150E-01
6.74200E+02	1.05510E-01	2.88940E-01	3.04870E-02	1.93550E-01
6.74250E+02	1.12130E-01	2.89100E-01	3.24150E-02	2.05790E-01
6.74300E+02	1.19660E-01	2.89250E-01	3.46140E-02	2.19750E-01
6.74350E+02	1.27980E-01	2.89410E-01	3.70390E-02	2.35150E-01
6.74400E+02	1.36850E-01	2.89570E-01	3.96280E-02	2.51580E-01
6.74450E+02	1.46010E-01	2.89730E-01	4.23040E-02	2.68570E-01
6.74500E+02	1.55190E-01	2.89890E-01	4.49880E-02	2.85610E-01
6.74550E+02	1.64120E-01	2.90040E-01	4.76040E-02	3.02220E-01
6.74600E+02	1.72600E-01	2.90200E-01	5.00900E-02	3.18010E-01
6.74650E+02	1.80480E-01	2.90360E-01	5.24050E-02	3.32700E-01
6.74700E+02	1.87690E-01	2.90520E-01	5.45280E-02	3.46180E-01
6.74750E+02	1.94260E-01	2.90680E-01	5.64660E-02	3.58480E-01
6.74800E+02	2.00270E-01	2.90840E-01	5.82450E-02	3.69780E-01
6.74850E+02	2.05880E-01	2.90990E-01	5.99100E-02	3.80350E-01
6.74900E+02	2.11280E-01	2.91150E-01	6.15150E-02	3.90540E-01
6.74950E+02	2.16660E-01	2.91310E-01	6.31160E-02	4.00700E-01
6.75000E+02	2.22200E-01	2.91470E-01	6.47630E-02	4.11160E-01
6.75050E+02	2.28020E-01	2.91620E-01	6.64960E-02	4.22160E-01
6.75100E+02	2.34210E-01	2.91780E-01	6.83380E-02	4.33850E-01
6.75150E+02	2.40780E-01	2.91920E-01	7.02890E-02	4.46240E-01
6.75200E+02	2.47690E-01	2.92030E-01	7.23350E-02	4.59230E-01
6.75250E+02	2.54860E-01	2.92150E-01	7.44570E-02	4.72700E-01
6.75300E+02	2.62150E-01	2.92270E-01	7.66190E-02	4.86430E-01
6.75350E+02	2.69450E-01	2.92380E-01	7.87840E-02	5.00170E-01
6.75400E+02	2.76650E-01	2.92500E-01	8.09200E-02	5.13730E-01
6.75450E+02	2.83640E-01	2.92620E-01	8.29980E-02	5.26930E-01
6.75500E+02	2.90380E-01	2.92730E-01	8.50050E-02	5.39670E-01
6.75550E+02	2.96860E-01	2.92850E-01	8.69350E-02	5.51920E-01
6.75600E+02	3.03090E-01	2.92970E-01	8.87960E-02	5.63730E-01
6.75650E+02	3.09120E-01	2.93080E-01	9.05990E-02	5.75180E-01
6.75700E+02	3.15010E-01	2.93200E-01	9.23620E-02	5.86370E-01
6.75750E+02	3.20800E-01	2.93320E-01	9.40970E-02	5.97390E-01
6.75800E+02	3.26520E-01	2.93430E-01	9.58120E-02	6.08280E-01
6.75850E+02	3.32160E-01	2.93550E-01	9.75060E-02	6.19030E-01
6.75900E+02	3.37680E-01	2.93660E-01	9.91650E-02	6.29560E-01
6.75950E+02	3.42990E-01	2.93780E-01	1.00760E-01	6.39720E-01

6.76000E+02	3.47990E-01	2.93900E-01	1.02270E-01	6.49300E-01
6.76050E+02	3.52560E-01	2.93990E-01	1.03650E-01	6.58040E-01
6.76100E+02	3.56580E-01	2.94080E-01	1.04870E-01	6.65750E-01
6.76150E+02	3.59960E-01	2.94180E-01	1.05890E-01	6.72270E-01
6.76200E+02	3.62620E-01	2.94270E-01	1.06710E-01	6.77460E-01
6.76250E+02	3.64550E-01	2.94370E-01	1.07310E-01	6.81300E-01
6.76300E+02	3.65790E-01	2.94460E-01	1.07710E-01	6.83820E-01
6.76350E+02	3.66390E-01	2.94560E-01	1.07920E-01	6.85170E-01
6.76400E+02	3.66480E-01	2.94650E-01	1.07980E-01	6.85550E-01
6.76450E+02	3.66160E-01	2.94750E-01	1.07930E-01	6.85180E-01
6.76500E+02	3.65590E-01	2.94840E-01	1.07790E-01	6.84330E-01
6.76550E+02	3.64880E-01	2.94930E-01	1.07610E-01	6.83210E-01
6.76600E+02	3.64120E-01	2.95030E-01	1.07430E-01	6.82010E-01
6.76650E+02	3.63380E-01	2.95120E-01	1.07240E-01	6.80840E-01
6.76700E+02	3.62700E-01	2.95220E-01	1.07070E-01	6.79770E-01
6.76750E+02	3.62060E-01	2.95310E-01	1.06920E-01	6.78790E-01
6.76800E+02	3.61440E-01	2.95400E-01	1.06770E-01	6.77850E-01
6.76850E+02	3.60810E-01	2.95490E-01	1.06620E-01	6.76880E-01
6.76900E+02	3.60130E-01	2.95590E-01	1.06450E-01	6.75810E-01
6.76950E+02	3.59380E-01	2.95680E-01	1.06260E-01	6.74610E-01
6.77000E+02	3.58550E-01	2.95770E-01	1.06050E-01	6.73260E-01
6.77050E+02	3.57660E-01	2.95860E-01	1.05820E-01	6.71810E-01
6.77100E+02	3.56770E-01	2.95940E-01	1.05580E-01	6.70290E-01
6.77150E+02	3.55920E-01	2.96000E-01	1.05350E-01	6.68850E-01
6.77200E+02	3.55180E-01	2.96070E-01	1.05160E-01	6.67610E-01
6.77250E+02	3.54600E-01	2.96140E-01	1.05010E-01	6.66660E-01
6.77300E+02	3.54190E-01	2.96200E-01	1.04910E-01	6.66040E-01
6.77350E+02	3.53950E-01	2.96270E-01	1.04860E-01	6.65740E-01
6.77400E+02	3.53830E-01	2.96330E-01	1.04850E-01	6.65670E-01
6.77450E+02	3.53760E-01	2.96400E-01	1.04850E-01	6.65690E-01
6.77500E+02	3.53630E-01	2.96470E-01	1.04840E-01	6.65590E-01
6.77550E+02	3.53320E-01	2.96530E-01	1.04770E-01	6.65140E-01
6.77600E+02	3.52710E-01	2.96590E-01	1.04610E-01	6.64140E-01
6.77650E+02	3.51720E-01	2.96660E-01	1.04340E-01	6.62430E-01
6.77700E+02	3.50300E-01	2.96720E-01	1.03940E-01	6.59890E-01
6.77750E+02	3.48440E-01	2.96790E-01	1.03410E-01	6.56540E-01
6.77800E+02	3.46210E-01	2.96850E-01	1.02770E-01	6.52470E-01
6.77850E+02	3.43710E-01	2.96910E-01	1.02050E-01	6.47890E-01
6.77900E+02	3.41080E-01	2.96980E-01	1.01290E-01	6.43060E-01
6.77950E+02	3.38490E-01	2.97040E-01	1.00540E-01	6.38320E-01
6.78000E+02	3.36110E-01	2.97100E-01	9.98580E-02	6.33970E-01
6.78050E+02	3.34090E-01	2.97180E-01	9.92860E-02	6.30330E-01
6.78100E+02	3.32540E-01	2.97260E-01	9.88510E-02	6.27570E-01

6.78150E+02	3.31510E-01	2.97340E-01	9.85710E-02	6.25790E-01
6.78200E+02	3.30980E-01	2.97430E-01	9.84420E-02	6.24980E-01
6.78250E+02	3.30900E-01	2.97510E-01	9.84440E-02	6.24980E-01
6.78300E+02	3.31130E-01	2.97590E-01	9.85410E-02	6.25600E-01
6.78350E+02	3.31540E-01	2.97670E-01	9.86890E-02	6.26540E-01
6.78400E+02	3.31960E-01	2.97750E-01	9.88410E-02	6.27510E-01
6.78450E+02	3.32250E-01	2.97830E-01	9.89530E-02	6.28220E-01
6.78500E+02	3.32300E-01	2.97910E-01	9.89940E-02	6.28480E-01
6.78550E+02	3.32040E-01	2.97990E-01	9.89440E-02	6.28160E-01
6.78600E+02	3.31480E-01	2.98070E-01	9.88030E-02	6.27270E-01
6.78650E+02	3.30670E-01	2.98150E-01	9.85890E-02	6.25910E-01
6.78700E+02	3.29720E-01	2.98230E-01	9.83320E-02	6.24280E-01
6.78750E+02	3.28770E-01	2.98310E-01	9.80740E-02	6.22640E-01
6.78800E+02	3.27960E-01	2.98380E-01	9.78580E-02	6.21260E-01
6.78850E+02	3.27430E-01	2.98460E-01	9.77250E-02	6.20420E-01
6.78900E+02	3.27280E-01	2.98540E-01	9.77060E-02	6.20300E-01
6.78950E+02	3.27570E-01	2.98620E-01	9.78210E-02	6.21030E-01
6.79000E+02	3.28330E-01	2.98700E-01	9.80740E-02	6.22640E-01
6.79050E+02	3.29510E-01	2.98790E-01	9.84530E-02	6.25040E-01
6.79100E+02	3.31030E-01	2.98870E-01	9.89350E-02	6.28100E-01
6.79150E+02	3.32790E-01	2.98950E-01	9.94880E-02	6.31620E-01
6.79200E+02	3.34680E-01	2.99040E-01	1.00080E-01	6.35390E-01
6.79250E+02	3.36620E-01	2.99120E-01	1.00690E-01	6.39250E-01
6.79300E+02	3.38550E-01	2.99210E-01	1.01300E-01	6.43090E-01
6.79350E+02	3.40440E-01	2.99290E-01	1.01890E-01	6.46870E-01
6.79400E+02	3.42330E-01	2.99380E-01	1.02490E-01	6.50650E-01
6.79450E+02	3.44280E-01	2.99460E-01	1.03100E-01	6.54540E-01
6.79500E+02	3.46380E-01	2.99540E-01	1.03760E-01	6.58710E-01
6.79550E+02	3.48710E-01	2.99630E-01	1.04480E-01	6.63330E-01
6.79600E+02	3.51350E-01	2.99710E-01	1.05300E-01	6.68530E-01
6.79650E+02	3.54330E-01	2.99800E-01	1.06230E-01	6.74390E-01
6.79700E+02	3.57640E-01	2.99880E-01	1.07250E-01	6.80890E-01
6.79750E+02	3.61210E-01	2.99960E-01	1.08350E-01	6.87880E-01
6.79800E+02	3.64920E-01	3.00050E-01	1.09490E-01	6.95140E-01
6.79850E+02	3.68600E-01	3.00130E-01	1.10630E-01	7.02340E-01
6.79900E+02	3.72070E-01	3.00210E-01	1.11700E-01	7.09160E-01
6.79950E+02	3.75160E-01	3.00300E-01	1.12660E-01	7.15250E-01
6.80000E+02	3.77750E-01	3.00380E-01	1.13470E-01	7.20370E-01
6.80050E+02	3.79740E-01	3.00470E-01	1.14100E-01	7.24390E-01
6.80100E+02	3.81170E-01	3.00560E-01	1.14560E-01	7.27330E-01
6.80150E+02	3.82130E-01	3.00640E-01	1.14890E-01	7.29370E-01
6.80200E+02	3.82810E-01	3.00730E-01	1.15120E-01	7.30860E-01
6.80250E+02	3.83440E-01	3.00820E-01	1.15350E-01	7.32290E-01

6.80300E+02	3.84320E-01	3.00900E-01	1.15640E-01	7.34180E-01
6.80350E+02	3.85740E-01	3.00990E-01	1.16100E-01	7.37100E-01
6.80400E+02	3.87930E-01	3.01080E-01	1.16800E-01	7.41500E-01
6.80450E+02	3.91080E-01	3.01160E-01	1.17780E-01	7.47730E-01
6.80500E+02	3.95240E-01	3.01250E-01	1.19070E-01	7.55920E-01
6.80550E+02	4.00390E-01	3.01340E-01	1.20650E-01	7.65970E-01
6.80600E+02	4.06340E-01	3.01420E-01	1.22480E-01	7.77590E-01
6.80650E+02	4.12840E-01	3.01510E-01	1.24470E-01	7.90250E-01
6.80700E+02	4.19540E-01	3.01600E-01	1.26530E-01	8.03310E-01
6.80750E+02	4.26070E-01	3.01680E-01	1.28540E-01	8.16040E-01
6.80800E+02	4.32060E-01	3.01770E-01	1.30380E-01	8.27760E-01
6.80850E+02	4.37220E-01	3.01860E-01	1.31980E-01	8.37880E-01
6.80900E+02	4.41330E-01	3.01940E-01	1.33250E-01	8.45990E-01
6.80950E+02	4.44290E-01	3.02030E-01	1.34190E-01	8.51920E-01
6.81000E+02	4.46170E-01	3.02120E-01	1.34800E-01	8.55770E-01
6.81050E+02	4.47140E-01	3.02210E-01	1.35130E-01	8.57880E-01
6.81100E+02	4.47470E-01	3.02300E-01	1.35270E-01	8.58760E-01
6.81150E+02	4.47510E-01	3.02390E-01	1.35320E-01	8.59100E-01
6.81200E+02	4.47640E-01	3.02470E-01	1.35400E-01	8.59610E-01
6.81250E+02	4.48210E-01	3.02560E-01	1.35610E-01	8.60950E-01
6.81300E+02	4.49490E-01	3.02650E-01	1.36040E-01	8.63670E-01
6.81350E+02	4.51660E-01	3.02740E-01	1.36740E-01	8.68090E-01
6.81400E+02	4.54760E-01	3.02830E-01	1.37720E-01	8.74320E-01
6.81450E+02	4.58710E-01	3.02920E-01	1.38950E-01	8.82170E-01
6.81500E+02	4.63310E-01	3.03010E-01	1.40390E-01	8.91270E-01
6.81550E+02	4.68250E-01	3.03100E-01	1.41930E-01	9.01040E-01
6.81600E+02	4.73190E-01	3.03190E-01	1.43470E-01	9.10830E-01
6.81650E+02	4.77790E-01	3.03280E-01	1.44900E-01	9.19940E-01
6.81700E+02	4.81730E-01	3.03370E-01	1.46140E-01	9.27800E-01
6.81750E+02	4.84790E-01	3.03460E-01	1.47110E-01	9.33960E-01
6.81800E+02	4.86850E-01	3.03550E-01	1.47780E-01	9.38210E-01
6.81850E+02	4.87930E-01	3.03640E-01	1.48150E-01	9.40560E-01
6.81900E+02	4.88150E-01	3.03720E-01	1.48260E-01	9.41280E-01
6.81950E+02	4.87770E-01	3.03810E-01	1.48190E-01	9.40810E-01
6.82000E+02	4.87080E-01	3.03900E-01	1.48030E-01	9.39760E-01
6.82050E+02	4.86420E-01	3.04030E-01	1.47890E-01	9.38890E-01
6.82100E+02	4.86120E-01	3.04160E-01	1.47860E-01	9.38690E-01
6.82150E+02	4.86430E-01	3.04290E-01	1.48010E-01	9.39690E-01
6.82200E+02	4.87530E-01	3.04410E-01	1.48410E-01	9.42220E-01
6.82250E+02	4.89500E-01	3.04540E-01	1.49070E-01	9.46410E-01
6.82300E+02	4.92260E-01	3.04670E-01	1.49980E-01	9.52140E-01
6.82350E+02	4.95660E-01	3.04800E-01	1.51080E-01	9.59130E-01
6.82400E+02	4.99460E-01	3.04920E-01	1.52300E-01	9.66880E-01

6.82450E+02	5.03350E-01	3.05050E-01	1.53550E-01	9.74830E-01
6.82500E+02	5.07040E-01	3.05180E-01	1.54740E-01	9.82380E-01
6.82550E+02	5.10240E-01	3.05310E-01	1.55780E-01	9.88980E-01
6.82600E+02	5.12720E-01	3.05430E-01	1.56600E-01	9.94210E-01
6.82650E+02	5.14360E-01	3.05560E-01	1.57170E-01	9.97800E-01
6.82700E+02	5.15120E-01	3.05690E-01	1.57470E-01	9.99690E-01
6.82750E+02	5.15060E-01	3.05820E-01	1.57510E-01	1.00000E+00
6.82800E+02	5.14340E-01	3.05940E-01	1.57360E-01	9.99010E-01
6.82850E+02	5.13150E-01	3.06070E-01	1.57060E-01	9.97130E-01
6.82900E+02	5.11750E-01	3.06190E-01	1.56690E-01	9.94800E-01
6.82950E+02	5.10360E-01	3.06320E-01	1.56330E-01	9.92500E-01
6.83000E+02	5.09170E-01	3.06440E-01	1.56030E-01	9.90590E-01
6.83050E+02	5.08320E-01	3.06570E-01	1.55840E-01	9.89340E-01
6.83100E+02	5.07880E-01	3.06690E-01	1.55760E-01	9.88880E-01
6.83150E+02	5.07800E-01	3.06820E-01	1.55800E-01	9.89140E-01
6.83200E+02	5.08010E-01	3.06940E-01	1.55930E-01	9.89950E-01
6.83250E+02	5.08340E-01	3.07070E-01	1.56090E-01	9.90980E-01
6.83300E+02	5.08590E-01	3.07190E-01	1.56230E-01	9.91880E-01
6.83350E+02	5.08570E-01	3.07320E-01	1.56290E-01	9.92250E-01
6.83400E+02	5.08100E-01	3.07440E-01	1.56210E-01	9.91730E-01
6.83450E+02	5.07040E-01	3.07570E-01	1.55950E-01	9.90070E-01
6.83500E+02	5.05320E-01	3.07690E-01	1.55480E-01	9.87100E-01
6.83550E+02	5.02920E-01	3.07820E-01	1.54810E-01	9.82810E-01
6.83600E+02	4.99900E-01	3.07940E-01	1.53940E-01	9.77310E-01
6.83650E+02	4.96380E-01	3.08060E-01	1.52920E-01	9.70820E-01
6.83700E+02	4.92500E-01	3.08190E-01	1.51780E-01	9.63620E-01
6.83750E+02	4.88440E-01	3.08310E-01	1.50590E-01	9.56050E-01
6.83800E+02	4.84340E-01	3.08440E-01	1.49390E-01	9.48430E-01
6.83850E+02	4.80370E-01	3.08560E-01	1.48220E-01	9.41010E-01
6.83900E+02	4.76590E-01	3.08690E-01	1.47120E-01	9.34000E-01
6.83950E+02	4.73070E-01	3.08810E-01	1.46090E-01	9.27480E-01
6.84000E+02	4.69800E-01	3.08930E-01	1.45140E-01	9.21420E-01
6.84050E+02	4.66710E-01	3.09010E-01	1.44220E-01	9.15590E-01
6.84100E+02	4.63720E-01	3.09090E-01	1.43330E-01	9.09950E-01
6.84150E+02	4.60720E-01	3.09160E-01	1.42440E-01	9.04280E-01
6.84200E+02	4.57590E-01	3.09240E-01	1.41500E-01	8.98360E-01
6.84250E+02	4.54240E-01	3.09310E-01	1.40500E-01	8.91990E-01
6.84300E+02	4.50580E-01	3.09390E-01	1.39400E-01	8.85020E-01
6.84350E+02	4.46580E-01	3.09460E-01	1.38200E-01	8.77380E-01
6.84400E+02	4.42230E-01	3.09540E-01	1.36890E-01	8.69050E-01
6.84450E+02	4.37570E-01	3.09610E-01	1.35480E-01	8.60110E-01
6.84500E+02	4.32660E-01	3.09690E-01	1.33990E-01	8.50660E-01
6.84550E+02	4.27570E-01	3.09760E-01	1.32450E-01	8.40850E-01

6.84600E+02	4.22370E-01	3.09840E-01	1.30870E-01	8.30830E-01
6.84650E+02	4.17130E-01	3.09920E-01	1.29280E-01	8.20720E-01
6.84700E+02	4.11890E-01	3.09990E-01	1.27680E-01	8.10610E-01
6.84750E+02	4.06660E-01	3.10070E-01	1.26090E-01	8.00510E-01
6.84800E+02	4.01420E-01	3.10140E-01	1.24500E-01	7.90390E-01
6.84850E+02	3.96130E-01	3.10210E-01	1.22880E-01	7.80150E-01
6.84900E+02	3.90700E-01	3.10290E-01	1.21230E-01	7.69640E-01
6.84950E+02	3.85070E-01	3.10360E-01	1.19510E-01	7.58720E-01
6.85000E+02	3.79140E-01	3.10430E-01	1.17700E-01	7.47210E-01
6.85050E+02	3.72840E-01	3.10500E-01	1.15770E-01	7.34970E-01
6.85100E+02	3.66120E-01	3.10570E-01	1.13710E-01	7.21890E-01
6.85150E+02	3.58970E-01	3.10650E-01	1.11510E-01	7.07950E-01
6.85200E+02	3.51380E-01	3.10720E-01	1.09180E-01	6.93150E-01
6.85250E+02	3.43410E-01	3.10790E-01	1.06730E-01	6.77580E-01
6.85300E+02	3.35110E-01	3.10860E-01	1.04170E-01	6.61370E-01
6.85350E+02	3.26590E-01	3.10930E-01	1.01550E-01	6.44690E-01
6.85400E+02	3.17930E-01	3.11000E-01	9.88780E-02	6.27740E-01
6.85450E+02	3.09240E-01	3.11080E-01	9.61960E-02	6.10720E-01
6.85500E+02	3.00590E-01	3.11150E-01	9.35280E-02	5.93780E-01
6.85550E+02	2.92070E-01	3.11220E-01	9.08970E-02	5.77070E-01
6.85600E+02	2.83720E-01	3.11290E-01	8.83180E-02	5.60700E-01
6.85650E+02	2.75560E-01	3.11360E-01	8.57980E-02	5.44700E-01
6.85700E+02	2.67610E-01	3.11430E-01	8.33410E-02	5.29100E-01
6.85750E+02	2.59850E-01	3.11500E-01	8.09430E-02	5.13880E-01
6.85800E+02	2.52260E-01	3.11580E-01	7.85970E-02	4.98990E-01
6.85850E+02	2.44820E-01	3.11650E-01	7.62970E-02	4.84390E-01
6.85900E+02	2.37510E-01	3.11720E-01	7.40360E-02	4.70030E-01
6.85950E+02	2.30310E-01	3.11790E-01	7.18090E-02	4.55890E-01
6.86000E+02	2.23230E-01	3.11860E-01	6.96160E-02	4.41970E-01
6.86050E+02	2.16260E-01	3.12030E-01	6.74790E-02	4.28400E-01
6.86100E+02	2.09430E-01	3.12200E-01	6.53820E-02	4.15090E-01
6.86150E+02	2.02760E-01	3.12360E-01	6.33340E-02	4.02090E-01
6.86200E+02	1.96280E-01	3.12530E-01	6.13430E-02	3.89450E-01
6.86250E+02	1.90020E-01	3.12690E-01	5.94180E-02	3.77220E-01
6.86300E+02	1.83990E-01	3.12860E-01	5.75640E-02	3.65450E-01
6.86350E+02	1.78210E-01	3.13030E-01	5.57850E-02	3.54160E-01
6.86400E+02	1.72680E-01	3.13190E-01	5.40820E-02	3.43350E-01
6.86450E+02	1.67390E-01	3.13360E-01	5.24530E-02	3.33010E-01
6.86500E+02	1.62330E-01	3.13530E-01	5.08960E-02	3.23120E-01
6.86550E+02	1.57490E-01	3.13690E-01	4.94050E-02	3.13650E-01
6.86600E+02	1.52860E-01	3.13860E-01	4.79770E-02	3.04590E-01
6.86650E+02	1.48420E-01	3.14030E-01	4.66080E-02	2.95900E-01
6.86700E+02	1.44180E-01	3.14190E-01	4.52990E-02	2.87590E-01

6.86750E+02	1.40130E-01	3.14360E-01	4.40500E-02	2.79660E-01
6.86800E+02	1.36280E-01	3.14530E-01	4.28630E-02	2.72120E-01
6.86850E+02	1.32640E-01	3.14700E-01	4.17420E-02	2.65000E-01
6.86900E+02	1.29220E-01	3.14870E-01	4.06870E-02	2.58310E-01
6.86950E+02	1.26010E-01	3.15030E-01	3.96980E-02	2.52030E-01
6.87000E+02	1.22990E-01	3.15200E-01	3.87680E-02	2.46130E-01
6.87050E+02	1.20130E-01	3.15370E-01	3.78870E-02	2.40530E-01
6.87100E+02	1.17380E-01	3.15540E-01	3.70360E-02	2.35130E-01
6.87150E+02	1.14640E-01	3.15710E-01	3.61940E-02	2.29780E-01
6.87200E+02	1.11860E-01	3.15870E-01	3.53330E-02	2.24320E-01
6.87250E+02	1.08930E-01	3.16040E-01	3.44250E-02	2.18550E-01
6.87300E+02	1.05760E-01	3.16210E-01	3.34430E-02	2.12320E-01
6.87350E+02	1.02300E-01	3.16380E-01	3.23640E-02	2.05470E-01
6.87400E+02	9.84770E-02	3.16540E-01	3.11720E-02	1.97900E-01
6.87450E+02	9.52870E-02	3.16710E-01	3.01780E-02	1.91590E-01
6.87500E+02	8.97450E-02	3.16880E-01	2.84380E-02	1.80540E-01
6.87550E+02	8.49060E-02	3.17040E-01	2.69190E-02	1.70900E-01
6.87600E+02	7.98600E-02	3.17210E-01	2.53330E-02	1.60830E-01
6.87650E+02	7.67260E-02	3.17380E-01	2.43510E-02	1.54600E-01
6.87700E+02	7.34880E-02	3.17550E-01	2.33360E-02	1.48150E-01
6.87750E+02	7.04300E-02	3.17710E-01	2.23770E-02	1.42060E-01
6.87800E+02	6.86280E-02	3.17880E-01	2.18160E-02	1.38500E-01
6.87850E+02	6.57770E-02	3.18050E-01	2.09200E-02	1.32820E-01
6.87900E+02	6.29740E-02	3.18220E-01	2.00390E-02	1.27220E-01
6.87950E+02	6.02200E-02	3.18380E-01	1.91730E-02	1.21720E-01
6.88000E+02	5.75200E-02	3.18550E-01	1.83230E-02	1.16330E-01
6.88050E+02	5.48820E-02	3.18760E-01	1.74940E-02	1.11060E-01
6.88100E+02	5.23160E-02	3.18970E-01	1.66870E-02	1.05940E-01
6.88150E+02	4.98320E-02	3.19170E-01	1.59050E-02	1.00980E-01
6.88200E+02	4.74440E-02	3.19380E-01	1.51530E-02	9.61990E-02
6.88250E+02	4.51610E-02	3.19590E-01	1.44330E-02	9.16290E-02
6.88300E+02	4.29920E-02	3.19790E-01	1.37480E-02	8.72840E-02
6.88350E+02	4.09430E-02	3.20000E-01	1.31020E-02	8.31780E-02
6.88400E+02	3.90150E-02	3.20210E-01	1.24930E-02	7.93140E-02
6.88450E+02	3.72090E-02	3.20420E-01	1.19220E-02	7.56910E-02
6.88500E+02	3.55180E-02	3.20620E-01	1.13880E-02	7.22980E-02
6.88550E+02	3.39350E-02	3.20830E-01	1.08870E-02	6.91210E-02
6.88600E+02	3.24490E-02	3.21040E-01	1.04170E-02	6.61370E-02
6.88650E+02	3.10480E-02	3.21240E-01	9.97380E-03	6.33200E-02
6.88700E+02	2.97170E-02	3.21440E-01	9.55230E-03	6.06440E-02
6.88750E+02	2.84440E-02	3.21640E-01	9.14880E-03	5.80830E-02
6.88800E+02	2.72170E-02	3.21840E-01	8.75950E-03	5.56110E-02
6.88850E+02	2.60240E-02	3.22040E-01	8.38090E-03	5.32080E-02

6.88900E+02	2.48590E-02	3.22240E-01	8.01050E-03	5.08560E-02
6.88950E+02	2.37140E-02	3.22440E-01	7.64660E-03	4.85450E-02
6.89000E+02	2.25890E-02	3.22650E-01	7.28820E-03	4.62700E-02
6.89050E+02	2.14820E-02	3.22840E-01	6.93530E-03	4.40290E-02
6.89100E+02	2.03940E-02	3.23040E-01	6.58830E-03	4.18270E-02
6.89150E+02	1.93300E-02	3.23240E-01	6.24830E-03	3.96680E-02
6.89200E+02	1.82930E-02	3.23440E-01	5.91690E-03	3.75640E-02
6.89250E+02	1.72900E-02	3.23640E-01	5.59570E-03	3.55250E-02
6.89300E+02	1.63250E-02	3.23840E-01	5.28670E-03	3.35640E-02
6.89350E+02	1.54050E-02	3.24040E-01	4.99190E-03	3.16920E-02
6.89400E+02	1.45350E-02	3.24240E-01	4.71280E-03	2.99200E-02
6.89450E+02	1.37170E-02	3.24440E-01	4.45040E-03	2.82540E-02
6.89500E+02	1.29550E-02	3.24640E-01	4.20560E-03	2.67000E-02
6.89550E+02	1.22480E-02	3.24840E-01	3.97870E-03	2.52600E-02
6.89600E+02	1.15980E-02	3.25040E-01	3.76970E-03	2.39320E-02
6.89650E+02	1.10020E-02	3.25240E-01	3.57810E-03	2.27160E-02
6.89700E+02	1.04570E-02	3.25430E-01	3.40320E-03	2.16060E-02
6.89750E+02	9.96230E-03	3.25630E-01	3.24410E-03	2.05950E-02
6.89800E+02	9.51200E-03	3.25830E-01	3.09930E-03	1.96760E-02
6.89850E+02	9.10210E-03	3.26030E-01	2.96750E-03	1.88400E-02
6.89900E+02	8.72800E-03	3.26230E-01	2.84730E-03	1.80770E-02
6.89950E+02	8.38570E-03	3.26430E-01	2.73730E-03	1.73780E-02
6.90000E+02	8.07130E-03	3.26620E-01	2.63630E-03	1.67370E-02
6.90050E+02	7.78200E-03	3.26670E-01	2.54210E-03	1.61390E-02
6.90100E+02	7.51560E-03	3.26720E-01	2.45550E-03	1.55890E-02
6.90150E+02	7.27100E-03	3.26770E-01	2.37600E-03	1.50840E-02
6.90200E+02	7.04790E-03	3.26820E-01	2.30340E-03	1.46230E-02
6.90250E+02	6.84660E-03	3.26870E-01	2.23790E-03	1.42080E-02
6.90300E+02	6.66780E-03	3.26920E-01	2.17980E-03	1.38390E-02
6.90350E+02	6.51260E-03	3.26970E-01	2.12940E-03	1.35190E-02
6.90400E+02	6.38240E-03	3.27020E-01	2.08720E-03	1.32510E-02
6.90450E+02	6.27850E-03	3.27070E-01	2.05350E-03	1.30370E-02
6.90500E+02	6.20130E-03	3.27120E-01	2.02850E-03	1.28780E-02
6.90550E+02	6.15010E-03	3.27160E-01	2.01210E-03	1.27740E-02
6.90600E+02	6.12300E-03	3.27210E-01	2.00350E-03	1.27200E-02
6.90650E+02	6.11640E-03	3.27260E-01	2.00170E-03	1.27080E-02
6.90700E+02	6.12560E-03	3.27310E-01	2.00500E-03	1.27290E-02
6.90750E+02	6.14440E-03	3.27360E-01	2.01140E-03	1.27700E-02
6.90800E+02	6.16550E-03	3.27400E-01	2.01860E-03	1.28150E-02
6.90850E+02	6.18030E-03	3.27450E-01	2.02370E-03	1.28480E-02
6.90900E+02	6.18000E-03	3.27500E-01	2.02390E-03	1.28490E-02
6.90950E+02	6.15570E-03	3.27550E-01	2.01630E-03	1.28010E-02
6.91000E+02	6.09930E-03	3.27590E-01	1.99810E-03	1.26850E-02

6.91050E+02	6.00400E-03	3.27640E-01	1.96710E-03	1.24890E-02
6.91100E+02	5.86430E-03	3.27680E-01	1.92160E-03	1.22000E-02
6.91150E+02	5.67710E-03	3.27730E-01	1.86050E-03	1.18120E-02
6.91200E+02	5.44200E-03	3.27780E-01	1.78380E-03	1.13240E-02
6.91250E+02	5.17830E-03	3.27820E-01	1.69760E-03	1.07770E-02
6.91300E+02	4.91200E-03	3.27870E-01	1.61050E-03	1.02240E-02
6.91350E+02	4.64410E-03	3.27910E-01	1.52280E-03	9.66800E-03
6.91400E+02	4.37580E-03	3.27960E-01	1.43510E-03	9.11080E-03
6.91450E+02	4.10910E-03	3.28000E-01	1.34780E-03	8.55660E-03
6.91500E+02	3.84520E-03	3.28050E-01	1.26140E-03	8.00820E-03
6.91550E+02	3.68460E-03	3.28090E-01	1.20890E-03	7.67470E-03
6.91600E+02	3.58590E-03	3.28140E-01	1.17670E-03	7.47020E-03
6.91650E+02	3.31590E-03	3.28180E-01	1.08820E-03	6.90860E-03
6.91700E+02	3.10850E-03	3.28230E-01	1.02030E-03	6.47750E-03
6.91750E+02	2.98860E-03	3.28270E-01	9.81050E-04	6.22840E-03
6.91800E+02	2.68540E-03	3.28320E-01	8.81660E-04	5.59730E-03
6.91850E+02	1.93240E-03	3.28360E-01	6.34520E-04	4.02840E-03
6.91900E+02	1.16670E-03	3.28410E-01	3.83160E-04	2.43260E-03
6.91950E+02	4.32830E-04	3.28450E-01	1.42160E-04	9.02550E-04
6.92000E+02	2.73520E-04	3.28500E-01	8.98500E-05	5.70420E-04
6.92050E+02	0.00000E+00	3.28560E-01	0.00000E+00	0.00000E+00

Channel 3

Wavenumber	HIRS Filter Transmittance	Optical Element Transmittance	Product of the HIRS Filter and Optical Element Transmittances	Normalized Value of Column 4
6.70000E+02	0	0.27653	0	0.00000E+00
6.70050E+02	6.49800E-04	2.76680E-01	1.79780E-04	6.85690E-04
6.70100E+02	7.63050E-04	2.76820E-01	2.11230E-04	8.05620E-04
6.70150E+02	9.08350E-04	2.76970E-01	2.51580E-04	9.59530E-04
6.70200E+02	9.38990E-04	2.77110E-01	2.60210E-04	9.92420E-04
6.70250E+02	8.17570E-04	2.77260E-01	2.26680E-04	8.64540E-04
6.70300E+02	7.12150E-04	2.77400E-01	1.97550E-04	7.53460E-04
6.70350E+02	6.24200E-04	2.77550E-01	1.73250E-04	6.60760E-04
6.70400E+02	5.54750E-04	2.77700E-01	1.54050E-04	5.87550E-04
6.70450E+02	5.04380E-04	2.77840E-01	1.40140E-04	5.34480E-04
6.70500E+02	4.73260E-04	2.77990E-01	1.31560E-04	5.01770E-04
6.70550E+02	4.61150E-04	2.78130E-01	1.28260E-04	4.89180E-04
6.70600E+02	4.67460E-04	2.78280E-01	1.30080E-04	4.96130E-04
6.70650E+02	4.91250E-04	2.78420E-01	1.36780E-04	5.21660E-04
6.70700E+02	5.31330E-04	2.78570E-01	1.48010E-04	5.64510E-04
6.70750E+02	5.86250E-04	2.78710E-01	1.63400E-04	6.23190E-04
6.70800E+02	6.54420E-04	2.78860E-01	1.82490E-04	6.96020E-04

6.70850E+02	7.34110E-04	2.79000E-01	2.04820E-04	7.81170E-04
6.70900E+02	8.23490E-04	2.79150E-01	2.29880E-04	8.76740E-04
6.70950E+02	9.20520E-04	2.79290E-01	2.57090E-04	9.80550E-04
6.71000E+02	1.02230E-03	2.79440E-01	2.85660E-04	1.08950E-03
6.71050E+02	1.12740E-03	2.79580E-01	3.15200E-04	1.20220E-03
6.71100E+02	1.23610E-03	2.79720E-01	3.45760E-04	1.31870E-03
6.71150E+02	1.34760E-03	2.79870E-01	3.77140E-04	1.43840E-03
6.71200E+02	1.46050E-03	2.80010E-01	4.08950E-04	1.55970E-03
6.71250E+02	1.57370E-03	2.80150E-01	4.40870E-04	1.68150E-03
6.71300E+02	1.68630E-03	2.80300E-01	4.72670E-04	1.80270E-03
6.71350E+02	1.79780E-03	2.80460E-01	5.04200E-04	1.92300E-03
6.71400E+02	1.90780E-03	2.80610E-01	5.35360E-04	2.04180E-03
6.71450E+02	2.01630E-03	2.80770E-01	5.66120E-04	2.15920E-03
6.71500E+02	2.12340E-03	2.80920E-01	5.96490E-04	2.27500E-03
6.71550E+02	2.22900E-03	2.81070E-01	6.26520E-04	2.38950E-03
6.71600E+02	2.33360E-03	2.81230E-01	6.56280E-04	2.50300E-03
6.71650E+02	2.43740E-03	2.81380E-01	6.85850E-04	2.61580E-03
6.71700E+02	2.54080E-03	2.81540E-01	7.15330E-04	2.72820E-03
6.71750E+02	2.64400E-03	2.81690E-01	7.44790E-04	2.84060E-03
6.71800E+02	2.74730E-03	2.81850E-01	7.74320E-04	2.95320E-03
6.71850E+02	2.85090E-03	2.82000E-01	8.03960E-04	3.06630E-03
6.71900E+02	2.95480E-03	2.82160E-01	8.33730E-04	3.17980E-03
6.71950E+02	3.05910E-03	2.82310E-01	8.63620E-04	3.29380E-03
6.72000E+02	3.16350E-03	2.82470E-01	8.93590E-04	3.40810E-03
6.72050E+02	3.26780E-03	2.82620E-01	9.23550E-04	3.52240E-03
6.72100E+02	3.37160E-03	2.82770E-01	9.53390E-04	3.63620E-03
6.72150E+02	3.47430E-03	2.82930E-01	9.82970E-04	3.74900E-03
6.72200E+02	3.57530E-03	2.83080E-01	1.01210E-03	3.86010E-03
6.72250E+02	3.67400E-03	2.83230E-01	1.04060E-03	3.96880E-03
6.72300E+02	3.76970E-03	2.83390E-01	1.06830E-03	4.07440E-03
6.72350E+02	3.86160E-03	2.83540E-01	1.09490E-03	4.17600E-03
6.72400E+02	3.94910E-03	2.83690E-01	1.12030E-03	4.27290E-03
6.72450E+02	4.03160E-03	2.83840E-01	1.14440E-03	4.36450E-03
6.72500E+02	4.10870E-03	2.84000E-01	1.16680E-03	4.45030E-03
6.72550E+02	4.17980E-03	2.84150E-01	1.18770E-03	4.52980E-03
6.72600E+02	4.24490E-03	2.84300E-01	1.20680E-03	4.60290E-03
6.72650E+02	4.30410E-03	2.84450E-01	1.22430E-03	4.66940E-03
6.72700E+02	4.35740E-03	2.84600E-01	1.24010E-03	4.72980E-03
6.72750E+02	4.40540E-03	2.84760E-01	1.25450E-03	4.78450E-03
6.72800E+02	4.44870E-03	2.84910E-01	1.26750E-03	4.83410E-03
6.72850E+02	4.48830E-03	2.85060E-01	1.27940E-03	4.87960E-03
6.72900E+02	4.52520E-03	2.85210E-01	1.29060E-03	4.92240E-03
6.72950E+02	4.56070E-03	2.85360E-01	1.30140E-03	4.96370E-03

6.73000E+02	4.59640E-03	2.85510E-01	1.31230E-03	5.00510E-03
6.73050E+02	4.63360E-03	2.85660E-01	1.32360E-03	5.04830E-03
6.73100E+02	4.67420E-03	2.85810E-01	1.33590E-03	5.09510E-03
6.73150E+02	4.71960E-03	2.85960E-01	1.34960E-03	5.14740E-03
6.73200E+02	4.77160E-03	2.86110E-01	1.36520E-03	5.20680E-03
6.73250E+02	4.83180E-03	2.86240E-01	1.38310E-03	5.27510E-03
6.73300E+02	4.90160E-03	2.86380E-01	1.40370E-03	5.35380E-03
6.73350E+02	4.98220E-03	2.86520E-01	1.42750E-03	5.44440E-03
6.73400E+02	5.07470E-03	2.86660E-01	1.45470E-03	5.54820E-03
6.73450E+02	5.18000E-03	2.86800E-01	1.48560E-03	5.66600E-03
6.73500E+02	5.29850E-03	2.86930E-01	1.52030E-03	5.79850E-03
6.73550E+02	5.43060E-03	2.87070E-01	1.55900E-03	5.94580E-03
6.73600E+02	5.57610E-03	2.87210E-01	1.60150E-03	6.10800E-03
6.73650E+02	5.73460E-03	2.87340E-01	1.64780E-03	6.28470E-03
6.73700E+02	5.90540E-03	2.87480E-01	1.69770E-03	6.47500E-03
6.73750E+02	6.08760E-03	2.87620E-01	1.75090E-03	6.67790E-03
6.73800E+02	6.27980E-03	2.87760E-01	1.80700E-03	6.89200E-03
6.73850E+02	6.48060E-03	2.87890E-01	1.86570E-03	7.11580E-03
6.73900E+02	6.68820E-03	2.88030E-01	1.92640E-03	7.34730E-03
6.73950E+02	6.90100E-03	2.88170E-01	1.98860E-03	7.58460E-03
6.74000E+02	7.11690E-03	2.88300E-01	2.05180E-03	7.82560E-03
6.74050E+02	7.33410E-03	2.88460E-01	2.11560E-03	8.06890E-03
6.74100E+02	7.55070E-03	2.88620E-01	2.17930E-03	8.31170E-03
6.74150E+02	7.76490E-03	2.88780E-01	2.24230E-03	8.55220E-03
6.74200E+02	7.97510E-03	2.88940E-01	2.30430E-03	8.78860E-03
6.74250E+02	8.18000E-03	2.89100E-01	2.36480E-03	9.01920E-03
6.74300E+02	8.37830E-03	2.89250E-01	2.42340E-03	9.24300E-03
6.74350E+02	8.56930E-03	2.89410E-01	2.48010E-03	9.45890E-03
6.74400E+02	8.75250E-03	2.89570E-01	2.53450E-03	9.66630E-03
6.74450E+02	8.92770E-03	2.89730E-01	2.58660E-03	9.86530E-03
6.74500E+02	9.09520E-03	2.89890E-01	2.63660E-03	1.00560E-02
6.74550E+02	9.25560E-03	2.90040E-01	2.68450E-03	1.02390E-02
6.74600E+02	9.40990E-03	2.90200E-01	2.73080E-03	1.04150E-02
6.74650E+02	9.55930E-03	2.90360E-01	2.77570E-03	1.05860E-02
6.74700E+02	9.70550E-03	2.90520E-01	2.81960E-03	1.07540E-02
6.74750E+02	9.85010E-03	2.90680E-01	2.86320E-03	1.09200E-02
6.74800E+02	9.99540E-03	2.90840E-01	2.90700E-03	1.10870E-02
6.74850E+02	1.01430E-02	2.90990E-01	2.95170E-03	1.12580E-02
6.74900E+02	1.02960E-02	2.91150E-01	2.99780E-03	1.14330E-02
6.74950E+02	1.04560E-02	2.91310E-01	3.04600E-03	1.16180E-02
6.75000E+02	1.06260E-02	2.91470E-01	3.09710E-03	1.18120E-02
6.75050E+02	1.08070E-02	2.91620E-01	3.15150E-03	1.20200E-02
6.75100E+02	1.10010E-02	2.91780E-01	3.20990E-03	1.22420E-02

6.75150E+02	1.12100E-02	2.91920E-01	3.27250E-03	1.24810E-02
6.75200E+02	1.14360E-02	2.92030E-01	3.33960E-03	1.27370E-02
6.75250E+02	1.16790E-02	2.92150E-01	3.41190E-03	1.30130E-02
6.75300E+02	1.19390E-02	2.92270E-01	3.48950E-03	1.33090E-02
6.75350E+02	1.22180E-02	2.92380E-01	3.57240E-03	1.36250E-02
6.75400E+02	1.25160E-02	2.92500E-01	3.66080E-03	1.39620E-02
6.75450E+02	1.28300E-02	2.92620E-01	3.75440E-03	1.43190E-02
6.75500E+02	1.31620E-02	2.92730E-01	3.85310E-03	1.46960E-02
6.75550E+02	1.35100E-02	2.92850E-01	3.95650E-03	1.50900E-02
6.75600E+02	1.38730E-02	2.92970E-01	4.06430E-03	1.55010E-02
6.75650E+02	1.42480E-02	2.93080E-01	4.17590E-03	1.59270E-02
6.75700E+02	1.46350E-02	2.93200E-01	4.29100E-03	1.63660E-02
6.75750E+02	1.50320E-02	2.93320E-01	4.40900E-03	1.68160E-02
6.75800E+02	1.54360E-02	2.93430E-01	4.52940E-03	1.72750E-02
6.75850E+02	1.58460E-02	2.93550E-01	4.65170E-03	1.77410E-02
6.75900E+02	1.62610E-02	2.93660E-01	4.77540E-03	1.82130E-02
6.75950E+02	1.66790E-02	2.93780E-01	4.90010E-03	1.86890E-02
6.76000E+02	1.71000E-02	2.93900E-01	5.02550E-03	1.91670E-02
6.76050E+02	1.75210E-02	2.93990E-01	5.15110E-03	1.96460E-02
6.76100E+02	1.79430E-02	2.94080E-01	5.27690E-03	2.01260E-02
6.76150E+02	1.83670E-02	2.94180E-01	5.40310E-03	2.06070E-02
6.76200E+02	1.87910E-02	2.94270E-01	5.52980E-03	2.10910E-02
6.76250E+02	1.92180E-02	2.94370E-01	5.65720E-03	2.15770E-02
6.76300E+02	1.96480E-02	2.94460E-01	5.78580E-03	2.20670E-02
6.76350E+02	2.00840E-02	2.94560E-01	5.91590E-03	2.25630E-02
6.76400E+02	2.05270E-02	2.94650E-01	6.04830E-03	2.30680E-02
6.76450E+02	2.09790E-02	2.94750E-01	6.18360E-03	2.35840E-02
6.76500E+02	2.14450E-02	2.94840E-01	6.32280E-03	2.41150E-02
6.76550E+02	2.19250E-02	2.94930E-01	6.46660E-03	2.46630E-02
6.76600E+02	2.24250E-02	2.95030E-01	6.61590E-03	2.52330E-02
6.76650E+02	2.29460E-02	2.95120E-01	6.77190E-03	2.58280E-02
6.76700E+02	2.34920E-02	2.95220E-01	6.93530E-03	2.64510E-02
6.76750E+02	2.40670E-02	2.95310E-01	7.10710E-03	2.71060E-02
6.76800E+02	2.46720E-02	2.95400E-01	7.28820E-03	2.77970E-02
6.76850E+02	2.53120E-02	2.95490E-01	7.47950E-03	2.85270E-02
6.76900E+02	2.59880E-02	2.95590E-01	7.68160E-03	2.92980E-02
6.76950E+02	2.67020E-02	2.95680E-01	7.89520E-03	3.01120E-02
6.77000E+02	2.74560E-02	2.95770E-01	8.12080E-03	3.09720E-02
6.77050E+02	2.82510E-02	2.95860E-01	8.35860E-03	3.18790E-02
6.77100E+02	2.90890E-02	2.95940E-01	8.60840E-03	3.28320E-02
6.77150E+02	2.99680E-02	2.96000E-01	8.87070E-03	3.38320E-02
6.77200E+02	3.08890E-02	2.96070E-01	9.14540E-03	3.48800E-02
6.77250E+02	3.18520E-02	2.96140E-01	9.43260E-03	3.59760E-02

6.77300E+02	3.28550E-02	2.96200E-01	9.73160E-03	3.71160E-02
6.77350E+02	3.38960E-02	2.96270E-01	1.00420E-02	3.83010E-02
6.77400E+02	3.49730E-02	2.96330E-01	1.03640E-02	3.95270E-02
6.77450E+02	3.60850E-02	2.96400E-01	1.06960E-02	4.07930E-02
6.77500E+02	3.72300E-02	2.96470E-01	1.10370E-02	4.20960E-02
6.77550E+02	3.84040E-02	2.96530E-01	1.13880E-02	4.34330E-02
6.77600E+02	3.96050E-02	2.96590E-01	1.17470E-02	4.48020E-02
6.77650E+02	4.08320E-02	2.96660E-01	1.21130E-02	4.61990E-02
6.77700E+02	4.20810E-02	2.96720E-01	1.24860E-02	4.76230E-02
6.77750E+02	4.33510E-02	2.96790E-01	1.28660E-02	4.90710E-02
6.77800E+02	4.46410E-02	2.96850E-01	1.32520E-02	5.05420E-02
6.77850E+02	4.59490E-02	2.96910E-01	1.36430E-02	5.20330E-02
6.77900E+02	4.72740E-02	2.96980E-01	1.40390E-02	5.35450E-02
6.77950E+02	4.86170E-02	2.97040E-01	1.44410E-02	5.50780E-02
6.78000E+02	4.99770E-02	2.97100E-01	1.48480E-02	5.66310E-02
6.78050E+02	5.13560E-02	2.97180E-01	1.52620E-02	5.82090E-02
6.78100E+02	5.27540E-02	2.97260E-01	1.56820E-02	5.98110E-02
6.78150E+02	5.41750E-02	2.97340E-01	1.61090E-02	6.14380E-02
6.78200E+02	5.56210E-02	2.97430E-01	1.65430E-02	6.30950E-02
6.78250E+02	5.70940E-02	2.97510E-01	1.69860E-02	6.47840E-02
6.78300E+02	5.86000E-02	2.97590E-01	1.74380E-02	6.65100E-02
6.78350E+02	6.01410E-02	2.97670E-01	1.79020E-02	6.82770E-02
6.78400E+02	6.09590E-02	2.97750E-01	1.81500E-02	6.92250E-02
6.78450E+02	6.24660E-02	2.97830E-01	1.86040E-02	7.09550E-02
6.78500E+02	6.40190E-02	2.97910E-01	1.90720E-02	7.27390E-02
6.78550E+02	6.56280E-02	2.97990E-01	1.95560E-02	7.45870E-02
6.78600E+02	6.72980E-02	2.98070E-01	2.00590E-02	7.65060E-02
6.78650E+02	6.90380E-02	2.98150E-01	2.05830E-02	7.85050E-02
6.78700E+02	7.08550E-02	2.98230E-01	2.11310E-02	8.05920E-02
6.78750E+02	7.27550E-02	2.98310E-01	2.17030E-02	8.27750E-02
6.78800E+02	7.47440E-02	2.98380E-01	2.23030E-02	8.50610E-02
6.78850E+02	7.68290E-02	2.98460E-01	2.29310E-02	8.74570E-02
6.78900E+02	7.90140E-02	2.98540E-01	2.35890E-02	8.99690E-02
6.78950E+02	8.13050E-02	2.98620E-01	2.42790E-02	9.26010E-02
6.79000E+02	8.37040E-02	2.98700E-01	2.50030E-02	9.53590E-02
6.79050E+02	8.62160E-02	2.98790E-01	2.57600E-02	9.82480E-02
6.79100E+02	8.88420E-02	2.98870E-01	2.65520E-02	1.01270E-01
6.79150E+02	9.15850E-02	2.98950E-01	2.73800E-02	1.04430E-01
6.79200E+02	9.44470E-02	2.99040E-01	2.82430E-02	1.07720E-01
6.79250E+02	9.74280E-02	2.99120E-01	2.91430E-02	1.11150E-01
6.79300E+02	1.00530E-01	2.99210E-01	3.00790E-02	1.14720E-01
6.79350E+02	1.03750E-01	2.99290E-01	3.10520E-02	1.18430E-01
6.79400E+02	1.07090E-01	2.99380E-01	3.20610E-02	1.22280E-01

6.79450E+02	1.10560E-01	2.99460E-01	3.31070E-02	1.26270E-01
6.79500E+02	1.14140E-01	2.99540E-01	3.41900E-02	1.30400E-01
6.79550E+02	1.17840E-01	2.99630E-01	3.53090E-02	1.34670E-01
6.79600E+02	1.21670E-01	2.99710E-01	3.64650E-02	1.39080E-01
6.79650E+02	1.25610E-01	2.99800E-01	3.76580E-02	1.43630E-01
6.79700E+02	1.29680E-01	2.99880E-01	3.88880E-02	1.48320E-01
6.79750E+02	1.33860E-01	2.99960E-01	4.01550E-02	1.53150E-01
6.79800E+02	1.38170E-01	3.00050E-01	4.14590E-02	1.58120E-01
6.79850E+02	1.42610E-01	3.00130E-01	4.28010E-02	1.63240E-01
6.79900E+02	1.47170E-01	3.00210E-01	4.41820E-02	1.68510E-01
6.79950E+02	1.51850E-01	3.00300E-01	4.56010E-02	1.73920E-01
6.80000E+02	1.56660E-01	3.00380E-01	4.70590E-02	1.79480E-01
6.80050E+02	1.61610E-01	3.00470E-01	4.85580E-02	1.85200E-01
6.80100E+02	1.66680E-01	3.00560E-01	5.00960E-02	1.91070E-01
6.80150E+02	1.71880E-01	3.00640E-01	5.16760E-02	1.97090E-01
6.80200E+02	1.77220E-01	3.00730E-01	5.32960E-02	2.03270E-01
6.80250E+02	1.82700E-01	3.00820E-01	5.49580E-02	2.09610E-01
6.80300E+02	1.88310E-01	3.00900E-01	5.66620E-02	2.16110E-01
6.80350E+02	1.94050E-01	3.00990E-01	5.84080E-02	2.22770E-01
6.80400E+02	1.99940E-01	3.01080E-01	6.01960E-02	2.29590E-01
6.80450E+02	2.05950E-01	3.01160E-01	6.20260E-02	2.36570E-01
6.80500E+02	2.12110E-01	3.01250E-01	6.38980E-02	2.43700E-01
6.80550E+02	2.18390E-01	3.01340E-01	6.58100E-02	2.51000E-01
6.80600E+02	2.24810E-01	3.01420E-01	6.77640E-02	2.58450E-01
6.80650E+02	2.31360E-01	3.01510E-01	6.97570E-02	2.66050E-01
6.80700E+02	2.38030E-01	3.01600E-01	7.17890E-02	2.73800E-01
6.80750E+02	2.44830E-01	3.01680E-01	7.38600E-02	2.81700E-01
6.80800E+02	2.51740E-01	3.01770E-01	7.59660E-02	2.89730E-01
6.80850E+02	2.58760E-01	3.01860E-01	7.81090E-02	2.97900E-01
6.80900E+02	2.65890E-01	3.01940E-01	8.02840E-02	3.06200E-01
6.80950E+02	2.73130E-01	3.02030E-01	8.24930E-02	3.14630E-01
6.81000E+02	2.80460E-01	3.02120E-01	8.47320E-02	3.23170E-01
6.81050E+02	2.87890E-01	3.02210E-01	8.70010E-02	3.31820E-01
6.81100E+02	2.95400E-01	3.02300E-01	8.92970E-02	3.40580E-01
6.81150E+02	3.02990E-01	3.02390E-01	9.16200E-02	3.49440E-01
6.81200E+02	3.10660E-01	3.02470E-01	9.39660E-02	3.58390E-01
6.81250E+02	3.18400E-01	3.02560E-01	9.63360E-02	3.67420E-01
6.81300E+02	3.26200E-01	3.02650E-01	9.87260E-02	3.76540E-01
6.81350E+02	3.34060E-01	3.02740E-01	1.01140E-01	3.85730E-01
6.81400E+02	3.41980E-01	3.02830E-01	1.03560E-01	3.94990E-01
6.81450E+02	3.49960E-01	3.02920E-01	1.06010E-01	4.04320E-01
6.81500E+02	3.57970E-01	3.03010E-01	1.08470E-01	4.13700E-01
6.81550E+02	3.66040E-01	3.03100E-01	1.10950E-01	4.23140E-01

6.81600E+02	3.74130E-01	3.03190E-01	1.13430E-01	4.32630E-01
6.81650E+02	3.82270E-01	3.03280E-01	1.15930E-01	4.42170E-01
6.81700E+02	3.90440E-01	3.03370E-01	1.18450E-01	4.51750E-01
6.81750E+02	3.98630E-01	3.03460E-01	1.20970E-01	4.61370E-01
6.81800E+02	4.06850E-01	3.03550E-01	1.23500E-01	4.71020E-01
6.81850E+02	4.15080E-01	3.03640E-01	1.26030E-01	4.80690E-01
6.81900E+02	4.23340E-01	3.03720E-01	1.28580E-01	4.90390E-01
6.81950E+02	4.31600E-01	3.03810E-01	1.31130E-01	5.00110E-01
6.82000E+02	4.39860E-01	3.03900E-01	1.33680E-01	5.09840E-01
6.82050E+02	4.48120E-01	3.04030E-01	1.36240E-01	5.19630E-01
6.82100E+02	4.56380E-01	3.04160E-01	1.38810E-01	5.29420E-01
6.82150E+02	4.64610E-01	3.04290E-01	1.41380E-01	5.39200E-01
6.82200E+02	4.72830E-01	3.04410E-01	1.43940E-01	5.48970E-01
6.82250E+02	4.81010E-01	3.04540E-01	1.46490E-01	5.58700E-01
6.82300E+02	4.89150E-01	3.04670E-01	1.49030E-01	5.68390E-01
6.82350E+02	4.97230E-01	3.04800E-01	1.51550E-01	5.78020E-01
6.82400E+02	5.05250E-01	3.04920E-01	1.54060E-01	5.87600E-01
6.82450E+02	5.13200E-01	3.05050E-01	1.56550E-01	5.97090E-01
6.82500E+02	5.21070E-01	3.05180E-01	1.59020E-01	6.06490E-01
6.82550E+02	5.28830E-01	3.05310E-01	1.61460E-01	6.15790E-01
6.82600E+02	5.36490E-01	3.05430E-01	1.63860E-01	6.24970E-01
6.82650E+02	5.44030E-01	3.05560E-01	1.66230E-01	6.34010E-01
6.82700E+02	5.51440E-01	3.05690E-01	1.68570E-01	6.42910E-01
6.82750E+02	5.58700E-01	3.05820E-01	1.70860E-01	6.51650E-01
6.82800E+02	5.65810E-01	3.05940E-01	1.73100E-01	6.60220E-01
6.82850E+02	5.72750E-01	3.06070E-01	1.75300E-01	6.68600E-01
6.82900E+02	5.79520E-01	3.06190E-01	1.77450E-01	6.76770E-01
6.82950E+02	5.86100E-01	3.06320E-01	1.79530E-01	6.84740E-01
6.83000E+02	5.92500E-01	3.06440E-01	1.81570E-01	6.92490E-01
6.83050E+02	5.98690E-01	3.06570E-01	1.83540E-01	7.00010E-01
6.83100E+02	6.04670E-01	3.06690E-01	1.85450E-01	7.07300E-01
6.83150E+02	6.10450E-01	3.06820E-01	1.87300E-01	7.14350E-01
6.83200E+02	6.16010E-01	3.06940E-01	1.89080E-01	7.21150E-01
6.83250E+02	6.21360E-01	3.07070E-01	1.90800E-01	7.27700E-01
6.83300E+02	6.26490E-01	3.07190E-01	1.92450E-01	7.34010E-01
6.83350E+02	6.31400E-01	3.07320E-01	1.94040E-01	7.40060E-01
6.83400E+02	6.36090E-01	3.07440E-01	1.95560E-01	7.45860E-01
6.83450E+02	6.40560E-01	3.07570E-01	1.97020E-01	7.51410E-01
6.83500E+02	6.44830E-01	3.07690E-01	1.98410E-01	7.56720E-01
6.83550E+02	6.48880E-01	3.07820E-01	1.99740E-01	7.61790E-01
6.83600E+02	6.52730E-01	3.07940E-01	2.01000E-01	7.66610E-01
6.83650E+02	6.56370E-01	3.08060E-01	2.02210E-01	7.71210E-01
6.83700E+02	6.59830E-01	3.08190E-01	2.03350E-01	7.75580E-01

6.83750E+02	6.63090E-01	3.08310E-01	2.04440E-01	7.79730E-01
6.83800E+02	6.66170E-01	3.08440E-01	2.05470E-01	7.83660E-01
6.83850E+02	6.69070E-01	3.08560E-01	2.06450E-01	7.87390E-01
6.83900E+02	6.71800E-01	3.08690E-01	2.07370E-01	7.90920E-01
6.83950E+02	6.74360E-01	3.08810E-01	2.08250E-01	7.94260E-01
6.84000E+02	6.76760E-01	3.08930E-01	2.09080E-01	7.97410E-01
6.84050E+02	6.79010E-01	3.09010E-01	2.09820E-01	8.00250E-01
6.84100E+02	6.81110E-01	3.09090E-01	2.10520E-01	8.02920E-01
6.84150E+02	6.83060E-01	3.09160E-01	2.11180E-01	8.05420E-01
6.84200E+02	6.84870E-01	3.09240E-01	2.11790E-01	8.07750E-01
6.84250E+02	6.86550E-01	3.09310E-01	2.12360E-01	8.09930E-01
6.84300E+02	6.88090E-01	3.09390E-01	2.12890E-01	8.11940E-01
6.84350E+02	6.89500E-01	3.09460E-01	2.13370E-01	8.13810E-01
6.84400E+02	6.90780E-01	3.09540E-01	2.13820E-01	8.15520E-01
6.84450E+02	6.91940E-01	3.09610E-01	2.14230E-01	8.17080E-01
6.84500E+02	6.92970E-01	3.09690E-01	2.14610E-01	8.18500E-01
6.84550E+02	6.93890E-01	3.09760E-01	2.14940E-01	8.19780E-01
6.84600E+02	6.94680E-01	3.09840E-01	2.15240E-01	8.20920E-01
6.84650E+02	6.95350E-01	3.09920E-01	2.15500E-01	8.21920E-01
6.84700E+02	6.95920E-01	3.09990E-01	2.15730E-01	8.22780E-01
6.84750E+02	6.96360E-01	3.10070E-01	2.15920E-01	8.23510E-01
6.84800E+02	6.96700E-01	3.10140E-01	2.16080E-01	8.24110E-01
6.84850E+02	6.96930E-01	3.10210E-01	2.16200E-01	8.24570E-01
6.84900E+02	6.97060E-01	3.10290E-01	2.16290E-01	8.24920E-01
6.84950E+02	6.97090E-01	3.10360E-01	2.16350E-01	8.25140E-01
6.85000E+02	6.97020E-01	3.10430E-01	2.16380E-01	8.25250E-01
6.85050E+02	6.96850E-01	3.10500E-01	2.16380E-01	8.25250E-01
6.85100E+02	6.96600E-01	3.10570E-01	2.16350E-01	8.25140E-01
6.85150E+02	6.96270E-01	3.10650E-01	2.16290E-01	8.24940E-01
6.85200E+02	6.95860E-01	3.10720E-01	2.16220E-01	8.24650E-01
6.85250E+02	6.95380E-01	3.10790E-01	2.16120E-01	8.24270E-01
6.85300E+02	6.94840E-01	3.10860E-01	2.16000E-01	8.23810E-01
6.85350E+02	6.94240E-01	3.10930E-01	2.15860E-01	8.23290E-01
6.85400E+02	6.93580E-01	3.11000E-01	2.15710E-01	8.22700E-01
6.85450E+02	6.92880E-01	3.11080E-01	2.15540E-01	8.22060E-01
6.85500E+02	6.92150E-01	3.11150E-01	2.15360E-01	8.21380E-01
6.85550E+02	6.91380E-01	3.11220E-01	2.15170E-01	8.20660E-01
6.85600E+02	6.90590E-01	3.11290E-01	2.14980E-01	8.19910E-01
6.85650E+02	6.89790E-01	3.11360E-01	2.14770E-01	8.19140E-01
6.85700E+02	6.88970E-01	3.11430E-01	2.14570E-01	8.18360E-01
6.85750E+02	6.88150E-01	3.11500E-01	2.14360E-01	8.17570E-01
6.85800E+02	6.87330E-01	3.11580E-01	2.14160E-01	8.16790E-01
6.85850E+02	6.86520E-01	3.11650E-01	2.13950E-01	8.16010E-01

6.85900E+02	6.85720E-01	3.11720E-01	2.13750E-01	8.15240E-01
6.85950E+02	6.84930E-01	3.11790E-01	2.13560E-01	8.14490E-01
6.86000E+02	6.84170E-01	3.11860E-01	2.13370E-01	8.13780E-01
6.86050E+02	6.83430E-01	3.12030E-01	2.13250E-01	8.13330E-01
6.86100E+02	6.82710E-01	3.12200E-01	2.13140E-01	8.12910E-01
6.86150E+02	6.82020E-01	3.12360E-01	2.13040E-01	8.12520E-01
6.86200E+02	6.81360E-01	3.12530E-01	2.12950E-01	8.12170E-01
6.86250E+02	6.80740E-01	3.12690E-01	2.12860E-01	8.11860E-01
6.86300E+02	6.80150E-01	3.12860E-01	2.12790E-01	8.11580E-01
6.86350E+02	6.79590E-01	3.13030E-01	2.12730E-01	8.11340E-01
6.86400E+02	6.79060E-01	3.13190E-01	2.12680E-01	8.11150E-01
6.86450E+02	6.78570E-01	3.13360E-01	2.12640E-01	8.10990E-01
6.86500E+02	6.78120E-01	3.13530E-01	2.12610E-01	8.10880E-01
6.86550E+02	6.77690E-01	3.13690E-01	2.12590E-01	8.10810E-01
6.86600E+02	6.77310E-01	3.13860E-01	2.12580E-01	8.10770E-01
6.86650E+02	6.76950E-01	3.14030E-01	2.12580E-01	8.10780E-01
6.86700E+02	6.76640E-01	3.14190E-01	2.12590E-01	8.10830E-01
6.86750E+02	6.76350E-01	3.14360E-01	2.12620E-01	8.10920E-01
6.86800E+02	6.76100E-01	3.14530E-01	2.12650E-01	8.11050E-01
6.86850E+02	6.75880E-01	3.14700E-01	2.12700E-01	8.11220E-01
6.86900E+02	6.75690E-01	3.14870E-01	2.12750E-01	8.11430E-01
6.86950E+02	6.75540E-01	3.15030E-01	2.12820E-01	8.11680E-01
6.87000E+02	6.75410E-01	3.15200E-01	2.12890E-01	8.11970E-01
6.87050E+02	6.75330E-01	3.15370E-01	2.12980E-01	8.12290E-01
6.87100E+02	6.75270E-01	3.15540E-01	2.13070E-01	8.12660E-01
6.87150E+02	6.75250E-01	3.15710E-01	2.13180E-01	8.13070E-01
6.87200E+02	6.75270E-01	3.15870E-01	2.13300E-01	8.13520E-01
6.87250E+02	6.75320E-01	3.16040E-01	2.13430E-01	8.14010E-01
6.87300E+02	6.75410E-01	3.16210E-01	2.13570E-01	8.14550E-01
6.87350E+02	6.75540E-01	3.16380E-01	2.13720E-01	8.15130E-01
6.87400E+02	6.75700E-01	3.16540E-01	2.13890E-01	8.15760E-01
6.87450E+02	6.75900E-01	3.16710E-01	2.14060E-01	8.16440E-01
6.87500E+02	6.76140E-01	3.16880E-01	2.14250E-01	8.17160E-01
6.87550E+02	6.76420E-01	3.17040E-01	2.14460E-01	8.17930E-01
6.87600E+02	6.76750E-01	3.17210E-01	2.14670E-01	8.18760E-01
6.87650E+02	6.77110E-01	3.17380E-01	2.14900E-01	8.19630E-01
6.87700E+02	6.77520E-01	3.17550E-01	2.15150E-01	8.20560E-01
6.87750E+02	6.77970E-01	3.17710E-01	2.15400E-01	8.21540E-01
6.87800E+02	6.78470E-01	3.17880E-01	2.15670E-01	8.22570E-01
6.87850E+02	6.79000E-01	3.18050E-01	2.15960E-01	8.23650E-01
6.87900E+02	6.79580E-01	3.18220E-01	2.16250E-01	8.24790E-01
6.87950E+02	6.80210E-01	3.18380E-01	2.16570E-01	8.25980E-01
6.88000E+02	6.80880E-01	3.18550E-01	2.16890E-01	8.27230E-01

6.88050E+02	6.81590E-01	3.18760E-01	2.17260E-01	8.28640E-01
6.88100E+02	6.82350E-01	3.18970E-01	2.17650E-01	8.30100E-01
6.88150E+02	6.83150E-01	3.19170E-01	2.18040E-01	8.31610E-01
6.88200E+02	6.84000E-01	3.19380E-01	2.18450E-01	8.33180E-01
6.88250E+02	6.84880E-01	3.19590E-01	2.18880E-01	8.34800E-01
6.88300E+02	6.85820E-01	3.19790E-01	2.19320E-01	8.36480E-01
6.88350E+02	6.86790E-01	3.20000E-01	2.19770E-01	8.38210E-01
6.88400E+02	6.87810E-01	3.20210E-01	2.20240E-01	8.40000E-01
6.88450E+02	6.88870E-01	3.20420E-01	2.20720E-01	8.41830E-01
6.88500E+02	6.89970E-01	3.20620E-01	2.21220E-01	8.43720E-01
6.88550E+02	6.91110E-01	3.20830E-01	2.21730E-01	8.45670E-01
6.88600E+02	6.92290E-01	3.21040E-01	2.22250E-01	8.47660E-01
6.88650E+02	6.93520E-01	3.21240E-01	2.22790E-01	8.49700E-01
6.88700E+02	6.94780E-01	3.21440E-01	2.23330E-01	8.51790E-01
6.88750E+02	6.96090E-01	3.21640E-01	2.23890E-01	8.53920E-01
6.88800E+02	6.97430E-01	3.21840E-01	2.24460E-01	8.56100E-01
6.88850E+02	6.98820E-01	3.22040E-01	2.25050E-01	8.58330E-01
6.88900E+02	7.00240E-01	3.22240E-01	2.25650E-01	8.60620E-01
6.88950E+02	7.01700E-01	3.22440E-01	2.26260E-01	8.62940E-01
6.89000E+02	7.03190E-01	3.22650E-01	2.26880E-01	8.65320E-01
6.89050E+02	7.04720E-01	3.22840E-01	2.27510E-01	8.67740E-01
6.89100E+02	7.06280E-01	3.23040E-01	2.28160E-01	8.70200E-01
6.89150E+02	7.07880E-01	3.23240E-01	2.28820E-01	8.72700E-01
6.89200E+02	7.09500E-01	3.23440E-01	2.29480E-01	8.75240E-01
6.89250E+02	7.11160E-01	3.23640E-01	2.30160E-01	8.77830E-01
6.89300E+02	7.12840E-01	3.23840E-01	2.30850E-01	8.80440E-01
6.89350E+02	7.14550E-01	3.24040E-01	2.31540E-01	8.83100E-01
6.89400E+02	7.16280E-01	3.24240E-01	2.32250E-01	8.85780E-01
6.89450E+02	7.18030E-01	3.24440E-01	2.32960E-01	8.88490E-01
6.89500E+02	7.19800E-01	3.24640E-01	2.33670E-01	8.91230E-01
6.89550E+02	7.21580E-01	3.24840E-01	2.34400E-01	8.93990E-01
6.89600E+02	7.23380E-01	3.25040E-01	2.35130E-01	8.96770E-01
6.89650E+02	7.25190E-01	3.25240E-01	2.35860E-01	8.99560E-01
6.89700E+02	7.27010E-01	3.25430E-01	2.36600E-01	9.02370E-01
6.89750E+02	7.28840E-01	3.25630E-01	2.37330E-01	9.05190E-01
6.89800E+02	7.30670E-01	3.25830E-01	2.38070E-01	9.08010E-01
6.89850E+02	7.32500E-01	3.26030E-01	2.38820E-01	9.10840E-01
6.89900E+02	7.34320E-01	3.26230E-01	2.39560E-01	9.13670E-01
6.89950E+02	7.36150E-01	3.26430E-01	2.40300E-01	9.16490E-01
6.90000E+02	7.37960E-01	3.26620E-01	2.41030E-01	9.19300E-01
6.90050E+02	7.39770E-01	3.26670E-01	2.41660E-01	9.21690E-01
6.90100E+02	7.41570E-01	3.26720E-01	2.42290E-01	9.24070E-01
6.90150E+02	7.43350E-01	3.26770E-01	2.42910E-01	9.26440E-01

6.90200E+02	7.45130E-01	3.26820E-01	2.43520E-01	9.28790E-01
6.90250E+02	7.46880E-01	3.26870E-01	2.44130E-01	9.31120E-01
6.90300E+02	7.48630E-01	3.26920E-01	2.44740E-01	9.33430E-01
6.90350E+02	7.50350E-01	3.26970E-01	2.45340E-01	9.35720E-01
6.90400E+02	7.52060E-01	3.27020E-01	2.45940E-01	9.37990E-01
6.90450E+02	7.53750E-01	3.27070E-01	2.46530E-01	9.40240E-01
6.90500E+02	7.55420E-01	3.27120E-01	2.47110E-01	9.42470E-01
6.90550E+02	7.57070E-01	3.27160E-01	2.47690E-01	9.44670E-01
6.90600E+02	7.58710E-01	3.27210E-01	2.48260E-01	9.46850E-01
6.90650E+02	7.60320E-01	3.27260E-01	2.48820E-01	9.49010E-01
6.90700E+02	7.61920E-01	3.27310E-01	2.49380E-01	9.51140E-01
6.90750E+02	7.63500E-01	3.27360E-01	2.49940E-01	9.53250E-01
6.90800E+02	7.65060E-01	3.27400E-01	2.50480E-01	9.55340E-01
6.90850E+02	7.66610E-01	3.27450E-01	2.51030E-01	9.57410E-01
6.90900E+02	7.68130E-01	3.27500E-01	2.51560E-01	9.59450E-01
6.90950E+02	7.69640E-01	3.27550E-01	2.52090E-01	9.61480E-01
6.91000E+02	7.71130E-01	3.27590E-01	2.52620E-01	9.63480E-01
6.91050E+02	7.72610E-01	3.27640E-01	2.53140E-01	9.65450E-01
6.91100E+02	7.74060E-01	3.27680E-01	2.53650E-01	9.67410E-01
6.91150E+02	7.75500E-01	3.27730E-01	2.54150E-01	9.69340E-01
6.91200E+02	7.76910E-01	3.27780E-01	2.54650E-01	9.71240E-01
6.91250E+02	7.78300E-01	3.27820E-01	2.55140E-01	9.73110E-01
6.91300E+02	7.79670E-01	3.27870E-01	2.55630E-01	9.74960E-01
6.91350E+02	7.81020E-01	3.27910E-01	2.56100E-01	9.76770E-01
6.91400E+02	7.82330E-01	3.27960E-01	2.56570E-01	9.78560E-01
6.91450E+02	7.83620E-01	3.28000E-01	2.57030E-01	9.80300E-01
6.91500E+02	7.84870E-01	3.28050E-01	2.57470E-01	9.82000E-01
6.91550E+02	7.86090E-01	3.28090E-01	2.57910E-01	9.83660E-01
6.91600E+02	7.87260E-01	3.28140E-01	2.58330E-01	9.85260E-01
6.91650E+02	7.88400E-01	3.28180E-01	2.58740E-01	9.86820E-01
6.91700E+02	7.89480E-01	3.28230E-01	2.59130E-01	9.88310E-01
6.91750E+02	7.90510E-01	3.28270E-01	2.59500E-01	9.89730E-01
6.91800E+02	7.91480E-01	3.28320E-01	2.59860E-01	9.91090E-01
6.91850E+02	7.92390E-01	3.28360E-01	2.60190E-01	9.92360E-01
6.91900E+02	7.93240E-01	3.28410E-01	2.60500E-01	9.93550E-01
6.91950E+02	7.94010E-01	3.28450E-01	2.60790E-01	9.94660E-01
6.92000E+02	7.94700E-01	3.28500E-01	2.61060E-01	9.95670E-01
6.92050E+02	7.95320E-01	3.28560E-01	2.61310E-01	9.96630E-01
6.92100E+02	7.95840E-01	3.28630E-01	2.61540E-01	9.97490E-01
6.92150E+02	7.96270E-01	3.28700E-01	2.61730E-01	9.98240E-01
6.92200E+02	7.96600E-01	3.28760E-01	2.61890E-01	9.98860E-01
6.92250E+02	7.96840E-01	3.28830E-01	2.62020E-01	9.99350E-01
6.92300E+02	7.96960E-01	3.28900E-01	2.62120E-01	9.99710E-01

6.92350E+02	7.96970E-01	3.28960E-01	2.62170E-01	9.99930E-01
6.92400E+02	7.96870E-01	3.29030E-01	2.62190E-01	1.00000E+00
6.92450E+02	7.96650E-01	3.29100E-01	2.62170E-01	9.99920E-01
6.92500E+02	7.96300E-01	3.29170E-01	2.62110E-01	9.99700E-01
6.92550E+02	7.95830E-01	3.29240E-01	2.62020E-01	9.99340E-01
6.92600E+02	7.95230E-01	3.29320E-01	2.61890E-01	9.98830E-01
6.92650E+02	7.94490E-01	3.29400E-01	2.61710E-01	9.98140E-01
6.92700E+02	7.93620E-01	3.29480E-01	2.61480E-01	9.97290E-01
6.92750E+02	7.92620E-01	3.29560E-01	2.61210E-01	9.96270E-01
6.92800E+02	7.91480E-01	3.29640E-01	2.60900E-01	9.95070E-01
6.92850E+02	7.90190E-01	3.29720E-01	2.60540E-01	9.93690E-01
6.92900E+02	7.88770E-01	3.29790E-01	2.60130E-01	9.92140E-01
6.92950E+02	7.87210E-01	3.29870E-01	2.59680E-01	9.90410E-01
6.93000E+02	7.85510E-01	3.29950E-01	2.59180E-01	9.88510E-01
6.93050E+02	7.83670E-01	3.30030E-01	2.58630E-01	9.86410E-01
6.93100E+02	7.81680E-01	3.30100E-01	2.58040E-01	9.84140E-01
6.93150E+02	7.79550E-01	3.30180E-01	2.57390E-01	9.81690E-01
6.93200E+02	7.77290E-01	3.30260E-01	2.56700E-01	9.79060E-01
6.93250E+02	7.74880E-01	3.30330E-01	2.55970E-01	9.76250E-01
6.93300E+02	7.72330E-01	3.30410E-01	2.55180E-01	9.73270E-01
6.93350E+02	7.69650E-01	3.30480E-01	2.54360E-01	9.70110E-01
6.93400E+02	7.66830E-01	3.30560E-01	2.53480E-01	9.66770E-01
6.93450E+02	7.63870E-01	3.30630E-01	2.52560E-01	9.63260E-01
6.93500E+02	7.60770E-01	3.30710E-01	2.51590E-01	9.59570E-01
6.93550E+02	7.57540E-01	3.30780E-01	2.50580E-01	9.55720E-01
6.93600E+02	7.54180E-01	3.30860E-01	2.49530E-01	9.51690E-01
6.93650E+02	7.50680E-01	3.30940E-01	2.48430E-01	9.47490E-01
6.93700E+02	7.47050E-01	3.31010E-01	2.47280E-01	9.43120E-01
6.93750E+02	7.43280E-01	3.31090E-01	2.46090E-01	9.38580E-01
6.93800E+02	7.39390E-01	3.31160E-01	2.44860E-01	9.33880E-01
6.93850E+02	7.35370E-01	3.31240E-01	2.43580E-01	9.29010E-01
6.93900E+02	7.31220E-01	3.31310E-01	2.42260E-01	9.23980E-01
6.93950E+02	7.26940E-01	3.31390E-01	2.40900E-01	9.18780E-01
6.94000E+02	7.22540E-01	3.31460E-01	2.39490E-01	9.13420E-01
6.94050E+02	7.18000E-01	3.31540E-01	2.38050E-01	9.07900E-01
6.94100E+02	7.13350E-01	3.31620E-01	2.36560E-01	9.02230E-01
6.94150E+02	7.08570E-01	3.31690E-01	2.35030E-01	8.96390E-01
6.94200E+02	7.03670E-01	3.31770E-01	2.33460E-01	8.90400E-01
6.94250E+02	6.98640E-01	3.31850E-01	2.31840E-01	8.84250E-01
6.94300E+02	6.93500E-01	3.31930E-01	2.30190E-01	8.77950E-01
6.94350E+02	6.88240E-01	3.32000E-01	2.28500E-01	8.71490E-01
6.94400E+02	6.82870E-01	3.32080E-01	2.26770E-01	8.64880E-01
6.94450E+02	6.77380E-01	3.32160E-01	2.25000E-01	8.58140E-01

6.94500E+02	6.71770E-01	3.32250E-01	2.23200E-01	8.51270E-01
6.94550E+02	6.66060E-01	3.32340E-01	2.21360E-01	8.44250E-01
6.94600E+02	6.60240E-01	3.32420E-01	2.19480E-01	8.37080E-01
6.94650E+02	6.54310E-01	3.32510E-01	2.17560E-01	8.29790E-01
6.94700E+02	6.48290E-01	3.32590E-01	2.15620E-01	8.22350E-01
6.94750E+02	6.42160E-01	3.32680E-01	2.13630E-01	8.14790E-01
6.94800E+02	6.35940E-01	3.32760E-01	2.11620E-01	8.07100E-01
6.94850E+02	6.29620E-01	3.32850E-01	2.09570E-01	7.99300E-01
6.94900E+02	6.23220E-01	3.32940E-01	2.07490E-01	7.91370E-01
6.94950E+02	6.16730E-01	3.33020E-01	2.05380E-01	7.83330E-01
6.95000E+02	6.10160E-01	3.33110E-01	2.03250E-01	7.75190E-01
6.95050E+02	6.03520E-01	3.33190E-01	2.01090E-01	7.66940E-01
6.95100E+02	5.96800E-01	3.33280E-01	1.98900E-01	7.58600E-01
6.95150E+02	5.90010E-01	3.33370E-01	1.96690E-01	7.50170E-01
6.95200E+02	5.83160E-01	3.33450E-01	1.94460E-01	7.41650E-01
6.95250E+02	5.76260E-01	3.33540E-01	1.92200E-01	7.33060E-01
6.95300E+02	5.69300E-01	3.33620E-01	1.89930E-01	7.24390E-01
6.95350E+02	5.62290E-01	3.33710E-01	1.87640E-01	7.15660E-01
6.95400E+02	5.55240E-01	3.33790E-01	1.85340E-01	7.06870E-01
6.95450E+02	5.48160E-01	3.33880E-01	1.83020E-01	6.98030E-01
6.95500E+02	5.41050E-01	3.33970E-01	1.80690E-01	6.89150E-01
6.95550E+02	5.33900E-01	3.34050E-01	1.78350E-01	6.80230E-01
6.95600E+02	5.26740E-01	3.34140E-01	1.76000E-01	6.71270E-01
6.95650E+02	5.19560E-01	3.34220E-01	1.73650E-01	6.62300E-01
6.95700E+02	5.12380E-01	3.34310E-01	1.71290E-01	6.53300E-01
6.95750E+02	5.05190E-01	3.34390E-01	1.68930E-01	6.44300E-01
6.95800E+02	4.97990E-01	3.34480E-01	1.66570E-01	6.35290E-01
6.95850E+02	4.90810E-01	3.34570E-01	1.64210E-01	6.26290E-01
6.95900E+02	4.83640E-01	3.34650E-01	1.61850E-01	6.17290E-01
6.95950E+02	4.76480E-01	3.34740E-01	1.59500E-01	6.08310E-01
6.96000E+02	4.69340E-01	3.34820E-01	1.57150E-01	5.99350E-01
6.96050E+02	4.62230E-01	3.34900E-01	1.54800E-01	5.90410E-01
6.96100E+02	4.55150E-01	3.34980E-01	1.52460E-01	5.81500E-01
6.96150E+02	4.48100E-01	3.35060E-01	1.50140E-01	5.72620E-01
6.96200E+02	4.41080E-01	3.35130E-01	1.47820E-01	5.63790E-01
6.96250E+02	4.34100E-01	3.35210E-01	1.45520E-01	5.55000E-01
6.96300E+02	4.27170E-01	3.35290E-01	1.43230E-01	5.46260E-01
6.96350E+02	4.20280E-01	3.35370E-01	1.40950E-01	5.37580E-01
6.96400E+02	4.13440E-01	3.35450E-01	1.38690E-01	5.28960E-01
6.96450E+02	4.06640E-01	3.35540E-01	1.36450E-01	5.20400E-01
6.96500E+02	3.99900E-01	3.35630E-01	1.34220E-01	5.11900E-01
6.96550E+02	3.93210E-01	3.35710E-01	1.32010E-01	5.03470E-01
6.96600E+02	3.86580E-01	3.35800E-01	1.29810E-01	4.95090E-01

6.96650E+02	3.79990E-01	3.35880E-01	1.27630E-01	4.86790E-01
6.96700E+02	3.73470E-01	3.35970E-01	1.25470E-01	4.78550E-01
6.96750E+02	3.67000E-01	3.36050E-01	1.23330E-01	4.70380E-01
6.96800E+02	3.60580E-01	3.36140E-01	1.21200E-01	4.62270E-01
6.96850E+02	3.54220E-01	3.36220E-01	1.19100E-01	4.54240E-01
6.96900E+02	3.47920E-01	3.36310E-01	1.17010E-01	4.46270E-01
6.96950E+02	3.41680E-01	3.36390E-01	1.14940E-01	4.38370E-01
6.97000E+02	3.35490E-01	3.36480E-01	1.12890E-01	4.30550E-01
6.97050E+02	3.29370E-01	3.36570E-01	1.10850E-01	4.22790E-01
6.97100E+02	3.23300E-01	3.36650E-01	1.08840E-01	4.15110E-01
6.97150E+02	3.17290E-01	3.36740E-01	1.06840E-01	4.07500E-01
6.97200E+02	3.11340E-01	3.36820E-01	1.04870E-01	3.99960E-01
6.97250E+02	3.05460E-01	3.36910E-01	1.02910E-01	3.92500E-01
6.97300E+02	2.99630E-01	3.36990E-01	1.00970E-01	3.85110E-01
6.97350E+02	2.93870E-01	3.37080E-01	9.90570E-02	3.77800E-01
6.97400E+02	2.88170E-01	3.37170E-01	9.71620E-02	3.70570E-01
6.97450E+02	2.82540E-01	3.37250E-01	9.52880E-02	3.63420E-01
6.97500E+02	2.76980E-01	3.37340E-01	9.34350E-02	3.56360E-01
6.97550E+02	2.71490E-01	3.37420E-01	9.16050E-02	3.49380E-01
6.97600E+02	2.66070E-01	3.37510E-01	8.97990E-02	3.42490E-01
6.97650E+02	2.60720E-01	3.37600E-01	8.80170E-02	3.35700E-01
6.97700E+02	2.55450E-01	3.37680E-01	8.62600E-02	3.28990E-01
6.97750E+02	2.50260E-01	3.37770E-01	8.45280E-02	3.22390E-01
6.97800E+02	2.45150E-01	3.37850E-01	8.28230E-02	3.15890E-01
6.97850E+02	2.40120E-01	3.37940E-01	8.11450E-02	3.09480E-01
6.97900E+02	2.35170E-01	3.38020E-01	7.94950E-02	3.03190E-01
6.97950E+02	2.30320E-01	3.38110E-01	7.78730E-02	2.97010E-01
6.98000E+02	2.25550E-01	3.38190E-01	7.62800E-02	2.90930E-01
6.98050E+02	2.20870E-01	3.38240E-01	7.47090E-02	2.84940E-01
6.98100E+02	2.16290E-01	3.38290E-01	7.31670E-02	2.79060E-01
6.98150E+02	2.11790E-01	3.38330E-01	7.16560E-02	2.73290E-01
6.98200E+02	2.07390E-01	3.38380E-01	7.01750E-02	2.67650E-01
6.98250E+02	2.03080E-01	3.38420E-01	6.87260E-02	2.62120E-01
6.98300E+02	1.98860E-01	3.38470E-01	6.73070E-02	2.56710E-01
6.98350E+02	1.94730E-01	3.38520E-01	6.59200E-02	2.51420E-01
6.98400E+02	1.90690E-01	3.38570E-01	6.45630E-02	2.46240E-01
6.98450E+02	1.86740E-01	3.38620E-01	6.32360E-02	2.41180E-01
6.98500E+02	1.82880E-01	3.38670E-01	6.19370E-02	2.36230E-01
6.98550E+02	1.79100E-01	3.38720E-01	6.06670E-02	2.31380E-01
6.98600E+02	1.75410E-01	3.38770E-01	5.94250E-02	2.26640E-01
6.98650E+02	1.71800E-01	3.38830E-01	5.82090E-02	2.22010E-01
6.98700E+02	1.68260E-01	3.38880E-01	5.70190E-02	2.17470E-01
6.98750E+02	1.64800E-01	3.38930E-01	5.58540E-02	2.13030E-01

6.98800E+02	1.61410E-01	3.38980E-01	5.47130E-02	2.08670E-01
6.98850E+02	1.58080E-01	3.39030E-01	5.35950E-02	2.04410E-01
6.98900E+02	1.54830E-01	3.39080E-01	5.24980E-02	2.00230E-01
6.98950E+02	1.51630E-01	3.39130E-01	5.14220E-02	1.96120E-01
6.99000E+02	1.48490E-01	3.39180E-01	5.03660E-02	1.92100E-01
6.99050E+02	1.45410E-01	3.39230E-01	4.93290E-02	1.88140E-01
6.99100E+02	1.42390E-01	3.39280E-01	4.83100E-02	1.84250E-01
6.99150E+02	1.39420E-01	3.39330E-01	4.73090E-02	1.80440E-01
6.99200E+02	1.36500E-01	3.39380E-01	4.63260E-02	1.76680E-01
6.99250E+02	1.33630E-01	3.39430E-01	4.53580E-02	1.72990E-01
6.99300E+02	1.30810E-01	3.39490E-01	4.44060E-02	1.69360E-01
6.99350E+02	1.28030E-01	3.39540E-01	4.34710E-02	1.65800E-01
6.99400E+02	1.25300E-01	3.39590E-01	4.25520E-02	1.62290E-01
6.99450E+02	1.22630E-01	3.39640E-01	4.16480E-02	1.58840E-01
6.99500E+02	1.19990E-01	3.39690E-01	4.07600E-02	1.55460E-01
6.99550E+02	1.17410E-01	3.39740E-01	3.98890E-02	1.52140E-01
6.99600E+02	1.14880E-01	3.39790E-01	3.90340E-02	1.48870E-01
6.99650E+02	1.12390E-01	3.39840E-01	3.81960E-02	1.45680E-01
6.99700E+02	1.09960E-01	3.39890E-01	3.73750E-02	1.42550E-01
6.99750E+02	1.07580E-01	3.39940E-01	3.65720E-02	1.39480E-01
6.99800E+02	1.05260E-01	3.39990E-01	3.57870E-02	1.36490E-01
6.99850E+02	1.02990E-01	3.40040E-01	3.50200E-02	1.33570E-01
6.99900E+02	1.00780E-01	3.40090E-01	3.42720E-02	1.30710E-01
6.99950E+02	9.86190E-02	3.40140E-01	3.35440E-02	1.27940E-01
7.00000E+02	9.65210E-02	3.40190E-01	3.28350E-02	1.25230E-01
7.00050E+02	9.44810E-02	3.40260E-01	3.21480E-02	1.22610E-01
7.00100E+02	9.25010E-02	3.40330E-01	3.14800E-02	1.20070E-01
7.00150E+02	9.05780E-02	3.40390E-01	3.08320E-02	1.17590E-01
7.00200E+02	8.87140E-02	3.40460E-01	3.02040E-02	1.15200E-01
7.00250E+02	8.69070E-02	3.40540E-01	2.95960E-02	1.12880E-01
7.00300E+02	8.51560E-02	3.40620E-01	2.90060E-02	1.10630E-01
7.00350E+02	8.34590E-02	3.40700E-01	2.84350E-02	1.08450E-01
7.00400E+02	8.18150E-02	3.40780E-01	2.78810E-02	1.06340E-01
7.00450E+02	8.02210E-02	3.40860E-01	2.73440E-02	1.04290E-01
7.00500E+02	7.86750E-02	3.40940E-01	2.68230E-02	1.02300E-01
7.00550E+02	7.71730E-02	3.41010E-01	2.63170E-02	1.00370E-01
7.00600E+02	7.57130E-02	3.41090E-01	2.58250E-02	9.84970E-02
7.00650E+02	7.42920E-02	3.41170E-01	2.53460E-02	9.66700E-02
7.00700E+02	7.29070E-02	3.41250E-01	2.48790E-02	9.48890E-02
7.00750E+02	7.15530E-02	3.41330E-01	2.44230E-02	9.31480E-02
7.00800E+02	7.02280E-02	3.41400E-01	2.39760E-02	9.14450E-02
7.00850E+02	6.89300E-02	3.41480E-01	2.35380E-02	8.97740E-02
7.00900E+02	6.76540E-02	3.41560E-01	2.31080E-02	8.81320E-02

7.00950E+02	6.63980E-02	3.41640E-01	2.26840E-02	8.65160E-02
7.01000E+02	6.51600E-02	3.41710E-01	2.22660E-02	8.49210E-02
7.01050E+02	6.39370E-02	3.41790E-01	2.18530E-02	8.33460E-02
7.01100E+02	6.27280E-02	3.41860E-01	2.14440E-02	8.17880E-02
7.01150E+02	6.15310E-02	3.41940E-01	2.10400E-02	8.02460E-02
7.01200E+02	6.03450E-02	3.42020E-01	2.06390E-02	7.87170E-02
7.01250E+02	5.91700E-02	3.42090E-01	2.02420E-02	7.72010E-02
7.01300E+02	5.80050E-02	3.42170E-01	1.98470E-02	7.56970E-02
7.01350E+02	5.68500E-02	3.42240E-01	1.94570E-02	7.42070E-02
7.01400E+02	5.57060E-02	3.42320E-01	1.90690E-02	7.27300E-02
7.01450E+02	5.45730E-02	3.42400E-01	1.86860E-02	7.12670E-02
7.01500E+02	5.34540E-02	3.42470E-01	1.83060E-02	6.98200E-02
7.01550E+02	5.23480E-02	3.42550E-01	1.79310E-02	6.83900E-02
7.01600E+02	5.12570E-02	3.42620E-01	1.75620E-02	6.69800E-02
7.01650E+02	5.01840E-02	3.42700E-01	1.71980E-02	6.55920E-02
7.01700E+02	4.91290E-02	3.42770E-01	1.68400E-02	6.42280E-02
7.01750E+02	4.80950E-02	3.42850E-01	1.64890E-02	6.28900E-02
7.01800E+02	4.70830E-02	3.42920E-01	1.61460E-02	6.15800E-02
7.01850E+02	4.60950E-02	3.43000E-01	1.58100E-02	6.03010E-02
7.01900E+02	4.51320E-02	3.43070E-01	1.54840E-02	5.90540E-02
7.01950E+02	4.41950E-02	3.43150E-01	1.51650E-02	5.78410E-02
7.02000E+02	4.32860E-02	3.43220E-01	1.48570E-02	5.66630E-02
7.02050E+02	4.24050E-02	3.43280E-01	1.45570E-02	5.55190E-02
7.02100E+02	4.15520E-02	3.43340E-01	1.42660E-02	5.44120E-02
7.02150E+02	4.07280E-02	3.43390E-01	1.39860E-02	5.33420E-02
7.02200E+02	3.99320E-02	3.43460E-01	1.37150E-02	5.23090E-02
7.02250E+02	3.91640E-02	3.43520E-01	1.34540E-02	5.13120E-02
7.02300E+02	3.84230E-02	3.43580E-01	1.32010E-02	5.03500E-02
7.02350E+02	3.77070E-02	3.43640E-01	1.29580E-02	4.94210E-02
7.02400E+02	3.70160E-02	3.43710E-01	1.27230E-02	4.85240E-02
7.02450E+02	3.63470E-02	3.43770E-01	1.24950E-02	4.76560E-02
7.02500E+02	3.57000E-02	3.43830E-01	1.22750E-02	4.68150E-02
7.02550E+02	3.50710E-02	3.43890E-01	1.20610E-02	4.59990E-02
7.02600E+02	3.44590E-02	3.43960E-01	1.18520E-02	4.52040E-02
7.02650E+02	3.38620E-02	3.44020E-01	1.16490E-02	4.44290E-02
7.02700E+02	3.32770E-02	3.44080E-01	1.14500E-02	4.36700E-02
7.02750E+02	3.27040E-02	3.44140E-01	1.12550E-02	4.29250E-02
7.02800E+02	3.21390E-02	3.44200E-01	1.10620E-02	4.21920E-02
7.02850E+02	3.15820E-02	3.44260E-01	1.08730E-02	4.14680E-02
7.02900E+02	3.10310E-02	3.44330E-01	1.06850E-02	4.07520E-02
7.02950E+02	3.04850E-02	3.44390E-01	1.04990E-02	4.00410E-02
7.03000E+02	2.99420E-02	3.44450E-01	1.03140E-02	3.93360E-02
7.03050E+02	2.94030E-02	3.44510E-01	1.01300E-02	3.86340E-02

7.03100E+02	2.88670E-02	3.44570E-01	9.94670E-03	3.79360E-02
7.03150E+02	2.83330E-02	3.44630E-01	9.76460E-03	3.72420E-02
7.03200E+02	2.78030E-02	3.44690E-01	9.58350E-03	3.65510E-02
7.03250E+02	2.72760E-02	3.44750E-01	9.40360E-03	3.58650E-02
7.03300E+02	2.67540E-02	3.44820E-01	9.22510E-03	3.51840E-02
7.03350E+02	2.62360E-02	3.44880E-01	9.04830E-03	3.45100E-02
7.03400E+02	2.57260E-02	3.44940E-01	8.87380E-03	3.38440E-02
7.03450E+02	2.52230E-02	3.45000E-01	8.70180E-03	3.31880E-02
7.03500E+02	2.47280E-02	3.45060E-01	8.53280E-03	3.25440E-02
7.03550E+02	2.42450E-02	3.45120E-01	8.36740E-03	3.19130E-02
7.03600E+02	2.37730E-02	3.45180E-01	8.20600E-03	3.12970E-02
7.03650E+02	2.33140E-02	3.45240E-01	8.04890E-03	3.06980E-02
7.03700E+02	2.28690E-02	3.45300E-01	7.89660E-03	3.01180E-02
7.03750E+02	2.24380E-02	3.45360E-01	7.74940E-03	2.95560E-02
7.03800E+02	2.20240E-02	3.45430E-01	7.60770E-03	2.90150E-02
7.03850E+02	2.16260E-02	3.45490E-01	7.47140E-03	2.84960E-02
7.03900E+02	2.12440E-02	3.45550E-01	7.34080E-03	2.79980E-02
7.03950E+02	2.08790E-02	3.45610E-01	7.21580E-03	2.75210E-02
7.04000E+02	2.05290E-02	3.45670E-01	7.09630E-03	2.70650E-02
7.04050E+02	2.01950E-02	3.45700E-01	6.98160E-03	2.66280E-02
7.04100E+02	1.98760E-02	3.45740E-01	6.87180E-03	2.62090E-02
7.04150E+02	1.95700E-02	3.45770E-01	6.76660E-03	2.58080E-02
7.04200E+02	1.92750E-02	3.45800E-01	6.66550E-03	2.54220E-02
7.04250E+02	1.89910E-02	3.45840E-01	6.56790E-03	2.50500E-02
7.04300E+02	1.87160E-02	3.45870E-01	6.47320E-03	2.46880E-02
7.04350E+02	1.84460E-02	3.45900E-01	6.38060E-03	2.43360E-02
7.04400E+02	1.81810E-02	3.45940E-01	6.28970E-03	2.39890E-02
7.04450E+02	1.79190E-02	3.45970E-01	6.19960E-03	2.36450E-02
7.04500E+02	1.76580E-02	3.46000E-01	6.10960E-03	2.33020E-02
7.04550E+02	1.73950E-02	3.46040E-01	6.01930E-03	2.29570E-02
7.04600E+02	1.71290E-02	3.46070E-01	5.92790E-03	2.26090E-02
7.04650E+02	1.68590E-02	3.46100E-01	5.83500E-03	2.22540E-02
7.04700E+02	1.65830E-02	3.46140E-01	5.74010E-03	2.18930E-02
7.04750E+02	1.63010E-02	3.46170E-01	5.64290E-03	2.15220E-02
7.04800E+02	1.60120E-02	3.46200E-01	5.54330E-03	2.11420E-02
7.04850E+02	1.57150E-02	3.46240E-01	5.44110E-03	2.07520E-02
7.04900E+02	1.54110E-02	3.46270E-01	5.33630E-03	2.03520E-02
7.04950E+02	1.51000E-02	3.46300E-01	5.22900E-03	1.99430E-02
7.05000E+02	1.47830E-02	3.46330E-01	5.11970E-03	1.95260E-02
7.05050E+02	1.44600E-02	3.46370E-01	5.00860E-03	1.91030E-02
7.05100E+02	1.41350E-02	3.46400E-01	4.89620E-03	1.86740E-02
7.05150E+02	1.38070E-02	3.46430E-01	4.78310E-03	1.82430E-02
7.05200E+02	1.34790E-02	3.46460E-01	4.66990E-03	1.78110E-02

7.05250E+02	1.31530E-02	3.46500E-01	4.55740E-03	1.73820E-02
7.05300E+02	1.28310E-02	3.46530E-01	4.44620E-03	1.69580E-02
7.05350E+02	1.25150E-02	3.46560E-01	4.33730E-03	1.65420E-02
7.05400E+02	1.22080E-02	3.46590E-01	4.23130E-03	1.61380E-02
7.05450E+02	1.19120E-02	3.46630E-01	4.12900E-03	1.57480E-02
7.05500E+02	1.16290E-02	3.46660E-01	4.03110E-03	1.53750E-02
7.05550E+02	1.13590E-02	3.46690E-01	3.93820E-03	1.50200E-02
7.05600E+02	1.13950E-02	3.46720E-01	3.95090E-03	1.50680E-02
7.05650E+02	1.11740E-02	3.46750E-01	3.87460E-03	1.47780E-02
7.05700E+02	1.09660E-02	3.46790E-01	3.80270E-03	1.45030E-02
7.05750E+02	1.07700E-02	3.46820E-01	3.73530E-03	1.42460E-02
7.05800E+02	1.05870E-02	3.46850E-01	3.67220E-03	1.40060E-02
7.05850E+02	1.04170E-02	3.46880E-01	3.61350E-03	1.37820E-02
7.05900E+02	1.02590E-02	3.46910E-01	3.55900E-03	1.35740E-02
7.05950E+02	1.01130E-02	3.46940E-01	3.50850E-03	1.33810E-02
7.06000E+02	9.97680E-03	3.46970E-01	3.46170E-03	1.32030E-02
7.06050E+02	9.85050E-03	3.47030E-01	3.41840E-03	1.30380E-02
7.06100E+02	9.73250E-03	3.47080E-01	3.37800E-03	1.28840E-02
7.06150E+02	9.62140E-03	3.47140E-01	3.33990E-03	1.27380E-02
7.06200E+02	9.51560E-03	3.47190E-01	3.30380E-03	1.26000E-02
7.06250E+02	9.41380E-03	3.47250E-01	3.26890E-03	1.24680E-02
7.06300E+02	9.31420E-03	3.47300E-01	3.23480E-03	1.23380E-02
7.06350E+02	9.21510E-03	3.47360E-01	3.20090E-03	1.22080E-02
7.06400E+02	9.11510E-03	3.47410E-01	3.16670E-03	1.20780E-02
7.06450E+02	9.01260E-03	3.47460E-01	3.13160E-03	1.19440E-02
7.06500E+02	8.90620E-03	3.47520E-01	3.09510E-03	1.18040E-02
7.06550E+02	8.79450E-03	3.47570E-01	3.05670E-03	1.16580E-02
7.06600E+02	8.67660E-03	3.47630E-01	3.01620E-03	1.15040E-02
7.06650E+02	8.55150E-03	3.47680E-01	2.97320E-03	1.13400E-02
7.06700E+02	8.41850E-03	3.47730E-01	2.92740E-03	1.11650E-02
7.06750E+02	8.27710E-03	3.47790E-01	2.87870E-03	1.09790E-02
7.06800E+02	8.12710E-03	3.47840E-01	2.82690E-03	1.07820E-02
7.06850E+02	7.96840E-03	3.47900E-01	2.77220E-03	1.05730E-02
7.06900E+02	7.80140E-03	3.47950E-01	2.71450E-03	1.03530E-02
7.06950E+02	7.62630E-03	3.48000E-01	2.65400E-03	1.01220E-02
7.07000E+02	7.44400E-03	3.48060E-01	2.59090E-03	9.88180E-03
7.07050E+02	7.25520E-03	3.48110E-01	2.52560E-03	9.63260E-03
7.07100E+02	7.06100E-03	3.48160E-01	2.45840E-03	9.37620E-03
7.07150E+02	6.86240E-03	3.48220E-01	2.38960E-03	9.11390E-03
7.07200E+02	6.66080E-03	3.48270E-01	2.31980E-03	8.84750E-03
7.07250E+02	6.45740E-03	3.48320E-01	2.24930E-03	8.57860E-03
7.07300E+02	6.25360E-03	3.48380E-01	2.17860E-03	8.30910E-03
7.07350E+02	6.05070E-03	3.48430E-01	2.10820E-03	8.04080E-03

7.07400E+02	5.85010E-03	3.48480E-01	2.03870E-03	7.77540E-03
7.07450E+02	5.65310E-03	3.48540E-01	1.97030E-03	7.51470E-03
7.07500E+02	5.46080E-03	3.48590E-01	1.90360E-03	7.26020E-03
7.07550E+02	5.27430E-03	3.48640E-01	1.83880E-03	7.01330E-03
7.07600E+02	5.09460E-03	3.48690E-01	1.77650E-03	6.77540E-03
7.07650E+02	4.92250E-03	3.48750E-01	1.71670E-03	6.54750E-03
7.07700E+02	4.75860E-03	3.48800E-01	1.65980E-03	6.33040E-03
7.07750E+02	4.60330E-03	3.48850E-01	1.60590E-03	6.12480E-03
7.07800E+02	4.45710E-03	3.48910E-01	1.55510E-03	5.93120E-03
7.07850E+02	4.32000E-03	3.48960E-01	1.50750E-03	5.74960E-03
7.07900E+02	4.19190E-03	3.49010E-01	1.46310E-03	5.58000E-03
7.07950E+02	4.07290E-03	3.49060E-01	1.42170E-03	5.42230E-03
7.08000E+02	3.96240E-03	3.49110E-01	1.38330E-03	5.27590E-03
7.08050E+02	3.86010E-03	3.49160E-01	1.34780E-03	5.14040E-03
7.08100E+02	3.76540E-03	3.49210E-01	1.31490E-03	5.01500E-03
7.08150E+02	3.67780E-03	3.49250E-01	1.28450E-03	4.89910E-03
7.08200E+02	3.59670E-03	3.49300E-01	1.25630E-03	4.79160E-03
7.08250E+02	3.52130E-03	3.49350E-01	1.23020E-03	4.69190E-03
7.08300E+02	3.45110E-03	3.49400E-01	1.20580E-03	4.59890E-03
7.08350E+02	3.38530E-03	3.49450E-01	1.18300E-03	4.51190E-03
7.08400E+02	3.32340E-03	3.49490E-01	1.16150E-03	4.43000E-03
7.08450E+02	3.26490E-03	3.49540E-01	1.14120E-03	4.35260E-03
7.08500E+02	3.20930E-03	3.49590E-01	1.12190E-03	4.27900E-03
7.08550E+02	3.15610E-03	3.49640E-01	1.10350E-03	4.20870E-03
7.08600E+02	3.10520E-03	3.49690E-01	1.08580E-03	4.14140E-03
7.08650E+02	3.05620E-03	3.49730E-01	1.06890E-03	4.07670E-03
7.08700E+02	3.00920E-03	3.49780E-01	1.05260E-03	4.01440E-03
7.08750E+02	2.96390E-03	3.49830E-01	1.03690E-03	3.95460E-03
7.08800E+02	2.92060E-03	3.49880E-01	1.02190E-03	3.89730E-03
7.08850E+02	2.87920E-03	3.49930E-01	1.00750E-03	3.84260E-03
7.08900E+02	2.83990E-03	3.49980E-01	9.93900E-04	3.79070E-03
7.08950E+02	2.80290E-03	3.50020E-01	9.81080E-04	3.74180E-03
7.09000E+02	2.76840E-03	3.50070E-01	9.69130E-04	3.69620E-03
7.09050E+02	2.73650E-03	3.50120E-01	9.58110E-04	3.65420E-03
7.09100E+02	2.70760E-03	3.50170E-01	9.48090E-04	3.61600E-03
7.09150E+02	2.68160E-03	3.50210E-01	9.39130E-04	3.58180E-03
7.09200E+02	2.65880E-03	3.50260E-01	9.31270E-04	3.55180E-03
7.09250E+02	2.63920E-03	3.50310E-01	9.24520E-04	3.52610E-03
7.09300E+02	2.62270E-03	3.50350E-01	9.18870E-04	3.50460E-03
7.09350E+02	2.60930E-03	3.50400E-01	9.14310E-04	3.48720E-03
7.09400E+02	2.59880E-03	3.50450E-01	9.10760E-04	3.47360E-03
7.09450E+02	2.59100E-03	3.50500E-01	9.08140E-04	3.46360E-03
7.09500E+02	2.58550E-03	3.50540E-01	9.06330E-04	3.45670E-03

7.09550E+02	2.58190E-03	3.50590E-01	9.05180E-04	3.45230E-03
7.09600E+02	2.57970E-03	3.50640E-01	9.04530E-04	3.44990E-03
7.09650E+02	2.57840E-03	3.50680E-01	9.04190E-04	3.44860E-03
7.09700E+02	2.57740E-03	3.50730E-01	9.03960E-04	3.44770E-03
7.09750E+02	2.57610E-03	3.50780E-01	9.03630E-04	3.44640E-03
7.09800E+02	2.57390E-03	3.50830E-01	9.02980E-04	3.44400E-03
7.09850E+02	2.57020E-03	3.50870E-01	9.01820E-04	3.43950E-03
7.09900E+02	2.56450E-03	3.50920E-01	8.99930E-04	3.43230E-03
7.09950E+02	2.55620E-03	3.50960E-01	8.97150E-04	3.42170E-03
7.10000E+02	2.54500E-03	3.51010E-01	8.93320E-04	3.40710E-03
7.10050E+02	2.53040E-03	3.51020E-01	8.88230E-04	3.38770E-03
7.10100E+02	2.51220E-03	3.51030E-01	8.81880E-04	3.36350E-03
7.10150E+02	2.49020E-03	3.51050E-01	8.74180E-04	3.33410E-03
7.10200E+02	2.46430E-03	3.51060E-01	8.65130E-04	3.29960E-03
7.10250E+02	2.43460E-03	3.51080E-01	8.54720E-04	3.25990E-03
7.10300E+02	2.40110E-03	3.51090E-01	8.43010E-04	3.21520E-03
7.10350E+02	2.36420E-03	3.51100E-01	8.30070E-04	3.16590E-03
7.10400E+02	2.32400E-03	3.51120E-01	8.16000E-04	3.11220E-03
7.10450E+02	2.28110E-03	3.51130E-01	8.00950E-04	3.05480E-03
7.10500E+02	2.23580E-03	3.51140E-01	7.85070E-04	2.99430E-03
7.10550E+02	2.18860E-03	3.51160E-01	7.68540E-04	2.93120E-03
7.10600E+02	2.14010E-03	3.51170E-01	7.51540E-04	2.86630E-03
7.10650E+02	2.09080E-03	3.51180E-01	7.34240E-04	2.80040E-03
7.10700E+02	2.04120E-03	3.51200E-01	7.16850E-04	2.73400E-03
7.10750E+02	1.99180E-03	3.51210E-01	6.99530E-04	2.66800E-03
7.10800E+02	1.94310E-03	3.51220E-01	6.82450E-04	2.60290E-03
7.10850E+02	1.89550E-03	3.51240E-01	6.65760E-04	2.53920E-03
7.10900E+02	1.84930E-03	3.51250E-01	6.49570E-04	2.47750E-03
7.10950E+02	1.80490E-03	3.51260E-01	6.33990E-04	2.41800E-03
7.11000E+02	1.76230E-03	3.51280E-01	6.19060E-04	2.36110E-03
7.11050E+02	1.72170E-03	3.51290E-01	6.04820E-04	2.30680E-03
7.11100E+02	1.68310E-03	3.51300E-01	5.91280E-04	2.25510E-03
7.11150E+02	1.64640E-03	3.51310E-01	5.78400E-04	2.20600E-03
7.11200E+02	1.61140E-03	3.51320E-01	5.66120E-04	2.15920E-03
7.11250E+02	1.57790E-03	3.51330E-01	5.54360E-04	2.11430E-03
7.11300E+02	1.54550E-03	3.51340E-01	5.42990E-04	2.07100E-03
7.11350E+02	1.51390E-03	3.51360E-01	5.31910E-04	2.02870E-03
7.11400E+02	1.48270E-03	3.51370E-01	5.20980E-04	1.98700E-03
7.11450E+02	1.45160E-03	3.51380E-01	5.10070E-04	1.94540E-03
7.11500E+02	1.42020E-03	3.51390E-01	4.99040E-04	1.90330E-03
7.11550E+02	1.38810E-03	3.51400E-01	4.87790E-04	1.86040E-03
7.11600E+02	1.35510E-03	3.51410E-01	4.76210E-04	1.81630E-03
7.11650E+02	1.32100E-03	3.51420E-01	4.64230E-04	1.77060E-03

7.11700E+02	1.28560E-03	3.51430E-01	4.51810E-04	1.72320E-03
7.11750E+02	1.24900E-03	3.51450E-01	4.38950E-04	1.67410E-03
7.11800E+02	1.21110E-03	3.51460E-01	4.25640E-04	1.62340E-03
7.11850E+02	1.17210E-03	3.51460E-01	4.11960E-04	1.57120E-03
7.11900E+02	1.13240E-03	3.51470E-01	3.98000E-04	1.51800E-03
7.11950E+02	1.09220E-03	3.51480E-01	3.83880E-04	1.46410E-03
7.12000E+02	1.05200E-03	3.51490E-01	3.69750E-04	1.41020E-03
7.12050E+02	1.01220E-03	3.51480E-01	3.55770E-04	1.35690E-03
7.12100E+02	9.73420E-04	3.51480E-01	3.42140E-04	1.30490E-03
7.12150E+02	9.36160E-04	3.51480E-01	3.29040E-04	1.25500E-03
7.12200E+02	9.00960E-04	3.51480E-01	3.16670E-04	1.20780E-03
7.12250E+02	8.68380E-04	3.51480E-01	3.05220E-04	1.16410E-03
7.12300E+02	8.38890E-04	3.51480E-01	2.94850E-04	1.12460E-03
7.12350E+02	8.12960E-04	3.51470E-01	2.85730E-04	1.08980E-03
7.12400E+02	7.90940E-04	3.51470E-01	2.77990E-04	1.06030E-03
7.12450E+02	7.73120E-04	3.51470E-01	2.71730E-04	1.03640E-03
7.12500E+02	7.59660E-04	3.51470E-01	2.66990E-04	1.01830E-03
7.12550E+02	7.50600E-04	3.51470E-01	2.63810E-04	1.00620E-03
7.12600E+02	7.45850E-04	3.51460E-01	2.62140E-04	9.99790E-04
7.12650E+02	7.45160E-04	3.51460E-01	2.61900E-04	9.98870E-04
7.12700E+02	7.48170E-04	3.51460E-01	2.62950E-04	1.00290E-03
7.12750E+02	7.54340E-04	3.51460E-01	2.65120E-04	1.01120E-03
7.12800E+02	7.63040E-04	3.51460E-01	2.68170E-04	1.02280E-03
7.12850E+02	7.73490E-04	3.51460E-01	2.71850E-04	1.03680E-03
7.12900E+02	7.84850E-04	3.51450E-01	2.75840E-04	1.05200E-03
7.12950E+02	7.96210E-04	3.51450E-01	2.79830E-04	1.06730E-03
7.13000E+02	8.06610E-04	3.51450E-01	2.83480E-04	1.08120E-03
7.13050E+02	8.15100E-04	3.51450E-01	2.86460E-04	1.09260E-03
7.13100E+02	8.20770E-04	3.51450E-01	2.88460E-04	1.10020E-03
7.13150E+02	8.22800E-04	3.51440E-01	2.89170E-04	1.10290E-03
7.13200E+02	8.20440E-04	3.51440E-01	2.88340E-04	1.09970E-03
7.13250E+02	8.13100E-04	3.51440E-01	2.85760E-04	1.08990E-03
7.13300E+02	8.00340E-04	3.51440E-01	2.81270E-04	1.07280E-03
7.13350E+02	7.81890E-04	3.51440E-01	2.74780E-04	1.04800E-03
7.13400E+02	7.57680E-04	3.51440E-01	2.66280E-04	1.01560E-03
7.13450E+02	7.27860E-04	3.51430E-01	2.55790E-04	9.75590E-04
7.13500E+02	6.92780E-04	3.51430E-01	2.43470E-04	9.28570E-04
7.13550E+02	6.53480E-04	3.51430E-01	2.29650E-04	8.75890E-04
7.13600E+02	6.13730E-04	3.51430E-01	2.15680E-04	8.22610E-04
7.13650E+02	5.73920E-04	3.51430E-01	2.01690E-04	7.69240E-04
7.13700E+02	5.33620E-04	3.51430E-01	1.87530E-04	7.15230E-04
7.13750E+02	4.92480E-04	3.51430E-01	1.73070E-04	6.60090E-04
7.13800E+02	4.50320E-04	3.51430E-01	1.58250E-04	6.03580E-04

7.13850E+02	4.07600E-04	3.51430E-01	1.43240E-04	5.46330E-04
7.13900E+02	3.66190E-04	3.51430E-01	1.28690E-04	4.90830E-04
7.13950E+02	3.28510E-04	3.51440E-01	1.15450E-04	4.40320E-04
7.14000E+02	2.96370E-04	3.51440E-01	1.04160E-04	3.97250E-04
7.14050E+02	2.71170E-04	3.51410E-01	9.52900E-05	3.63430E-04
7.14100E+02	2.54000E-04	3.51370E-01	8.92490E-05	3.40400E-04
7.14150E+02	2.45740E-04	3.51340E-01	8.63390E-05	3.29290E-04
7.14200E+02	2.47000E-04	3.51310E-01	8.67750E-05	3.30960E-04
7.14250E+02	2.58140E-04	3.51280E-01	9.06790E-05	3.45850E-04
7.14300E+02	2.79210E-04	3.51250E-01	9.80730E-05	3.74050E-04
7.14350E+02	3.10000E-04	3.51220E-01	1.08880E-04	4.15250E-04
7.14400E+02	3.49960E-04	3.51180E-01	1.22900E-04	4.68740E-04
7.14450E+02	3.98290E-04	3.51150E-01	1.39860E-04	5.33430E-04
7.14500E+02	4.53890E-04	3.51120E-01	1.59370E-04	6.07840E-04
7.14550E+02	5.15390E-04	3.51090E-01	1.80950E-04	6.90130E-04
7.14600E+02	5.80760E-04	3.51060E-01	2.03880E-04	7.77590E-04
7.14650E+02	6.45240E-04	3.51020E-01	2.26500E-04	8.63850E-04
7.14700E+02	7.07520E-04	3.50990E-01	2.48330E-04	9.47140E-04
7.14750E+02	7.67180E-04	3.50960E-01	2.69250E-04	1.02690E-03
7.14800E+02	8.23880E-04	3.50930E-01	2.89120E-04	1.10270E-03
7.14850E+02	8.77220E-04	3.50900E-01	3.07820E-04	1.17400E-03
7.14900E+02	9.26330E-04	3.50870E-01	3.25020E-04	1.23960E-03
7.14950E+02	9.69140E-04	3.50830E-01	3.40000E-04	1.29680E-03
7.15000E+02	1.00320E-03	3.50800E-01	3.51920E-04	1.34220E-03
7.15050E+02	1.02680E-03	3.50770E-01	3.60170E-04	1.37370E-03
7.15100E+02	1.03900E-03	3.50740E-01	3.64420E-04	1.38990E-03
7.15150E+02	1.03920E-03	3.50700E-01	3.64460E-04	1.39000E-03
7.15200E+02	1.02730E-03	3.50670E-01	3.60250E-04	1.37400E-03
7.15250E+02	1.00360E-03	3.50640E-01	3.51910E-04	1.34220E-03
7.15300E+02	9.69100E-04	3.50610E-01	3.39770E-04	1.29590E-03
7.15350E+02	9.27750E-04	3.50580E-01	3.25240E-04	1.24050E-03
7.15400E+02	8.83670E-04	3.50540E-01	3.09760E-04	1.18140E-03
7.15450E+02	8.36890E-04	3.50510E-01	2.93340E-04	1.11880E-03
7.15500E+02	7.86900E-04	3.50480E-01	2.75790E-04	1.05190E-03
7.15550E+02	7.33230E-04	3.50450E-01	2.56960E-04	9.80030E-04
7.15600E+02	6.75520E-04	3.50410E-01	2.36710E-04	9.02820E-04
7.15650E+02	6.13780E-04	3.50380E-01	2.15060E-04	8.20230E-04
7.15700E+02	5.50540E-04	3.50360E-01	1.92890E-04	7.35660E-04
7.15750E+02	4.92250E-04	3.50330E-01	1.72450E-04	6.57730E-04
7.15800E+02	4.42350E-04	3.50310E-01	1.54960E-04	5.91020E-04
7.15850E+02	4.03140E-04	3.50290E-01	1.41220E-04	5.38590E-04
7.15900E+02	3.76520E-04	3.50260E-01	1.31880E-04	5.02980E-04
7.15950E+02	3.64000E-04	3.50240E-01	1.27490E-04	4.86230E-04

7.16000E+02	3.66760E-04	3.50210E-01	1.28440E-04	4.89880E-04
7.16050E+02	3.85520E-04	3.50230E-01	1.35020E-04	5.14970E-04
7.16100E+02	4.20560E-04	3.50250E-01	1.47300E-04	5.61810E-04
7.16150E+02	4.71720E-04	3.50260E-01	1.65230E-04	6.30180E-04
7.16200E+02	5.38350E-04	3.50280E-01	1.88570E-04	7.19220E-04
7.16250E+02	6.19340E-04	3.50300E-01	2.16950E-04	8.27460E-04
7.16300E+02	7.13110E-04	3.50320E-01	2.49810E-04	9.52780E-04
7.16350E+02	8.17380E-04	3.50330E-01	2.86350E-04	1.09210E-03
7.16400E+02	9.26980E-04	3.50350E-01	3.24770E-04	1.23860E-03
7.16450E+02	1.03660E-03	3.50370E-01	3.63190E-04	1.38520E-03
7.16500E+02	1.14520E-03	3.50380E-01	4.01270E-04	1.53040E-03
7.16550E+02	1.25240E-03	3.50400E-01	4.38840E-04	1.67370E-03
7.16600E+02	1.35790E-03	3.50420E-01	4.75830E-04	1.81480E-03
7.16650E+02	1.46150E-03	3.50430E-01	5.12170E-04	1.95340E-03
7.16700E+02	1.56300E-03	3.50450E-01	5.47750E-04	2.08910E-03
7.16750E+02	1.65960E-03	3.50470E-01	5.81630E-04	2.21830E-03
7.16800E+02	1.74500E-03	3.50480E-01	6.11600E-04	2.33260E-03
7.16850E+02	1.81620E-03	3.50500E-01	6.36590E-04	2.42790E-03
7.16900E+02	1.87150E-03	3.50520E-01	6.55980E-04	2.50190E-03
7.16950E+02	1.90960E-03	3.50530E-01	6.69370E-04	2.55300E-03
7.17000E+02	1.93000E-03	3.50550E-01	6.76550E-04	2.58040E-03
7.17050E+02	1.93260E-03	3.50570E-01	6.77510E-04	2.58400E-03
7.17100E+02	1.91790E-03	3.50580E-01	6.72380E-04	2.56450E-03
7.17150E+02	1.88680E-03	3.50600E-01	6.61520E-04	2.52300E-03
7.17200E+02	1.84080E-03	3.50610E-01	6.45430E-04	2.46160E-03
7.17250E+02	1.78180E-03	3.50630E-01	6.24770E-04	2.38280E-03
7.17300E+02	1.71210E-03	3.50650E-01	6.00340E-04	2.28970E-03
7.17350E+02	1.63420E-03	3.50660E-01	5.73050E-04	2.18560E-03
7.17400E+02	1.55110E-03	3.50680E-01	5.43930E-04	2.07450E-03
7.17450E+02	1.46580E-03	3.50690E-01	5.14040E-04	1.96050E-03
7.17500E+02	1.27370E-03	3.50710E-01	4.46690E-04	1.70370E-03
7.17550E+02	1.10510E-03	3.50720E-01	3.87600E-04	1.47830E-03
7.17600E+02	9.49040E-04	3.50750E-01	3.32880E-04	1.26960E-03
7.17650E+02	8.10680E-04	3.50790E-01	2.84380E-04	1.08460E-03
7.17700E+02	6.94900E-04	3.50820E-01	2.43790E-04	9.29800E-04
7.17750E+02	6.05710E-04	3.50860E-01	2.12520E-04	8.10540E-04
7.17800E+02	5.46500E-04	3.50890E-01	1.91760E-04	7.31380E-04
7.17850E+02	5.19870E-04	3.50920E-01	1.82430E-04	6.95800E-04
7.17900E+02	5.27630E-04	3.50960E-01	1.85170E-04	7.06250E-04
7.17950E+02	5.70950E-04	3.50990E-01	2.00400E-04	7.64310E-04
7.18000E+02	0.00000E+00	3.51020E-01	0	0

Channel 4

Wavenumber	HIRS Filter Transmittance	Optical Element Transmittance	Product of the HIRS Filter and Optical Element Transmittances	Normalized Value of Column 4
6.86300E+02	0.00000E+00	3.12860E-01	0.00000E+00	0.00000E+00
6.86400E+02	8.20000E-04	3.13190E-01	2.56820E-04	9.83310E-04
6.86500E+02	7.43910E-04	3.13530E-01	2.33240E-04	8.93020E-04
6.86600E+02	8.08230E-04	3.13860E-01	2.53670E-04	9.71260E-04
6.86700E+02	1.07040E-03	3.14190E-01	3.36310E-04	1.28770E-03
6.86800E+02	1.56690E-03	3.14530E-01	4.92840E-04	1.88700E-03
6.86900E+02	2.29870E-03	3.14870E-01	7.23800E-04	2.77130E-03
6.87000E+02	3.22450E-03	3.15200E-01	1.01640E-03	3.89150E-03
6.87100E+02	4.26410E-03	3.15540E-01	1.34550E-03	5.15160E-03
6.87200E+02	5.31160E-03	3.15870E-01	1.67780E-03	6.42390E-03
6.87300E+02	6.25550E-03	3.16210E-01	1.97800E-03	7.57360E-03
6.87400E+02	5.03040E-03	3.16540E-01	1.59240E-03	6.09680E-03
6.87500E+02	5.31670E-03	3.16880E-01	1.68480E-03	6.45060E-03
6.87600E+02	5.59530E-03	3.17210E-01	1.77490E-03	6.79580E-03
6.87700E+02	5.84920E-03	3.17550E-01	1.85740E-03	7.11170E-03
6.87800E+02	6.05930E-03	3.17880E-01	1.92620E-03	7.37490E-03
6.87900E+02	6.20830E-03	3.18220E-01	1.97560E-03	7.56420E-03
6.88000E+02	6.28520E-03	3.18550E-01	2.00210E-03	7.66590E-03
6.88100E+02	6.28920E-03	3.18970E-01	2.00600E-03	7.68070E-03
6.88200E+02	6.23200E-03	3.19380E-01	1.99040E-03	7.62070E-03
6.88300E+02	6.13770E-03	3.19790E-01	1.96280E-03	7.51520E-03
6.88400E+02	6.03980E-03	3.20210E-01	1.93400E-03	7.40490E-03
6.88500E+02	5.97640E-03	3.20620E-01	1.91620E-03	7.33670E-03
6.88600E+02	5.98400E-03	3.21040E-01	1.92110E-03	7.35540E-03
6.88700E+02	6.09080E-03	3.21440E-01	1.95780E-03	7.49620E-03
6.88800E+02	6.31200E-03	3.21840E-01	2.03150E-03	7.77810E-03
6.88900E+02	6.64700E-03	3.22240E-01	2.14200E-03	8.20120E-03
6.89000E+02	7.07970E-03	3.22650E-01	2.28420E-03	8.74590E-03
6.89100E+02	7.58200E-03	3.23040E-01	2.44930E-03	9.37810E-03
6.89200E+02	8.11980E-03	3.23440E-01	2.62630E-03	1.00560E-02
6.89300E+02	8.66000E-03	3.23840E-01	2.80450E-03	1.07380E-02
6.89400E+02	9.17770E-03	3.24240E-01	2.97580E-03	1.13940E-02
6.89500E+02	9.66140E-03	3.24640E-01	3.13650E-03	1.20090E-02
6.89600E+02	1.01160E-02	3.25040E-01	3.28790E-03	1.25890E-02
6.89700E+02	1.05600E-02	3.25430E-01	3.43660E-03	1.31580E-02
6.89800E+02	1.10250E-02	3.25830E-01	3.59240E-03	1.37550E-02
6.89900E+02	1.15470E-02	3.26230E-01	3.76700E-03	1.44230E-02
6.90000E+02	1.21580E-02	3.26620E-01	3.97110E-03	1.52040E-02
6.90100E+02	1.28810E-02	3.26720E-01	4.20840E-03	1.61130E-02

6.90200E+02	1.37230E-02	3.26820E-01	4.48480E-03	1.71720E-02
6.90300E+02	1.46750E-02	3.26920E-01	4.79760E-03	1.83690E-02
6.90400E+02	1.57140E-02	3.27020E-01	5.13880E-03	1.96750E-02
6.90500E+02	1.68040E-02	3.27120E-01	5.49690E-03	2.10470E-02
6.90600E+02	1.79070E-02	3.27210E-01	5.85940E-03	2.24350E-02
6.90700E+02	1.89880E-02	3.27310E-01	6.21480E-03	2.37950E-02
6.90800E+02	2.00220E-02	3.27400E-01	6.55540E-03	2.50990E-02
6.90900E+02	2.10030E-02	3.27500E-01	6.87850E-03	2.63360E-02
6.91000E+02	2.19390E-02	3.27590E-01	7.18720E-03	2.75180E-02
6.91100E+02	2.28560E-02	3.27680E-01	7.48970E-03	2.86770E-02
6.91200E+02	2.37910E-02	3.27780E-01	7.79820E-03	2.98580E-02
6.91300E+02	2.47850E-02	3.27870E-01	8.12630E-03	3.11140E-02
6.91400E+02	2.58790E-02	3.27960E-01	8.48710E-03	3.24960E-02
6.91500E+02	2.71040E-02	3.28050E-01	8.89130E-03	3.40430E-02
6.91600E+02	2.84810E-02	3.28140E-01	9.34570E-03	3.57830E-02
6.91700E+02	3.03400E-02	3.28230E-01	9.95850E-03	3.81290E-02
6.91800E+02	3.16790E-02	3.28320E-01	1.04010E-02	3.98220E-02
6.91900E+02	3.29330E-02	3.28410E-01	1.08160E-02	4.14110E-02
6.92000E+02	3.42130E-02	3.28500E-01	1.12390E-02	4.30310E-02
6.92100E+02	3.56190E-02	3.28630E-01	1.17060E-02	4.48180E-02
6.92200E+02	3.72280E-02	3.28760E-01	1.22390E-02	4.68610E-02
6.92300E+02	3.90760E-02	3.28900E-01	1.28520E-02	4.92080E-02
6.92400E+02	4.11680E-02	3.29030E-01	1.35450E-02	5.18630E-02
6.92500E+02	4.34790E-02	3.29170E-01	1.43120E-02	5.47970E-02
6.92600E+02	4.59790E-02	3.29320E-01	1.51420E-02	5.79760E-02
6.92700E+02	4.86470E-02	3.29480E-01	1.60280E-02	6.13690E-02
6.92800E+02	5.14900E-02	3.29640E-01	1.69730E-02	6.49870E-02
6.92900E+02	5.45480E-02	3.29790E-01	1.79900E-02	6.88790E-02
6.93000E+02	5.78940E-02	3.29950E-01	1.91020E-02	7.31390E-02
6.93100E+02	6.16230E-02	3.30100E-01	2.03420E-02	7.78860E-02
6.93200E+02	6.58320E-02	3.30260E-01	2.17410E-02	8.32440E-02
6.93300E+02	7.06020E-02	3.30410E-01	2.33270E-02	8.93160E-02
6.93400E+02	7.59780E-02	3.30560E-01	2.51150E-02	9.61610E-02
6.93500E+02	8.19630E-02	3.30710E-01	2.71060E-02	1.03780E-01
6.93600E+02	8.85120E-02	3.30860E-01	2.92850E-02	1.12130E-01
6.93700E+02	9.55500E-02	3.31010E-01	3.16280E-02	1.21100E-01
6.93800E+02	1.02990E-01	3.31160E-01	3.41050E-02	1.30580E-01
6.93900E+02	1.10740E-01	3.31310E-01	3.66880E-02	1.40470E-01
6.94000E+02	1.18760E-01	3.31460E-01	3.93640E-02	1.50720E-01
6.94100E+02	1.27060E-01	3.31620E-01	4.21340E-02	1.61320E-01
6.94200E+02	1.35700E-01	3.31770E-01	4.50210E-02	1.72380E-01
6.94300E+02	1.44810E-01	3.31930E-01	4.80660E-02	1.84040E-01
6.94400E+02	1.54550E-01	3.32080E-01	5.13250E-02	1.96510E-01

6.94500E+02	1.65120E-01	3.32250E-01	5.48620E-02	2.10060E-01
6.94600E+02	1.76690E-01	3.32420E-01	5.87360E-02	2.24890E-01
6.94700E+02	1.89400E-01	3.32590E-01	6.29940E-02	2.41190E-01
6.94800E+02	2.03330E-01	3.32760E-01	6.76620E-02	2.59070E-01
6.94900E+02	2.18500E-01	3.32940E-01	7.27470E-02	2.78540E-01
6.95000E+02	2.34850E-01	3.33110E-01	7.82300E-02	2.99530E-01
6.95100E+02	2.52260E-01	3.33280E-01	8.40730E-02	3.21900E-01
6.95200E+02	2.70580E-01	3.33450E-01	9.02250E-02	3.45450E-01
6.95300E+02	2.89630E-01	3.33620E-01	9.66280E-02	3.69970E-01
6.95400E+02	3.09260E-01	3.33790E-01	1.03230E-01	3.95240E-01
6.95500E+02	3.29300E-01	3.33970E-01	1.09980E-01	4.21080E-01
6.95600E+02	3.49670E-01	3.34140E-01	1.16840E-01	4.47350E-01
6.95700E+02	3.70270E-01	3.34310E-01	1.23780E-01	4.73950E-01
6.95800E+02	3.91060E-01	3.34480E-01	1.30800E-01	5.00820E-01
6.95900E+02	4.12010E-01	3.34650E-01	1.37880E-01	5.27920E-01
6.96000E+02	4.33080E-01	3.34820E-01	1.45000E-01	5.55200E-01
6.96100E+02	4.54220E-01	3.34980E-01	1.52150E-01	5.82570E-01
6.96200E+02	4.75350E-01	3.35130E-01	1.59310E-01	6.09960E-01
6.96300E+02	4.96370E-01	3.35290E-01	1.66430E-01	6.37230E-01
6.96400E+02	5.17150E-01	3.35450E-01	1.73480E-01	6.64230E-01
6.96500E+02	5.37540E-01	3.35630E-01	1.80410E-01	6.90770E-01
6.96600E+02	5.57390E-01	3.35800E-01	1.87170E-01	7.16630E-01
6.96700E+02	5.76530E-01	3.35970E-01	1.93700E-01	7.41630E-01
6.96800E+02	5.94860E-01	3.36140E-01	1.99960E-01	7.65590E-01
6.96900E+02	6.12260E-01	3.36310E-01	2.05910E-01	7.88380E-01
6.97000E+02	6.28650E-01	3.36480E-01	2.11530E-01	8.09900E-01
6.97100E+02	6.43970E-01	3.36650E-01	2.16790E-01	8.30070E-01
6.97200E+02	6.58200E-01	3.36820E-01	2.21700E-01	8.48840E-01
6.97300E+02	6.71320E-01	3.36990E-01	2.26230E-01	8.66190E-01
6.97400E+02	6.83280E-01	3.37170E-01	2.30380E-01	8.82080E-01
6.97500E+02	6.94080E-01	3.37340E-01	2.34140E-01	8.96480E-01
6.97600E+02	7.03680E-01	3.37510E-01	2.37500E-01	9.09350E-01
6.97700E+02	7.12060E-01	3.37680E-01	2.40450E-01	9.20640E-01
6.97800E+02	7.19180E-01	3.37850E-01	2.42980E-01	9.30310E-01
6.97900E+02	7.25020E-01	3.38020E-01	2.45070E-01	9.38340E-01
6.98000E+02	7.29580E-01	3.38190E-01	2.46740E-01	9.44730E-01
6.98100E+02	7.32890E-01	3.38290E-01	2.47930E-01	9.49260E-01
6.98200E+02	7.34990E-01	3.38380E-01	2.48700E-01	9.52240E-01
6.98300E+02	7.35980E-01	3.38470E-01	2.49110E-01	9.53780E-01
6.98400E+02	7.35960E-01	3.38570E-01	2.49180E-01	9.54050E-01
6.98500E+02	7.35080E-01	3.38670E-01	2.48950E-01	9.53190E-01
6.98600E+02	7.33490E-01	3.38770E-01	2.48490E-01	9.51410E-01
6.98700E+02	7.31330E-01	3.38880E-01	2.47830E-01	9.48900E-01

6.98800E+02	7.28770E-01	3.38980E-01	2.47040E-01	9.45860E-01
6.98900E+02	7.25930E-01	3.39080E-01	2.46150E-01	9.42460E-01
6.99000E+02	7.22930E-01	3.39180E-01	2.45200E-01	9.38840E-01
6.99100E+02	7.19830E-01	3.39280E-01	2.44230E-01	9.35100E-01
6.99200E+02	7.16700E-01	3.39380E-01	2.43240E-01	9.31310E-01
6.99300E+02	7.13560E-01	3.39490E-01	2.42240E-01	9.27500E-01
6.99400E+02	7.10410E-01	3.39590E-01	2.41250E-01	9.23690E-01
6.99500E+02	7.07250E-01	3.39690E-01	2.40250E-01	9.19860E-01
6.99600E+02	7.04080E-01	3.39790E-01	2.39240E-01	9.16000E-01
6.99700E+02	7.00890E-01	3.39890E-01	2.38220E-01	9.12120E-01
6.99800E+02	6.97690E-01	3.39990E-01	2.37210E-01	9.08220E-01
6.99900E+02	6.94530E-01	3.40090E-01	2.36200E-01	9.04380E-01
7.00000E+02	6.91460E-01	3.40190E-01	2.35230E-01	9.00640E-01
7.00100E+02	6.88550E-01	3.40330E-01	2.34330E-01	8.97210E-01
7.00200E+02	6.85890E-01	3.40460E-01	2.33520E-01	8.94110E-01
7.00300E+02	6.83570E-01	3.40620E-01	2.32840E-01	8.91500E-01
7.00400E+02	6.81670E-01	3.40780E-01	2.32300E-01	8.89430E-01
7.00500E+02	6.80240E-01	3.40940E-01	2.31920E-01	8.87970E-01
7.00600E+02	6.79310E-01	3.41090E-01	2.31710E-01	8.87170E-01
7.00700E+02	6.78880E-01	3.41250E-01	2.31670E-01	8.87010E-01
7.00800E+02	6.78920E-01	3.41400E-01	2.31780E-01	8.87460E-01
7.00900E+02	6.79350E-01	3.41560E-01	2.32040E-01	8.88430E-01
7.01000E+02	6.80100E-01	3.41710E-01	2.32400E-01	8.89810E-01
7.01100E+02	6.81080E-01	3.41860E-01	2.32840E-01	8.91500E-01
7.01200E+02	6.82230E-01	3.42020E-01	2.33330E-01	8.93390E-01
7.01300E+02	6.83480E-01	3.42170E-01	2.33860E-01	8.95420E-01
7.01400E+02	6.84800E-01	3.42320E-01	2.34420E-01	8.97560E-01
7.01500E+02	6.86210E-01	3.42470E-01	2.35010E-01	8.99800E-01
7.01600E+02	6.87730E-01	3.42620E-01	2.35630E-01	9.02190E-01
7.01700E+02	6.89410E-01	3.42770E-01	2.36310E-01	9.04790E-01
7.01800E+02	6.91290E-01	3.42920E-01	2.37060E-01	9.07660E-01
7.01900E+02	6.93430E-01	3.43070E-01	2.37890E-01	9.10860E-01
7.02000E+02	6.95830E-01	3.43220E-01	2.38820E-01	9.14410E-01
7.02100E+02	6.98500E-01	3.43340E-01	2.39820E-01	9.18230E-01
7.02200E+02	7.01380E-01	3.43460E-01	2.40900E-01	9.22350E-01
7.02300E+02	7.04420E-01	3.43580E-01	2.42030E-01	9.26670E-01
7.02400E+02	7.07510E-01	3.43710E-01	2.43180E-01	9.31080E-01
7.02500E+02	7.10580E-01	3.43830E-01	2.44320E-01	9.35450E-01
7.02600E+02	7.13530E-01	3.43960E-01	2.45420E-01	9.39680E-01
7.02700E+02	7.16300E-01	3.44080E-01	2.46460E-01	9.43660E-01
7.02800E+02	7.18860E-01	3.44200E-01	2.47430E-01	9.47370E-01
7.02900E+02	7.21190E-01	3.44330E-01	2.48330E-01	9.50790E-01
7.03000E+02	7.23340E-01	3.44450E-01	2.49150E-01	9.53960E-01

7.03100E+02	7.25340E-01	3.44570E-01	2.49930E-01	9.56940E-01
7.03200E+02	7.27250E-01	3.44690E-01	2.50680E-01	9.59800E-01
7.03300E+02	7.29100E-01	3.44820E-01	2.51410E-01	9.62590E-01
7.03400E+02	7.30940E-01	3.44940E-01	2.52130E-01	9.65360E-01
7.03500E+02	7.32770E-01	3.45060E-01	2.52850E-01	9.68110E-01
7.03600E+02	7.34570E-01	3.45180E-01	2.53560E-01	9.70830E-01
7.03700E+02	7.36310E-01	3.45300E-01	2.54250E-01	9.73480E-01
7.03800E+02	7.37940E-01	3.45430E-01	2.54900E-01	9.75980E-01
7.03900E+02	7.39400E-01	3.45550E-01	2.55500E-01	9.78260E-01
7.04000E+02	7.40670E-01	3.45670E-01	2.56020E-01	9.80270E-01
7.04100E+02	7.41690E-01	3.45740E-01	2.56430E-01	9.81820E-01
7.04200E+02	7.42460E-01	3.45800E-01	2.56750E-01	9.83040E-01
7.04300E+02	7.43000E-01	3.45870E-01	2.56980E-01	9.83940E-01
7.04400E+02	7.43320E-01	3.45940E-01	2.57140E-01	9.84550E-01
7.04500E+02	7.43440E-01	3.46000E-01	2.57230E-01	9.84900E-01
7.04600E+02	7.43400E-01	3.46070E-01	2.57270E-01	9.85040E-01
7.04700E+02	7.43220E-01	3.46140E-01	2.57260E-01	9.84990E-01
7.04800E+02	7.42900E-01	3.46200E-01	2.57190E-01	9.84740E-01
7.04900E+02	7.42420E-01	3.46270E-01	2.57080E-01	9.84300E-01
7.05000E+02	7.41770E-01	3.46330E-01	2.56900E-01	9.83630E-01
7.05100E+02	7.40940E-01	3.46400E-01	2.56660E-01	9.82710E-01
7.05200E+02	7.39900E-01	3.46460E-01	2.56350E-01	9.81510E-01
7.05300E+02	7.38650E-01	3.46530E-01	2.55970E-01	9.80040E-01
7.05400E+02	7.37220E-01	3.46590E-01	2.55520E-01	9.78320E-01
7.05500E+02	7.35630E-01	3.46660E-01	2.55010E-01	9.76390E-01
7.05600E+02	7.33940E-01	3.46720E-01	2.54470E-01	9.74330E-01
7.05700E+02	7.32220E-01	3.46790E-01	2.53920E-01	9.72220E-01
7.05800E+02	7.30530E-01	3.46850E-01	2.53380E-01	9.70150E-01
7.05900E+02	7.28930E-01	3.46910E-01	2.52870E-01	9.68210E-01
7.06000E+02	7.27480E-01	3.46970E-01	2.52420E-01	9.66460E-01
7.06100E+02	7.26200E-01	3.47080E-01	2.52050E-01	9.65070E-01
7.06200E+02	7.25110E-01	3.47190E-01	2.51750E-01	9.63920E-01
7.06300E+02	7.24200E-01	3.47300E-01	2.51520E-01	9.63010E-01
7.06400E+02	7.23460E-01	3.47410E-01	2.51340E-01	9.62320E-01
7.06500E+02	7.22860E-01	3.47520E-01	2.51210E-01	9.61830E-01
7.06600E+02	7.22420E-01	3.47630E-01	2.51130E-01	9.61530E-01
7.06700E+02	7.22110E-01	3.47730E-01	2.51100E-01	9.61430E-01
7.06800E+02	7.21970E-01	3.47840E-01	2.51130E-01	9.61530E-01
7.06900E+02	7.22010E-01	3.47950E-01	2.51220E-01	9.61880E-01
7.07000E+02	7.22260E-01	3.48060E-01	2.51390E-01	9.62510E-01
7.07100E+02	7.22750E-01	3.48160E-01	2.51640E-01	9.63470E-01
7.07200E+02	7.23520E-01	3.48270E-01	2.51980E-01	9.64780E-01
7.07300E+02	7.24550E-01	3.48380E-01	2.52420E-01	9.66450E-01

7.07400E+02	7.25840E-01	3.48480E-01	2.52940E-01	9.68470E-01
7.07500E+02	7.27360E-01	3.48590E-01	2.53550E-01	9.70790E-01
7.07600E+02	7.29060E-01	3.48690E-01	2.54220E-01	9.73360E-01
7.07700E+02	7.30880E-01	3.48800E-01	2.54930E-01	9.76090E-01
7.07800E+02	7.32770E-01	3.48910E-01	2.55670E-01	9.78910E-01
7.07900E+02	7.34670E-01	3.49010E-01	2.56410E-01	9.81750E-01
7.08000E+02	7.36540E-01	3.49110E-01	2.57130E-01	9.84520E-01
7.08100E+02	7.38340E-01	3.49210E-01	2.57830E-01	9.87200E-01
7.08200E+02	7.40050E-01	3.49300E-01	2.58500E-01	9.89760E-01
7.08300E+02	7.41650E-01	3.49400E-01	2.59130E-01	9.92170E-01
7.08400E+02	7.43110E-01	3.49490E-01	2.59710E-01	9.94390E-01
7.08500E+02	7.44390E-01	3.49590E-01	2.60230E-01	9.96380E-01
7.08600E+02	7.45430E-01	3.49690E-01	2.60670E-01	9.98050E-01
7.08700E+02	7.46160E-01	3.49780E-01	2.61000E-01	9.99300E-01
7.08800E+02	7.46480E-01	3.49880E-01	2.61180E-01	1.00000E+00
7.08900E+02	7.46250E-01	3.49980E-01	2.61170E-01	9.99980E-01
7.09000E+02	7.45360E-01	3.50070E-01	2.60930E-01	9.99050E-01
7.09100E+02	7.43660E-01	3.50170E-01	2.60400E-01	9.97040E-01
7.09200E+02	7.41020E-01	3.50260E-01	2.59550E-01	9.93780E-01
7.09300E+02	7.37340E-01	3.50350E-01	2.58330E-01	9.89100E-01
7.09400E+02	7.32520E-01	3.50450E-01	2.56710E-01	9.82900E-01
7.09500E+02	7.26500E-01	3.50540E-01	2.54670E-01	9.75080E-01
7.09600E+02	7.19250E-01	3.50640E-01	2.52190E-01	9.65610E-01
7.09700E+02	7.10760E-01	3.50730E-01	2.49280E-01	9.54470E-01
7.09800E+02	7.01050E-01	3.50830E-01	2.45950E-01	9.41690E-01
7.09900E+02	6.90170E-01	3.50920E-01	2.42190E-01	9.27310E-01
7.10000E+02	6.78160E-01	3.51010E-01	2.38040E-01	9.11410E-01
7.10100E+02	6.65090E-01	3.51030E-01	2.33470E-01	8.93910E-01
7.10200E+02	6.51010E-01	3.51060E-01	2.28550E-01	8.75060E-01
7.10300E+02	6.36000E-01	3.51090E-01	2.23290E-01	8.54950E-01
7.10400E+02	6.20130E-01	3.51120E-01	2.17740E-01	8.33680E-01
7.10500E+02	6.03470E-01	3.51140E-01	2.11900E-01	8.11340E-01
7.10600E+02	5.86080E-01	3.51170E-01	2.05810E-01	7.88020E-01
7.10700E+02	5.68030E-01	3.51200E-01	1.99490E-01	7.63820E-01
7.10800E+02	5.49400E-01	3.51220E-01	1.92960E-01	7.38810E-01
7.10900E+02	5.30250E-01	3.51250E-01	1.86250E-01	7.13120E-01
7.11000E+02	5.10650E-01	3.51280E-01	1.79380E-01	6.86820E-01
7.11100E+02	4.90690E-01	3.51300E-01	1.72380E-01	6.60020E-01
7.11200E+02	4.70450E-01	3.51320E-01	1.65280E-01	6.32830E-01
7.11300E+02	4.50000E-01	3.51340E-01	1.58110E-01	6.05360E-01
7.11400E+02	4.29440E-01	3.51370E-01	1.50890E-01	5.77740E-01
7.11500E+02	4.08870E-01	3.51390E-01	1.43670E-01	5.50090E-01
7.11600E+02	3.88360E-01	3.51410E-01	1.36480E-01	5.22540E-01

7.11700E+02	3.68040E-01	3.51430E-01	1.29340E-01	4.95220E-01
7.11800E+02	3.47980E-01	3.51460E-01	1.22300E-01	4.68270E-01
7.11900E+02	3.28290E-01	3.51470E-01	1.15380E-01	4.41780E-01
7.12000E+02	3.09040E-01	3.51490E-01	1.08620E-01	4.15900E-01
7.12100E+02	2.90310E-01	3.51480E-01	1.02040E-01	3.90690E-01
7.12200E+02	2.72160E-01	3.51480E-01	9.56590E-02	3.66260E-01
7.12300E+02	2.54650E-01	3.51480E-01	8.95020E-02	3.42690E-01
7.12400E+02	2.37810E-01	3.51470E-01	8.35840E-02	3.20030E-01
7.12500E+02	2.21690E-01	3.51470E-01	7.79170E-02	2.98330E-01
7.12600E+02	2.06320E-01	3.51460E-01	7.25130E-02	2.77640E-01
7.12700E+02	1.91730E-01	3.51460E-01	6.73860E-02	2.58010E-01
7.12800E+02	1.77960E-01	3.51460E-01	6.25460E-02	2.39480E-01
7.12900E+02	1.65050E-01	3.51450E-01	5.80060E-02	2.22090E-01
7.13000E+02	1.53020E-01	3.51450E-01	5.37770E-02	2.05900E-01
7.13100E+02	1.41890E-01	3.51450E-01	4.98680E-02	1.90940E-01
7.13200E+02	1.31690E-01	3.51440E-01	4.62830E-02	1.77210E-01
7.13300E+02	1.22410E-01	3.51440E-01	4.30190E-02	1.64710E-01
7.13400E+02	1.14010E-01	3.51440E-01	4.00660E-02	1.53410E-01
7.13500E+02	1.06440E-01	3.51430E-01	3.74060E-02	1.43220E-01
7.13600E+02	9.96200E-02	3.51430E-01	3.50090E-02	1.34050E-01
7.13700E+02	9.34570E-02	3.51430E-01	3.28430E-02	1.25750E-01
7.13800E+02	8.78390E-02	3.51430E-01	3.08690E-02	1.18190E-01
7.13900E+02	8.26520E-02	3.51430E-01	2.90470E-02	1.11210E-01
7.14000E+02	7.77880E-02	3.51440E-01	2.73380E-02	1.04670E-01
7.14100E+02	7.31560E-02	3.51370E-01	2.57050E-02	9.84210E-02
7.14200E+02	6.86860E-02	3.51310E-01	2.41300E-02	9.23900E-02
7.14300E+02	6.43340E-02	3.51250E-01	2.25970E-02	8.65200E-02
7.14400E+02	6.00840E-02	3.51180E-01	2.11010E-02	8.07910E-02
7.14500E+02	5.59470E-02	3.51120E-01	1.96440E-02	7.52140E-02
7.14600E+02	5.19520E-02	3.51060E-01	1.82380E-02	6.98300E-02
7.14700E+02	4.81390E-02	3.50990E-01	1.68970E-02	6.46940E-02
7.14800E+02	4.45570E-02	3.50930E-01	1.56360E-02	5.98690E-02
7.14900E+02	4.12500E-02	3.50870E-01	1.44730E-02	5.54150E-02
7.15000E+02	3.82510E-02	3.50800E-01	1.34180E-02	5.13770E-02
7.15100E+02	3.55790E-02	3.50740E-01	1.24790E-02	4.77800E-02
7.15200E+02	3.32360E-02	3.50670E-01	1.16550E-02	4.46240E-02
7.15300E+02	3.29510E-02	3.50610E-01	1.15530E-02	4.42340E-02
7.15400E+02	3.02030E-02	3.50540E-01	1.05870E-02	4.05370E-02
7.15500E+02	2.88400E-02	3.50480E-01	1.01080E-02	3.87000E-02
7.15600E+02	2.78880E-02	3.50410E-01	9.77220E-03	3.74160E-02
7.15700E+02	2.58990E-02	3.50360E-01	9.07390E-03	3.47420E-02
7.15800E+02	2.44750E-02	3.50310E-01	8.57400E-03	3.28280E-02
7.15900E+02	2.34160E-02	3.50260E-01	8.20160E-03	3.14020E-02

7.16000E+02	2.25120E-02	3.50210E-01	7.88400E-03	3.01870E-02
7.16100E+02	2.15510E-02	3.50250E-01	7.54830E-03	2.89010E-02
7.16200E+02	2.05140E-02	3.50280E-01	7.18570E-03	2.75130E-02
7.16300E+02	1.95760E-02	3.50320E-01	6.85770E-03	2.62570E-02
7.16400E+02	1.87090E-02	3.50350E-01	6.55470E-03	2.50970E-02
7.16500E+02	1.78860E-02	3.50380E-01	6.26710E-03	2.39950E-02
7.16600E+02	1.70840E-02	3.50420E-01	5.98650E-03	2.29210E-02
7.16700E+02	1.62840E-02	3.50450E-01	5.70670E-03	2.18500E-02
7.16800E+02	1.54770E-02	3.50480E-01	5.42450E-03	2.07700E-02
7.16900E+02	1.46650E-02	3.50520E-01	5.14020E-03	1.96810E-02
7.17000E+02	1.38560E-02	3.50550E-01	4.85720E-03	1.85970E-02
7.17100E+02	1.30690E-02	3.50580E-01	4.58180E-03	1.75430E-02
7.17200E+02	1.23260E-02	3.50610E-01	4.32160E-03	1.65470E-02
7.17300E+02	1.16480E-02	3.50650E-01	4.08440E-03	1.56380E-02
7.17400E+02	1.10530E-02	3.50680E-01	3.87590E-03	1.48400E-02
7.17500E+02	1.05480E-02	3.50710E-01	3.69920E-03	1.41640E-02
7.17600E+02	1.01310E-02	3.50750E-01	3.55360E-03	1.36060E-02
7.17700E+02	9.78940E-03	3.50820E-01	3.43430E-03	1.31490E-02
7.17800E+02	9.49820E-03	3.50890E-01	3.33280E-03	1.27610E-02
7.17900E+02	9.22830E-03	3.50960E-01	3.23870E-03	1.24000E-02
7.18000E+02	8.94890E-03	3.51020E-01	3.14130E-03	1.20270E-02
7.18100E+02	8.63410E-03	3.51040E-01	3.03090E-03	1.16050E-02
7.18200E+02	8.26760E-03	3.51050E-01	2.90240E-03	1.11130E-02
7.18300E+02	7.84610E-03	3.51070E-01	2.75450E-03	1.05470E-02
7.18400E+02	7.38030E-03	3.51090E-01	2.59110E-03	9.92090E-03
7.18500E+02	6.89340E-03	3.51100E-01	2.42030E-03	9.26680E-03
7.18600E+02	6.41680E-03	3.51120E-01	2.25310E-03	8.62650E-03
7.18700E+02	5.98440E-03	3.51130E-01	2.10130E-03	8.04550E-03
7.18800E+02	5.62560E-03	3.51150E-01	1.97540E-03	7.56360E-03
7.18900E+02	5.35980E-03	3.51160E-01	1.88220E-03	7.20650E-03
7.19000E+02	5.19170E-03	3.51180E-01	1.82320E-03	6.98080E-03
7.19100E+02	5.10990E-03	3.51190E-01	1.79460E-03	6.87110E-03
7.19200E+02	5.08850E-03	3.51210E-01	1.78710E-03	6.84250E-03
7.19300E+02	5.09140E-03	3.51220E-01	1.78820E-03	6.84680E-03
7.19400E+02	5.07910E-03	3.51230E-01	1.78390E-03	6.83040E-03
7.19500E+02	5.01550E-03	3.51250E-01	1.76170E-03	6.74530E-03
7.19600E+02	4.87560E-03	3.51300E-01	1.71280E-03	6.55800E-03
7.19700E+02	4.64950E-03	3.51360E-01	1.63360E-03	6.25490E-03
7.19800E+02	4.34530E-03	3.51410E-01	1.52700E-03	5.84660E-03
7.19900E+02	3.98720E-03	3.51460E-01	1.40130E-03	5.36550E-03
7.20000E+02	3.61130E-03	3.51510E-01	1.26940E-03	4.86030E-03
7.20100E+02	3.25880E-03	3.51530E-01	1.14560E-03	4.38620E-03
7.20200E+02	2.96890E-03	3.51550E-01	1.04370E-03	3.99620E-03

7.20300E+02	2.77120E-03	3.51570E-01	9.74270E-04	3.73030E-03
7.20400E+02	2.68050E-03	3.51590E-01	9.42440E-04	3.60840E-03
7.20500E+02	2.69480E-03	3.51610E-01	9.47500E-04	3.62780E-03
7.20600E+02	2.79560E-03	3.51630E-01	9.83030E-04	3.76380E-03
7.20700E+02	2.95270E-03	3.51650E-01	1.03830E-03	3.97550E-03
7.20800E+02	3.12920E-03	3.51670E-01	1.10040E-03	4.21340E-03
7.20900E+02	3.28950E-03	3.51680E-01	1.15690E-03	4.42940E-03
7.21000E+02	3.40470E-03	3.51700E-01	1.19740E-03	4.58480E-03
7.21100E+02	3.45800E-03	3.51720E-01	1.21630E-03	4.65680E-03
7.21200E+02	3.44630E-03	3.51740E-01	1.21220E-03	4.64140E-03
7.21300E+02	3.37950E-03	3.51760E-01	1.18880E-03	4.55170E-03
7.21400E+02	3.27700E-03	3.51780E-01	1.15280E-03	4.41380E-03
7.21500E+02	3.16240E-03	3.51820E-01	1.11260E-03	4.25990E-03
7.21600E+02	3.05840E-03	3.51850E-01	1.07610E-03	4.12020E-03
7.21700E+02	2.98150E-03	3.51890E-01	1.04920E-03	4.01700E-03
7.21800E+02	2.93910E-03	3.51920E-01	1.03430E-03	3.96030E-03
7.21900E+02	2.81860E-03	3.51960E-01	9.92040E-04	3.79830E-03
7.22000E+02	2.69920E-03	3.51990E-01	9.50120E-04	3.63780E-03
7.22100E+02	2.57200E-03	3.52080E-01	9.05560E-04	3.46720E-03
7.22200E+02	2.45060E-03	3.52170E-01	8.63020E-04	3.30440E-03
7.22300E+02	2.33240E-03	3.52260E-01	8.21620E-04	3.14580E-03
7.22400E+02	2.21240E-03	3.52350E-01	7.79530E-04	2.98470E-03
7.22500E+02	2.09860E-03	3.52440E-01	7.39640E-04	2.83190E-03
7.22600E+02	1.84830E-03	3.52530E-01	6.51560E-04	2.49470E-03
7.22700E+02	1.58280E-03	3.52620E-01	5.58130E-04	2.13700E-03
7.22800E+02	1.36470E-03	3.52710E-01	4.81330E-04	1.84290E-03
7.22900E+02	1.16460E-03	3.52800E-01	4.10890E-04	1.57320E-03
7.23000E+02	9.75890E-04	3.52890E-01	3.44380E-04	1.31860E-03
7.23100E+02	0.00000E+00	3.52980E-01	0.00000E+00	0.00000E+00

Channel 5

Wavenumber	HIRS Filter Transmittance	Optical Element Transmittance	Product of the HIRS Filter and Optical Element Transmittances	Normalized Value of Column 4
6.94800E+02	0.00000E+00	3.32760E-01	0.00000E+00	0.00000E+00
6.94900E+02	8.02990E-04	3.32940E-01	2.67350E-04	9.23620E-04
6.95000E+02	1.17250E-03	3.33110E-01	3.90580E-04	1.34940E-03
6.95100E+02	1.18480E-03	3.33280E-01	3.94890E-04	1.36430E-03
6.95200E+02	8.55810E-04	3.33450E-01	2.85370E-04	9.85900E-04
6.95300E+02	2.56220E-04	3.33620E-01	8.54810E-05	2.95320E-04
6.95400E+02	5.07980E-04	3.33790E-01	1.69560E-04	5.85800E-04
6.95500E+02	1.29650E-03	3.33970E-01	4.32980E-04	1.49590E-03
6.95600E+02	1.98240E-03	3.34140E-01	6.62390E-04	2.28840E-03

6.95700E+02	2.45950E-03	3.34310E-01	8.22230E-04	2.84060E-03
6.95800E+02	2.66470E-03	3.34480E-01	8.91280E-04	3.07920E-03
6.95900E+02	1.29000E-03	3.34650E-01	4.31700E-04	1.49140E-03
6.96000E+02	1.34900E-03	3.34820E-01	4.51680E-04	1.56050E-03
6.96100E+02	1.40070E-03	3.34980E-01	4.69220E-04	1.62110E-03
6.96200E+02	1.45320E-03	3.35130E-01	4.87000E-04	1.68250E-03
6.96300E+02	1.51360E-03	3.35290E-01	5.07480E-04	1.75320E-03
6.96400E+02	1.58770E-03	3.35450E-01	5.32610E-04	1.84010E-03
6.96500E+02	1.63160E-03	3.35630E-01	5.47600E-04	1.89190E-03
6.96600E+02	1.62010E-03	3.35800E-01	5.44030E-04	1.87950E-03
6.96700E+02	1.56310E-03	3.35970E-01	5.25140E-04	1.81420E-03
6.96800E+02	1.47840E-03	3.36140E-01	4.96950E-04	1.71690E-03
6.96900E+02	1.38890E-03	3.36310E-01	4.67100E-04	1.61370E-03
6.97000E+02	1.31780E-03	3.36480E-01	4.43400E-04	1.53190E-03
6.97100E+02	1.28440E-03	3.36650E-01	4.32380E-04	1.49380E-03
6.97200E+02	1.30090E-03	3.36820E-01	4.38180E-04	1.51380E-03
6.97300E+02	1.37060E-03	3.36990E-01	4.61900E-04	1.59580E-03
6.97400E+02	1.48760E-03	3.37170E-01	5.01570E-04	1.73280E-03
6.97500E+02	1.63860E-03	3.37340E-01	5.52770E-04	1.90970E-03
6.97600E+02	1.80620E-03	3.37510E-01	6.09610E-04	2.10610E-03
6.97700E+02	1.97250E-03	3.37680E-01	6.66080E-04	2.30120E-03
6.97800E+02	2.12290E-03	3.37850E-01	7.17240E-04	2.47790E-03
6.97900E+02	2.24920E-03	3.38020E-01	7.60270E-04	2.62660E-03
6.98000E+02	2.35070E-03	3.38190E-01	7.95000E-04	2.74660E-03
6.98100E+02	2.43480E-03	3.38290E-01	8.23660E-04	2.84560E-03
6.98200E+02	2.51480E-03	3.38380E-01	8.50950E-04	2.93990E-03
6.98300E+02	2.60760E-03	3.38470E-01	8.82580E-04	3.04910E-03
6.98400E+02	2.72980E-03	3.38570E-01	9.24250E-04	3.19310E-03
6.98500E+02	2.89520E-03	3.38670E-01	9.80520E-04	3.38750E-03
6.98600E+02	3.11130E-03	3.38770E-01	1.05400E-03	3.64150E-03
6.98700E+02	3.37890E-03	3.38880E-01	1.14500E-03	3.95580E-03
6.98800E+02	3.69170E-03	3.38980E-01	1.25140E-03	4.32340E-03
6.98900E+02	4.03840E-03	3.39080E-01	1.36930E-03	4.73070E-03
6.99000E+02	4.40480E-03	3.39180E-01	1.49400E-03	5.16150E-03
6.99100E+02	4.77750E-03	3.39280E-01	1.62090E-03	5.59990E-03
6.99200E+02	5.14630E-03	3.39380E-01	1.74660E-03	6.03410E-03
6.99300E+02	5.50710E-03	3.39490E-01	1.86960E-03	6.45900E-03
6.99400E+02	5.86230E-03	3.39590E-01	1.99070E-03	6.87760E-03
6.99500E+02	6.22100E-03	3.39690E-01	2.11320E-03	7.30070E-03
6.99600E+02	6.59770E-03	3.39790E-01	2.24180E-03	7.74510E-03
6.99700E+02	7.00920E-03	3.39890E-01	2.38240E-03	8.23060E-03
6.99800E+02	7.47210E-03	3.39990E-01	2.54040E-03	8.77670E-03
6.99900E+02	7.99990E-03	3.40090E-01	2.72070E-03	9.39940E-03

7.00000E+02	8.60070E-03	3.40190E-01	2.92590E-03	1.01080E-02
7.00100E+02	9.27610E-03	3.40330E-01	3.15690E-03	1.09060E-02
7.00200E+02	1.00210E-02	3.40460E-01	3.41190E-03	1.17870E-02
7.00300E+02	1.08260E-02	3.40620E-01	3.68770E-03	1.27400E-02
7.00400E+02	1.01940E-02	3.40780E-01	3.47380E-03	1.20010E-02
7.00500E+02	1.08000E-02	3.40940E-01	3.68220E-03	1.27210E-02
7.00600E+02	1.15830E-02	3.41090E-01	3.95080E-03	1.36490E-02
7.00700E+02	1.25630E-02	3.41250E-01	4.28710E-03	1.48110E-02
7.00800E+02	1.37360E-02	3.41400E-01	4.68950E-03	1.62010E-02
7.00900E+02	1.50690E-02	3.41560E-01	5.14700E-03	1.77820E-02
7.01000E+02	1.65100E-02	3.41710E-01	5.64170E-03	1.94910E-02
7.01100E+02	1.79940E-02	3.41860E-01	6.15150E-03	2.12520E-02
7.01200E+02	1.94570E-02	3.42020E-01	6.65470E-03	2.29910E-02
7.01300E+02	2.08460E-02	3.42170E-01	7.13300E-03	2.46430E-02
7.01400E+02	2.21310E-02	3.42320E-01	7.57590E-03	2.61730E-02
7.01500E+02	2.33080E-02	3.42470E-01	7.98240E-03	2.75780E-02
7.01600E+02	2.44050E-02	3.42620E-01	8.36170E-03	2.88880E-02
7.01700E+02	2.54750E-02	3.42770E-01	8.73220E-03	3.01680E-02
7.01800E+02	2.65940E-02	3.42920E-01	9.11960E-03	3.15060E-02
7.01900E+02	2.78450E-02	3.43070E-01	9.55290E-03	3.30030E-02
7.02000E+02	2.93140E-02	3.43220E-01	1.00610E-02	3.47590E-02
7.02100E+02	3.10720E-02	3.43340E-01	1.06680E-02	3.68560E-02
7.02200E+02	3.31740E-02	3.43460E-01	1.13940E-02	3.93630E-02
7.02300E+02	3.56470E-02	3.43580E-01	1.22480E-02	4.23140E-02
7.02400E+02	3.84970E-02	3.43710E-01	1.32320E-02	4.57130E-02
7.02500E+02	4.17050E-02	3.43830E-01	1.43390E-02	4.95400E-02
7.02600E+02	4.52390E-02	3.43960E-01	1.55600E-02	5.37570E-02
7.02700E+02	4.90630E-02	3.44080E-01	1.68810E-02	5.83220E-02
7.02800E+02	5.31430E-02	3.44200E-01	1.82920E-02	6.31950E-02
7.02900E+02	5.74600E-02	3.44330E-01	1.97850E-02	6.83530E-02
7.03000E+02	6.20150E-02	3.44450E-01	2.13610E-02	7.37980E-02
7.03100E+02	6.68310E-02	3.44570E-01	2.30280E-02	7.95570E-02
7.03200E+02	7.19510E-02	3.44690E-01	2.48010E-02	8.56820E-02
7.03300E+02	7.74370E-02	3.44820E-01	2.67010E-02	9.22480E-02
7.03400E+02	8.33610E-02	3.44940E-01	2.87540E-02	9.93400E-02
7.03500E+02	8.97960E-02	3.45060E-01	3.09850E-02	1.07050E-01
7.03600E+02	9.68110E-02	3.45180E-01	3.34180E-02	1.15450E-01
7.03700E+02	1.04460E-01	3.45300E-01	3.60720E-02	1.24620E-01
7.03800E+02	1.12790E-01	3.45430E-01	3.89620E-02	1.34610E-01
7.03900E+02	1.21830E-01	3.45550E-01	4.20980E-02	1.45440E-01
7.04000E+02	1.31590E-01	3.45670E-01	4.54860E-02	1.57140E-01
7.04100E+02	1.42070E-01	3.45740E-01	4.91200E-02	1.69700E-01
7.04200E+02	1.53290E-01	3.45800E-01	5.30080E-02	1.83130E-01

7.04300E+02	1.65250E-01	3.45870E-01	5.71540E-02	1.97460E-01
7.04400E+02	1.77960E-01	3.45940E-01	6.15610E-02	2.12680E-01
7.04500E+02	1.91430E-01	3.46000E-01	6.62370E-02	2.28830E-01
7.04600E+02	2.05700E-01	3.46070E-01	7.11860E-02	2.45930E-01
7.04700E+02	2.20770E-01	3.46140E-01	7.64160E-02	2.64000E-01
7.04800E+02	2.36640E-01	3.46200E-01	8.19260E-02	2.83040E-01
7.04900E+02	2.53310E-01	3.46270E-01	8.77120E-02	3.03030E-01
7.05000E+02	2.70730E-01	3.46330E-01	9.37620E-02	3.23930E-01
7.05100E+02	2.88840E-01	3.46400E-01	1.00050E-01	3.45670E-01
7.05200E+02	3.07560E-01	3.46460E-01	1.06560E-01	3.68140E-01
7.05300E+02	3.26800E-01	3.46530E-01	1.13240E-01	3.91240E-01
7.05400E+02	3.46440E-01	3.46590E-01	1.20070E-01	4.14830E-01
7.05500E+02	3.66390E-01	3.46660E-01	1.27010E-01	4.38800E-01
7.05600E+02	3.86560E-01	3.46720E-01	1.34030E-01	4.63040E-01
7.05700E+02	4.06880E-01	3.46790E-01	1.41100E-01	4.87480E-01
7.05800E+02	4.27320E-01	3.46850E-01	1.48220E-01	5.12060E-01
7.05900E+02	4.47840E-01	3.46910E-01	1.55360E-01	5.36740E-01
7.06000E+02	4.68430E-01	3.46970E-01	1.62530E-01	5.61520E-01
7.06100E+02	4.89060E-01	3.47080E-01	1.69740E-01	5.86430E-01
7.06200E+02	5.09690E-01	3.47190E-01	1.76960E-01	6.11360E-01
7.06300E+02	5.30260E-01	3.47300E-01	1.84160E-01	6.36230E-01
7.06400E+02	5.50650E-01	3.47410E-01	1.91300E-01	6.60910E-01
7.06500E+02	5.70730E-01	3.47520E-01	1.98340E-01	6.85230E-01
7.06600E+02	5.90330E-01	3.47630E-01	2.05220E-01	7.08980E-01
7.06700E+02	6.09260E-01	3.47730E-01	2.11860E-01	7.31940E-01
7.06800E+02	6.27330E-01	3.47840E-01	2.18210E-01	7.53870E-01
7.06900E+02	6.44370E-01	3.47950E-01	2.24210E-01	7.74600E-01
7.07000E+02	6.60270E-01	3.48060E-01	2.29810E-01	7.93950E-01
7.07100E+02	6.74940E-01	3.48160E-01	2.34990E-01	8.11840E-01
7.07200E+02	6.88390E-01	3.48270E-01	2.39740E-01	8.28270E-01
7.07300E+02	7.00640E-01	3.48380E-01	2.44090E-01	8.43270E-01
7.07400E+02	7.11800E-01	3.48480E-01	2.48050E-01	8.56960E-01
7.07500E+02	7.21970E-01	3.48590E-01	2.51670E-01	8.69470E-01
7.07600E+02	7.31270E-01	3.48690E-01	2.54990E-01	8.80930E-01
7.07700E+02	7.39780E-01	3.48800E-01	2.58040E-01	8.91470E-01
7.07800E+02	7.47580E-01	3.48910E-01	2.60840E-01	9.01140E-01
7.07900E+02	7.54670E-01	3.49010E-01	2.63390E-01	9.09970E-01
7.08000E+02	7.61030E-01	3.49110E-01	2.65680E-01	9.17880E-01
7.08100E+02	7.66580E-01	3.49210E-01	2.67690E-01	9.24830E-01
7.08200E+02	7.71230E-01	3.49300E-01	2.69390E-01	9.30700E-01
7.08300E+02	7.74910E-01	3.49400E-01	2.70750E-01	9.35390E-01
7.08400E+02	7.77550E-01	3.49490E-01	2.71750E-01	9.38850E-01
7.08500E+02	7.79160E-01	3.49590E-01	2.72390E-01	9.41050E-01

7.08600E+02	7.79770E-01	3.49690E-01	2.72680E-01	9.42040E-01
7.08700E+02	7.79480E-01	3.49780E-01	2.72650E-01	9.41950E-01
7.08800E+02	7.78460E-01	3.49880E-01	2.72370E-01	9.40970E-01
7.08900E+02	7.76860E-01	3.49980E-01	2.71880E-01	9.39300E-01
7.09000E+02	7.74900E-01	3.50070E-01	2.71270E-01	9.37190E-01
7.09100E+02	7.72750E-01	3.50170E-01	2.70590E-01	9.34840E-01
7.09200E+02	7.70550E-01	3.50260E-01	2.69890E-01	9.32420E-01
7.09300E+02	7.68400E-01	3.50350E-01	2.69210E-01	9.30070E-01
7.09400E+02	7.66330E-01	3.50450E-01	2.68560E-01	9.27820E-01
7.09500E+02	7.64340E-01	3.50540E-01	2.67930E-01	9.25660E-01
7.09600E+02	7.62390E-01	3.50640E-01	2.67320E-01	9.23540E-01
7.09700E+02	7.60390E-01	3.50730E-01	2.66690E-01	9.21370E-01
7.09800E+02	7.58290E-01	3.50830E-01	2.66030E-01	9.19070E-01
7.09900E+02	7.56030E-01	3.50920E-01	2.65300E-01	9.16570E-01
7.10000E+02	7.53590E-01	3.51010E-01	2.64520E-01	9.13850E-01
7.10100E+02	7.50990E-01	3.51030E-01	2.63620E-01	9.10770E-01
7.10200E+02	7.48290E-01	3.51060E-01	2.62690E-01	9.07560E-01
7.10300E+02	7.45560E-01	3.51090E-01	2.61760E-01	9.04320E-01
7.10400E+02	7.42910E-01	3.51120E-01	2.60850E-01	9.01180E-01
7.10500E+02	7.40420E-01	3.51140E-01	2.59990E-01	8.98230E-01
7.10600E+02	7.38180E-01	3.51170E-01	2.59230E-01	8.95570E-01
7.10700E+02	7.36220E-01	3.51200E-01	2.58560E-01	8.93260E-01
7.10800E+02	7.34540E-01	3.51220E-01	2.57990E-01	8.91300E-01
7.10900E+02	7.33130E-01	3.51250E-01	2.57510E-01	8.89660E-01
7.11000E+02	7.31930E-01	3.51280E-01	2.57110E-01	8.88260E-01
7.11100E+02	7.30850E-01	3.51300E-01	2.56750E-01	8.87020E-01
7.11200E+02	7.29840E-01	3.51320E-01	2.56410E-01	8.85840E-01
7.11300E+02	7.28820E-01	3.51340E-01	2.56070E-01	8.84660E-01
7.11400E+02	7.27760E-01	3.51370E-01	2.55710E-01	8.83430E-01
7.11500E+02	7.26640E-01	3.51390E-01	2.55340E-01	8.82130E-01
7.11600E+02	7.25510E-01	3.51410E-01	2.54950E-01	8.80810E-01
7.11700E+02	7.24390E-01	3.51430E-01	2.54580E-01	8.79510E-01
7.11800E+02	7.23370E-01	3.51460E-01	2.54230E-01	8.78330E-01
7.11900E+02	7.22520E-01	3.51470E-01	2.53940E-01	8.77330E-01
7.12000E+02	7.21900E-01	3.51490E-01	2.53740E-01	8.76610E-01
7.12100E+02	7.21560E-01	3.51480E-01	2.53620E-01	8.76200E-01
7.12200E+02	7.21540E-01	3.51480E-01	2.53610E-01	8.76160E-01
7.12300E+02	7.21820E-01	3.51480E-01	2.53700E-01	8.76490E-01
7.12400E+02	7.22370E-01	3.51470E-01	2.53890E-01	8.77160E-01
7.12500E+02	7.23160E-01	3.51470E-01	2.54170E-01	8.78100E-01
7.12600E+02	7.24100E-01	3.51460E-01	2.54500E-01	8.79240E-01
7.12700E+02	7.25140E-01	3.51460E-01	2.54860E-01	8.80480E-01
7.12800E+02	7.26200E-01	3.51460E-01	2.55230E-01	8.81770E-01

7.12900E+02	7.27250E-01	3.51450E-01	2.55590E-01	8.83030E-01
7.13000E+02	7.28250E-01	3.51450E-01	2.55940E-01	8.84240E-01
7.13100E+02	7.29210E-01	3.51450E-01	2.56280E-01	8.85390E-01
7.13200E+02	7.30130E-01	3.51440E-01	2.56600E-01	8.86500E-01
7.13300E+02	7.31080E-01	3.51440E-01	2.56930E-01	8.87640E-01
7.13400E+02	7.32100E-01	3.51440E-01	2.57290E-01	8.88870E-01
7.13500E+02	7.33260E-01	3.51430E-01	2.57690E-01	8.90270E-01
7.13600E+02	7.34610E-01	3.51430E-01	2.58160E-01	8.91900E-01
7.13700E+02	7.36200E-01	3.51430E-01	2.58720E-01	8.93830E-01
7.13800E+02	7.38060E-01	3.51430E-01	2.59370E-01	8.96090E-01
7.13900E+02	7.40190E-01	3.51430E-01	2.60130E-01	8.98680E-01
7.14000E+02	7.42560E-01	3.51440E-01	2.60960E-01	9.01580E-01
7.14100E+02	7.45130E-01	3.51370E-01	2.61820E-01	9.04540E-01
7.14200E+02	7.47840E-01	3.51310E-01	2.62720E-01	9.07660E-01
7.14300E+02	7.50600E-01	3.51250E-01	2.63650E-01	9.10850E-01
7.14400E+02	7.53350E-01	3.51180E-01	2.64570E-01	9.14020E-01
7.14500E+02	7.56030E-01	3.51120E-01	2.65460E-01	9.17100E-01
7.14600E+02	7.58580E-01	3.51060E-01	2.66300E-01	9.20030E-01
7.14700E+02	7.60990E-01	3.50990E-01	2.67100E-01	9.22790E-01
7.14800E+02	7.63280E-01	3.50930E-01	2.67860E-01	9.25390E-01
7.14900E+02	7.65470E-01	3.50870E-01	2.68580E-01	9.27890E-01
7.15000E+02	7.67640E-01	3.50800E-01	2.69290E-01	9.30340E-01
7.15100E+02	7.69830E-01	3.50740E-01	2.70010E-01	9.32830E-01
7.15200E+02	7.72130E-01	3.50670E-01	2.70760E-01	9.35430E-01
7.15300E+02	7.74560E-01	3.50610E-01	2.71570E-01	9.38210E-01
7.15400E+02	7.77160E-01	3.50540E-01	2.72430E-01	9.41190E-01
7.15500E+02	7.79930E-01	3.50480E-01	2.73350E-01	9.44370E-01
7.15600E+02	7.82840E-01	3.50410E-01	2.74320E-01	9.47710E-01
7.15700E+02	7.85820E-01	3.50360E-01	2.75320E-01	9.51170E-01
7.15800E+02	7.88800E-01	3.50310E-01	2.76330E-01	9.54650E-01
7.15900E+02	7.91720E-01	3.50260E-01	2.77310E-01	9.58050E-01
7.16000E+02	7.94500E-01	3.50210E-01	2.78250E-01	9.61290E-01
7.16100E+02	7.97120E-01	3.50250E-01	2.79190E-01	9.64540E-01
7.16200E+02	7.99540E-01	3.50280E-01	2.80060E-01	9.67570E-01
7.16300E+02	8.01790E-01	3.50320E-01	2.80880E-01	9.70390E-01
7.16400E+02	8.03920E-01	3.50350E-01	2.81650E-01	9.73050E-01
7.16500E+02	8.05960E-01	3.50380E-01	2.82390E-01	9.75620E-01
7.16600E+02	8.07980E-01	3.50420E-01	2.83130E-01	9.78160E-01
7.16700E+02	8.10030E-01	3.50450E-01	2.83870E-01	9.80730E-01
7.16800E+02	8.12110E-01	3.50480E-01	2.84630E-01	9.83350E-01
7.16900E+02	8.14230E-01	3.50520E-01	2.85400E-01	9.86000E-01
7.17000E+02	8.16340E-01	3.50550E-01	2.86170E-01	9.88650E-01
7.17100E+02	8.18360E-01	3.50580E-01	2.86900E-01	9.91190E-01

7.17200E+02	8.20220E-01	3.50610E-01	2.87580E-01	9.93530E-01
7.17300E+02	8.21830E-01	3.50650E-01	2.88170E-01	9.95570E-01
7.17400E+02	8.23120E-01	3.50680E-01	2.88650E-01	9.97230E-01
7.17500E+02	8.24060E-01	3.50710E-01	2.89010E-01	9.98460E-01
7.17600E+02	8.24640E-01	3.50750E-01	2.89250E-01	9.99290E-01
7.17700E+02	8.24900E-01	3.50820E-01	2.89390E-01	9.99800E-01
7.17800E+02	8.24910E-01	3.50890E-01	2.89450E-01	1.00000E+00
7.17900E+02	8.24750E-01	3.50960E-01	2.89450E-01	1.00000E+00
7.18000E+02	8.24510E-01	3.51020E-01	2.89420E-01	9.99900E-01
7.18100E+02	8.24270E-01	3.51040E-01	2.89350E-01	9.99650E-01
7.18200E+02	8.24070E-01	3.51050E-01	2.89290E-01	9.99450E-01
7.18300E+02	8.23920E-01	3.51070E-01	2.89250E-01	9.99310E-01
7.18400E+02	8.23780E-01	3.51090E-01	2.89220E-01	9.99190E-01
7.18500E+02	8.23580E-01	3.51100E-01	2.89160E-01	9.98990E-01
7.18600E+02	8.23220E-01	3.51120E-01	2.89050E-01	9.98600E-01
7.18700E+02	8.22600E-01	3.51130E-01	2.88840E-01	9.97890E-01
7.18800E+02	8.21640E-01	3.51150E-01	2.88520E-01	9.96770E-01
7.18900E+02	8.20270E-01	3.51160E-01	2.88050E-01	9.95140E-01
7.19000E+02	8.18450E-01	3.51180E-01	2.87420E-01	9.92990E-01
7.19100E+02	8.16210E-01	3.51190E-01	2.86650E-01	9.90310E-01
7.19200E+02	8.13590E-01	3.51210E-01	2.85740E-01	9.87170E-01
7.19300E+02	8.10640E-01	3.51220E-01	2.84710E-01	9.83620E-01
7.19400E+02	8.07420E-01	3.51230E-01	2.83590E-01	9.79760E-01
7.19500E+02	8.03990E-01	3.51250E-01	2.82400E-01	9.75650E-01
7.19600E+02	8.00360E-01	3.51300E-01	2.81170E-01	9.71380E-01
7.19700E+02	7.96490E-01	3.51360E-01	2.79850E-01	9.66840E-01
7.19800E+02	7.92340E-01	3.51410E-01	2.78430E-01	9.61930E-01
7.19900E+02	7.87790E-01	3.51460E-01	2.76880E-01	9.56550E-01
7.20000E+02	7.82720E-01	3.51510E-01	2.75140E-01	9.50540E-01
7.20100E+02	7.77010E-01	3.51530E-01	2.73140E-01	9.43660E-01
7.20200E+02	7.70560E-01	3.51550E-01	2.70890E-01	9.35870E-01
7.20300E+02	7.63280E-01	3.51570E-01	2.68350E-01	9.27090E-01
7.20400E+02	7.55160E-01	3.51590E-01	2.65500E-01	9.17260E-01
7.20500E+02	7.46190E-01	3.51610E-01	2.62370E-01	9.06420E-01
7.20600E+02	7.36440E-01	3.51630E-01	2.58950E-01	8.94630E-01
7.20700E+02	7.25980E-01	3.51650E-01	2.55290E-01	8.81980E-01
7.20800E+02	7.14910E-01	3.51670E-01	2.51410E-01	8.68570E-01
7.20900E+02	7.03310E-01	3.51680E-01	2.47340E-01	8.54520E-01
7.21000E+02	6.91240E-01	3.51700E-01	2.43110E-01	8.39900E-01
7.21100E+02	6.78710E-01	3.51720E-01	2.38720E-01	8.24730E-01
7.21200E+02	6.65740E-01	3.51740E-01	2.34170E-01	8.09010E-01
7.21300E+02	6.52260E-01	3.51760E-01	2.29440E-01	7.92680E-01
7.21400E+02	6.38230E-01	3.51780E-01	2.24520E-01	7.75670E-01

7.21500E+02	6.23580E-01	3.51820E-01	2.19390E-01	7.57930E-01
7.21600E+02	6.08250E-01	3.51850E-01	2.14010E-01	7.39380E-01
7.21700E+02	5.92210E-01	3.51890E-01	2.08390E-01	7.19950E-01
7.21800E+02	5.75470E-01	3.51920E-01	2.02520E-01	6.99670E-01
7.21900E+02	5.58070E-01	3.51960E-01	1.96420E-01	6.78590E-01
7.22000E+02	5.40100E-01	3.51990E-01	1.90110E-01	6.56800E-01
7.22100E+02	5.21660E-01	3.52080E-01	1.83670E-01	6.34530E-01
7.22200E+02	5.02870E-01	3.52170E-01	1.77100E-01	6.11840E-01
7.22300E+02	4.83880E-01	3.52260E-01	1.70450E-01	5.88890E-01
7.22400E+02	4.64820E-01	3.52350E-01	1.63780E-01	5.65830E-01
7.22500E+02	4.45800E-01	3.52440E-01	1.57120E-01	5.42820E-01
7.22600E+02	4.26930E-01	3.52530E-01	1.50500E-01	5.19960E-01
7.22700E+02	4.08270E-01	3.52620E-01	1.43960E-01	4.97360E-01
7.22800E+02	3.89890E-01	3.52710E-01	1.37520E-01	4.75100E-01
7.22900E+02	3.71840E-01	3.52800E-01	1.31190E-01	4.53220E-01
7.23000E+02	3.54160E-01	3.52890E-01	1.24980E-01	4.31780E-01
7.23100E+02	3.36880E-01	3.52980E-01	1.18910E-01	4.10810E-01
7.23200E+02	3.20010E-01	3.53070E-01	1.12980E-01	3.90340E-01
7.23300E+02	3.03570E-01	3.53160E-01	1.07210E-01	3.70390E-01
7.23400E+02	2.87590E-01	3.53260E-01	1.01590E-01	3.50980E-01
7.23500E+02	2.72060E-01	3.53360E-01	9.61340E-02	3.32120E-01
7.23600E+02	2.56980E-01	3.53470E-01	9.08340E-02	3.13810E-01
7.23700E+02	2.42360E-01	3.53580E-01	8.56910E-02	2.96050E-01
7.23800E+02	2.28180E-01	3.53690E-01	8.07050E-02	2.78820E-01
7.23900E+02	2.14470E-01	3.53790E-01	7.58780E-02	2.62140E-01
7.24000E+02	2.01230E-01	3.53900E-01	7.12150E-02	2.46030E-01
7.24100E+02	1.88490E-01	3.53910E-01	6.67090E-02	2.30470E-01
7.24200E+02	1.76290E-01	3.53930E-01	6.23960E-02	2.15570E-01
7.24300E+02	1.64700E-01	3.53950E-01	5.82950E-02	2.01400E-01
7.24400E+02	1.53760E-01	3.53960E-01	5.44250E-02	1.88030E-01
7.24500E+02	1.43530E-01	3.53980E-01	5.08070E-02	1.75530E-01
7.24600E+02	1.34050E-01	3.53990E-01	4.74510E-02	1.63940E-01
7.24700E+02	1.25320E-01	3.54010E-01	4.43630E-02	1.53260E-01
7.24800E+02	1.17310E-01	3.54020E-01	4.15320E-02	1.43480E-01
7.24900E+02	1.09980E-01	3.54040E-01	3.89370E-02	1.34520E-01
7.25000E+02	1.03220E-01	3.54050E-01	3.65470E-02	1.26260E-01
7.25100E+02	9.69310E-02	3.54060E-01	3.43200E-02	1.18570E-01
7.25200E+02	9.09810E-02	3.54080E-01	3.22140E-02	1.11290E-01
7.25300E+02	8.52640E-02	3.54090E-01	3.01910E-02	1.04310E-01
7.25400E+02	7.96950E-02	3.54120E-01	2.82210E-02	9.74990E-02
7.25500E+02	7.42250E-02	3.54140E-01	2.62860E-02	9.08140E-02
7.25600E+02	6.88500E-02	3.54170E-01	2.43840E-02	8.42430E-02
7.25700E+02	6.36060E-02	3.54190E-01	2.25290E-02	7.78320E-02

7.25800E+02	5.85600E-02	3.54220E-01	2.07430E-02	7.16630E-02
7.25900E+02	5.38000E-02	3.54240E-01	1.90580E-02	6.58420E-02
7.26000E+02	4.94110E-02	3.54260E-01	1.75050E-02	6.04750E-02
7.26100E+02	4.54630E-02	3.54320E-01	1.61080E-02	5.56510E-02
7.26200E+02	4.19900E-02	3.54370E-01	1.48800E-02	5.14080E-02
7.26300E+02	3.89930E-02	3.54420E-01	1.38200E-02	4.77460E-02
7.26400E+02	3.64280E-02	3.54480E-01	1.29130E-02	4.46120E-02
7.26500E+02	3.42230E-02	3.54530E-01	1.21330E-02	4.19170E-02
7.26600E+02	3.22820E-02	3.54580E-01	1.14470E-02	3.95460E-02
7.26700E+02	3.05100E-02	3.54640E-01	1.08200E-02	3.73800E-02
7.26800E+02	2.88220E-02	3.54690E-01	1.02230E-02	3.53180E-02
7.26900E+02	2.71620E-02	3.54740E-01	9.63550E-03	3.32890E-02
7.27000E+02	2.55040E-02	3.54800E-01	9.04900E-03	3.12620E-02
7.27100E+02	2.38590E-02	3.54850E-01	8.46640E-03	2.92500E-02
7.27200E+02	2.22630E-02	3.54900E-01	7.90100E-03	2.72970E-02
7.27300E+02	2.07670E-02	3.54960E-01	7.37150E-03	2.54670E-02
7.27400E+02	1.94260E-02	3.55020E-01	6.89680E-03	2.38270E-02
7.27500E+02	1.82820E-02	3.55090E-01	6.49180E-03	2.24280E-02
7.27600E+02	1.73550E-02	3.55150E-01	6.16340E-03	2.12930E-02
7.27700E+02	1.66340E-02	3.55210E-01	5.90850E-03	2.04130E-02
7.27800E+02	1.60850E-02	3.55270E-01	5.71440E-03	1.97420E-02
7.27900E+02	1.56500E-02	3.55330E-01	5.56090E-03	1.92120E-02
7.28000E+02	1.52620E-02	3.55390E-01	5.42400E-03	1.87390E-02
7.28100E+02	1.48560E-02	3.55470E-01	5.28070E-03	1.82440E-02
7.28200E+02	1.43780E-02	3.55560E-01	5.11230E-03	1.76620E-02
7.28300E+02	1.38000E-02	3.55640E-01	4.90770E-03	1.69550E-02
7.28400E+02	1.31140E-02	3.55720E-01	4.66500E-03	1.61170E-02
7.28500E+02	1.23410E-02	3.55800E-01	4.39100E-03	1.51700E-02
7.28600E+02	1.15170E-02	3.55890E-01	4.09870E-03	1.41600E-02
7.28700E+02	1.06880E-02	3.55970E-01	3.80470E-03	1.31450E-02
7.28800E+02	1.06230E-02	3.56050E-01	3.78220E-03	1.30670E-02
7.28900E+02	1.01550E-02	3.56130E-01	3.61670E-03	1.24950E-02
7.29000E+02	9.69630E-03	3.56210E-01	3.45390E-03	1.19330E-02
7.29100E+02	9.24050E-03	3.56290E-01	3.29230E-03	1.13740E-02
7.29200E+02	8.78610E-03	3.56370E-01	3.13110E-03	1.08170E-02
7.29300E+02	8.33380E-03	3.56440E-01	2.97050E-03	1.02630E-02
7.29400E+02	7.88540E-03	3.56520E-01	2.81130E-03	9.71250E-03
7.29500E+02	7.44420E-03	3.56590E-01	2.65450E-03	9.17090E-03
7.29600E+02	7.01340E-03	3.56670E-01	2.50150E-03	8.64210E-03
7.29700E+02	6.59670E-03	3.56740E-01	2.35330E-03	8.13030E-03
7.29800E+02	6.19780E-03	3.56820E-01	2.21150E-03	7.64020E-03
7.29900E+02	5.82060E-03	3.56890E-01	2.07730E-03	7.17670E-03
7.30000E+02	5.46960E-03	3.56960E-01	1.95240E-03	6.74530E-03

7.30100E+02	5.14920E-03	3.57020E-01	1.83840E-03	6.35130E-03
7.30200E+02	4.86380E-03	3.57080E-01	1.73680E-03	6.00020E-03
7.30300E+02	4.61640E-03	3.57140E-01	1.64870E-03	5.69590E-03
7.30400E+02	4.40820E-03	3.57200E-01	1.57460E-03	5.43990E-03
7.30500E+02	4.23730E-03	3.57250E-01	1.51380E-03	5.22990E-03
7.30600E+02	4.09810E-03	3.57310E-01	1.46430E-03	5.05880E-03
7.30700E+02	3.98130E-03	3.57370E-01	1.42280E-03	4.91550E-03
7.30800E+02	3.87480E-03	3.57430E-01	1.38500E-03	4.78480E-03
7.30900E+02	3.76490E-03	3.57490E-01	1.34590E-03	4.64990E-03
7.31000E+02	3.63870E-03	3.57540E-01	1.30100E-03	4.49460E-03
7.31100E+02	3.48590E-03	3.57600E-01	1.24660E-03	4.30660E-03
7.31200E+02	3.30140E-03	3.57670E-01	1.18080E-03	4.07950E-03
7.31300E+02	3.08630E-03	3.57740E-01	1.10410E-03	3.81440E-03
7.31400E+02	2.85970E-03	3.57810E-01	1.02320E-03	3.53500E-03
7.31500E+02	2.76540E-03	3.57870E-01	9.89660E-04	3.41910E-03
7.31600E+02	2.67100E-03	3.57940E-01	9.56080E-04	3.30310E-03
7.31700E+02	2.57670E-03	3.58010E-01	9.22480E-04	3.18700E-03
7.31800E+02	2.48230E-03	3.58080E-01	8.88880E-04	3.07090E-03
7.31900E+02	2.38800E-03	3.58150E-01	8.55260E-04	2.95470E-03
7.32000E+02	2.29370E-03	3.58210E-01	8.21620E-04	2.83850E-03
7.32100E+02	2.19930E-03	3.58280E-01	7.87990E-04	2.72230E-03
7.32200E+02	1.81440E-03	3.58360E-01	6.50210E-04	2.24640E-03
7.32300E+02	7.98120E-04	3.58430E-01	2.86070E-04	9.88320E-04
7.32400E+02	1.19930E-04	3.58500E-01	4.29950E-05	1.48540E-04
7.32500E+02	0.00000E+00	3.58570E-01	0.00000E+00	0.00000E+00

Channel 6

Wavenumber	HIRS Filter Transmittance	Optical Element Transmittance	Product of the HIRS Filter and Optical Element Transmittances	Normalized Value of Column 4
7.12800E+02	0.00000E+00	3.51460E-01	0.00000E+00	0.00000E+00
7.12900E+02	1.72790E-03	3.51450E-01	6.07280E-04	2.13450E-03
7.13000E+02	1.69340E-03	3.51450E-01	5.95130E-04	2.09180E-03
7.13100E+02	1.79130E-03	3.51450E-01	6.29560E-04	2.21280E-03
7.13200E+02	2.06540E-03	3.51440E-01	7.25860E-04	2.55130E-03
7.13300E+02	2.53830E-03	3.51440E-01	8.92050E-04	3.13550E-03
7.13400E+02	3.20000E-03	3.51440E-01	1.12460E-03	3.95280E-03
7.13500E+02	4.00130E-03	3.51430E-01	1.40620E-03	4.94270E-03
7.13600E+02	4.86100E-03	3.51430E-01	1.70830E-03	6.00450E-03
7.13700E+02	5.68170E-03	3.51430E-01	1.99670E-03	7.01820E-03
7.13800E+02	6.36970E-03	3.51430E-01	2.23850E-03	7.86810E-03
7.13900E+02	5.09840E-03	3.51430E-01	1.79180E-03	6.29790E-03
7.14000E+02	5.37330E-03	3.51440E-01	1.88840E-03	6.63750E-03

7.14100E+02	5.67310E-03	3.51370E-01	1.99340E-03	7.00660E-03
7.14200E+02	5.98740E-03	3.51310E-01	2.10340E-03	7.39350E-03
7.14300E+02	6.30200E-03	3.51250E-01	2.21360E-03	7.78050E-03
7.14400E+02	6.60140E-03	3.51180E-01	2.31830E-03	8.14860E-03
7.14500E+02	6.87220E-03	3.51120E-01	2.41300E-03	8.48140E-03
7.14600E+02	7.10670E-03	3.51060E-01	2.49480E-03	8.76920E-03
7.14700E+02	7.30500E-03	3.50990E-01	2.56400E-03	9.01220E-03
7.14800E+02	7.47580E-03	3.50930E-01	2.62350E-03	9.22140E-03
7.14900E+02	7.63540E-03	3.50870E-01	2.67900E-03	9.41650E-03
7.15000E+02	7.80450E-03	3.50800E-01	2.73780E-03	9.62320E-03
7.15100E+02	8.00470E-03	3.50740E-01	2.80750E-03	9.86830E-03
7.15200E+02	8.25440E-03	3.50670E-01	2.89460E-03	1.01740E-02
7.15300E+02	8.56520E-03	3.50610E-01	3.00300E-03	1.05550E-02
7.15400E+02	8.93960E-03	3.50540E-01	3.13370E-03	1.10150E-02
7.15500E+02	9.37110E-03	3.50480E-01	3.28440E-03	1.15440E-02
7.15600E+02	9.84530E-03	3.50410E-01	3.44990E-03	1.21260E-02
7.15700E+02	1.03430E-02	3.50360E-01	3.62390E-03	1.27380E-02
7.15800E+02	1.08460E-02	3.50310E-01	3.79940E-03	1.33540E-02
7.15900E+02	1.13360E-02	3.50260E-01	3.97060E-03	1.39560E-02
7.16000E+02	1.18050E-02	3.50210E-01	4.13430E-03	1.45320E-02
7.16100E+02	1.22520E-02	3.50250E-01	4.29140E-03	1.50840E-02
7.16200E+02	1.26870E-02	3.50280E-01	4.44390E-03	1.56200E-02
7.16300E+02	1.31240E-02	3.50320E-01	4.59740E-03	1.61600E-02
7.16400E+02	1.35830E-02	3.50350E-01	4.75880E-03	1.67270E-02
7.16500E+02	1.40840E-02	3.50380E-01	4.93490E-03	1.73460E-02
7.16600E+02	1.46430E-02	3.50420E-01	5.13130E-03	1.80360E-02
7.16700E+02	1.52690E-02	3.50450E-01	5.35100E-03	1.88080E-02
7.16800E+02	1.59610E-02	3.50480E-01	5.59410E-03	1.96630E-02
7.16900E+02	1.67130E-02	3.50520E-01	5.85830E-03	2.05910E-02
7.17000E+02	1.75130E-02	3.50550E-01	6.13910E-03	2.15780E-02
7.17100E+02	1.83450E-02	3.50580E-01	6.43130E-03	2.26060E-02
7.17200E+02	1.91960E-02	3.50610E-01	6.73050E-03	2.36570E-02
7.17300E+02	2.00610E-02	3.50650E-01	7.03410E-03	2.47240E-02
7.17400E+02	2.09380E-02	3.50680E-01	7.34260E-03	2.58090E-02
7.17500E+02	2.18400E-02	3.50710E-01	7.65950E-03	2.69220E-02
7.17600E+02	2.27840E-02	3.50750E-01	7.99150E-03	2.80890E-02
7.17700E+02	2.37930E-02	3.50820E-01	8.34730E-03	2.93400E-02
7.17800E+02	2.48960E-02	3.50890E-01	8.73560E-03	3.07050E-02
7.17900E+02	2.61140E-02	3.50960E-01	9.16490E-03	3.22140E-02
7.18000E+02	2.74680E-02	3.51020E-01	9.64180E-03	3.38900E-02
7.18100E+02	2.89680E-02	3.51040E-01	1.01690E-02	3.57430E-02
7.18200E+02	3.06190E-02	3.51050E-01	1.07490E-02	3.77820E-02
7.18300E+02	3.24170E-02	3.51070E-01	1.13810E-02	4.00020E-02

7.18400E+02	3.43540E-02	3.51090E-01	1.20610E-02	4.23940E-02
7.18500E+02	3.64210E-02	3.51100E-01	1.27870E-02	4.49470E-02
7.18600E+02	3.86100E-02	3.51120E-01	1.35570E-02	4.76510E-02
7.18700E+02	4.09220E-02	3.51130E-01	1.43690E-02	5.05060E-02
7.18800E+02	4.23830E-02	3.51150E-01	1.48830E-02	5.23110E-02
7.18900E+02	4.33610E-02	3.51160E-01	1.52270E-02	5.35200E-02
7.19000E+02	4.52800E-02	3.51180E-01	1.59010E-02	5.58920E-02
7.19100E+02	4.83580E-02	3.51190E-01	1.69830E-02	5.96940E-02
7.19200E+02	5.15650E-02	3.51210E-01	1.81100E-02	6.36550E-02
7.19300E+02	5.48630E-02	3.51220E-01	1.92690E-02	6.77300E-02
7.19400E+02	5.82420E-02	3.51230E-01	2.04570E-02	7.19040E-02
7.19500E+02	6.17190E-02	3.51250E-01	2.16790E-02	7.62000E-02
7.19600E+02	6.53390E-02	3.51300E-01	2.29540E-02	8.06810E-02
7.19700E+02	6.91660E-02	3.51360E-01	2.43020E-02	8.54190E-02
7.19800E+02	7.32690E-02	3.51410E-01	2.57470E-02	9.05000E-02
7.19900E+02	7.77150E-02	3.51460E-01	2.73140E-02	9.60060E-02
7.20000E+02	8.25550E-02	3.51510E-01	2.90190E-02	1.02000E-01
7.20100E+02	8.78180E-02	3.51530E-01	3.08710E-02	1.08510E-01
7.20200E+02	9.35140E-02	3.51550E-01	3.28750E-02	1.15550E-01
7.20300E+02	9.96380E-02	3.51570E-01	3.50300E-02	1.23130E-01
7.20400E+02	1.06180E-01	3.51590E-01	3.73300E-02	1.31210E-01
7.20500E+02	1.13110E-01	3.51610E-01	3.97720E-02	1.39800E-01
7.20600E+02	1.20450E-01	3.51630E-01	4.23530E-02	1.48870E-01
7.20700E+02	1.28180E-01	3.51650E-01	4.50740E-02	1.58430E-01
7.20800E+02	1.36330E-01	3.51670E-01	4.79410E-02	1.68510E-01
7.20900E+02	1.44910E-01	3.51680E-01	5.09610E-02	1.79120E-01
7.21000E+02	1.53940E-01	3.51700E-01	5.41410E-02	1.90300E-01
7.21100E+02	1.63430E-01	3.51720E-01	5.74820E-02	2.02050E-01
7.21200E+02	1.73370E-01	3.51740E-01	6.09830E-02	2.14350E-01
7.21300E+02	1.83740E-01	3.51760E-01	6.46320E-02	2.27180E-01
7.21400E+02	1.94480E-01	3.51780E-01	6.84170E-02	2.40480E-01
7.21500E+02	2.05570E-01	3.51820E-01	7.23210E-02	2.54200E-01
7.21600E+02	2.16940E-01	3.51850E-01	7.63300E-02	2.68290E-01
7.21700E+02	2.28570E-01	3.51890E-01	8.04310E-02	2.82710E-01
7.21800E+02	2.40460E-01	3.51920E-01	8.46250E-02	2.97450E-01
7.21900E+02	2.52640E-01	3.51960E-01	8.89200E-02	3.12550E-01
7.22000E+02	2.65160E-01	3.51990E-01	9.33350E-02	3.28070E-01
7.22100E+02	2.78080E-01	3.52080E-01	9.79070E-02	3.44140E-01
7.22200E+02	2.91470E-01	3.52170E-01	1.02650E-01	3.60800E-01
7.22300E+02	3.05370E-01	3.52260E-01	1.07570E-01	3.78100E-01
7.22400E+02	3.19790E-01	3.52350E-01	1.12680E-01	3.96060E-01
7.22500E+02	3.34700E-01	3.52440E-01	1.17960E-01	4.14630E-01
7.22600E+02	3.50010E-01	3.52530E-01	1.23390E-01	4.33700E-01

7.22700E+02	3.65570E-01	3.52620E-01	1.28910E-01	4.53100E-01
7.22800E+02	3.81220E-01	3.52710E-01	1.34460E-01	4.72610E-01
7.22900E+02	3.96780E-01	3.52800E-01	1.39980E-01	4.92030E-01
7.23000E+02	4.12080E-01	3.52890E-01	1.45420E-01	5.11140E-01
7.23100E+02	4.27010E-01	3.52980E-01	1.50720E-01	5.29790E-01
7.23200E+02	4.41480E-01	3.53070E-01	1.55870E-01	5.47870E-01
7.23300E+02	4.55470E-01	3.53160E-01	1.60850E-01	5.65380E-01
7.23400E+02	4.69020E-01	3.53260E-01	1.65680E-01	5.82360E-01
7.23500E+02	4.82190E-01	3.53360E-01	1.70390E-01	5.98910E-01
7.23600E+02	4.95100E-01	3.53470E-01	1.75000E-01	6.15120E-01
7.23700E+02	5.07800E-01	3.53580E-01	1.79550E-01	6.31100E-01
7.23800E+02	5.20370E-01	3.53690E-01	1.84050E-01	6.46910E-01
7.23900E+02	5.32810E-01	3.53790E-01	1.88500E-01	6.62580E-01
7.24000E+02	5.45080E-01	3.53900E-01	1.92900E-01	6.78040E-01
7.24100E+02	5.57090E-01	3.53910E-01	1.97160E-01	6.93010E-01
7.24200E+02	5.68740E-01	3.53930E-01	2.01300E-01	7.07540E-01
7.24300E+02	5.79910E-01	3.53950E-01	2.05260E-01	7.21470E-01
7.24400E+02	5.90510E-01	3.53960E-01	2.09020E-01	7.34680E-01
7.24500E+02	6.00460E-01	3.53980E-01	2.12550E-01	7.47100E-01
7.24600E+02	6.09760E-01	3.53990E-01	2.15850E-01	7.58700E-01
7.24700E+02	6.18450E-01	3.54010E-01	2.18940E-01	7.69540E-01
7.24800E+02	6.26600E-01	3.54020E-01	2.21830E-01	7.79720E-01
7.24900E+02	6.34320E-01	3.54040E-01	2.24570E-01	7.89350E-01
7.25000E+02	6.41710E-01	3.54050E-01	2.27200E-01	7.98590E-01
7.25100E+02	6.48870E-01	3.54060E-01	2.29740E-01	8.07520E-01
7.25200E+02	6.55830E-01	3.54080E-01	2.32210E-01	8.16220E-01
7.25300E+02	6.62600E-01	3.54090E-01	2.34620E-01	8.24680E-01
7.25400E+02	6.69150E-01	3.54120E-01	2.36960E-01	8.32890E-01
7.25500E+02	6.75390E-01	3.54140E-01	2.39180E-01	8.40710E-01
7.25600E+02	6.81240E-01	3.54170E-01	2.41270E-01	8.48060E-01
7.25700E+02	6.86630E-01	3.54190E-01	2.43200E-01	8.54830E-01
7.25800E+02	6.91520E-01	3.54220E-01	2.44950E-01	8.60970E-01
7.25900E+02	6.95900E-01	3.54240E-01	2.46520E-01	8.66480E-01
7.26000E+02	6.99840E-01	3.54260E-01	2.47930E-01	8.71450E-01
7.26100E+02	7.03440E-01	3.54320E-01	2.49240E-01	8.76060E-01
7.26200E+02	7.06820E-01	3.54370E-01	2.50480E-01	8.80410E-01
7.26300E+02	7.10130E-01	3.54420E-01	2.51690E-01	8.84660E-01
7.26400E+02	7.13490E-01	3.54480E-01	2.52920E-01	8.88980E-01
7.26500E+02	7.16970E-01	3.54530E-01	2.54190E-01	8.93450E-01
7.26600E+02	7.20600E-01	3.54580E-01	2.55510E-01	8.98100E-01
7.26700E+02	7.24340E-01	3.54640E-01	2.56880E-01	9.02910E-01
7.26800E+02	7.28130E-01	3.54690E-01	2.58260E-01	9.07760E-01
7.26900E+02	7.31840E-01	3.54740E-01	2.59620E-01	9.12540E-01

7.27000E+02	7.35370E-01	3.54800E-01	2.60910E-01	9.17070E-01
7.27100E+02	7.38610E-01	3.54850E-01	2.62100E-01	9.21250E-01
7.27200E+02	7.41510E-01	3.54900E-01	2.63160E-01	9.25000E-01
7.27300E+02	7.44050E-01	3.54960E-01	2.64110E-01	9.28320E-01
7.27400E+02	7.46280E-01	3.55020E-01	2.64950E-01	9.31270E-01
7.27500E+02	7.48280E-01	3.55090E-01	2.65700E-01	9.33930E-01
7.27600E+02	7.50180E-01	3.55150E-01	2.66420E-01	9.36460E-01
7.27700E+02	7.52080E-01	3.55210E-01	2.67150E-01	9.39000E-01
7.27800E+02	7.54090E-01	3.55270E-01	2.67900E-01	9.41670E-01
7.27900E+02	7.56260E-01	3.55330E-01	2.68720E-01	9.44540E-01
7.28000E+02	7.58600E-01	3.55390E-01	2.69600E-01	9.47620E-01
7.28100E+02	7.61070E-01	3.55470E-01	2.70540E-01	9.50920E-01
7.28200E+02	7.63570E-01	3.55560E-01	2.71490E-01	9.54280E-01
7.28300E+02	7.66020E-01	3.55640E-01	2.72430E-01	9.57560E-01
7.28400E+02	7.68300E-01	3.55720E-01	2.73300E-01	9.60630E-01
7.28500E+02	7.70340E-01	3.55800E-01	2.74090E-01	9.63400E-01
7.28600E+02	7.72080E-01	3.55890E-01	2.74770E-01	9.65810E-01
7.28700E+02	7.73550E-01	3.55970E-01	2.75360E-01	9.67860E-01
7.28800E+02	7.74780E-01	3.56050E-01	2.75860E-01	9.69620E-01
7.28900E+02	7.75860E-01	3.56130E-01	2.76310E-01	9.71200E-01
7.29000E+02	7.76900E-01	3.56210E-01	2.76740E-01	9.72720E-01
7.29100E+02	7.78000E-01	3.56290E-01	2.77190E-01	9.74320E-01
7.29200E+02	7.79240E-01	3.56370E-01	2.77700E-01	9.76090E-01
7.29300E+02	7.80680E-01	3.56440E-01	2.78270E-01	9.78090E-01
7.29400E+02	7.82300E-01	3.56520E-01	2.78900E-01	9.80330E-01
7.29500E+02	7.84080E-01	3.56590E-01	2.79600E-01	9.82760E-01
7.29600E+02	7.85920E-01	3.56670E-01	2.80310E-01	9.85280E-01
7.29700E+02	7.87750E-01	3.56740E-01	2.81020E-01	9.87780E-01
7.29800E+02	7.89460E-01	3.56820E-01	2.81690E-01	9.90130E-01
7.29900E+02	7.90970E-01	3.56890E-01	2.82290E-01	9.92230E-01
7.30000E+02	7.92240E-01	3.56960E-01	2.82800E-01	9.94020E-01
7.30100E+02	7.93220E-01	3.57020E-01	2.83200E-01	9.95420E-01
7.30200E+02	7.93950E-01	3.57080E-01	2.83500E-01	9.96490E-01
7.30300E+02	7.94450E-01	3.57140E-01	2.83730E-01	9.97280E-01
7.30400E+02	7.94780E-01	3.57200E-01	2.83890E-01	9.97860E-01
7.30500E+02	7.95000E-01	3.57250E-01	2.84010E-01	9.98290E-01
7.30600E+02	7.95150E-01	3.57310E-01	2.84120E-01	9.98650E-01
7.30700E+02	7.95270E-01	3.57370E-01	2.84210E-01	9.98970E-01
7.30800E+02	7.95380E-01	3.57430E-01	2.84290E-01	9.99260E-01
7.30900E+02	7.95470E-01	3.57490E-01	2.84370E-01	9.99530E-01
7.31000E+02	7.95520E-01	3.57540E-01	2.84430E-01	9.99760E-01
7.31100E+02	7.95510E-01	3.57600E-01	2.84480E-01	9.99920E-01
7.31200E+02	7.95430E-01	3.57670E-01	2.84500E-01	1.00000E+00

7.31300E+02	7.95250E-01	3.57740E-01	2.84490E-01	9.99970E-01
7.31400E+02	7.94990E-01	3.57810E-01	2.84450E-01	9.99830E-01
7.31500E+02	7.94660E-01	3.57870E-01	2.84390E-01	9.99610E-01
7.31600E+02	7.94280E-01	3.57940E-01	2.84310E-01	9.99320E-01
7.31700E+02	7.93870E-01	3.58010E-01	2.84210E-01	9.98990E-01
7.31800E+02	7.93470E-01	3.58080E-01	2.84120E-01	9.98670E-01
7.31900E+02	7.93080E-01	3.58150E-01	2.84040E-01	9.98370E-01
7.32000E+02	7.92720E-01	3.58210E-01	2.83960E-01	9.98100E-01
7.32100E+02	7.92370E-01	3.58280E-01	2.83900E-01	9.97870E-01
7.32200E+02	7.92040E-01	3.58360E-01	2.83830E-01	9.97650E-01
7.32300E+02	7.91710E-01	3.58430E-01	2.83770E-01	9.97430E-01
7.32400E+02	7.91360E-01	3.58500E-01	2.83700E-01	9.97180E-01
7.32500E+02	7.90980E-01	3.58570E-01	2.83620E-01	9.96910E-01
7.32600E+02	7.90580E-01	3.58640E-01	2.83540E-01	9.96610E-01
7.32700E+02	7.90170E-01	3.58710E-01	2.83450E-01	9.96290E-01
7.32800E+02	7.89760E-01	3.58790E-01	2.83350E-01	9.95970E-01
7.32900E+02	7.89360E-01	3.58860E-01	2.83270E-01	9.95670E-01
7.33000E+02	7.89000E-01	3.58930E-01	2.83200E-01	9.95410E-01
7.33100E+02	7.88670E-01	3.59020E-01	2.83150E-01	9.95250E-01
7.33200E+02	7.88380E-01	3.59110E-01	2.83120E-01	9.95140E-01
7.33300E+02	7.88120E-01	3.59210E-01	2.83100E-01	9.95060E-01
7.33400E+02	7.87870E-01	3.59300E-01	2.83080E-01	9.95000E-01
7.33500E+02	7.87610E-01	3.59390E-01	2.83060E-01	9.94930E-01
7.33600E+02	7.87320E-01	3.59480E-01	2.83030E-01	9.94820E-01
7.33700E+02	7.86990E-01	3.59570E-01	2.82980E-01	9.94650E-01
7.33800E+02	7.86610E-01	3.59670E-01	2.82920E-01	9.94430E-01
7.33900E+02	7.86180E-01	3.59760E-01	2.82830E-01	9.94140E-01
7.34000E+02	7.85700E-01	3.59850E-01	2.82740E-01	9.93790E-01
7.34100E+02	7.85200E-01	3.59930E-01	2.82610E-01	9.93360E-01
7.34200E+02	7.84670E-01	3.60000E-01	2.82480E-01	9.92900E-01
7.34300E+02	7.84120E-01	3.60080E-01	2.82340E-01	9.92420E-01
7.34400E+02	7.83550E-01	3.60150E-01	2.82200E-01	9.91910E-01
7.34500E+02	7.82950E-01	3.60230E-01	2.82040E-01	9.91350E-01
7.34600E+02	7.82290E-01	3.60310E-01	2.81860E-01	9.90730E-01
7.34700E+02	7.81570E-01	3.60380E-01	2.81660E-01	9.90020E-01
7.34800E+02	7.80740E-01	3.60460E-01	2.81430E-01	9.89190E-01
7.34900E+02	7.79810E-01	3.60530E-01	2.81150E-01	9.88220E-01
7.35000E+02	7.78760E-01	3.60620E-01	2.80840E-01	9.87120E-01
7.35100E+02	7.77600E-01	3.60700E-01	2.80480E-01	9.85880E-01
7.35200E+02	7.76330E-01	3.60790E-01	2.80090E-01	9.84490E-01
7.35300E+02	7.74960E-01	3.60870E-01	2.79660E-01	9.83000E-01
7.35400E+02	7.73530E-01	3.60960E-01	2.79210E-01	9.81410E-01
7.35500E+02	7.72030E-01	3.61040E-01	2.78740E-01	9.79740E-01

7.35600E+02	7.70480E-01	3.61130E-01	2.78240E-01	9.78000E-01
7.35700E+02	7.68850E-01	3.61220E-01	2.77720E-01	9.76170E-01
7.35800E+02	7.67140E-01	3.61300E-01	2.77170E-01	9.74230E-01
7.35900E+02	7.65310E-01	3.61390E-01	2.76570E-01	9.72130E-01
7.36000E+02	7.63320E-01	3.61470E-01	2.75920E-01	9.69840E-01
7.36100E+02	7.61150E-01	3.61660E-01	2.75280E-01	9.67580E-01
7.36200E+02	7.58760E-01	3.61840E-01	2.74550E-01	9.65030E-01
7.36300E+02	7.56120E-01	3.62030E-01	2.73740E-01	9.62170E-01
7.36400E+02	7.53250E-01	3.62210E-01	2.72840E-01	9.59000E-01
7.36500E+02	7.50130E-01	3.62400E-01	2.71850E-01	9.55520E-01
7.36600E+02	7.46770E-01	3.62580E-01	2.70770E-01	9.51730E-01
7.36700E+02	7.43180E-01	3.62770E-01	2.69600E-01	9.47640E-01
7.36800E+02	7.39350E-01	3.62960E-01	2.68350E-01	9.43240E-01
7.36900E+02	7.35270E-01	3.63150E-01	2.67010E-01	9.38520E-01
7.37000E+02	7.30890E-01	3.63340E-01	2.65560E-01	9.33420E-01
7.37100E+02	7.26160E-01	3.63530E-01	2.63980E-01	9.27870E-01
7.37200E+02	7.21000E-01	3.63730E-01	2.62250E-01	9.21780E-01
7.37300E+02	7.15350E-01	3.63920E-01	2.60330E-01	9.15040E-01
7.37400E+02	7.09130E-01	3.64120E-01	2.58210E-01	9.07570E-01
7.37500E+02	7.02280E-01	3.64310E-01	2.55850E-01	8.99280E-01
7.37600E+02	6.94750E-01	3.64500E-01	2.53240E-01	8.90120E-01
7.37700E+02	6.86540E-01	3.64700E-01	2.50380E-01	8.80070E-01
7.37800E+02	6.77650E-01	3.64890E-01	2.47270E-01	8.69140E-01
7.37900E+02	6.68120E-01	3.65090E-01	2.43930E-01	8.57380E-01
7.38000E+02	6.58000E-01	3.65290E-01	2.40360E-01	8.44850E-01
7.38100E+02	6.47350E-01	3.65500E-01	2.36600E-01	8.31650E-01
7.38200E+02	6.36210E-01	3.65710E-01	2.32670E-01	8.17810E-01
7.38300E+02	6.24630E-01	3.65920E-01	2.28560E-01	8.03380E-01
7.38400E+02	6.12610E-01	3.66130E-01	2.24300E-01	7.88390E-01
7.38500E+02	6.00180E-01	3.66340E-01	2.19870E-01	7.72840E-01
7.38600E+02	5.87310E-01	3.66560E-01	2.15280E-01	7.56700E-01
7.38700E+02	5.73990E-01	3.66770E-01	2.10520E-01	7.39970E-01
7.38800E+02	5.60200E-01	3.66980E-01	2.05580E-01	7.22610E-01
7.38900E+02	5.45950E-01	3.67200E-01	2.00470E-01	7.04630E-01
7.39000E+02	5.31240E-01	3.67410E-01	1.95180E-01	6.86060E-01
7.39100E+02	5.16140E-01	3.67630E-01	1.89750E-01	6.66950E-01
7.39200E+02	5.00710E-01	3.67840E-01	1.84180E-01	6.47390E-01
7.39300E+02	4.85050E-01	3.68060E-01	1.78530E-01	6.27510E-01
7.39400E+02	4.69260E-01	3.68270E-01	1.72820E-01	6.07440E-01
7.39500E+02	4.53440E-01	3.68490E-01	1.67090E-01	5.87310E-01
7.39600E+02	4.37690E-01	3.68700E-01	1.61380E-01	5.67230E-01
7.39700E+02	4.22070E-01	3.68920E-01	1.55710E-01	5.47310E-01
7.39800E+02	4.06610E-01	3.69140E-01	1.50100E-01	5.27570E-01

7.39900E+02	3.91330E-01	3.69350E-01	1.44540E-01	5.08050E-01
7.40000E+02	3.76220E-01	3.69570E-01	1.39040E-01	4.88710E-01
7.40100E+02	3.61240E-01	3.69700E-01	1.33550E-01	4.69410E-01
7.40200E+02	3.46350E-01	3.69830E-01	1.28090E-01	4.50230E-01
7.40300E+02	3.31550E-01	3.69950E-01	1.22660E-01	4.31130E-01
7.40400E+02	3.16820E-01	3.70080E-01	1.17250E-01	4.12120E-01
7.40500E+02	3.02180E-01	3.70210E-01	1.11870E-01	3.93220E-01
7.40600E+02	2.87700E-01	3.70340E-01	1.06550E-01	3.74500E-01
7.40700E+02	2.73440E-01	3.70460E-01	1.01300E-01	3.56070E-01
7.40800E+02	2.59510E-01	3.70590E-01	9.61730E-02	3.38040E-01
7.40900E+02	2.45990E-01	3.70720E-01	9.11960E-02	3.20550E-01
7.41000E+02	2.32980E-01	3.70850E-01	8.64020E-02	3.03700E-01
7.41100E+02	2.20540E-01	3.70980E-01	8.18170E-02	2.87580E-01
7.41200E+02	2.08710E-01	3.71110E-01	7.74540E-02	2.72240E-01
7.41300E+02	1.97480E-01	3.71240E-01	7.33140E-02	2.57690E-01
7.41400E+02	1.86840E-01	3.71370E-01	6.93880E-02	2.43890E-01
7.41500E+02	1.76740E-01	3.71500E-01	6.56590E-02	2.30790E-01
7.41600E+02	1.67110E-01	3.71630E-01	6.21030E-02	2.18290E-01
7.41700E+02	1.57900E-01	3.71760E-01	5.86990E-02	2.06320E-01
7.41800E+02	1.49050E-01	3.71890E-01	5.54290E-02	1.94830E-01
7.41900E+02	1.40530E-01	3.72020E-01	5.22810E-02	1.83760E-01
7.42000E+02	1.32350E-01	3.72150E-01	4.92550E-02	1.73130E-01
7.42100E+02	1.24520E-01	3.72310E-01	4.63610E-02	1.62960E-01
7.42200E+02	1.17080E-01	3.72460E-01	4.36070E-02	1.53280E-01
7.42300E+02	1.10060E-01	3.72620E-01	4.10110E-02	1.44150E-01
7.42400E+02	1.03510E-01	3.72780E-01	3.85850E-02	1.35620E-01
7.42500E+02	9.74390E-02	3.72940E-01	3.63390E-02	1.27730E-01
7.42600E+02	9.18600E-02	3.73100E-01	3.42730E-02	1.20470E-01
7.42700E+02	8.67460E-02	3.73250E-01	3.23780E-02	1.13810E-01
7.42800E+02	8.20490E-02	3.73410E-01	3.06380E-02	1.07690E-01
7.42900E+02	7.77020E-02	3.73570E-01	2.90270E-02	1.02030E-01
7.43000E+02	7.36330E-02	3.73720E-01	2.75180E-02	9.67250E-02
7.43100E+02	6.97700E-02	3.73880E-01	2.60860E-02	9.16890E-02
7.43200E+02	6.60530E-02	3.74040E-01	2.47070E-02	8.68420E-02
7.43300E+02	6.24440E-02	3.74200E-01	2.33660E-02	8.21310E-02
7.43400E+02	5.89260E-02	3.74360E-01	2.20590E-02	7.75370E-02
7.43500E+02	5.55040E-02	3.74520E-01	2.07870E-02	7.30660E-02
7.43600E+02	5.22020E-02	3.74680E-01	1.95590E-02	6.87480E-02
7.43700E+02	4.90510E-02	3.74840E-01	1.83860E-02	6.46250E-02
7.43800E+02	4.60820E-02	3.75000E-01	1.72810E-02	6.07400E-02
7.43900E+02	4.33190E-02	3.75160E-01	1.62510E-02	5.71230E-02
7.44000E+02	4.14240E-02	3.75320E-01	1.55470E-02	5.46470E-02
7.44100E+02	4.07700E-02	3.75530E-01	1.53100E-02	5.38150E-02

7.44200E+02	3.91550E-02	3.75740E-01	1.47120E-02	5.17120E-02
7.44300E+02	3.70390E-02	3.75950E-01	1.39250E-02	4.89450E-02
7.44400E+02	3.50760E-02	3.76160E-01	1.31940E-02	4.63770E-02
7.44500E+02	3.32650E-02	3.76380E-01	1.25200E-02	4.40070E-02
7.44600E+02	3.16000E-02	3.76590E-01	1.19010E-02	4.18290E-02
7.44700E+02	3.00720E-02	3.76830E-01	1.13320E-02	3.98300E-02
7.44800E+02	2.86640E-02	3.77060E-01	1.08080E-02	3.79900E-02
7.44900E+02	2.73610E-02	3.77300E-01	1.03230E-02	3.62850E-02
7.45000E+02	2.61430E-02	3.77530E-01	9.86980E-03	3.46920E-02
7.45100E+02	2.49940E-02	3.77760E-01	9.44160E-03	3.31870E-02
7.45200E+02	2.38980E-02	3.77990E-01	9.03340E-03	3.17520E-02
7.45300E+02	2.28490E-02	3.78230E-01	8.64210E-03	3.03760E-02
7.45400E+02	2.18430E-02	3.78460E-01	8.26650E-03	2.90560E-02
7.45500E+02	2.08810E-02	3.78690E-01	7.90750E-03	2.77940E-02
7.45600E+02	1.99700E-02	3.78930E-01	7.56730E-03	2.65980E-02
7.45700E+02	1.91170E-02	3.79160E-01	7.24850E-03	2.54780E-02
7.45800E+02	1.83280E-02	3.79390E-01	6.95340E-03	2.44410E-02
7.45900E+02	1.76050E-02	3.79630E-01	6.68310E-03	2.34910E-02
7.46000E+02	1.69450E-02	3.79860E-01	6.43660E-03	2.26240E-02
7.46100E+02	1.63410E-02	3.80050E-01	6.21030E-03	2.18290E-02
7.46200E+02	1.57790E-02	3.80240E-01	6.00000E-03	2.10890E-02
7.46300E+02	1.52450E-02	3.80440E-01	5.79960E-03	2.03850E-02
7.46400E+02	1.47200E-02	3.80630E-01	5.60290E-03	1.96940E-02
7.46500E+02	1.41910E-02	3.80820E-01	5.40420E-03	1.89950E-02
7.46600E+02	1.36460E-02	3.81020E-01	5.19950E-03	1.82760E-02
7.46700E+02	1.30810E-02	3.81230E-01	4.98690E-03	1.75280E-02
7.46800E+02	1.24970E-02	3.81440E-01	4.76670E-03	1.67550E-02
7.46900E+02	1.19000E-02	3.81640E-01	4.54150E-03	1.59630E-02
7.47000E+02	1.13000E-02	3.81850E-01	4.31510E-03	1.51670E-02
7.47100E+02	1.07110E-02	3.82050E-01	4.09210E-03	1.43830E-02
7.47200E+02	1.01420E-02	3.82260E-01	3.87670E-03	1.36260E-02
7.47300E+02	9.60100E-03	3.82470E-01	3.67210E-03	1.29070E-02
7.47400E+02	9.09350E-03	3.82670E-01	3.47980E-03	1.22310E-02
7.47500E+02	8.61850E-03	3.82880E-01	3.29990E-03	1.15990E-02
7.47600E+02	8.17240E-03	3.83090E-01	3.13070E-03	1.10040E-02
7.47700E+02	7.74940E-03	3.83290E-01	2.97030E-03	1.04400E-02
7.47800E+02	7.34440E-03	3.83500E-01	2.81660E-03	9.90000E-03
7.47900E+02	6.95450E-03	3.83710E-01	2.66850E-03	9.37950E-03
7.48000E+02	6.58030E-03	3.83910E-01	2.52630E-03	8.87970E-03
7.48100E+02	6.22650E-03	3.84190E-01	2.39210E-03	8.40820E-03
7.48200E+02	5.90070E-03	3.84470E-01	2.26860E-03	7.97410E-03
7.48300E+02	5.61300E-03	3.84740E-01	2.15960E-03	7.59070E-03
7.48400E+02	5.37310E-03	3.85020E-01	2.06880E-03	7.27150E-03

7.48500E+02	5.18860E-03	3.85300E-01	1.99920E-03	7.02700E-03
7.48600E+02	5.06270E-03	3.85590E-01	1.95210E-03	6.86160E-03
7.48700E+02	4.99340E-03	3.85870E-01	1.92680E-03	6.77270E-03
7.48800E+02	4.97310E-03	3.86160E-01	1.92040E-03	6.75010E-03
7.48900E+02	4.99000E-03	3.86440E-01	1.92840E-03	6.77810E-03
7.49000E+02	5.02990E-03	3.86730E-01	1.94520E-03	6.83730E-03
7.49100E+02	5.07870E-03	3.87010E-01	1.96550E-03	6.90870E-03
7.49200E+02	5.12430E-03	3.87300E-01	1.98470E-03	6.97590E-03
7.49300E+02	5.15870E-03	3.87590E-01	1.99950E-03	7.02800E-03
7.49400E+02	5.17840E-03	3.87870E-01	2.00860E-03	7.06000E-03
7.49500E+02	5.18380E-03	3.88160E-01	2.01210E-03	7.07250E-03
7.49600E+02	5.17840E-03	3.88450E-01	2.01150E-03	7.07040E-03
7.49700E+02	5.16670E-03	3.88730E-01	2.00850E-03	7.05960E-03
7.49800E+02	5.15180E-03	3.89020E-01	2.00420E-03	7.04440E-03
7.49900E+02	5.13390E-03	3.89310E-01	1.99870E-03	7.02510E-03
7.50000E+02	5.10870E-03	3.89590E-01	1.99030E-03	6.99580E-03
7.50100E+02	5.06780E-03	3.89900E-01	1.97590E-03	6.94520E-03
7.50200E+02	5.00050E-03	3.90200E-01	1.95120E-03	6.85830E-03
7.50300E+02	4.89620E-03	3.90500E-01	1.91200E-03	6.72050E-03
7.50400E+02	4.74700E-03	3.90800E-01	1.85520E-03	6.52080E-03
7.50500E+02	3.69180E-03	3.91110E-01	1.44390E-03	5.07520E-03
7.50600E+02	3.05470E-03	3.91410E-01	1.19560E-03	4.20250E-03
7.50700E+02	2.60570E-03	3.91710E-01	1.02070E-03	3.58760E-03
7.50800E+02	2.33610E-03	3.92010E-01	9.15770E-04	3.21880E-03
7.50900E+02	2.20680E-03	3.92310E-01	8.65750E-04	3.04300E-03
7.51000E+02	2.15810E-03	3.92610E-01	8.47310E-04	2.97820E-03
7.51100E+02	2.12770E-03	3.92910E-01	8.36000E-04	2.93850E-03
7.51200E+02	2.06960E-03	3.93220E-01	8.13790E-04	2.86040E-03
7.51300E+02	1.96760E-03	3.93520E-01	7.74280E-04	2.72160E-03
7.51400E+02	1.83880E-03	3.93830E-01	7.24160E-04	2.54540E-03
7.51500E+02	0.00000E+00	3.94130E-01	0.00000E+00	0.00000E+00

Channel 7

Wavenumber	HIRS Filter Transmittance	Optical Element Transmittance	Product of the HIRS Filter and Optical Element Transmittances	Normalized Value of Column 4
7.28030E+02	0.00000E+00	3.55420E-01	0.00000E+00	0.00000E+00
7.29480E+02	1.30520E-03	3.56580E-01	4.65410E-04	1.59850E-03
7.30230E+02	2.89470E-03	3.57100E-01	1.03370E-03	3.55050E-03
7.31180E+02	5.47300E-03	3.57660E-01	1.95750E-03	6.72330E-03
7.32220E+02	9.90190E-03	3.58370E-01	3.54850E-03	1.21880E-02
7.33310E+02	1.67880E-02	3.59220E-01	6.03070E-03	2.07140E-02
7.33850E+02	2.62870E-02	3.59710E-01	9.45560E-03	3.24770E-02

7.34680E+02	3.85480E-02	3.60370E-01	1.38910E-02	4.77130E-02
7.35800E+02	5.48670E-02	3.61300E-01	1.98240E-02	6.80880E-02
7.36540E+02	7.86390E-02	3.62480E-01	2.85050E-02	9.79050E-02
7.37020E+02	1.15080E-01	3.63380E-01	4.18190E-02	1.43630E-01
7.38100E+02	1.69400E-01	3.65500E-01	6.19160E-02	2.12660E-01
7.39380E+02	2.43930E-01	3.68220E-01	8.98190E-02	3.08500E-01
7.40160E+02	3.35700E-01	3.69770E-01	1.24130E-01	4.26360E-01
7.40830E+02	4.35990E-01	3.70640E-01	1.61590E-01	5.55030E-01
7.41860E+02	5.32520E-01	3.71960E-01	1.98080E-01	6.80340E-01
7.42920E+02	6.13510E-01	3.73600E-01	2.29210E-01	7.87250E-01
7.43720E+02	6.71800E-01	3.74860E-01	2.51830E-01	8.64960E-01
7.44060E+02	7.06930E-01	3.75450E-01	2.65410E-01	9.11620E-01
7.44320E+02	7.24380E-01	3.75990E-01	2.72360E-01	9.35460E-01
7.44730E+02	7.32350E-01	3.76890E-01	2.76020E-01	9.48030E-01
7.44950E+02	7.37930E-01	3.77410E-01	2.78500E-01	9.56570E-01
7.45290E+02	7.44580E-01	3.78200E-01	2.81600E-01	9.67220E-01
7.45710E+02	7.51960E-01	3.79180E-01	2.85130E-01	9.79330E-01
7.46170E+02	7.57650E-01	3.80180E-01	2.88040E-01	9.89340E-01
7.46550E+02	7.59570E-01	3.80920E-01	2.89330E-01	9.93780E-01
7.47170E+02	7.57570E-01	3.82210E-01	2.89550E-01	9.94510E-01
7.47890E+02	7.53410E-01	3.83690E-01	2.89080E-01	9.92880E-01
7.48520E+02	7.49450E-01	3.85350E-01	2.88800E-01	9.91940E-01
7.49000E+02	7.47220E-01	3.86720E-01	2.88970E-01	9.92520E-01
7.49540E+02	7.46580E-01	3.88280E-01	2.89880E-01	9.95640E-01
7.49710E+02	7.46050E-01	3.88770E-01	2.90040E-01	9.96210E-01
7.50530E+02	7.43930E-01	3.91210E-01	2.91030E-01	9.99610E-01
7.51390E+02	7.39330E-01	3.93800E-01	2.91150E-01	1.00000E+00
7.52170E+02	7.32550E-01	3.96130E-01	2.90190E-01	9.96710E-01
7.52730E+02	7.24580E-01	3.97800E-01	2.88240E-01	9.90000E-01
7.53360E+02	7.16110E-01	3.99660E-01	2.86200E-01	9.83010E-01
7.54010E+02	7.06740E-01	4.01580E-01	2.83820E-01	9.74820E-01
7.54710E+02	6.94830E-01	4.03810E-01	2.80580E-01	9.63700E-01
7.55380E+02	6.78080E-01	4.05940E-01	2.75260E-01	9.45430E-01
7.55750E+02	6.54580E-01	4.07090E-01	2.66470E-01	9.15250E-01
7.56420E+02	6.23720E-01	4.08720E-01	2.54930E-01	8.75600E-01
7.56990E+02	5.86550E-01	4.09830E-01	2.40390E-01	8.25660E-01
7.57630E+02	5.45330E-01	4.11110E-01	2.24190E-01	7.70030E-01
7.58080E+02	5.02610E-01	4.12110E-01	2.07130E-01	7.11430E-01
7.58530E+02	4.60220E-01	4.13530E-01	1.90320E-01	6.53680E-01
7.58990E+02	4.18800E-01	4.15000E-01	1.73800E-01	5.96960E-01
7.59280E+02	3.77970E-01	4.15910E-01	1.57200E-01	5.39940E-01
7.59630E+02	3.37100E-01	4.17050E-01	1.40590E-01	4.82880E-01
7.60050E+02	2.96200E-01	4.18400E-01	1.23930E-01	4.25650E-01

7.60580E+02	2.56300E-01	4.20090E-01	1.07670E-01	3.69810E-01
7.60940E+02	2.19190E-01	4.21280E-01	9.23400E-02	3.17160E-01
7.61450E+02	1.86540E-01	4.22890E-01	7.88860E-02	2.70950E-01
7.61760E+02	1.59030E-01	4.23900E-01	6.74130E-02	2.31540E-01
7.62180E+02	1.35970E-01	4.25120E-01	5.78020E-02	1.98530E-01
7.62680E+02	1.15680E-01	4.26430E-01	4.93290E-02	1.69430E-01
7.63190E+02	9.64600E-02	4.27740E-01	4.12600E-02	1.41710E-01
7.63650E+02	7.74480E-02	4.28920E-01	3.32190E-02	1.14100E-01
7.64310E+02	5.89610E-02	4.30940E-01	2.54090E-02	8.72720E-02
7.65140E+02	4.21110E-02	4.33970E-01	1.82750E-02	6.27700E-02
7.65970E+02	2.80460E-02	4.37010E-01	1.22560E-02	4.20960E-02
7.67060E+02	1.73050E-02	4.40260E-01	7.61870E-03	2.61680E-02
7.68330E+02	9.64080E-03	4.44680E-01	4.28710E-03	1.47250E-02
7.69700E+02	4.37610E-03	4.51430E-01	1.97550E-03	6.78520E-03
7.71040E+02	9.49860E-04	4.56210E-01	4.33330E-04	1.48840E-03
7.72320E+02	0.00000E+00	4.60160E-01	0.00000E+00	0.00000E+00
Channel 8				
Wavenumber	HIRS Filter Transmittance	Optical Element Transmittance	Product of the HIRS Filter and Optical Element Transmittances	Normalized Value of Column 4
8.68680E+02	0.00000E+00	5.19840E-01	0.00000E+00	0.00000E+00
8.68780E+02	1.49200E-03	5.19800E-01	7.75570E-04	1.66610E-03
8.68880E+02	2.46640E-03	5.19770E-01	1.28200E-03	2.75400E-03
8.68980E+02	2.43280E-03	5.19740E-01	1.26440E-03	2.71630E-03
8.69080E+02	2.39490E-03	5.19710E-01	1.24470E-03	2.67380E-03
8.69180E+02	2.35610E-03	5.19680E-01	1.22440E-03	2.63040E-03
8.69280E+02	2.32050E-03	5.19650E-01	1.20590E-03	2.59050E-03
8.69380E+02	2.29250E-03	5.19620E-01	1.19130E-03	2.55910E-03
8.69480E+02	2.27690E-03	5.19590E-01	1.18310E-03	2.54150E-03
8.69580E+02	2.27830E-03	5.19570E-01	1.18370E-03	2.54290E-03
8.69680E+02	2.30080E-03	5.19540E-01	1.19540E-03	2.56790E-03
8.69780E+02	2.34810E-03	5.19520E-01	1.21990E-03	2.62060E-03
8.69880E+02	2.42300E-03	5.19490E-01	1.25870E-03	2.70400E-03
8.69980E+02	2.52700E-03	5.19460E-01	1.31270E-03	2.82000E-03
8.70080E+02	2.66080E-03	5.19480E-01	1.38220E-03	2.96930E-03
8.70180E+02	2.82350E-03	5.19510E-01	1.46680E-03	3.15110E-03
8.70280E+02	3.01350E-03	5.19530E-01	1.56560E-03	3.36330E-03
8.70380E+02	3.22770E-03	5.19560E-01	1.67700E-03	3.60250E-03
8.70480E+02	3.46230E-03	5.19590E-01	1.79900E-03	3.86460E-03
8.70580E+02	3.71310E-03	5.19620E-01	1.92940E-03	4.14470E-03
8.70680E+02	3.97510E-03	5.19650E-01	2.06570E-03	4.43750E-03
8.70780E+02	4.24370E-03	5.19680E-01	2.20540E-03	4.73760E-03

8.70880E+02	4.51430E-03	5.19710E-01	2.34620E-03	5.04010E-03
8.70980E+02	4.78300E-03	5.19740E-01	2.48590E-03	5.34040E-03
8.71080E+02	5.04660E-03	5.19780E-01	2.62310E-03	5.63500E-03
8.71180E+02	5.30260E-03	5.19810E-01	2.75640E-03	5.92130E-03
8.71280E+02	5.55020E-03	5.19840E-01	2.88520E-03	6.19810E-03
8.71380E+02	5.78920E-03	5.19880E-01	3.00970E-03	6.46550E-03
8.71480E+02	6.02090E-03	5.19910E-01	3.13030E-03	6.72460E-03
8.71580E+02	6.24730E-03	5.19950E-01	3.24830E-03	6.97800E-03
8.71680E+02	6.47170E-03	5.19980E-01	3.36520E-03	7.22920E-03
8.71780E+02	6.69780E-03	5.20020E-01	3.48300E-03	7.48220E-03
8.71880E+02	6.92960E-03	5.20060E-01	3.60380E-03	7.74170E-03
8.71980E+02	7.17150E-03	5.20090E-01	3.72980E-03	8.01250E-03
8.72080E+02	7.42740E-03	5.20190E-01	3.86370E-03	8.30000E-03
8.72180E+02	7.70120E-03	5.20290E-01	4.00690E-03	8.60770E-03
8.72280E+02	7.99560E-03	5.20400E-01	4.16090E-03	8.93860E-03
8.72380E+02	8.31280E-03	5.20510E-01	4.32690E-03	9.29520E-03
8.72480E+02	8.65400E-03	5.20620E-01	4.50540E-03	9.67860E-03
8.72580E+02	9.01920E-03	5.20730E-01	4.69650E-03	1.00890E-02
8.72680E+02	9.40770E-03	5.20840E-01	4.89990E-03	1.05260E-02
8.72780E+02	9.81790E-03	5.20940E-01	5.11460E-03	1.09870E-02
8.72880E+02	1.02470E-02	5.21060E-01	5.33950E-03	1.14700E-02
8.72980E+02	1.06940E-02	5.21170E-01	5.57330E-03	1.19730E-02
8.73080E+02	1.11540E-02	5.21280E-01	5.81420E-03	1.24900E-02
8.73180E+02	1.16250E-02	5.21380E-01	6.06090E-03	1.30200E-02
8.73280E+02	1.21040E-02	5.21490E-01	6.31200E-03	1.35600E-02
8.73380E+02	1.25890E-02	5.21600E-01	6.56670E-03	1.41070E-02
8.73480E+02	1.30800E-02	5.21710E-01	6.82400E-03	1.46600E-02
8.73580E+02	1.35760E-02	5.21820E-01	7.08410E-03	1.52180E-02
8.73680E+02	1.40770E-02	5.21930E-01	7.34710E-03	1.57830E-02
8.73780E+02	1.45850E-02	5.22050E-01	7.61390E-03	1.63560E-02
8.73880E+02	1.51030E-02	5.22170E-01	7.88620E-03	1.69410E-02
8.73980E+02	1.56340E-02	5.22310E-01	8.16560E-03	1.75420E-02
8.74080E+02	1.61820E-02	5.22400E-01	8.45350E-03	1.81600E-02
8.74180E+02	1.67520E-02	5.22490E-01	8.75250E-03	1.88020E-02
8.74280E+02	1.73470E-02	5.22570E-01	9.06510E-03	1.94740E-02
8.74380E+02	1.79730E-02	5.22660E-01	9.39380E-03	2.01800E-02
8.74480E+02	1.86330E-02	5.22750E-01	9.74020E-03	2.09240E-02
8.74580E+02	1.93300E-02	5.22840E-01	1.01060E-02	2.17110E-02
8.74680E+02	2.00670E-02	5.22930E-01	1.04930E-02	2.25420E-02
8.74780E+02	2.08450E-02	5.23020E-01	1.09020E-02	2.34210E-02
8.74880E+02	2.16650E-02	5.23110E-01	1.13330E-02	2.43460E-02
8.74980E+02	2.25250E-02	5.23200E-01	1.17850E-02	2.53170E-02
8.75080E+02	2.34250E-02	5.23290E-01	1.22580E-02	2.63340E-02

8.75180E+02	2.43630E-02	5.23380E-01	1.27510E-02	2.73920E-02
8.75280E+02	2.53350E-02	5.23480E-01	1.32620E-02	2.84900E-02
8.75380E+02	2.63380E-02	5.23570E-01	1.37900E-02	2.96230E-02
8.75480E+02	2.73690E-02	5.23670E-01	1.43320E-02	3.07890E-02
8.75580E+02	2.84260E-02	5.23760E-01	1.48880E-02	3.19830E-02
8.75680E+02	2.95050E-02	5.23860E-01	1.54560E-02	3.32040E-02
8.75780E+02	3.06050E-02	5.23950E-01	1.60360E-02	3.44480E-02
8.75880E+02	3.17260E-02	5.24040E-01	1.66260E-02	3.57160E-02
8.75980E+02	3.05580E-02	5.24130E-01	1.60160E-02	3.44060E-02
8.76080E+02	3.15430E-02	5.24180E-01	1.65340E-02	3.55190E-02
8.76180E+02	3.26260E-02	5.24220E-01	1.71030E-02	3.67420E-02
8.76280E+02	3.38080E-02	5.24260E-01	1.77240E-02	3.80750E-02
8.76380E+02	3.50830E-02	5.24300E-01	1.83940E-02	3.95150E-02
8.76480E+02	3.64460E-02	5.24350E-01	1.91100E-02	4.10530E-02
8.76580E+02	3.78860E-02	5.24390E-01	1.98670E-02	4.26790E-02
8.76680E+02	3.93920E-02	5.24430E-01	2.06580E-02	4.43790E-02
8.76780E+02	4.09510E-02	5.24480E-01	2.14780E-02	4.61390E-02
8.76880E+02	4.25530E-02	5.24520E-01	2.23200E-02	4.79480E-02
8.76980E+02	4.41880E-02	5.24560E-01	2.31790E-02	4.97950E-02
8.77080E+02	4.58490E-02	5.24610E-01	2.40530E-02	5.16710E-02
8.77180E+02	4.75340E-02	5.24660E-01	2.49390E-02	5.35750E-02
8.77280E+02	4.92430E-02	5.24700E-01	2.58380E-02	5.55050E-02
8.77380E+02	5.09800E-02	5.24750E-01	2.67520E-02	5.74690E-02
8.77480E+02	5.27560E-02	5.24790E-01	2.76860E-02	5.94750E-02
8.77580E+02	5.45820E-02	5.24840E-01	2.86470E-02	6.15390E-02
8.77680E+02	5.64750E-02	5.24880E-01	2.96430E-02	6.36790E-02
8.77780E+02	5.84540E-02	5.24930E-01	3.06840E-02	6.59160E-02
8.77880E+02	6.05380E-02	5.24970E-01	3.17810E-02	6.82720E-02
8.77980E+02	6.27490E-02	5.25010E-01	3.29440E-02	7.07710E-02
8.78080E+02	6.51060E-02	5.25030E-01	3.41830E-02	7.34320E-02
8.78180E+02	6.76280E-02	5.25050E-01	3.55080E-02	7.62800E-02
8.78280E+02	7.03330E-02	5.25060E-01	3.69290E-02	7.93320E-02
8.78380E+02	7.32340E-02	5.25080E-01	3.84530E-02	8.26070E-02
8.78480E+02	7.63400E-02	5.25090E-01	4.00860E-02	8.61140E-02
8.78580E+02	7.96600E-02	5.25110E-01	4.18300E-02	8.98610E-02
8.78680E+02	8.31960E-02	5.25130E-01	4.36880E-02	9.38520E-02
8.78780E+02	8.69470E-02	5.25140E-01	4.56600E-02	9.80880E-02
8.78880E+02	9.09110E-02	5.25160E-01	4.77430E-02	1.02560E-01
8.78980E+02	9.50820E-02	5.25180E-01	4.99350E-02	1.07270E-01
8.79080E+02	9.94520E-02	5.25190E-01	5.22310E-02	1.12200E-01
8.79180E+02	1.04010E-01	5.25210E-01	5.46280E-02	1.17350E-01
8.79280E+02	1.08760E-01	5.25220E-01	5.71210E-02	1.22710E-01
8.79380E+02	1.13670E-01	5.25240E-01	5.97060E-02	1.28260E-01

8.79480E+02	1.18760E-01	5.25250E-01	6.23790E-02	1.34000E-01
8.79580E+02	1.24010E-01	5.25270E-01	6.51370E-02	1.39930E-01
8.79680E+02	1.29420E-01	5.25280E-01	6.79800E-02	1.46040E-01
8.79780E+02	1.34990E-01	5.25300E-01	7.09090E-02	1.52330E-01
8.79880E+02	1.40720E-01	5.25320E-01	7.39220E-02	1.58800E-01
8.79980E+02	1.46620E-01	5.25330E-01	7.70230E-02	1.65460E-01
8.80080E+02	1.52690E-01	5.25410E-01	8.02250E-02	1.72340E-01
8.80180E+02	1.58940E-01	5.25500E-01	8.35250E-02	1.79430E-01
8.80280E+02	1.65390E-01	5.25590E-01	8.69270E-02	1.86740E-01
8.80380E+02	1.72030E-01	5.25680E-01	9.04360E-02	1.94280E-01
8.80480E+02	1.78890E-01	5.25770E-01	9.40560E-02	2.02050E-01
8.80580E+02	1.85970E-01	5.25870E-01	9.77940E-02	2.10080E-01
8.80680E+02	1.93270E-01	5.25960E-01	1.01650E-01	2.18370E-01
8.80780E+02	2.00810E-01	5.26050E-01	1.05630E-01	2.26930E-01
8.80880E+02	2.08580E-01	5.26140E-01	1.09740E-01	2.35750E-01
8.80980E+02	2.16600E-01	5.26230E-01	1.13980E-01	2.44860E-01
8.81080E+02	2.24860E-01	5.26320E-01	1.18350E-01	2.54240E-01
8.81180E+02	2.33370E-01	5.26410E-01	1.22850E-01	2.63900E-01
8.81280E+02	2.42110E-01	5.26510E-01	1.27470E-01	2.73840E-01
8.81380E+02	2.51090E-01	5.26600E-01	1.32220E-01	2.84050E-01
8.81480E+02	2.60300E-01	5.26690E-01	1.37100E-01	2.94520E-01
8.81580E+02	2.69740E-01	5.26790E-01	1.42100E-01	3.05260E-01
8.81680E+02	2.79400E-01	5.26900E-01	1.47210E-01	3.16250E-01
8.81780E+02	2.89270E-01	5.27000E-01	1.52450E-01	3.27490E-01
8.81880E+02	2.99350E-01	5.27100E-01	1.57790E-01	3.38970E-01
8.81980E+02	3.09630E-01	5.27210E-01	1.63240E-01	3.50680E-01
8.82080E+02	3.20110E-01	5.27230E-01	1.68770E-01	3.62570E-01
8.82180E+02	3.30780E-01	5.27240E-01	1.74400E-01	3.74660E-01
8.82280E+02	3.41640E-01	5.27250E-01	1.80130E-01	3.86960E-01
8.82380E+02	3.52680E-01	5.27250E-01	1.85950E-01	3.99460E-01
8.82480E+02	3.63890E-01	5.27260E-01	1.91860E-01	4.12170E-01
8.82580E+02	3.75270E-01	5.27270E-01	1.97870E-01	4.25060E-01
8.82680E+02	3.86800E-01	5.27270E-01	2.03950E-01	4.38130E-01
8.82780E+02	3.98490E-01	5.27280E-01	2.10110E-01	4.51370E-01
8.82880E+02	4.10310E-01	5.27290E-01	2.16350E-01	4.64770E-01
8.82980E+02	4.22250E-01	5.27290E-01	2.22650E-01	4.78300E-01
8.83080E+02	4.34300E-01	5.27300E-01	2.29010E-01	4.91960E-01
8.83180E+02	4.46440E-01	5.27310E-01	2.35420E-01	5.05730E-01
8.83280E+02	4.58660E-01	5.27320E-01	2.41860E-01	5.19570E-01
8.83380E+02	4.70920E-01	5.27340E-01	2.48330E-01	5.33470E-01
8.83480E+02	4.83210E-01	5.27340E-01	2.54820E-01	5.47400E-01
8.83580E+02	4.95500E-01	5.27340E-01	2.61300E-01	5.61330E-01
8.83680E+02	5.07770E-01	5.27340E-01	2.67770E-01	5.75230E-01

8.83780E+02	5.19990E-01	5.27340E-01	2.74220E-01	5.89080E-01
8.83880E+02	5.32150E-01	5.27350E-01	2.80630E-01	6.02850E-01
8.83980E+02	5.44220E-01	5.27350E-01	2.86990E-01	6.16530E-01
8.84080E+02	5.56180E-01	5.27400E-01	2.93330E-01	6.30130E-01
8.84180E+02	5.68000E-01	5.27460E-01	2.99600E-01	6.43610E-01
8.84280E+02	5.79680E-01	5.27530E-01	3.05800E-01	6.56920E-01
8.84380E+02	5.91190E-01	5.27590E-01	3.11910E-01	6.70050E-01
8.84480E+02	6.02530E-01	5.27660E-01	3.17930E-01	6.82980E-01
8.84580E+02	6.13670E-01	5.27720E-01	3.23850E-01	6.95700E-01
8.84680E+02	6.24620E-01	5.27790E-01	3.29660E-01	7.08190E-01
8.84780E+02	6.35350E-01	5.27850E-01	3.35370E-01	7.20450E-01
8.84880E+02	6.45880E-01	5.27910E-01	3.40970E-01	7.32470E-01
8.84980E+02	6.56180E-01	5.27980E-01	3.46450E-01	7.44250E-01
8.85080E+02	6.66250E-01	5.28040E-01	3.51810E-01	7.55760E-01
8.85180E+02	6.76090E-01	5.28100E-01	3.57040E-01	7.67010E-01
8.85280E+02	6.85700E-01	5.28160E-01	3.62160E-01	7.77990E-01
8.85380E+02	6.95060E-01	5.28210E-01	3.67140E-01	7.88700E-01
8.85480E+02	7.04170E-01	5.28270E-01	3.71990E-01	7.99130E-01
8.85580E+02	7.13030E-01	5.28320E-01	3.76710E-01	8.09270E-01
8.85680E+02	7.21630E-01	5.28380E-01	3.81300E-01	8.19110E-01
8.85780E+02	7.29970E-01	5.28430E-01	3.85740E-01	8.28660E-01
8.85880E+02	7.38030E-01	5.28490E-01	3.90040E-01	8.37890E-01
8.85980E+02	7.45820E-01	5.28540E-01	3.94190E-01	8.46820E-01
8.86080E+02	7.53320E-01	5.28510E-01	3.98140E-01	8.55290E-01
8.86180E+02	7.60540E-01	5.28470E-01	4.01920E-01	8.63410E-01
8.86280E+02	7.67470E-01	5.28420E-01	4.05550E-01	8.71210E-01
8.86380E+02	7.74120E-01	5.28370E-01	4.09020E-01	8.78680E-01
8.86480E+02	7.80480E-01	5.28330E-01	4.12350E-01	8.85820E-01
8.86580E+02	7.86550E-01	5.28280E-01	4.15520E-01	8.92640E-01
8.86680E+02	7.92360E-01	5.28230E-01	4.18550E-01	8.99140E-01
8.86780E+02	7.97880E-01	5.28190E-01	4.21430E-01	9.05330E-01
8.86880E+02	8.03150E-01	5.28140E-01	4.24170E-01	9.11220E-01
8.86980E+02	8.08160E-01	5.28090E-01	4.26780E-01	9.16820E-01
8.87080E+02	8.12930E-01	5.28040E-01	4.29260E-01	9.22150E-01
8.87180E+02	8.17470E-01	5.27990E-01	4.31610E-01	9.27210E-01
8.87280E+02	8.21780E-01	5.27940E-01	4.33850E-01	9.32010E-01
8.87380E+02	8.25890E-01	5.27890E-01	4.35980E-01	9.36580E-01
8.87480E+02	8.29790E-01	5.27840E-01	4.38000E-01	9.40920E-01
8.87580E+02	8.33500E-01	5.27800E-01	4.39920E-01	9.45050E-01
8.87680E+02	8.37030E-01	5.27750E-01	4.41740E-01	9.48960E-01
8.87780E+02	8.40380E-01	5.27700E-01	4.43470E-01	9.52660E-01
8.87880E+02	8.43550E-01	5.27650E-01	4.45100E-01	9.56170E-01
8.87980E+02	8.46550E-01	5.27600E-01	4.46640E-01	9.59480E-01

8.88080E+02	8.49380E-01	5.27600E-01	4.48130E-01	9.62680E-01
8.88180E+02	8.52040E-01	5.27600E-01	4.49530E-01	9.65700E-01
8.88280E+02	8.54530E-01	5.27600E-01	4.50850E-01	9.68530E-01
8.88380E+02	8.56850E-01	5.27610E-01	4.52080E-01	9.71180E-01
8.88480E+02	8.59010E-01	5.27610E-01	4.53230E-01	9.73630E-01
8.88580E+02	8.61010E-01	5.27620E-01	4.54280E-01	9.75900E-01
8.88680E+02	8.62850E-01	5.27620E-01	4.55260E-01	9.77990E-01
8.88780E+02	8.64530E-01	5.27620E-01	4.56140E-01	9.79900E-01
8.88880E+02	8.66060E-01	5.27630E-01	4.56960E-01	9.81640E-01
8.88980E+02	8.67450E-01	5.27630E-01	4.57690E-01	9.83230E-01
8.89080E+02	8.68710E-01	5.27630E-01	4.58360E-01	9.84670E-01
8.89180E+02	8.69860E-01	5.27640E-01	4.58970E-01	9.85970E-01
8.89280E+02	8.70900E-01	5.27640E-01	4.59520E-01	9.87160E-01
8.89380E+02	8.71850E-01	5.27650E-01	4.60030E-01	9.88240E-01
8.89480E+02	8.72720E-01	5.27650E-01	4.60490E-01	9.89250E-01
8.89580E+02	8.73530E-01	5.27660E-01	4.60930E-01	9.90180E-01
8.89680E+02	8.74290E-01	5.27670E-01	4.61330E-01	9.91050E-01
8.89780E+02	8.75010E-01	5.27670E-01	4.61720E-01	9.91880E-01
8.89880E+02	8.75710E-01	5.27680E-01	4.62090E-01	9.92680E-01
8.89980E+02	8.76380E-01	5.27680E-01	4.62450E-01	9.93450E-01
8.90080E+02	8.77030E-01	5.27670E-01	4.62780E-01	9.94170E-01
8.90180E+02	8.77670E-01	5.27660E-01	4.63110E-01	9.94860E-01
8.90280E+02	8.78290E-01	5.27640E-01	4.63420E-01	9.95530E-01
8.90380E+02	8.78890E-01	5.27620E-01	4.63720E-01	9.96180E-01
8.90480E+02	8.79470E-01	5.27610E-01	4.64010E-01	9.96810E-01
8.90580E+02	8.80020E-01	5.27590E-01	4.64290E-01	9.97390E-01
8.90680E+02	8.80520E-01	5.27570E-01	4.64540E-01	9.97930E-01
8.90780E+02	8.80980E-01	5.27550E-01	4.64770E-01	9.98420E-01
8.90880E+02	8.81390E-01	5.27540E-01	4.64970E-01	9.98850E-01
8.90980E+02	8.81730E-01	5.27520E-01	4.65130E-01	9.99210E-01
8.91080E+02	8.82010E-01	5.27510E-01	4.65270E-01	9.99500E-01
8.91180E+02	8.82230E-01	5.27490E-01	4.65370E-01	9.99710E-01
8.91280E+02	8.82370E-01	5.27490E-01	4.65440E-01	9.99880E-01
8.91380E+02	8.82450E-01	5.27490E-01	4.65490E-01	9.99970E-01
8.91480E+02	8.82480E-01	5.27490E-01	4.65500E-01	1.00000E+00
8.91580E+02	8.82450E-01	5.27490E-01	4.65490E-01	9.99970E-01
8.91680E+02	8.82390E-01	5.27490E-01	4.65450E-01	9.99890E-01
8.91780E+02	8.82300E-01	5.27490E-01	4.65400E-01	9.99790E-01
8.91880E+02	8.82190E-01	5.27490E-01	4.65340E-01	9.99670E-01
8.91980E+02	8.82080E-01	5.27490E-01	4.65290E-01	9.99540E-01
8.92080E+02	8.81970E-01	5.27450E-01	4.65200E-01	9.99350E-01
8.92180E+02	8.81890E-01	5.27400E-01	4.65110E-01	9.99160E-01
8.92280E+02	8.81830E-01	5.27350E-01	4.65040E-01	9.99000E-01

8.92380E+02	8.81800E-01	5.27300E-01	4.64980E-01	9.98880E-01
8.92480E+02	8.81810E-01	5.27260E-01	4.64940E-01	9.98790E-01
8.92580E+02	8.81840E-01	5.27210E-01	4.64910E-01	9.98740E-01
8.92680E+02	8.81900E-01	5.27160E-01	4.64900E-01	9.98710E-01
8.92780E+02	8.81970E-01	5.27110E-01	4.64900E-01	9.98700E-01
8.92880E+02	8.82050E-01	5.27060E-01	4.64900E-01	9.98700E-01
8.92980E+02	8.82120E-01	5.27010E-01	4.64890E-01	9.98690E-01
8.93080E+02	8.82170E-01	5.26970E-01	4.64880E-01	9.98660E-01
8.93180E+02	8.82180E-01	5.26960E-01	4.64870E-01	9.98650E-01
8.93280E+02	8.82140E-01	5.26960E-01	4.64850E-01	9.98610E-01
8.93380E+02	8.82050E-01	5.26960E-01	4.64800E-01	9.98500E-01
8.93480E+02	8.81880E-01	5.26960E-01	4.64710E-01	9.98310E-01
8.93580E+02	8.81630E-01	5.26960E-01	4.64580E-01	9.98030E-01
8.93680E+02	8.81310E-01	5.26960E-01	4.64410E-01	9.97660E-01
8.93780E+02	8.80920E-01	5.26950E-01	4.64200E-01	9.97210E-01
8.93880E+02	8.80450E-01	5.26950E-01	4.63960E-01	9.96690E-01
8.93980E+02	8.79930E-01	5.26950E-01	4.63680E-01	9.96090E-01
8.94080E+02	8.79350E-01	5.26980E-01	4.63400E-01	9.95500E-01
8.94180E+02	8.78750E-01	5.27020E-01	4.63120E-01	9.94880E-01
8.94280E+02	8.78130E-01	5.27050E-01	4.62820E-01	9.94240E-01
8.94380E+02	8.77510E-01	5.27090E-01	4.62530E-01	9.93610E-01
8.94480E+02	8.76910E-01	5.27120E-01	4.62240E-01	9.92990E-01
8.94580E+02	8.76350E-01	5.27150E-01	4.61970E-01	9.92420E-01
8.94680E+02	8.75830E-01	5.27190E-01	4.61730E-01	9.91890E-01
8.94780E+02	8.75360E-01	5.27220E-01	4.61510E-01	9.91430E-01
8.94880E+02	8.74940E-01	5.27260E-01	4.61320E-01	9.91020E-01
8.94980E+02	8.74580E-01	5.27290E-01	4.61160E-01	9.90680E-01
8.95080E+02	8.74280E-01	5.27350E-01	4.61050E-01	9.90430E-01
8.95180E+02	8.74010E-01	5.27410E-01	4.60970E-01	9.90260E-01
8.95280E+02	8.73770E-01	5.27480E-01	4.60900E-01	9.90120E-01
8.95380E+02	8.73540E-01	5.27550E-01	4.60840E-01	9.89990E-01
8.95480E+02	8.73310E-01	5.27620E-01	4.60780E-01	9.89850E-01
8.95580E+02	8.73050E-01	5.27690E-01	4.60700E-01	9.89690E-01
8.95680E+02	8.72740E-01	5.27760E-01	4.60600E-01	9.89470E-01
8.95780E+02	8.72380E-01	5.27830E-01	4.60470E-01	9.89190E-01
8.95880E+02	8.71930E-01	5.27900E-01	4.60290E-01	9.88810E-01
8.95980E+02	8.71400E-01	5.27970E-01	4.60070E-01	9.88340E-01
8.96080E+02	8.70780E-01	5.28020E-01	4.59790E-01	9.87720E-01
8.96180E+02	8.70070E-01	5.28050E-01	4.59440E-01	9.86990E-01
8.96280E+02	8.69270E-01	5.28090E-01	4.59050E-01	9.86150E-01
8.96380E+02	8.68390E-01	5.28130E-01	4.58620E-01	9.85230E-01
8.96480E+02	8.67450E-01	5.28170E-01	4.58160E-01	9.84230E-01
8.96580E+02	8.66470E-01	5.28210E-01	4.57680E-01	9.83200E-01

8.96680E+02	8.65470E-01	5.28250E-01	4.57180E-01	9.82130E-01
8.96780E+02	8.64480E-01	5.28280E-01	4.56690E-01	9.81080E-01
8.96880E+02	8.63510E-01	5.28320E-01	4.56210E-01	9.80050E-01
8.96980E+02	8.62600E-01	5.28370E-01	4.55770E-01	9.79090E-01
8.97080E+02	8.61750E-01	5.28430E-01	4.55380E-01	9.78250E-01
8.97180E+02	8.61000E-01	5.28490E-01	4.55030E-01	9.77510E-01
8.97280E+02	8.60350E-01	5.28550E-01	4.54740E-01	9.76880E-01
8.97380E+02	8.59800E-01	5.28620E-01	4.54510E-01	9.76380E-01
8.97480E+02	8.59360E-01	5.28680E-01	4.54330E-01	9.76000E-01
8.97580E+02	8.59030E-01	5.28740E-01	4.54210E-01	9.75740E-01
8.97680E+02	8.58790E-01	5.28810E-01	4.54130E-01	9.75580E-01
8.97780E+02	8.58620E-01	5.28870E-01	4.54100E-01	9.75510E-01
8.97880E+02	8.58510E-01	5.28930E-01	4.54100E-01	9.75500E-01
8.97980E+02	8.58430E-01	5.29000E-01	4.54110E-01	9.75520E-01
8.98080E+02	8.58350E-01	5.29060E-01	4.54120E-01	9.75550E-01
8.98180E+02	8.58260E-01	5.29110E-01	4.54120E-01	9.75540E-01
8.98280E+02	8.58110E-01	5.29170E-01	4.54090E-01	9.75490E-01
8.98380E+02	8.57900E-01	5.29230E-01	4.54030E-01	9.75360E-01
8.98480E+02	8.57600E-01	5.29290E-01	4.53920E-01	9.75120E-01
8.98580E+02	8.57200E-01	5.29350E-01	4.53760E-01	9.74780E-01
8.98680E+02	8.56690E-01	5.29410E-01	4.53540E-01	9.74310E-01
8.98780E+02	8.56060E-01	5.29470E-01	4.53260E-01	9.73710E-01
8.98880E+02	8.55340E-01	5.29530E-01	4.52930E-01	9.72990E-01
8.98980E+02	8.54520E-01	5.29610E-01	4.52560E-01	9.72200E-01
8.99080E+02	8.53610E-01	5.29690E-01	4.52150E-01	9.71320E-01
8.99180E+02	8.52660E-01	5.29770E-01	4.51710E-01	9.70390E-01
8.99280E+02	8.51670E-01	5.29860E-01	4.51260E-01	9.69410E-01
8.99380E+02	8.50670E-01	5.29940E-01	4.50800E-01	9.68430E-01
8.99480E+02	8.49700E-01	5.30020E-01	4.50360E-01	9.67470E-01
8.99580E+02	8.48780E-01	5.30100E-01	4.49940E-01	9.66570E-01
8.99680E+02	8.47930E-01	5.30180E-01	4.49560E-01	9.65760E-01
8.99780E+02	8.47180E-01	5.30270E-01	4.49230E-01	9.65050E-01
8.99880E+02	8.46550E-01	5.30350E-01	4.48960E-01	9.64480E-01
8.99980E+02	8.46040E-01	5.30430E-01	4.48760E-01	9.64050E-01
9.00080E+02	8.45660E-01	5.30470E-01	4.48600E-01	9.63680E-01
9.00180E+02	8.45420E-01	5.30490E-01	4.48490E-01	9.63450E-01
9.00280E+02	8.45310E-01	5.30510E-01	4.48440E-01	9.63360E-01
9.00380E+02	8.45310E-01	5.30540E-01	4.48470E-01	9.63410E-01
9.00480E+02	8.45410E-01	5.30560E-01	4.48540E-01	9.63560E-01
9.00580E+02	8.45590E-01	5.30580E-01	4.48660E-01	9.63820E-01
9.00680E+02	8.45840E-01	5.30600E-01	4.48800E-01	9.64130E-01
9.00780E+02	8.46110E-01	5.30630E-01	4.48970E-01	9.64490E-01
9.00880E+02	8.46400E-01	5.30650E-01	4.49140E-01	9.64860E-01

9.00980E+02	8.46680E-01	5.30680E-01	4.49310E-01	9.65230E-01
9.01080E+02	8.46920E-01	5.30700E-01	4.49460E-01	9.65550E-01
9.01180E+02	8.47120E-01	5.30730E-01	4.49590E-01	9.65820E-01
9.01280E+02	8.47250E-01	5.30750E-01	4.49680E-01	9.66010E-01
9.01380E+02	8.47300E-01	5.30780E-01	4.49730E-01	9.66120E-01
9.01480E+02	8.47270E-01	5.30800E-01	4.49740E-01	9.66130E-01
9.01580E+02	8.47170E-01	5.30830E-01	4.49700E-01	9.66060E-01
9.01680E+02	8.46990E-01	5.30850E-01	4.49630E-01	9.65900E-01
9.01780E+02	8.46750E-01	5.30880E-01	4.49520E-01	9.65660E-01
9.01880E+02	8.46450E-01	5.30900E-01	4.49380E-01	9.65370E-01
9.01980E+02	8.46110E-01	5.30920E-01	4.49220E-01	9.65020E-01
9.02080E+02	8.45750E-01	5.30960E-01	4.49060E-01	9.64690E-01
9.02180E+02	8.45380E-01	5.31010E-01	4.48910E-01	9.64350E-01
9.02280E+02	8.45030E-01	5.31050E-01	4.48760E-01	9.64030E-01
9.02380E+02	8.44710E-01	5.31100E-01	4.48620E-01	9.63740E-01
9.02480E+02	8.44430E-01	5.31140E-01	4.48510E-01	9.63500E-01
9.02580E+02	8.44200E-01	5.31180E-01	4.48430E-01	9.63320E-01
9.02680E+02	8.44040E-01	5.31230E-01	4.48380E-01	9.63220E-01
9.02780E+02	8.43950E-01	5.31260E-01	4.48360E-01	9.63170E-01
9.02880E+02	8.43930E-01	5.31270E-01	4.48350E-01	9.63160E-01
9.02980E+02	8.43980E-01	5.31280E-01	4.48390E-01	9.63240E-01
9.03080E+02	8.44090E-01	5.31280E-01	4.48450E-01	9.63380E-01
9.03180E+02	8.44270E-01	5.31290E-01	4.48550E-01	9.63590E-01
9.03280E+02	8.44490E-01	5.31290E-01	4.48670E-01	9.63850E-01
9.03380E+02	8.44750E-01	5.31300E-01	4.48820E-01	9.64160E-01
9.03480E+02	8.45050E-01	5.31300E-01	4.48980E-01	9.64500E-01
9.03580E+02	8.45360E-01	5.31300E-01	4.49140E-01	9.64860E-01
9.03680E+02	8.45670E-01	5.31310E-01	4.49310E-01	9.65230E-01
9.03780E+02	8.45980E-01	5.31310E-01	4.49480E-01	9.65590E-01
9.03880E+02	8.46280E-01	5.31320E-01	4.49640E-01	9.65940E-01
9.03980E+02	8.46570E-01	5.31320E-01	4.49800E-01	9.66260E-01
9.04080E+02	8.46820E-01	5.31340E-01	4.49950E-01	9.66600E-01
9.04180E+02	8.47060E-01	5.31370E-01	4.50100E-01	9.66910E-01
9.04280E+02	8.47260E-01	5.31390E-01	4.50230E-01	9.67190E-01
9.04380E+02	8.47440E-01	5.31420E-01	4.50350E-01	9.67450E-01
9.04480E+02	8.47600E-01	5.31440E-01	4.50450E-01	9.67680E-01
9.04580E+02	8.47740E-01	5.31470E-01	4.50550E-01	9.67880E-01
9.04680E+02	8.47870E-01	5.31490E-01	4.50640E-01	9.68070E-01
9.04780E+02	8.47980E-01	5.31500E-01	4.50700E-01	9.68210E-01
9.04880E+02	8.48090E-01	5.31510E-01	4.50770E-01	9.68350E-01
9.04980E+02	8.48190E-01	5.31520E-01	4.50830E-01	9.68480E-01
9.05080E+02	8.48290E-01	5.31520E-01	4.50890E-01	9.68600E-01
9.05180E+02	8.48380E-01	5.31530E-01	4.50940E-01	9.68720E-01

9.05280E+02	8.48470E-01	5.31530E-01	4.50990E-01	9.68820E-01
9.05380E+02	8.48560E-01	5.31530E-01	4.51030E-01	9.68920E-01
9.05480E+02	8.48630E-01	5.31530E-01	4.51070E-01	9.69010E-01
9.05580E+02	8.48690E-01	5.31530E-01	4.51100E-01	9.69070E-01
9.05680E+02	8.48720E-01	5.31530E-01	4.51120E-01	9.69110E-01
9.05780E+02	8.48730E-01	5.31530E-01	4.51130E-01	9.69120E-01
9.05880E+02	8.48700E-01	5.31530E-01	4.51110E-01	9.69090E-01
9.05980E+02	8.48640E-01	5.31530E-01	4.51080E-01	9.69020E-01
9.06080E+02	8.48530E-01	5.31510E-01	4.51000E-01	9.68860E-01
9.06180E+02	8.48380E-01	5.31490E-01	4.50900E-01	9.68640E-01
9.06280E+02	8.48180E-01	5.31460E-01	4.50780E-01	9.68370E-01
9.06380E+02	8.47940E-01	5.31440E-01	4.50630E-01	9.68050E-01
9.06480E+02	8.47660E-01	5.31410E-01	4.50460E-01	9.67690E-01
9.06580E+02	8.47350E-01	5.31390E-01	4.50270E-01	9.67290E-01
9.06680E+02	8.47020E-01	5.31360E-01	4.50070E-01	9.66850E-01
9.06780E+02	8.46670E-01	5.31330E-01	4.49860E-01	9.66400E-01
9.06880E+02	8.46310E-01	5.31300E-01	4.49640E-01	9.65940E-01
9.06980E+02	8.45960E-01	5.31270E-01	4.49430E-01	9.65480E-01
9.07080E+02	8.45630E-01	5.31250E-01	4.49240E-01	9.65060E-01
9.07180E+02	8.45320E-01	5.31220E-01	4.49050E-01	9.64660E-01
9.07280E+02	8.45050E-01	5.31200E-01	4.48890E-01	9.64310E-01
9.07380E+02	8.44820E-01	5.31170E-01	4.48750E-01	9.64010E-01
9.07480E+02	8.44640E-01	5.31150E-01	4.48630E-01	9.63760E-01
9.07580E+02	8.44510E-01	5.31120E-01	4.48540E-01	9.63560E-01
9.07680E+02	8.44430E-01	5.31100E-01	4.48470E-01	9.63420E-01
9.07780E+02	8.44390E-01	5.31070E-01	4.48430E-01	9.63330E-01
9.07880E+02	8.44390E-01	5.31050E-01	4.48410E-01	9.63290E-01
9.07980E+02	8.44430E-01	5.31020E-01	4.48410E-01	9.63280E-01
9.08080E+02	8.44490E-01	5.30990E-01	4.48410E-01	9.63290E-01
9.08180E+02	8.44560E-01	5.30950E-01	4.48420E-01	9.63300E-01
9.08280E+02	8.44630E-01	5.30910E-01	4.48430E-01	9.63320E-01
9.08380E+02	8.44700E-01	5.30880E-01	4.48430E-01	9.63330E-01
9.08480E+02	8.44740E-01	5.30840E-01	4.48430E-01	9.63320E-01
9.08580E+02	8.44770E-01	5.30800E-01	4.48400E-01	9.63270E-01
9.08680E+02	8.44760E-01	5.30750E-01	4.48350E-01	9.63170E-01
9.08780E+02	8.44720E-01	5.30700E-01	4.48290E-01	9.63030E-01
9.08880E+02	8.44640E-01	5.30650E-01	4.48200E-01	9.62850E-01
9.08980E+02	8.44520E-01	5.30600E-01	4.48100E-01	9.62630E-01
9.09080E+02	8.44380E-01	5.30550E-01	4.47980E-01	9.62370E-01
9.09180E+02	8.44210E-01	5.30500E-01	4.47850E-01	9.62090E-01
9.09280E+02	8.44030E-01	5.30450E-01	4.47710E-01	9.61790E-01
9.09380E+02	8.43830E-01	5.30400E-01	4.47570E-01	9.61480E-01
9.09480E+02	8.43640E-01	5.30350E-01	4.47420E-01	9.61170E-01

9.09580E+02	8.43450E-01	5.30300E-01	4.47280E-01	9.60860E-01
9.09680E+02	8.43270E-01	5.30250E-01	4.47140E-01	9.60560E-01
9.09780E+02	8.43110E-01	5.30200E-01	4.47020E-01	9.60290E-01
9.09880E+02	8.42970E-01	5.30150E-01	4.46900E-01	9.60040E-01
9.09980E+02	8.42850E-01	5.30100E-01	4.46800E-01	9.59820E-01
9.10080E+02	8.42750E-01	5.30050E-01	4.46700E-01	9.59610E-01
9.10180E+02	8.42670E-01	5.29990E-01	4.46610E-01	9.59420E-01
9.10280E+02	8.42600E-01	5.29940E-01	4.46530E-01	9.59250E-01
9.10380E+02	8.42540E-01	5.29890E-01	4.46450E-01	9.59080E-01
9.10480E+02	8.42470E-01	5.29830E-01	4.46370E-01	9.58900E-01
9.10580E+02	8.42400E-01	5.29770E-01	4.46280E-01	9.58710E-01
9.10680E+02	8.42310E-01	5.29710E-01	4.46180E-01	9.58500E-01
9.10780E+02	8.42200E-01	5.29650E-01	4.46080E-01	9.58270E-01
9.10880E+02	8.42080E-01	5.29590E-01	4.45960E-01	9.58010E-01
9.10980E+02	8.41930E-01	5.29530E-01	4.45830E-01	9.57730E-01
9.11080E+02	8.41760E-01	5.29470E-01	4.45680E-01	9.57430E-01
9.11180E+02	8.41580E-01	5.29410E-01	4.45540E-01	9.57110E-01
9.11280E+02	8.41390E-01	5.29340E-01	4.45380E-01	9.56790E-01
9.11380E+02	8.41210E-01	5.29280E-01	4.45240E-01	9.56470E-01
9.11480E+02	8.41050E-01	5.29210E-01	4.45100E-01	9.56170E-01
9.11580E+02	8.40930E-01	5.29150E-01	4.44980E-01	9.55910E-01
9.11680E+02	8.40850E-01	5.29090E-01	4.44880E-01	9.55700E-01
9.11780E+02	8.40820E-01	5.29020E-01	4.44810E-01	9.55560E-01
9.11880E+02	8.40870E-01	5.28960E-01	4.44780E-01	9.55500E-01
9.11980E+02	8.40980E-01	5.28900E-01	4.44790E-01	9.55510E-01
9.12080E+02	8.41170E-01	5.28800E-01	4.44810E-01	9.55550E-01
9.12180E+02	8.41420E-01	5.28700E-01	4.44860E-01	9.55660E-01
9.12280E+02	8.41740E-01	5.28600E-01	4.44940E-01	9.55840E-01
9.12380E+02	8.42100E-01	5.28500E-01	4.45050E-01	9.56060E-01
9.12480E+02	8.42490E-01	5.28390E-01	4.45160E-01	9.56310E-01
9.12580E+02	8.42890E-01	5.28280E-01	4.45280E-01	9.56560E-01
9.12680E+02	8.43250E-01	5.28170E-01	4.45380E-01	9.56770E-01
9.12780E+02	8.43550E-01	5.28060E-01	4.45450E-01	9.56920E-01
9.12880E+02	8.43770E-01	5.27950E-01	4.45470E-01	9.56960E-01
9.12980E+02	8.43850E-01	5.27840E-01	4.45420E-01	9.56860E-01
9.13080E+02	8.43780E-01	5.27730E-01	4.45290E-01	9.56580E-01
9.13180E+02	8.43520E-01	5.27620E-01	4.45060E-01	9.56090E-01
9.13280E+02	8.43040E-01	5.27510E-01	4.44710E-01	9.55340E-01
9.13380E+02	8.42330E-01	5.27400E-01	4.44240E-01	9.54330E-01
9.13480E+02	8.41350E-01	5.27290E-01	4.43630E-01	9.53030E-01
9.13580E+02	8.40110E-01	5.27170E-01	4.42890E-01	9.51420E-01
9.13680E+02	8.38590E-01	5.27060E-01	4.41990E-01	9.49500E-01
9.13780E+02	8.36800E-01	5.26950E-01	4.40950E-01	9.47260E-01

9.13880E+02	8.34730E-01	5.26840E-01	4.39760E-01	9.44710E-01
9.13980E+02	8.32380E-01	5.26720E-01	4.38440E-01	9.41860E-01
9.14080E+02	8.29770E-01	5.26600E-01	4.36960E-01	9.38680E-01
9.14180E+02	8.26910E-01	5.26470E-01	4.35340E-01	9.35210E-01
9.14280E+02	8.23790E-01	5.26340E-01	4.33600E-01	9.31460E-01
9.14380E+02	8.20430E-01	5.26210E-01	4.31720E-01	9.27420E-01
9.14480E+02	8.16820E-01	5.26070E-01	4.29700E-01	9.23100E-01
9.14580E+02	8.12950E-01	5.25940E-01	4.27560E-01	9.18500E-01
9.14680E+02	8.08830E-01	5.25800E-01	4.25280E-01	9.13600E-01
9.14780E+02	8.04430E-01	5.25660E-01	4.22860E-01	9.08390E-01
9.14880E+02	7.99720E-01	5.25530E-01	4.20270E-01	9.02840E-01
9.14980E+02	7.94690E-01	5.25390E-01	4.17520E-01	8.96930E-01
9.15080E+02	7.89310E-01	5.25260E-01	4.14590E-01	8.90630E-01
9.15180E+02	7.83540E-01	5.25120E-01	4.11460E-01	8.83900E-01
9.15280E+02	7.77350E-01	5.24990E-01	4.08100E-01	8.76700E-01
9.15380E+02	7.70700E-01	5.24860E-01	4.04510E-01	8.68980E-01
9.15480E+02	7.63570E-01	5.24730E-01	4.00670E-01	8.60720E-01
9.15580E+02	7.55930E-01	5.24600E-01	3.96560E-01	8.51890E-01
9.15680E+02	7.47750E-01	5.24460E-01	3.92170E-01	8.42460E-01
9.15780E+02	7.39020E-01	5.24330E-01	3.87490E-01	8.32420E-01
9.15880E+02	7.29740E-01	5.24200E-01	3.82530E-01	8.21760E-01
9.15980E+02	7.19920E-01	5.24070E-01	3.77280E-01	8.10490E-01
9.16080E+02	7.09550E-01	5.24000E-01	3.71800E-01	7.98720E-01
9.16180E+02	6.98660E-01	5.23960E-01	3.66070E-01	7.86390E-01
9.16280E+02	6.87280E-01	5.23900E-01	3.60070E-01	7.73500E-01
9.16380E+02	6.75440E-01	5.23830E-01	3.53810E-01	7.60070E-01
9.16480E+02	6.63190E-01	5.23760E-01	3.47350E-01	7.46180E-01
9.16580E+02	6.50560E-01	5.23680E-01	3.40690E-01	7.31870E-01
9.16680E+02	6.37610E-01	5.23610E-01	3.33860E-01	7.17200E-01
9.16780E+02	6.24380E-01	5.23540E-01	3.26890E-01	7.02220E-01
9.16880E+02	6.10920E-01	5.23460E-01	3.19790E-01	6.86990E-01
9.16980E+02	5.97270E-01	5.23390E-01	3.12600E-01	6.71540E-01
9.17080E+02	5.83470E-01	5.23310E-01	3.05340E-01	6.55930E-01
9.17180E+02	5.69560E-01	5.23240E-01	2.98010E-01	6.40200E-01
9.17280E+02	5.55560E-01	5.23160E-01	2.90650E-01	6.24380E-01
9.17380E+02	5.41510E-01	5.23080E-01	2.83250E-01	6.08490E-01
9.17480E+02	5.27420E-01	5.23000E-01	2.75840E-01	5.92570E-01
9.17580E+02	5.13310E-01	5.22930E-01	2.68420E-01	5.76630E-01
9.17680E+02	4.99180E-01	5.22850E-01	2.61000E-01	5.60680E-01
9.17780E+02	4.85050E-01	5.22770E-01	2.53570E-01	5.44730E-01
9.17880E+02	4.70940E-01	5.22690E-01	2.46150E-01	5.28800E-01
9.17980E+02	4.56840E-01	5.22610E-01	2.38750E-01	5.12880E-01
9.18080E+02	4.42760E-01	5.22530E-01	2.31360E-01	4.97000E-01

9.18180E+02	4.28730E-01	5.22440E-01	2.23990E-01	4.81170E-01
9.18280E+02	4.14740E-01	5.22370E-01	2.16650E-01	4.65410E-01
9.18380E+02	4.00830E-01	5.22290E-01	2.09350E-01	4.49730E-01
9.18480E+02	3.87010E-01	5.22210E-01	2.02100E-01	4.34160E-01
9.18580E+02	3.73310E-01	5.22140E-01	1.94920E-01	4.18730E-01
9.18680E+02	3.59760E-01	5.22060E-01	1.87820E-01	4.03470E-01
9.18780E+02	3.46390E-01	5.21980E-01	1.80810E-01	3.88410E-01
9.18880E+02	3.33220E-01	5.21900E-01	1.73910E-01	3.73590E-01
9.18980E+02	3.20290E-01	5.21820E-01	1.67130E-01	3.59040E-01
9.19080E+02	3.07640E-01	5.21740E-01	1.60510E-01	3.44800E-01
9.19180E+02	2.95280E-01	5.21660E-01	1.54030E-01	3.30900E-01
9.19280E+02	2.83250E-01	5.21570E-01	1.47730E-01	3.17370E-01
9.19380E+02	2.71560E-01	5.21490E-01	1.41620E-01	3.04220E-01
9.19480E+02	2.60240E-01	5.21410E-01	1.35690E-01	2.91490E-01
9.19580E+02	2.49280E-01	5.21320E-01	1.29960E-01	2.79180E-01
9.19680E+02	2.38710E-01	5.21240E-01	1.24420E-01	2.67290E-01
9.19780E+02	2.28510E-01	5.21150E-01	1.19090E-01	2.55830E-01
9.19880E+02	2.18690E-01	5.21070E-01	1.13950E-01	2.44790E-01
9.19980E+02	2.09230E-01	5.20990E-01	1.09000E-01	2.34160E-01
9.20080E+02	2.00110E-01	5.20750E-01	1.04210E-01	2.23870E-01
9.20180E+02	1.91340E-01	5.20500E-01	9.95920E-02	2.13950E-01
9.20280E+02	1.82880E-01	5.20260E-01	9.51460E-02	2.04390E-01
9.20380E+02	1.74720E-01	5.20020E-01	9.08600E-02	1.95190E-01
9.20480E+02	1.66860E-01	5.19770E-01	8.67280E-02	1.86310E-01
9.20580E+02	1.59260E-01	5.19530E-01	8.27400E-02	1.77740E-01
9.20680E+02	1.51920E-01	5.19290E-01	7.88910E-02	1.69480E-01
9.20780E+02	1.44840E-01	5.19040E-01	7.51760E-02	1.61490E-01
9.20880E+02	1.37990E-01	5.18800E-01	7.15900E-02	1.53790E-01
9.20980E+02	1.31390E-01	5.18550E-01	6.81330E-02	1.46360E-01
9.21080E+02	1.25030E-01	5.18310E-01	6.48020E-02	1.39210E-01
9.21180E+02	1.18900E-01	5.18060E-01	6.15980E-02	1.32330E-01
9.21280E+02	1.13020E-01	5.17810E-01	5.85230E-02	1.25720E-01
9.21380E+02	1.07380E-01	5.17570E-01	5.55790E-02	1.19400E-01
9.21480E+02	1.02000E-01	5.17320E-01	5.27670E-02	1.13360E-01
9.21580E+02	9.68690E-02	5.17080E-01	5.00890E-02	1.07600E-01
9.21680E+02	9.19960E-02	5.16830E-01	4.75470E-02	1.02140E-01
9.21780E+02	8.73810E-02	5.16590E-01	4.51400E-02	9.69700E-02
9.21880E+02	8.30230E-02	5.16340E-01	4.28680E-02	9.20900E-02
9.21980E+02	7.89190E-02	5.16090E-01	4.07300E-02	8.74970E-02
9.22080E+02	7.50640E-02	5.15950E-01	3.87290E-02	8.31990E-02
9.22180E+02	7.14490E-02	5.15830E-01	3.68560E-02	7.91740E-02
9.22280E+02	6.80650E-02	5.15710E-01	3.51020E-02	7.54070E-02
9.22380E+02	6.49010E-02	5.15590E-01	3.34620E-02	7.18840E-02

9.22480E+02	6.19420E-02	5.15470E-01	3.19290E-02	6.85910E-02
9.22580E+02	5.91750E-02	5.15350E-01	3.04960E-02	6.55120E-02
9.22680E+02	5.65840E-02	5.15230E-01	2.91540E-02	6.26290E-02
9.22780E+02	5.41550E-02	5.15110E-01	2.78960E-02	5.99270E-02
9.22880E+02	5.18740E-02	5.14990E-01	2.67140E-02	5.73890E-02
9.22980E+02	4.97250E-02	5.14870E-01	2.56020E-02	5.49980E-02
9.23080E+02	4.76960E-02	5.14750E-01	2.45510E-02	5.27420E-02
9.23180E+02	4.57730E-02	5.14630E-01	2.35560E-02	5.06050E-02
9.23280E+02	4.39470E-02	5.14510E-01	2.26110E-02	4.85740E-02
9.23380E+02	4.22070E-02	5.14400E-01	2.17110E-02	4.66400E-02
9.23480E+02	4.05430E-02	5.14280E-01	2.08510E-02	4.47920E-02
9.23580E+02	3.89490E-02	5.14160E-01	2.00260E-02	4.30200E-02
9.23680E+02	3.74170E-02	5.14040E-01	1.92340E-02	4.13180E-02
9.23780E+02	3.59400E-02	5.13920E-01	1.84710E-02	3.96790E-02
9.23880E+02	3.45150E-02	5.13810E-01	1.77340E-02	3.80970E-02
9.23980E+02	3.31360E-02	5.13690E-01	1.70220E-02	3.65660E-02
9.24080E+02	3.18000E-02	5.13590E-01	1.63320E-02	3.50850E-02
9.24180E+02	3.05040E-02	5.13500E-01	1.56640E-02	3.36490E-02
9.24280E+02	3.10980E-02	5.13400E-01	1.59660E-02	3.42980E-02
9.24380E+02	2.98440E-02	5.13310E-01	1.53190E-02	3.29090E-02
9.24480E+02	2.86490E-02	5.13210E-01	1.47030E-02	3.15850E-02
9.24580E+02	2.75100E-02	5.13120E-01	1.41160E-02	3.03240E-02
9.24680E+02	2.64230E-02	5.13030E-01	1.35560E-02	2.91210E-02
9.24780E+02	2.53860E-02	5.12930E-01	1.30210E-02	2.79720E-02
9.24880E+02	2.43940E-02	5.12840E-01	1.25100E-02	2.68750E-02
9.24980E+02	2.34450E-02	5.12740E-01	1.20210E-02	2.58240E-02
9.25080E+02	2.25350E-02	5.12650E-01	1.15530E-02	2.48170E-02
9.25180E+02	2.16610E-02	5.12560E-01	1.11030E-02	2.38510E-02
9.25280E+02	2.08200E-02	5.12470E-01	1.06700E-02	2.29210E-02
9.25380E+02	2.00090E-02	5.12380E-01	1.02520E-02	2.20240E-02
9.25480E+02	1.92260E-02	5.12290E-01	9.84900E-03	2.11580E-02
9.25580E+02	1.84670E-02	5.12200E-01	9.45870E-03	2.03190E-02
9.25680E+02	1.77320E-02	5.12110E-01	9.08040E-03	1.95070E-02
9.25780E+02	1.70180E-02	5.12010E-01	8.71320E-03	1.87180E-02
9.25880E+02	1.63240E-02	5.11920E-01	8.35670E-03	1.79520E-02
9.25980E+02	1.56510E-02	5.11840E-01	8.01070E-03	1.72090E-02
9.26080E+02	1.49970E-02	5.11710E-01	7.67410E-03	1.64860E-02
9.26180E+02	1.43640E-02	5.11550E-01	7.34800E-03	1.57850E-02
9.26280E+02	1.37520E-02	5.11400E-01	7.03270E-03	1.51080E-02
9.26380E+02	1.31610E-02	5.11250E-01	6.72880E-03	1.44550E-02
9.26480E+02	1.25940E-02	5.11100E-01	6.43680E-03	1.38280E-02
9.26580E+02	1.20510E-02	5.10950E-01	6.15720E-03	1.32270E-02
9.26680E+02	1.15320E-02	5.10800E-01	5.89050E-03	1.26540E-02

9.26780E+02	1.10390E-02	5.10650E-01	5.63700E-03	1.21100E-02
9.26880E+02	1.05720E-02	5.10500E-01	5.39710E-03	1.15940E-02
9.26980E+02	1.01310E-02	5.10350E-01	5.17050E-03	1.11070E-02
9.27080E+02	9.71590E-03	5.10200E-01	4.95700E-03	1.06490E-02
9.27180E+02	9.32510E-03	5.10050E-01	4.75620E-03	1.02170E-02
9.27280E+02	8.95760E-03	5.09900E-01	4.56740E-03	9.81190E-03
9.27380E+02	8.61160E-03	5.09750E-01	4.38970E-03	9.43010E-03
9.27480E+02	8.28510E-03	5.09600E-01	4.22210E-03	9.07000E-03
9.27580E+02	7.97620E-03	5.09450E-01	4.06350E-03	8.72920E-03
9.27680E+02	7.68260E-03	5.09300E-01	3.91270E-03	8.40550E-03
9.27780E+02	7.40240E-03	5.09150E-01	3.76890E-03	8.09650E-03
9.27880E+02	7.13380E-03	5.09000E-01	3.63110E-03	7.80040E-03
9.27980E+02	6.87550E-03	5.08850E-01	3.49850E-03	7.51570E-03
9.28080E+02	6.62640E-03	5.08790E-01	3.37150E-03	7.24260E-03
9.28180E+02	6.38610E-03	5.08760E-01	3.24900E-03	6.97950E-03
9.28280E+02	6.15450E-03	5.08730E-01	3.13100E-03	6.72600E-03
9.28380E+02	5.93210E-03	5.08700E-01	3.01760E-03	6.48260E-03
9.28480E+02	5.71970E-03	5.08670E-01	2.90940E-03	6.25010E-03
9.28580E+02	5.51830E-03	5.08630E-01	2.80680E-03	6.02970E-03
9.28680E+02	5.32930E-03	5.08600E-01	2.71050E-03	5.82280E-03
9.28780E+02	5.15380E-03	5.08570E-01	2.62110E-03	5.63070E-03
9.28880E+02	4.99290E-03	5.08540E-01	2.53910E-03	5.45460E-03
9.28980E+02	4.84750E-03	5.08510E-01	2.46500E-03	5.29530E-03
9.29080E+02	4.71780E-03	5.08480E-01	2.39890E-03	5.15340E-03
9.29180E+02	4.60390E-03	5.08450E-01	2.34080E-03	5.02860E-03
9.29280E+02	4.50480E-03	5.08420E-01	2.29030E-03	4.92010E-03
9.29380E+02	4.41940E-03	5.08380E-01	2.24680E-03	4.82660E-03
9.29480E+02	4.34570E-03	5.08350E-01	2.20920E-03	4.74580E-03
9.29580E+02	4.28140E-03	5.08320E-01	2.17630E-03	4.67520E-03
9.29680E+02	4.22360E-03	5.08290E-01	2.14680E-03	4.61180E-03
9.29780E+02	4.16940E-03	5.08250E-01	2.11910E-03	4.55230E-03
9.29880E+02	4.11570E-03	5.08200E-01	2.09160E-03	4.49330E-03
9.29980E+02	4.05990E-03	5.08150E-01	2.06300E-03	4.43180E-03
9.30080E+02	3.99920E-03	5.08050E-01	2.03180E-03	4.36480E-03
9.30180E+02	3.93180E-03	5.07940E-01	1.99710E-03	4.29020E-03
9.30280E+02	3.85610E-03	5.07830E-01	1.95830E-03	4.20680E-03
9.30380E+02	3.77170E-03	5.07720E-01	1.91500E-03	4.11380E-03
9.30480E+02	3.67860E-03	5.07610E-01	1.86730E-03	4.01130E-03
9.30580E+02	3.57760E-03	5.07500E-01	1.81560E-03	3.90040E-03
9.30680E+02	3.47040E-03	5.07390E-01	1.76080E-03	3.78270E-03
9.30780E+02	3.35910E-03	5.07280E-01	1.70400E-03	3.66060E-03
9.30880E+02	3.24660E-03	5.07170E-01	1.64660E-03	3.53720E-03
9.30980E+02	3.13570E-03	5.07060E-01	1.59000E-03	3.41560E-03

9.31080E+02	3.02950E-03	5.06950E-01	1.53580E-03	3.29920E-03
9.31180E+02	2.93090E-03	5.06850E-01	1.48550E-03	3.19130E-03
9.31280E+02	2.84270E-03	5.06740E-01	1.44050E-03	3.09450E-03
9.31380E+02	2.76680E-03	5.06630E-01	1.40180E-03	3.01130E-03
9.31480E+02	2.70480E-03	5.06530E-01	1.37000E-03	2.94320E-03
9.31580E+02	2.65720E-03	5.06420E-01	1.34570E-03	2.89080E-03
9.31680E+02	2.62400E-03	5.06310E-01	1.32860E-03	2.85400E-03
9.31780E+02	2.60420E-03	5.06210E-01	1.31830E-03	2.83190E-03
9.31880E+02	2.59630E-03	5.06100E-01	1.31400E-03	2.82270E-03
9.31980E+02	2.14940E-03	5.06000E-01	1.08760E-03	2.33640E-03
9.32080E+02	2.03210E-03	5.05920E-01	1.02810E-03	2.20850E-03
9.32180E+02	1.93470E-03	5.05850E-01	9.78670E-04	2.10240E-03
9.32280E+02	1.86650E-03	5.05770E-01	9.44000E-04	2.02790E-03
9.32380E+02	1.83520E-03	5.05700E-01	9.28050E-04	1.99370E-03
9.32480E+02	1.77770E-03	5.05620E-01	8.98850E-04	1.93090E-03
9.32580E+02	1.74760E-03	5.05550E-01	8.83510E-04	1.89800E-03
9.32680E+02	1.71830E-03	5.05470E-01	8.68540E-04	1.86580E-03
9.32780E+02	1.68890E-03	5.05400E-01	8.53560E-04	1.83360E-03
9.32880E+02	1.65950E-03	5.05320E-01	8.38590E-04	1.80150E-03
9.32980E+02	1.63120E-03	5.05250E-01	8.24130E-04	1.77040E-03
9.33080E+02	1.60280E-03	5.05170E-01	8.09680E-04	1.73940E-03
9.33180E+02	1.57340E-03	5.05090E-01	7.94720E-04	1.70720E-03
9.33280E+02	1.54400E-03	5.05020E-01	7.79770E-04	1.67510E-03
9.33380E+02	1.51240E-03	5.04940E-01	7.63680E-04	1.64060E-03
9.33480E+02	0.00000E+00	5.04860E-01	0.00000E+00	0.00000E+00

Channel 9

Wavenumber	HIRS Filter Transmittance	Optical Element Transmittance	Product of the HIRS Filter and Optical Element Transmittances	Normalized Value of Column 4
9.93630E+02	0.00000E+00	4.90220E-01	0.00000E+00	0.00000E+00
9.93730E+02	9.50780E-04	4.90200E-01	4.66070E-04	1.20570E-03
9.93830E+02	9.68620E-04	4.90170E-01	4.74790E-04	1.22820E-03
9.93930E+02	1.00320E-03	4.90150E-01	4.91690E-04	1.27190E-03
9.94030E+02	1.05350E-03	4.90120E-01	5.16360E-04	1.33580E-03
9.94130E+02	1.11800E-03	4.90090E-01	5.47900E-04	1.41740E-03
9.94230E+02	1.19380E-03	4.90050E-01	5.85030E-04	1.51340E-03
9.94330E+02	1.27800E-03	4.90020E-01	6.26230E-04	1.62000E-03
9.94430E+02	1.36750E-03	4.89990E-01	6.70080E-04	1.73340E-03
9.94530E+02	1.45980E-03	4.89950E-01	7.15260E-04	1.85030E-03
9.94630E+02	1.55260E-03	4.89920E-01	7.60630E-04	1.96770E-03
9.94730E+02	1.64410E-03	4.89890E-01	8.05430E-04	2.08350E-03
9.94830E+02	1.73340E-03	4.89850E-01	8.49090E-04	2.19650E-03

9.94930E+02	1.81960E-03	4.89820E-01	8.91290E-04	2.30570E-03
9.95030E+02	1.90280E-03	4.89790E-01	9.31970E-04	2.41090E-03
9.95130E+02	1.98290E-03	4.89760E-01	9.71160E-04	2.51230E-03
9.95230E+02	2.06020E-03	4.89730E-01	1.00890E-03	2.61000E-03
9.95330E+02	2.13520E-03	4.89700E-01	1.04560E-03	2.70480E-03
9.95430E+02	2.20830E-03	4.89660E-01	1.08130E-03	2.79720E-03
9.95530E+02	2.27990E-03	4.89630E-01	1.11630E-03	2.88770E-03
9.95630E+02	2.35060E-03	4.89600E-01	1.15090E-03	2.97710E-03
9.95730E+02	2.42090E-03	4.89570E-01	1.18520E-03	3.06590E-03
9.95830E+02	2.49090E-03	4.89540E-01	1.21940E-03	3.15440E-03
9.95930E+02	2.56090E-03	4.89510E-01	1.25360E-03	3.24280E-03
9.96030E+02	2.63060E-03	4.89470E-01	1.28760E-03	3.33080E-03
9.96130E+02	2.69920E-03	4.89420E-01	1.32110E-03	3.41750E-03
9.96230E+02	2.76590E-03	4.89380E-01	1.35360E-03	3.50150E-03
9.96330E+02	2.82890E-03	4.89330E-01	1.38430E-03	3.58090E-03
9.96430E+02	2.88620E-03	4.89280E-01	1.41220E-03	3.65310E-03
9.96530E+02	2.93560E-03	4.89240E-01	1.43620E-03	3.71530E-03
9.96630E+02	2.97480E-03	4.89190E-01	1.45530E-03	3.76460E-03
9.96730E+02	3.00170E-03	4.89140E-01	1.46830E-03	3.79830E-03
9.96830E+02	3.01480E-03	4.89100E-01	1.47450E-03	3.81440E-03
9.96930E+02	3.01280E-03	4.89050E-01	1.47340E-03	3.81160E-03
9.97030E+02	2.99570E-03	4.89000E-01	1.46490E-03	3.78950E-03
9.97130E+02	2.96410E-03	4.88950E-01	1.44930E-03	3.74920E-03
9.97230E+02	2.91970E-03	4.88910E-01	1.42750E-03	3.69260E-03
9.97330E+02	2.86470E-03	4.88830E-01	1.40040E-03	3.62260E-03
9.97430E+02	2.80240E-03	4.88750E-01	1.36970E-03	3.54320E-03
9.97530E+02	2.73640E-03	4.88660E-01	1.33720E-03	3.45920E-03
9.97630E+02	2.67050E-03	4.88580E-01	1.30480E-03	3.37530E-03
9.97730E+02	2.60870E-03	4.88500E-01	1.27440E-03	3.29660E-03
9.97830E+02	2.55490E-03	4.88410E-01	1.24790E-03	3.22800E-03
9.97930E+02	2.51250E-03	4.88330E-01	1.22690E-03	3.17390E-03
9.98030E+02	2.48460E-03	4.88250E-01	1.21310E-03	3.13820E-03
9.98130E+02	2.47380E-03	4.88180E-01	1.20770E-03	3.12410E-03
9.98230E+02	2.48180E-03	4.88110E-01	1.21140E-03	3.13380E-03
9.98330E+02	2.50990E-03	4.88050E-01	1.22500E-03	3.16880E-03
9.98430E+02	2.55820E-03	4.87980E-01	1.24840E-03	3.22940E-03
9.98530E+02	2.62580E-03	4.87910E-01	1.28120E-03	3.31420E-03
9.98630E+02	2.71080E-03	4.87840E-01	1.32250E-03	3.42110E-03
9.98730E+02	2.81040E-03	4.87770E-01	1.37090E-03	3.54620E-03
9.98830E+02	2.92080E-03	4.87700E-01	1.42450E-03	3.68500E-03
9.98930E+02	3.03800E-03	4.87640E-01	1.48140E-03	3.83230E-03
9.99030E+02	3.15760E-03	4.87570E-01	1.53960E-03	3.98270E-03
9.99130E+02	3.27570E-03	4.87500E-01	1.59690E-03	4.13090E-03

9.99230E+02	3.38860E-03	4.87430E-01	1.65170E-03	4.27280E-03
9.99330E+02	3.49390E-03	4.87350E-01	1.70280E-03	4.40490E-03
9.99430E+02	3.58980E-03	4.87270E-01	1.74920E-03	4.52510E-03
9.99530E+02	3.67590E-03	4.87200E-01	1.79090E-03	4.63280E-03
9.99630E+02	3.75280E-03	4.87120E-01	1.82810E-03	4.72900E-03
9.99730E+02	3.82220E-03	4.87040E-01	1.86160E-03	4.81570E-03
9.99830E+02	3.88680E-03	4.86970E-01	1.89280E-03	4.89630E-03
9.99930E+02	3.95010E-03	4.86890E-01	1.92330E-03	4.97520E-03
1.00000E+03	4.01600E-03	4.86800E-01	1.95500E-03	5.05730E-03
1.00010E+03	4.08880E-03	4.86670E-01	1.98990E-03	5.14770E-03
1.00020E+03	4.17300E-03	4.86550E-01	2.03040E-03	5.25230E-03
1.00030E+03	4.27260E-03	4.86420E-01	2.07830E-03	5.37630E-03
1.00040E+03	4.39130E-03	4.86290E-01	2.13550E-03	5.52420E-03
1.00050E+03	4.53190E-03	4.86170E-01	2.20330E-03	5.69960E-03
1.00060E+03	4.69640E-03	4.86040E-01	2.28260E-03	5.90490E-03
1.00070E+03	4.88530E-03	4.85920E-01	2.37380E-03	6.14080E-03
1.00080E+03	5.09790E-03	4.85790E-01	2.47650E-03	6.40650E-03
1.00090E+03	5.33200E-03	4.85660E-01	2.58960E-03	6.69890E-03
1.00100E+03	5.58400E-03	4.85540E-01	2.71120E-03	7.01370E-03
1.00110E+03	5.84900E-03	4.85410E-01	2.83920E-03	7.34470E-03
1.00120E+03	6.12120E-03	4.85290E-01	2.97060E-03	7.68460E-03
1.00130E+03	6.39420E-03	4.85180E-01	3.10230E-03	8.02530E-03
1.00140E+03	6.66120E-03	4.85060E-01	3.23110E-03	8.35850E-03
1.00150E+03	6.91590E-03	4.84940E-01	3.35380E-03	8.67590E-03
1.00160E+03	7.15220E-03	4.84830E-01	3.46760E-03	8.97020E-03
1.00170E+03	7.36520E-03	4.84710E-01	3.57000E-03	9.23520E-03
1.00180E+03	7.55130E-03	4.84590E-01	3.65930E-03	9.46620E-03
1.00190E+03	7.70810E-03	4.84480E-01	3.73440E-03	9.66050E-03
1.00200E+03	7.83510E-03	4.84360E-01	3.79500E-03	9.81720E-03
1.00210E+03	7.90320E-03	4.84230E-01	3.82700E-03	9.89990E-03
1.00220E+03	8.00520E-03	4.84100E-01	3.87530E-03	1.00250E-02
1.00230E+03	8.05520E-03	4.83970E-01	3.89850E-03	1.00850E-02
1.00240E+03	8.08870E-03	4.83850E-01	3.91370E-03	1.01240E-02
1.00250E+03	8.11230E-03	4.83720E-01	3.92410E-03	1.01510E-02
1.00260E+03	8.13320E-03	4.83590E-01	3.93320E-03	1.01750E-02
1.00270E+03	8.15890E-03	4.83460E-01	3.94450E-03	1.02040E-02
1.00280E+03	8.19700E-03	4.83340E-01	3.96190E-03	1.02490E-02
1.00290E+03	8.25460E-03	4.83210E-01	3.98870E-03	1.03180E-02
1.00300E+03	8.33790E-03	4.83080E-01	4.02790E-03	1.04200E-02
1.00310E+03	8.45190E-03	4.82940E-01	4.08180E-03	1.05590E-02
1.00320E+03	8.60040E-03	4.82800E-01	4.15230E-03	1.07410E-02
1.00330E+03	8.78520E-03	4.82660E-01	4.24030E-03	1.09690E-02
1.00340E+03	9.00670E-03	4.82520E-01	4.34590E-03	1.12420E-02

1.00350E+03	9.26320E-03	4.82380E-01	4.46840E-03	1.15590E-02
1.00360E+03	9.55180E-03	4.82240E-01	4.60620E-03	1.19160E-02
1.00370E+03	9.86800E-03	4.82100E-01	4.75740E-03	1.23070E-02
1.00380E+03	1.02060E-02	4.81960E-01	4.91910E-03	1.27250E-02
1.00390E+03	1.05610E-02	4.81820E-01	5.08840E-03	1.31630E-02
1.00400E+03	1.09250E-02	4.81680E-01	5.26230E-03	1.36130E-02
1.00410E+03	1.12920E-02	4.81530E-01	5.43740E-03	1.40660E-02
1.00420E+03	1.16560E-02	4.81370E-01	5.61090E-03	1.45150E-02
1.00430E+03	1.20120E-02	4.81220E-01	5.78030E-03	1.49530E-02
1.00440E+03	1.23540E-02	4.81070E-01	5.94330E-03	1.53750E-02
1.00450E+03	1.26800E-02	4.80920E-01	6.09830E-03	1.57760E-02
1.00460E+03	1.29880E-02	4.80770E-01	6.24430E-03	1.61530E-02
1.00470E+03	1.32760E-02	4.80620E-01	6.38100E-03	1.65070E-02
1.00480E+03	1.35460E-02	4.80470E-01	6.50840E-03	1.68370E-02
1.00490E+03	1.37990E-02	4.80320E-01	6.62770E-03	1.71450E-02
1.00500E+03	1.40370E-02	4.80170E-01	6.74020E-03	1.74360E-02
1.00510E+03	1.42650E-02	4.80020E-01	6.84770E-03	1.77140E-02
1.00520E+03	1.44880E-02	4.79880E-01	6.95250E-03	1.79850E-02
1.00530E+03	1.47100E-02	4.79730E-01	7.05680E-03	1.82550E-02
1.00540E+03	1.49360E-02	4.79590E-01	7.16330E-03	1.85310E-02
1.00550E+03	1.51720E-02	4.79440E-01	7.27420E-03	1.88170E-02
1.00560E+03	1.54220E-02	4.79290E-01	7.39180E-03	1.91220E-02
1.00570E+03	1.56910E-02	4.79150E-01	7.51810E-03	1.94490E-02
1.00580E+03	1.59810E-02	4.79000E-01	7.65480E-03	1.98020E-02
1.00590E+03	1.62950E-02	4.78850E-01	7.80300E-03	2.01860E-02
1.00600E+03	1.66360E-02	4.78720E-01	7.96400E-03	2.06020E-02
1.00610E+03	1.70040E-02	4.78610E-01	8.13850E-03	2.10530E-02
1.00620E+03	1.74000E-02	4.78500E-01	8.32620E-03	2.15390E-02
1.00630E+03	1.78250E-02	4.78400E-01	8.52720E-03	2.20590E-02
1.00640E+03	1.82760E-02	4.78290E-01	8.74110E-03	2.26120E-02
1.00650E+03	1.87530E-02	4.78180E-01	8.96730E-03	2.31970E-02
1.00660E+03	1.92550E-02	4.78070E-01	9.20530E-03	2.38130E-02
1.00670E+03	1.97800E-02	4.77960E-01	9.45440E-03	2.44570E-02
1.00680E+03	2.03280E-02	4.77860E-01	9.71370E-03	2.51280E-02
1.00690E+03	2.08950E-02	4.77750E-01	9.98250E-03	2.58240E-02
1.00700E+03	2.14810E-02	4.77640E-01	1.02600E-02	2.65420E-02
1.00710E+03	2.20840E-02	4.77530E-01	1.05460E-02	2.72800E-02
1.00720E+03	2.27020E-02	4.77430E-01	1.08390E-02	2.80380E-02
1.00730E+03	2.33350E-02	4.77320E-01	1.11380E-02	2.88140E-02
1.00740E+03	2.39820E-02	4.77210E-01	1.14440E-02	2.96060E-02
1.00750E+03	2.46410E-02	4.77100E-01	1.17560E-02	3.04120E-02
1.00760E+03	2.53120E-02	4.76990E-01	1.20740E-02	3.12330E-02
1.00770E+03	2.59930E-02	4.76890E-01	1.23960E-02	3.20670E-02

1.00780E+03	2.66860E-02	4.76780E-01	1.27230E-02	3.29130E-02
1.00790E+03	2.73880E-02	4.76670E-01	1.30550E-02	3.37720E-02
1.00800E+03	2.81000E-02	4.76540E-01	1.33910E-02	3.46410E-02
1.00810E+03	2.88230E-02	4.76380E-01	1.37310E-02	3.55190E-02
1.00820E+03	2.95560E-02	4.76210E-01	1.40750E-02	3.64110E-02
1.00830E+03	3.03020E-02	4.76040E-01	1.44250E-02	3.73160E-02
1.00840E+03	3.10620E-02	4.75870E-01	1.47810E-02	3.82380E-02
1.00850E+03	3.18370E-02	4.75700E-01	1.51450E-02	3.91780E-02
1.00860E+03	3.26320E-02	4.75540E-01	1.55180E-02	4.01420E-02
1.00870E+03	3.34490E-02	4.75370E-01	1.59010E-02	4.11330E-02
1.00880E+03	3.42940E-02	4.75200E-01	1.62960E-02	4.21570E-02
1.00890E+03	3.51700E-02	4.75040E-01	1.67070E-02	4.32200E-02
1.00900E+03	3.60840E-02	4.74880E-01	1.71350E-02	4.43270E-02
1.00910E+03	3.70390E-02	4.74720E-01	1.75830E-02	4.54860E-02
1.00920E+03	3.80430E-02	4.74560E-01	1.80530E-02	4.67020E-02
1.00930E+03	3.90980E-02	4.74390E-01	1.85480E-02	4.79810E-02
1.00940E+03	4.02110E-02	4.74230E-01	1.90690E-02	4.93300E-02
1.00950E+03	4.13840E-02	4.74070E-01	1.96190E-02	5.07510E-02
1.00960E+03	4.26200E-02	4.73900E-01	2.01980E-02	5.22490E-02
1.00970E+03	4.39210E-02	4.73740E-01	2.08070E-02	5.38250E-02
1.00980E+03	4.52860E-02	4.73580E-01	2.14460E-02	5.54800E-02
1.00990E+03	4.67150E-02	4.73420E-01	2.21150E-02	5.72100E-02
1.01000E+03	4.82040E-02	4.73250E-01	2.28130E-02	5.90140E-02
1.01010E+03	4.97510E-02	4.73080E-01	2.35360E-02	6.08850E-02
1.01020E+03	5.13500E-02	4.72910E-01	2.42840E-02	6.28190E-02
1.01030E+03	5.29950E-02	4.72740E-01	2.50530E-02	6.48090E-02
1.01040E+03	5.46810E-02	4.72570E-01	2.58410E-02	6.68470E-02
1.01050E+03	5.64020E-02	4.72390E-01	2.66440E-02	6.89250E-02
1.01060E+03	5.81510E-02	4.72220E-01	2.74600E-02	7.10370E-02
1.01070E+03	5.99250E-02	4.72050E-01	2.82880E-02	7.31770E-02
1.01080E+03	6.17190E-02	4.71870E-01	2.91230E-02	7.53380E-02
1.01090E+03	6.35300E-02	4.71680E-01	2.99660E-02	7.75180E-02
1.01100E+03	6.53600E-02	4.71490E-01	3.08160E-02	7.97180E-02
1.01110E+03	6.72090E-02	4.71300E-01	3.16760E-02	8.19410E-02
1.01120E+03	6.90820E-02	4.71110E-01	3.25450E-02	8.41910E-02
1.01130E+03	7.09840E-02	4.70930E-01	3.34280E-02	8.64750E-02
1.01140E+03	7.29240E-02	4.70740E-01	3.43280E-02	8.88030E-02
1.01150E+03	7.49110E-02	4.70550E-01	3.52500E-02	9.11860E-02
1.01160E+03	7.69570E-02	4.70360E-01	3.61980E-02	9.36390E-02
1.01170E+03	7.90730E-02	4.70180E-01	3.71780E-02	9.61760E-02
1.01180E+03	8.12730E-02	4.69990E-01	3.81970E-02	9.88120E-02
1.01190E+03	8.35670E-02	4.69800E-01	3.92600E-02	1.01560E-01
1.01200E+03	8.59690E-02	4.69590E-01	4.03700E-02	1.04430E-01

1.01210E+03	8.84880E-02	4.69340E-01	4.15310E-02	1.07430E-01
1.01220E+03	9.11330E-02	4.69080E-01	4.27490E-02	1.10590E-01
1.01230E+03	9.39110E-02	4.68830E-01	4.40280E-02	1.13900E-01
1.01240E+03	9.68270E-02	4.68570E-01	4.53710E-02	1.17370E-01
1.01250E+03	9.98830E-02	4.68320E-01	4.67770E-02	1.21010E-01
1.01260E+03	1.03080E-01	4.68060E-01	4.82470E-02	1.24810E-01
1.01270E+03	1.06410E-01	4.67810E-01	4.97800E-02	1.28780E-01
1.01280E+03	1.09880E-01	4.67560E-01	5.13730E-02	1.32900E-01
1.01290E+03	1.13470E-01	4.67310E-01	5.30240E-02	1.37170E-01
1.01300E+03	1.17180E-01	4.67050E-01	5.47280E-02	1.41570E-01
1.01310E+03	1.21000E-01	4.66800E-01	5.64820E-02	1.46110E-01
1.01320E+03	1.24920E-01	4.66550E-01	5.82820E-02	1.50770E-01
1.01330E+03	1.28940E-01	4.66300E-01	6.01250E-02	1.55540E-01
1.01340E+03	1.33050E-01	4.66040E-01	6.20060E-02	1.60400E-01
1.01350E+03	1.37240E-01	4.65790E-01	6.39250E-02	1.65370E-01
1.01360E+03	1.41510E-01	4.65540E-01	6.58790E-02	1.70420E-01
1.01370E+03	1.45860E-01	4.65280E-01	6.78670E-02	1.75560E-01
1.01380E+03	1.50290E-01	4.65030E-01	6.98900E-02	1.80800E-01
1.01390E+03	1.54800E-01	4.64780E-01	7.19490E-02	1.86120E-01
1.01400E+03	1.59400E-01	4.64530E-01	7.40480E-02	1.91550E-01
1.01410E+03	1.64090E-01	4.64310E-01	7.61920E-02	1.97100E-01
1.01420E+03	1.68890E-01	4.64100E-01	7.83800E-02	2.02760E-01
1.01430E+03	1.73790E-01	4.63880E-01	8.06180E-02	2.08550E-01
1.01440E+03	1.78810E-01	4.63660E-01	8.29070E-02	2.14470E-01
1.01450E+03	1.83960E-01	4.63440E-01	8.52550E-02	2.20540E-01
1.01460E+03	1.89250E-01	4.63220E-01	8.76630E-02	2.26770E-01
1.01470E+03	1.94670E-01	4.63030E-01	9.01410E-02	2.33180E-01
1.01480E+03	2.00250E-01	4.62850E-01	9.26860E-02	2.39770E-01
1.01490E+03	2.05980E-01	4.62660E-01	9.53000E-02	2.46530E-01
1.01500E+03	2.11870E-01	4.62470E-01	9.79830E-02	2.53470E-01
1.01510E+03	2.17910E-01	4.62280E-01	1.00740E-01	2.60590E-01
1.01520E+03	2.24110E-01	4.62090E-01	1.03560E-01	2.67900E-01
1.01530E+03	2.30460E-01	4.61910E-01	1.06450E-01	2.75380E-01
1.01540E+03	2.36960E-01	4.61720E-01	1.09410E-01	2.83030E-01
1.01550E+03	2.43600E-01	4.61530E-01	1.12430E-01	2.90840E-01
1.01560E+03	2.50380E-01	4.61340E-01	1.15510E-01	2.98820E-01
1.01570E+03	2.57300E-01	4.61160E-01	1.18650E-01	3.06950E-01
1.01580E+03	2.64340E-01	4.60970E-01	1.21850E-01	3.15220E-01
1.01590E+03	2.71510E-01	4.60780E-01	1.25110E-01	3.23630E-01
1.01600E+03	2.78790E-01	4.60590E-01	1.28410E-01	3.32180E-01
1.01610E+03	2.86200E-01	4.60370E-01	1.31760E-01	3.40840E-01
1.01620E+03	2.93710E-01	4.60160E-01	1.35150E-01	3.49630E-01
1.01630E+03	3.01350E-01	4.59940E-01	1.38600E-01	3.58550E-01

1.01640E+03	3.09090E-01	4.59730E-01	1.42100E-01	3.67590E-01
1.01650E+03	3.16950E-01	4.59520E-01	1.45650E-01	3.76770E-01
1.01660E+03	3.24930E-01	4.59310E-01	1.49240E-01	3.86080E-01
1.01670E+03	3.33020E-01	4.59110E-01	1.52890E-01	3.95520E-01
1.01680E+03	3.41230E-01	4.58910E-01	1.56590E-01	4.05090E-01
1.01690E+03	3.49550E-01	4.58710E-01	1.60340E-01	4.14790E-01
1.01700E+03	3.57980E-01	4.58510E-01	1.64140E-01	4.24610E-01
1.01710E+03	3.66530E-01	4.58310E-01	1.67990E-01	4.34560E-01
1.01720E+03	3.75180E-01	4.58110E-01	1.71870E-01	4.44620E-01
1.01730E+03	3.83930E-01	4.57910E-01	1.75800E-01	4.54780E-01
1.01740E+03	3.92760E-01	4.57710E-01	1.79770E-01	4.65040E-01
1.01750E+03	4.01670E-01	4.57510E-01	1.83770E-01	4.75390E-01
1.01760E+03	4.10660E-01	4.57310E-01	1.87800E-01	4.85800E-01
1.01770E+03	4.19690E-01	4.57100E-01	1.91840E-01	4.96270E-01
1.01780E+03	4.28770E-01	4.56900E-01	1.95900E-01	5.06780E-01
1.01790E+03	4.37870E-01	4.56700E-01	1.99980E-01	5.17310E-01
1.01800E+03	4.46990E-01	4.56480E-01	2.04040E-01	5.27830E-01
1.01810E+03	4.56100E-01	4.56220E-01	2.08080E-01	5.38290E-01
1.01820E+03	4.65210E-01	4.55950E-01	2.12120E-01	5.48720E-01
1.01830E+03	4.74300E-01	4.55690E-01	2.16130E-01	5.59110E-01
1.01840E+03	4.83360E-01	4.55430E-01	2.20140E-01	5.69470E-01
1.01850E+03	4.92390E-01	4.55170E-01	2.24120E-01	5.79770E-01
1.01860E+03	5.01370E-01	4.54910E-01	2.28080E-01	5.90020E-01
1.01870E+03	5.10320E-01	4.54650E-01	2.32020E-01	6.00200E-01
1.01880E+03	5.19210E-01	4.54400E-01	2.35930E-01	6.10320E-01
1.01890E+03	5.28070E-01	4.54140E-01	2.39820E-01	6.20380E-01
1.01900E+03	5.36870E-01	4.53880E-01	2.43680E-01	6.30370E-01
1.01910E+03	5.45630E-01	4.53630E-01	2.47510E-01	6.40290E-01
1.01920E+03	5.54350E-01	4.53370E-01	2.51330E-01	6.50150E-01
1.01930E+03	5.63010E-01	4.53120E-01	2.55110E-01	6.59940E-01
1.01940E+03	5.71630E-01	4.52860E-01	2.58870E-01	6.69660E-01
1.01950E+03	5.80190E-01	4.52610E-01	2.62600E-01	6.79310E-01
1.01960E+03	5.88690E-01	4.52350E-01	2.66290E-01	6.88870E-01
1.01970E+03	5.97120E-01	4.52100E-01	2.69960E-01	6.98340E-01
1.01980E+03	6.05470E-01	4.51840E-01	2.73580E-01	7.07720E-01
1.01990E+03	6.13740E-01	4.51590E-01	2.77160E-01	7.16980E-01
1.02000E+03	6.21910E-01	4.51370E-01	2.80710E-01	7.26170E-01
1.02010E+03	6.29970E-01	4.51240E-01	2.84270E-01	7.35370E-01
1.02020E+03	6.37900E-01	4.51120E-01	2.87770E-01	7.44420E-01
1.02030E+03	6.45700E-01	4.50990E-01	2.91200E-01	7.53300E-01
1.02040E+03	6.53340E-01	4.50860E-01	2.94570E-01	7.62010E-01
1.02050E+03	6.60830E-01	4.50740E-01	2.97860E-01	7.70540E-01
1.02060E+03	6.68150E-01	4.50620E-01	3.01080E-01	7.78860E-01

1.02070E+03	6.75290E-01	4.50500E-01	3.04220E-01	7.86980E-01
1.02080E+03	6.82250E-01	4.50380E-01	3.07270E-01	7.94880E-01
1.02090E+03	6.89030E-01	4.50260E-01	3.10240E-01	8.02560E-01
1.02100E+03	6.95630E-01	4.50140E-01	3.13130E-01	8.10040E-01
1.02110E+03	7.02060E-01	4.50020E-01	3.15940E-01	8.17300E-01
1.02120E+03	7.08310E-01	4.49900E-01	3.18670E-01	8.24360E-01
1.02130E+03	7.14400E-01	4.49780E-01	3.21320E-01	8.31230E-01
1.02140E+03	7.20330E-01	4.49660E-01	3.23910E-01	8.37910E-01
1.02150E+03	7.26120E-01	4.49550E-01	3.26420E-01	8.44420E-01
1.02160E+03	7.31770E-01	4.49430E-01	3.28880E-01	8.50770E-01
1.02170E+03	7.37290E-01	4.49310E-01	3.31270E-01	8.56970E-01
1.02180E+03	7.42700E-01	4.49190E-01	3.33610E-01	8.63020E-01
1.02190E+03	7.47990E-01	4.49080E-01	3.35910E-01	8.68950E-01
1.02200E+03	7.53180E-01	4.48930E-01	3.38120E-01	8.74690E-01
1.02210E+03	7.58260E-01	4.48710E-01	3.40240E-01	8.80170E-01
1.02220E+03	7.63250E-01	4.48500E-01	3.42310E-01	8.85520E-01
1.02230E+03	7.68120E-01	4.48280E-01	3.44330E-01	8.90750E-01
1.02240E+03	7.72900E-01	4.48070E-01	3.46310E-01	8.95870E-01
1.02250E+03	7.77570E-01	4.47850E-01	3.48240E-01	9.00850E-01
1.02260E+03	7.82120E-01	4.47640E-01	3.50110E-01	9.05690E-01
1.02270E+03	7.86550E-01	4.47430E-01	3.51930E-01	9.10390E-01
1.02280E+03	7.90850E-01	4.47220E-01	3.53680E-01	9.14940E-01
1.02290E+03	7.95020E-01	4.47010E-01	3.55380E-01	9.19330E-01
1.02300E+03	7.99060E-01	4.46800E-01	3.57020E-01	9.23560E-01
1.02310E+03	8.02960E-01	4.46580E-01	3.58590E-01	9.27630E-01
1.02320E+03	8.06710E-01	4.46370E-01	3.60090E-01	9.31520E-01
1.02330E+03	8.10330E-01	4.46160E-01	3.61540E-01	9.35250E-01
1.02340E+03	8.13800E-01	4.45950E-01	3.62910E-01	9.38820E-01
1.02350E+03	8.17150E-01	4.45740E-01	3.64230E-01	9.42220E-01
1.02360E+03	8.20360E-01	4.45530E-01	3.65490E-01	9.45480E-01
1.02370E+03	8.23450E-01	4.45310E-01	3.66690E-01	9.48590E-01
1.02380E+03	8.26420E-01	4.45100E-01	3.67840E-01	9.51570E-01
1.02390E+03	8.29290E-01	4.44890E-01	3.68950E-01	9.54420E-01
1.02400E+03	8.32070E-01	4.44690E-01	3.70010E-01	9.57180E-01
1.02410E+03	8.34760E-01	4.44510E-01	3.71060E-01	9.59880E-01
1.02420E+03	8.37370E-01	4.44320E-01	3.72060E-01	9.62490E-01
1.02430E+03	8.39910E-01	4.44130E-01	3.73030E-01	9.64990E-01
1.02440E+03	8.42390E-01	4.43930E-01	3.73960E-01	9.67390E-01
1.02450E+03	8.44810E-01	4.43730E-01	3.74860E-01	9.69730E-01
1.02460E+03	8.47160E-01	4.43530E-01	3.75740E-01	9.72000E-01
1.02470E+03	8.49460E-01	4.43330E-01	3.76590E-01	9.74200E-01
1.02480E+03	8.51700E-01	4.43130E-01	3.77410E-01	9.76320E-01
1.02490E+03	8.53870E-01	4.42930E-01	3.78210E-01	9.78380E-01

1.02500E+03	8.55980E-01	4.42730E-01	3.78970E-01	9.80360E-01
1.02510E+03	8.58020E-01	4.42530E-01	3.79710E-01	9.82250E-01
1.02520E+03	8.59990E-01	4.42340E-01	3.80400E-01	9.84060E-01
1.02530E+03	8.61870E-01	4.42140E-01	3.81070E-01	9.85770E-01
1.02540E+03	8.63670E-01	4.41940E-01	3.81690E-01	9.87390E-01
1.02550E+03	8.65380E-01	4.41740E-01	3.82280E-01	9.88900E-01
1.02560E+03	8.67000E-01	4.41550E-01	3.82820E-01	9.90310E-01
1.02570E+03	8.68520E-01	4.41350E-01	3.83320E-01	9.91610E-01
1.02580E+03	8.69960E-01	4.41150E-01	3.83780E-01	9.92800E-01
1.02590E+03	8.71300E-01	4.40950E-01	3.84210E-01	9.93890E-01
1.02600E+03	8.72560E-01	4.40750E-01	3.84580E-01	9.94860E-01
1.02610E+03	8.73740E-01	4.40510E-01	3.84890E-01	9.95670E-01
1.02620E+03	8.74830E-01	4.40280E-01	3.85170E-01	9.96400E-01
1.02630E+03	8.75850E-01	4.40050E-01	3.85420E-01	9.97040E-01
1.02640E+03	8.76810E-01	4.39820E-01	3.85640E-01	9.97610E-01
1.02650E+03	8.77700E-01	4.39600E-01	3.85840E-01	9.98110E-01
1.02660E+03	8.78540E-01	4.39370E-01	3.86000E-01	9.98550E-01
1.02670E+03	8.79330E-01	4.39140E-01	3.86150E-01	9.98920E-01
1.02680E+03	8.80060E-01	4.38910E-01	3.86270E-01	9.99230E-01
1.02690E+03	8.80750E-01	4.38680E-01	3.86370E-01	9.99500E-01
1.02700E+03	8.81390E-01	4.38460E-01	3.86450E-01	9.99700E-01
1.02710E+03	8.81980E-01	4.38230E-01	3.86510E-01	9.99860E-01
1.02720E+03	8.82520E-01	4.38010E-01	3.86550E-01	9.99960E-01
1.02730E+03	8.83000E-01	4.37790E-01	3.86570E-01	1.00000E+00
1.02740E+03	8.83420E-01	4.37560E-01	3.86550E-01	9.99970E-01
1.02750E+03	8.83780E-01	4.37340E-01	3.86510E-01	9.99870E-01
1.02760E+03	8.84080E-01	4.37120E-01	3.86450E-01	9.99690E-01
1.02770E+03	8.84290E-01	4.36900E-01	3.86340E-01	9.99430E-01
1.02780E+03	8.84440E-01	4.36670E-01	3.86210E-01	9.99080E-01
1.02790E+03	8.84500E-01	4.36450E-01	3.86040E-01	9.98640E-01
1.02800E+03	8.84480E-01	4.36240E-01	3.85850E-01	9.98150E-01
1.02810E+03	8.84380E-01	4.36070E-01	3.85660E-01	9.97650E-01
1.02820E+03	8.84200E-01	4.35910E-01	3.85430E-01	9.97070E-01
1.02830E+03	8.83930E-01	4.35750E-01	3.85180E-01	9.96410E-01
1.02840E+03	8.83590E-01	4.35600E-01	3.84890E-01	9.95660E-01
1.02850E+03	8.83170E-01	4.35440E-01	3.84560E-01	9.94820E-01
1.02860E+03	8.82680E-01	4.35280E-01	3.84210E-01	9.93910E-01
1.02870E+03	8.82130E-01	4.35120E-01	3.83830E-01	9.92920E-01
1.02880E+03	8.81510E-01	4.34960E-01	3.83420E-01	9.91860E-01
1.02890E+03	8.80830E-01	4.34800E-01	3.82980E-01	9.90730E-01
1.02900E+03	8.80100E-01	4.34640E-01	3.82530E-01	9.89550E-01
1.02910E+03	8.79320E-01	4.34480E-01	3.82050E-01	9.88310E-01
1.02920E+03	8.78490E-01	4.34320E-01	3.81550E-01	9.87020E-01

1.02930E+03	8.77620E-01	4.34160E-01	3.81030E-01	9.85680E-01
1.02940E+03	8.76700E-01	4.34000E-01	3.80490E-01	9.84280E-01
1.02950E+03	8.75730E-01	4.33840E-01	3.79930E-01	9.82830E-01
1.02960E+03	8.74710E-01	4.33690E-01	3.79350E-01	9.81330E-01
1.02970E+03	8.73630E-01	4.33530E-01	3.78740E-01	9.79760E-01
1.02980E+03	8.72500E-01	4.33370E-01	3.78110E-01	9.78140E-01
1.02990E+03	8.71310E-01	4.33210E-01	3.77460E-01	9.76440E-01
1.03000E+03	8.70050E-01	4.33050E-01	3.76780E-01	9.74670E-01
1.03010E+03	8.68720E-01	4.32900E-01	3.76070E-01	9.72840E-01
1.03020E+03	8.67310E-01	4.32750E-01	3.75330E-01	9.70930E-01
1.03030E+03	8.65820E-01	4.32600E-01	3.74560E-01	9.68930E-01
1.03040E+03	8.64260E-01	4.32450E-01	3.73750E-01	9.66840E-01
1.03050E+03	8.62600E-01	4.32300E-01	3.72900E-01	9.64650E-01
1.03060E+03	8.60860E-01	4.32150E-01	3.72020E-01	9.62370E-01
1.03070E+03	8.59030E-01	4.32000E-01	3.71100E-01	9.59990E-01
1.03080E+03	8.57110E-01	4.31850E-01	3.70140E-01	9.57520E-01
1.03090E+03	8.55100E-01	4.31700E-01	3.69150E-01	9.54940E-01
1.03100E+03	8.53010E-01	4.31550E-01	3.68120E-01	9.52270E-01
1.03110E+03	8.50830E-01	4.31400E-01	3.67040E-01	9.49500E-01
1.03120E+03	8.48560E-01	4.31250E-01	3.65940E-01	9.46640E-01
1.03130E+03	8.46220E-01	4.31090E-01	3.64800E-01	9.43690E-01
1.03140E+03	8.43790E-01	4.30940E-01	3.63630E-01	9.40660E-01
1.03150E+03	8.41290E-01	4.30790E-01	3.62420E-01	9.37540E-01
1.03160E+03	8.38720E-01	4.30640E-01	3.61180E-01	9.34340E-01
1.03170E+03	8.36070E-01	4.30490E-01	3.59920E-01	9.31060E-01
1.03180E+03	8.33350E-01	4.30330E-01	3.58620E-01	9.27700E-01
1.03190E+03	8.30570E-01	4.30180E-01	3.57290E-01	9.24280E-01
1.03200E+03	8.27720E-01	4.30020E-01	3.55940E-01	9.20770E-01
1.03210E+03	8.24800E-01	4.29850E-01	3.54540E-01	9.17150E-01
1.03220E+03	8.21830E-01	4.29670E-01	3.53120E-01	9.13480E-01
1.03230E+03	8.18800E-01	4.29500E-01	3.51670E-01	9.09740E-01
1.03240E+03	8.15710E-01	4.29320E-01	3.50200E-01	9.05930E-01
1.03250E+03	8.12570E-01	4.29150E-01	3.48710E-01	9.02080E-01
1.03260E+03	8.09370E-01	4.28970E-01	3.47200E-01	8.98170E-01
1.03270E+03	8.06130E-01	4.28800E-01	3.45670E-01	8.94200E-01
1.03280E+03	8.02850E-01	4.28620E-01	3.44120E-01	8.90200E-01
1.03290E+03	7.99520E-01	4.28450E-01	3.42550E-01	8.86140E-01
1.03300E+03	7.96150E-01	4.28270E-01	3.40970E-01	8.82040E-01
1.03310E+03	7.92730E-01	4.28100E-01	3.39370E-01	8.77900E-01
1.03320E+03	7.89290E-01	4.27920E-01	3.37750E-01	8.73720E-01
1.03330E+03	7.85800E-01	4.27740E-01	3.36120E-01	8.69500E-01
1.03340E+03	7.82270E-01	4.27570E-01	3.34470E-01	8.65240E-01
1.03350E+03	7.78700E-01	4.27390E-01	3.32810E-01	8.60930E-01

1.03360E+03	7.75090E-01	4.27210E-01	3.31130E-01	8.56580E-01
1.03370E+03	7.71430E-01	4.27030E-01	3.29430E-01	8.52180E-01
1.03380E+03	7.67710E-01	4.26860E-01	3.27700E-01	8.47730E-01
1.03390E+03	7.63940E-01	4.26680E-01	3.25960E-01	8.43220E-01
1.03400E+03	7.60110E-01	4.26530E-01	3.24210E-01	8.38700E-01
1.03410E+03	7.56210E-01	4.26420E-01	3.22460E-01	8.34170E-01
1.03420E+03	7.52240E-01	4.26300E-01	3.20680E-01	8.29560E-01
1.03430E+03	7.48180E-01	4.26190E-01	3.18870E-01	8.24870E-01
1.03440E+03	7.44050E-01	4.26070E-01	3.17020E-01	8.20090E-01
1.03450E+03	7.39830E-01	4.25960E-01	3.15140E-01	8.15220E-01
1.03460E+03	7.35520E-01	4.25840E-01	3.13220E-01	8.10250E-01
1.03470E+03	7.31130E-01	4.25720E-01	3.11260E-01	8.05190E-01
1.03480E+03	7.26650E-01	4.25610E-01	3.09270E-01	8.00050E-01
1.03490E+03	7.22100E-01	4.25490E-01	3.07250E-01	7.94810E-01
1.03500E+03	7.17460E-01	4.25380E-01	3.05190E-01	7.89490E-01
1.03510E+03	7.12760E-01	4.25260E-01	3.03110E-01	7.84100E-01
1.03520E+03	7.07990E-01	4.25150E-01	3.01000E-01	7.78650E-01
1.03530E+03	7.03180E-01	4.25030E-01	2.98870E-01	7.73140E-01
1.03540E+03	6.98320E-01	4.24910E-01	2.96720E-01	7.67590E-01
1.03550E+03	6.93430E-01	4.24800E-01	2.94570E-01	7.62010E-01
1.03560E+03	6.88510E-01	4.24680E-01	2.92400E-01	7.56400E-01
1.03570E+03	6.83580E-01	4.24560E-01	2.90230E-01	7.50780E-01
1.03580E+03	6.78650E-01	4.24450E-01	2.88050E-01	7.45150E-01
1.03590E+03	6.73710E-01	4.24330E-01	2.85880E-01	7.39530E-01
1.03600E+03	6.68780E-01	4.24200E-01	2.83700E-01	7.33900E-01
1.03610E+03	6.63860E-01	4.24050E-01	2.81510E-01	7.28230E-01
1.03620E+03	6.58940E-01	4.23890E-01	2.79320E-01	7.22570E-01
1.03630E+03	6.54040E-01	4.23730E-01	2.77140E-01	7.16920E-01
1.03640E+03	6.49130E-01	4.23580E-01	2.74960E-01	7.11280E-01
1.03650E+03	6.44230E-01	4.23420E-01	2.72780E-01	7.05640E-01
1.03660E+03	6.39310E-01	4.23260E-01	2.70600E-01	7.00000E-01
1.03670E+03	6.34390E-01	4.23100E-01	2.68410E-01	6.94350E-01
1.03680E+03	6.29440E-01	4.22950E-01	2.66220E-01	6.88680E-01
1.03690E+03	6.24460E-01	4.22790E-01	2.64020E-01	6.82980E-01
1.03700E+03	6.19450E-01	4.22630E-01	2.61800E-01	6.77240E-01
1.03710E+03	6.14390E-01	4.22480E-01	2.59570E-01	6.71470E-01
1.03720E+03	6.09280E-01	4.22320E-01	2.57310E-01	6.65640E-01
1.03730E+03	6.04120E-01	4.22170E-01	2.55040E-01	6.59760E-01
1.03740E+03	5.98910E-01	4.22010E-01	2.52750E-01	6.53830E-01
1.03750E+03	5.93640E-01	4.21860E-01	2.50430E-01	6.47830E-01
1.03760E+03	5.88310E-01	4.21700E-01	2.48090E-01	6.41780E-01
1.03770E+03	5.82930E-01	4.21550E-01	2.45730E-01	6.35680E-01
1.03780E+03	5.77500E-01	4.21390E-01	2.43350E-01	6.29520E-01

1.03790E+03	5.72020E-01	4.21230E-01	2.40950E-01	6.23310E-01
1.03800E+03	5.66510E-01	4.21050E-01	2.38530E-01	6.17050E-01
1.03810E+03	5.60970E-01	4.20860E-01	2.36090E-01	6.10730E-01
1.03820E+03	5.55410E-01	4.20660E-01	2.33640E-01	6.04400E-01
1.03830E+03	5.49820E-01	4.20470E-01	2.31180E-01	5.98040E-01
1.03840E+03	5.44230E-01	4.20270E-01	2.28730E-01	5.91690E-01
1.03850E+03	5.38640E-01	4.20080E-01	2.26270E-01	5.85340E-01
1.03860E+03	5.33050E-01	4.19880E-01	2.23820E-01	5.78990E-01
1.03870E+03	5.27460E-01	4.19690E-01	2.21370E-01	5.72660E-01
1.03880E+03	5.21890E-01	4.19500E-01	2.18930E-01	5.66350E-01
1.03890E+03	5.16330E-01	4.19300E-01	2.16500E-01	5.60050E-01
1.03900E+03	5.10780E-01	4.19100E-01	2.14070E-01	5.53770E-01
1.03910E+03	5.05240E-01	4.18900E-01	2.11650E-01	5.47500E-01
1.03920E+03	4.99710E-01	4.18700E-01	2.09230E-01	5.41250E-01
1.03930E+03	4.94190E-01	4.18500E-01	2.06820E-01	5.35020E-01
1.03940E+03	4.88670E-01	4.18300E-01	2.04410E-01	5.28790E-01
1.03950E+03	4.83160E-01	4.18100E-01	2.02010E-01	5.22570E-01
1.03960E+03	4.77650E-01	4.17900E-01	1.99610E-01	5.16360E-01
1.03970E+03	4.72130E-01	4.17700E-01	1.97210E-01	5.10150E-01
1.03980E+03	4.66610E-01	4.17500E-01	1.94810E-01	5.03950E-01
1.03990E+03	4.61070E-01	4.17300E-01	1.92410E-01	4.97740E-01
1.04000E+03	4.55530E-01	4.17110E-01	1.90010E-01	4.91520E-01
1.04010E+03	4.49980E-01	4.16920E-01	1.87600E-01	4.85310E-01
1.04020E+03	4.44410E-01	4.16720E-01	1.85200E-01	4.79080E-01
1.04030E+03	4.38840E-01	4.16530E-01	1.82790E-01	4.72850E-01
1.04040E+03	4.33250E-01	4.16340E-01	1.80380E-01	4.66620E-01
1.04050E+03	4.27660E-01	4.16140E-01	1.77970E-01	4.60380E-01
1.04060E+03	4.22060E-01	4.15950E-01	1.75560E-01	4.54140E-01
1.04070E+03	4.16460E-01	4.15760E-01	1.73150E-01	4.47910E-01
1.04080E+03	4.10850E-01	4.15570E-01	1.70740E-01	4.41680E-01
1.04090E+03	4.05250E-01	4.15370E-01	1.68330E-01	4.35450E-01
1.04100E+03	3.99660E-01	4.15180E-01	1.65930E-01	4.29240E-01
1.04110E+03	3.94080E-01	4.14990E-01	1.63540E-01	4.23050E-01
1.04120E+03	3.88510E-01	4.14800E-01	1.61150E-01	4.16880E-01
1.04130E+03	3.82950E-01	4.14610E-01	1.58770E-01	4.10730E-01
1.04140E+03	3.77420E-01	4.14420E-01	1.56410E-01	4.04610E-01
1.04150E+03	3.71910E-01	4.14230E-01	1.54050E-01	3.98520E-01
1.04160E+03	3.66430E-01	4.14040E-01	1.51710E-01	3.92460E-01
1.04170E+03	3.60970E-01	4.13850E-01	1.49390E-01	3.86450E-01
1.04180E+03	3.55550E-01	4.13670E-01	1.47080E-01	3.80480E-01
1.04190E+03	3.50170E-01	4.13480E-01	1.44790E-01	3.74550E-01
1.04200E+03	3.44820E-01	4.13310E-01	1.42520E-01	3.68680E-01
1.04210E+03	3.39510E-01	4.13180E-01	1.40280E-01	3.62880E-01

1.04220E+03	3.34240E-01	4.13050E-01	1.38060E-01	3.57140E-01
1.04230E+03	3.29010E-01	4.12920E-01	1.35850E-01	3.51440E-01
1.04240E+03	3.23820E-01	4.12790E-01	1.33670E-01	3.45780E-01
1.04250E+03	3.18670E-01	4.12660E-01	1.31500E-01	3.40180E-01
1.04260E+03	3.13560E-01	4.12530E-01	1.29350E-01	3.34610E-01
1.04270E+03	3.08490E-01	4.12390E-01	1.27220E-01	3.29100E-01
1.04280E+03	3.03450E-01	4.12260E-01	1.25100E-01	3.23620E-01
1.04290E+03	2.98440E-01	4.12130E-01	1.23000E-01	3.18180E-01
1.04300E+03	2.93470E-01	4.12000E-01	1.20910E-01	3.12780E-01
1.04310E+03	2.88520E-01	4.11870E-01	1.18830E-01	3.07410E-01
1.04320E+03	2.83590E-01	4.11750E-01	1.16770E-01	3.02070E-01
1.04330E+03	2.78690E-01	4.11620E-01	1.14710E-01	2.96750E-01
1.04340E+03	2.73800E-01	4.11490E-01	1.12660E-01	2.91450E-01
1.04350E+03	2.68920E-01	4.11370E-01	1.10620E-01	2.86170E-01
1.04360E+03	2.64060E-01	4.11230E-01	1.08590E-01	2.80910E-01
1.04370E+03	2.59210E-01	4.11100E-01	1.06560E-01	2.75670E-01
1.04380E+03	2.54380E-01	4.10970E-01	1.04540E-01	2.70440E-01
1.04390E+03	2.49570E-01	4.10830E-01	1.02530E-01	2.65230E-01
1.04400E+03	2.44770E-01	4.10700E-01	1.00530E-01	2.60050E-01
1.04410E+03	2.40000E-01	4.10540E-01	9.85300E-02	2.54880E-01
1.04420E+03	2.35260E-01	4.10390E-01	9.65470E-02	2.49760E-01
1.04430E+03	2.30550E-01	4.10230E-01	9.45810E-02	2.44670E-01
1.04440E+03	2.25890E-01	4.10080E-01	9.26340E-02	2.39630E-01
1.04450E+03	2.21280E-01	4.09930E-01	9.07100E-02	2.34660E-01
1.04460E+03	2.16730E-01	4.09770E-01	8.88110E-02	2.29740E-01
1.04470E+03	2.12240E-01	4.09620E-01	8.69390E-02	2.24900E-01
1.04480E+03	2.07830E-01	4.09470E-01	8.50970E-02	2.20140E-01
1.04490E+03	2.03480E-01	4.09310E-01	8.32880E-02	2.15460E-01
1.04500E+03	1.99220E-01	4.09160E-01	8.15110E-02	2.10860E-01
1.04510E+03	1.95030E-01	4.09000E-01	7.97690E-02	2.06350E-01
1.04520E+03	1.90930E-01	4.08850E-01	7.80600E-02	2.01930E-01
1.04530E+03	1.86900E-01	4.08690E-01	7.63850E-02	1.97600E-01
1.04540E+03	1.82950E-01	4.08530E-01	7.47410E-02	1.93350E-01
1.04550E+03	1.79070E-01	4.08380E-01	7.31270E-02	1.89170E-01
1.04560E+03	1.75250E-01	4.08220E-01	7.15400E-02	1.85070E-01
1.04570E+03	1.71490E-01	4.08070E-01	6.99770E-02	1.81020E-01
1.04580E+03	1.67770E-01	4.07910E-01	6.84350E-02	1.77030E-01
1.04590E+03	1.64090E-01	4.07760E-01	6.69090E-02	1.73090E-01
1.04600E+03	1.60450E-01	4.07600E-01	6.53980E-02	1.69180E-01
1.04610E+03	1.56830E-01	4.07460E-01	6.39000E-02	1.65300E-01
1.04620E+03	1.53220E-01	4.07320E-01	6.24100E-02	1.61450E-01
1.04630E+03	1.49630E-01	4.07180E-01	6.09270E-02	1.57610E-01
1.04640E+03	1.46050E-01	4.07030E-01	5.94490E-02	1.53790E-01

1.04650E+03	1.42480E-01	4.06890E-01	5.79760E-02	1.49980E-01
1.04660E+03	1.38930E-01	4.06750E-01	5.65100E-02	1.46180E-01
1.04670E+03	1.35390E-01	4.06610E-01	5.50510E-02	1.42410E-01
1.04680E+03	1.31870E-01	4.06470E-01	5.36030E-02	1.38660E-01
1.04690E+03	1.28390E-01	4.06330E-01	5.21670E-02	1.34950E-01
1.04700E+03	1.24940E-01	4.06180E-01	5.07480E-02	1.31280E-01
1.04710E+03	1.21540E-01	4.06040E-01	4.93510E-02	1.27660E-01
1.04720E+03	1.18200E-01	4.05900E-01	4.79780E-02	1.24110E-01
1.04730E+03	1.14930E-01	4.05760E-01	4.66340E-02	1.20640E-01
1.04740E+03	1.11740E-01	4.05630E-01	4.53240E-02	1.17250E-01
1.04750E+03	1.08640E-01	4.05500E-01	4.40510E-02	1.13960E-01
1.04760E+03	1.05630E-01	4.05370E-01	4.28180E-02	1.10760E-01
1.04770E+03	1.02720E-01	4.05240E-01	4.16260E-02	1.07680E-01
1.04780E+03	9.99150E-02	4.05110E-01	4.04760E-02	1.04710E-01
1.04790E+03	9.72160E-02	4.04980E-01	3.93700E-02	1.01850E-01
1.04800E+03	9.46180E-02	4.04840E-01	3.83050E-02	9.90900E-02
1.04810E+03	9.21200E-02	4.04670E-01	3.72780E-02	9.64340E-02
1.04820E+03	8.97150E-02	4.04500E-01	3.62900E-02	9.38770E-02
1.04830E+03	8.73960E-02	4.04330E-01	3.53370E-02	9.14120E-02
1.04840E+03	8.51540E-02	4.04160E-01	3.44160E-02	8.90290E-02
1.04850E+03	8.29800E-02	4.03990E-01	3.35230E-02	8.67200E-02
1.04860E+03	8.08630E-02	4.03820E-01	3.26540E-02	8.44720E-02
1.04870E+03	7.87940E-02	4.03650E-01	3.18050E-02	8.22770E-02
1.04880E+03	7.67640E-02	4.03480E-01	3.09730E-02	8.01240E-02
1.04890E+03	7.47660E-02	4.03310E-01	3.01540E-02	7.80050E-02
1.04900E+03	7.27920E-02	4.03150E-01	2.93460E-02	7.59140E-02
1.04910E+03	7.08380E-02	4.02980E-01	2.85460E-02	7.38460E-02
1.04920E+03	6.89010E-02	4.02810E-01	2.77540E-02	7.17970E-02
1.04930E+03	6.69810E-02	4.02650E-01	2.69700E-02	6.97680E-02
1.04940E+03	6.50780E-02	4.02480E-01	2.61930E-02	6.77570E-02
1.04950E+03	6.31960E-02	4.02310E-01	2.54240E-02	6.57690E-02
1.04960E+03	6.13390E-02	4.02130E-01	2.46660E-02	6.38090E-02
1.04970E+03	5.95120E-02	4.01960E-01	2.39220E-02	6.18820E-02
1.04980E+03	5.77220E-02	4.01790E-01	2.31920E-02	5.99950E-02
1.04990E+03	5.59750E-02	4.01620E-01	2.24800E-02	5.81540E-02
1.05000E+03	5.42770E-02	4.01440E-01	2.17890E-02	5.63670E-02
1.05010E+03	5.26360E-02	4.01270E-01	2.11210E-02	5.46380E-02
1.05020E+03	5.10550E-02	4.01090E-01	2.04780E-02	5.29730E-02
1.05030E+03	4.95390E-02	4.00910E-01	1.98610E-02	5.13770E-02
1.05040E+03	4.80890E-02	4.00740E-01	1.92710E-02	4.98520E-02
1.05050E+03	4.67070E-02	4.00560E-01	1.87090E-02	4.83980E-02
1.05060E+03	4.53910E-02	4.00380E-01	1.81740E-02	4.70140E-02
1.05070E+03	4.41390E-02	4.00210E-01	1.76650E-02	4.56970E-02

1.05080E+03	4.29470E-02	4.00030E-01	1.71800E-02	4.44430E-02
1.05090E+03	4.18090E-02	3.99850E-01	1.67170E-02	4.32460E-02
1.05100E+03	4.07180E-02	3.99680E-01	1.62740E-02	4.20990E-02
1.05110E+03	3.96670E-02	3.99500E-01	1.58470E-02	4.09940E-02
1.05120E+03	3.86490E-02	3.99320E-01	1.54330E-02	3.99250E-02
1.05130E+03	3.76560E-02	3.99150E-01	1.50300E-02	3.88810E-02
1.05140E+03	3.66810E-02	3.98970E-01	1.46340E-02	3.78570E-02
1.05150E+03	3.57170E-02	3.98790E-01	1.42430E-02	3.68460E-02
1.05160E+03	3.47580E-02	3.98610E-01	1.38550E-02	3.58420E-02
1.05170E+03	3.38020E-02	3.98440E-01	1.34680E-02	3.48400E-02
1.05180E+03	3.28440E-02	3.98260E-01	1.30800E-02	3.38380E-02
1.05190E+03	3.18840E-02	3.98080E-01	1.26920E-02	3.28340E-02
1.05200E+03	3.09210E-02	3.97910E-01	1.23040E-02	3.18290E-02
1.05210E+03	2.99580E-02	3.97770E-01	1.19160E-02	3.08260E-02
1.05220E+03	2.89970E-02	3.97620E-01	1.15300E-02	2.98270E-02
1.05230E+03	2.80430E-02	3.97480E-01	1.11460E-02	2.88340E-02
1.05240E+03	2.71000E-02	3.97330E-01	1.07680E-02	2.78540E-02
1.05250E+03	2.61730E-02	3.97180E-01	1.03950E-02	2.68920E-02
1.05260E+03	2.52680E-02	3.97040E-01	1.00320E-02	2.59530E-02
1.05270E+03	2.43910E-02	3.96890E-01	9.68070E-03	2.50430E-02
1.05280E+03	2.35470E-02	3.96750E-01	9.34220E-03	2.41670E-02
1.05290E+03	2.27410E-02	3.96600E-01	9.01890E-03	2.33310E-02
1.05300E+03	2.19750E-02	3.96450E-01	8.71220E-03	2.25370E-02
1.05310E+03	2.12540E-02	3.96300E-01	8.42320E-03	2.17900E-02
1.05320E+03	2.05790E-02	3.96150E-01	8.15250E-03	2.10900E-02
1.05330E+03	1.99500E-02	3.96000E-01	7.90040E-03	2.04370E-02
1.05340E+03	1.93670E-02	3.95850E-01	7.66650E-03	1.98320E-02
1.05350E+03	1.88280E-02	3.95700E-01	7.45020E-03	1.92730E-02
1.05360E+03	1.83300E-02	3.95550E-01	7.25030E-03	1.87560E-02
1.05370E+03	1.78690E-02	3.95390E-01	7.06510E-03	1.82770E-02
1.05380E+03	1.74400E-02	3.95240E-01	6.89290E-03	1.78310E-02
1.05390E+03	1.70380E-02	3.95090E-01	6.73150E-03	1.74140E-02
1.05400E+03	1.66580E-02	3.94940E-01	6.57870E-03	1.70180E-02
1.05410E+03	1.62940E-02	3.94780E-01	6.43240E-03	1.66400E-02
1.05420E+03	1.59400E-02	3.94630E-01	6.29040E-03	1.62720E-02
1.05430E+03	1.55920E-02	3.94470E-01	6.15060E-03	1.59110E-02
1.05440E+03	1.52440E-02	3.94320E-01	6.01120E-03	1.55500E-02
1.05450E+03	1.48940E-02	3.94160E-01	5.87070E-03	1.51870E-02
1.05460E+03	1.45370E-02	3.94010E-01	5.72780E-03	1.48170E-02
1.05470E+03	1.41720E-02	3.93860E-01	5.58170E-03	1.44390E-02
1.05480E+03	1.37970E-02	3.93700E-01	5.43190E-03	1.40520E-02
1.05490E+03	1.34110E-02	3.93550E-01	5.27800E-03	1.36540E-02
1.05500E+03	1.30160E-02	3.93390E-01	5.12040E-03	1.32460E-02

1.05510E+03	1.26120E-02	3.93240E-01	4.95940E-03	1.28300E-02
1.05520E+03	1.22010E-02	3.93090E-01	4.79610E-03	1.24070E-02
1.05530E+03	1.17860E-02	3.92940E-01	4.63140E-03	1.19810E-02
1.05540E+03	1.13710E-02	3.92790E-01	4.46650E-03	1.15540E-02
1.05550E+03	1.09590E-02	3.92640E-01	4.30290E-03	1.11310E-02
1.05560E+03	1.05530E-02	3.92490E-01	4.14200E-03	1.07150E-02
1.05570E+03	1.01570E-02	3.92350E-01	3.98520E-03	1.03090E-02
1.05580E+03	9.77530E-03	3.92200E-01	3.83390E-03	9.91770E-03
1.05590E+03	9.40980E-03	3.92050E-01	3.68910E-03	9.54330E-03
1.05600E+03	9.06330E-03	3.91880E-01	3.55170E-03	9.18790E-03
1.05610E+03	8.73760E-03	3.91660E-01	3.42220E-03	8.85280E-03
1.05620E+03	8.43390E-03	3.91440E-01	3.30140E-03	8.54030E-03
1.05630E+03	8.15270E-03	3.91220E-01	3.18950E-03	8.25090E-03
1.05640E+03	7.89370E-03	3.91000E-01	3.08650E-03	7.98430E-03
1.05650E+03	7.65610E-03	3.90780E-01	2.99190E-03	7.73960E-03
1.05660E+03	7.43850E-03	3.90560E-01	2.90520E-03	7.51550E-03
1.05670E+03	7.23900E-03	3.90340E-01	2.82570E-03	7.30970E-03
1.05680E+03	7.05520E-03	3.90120E-01	2.75240E-03	7.12020E-03
1.05690E+03	6.88460E-03	3.89900E-01	2.68440E-03	6.94410E-03
1.05700E+03	6.72440E-03	3.89690E-01	2.62040E-03	6.77870E-03
1.05710E+03	6.57170E-03	3.89470E-01	2.55950E-03	6.62100E-03
1.05720E+03	6.42390E-03	3.89240E-01	2.50050E-03	6.46840E-03
1.05730E+03	6.27860E-03	3.89020E-01	2.44250E-03	6.31840E-03
1.05740E+03	6.13390E-03	3.88790E-01	2.38480E-03	6.16930E-03
1.05750E+03	5.98850E-03	3.88570E-01	2.32690E-03	6.01950E-03
1.05760E+03	5.84150E-03	3.88340E-01	2.26850E-03	5.86840E-03
1.05770E+03	5.69320E-03	3.88120E-01	2.20960E-03	5.71600E-03
1.05780E+03	5.54400E-03	3.87900E-01	2.15050E-03	5.56300E-03
1.05790E+03	5.39510E-03	3.87670E-01	2.09150E-03	5.41060E-03
1.05800E+03	5.24840E-03	3.87440E-01	2.03350E-03	5.26030E-03
1.05810E+03	5.10570E-03	3.87200E-01	1.97700E-03	5.11410E-03
1.05820E+03	4.96910E-03	3.86960E-01	1.92280E-03	4.97420E-03
1.05830E+03	4.84060E-03	3.86720E-01	1.87200E-03	4.84260E-03
1.05840E+03	4.72220E-03	3.86490E-01	1.82500E-03	4.72120E-03
1.05850E+03	4.61540E-03	3.86250E-01	1.78270E-03	4.61150E-03
1.05860E+03	4.52150E-03	3.86010E-01	1.74530E-03	4.51490E-03
1.05870E+03	4.44130E-03	3.85770E-01	1.71330E-03	4.43220E-03
1.05880E+03	4.37510E-03	3.85530E-01	1.68680E-03	4.36340E-03
1.05890E+03	4.32280E-03	3.85290E-01	1.66550E-03	4.30860E-03
1.05900E+03	4.28350E-03	3.85060E-01	1.64940E-03	4.26680E-03
1.05910E+03	4.25560E-03	3.84830E-01	1.63770E-03	4.23650E-03
1.05920E+03	4.23730E-03	3.84600E-01	1.62970E-03	4.21580E-03
1.05930E+03	4.22580E-03	3.84370E-01	1.62430E-03	4.20180E-03

1.05940E+03	4.21800E-03	3.84150E-01	1.62030E-03	4.19160E-03
1.05950E+03	4.21080E-03	3.83920E-01	1.61660E-03	4.18200E-03
1.05960E+03	4.20070E-03	3.83690E-01	1.61180E-03	4.16950E-03
1.05970E+03	4.18460E-03	3.83470E-01	1.60460E-03	4.15100E-03
1.05980E+03	4.15960E-03	3.83240E-01	1.59410E-03	4.12380E-03
1.05990E+03	4.12360E-03	3.83010E-01	1.57940E-03	4.08570E-03
1.06000E+03	4.07490E-03	3.82790E-01	1.55980E-03	4.03510E-03
1.06010E+03	4.01280E-03	3.82570E-01	1.53520E-03	3.97130E-03
1.06020E+03	3.93710E-03	3.82350E-01	1.50530E-03	3.89410E-03
1.06030E+03	3.84830E-03	3.82130E-01	1.47060E-03	3.80420E-03
1.06040E+03	3.74770E-03	3.81910E-01	1.43130E-03	3.70260E-03
1.06050E+03	3.63690E-03	3.81690E-01	1.38820E-03	3.59100E-03
1.06060E+03	3.51760E-03	3.81470E-01	1.34190E-03	3.47120E-03
1.06070E+03	3.39230E-03	3.81250E-01	1.29330E-03	3.34560E-03
1.06080E+03	3.26300E-03	3.81030E-01	1.24330E-03	3.21630E-03
1.06090E+03	3.13210E-03	3.80820E-01	1.19270E-03	3.08550E-03
1.06100E+03	3.00170E-03	3.80610E-01	1.14250E-03	2.95550E-03
1.06110E+03	2.87390E-03	3.80400E-01	1.09330E-03	2.82810E-03
1.06120E+03	2.75040E-03	3.80200E-01	1.04570E-03	2.70510E-03
1.06130E+03	2.63270E-03	3.79990E-01	1.00040E-03	2.58790E-03
1.06140E+03	2.52160E-03	3.79790E-01	9.57660E-04	2.47740E-03
1.06150E+03	2.41750E-03	3.79580E-01	9.17650E-04	2.37390E-03
1.06160E+03	2.32040E-03	3.79380E-01	8.80300E-04	2.27720E-03
1.06170E+03	2.22940E-03	3.79170E-01	8.45310E-04	2.18670E-03
1.06180E+03	2.14310E-03	3.78970E-01	8.12180E-04	2.10100E-03
1.06190E+03	2.06010E-03	3.78760E-01	7.80300E-04	2.01860E-03
1.06200E+03	1.97860E-03	3.78570E-01	7.49050E-04	1.93770E-03
1.06210E+03	1.89700E-03	3.78390E-01	7.17810E-04	1.85690E-03
1.06220E+03	1.81410E-03	3.78210E-01	6.86120E-04	1.77490E-03
1.06230E+03	1.72930E-03	3.78030E-01	6.53720E-04	1.69110E-03
1.06240E+03	1.64240E-03	3.77860E-01	6.20580E-04	1.60540E-03
1.06250E+03	1.55420E-03	3.77680E-01	5.86990E-04	1.51850E-03
1.06260E+03	1.46590E-03	3.77500E-01	5.53380E-04	1.43150E-03
1.06270E+03	1.37910E-03	3.77320E-01	5.20380E-04	1.34610E-03
1.06280E+03	1.29580E-03	3.77150E-01	4.88700E-04	1.26420E-03
1.06290E+03	1.21780E-03	3.76980E-01	4.59080E-04	1.18760E-03
1.06300E+03	1.14690E-03	3.76810E-01	4.32160E-04	1.11790E-03
1.06310E+03	1.08470E-03	3.76650E-01	4.08550E-04	1.05690E-03
1.06320E+03	1.03260E-03	3.76480E-01	3.88740E-04	1.00560E-03
1.06330E+03	9.91700E-04	3.76320E-01	3.73200E-04	9.65420E-04
1.06340E+03	9.63530E-04	3.76160E-01	3.62440E-04	9.37590E-04
1.06350E+03	9.49450E-04	3.75990E-01	3.56990E-04	9.23490E-04
1.06360E+03	0.00000E+00	3.75830E-01	0.00000E+00	0.00000E+00

Channel 10				
Wavenumber	HIRS Filter Transmittance	Optical Element Transmittance	Product of the HIRS Filter and Optical Element Transmittances	Normalized Value of Column 4
7.79320E+02	0.00000E+00	4.77910E-01	0.00000E+00	0.00000E+00
7.79420E+02	1.85710E-04	4.78130E-01	8.87930E-05	2.18420E-04
7.79520E+02	2.97140E-04	4.78350E-01	1.42140E-04	3.49640E-04
7.79620E+02	3.24260E-04	4.78580E-01	1.55180E-04	3.81730E-04
7.79720E+02	2.56860E-04	4.78800E-01	1.22980E-04	3.02520E-04
7.79820E+02	1.36060E-04	4.79020E-01	6.51740E-05	1.60320E-04
7.79920E+02	2.75590E-04	4.79240E-01	1.32080E-04	3.24890E-04
7.80020E+02	6.15770E-04	4.79470E-01	2.95240E-04	7.26250E-04
7.80120E+02	1.01770E-03	4.79690E-01	4.88160E-04	1.20080E-03
7.80220E+02	1.43590E-03	4.79910E-01	6.89110E-04	1.69510E-03
7.80320E+02	1.83260E-03	4.80140E-01	8.79900E-04	2.16440E-03
7.80420E+02	1.58140E-03	4.80360E-01	7.59640E-04	1.86860E-03
7.80520E+02	1.67820E-03	4.80580E-01	8.06520E-04	1.98390E-03
7.80620E+02	1.77330E-03	4.80810E-01	8.52590E-04	2.09730E-03
7.80720E+02	1.87220E-03	4.81030E-01	9.00580E-04	2.21530E-03
7.80820E+02	1.98030E-03	4.81250E-01	9.53020E-04	2.34430E-03
7.80920E+02	2.10020E-03	4.81480E-01	1.01120E-03	2.48750E-03
7.81020E+02	2.21940E-03	4.81700E-01	1.06910E-03	2.62970E-03
7.81120E+02	2.32770E-03	4.81930E-01	1.12180E-03	2.75940E-03
7.81220E+02	2.42210E-03	4.82150E-01	1.16780E-03	2.87270E-03
7.81320E+02	2.50220E-03	4.82350E-01	1.20690E-03	2.96880E-03
7.81420E+02	2.56970E-03	4.82540E-01	1.24000E-03	3.05020E-03
7.81520E+02	2.62870E-03	4.82740E-01	1.26900E-03	3.12150E-03
7.81620E+02	2.68470E-03	4.82930E-01	1.29650E-03	3.18920E-03
7.81720E+02	2.74400E-03	4.83130E-01	1.32570E-03	3.26100E-03
7.81820E+02	2.81280E-03	4.83330E-01	1.35950E-03	3.34410E-03
7.81920E+02	2.89620E-03	4.83520E-01	1.40040E-03	3.44470E-03
7.82020E+02	2.99740E-03	4.83700E-01	1.44990E-03	3.56640E-03
7.82120E+02	3.11720E-03	4.83790E-01	1.50810E-03	3.70970E-03
7.82220E+02	3.25390E-03	4.83880E-01	1.57450E-03	3.87310E-03
7.82320E+02	3.40350E-03	4.83970E-01	1.64720E-03	4.05180E-03
7.82420E+02	3.56040E-03	4.84070E-01	1.72350E-03	4.23950E-03
7.82520E+02	3.71860E-03	4.84160E-01	1.80040E-03	4.42860E-03
7.82620E+02	3.87230E-03	4.84250E-01	1.87510E-03	4.61260E-03
7.82720E+02	4.01740E-03	4.84340E-01	1.94580E-03	4.78640E-03
7.82820E+02	4.15220E-03	4.84430E-01	2.01140E-03	4.94780E-03
7.82920E+02	4.27730E-03	4.84520E-01	2.07250E-03	5.09800E-03
7.83020E+02	4.39610E-03	4.84610E-01	2.13040E-03	5.24050E-03

7.83120E+02	4.51330E-03	4.84710E-01	2.18760E-03	5.38120E-03
7.83220E+02	4.63480E-03	4.84780E-01	2.24690E-03	5.52690E-03
7.83320E+02	4.76610E-03	4.84840E-01	2.31080E-03	5.68420E-03
7.83420E+02	4.91150E-03	4.84900E-01	2.38160E-03	5.85840E-03
7.83520E+02	5.07320E-03	4.84960E-01	2.46030E-03	6.05200E-03
7.83620E+02	5.25070E-03	4.85030E-01	2.54670E-03	6.26460E-03
7.83720E+02	5.44120E-03	4.85090E-01	2.63950E-03	6.49270E-03
7.83820E+02	5.63960E-03	4.85150E-01	2.73610E-03	6.73030E-03
7.83920E+02	5.83960E-03	4.85210E-01	2.83350E-03	6.96990E-03
7.84020E+02	6.03480E-03	4.85310E-01	2.92870E-03	7.20430E-03
7.84120E+02	6.22010E-03	4.85540E-01	3.02010E-03	7.42910E-03
7.84220E+02	6.39270E-03	4.85780E-01	3.10540E-03	7.63890E-03
7.84320E+02	6.55290E-03	4.86010E-01	3.18480E-03	7.83410E-03
7.84420E+02	6.70410E-03	4.86250E-01	3.25990E-03	8.01880E-03
7.84520E+02	6.85270E-03	4.86480E-01	3.33370E-03	8.20040E-03
7.84620E+02	7.00680E-03	4.86720E-01	3.41030E-03	8.38880E-03
7.84720E+02	7.17550E-03	4.86950E-01	3.49410E-03	8.59500E-03
7.84820E+02	7.36730E-03	4.87190E-01	3.58920E-03	8.82900E-03
7.84920E+02	7.58860E-03	4.87420E-01	3.69880E-03	9.09850E-03
7.85020E+02	7.84280E-03	4.87650E-01	3.82460E-03	9.40790E-03
7.85120E+02	8.13000E-03	4.87880E-01	3.96650E-03	9.75690E-03
7.85220E+02	8.44680E-03	4.88100E-01	4.12290E-03	1.01420E-02
7.85320E+02	8.78700E-03	4.88310E-01	4.29080E-03	1.05550E-02
7.85420E+02	9.14290E-03	4.88530E-01	4.46660E-03	1.09870E-02
7.85520E+02	9.50670E-03	4.88750E-01	4.64640E-03	1.14290E-02
7.85620E+02	9.87240E-03	4.88960E-01	4.82730E-03	1.18740E-02
7.85720E+02	1.02370E-02	4.89180E-01	5.00770E-03	1.23180E-02
7.85820E+02	1.06010E-02	4.89400E-01	5.18810E-03	1.27620E-02
7.85920E+02	1.09700E-02	4.89610E-01	5.37110E-03	1.32120E-02
7.86020E+02	1.13530E-02	4.89820E-01	5.56100E-03	1.36790E-02
7.86120E+02	1.17620E-02	4.89950E-01	5.76300E-03	1.41760E-02
7.86220E+02	1.22110E-02	4.90090E-01	5.98450E-03	1.47210E-02
7.86320E+02	1.27130E-02	4.90230E-01	6.23200E-03	1.53300E-02
7.86420E+02	1.32780E-02	4.90370E-01	6.51110E-03	1.60160E-02
7.86520E+02	1.39150E-02	4.90510E-01	6.82520E-03	1.67890E-02
7.86620E+02	1.46260E-02	4.90650E-01	7.17610E-03	1.76520E-02
7.86720E+02	1.54100E-02	4.90780E-01	7.56290E-03	1.86040E-02
7.86820E+02	1.62610E-02	4.90920E-01	7.98270E-03	1.96360E-02
7.86920E+02	1.71690E-02	4.91060E-01	8.43100E-03	2.07390E-02
7.87020E+02	1.81240E-02	4.91200E-01	8.90260E-03	2.18990E-02
7.87120E+02	1.91160E-02	4.91320E-01	9.39220E-03	2.31030E-02
7.87220E+02	2.01360E-02	4.91430E-01	9.89580E-03	2.43420E-02
7.87320E+02	2.11800E-02	4.91550E-01	1.04110E-02	2.56100E-02

7.87420E+02	2.22460E-02	4.91670E-01	1.09380E-02	2.69050E-02
7.87520E+02	2.33380E-02	4.91790E-01	1.14770E-02	2.82320E-02
7.87620E+02	2.44630E-02	4.91910E-01	1.20340E-02	2.96010E-02
7.87720E+02	2.56320E-02	4.92020E-01	1.26120E-02	3.10230E-02
7.87820E+02	2.68560E-02	4.92140E-01	1.32170E-02	3.25120E-02
7.87920E+02	2.81450E-02	4.92260E-01	1.38550E-02	3.40810E-02
7.88020E+02	2.95100E-02	4.92390E-01	1.45300E-02	3.57420E-02
7.88120E+02	3.09550E-02	4.92540E-01	1.52470E-02	3.75050E-02
7.88220E+02	3.24850E-02	4.92700E-01	1.60060E-02	3.93710E-02
7.88320E+02	3.41000E-02	4.92860E-01	1.68060E-02	4.13410E-02
7.88420E+02	3.57970E-02	4.93020E-01	1.76480E-02	4.34130E-02
7.88520E+02	3.75730E-02	4.93170E-01	1.85300E-02	4.55820E-02
7.88620E+02	3.94270E-02	4.93330E-01	1.94510E-02	4.78460E-02
7.88720E+02	4.13580E-02	4.93490E-01	2.04100E-02	5.02050E-02
7.88820E+02	4.33690E-02	4.93650E-01	2.14090E-02	5.26630E-02
7.88920E+02	4.54670E-02	4.93810E-01	2.24520E-02	5.52280E-02
7.89020E+02	4.76640E-02	4.93930E-01	2.35430E-02	5.79120E-02
7.89120E+02	4.99730E-02	4.94050E-01	2.46900E-02	6.07330E-02
7.89220E+02	5.24140E-02	4.94170E-01	2.59020E-02	6.37140E-02
7.89320E+02	5.19660E-02	4.94290E-01	2.56870E-02	6.31850E-02
7.89420E+02	5.48250E-02	4.94410E-01	2.71060E-02	6.66760E-02
7.89520E+02	5.78100E-02	4.94530E-01	2.85890E-02	7.03240E-02
7.89620E+02	6.09070E-02	4.94650E-01	3.01280E-02	7.41090E-02
7.89720E+02	6.41140E-02	4.94770E-01	3.17210E-02	7.80300E-02
7.89820E+02	6.74420E-02	4.94890E-01	3.33760E-02	8.21000E-02
7.89920E+02	7.09160E-02	4.95010E-01	3.51040E-02	8.63510E-02
7.90020E+02	7.45710E-02	4.95120E-01	3.69220E-02	9.08220E-02
7.90120E+02	7.84460E-02	4.95210E-01	3.88470E-02	9.55580E-02
7.90220E+02	8.25780E-02	4.95300E-01	4.09010E-02	1.00610E-01
7.90320E+02	8.70020E-02	4.95390E-01	4.31000E-02	1.06020E-01
7.90420E+02	9.17430E-02	4.95480E-01	4.54570E-02	1.11820E-01
7.90520E+02	9.68190E-02	4.95560E-01	4.79800E-02	1.18020E-01
7.90620E+02	1.02240E-01	4.95650E-01	5.06740E-02	1.24650E-01
7.90720E+02	1.08000E-01	4.95740E-01	5.35400E-02	1.31700E-01
7.90820E+02	1.14100E-01	4.95830E-01	5.65760E-02	1.39170E-01
7.90920E+02	1.20550E-01	4.95910E-01	5.97810E-02	1.47050E-01
7.91020E+02	1.27340E-01	4.95990E-01	6.31570E-02	1.55360E-01
7.91120E+02	1.34470E-01	4.96060E-01	6.67070E-02	1.64090E-01
7.91220E+02	1.41980E-01	4.96140E-01	7.04390E-02	1.73270E-01
7.91320E+02	1.49860E-01	4.96210E-01	7.43620E-02	1.82920E-01
7.91420E+02	1.58150E-01	4.96290E-01	7.84890E-02	1.93070E-01
7.91520E+02	1.66880E-01	4.96360E-01	8.28310E-02	2.03750E-01
7.91620E+02	1.76050E-01	4.96440E-01	8.73990E-02	2.14990E-01

7.91720E+02	1.85700E-01	4.96510E-01	9.22000E-02	2.26800E-01
7.91820E+02	1.95820E-01	4.96590E-01	9.72400E-02	2.39200E-01
7.91920E+02	2.06420E-01	4.96660E-01	1.02520E-01	2.52180E-01
7.92020E+02	2.17490E-01	4.96710E-01	1.08030E-01	2.65740E-01
7.92120E+02	2.29020E-01	4.96700E-01	1.13750E-01	2.79820E-01
7.92220E+02	2.41000E-01	4.96690E-01	1.19700E-01	2.94450E-01
7.92320E+02	2.53410E-01	4.96670E-01	1.25860E-01	3.09600E-01
7.92420E+02	2.66240E-01	4.96660E-01	1.32230E-01	3.25260E-01
7.92520E+02	2.79470E-01	4.96640E-01	1.38790E-01	3.41410E-01
7.92620E+02	2.93090E-01	4.96630E-01	1.45560E-01	3.58050E-01
7.92720E+02	3.07090E-01	4.96610E-01	1.52510E-01	3.75140E-01
7.92820E+02	3.21460E-01	4.96600E-01	1.59640E-01	3.92690E-01
7.92920E+02	3.36170E-01	4.96600E-01	1.66940E-01	4.10650E-01
7.93020E+02	3.51180E-01	4.96600E-01	1.74400E-01	4.28990E-01
7.93120E+02	3.66460E-01	4.96600E-01	1.81980E-01	4.47650E-01
7.93220E+02	3.81940E-01	4.96590E-01	1.89670E-01	4.66550E-01
7.93320E+02	3.97560E-01	4.96590E-01	1.97420E-01	4.85630E-01
7.93420E+02	4.13240E-01	4.96590E-01	2.05210E-01	5.04780E-01
7.93520E+02	4.28910E-01	4.96580E-01	2.12990E-01	5.23930E-01
7.93620E+02	4.44520E-01	4.96580E-01	2.20740E-01	5.42980E-01
7.93720E+02	4.59990E-01	4.96570E-01	2.28420E-01	5.61870E-01
7.93820E+02	4.75300E-01	4.96570E-01	2.36020E-01	5.80560E-01
7.93920E+02	4.90410E-01	4.96560E-01	2.43520E-01	5.99020E-01
7.94020E+02	5.05320E-01	4.96570E-01	2.50930E-01	6.17250E-01
7.94120E+02	5.20050E-01	4.96640E-01	2.58280E-01	6.35330E-01
7.94220E+02	5.34600E-01	4.96710E-01	2.65540E-01	6.53200E-01
7.94320E+02	5.49000E-01	4.96780E-01	2.72730E-01	6.70870E-01
7.94420E+02	5.63230E-01	4.96850E-01	2.79840E-01	6.88370E-01
7.94520E+02	5.77310E-01	4.96910E-01	2.86870E-01	7.05660E-01
7.94620E+02	5.91190E-01	4.96980E-01	2.93810E-01	7.22720E-01
7.94720E+02	6.04810E-01	4.97050E-01	3.00620E-01	7.39480E-01
7.94820E+02	6.18120E-01	4.97110E-01	3.07280E-01	7.55850E-01
7.94920E+02	6.31010E-01	4.97180E-01	3.13730E-01	7.71720E-01
7.95020E+02	6.43390E-01	4.97250E-01	3.19920E-01	7.86970E-01
7.95120E+02	6.55170E-01	4.97310E-01	3.25820E-01	8.01470E-01
7.95220E+02	6.66280E-01	4.97360E-01	3.31380E-01	8.15150E-01
7.95320E+02	6.76650E-01	4.97420E-01	3.36580E-01	8.27940E-01
7.95420E+02	6.86280E-01	4.97480E-01	3.41410E-01	8.39810E-01
7.95520E+02	6.95170E-01	4.97540E-01	3.45870E-01	8.50800E-01
7.95620E+02	7.03380E-01	4.97590E-01	3.50000E-01	8.60950E-01
7.95720E+02	7.10990E-01	4.97650E-01	3.53820E-01	8.70360E-01
7.95820E+02	7.18080E-01	4.97710E-01	3.57400E-01	8.79140E-01
7.95920E+02	7.24770E-01	4.97770E-01	3.60760E-01	8.87420E-01

7.96020E+02	7.31130E-01	4.97810E-01	3.63960E-01	8.95300E-01
7.96120E+02	7.37260E-01	4.97790E-01	3.67000E-01	9.02770E-01
7.96220E+02	7.43210E-01	4.97770E-01	3.69940E-01	9.10000E-01
7.96320E+02	7.48980E-01	4.97750E-01	3.72800E-01	9.17040E-01
7.96420E+02	7.54580E-01	4.97720E-01	3.75570E-01	9.23860E-01
7.96520E+02	7.59970E-01	4.97700E-01	3.78240E-01	9.30410E-01
7.96620E+02	7.65090E-01	4.97680E-01	3.80770E-01	9.36640E-01
7.96720E+02	7.69880E-01	4.97660E-01	3.83140E-01	9.42480E-01
7.96820E+02	7.74290E-01	4.97650E-01	3.85330E-01	9.47840E-01
7.96920E+02	7.78270E-01	4.97640E-01	3.87300E-01	9.52690E-01
7.97020E+02	7.81810E-01	4.97620E-01	3.89040E-01	9.56990E-01
7.97120E+02	7.84910E-01	4.97600E-01	3.90570E-01	9.60750E-01
7.97220E+02	7.87620E-01	4.97580E-01	3.91900E-01	9.64020E-01
7.97320E+02	7.89990E-01	4.97560E-01	3.93060E-01	9.66870E-01
7.97420E+02	7.92090E-01	4.97530E-01	3.94090E-01	9.69410E-01
7.97520E+02	7.94020E-01	4.97510E-01	3.95040E-01	9.71730E-01
7.97620E+02	7.95860E-01	4.97490E-01	3.95930E-01	9.73930E-01
7.97720E+02	7.97650E-01	4.97470E-01	3.96810E-01	9.76090E-01
7.97820E+02	7.99460E-01	4.97450E-01	3.97690E-01	9.78250E-01
7.97920E+02	8.01290E-01	4.97420E-01	3.98580E-01	9.80450E-01
7.98020E+02	8.03140E-01	4.97410E-01	3.99490E-01	9.82690E-01
7.98120E+02	8.04970E-01	4.97480E-01	4.00460E-01	9.85060E-01
7.98220E+02	8.06750E-01	4.97540E-01	4.01390E-01	9.87360E-01
7.98320E+02	8.08410E-01	4.97600E-01	4.02270E-01	9.89520E-01
7.98420E+02	8.09900E-01	4.97670E-01	4.03060E-01	9.91470E-01
7.98520E+02	8.11200E-01	4.97730E-01	4.03760E-01	9.93180E-01
7.98620E+02	8.12260E-01	4.97790E-01	4.04340E-01	9.94610E-01
7.98720E+02	8.13090E-01	4.97860E-01	4.04800E-01	9.95750E-01
7.98820E+02	8.13700E-01	4.97920E-01	4.05160E-01	9.96620E-01
7.98920E+02	8.14120E-01	4.97980E-01	4.05420E-01	9.97260E-01
7.99020E+02	8.14400E-01	4.98040E-01	4.05610E-01	9.97730E-01
7.99120E+02	8.14580E-01	4.98100E-01	4.05750E-01	9.98070E-01
7.99220E+02	8.14710E-01	4.98170E-01	4.05860E-01	9.98360E-01
7.99320E+02	8.14820E-01	4.98230E-01	4.05970E-01	9.98620E-01
7.99420E+02	8.14940E-01	4.98290E-01	4.06080E-01	9.98890E-01
7.99520E+02	8.15070E-01	4.98350E-01	4.06190E-01	9.99170E-01
7.99620E+02	8.15200E-01	4.98410E-01	4.06310E-01	9.99460E-01
7.99720E+02	8.15310E-01	4.98470E-01	4.06410E-01	9.99720E-01
7.99820E+02	8.15370E-01	4.98540E-01	4.06490E-01	9.99910E-01
7.99920E+02	8.15340E-01	4.98600E-01	4.06530E-01	1.00000E+00
8.00020E+02	8.15190E-01	4.98660E-01	4.06500E-01	9.99930E-01
8.00120E+02	8.14880E-01	4.98710E-01	4.06380E-01	9.99650E-01
8.00220E+02	8.14400E-01	4.98750E-01	4.06180E-01	9.99150E-01

8.00320E+02	8.13750E-01	4.98800E-01	4.05900E-01	9.98440E-01
8.00420E+02	8.12920E-01	4.98840E-01	4.05520E-01	9.97520E-01
8.00520E+02	8.11930E-01	4.98890E-01	4.05070E-01	9.96400E-01
8.00620E+02	8.10810E-01	4.98940E-01	4.04540E-01	9.95120E-01
8.00720E+02	8.09560E-01	4.98990E-01	4.03960E-01	9.93690E-01
8.00820E+02	8.08230E-01	4.99040E-01	4.03340E-01	9.92160E-01
8.00920E+02	8.06830E-01	4.99090E-01	4.02680E-01	9.90530E-01
8.01020E+02	8.05380E-01	4.99140E-01	4.02000E-01	9.88850E-01
8.01120E+02	8.03890E-01	4.99190E-01	4.01290E-01	9.87120E-01
8.01220E+02	8.02370E-01	4.99240E-01	4.00570E-01	9.85350E-01
8.01320E+02	8.00840E-01	4.99290E-01	3.99850E-01	9.83570E-01
8.01420E+02	7.99280E-01	4.99340E-01	3.99110E-01	9.81760E-01
8.01520E+02	7.97720E-01	4.99390E-01	3.98370E-01	9.79940E-01
8.01620E+02	7.96160E-01	4.99440E-01	3.97630E-01	9.78110E-01
8.01720E+02	7.94600E-01	4.99490E-01	3.96890E-01	9.76290E-01
8.01820E+02	7.93050E-01	4.99540E-01	3.96160E-01	9.74490E-01
8.01920E+02	7.91530E-01	4.99590E-01	3.95440E-01	9.72720E-01
8.02020E+02	7.90040E-01	4.99640E-01	3.94730E-01	9.70990E-01
8.02120E+02	7.88600E-01	4.99680E-01	3.94050E-01	9.69290E-01
8.02220E+02	7.87210E-01	4.99720E-01	3.93380E-01	9.67660E-01
8.02320E+02	7.85870E-01	4.99760E-01	3.92750E-01	9.66100E-01
8.02420E+02	7.84590E-01	4.99800E-01	3.92140E-01	9.64600E-01
8.02520E+02	7.83350E-01	4.99820E-01	3.91530E-01	9.63110E-01
8.02620E+02	7.82160E-01	4.99830E-01	3.90950E-01	9.61680E-01
8.02720E+02	7.81010E-01	4.99850E-01	3.90380E-01	9.60280E-01
8.02820E+02	7.79890E-01	4.99860E-01	3.89830E-01	9.58930E-01
8.02920E+02	7.78800E-01	4.99870E-01	3.89300E-01	9.57620E-01
8.03020E+02	7.77750E-01	4.99890E-01	3.88790E-01	9.56360E-01
8.03120E+02	7.76760E-01	4.99890E-01	3.88290E-01	9.55140E-01
8.03220E+02	7.75820E-01	4.99900E-01	3.87830E-01	9.54000E-01
8.03320E+02	7.74960E-01	4.99900E-01	3.87410E-01	9.52960E-01
8.03420E+02	7.74210E-01	4.99910E-01	3.87030E-01	9.52050E-01
8.03520E+02	7.73570E-01	4.99910E-01	3.86720E-01	9.51270E-01
8.03620E+02	7.73070E-01	4.99920E-01	3.86470E-01	9.50670E-01
8.03720E+02	7.72710E-01	4.99930E-01	3.86300E-01	9.50240E-01
8.03820E+02	7.72500E-01	4.99930E-01	3.86200E-01	9.49990E-01
8.03920E+02	7.72420E-01	4.99940E-01	3.86170E-01	9.49910E-01
8.04020E+02	7.72470E-01	4.99940E-01	3.86190E-01	9.49970E-01
8.04120E+02	7.72620E-01	4.99900E-01	3.86230E-01	9.50070E-01
8.04220E+02	7.72810E-01	4.99860E-01	3.86300E-01	9.50240E-01
8.04320E+02	7.73020E-01	4.99830E-01	3.86380E-01	9.50430E-01
8.04420E+02	7.73180E-01	4.99780E-01	3.86420E-01	9.50540E-01
8.04520E+02	7.73250E-01	4.99730E-01	3.86420E-01	9.50530E-01

8.04620E+02	7.73150E-01	4.99680E-01	3.86330E-01	9.50310E-01
8.04720E+02	7.72840E-01	4.99630E-01	3.86130E-01	9.49830E-01
8.04820E+02	7.72240E-01	4.99580E-01	3.85800E-01	9.49000E-01
8.04920E+02	7.71300E-01	4.99530E-01	3.85290E-01	9.47750E-01
8.05020E+02	7.69970E-01	4.99480E-01	3.84590E-01	9.46020E-01
8.05120E+02	7.68190E-01	4.99430E-01	3.83660E-01	9.43740E-01
8.05220E+02	7.65930E-01	4.99380E-01	3.82490E-01	9.40860E-01
8.05320E+02	7.63130E-01	4.99330E-01	3.81050E-01	9.37330E-01
8.05420E+02	7.59760E-01	4.99280E-01	3.79330E-01	9.33100E-01
8.05520E+02	7.55790E-01	4.99230E-01	3.77310E-01	9.28130E-01
8.05620E+02	7.51180E-01	4.99180E-01	3.74970E-01	9.22380E-01
8.05720E+02	7.45920E-01	4.99130E-01	3.72310E-01	9.15820E-01
8.05820E+02	7.39970E-01	4.99080E-01	3.69300E-01	9.08430E-01
8.05920E+02	7.33310E-01	4.99030E-01	3.65940E-01	9.00160E-01
8.06020E+02	7.25920E-01	4.98970E-01	3.62210E-01	8.90980E-01
8.06120E+02	7.17770E-01	4.98860E-01	3.58070E-01	8.80790E-01
8.06220E+02	7.08840E-01	4.98750E-01	3.53540E-01	8.69650E-01
8.06320E+02	6.99130E-01	4.98640E-01	3.48620E-01	8.57540E-01
8.06420E+02	6.88610E-01	4.98540E-01	3.43300E-01	8.44460E-01
8.06520E+02	6.77280E-01	4.98430E-01	3.37580E-01	8.30390E-01
8.06620E+02	6.65140E-01	4.98330E-01	3.31460E-01	8.15330E-01
8.06720E+02	6.52200E-01	4.98220E-01	3.24940E-01	7.99300E-01
8.06820E+02	6.38490E-01	4.98110E-01	3.18040E-01	7.82330E-01
8.06920E+02	6.24040E-01	4.98010E-01	3.10780E-01	7.64460E-01
8.07020E+02	6.08880E-01	4.97910E-01	3.03170E-01	7.45750E-01
8.07120E+02	5.93100E-01	4.97810E-01	2.95250E-01	7.26260E-01
8.07220E+02	5.76740E-01	4.97710E-01	2.87050E-01	7.06090E-01
8.07320E+02	5.59880E-01	4.97610E-01	2.78600E-01	6.85310E-01
8.07420E+02	5.42590E-01	4.97510E-01	2.69940E-01	6.64020E-01
8.07520E+02	5.24970E-01	4.97410E-01	2.61130E-01	6.42330E-01
8.07620E+02	5.07090E-01	4.97310E-01	2.52180E-01	6.20330E-01
8.07720E+02	4.89030E-01	4.97210E-01	2.43150E-01	5.98110E-01
8.07820E+02	4.70860E-01	4.97110E-01	2.34070E-01	5.75780E-01
8.07920E+02	4.52670E-01	4.97010E-01	2.24980E-01	5.53420E-01
8.08020E+02	4.34510E-01	4.96930E-01	2.15920E-01	5.31130E-01
8.08120E+02	4.16450E-01	4.96910E-01	2.06940E-01	5.09040E-01
8.08220E+02	3.98570E-01	4.96890E-01	1.98040E-01	4.87160E-01
8.08320E+02	3.80910E-01	4.96860E-01	1.89260E-01	4.65550E-01
8.08420E+02	3.63530E-01	4.96840E-01	1.80620E-01	4.44290E-01
8.08520E+02	3.46490E-01	4.96810E-01	1.72140E-01	4.23440E-01
8.08620E+02	3.29840E-01	4.96780E-01	1.63860E-01	4.03060E-01
8.08720E+02	3.13610E-01	4.96750E-01	1.55790E-01	3.83220E-01
8.08820E+02	2.97860E-01	4.96730E-01	1.47960E-01	3.63950E-01

8.08920E+02	2.82610E-01	4.96700E-01	1.40370E-01	3.45290E-01
8.09020E+02	2.67870E-01	4.96680E-01	1.33050E-01	3.27270E-01
8.09120E+02	2.53670E-01	4.96650E-01	1.25990E-01	3.09910E-01
8.09220E+02	2.40000E-01	4.96630E-01	1.19190E-01	2.93200E-01
8.09320E+02	2.26870E-01	4.96610E-01	1.12670E-01	2.77150E-01
8.09420E+02	2.14280E-01	4.96590E-01	1.06410E-01	2.61740E-01
8.09520E+02	2.02200E-01	4.96570E-01	1.00400E-01	2.46980E-01
8.09620E+02	1.90630E-01	4.96550E-01	9.46590E-02	2.32850E-01
8.09720E+02	1.79580E-01	4.96530E-01	8.91680E-02	2.19340E-01
8.09820E+02	1.69040E-01	4.96510E-01	8.39300E-02	2.06450E-01
8.09920E+02	1.59010E-01	4.96490E-01	7.89490E-02	1.94200E-01
8.10020E+02	1.49510E-01	4.96480E-01	7.42280E-02	1.82590E-01
8.10120E+02	1.40540E-01	4.96480E-01	6.97740E-02	1.71630E-01
8.10220E+02	1.32100E-01	4.96480E-01	6.55870E-02	1.61330E-01
8.10320E+02	1.24210E-01	4.96480E-01	6.16680E-02	1.51690E-01
8.10420E+02	1.16860E-01	4.96480E-01	5.80160E-02	1.42710E-01
8.10520E+02	1.10020E-01	4.96480E-01	5.46230E-02	1.34360E-01
8.10620E+02	1.03680E-01	4.96470E-01	5.14750E-02	1.26620E-01
8.10720E+02	9.78000E-02	4.96470E-01	4.85550E-02	1.19440E-01
8.10820E+02	9.23300E-02	4.96470E-01	4.58390E-02	1.12760E-01
8.10920E+02	8.72190E-02	4.96470E-01	4.33020E-02	1.06520E-01
8.11020E+02	8.24150E-02	4.96470E-01	4.09170E-02	1.00650E-01
8.11120E+02	7.78670E-02	4.96480E-01	3.86590E-02	9.50970E-02
8.11220E+02	7.35330E-02	4.96480E-01	3.65080E-02	8.98040E-02
8.11320E+02	6.93810E-02	4.96490E-01	3.44470E-02	8.47350E-02
8.11420E+02	6.53940E-02	4.96500E-01	3.24680E-02	7.98660E-02
8.11520E+02	6.15680E-02	4.96500E-01	3.05680E-02	7.51940E-02
8.11620E+02	5.79090E-02	4.96510E-01	2.87520E-02	7.07260E-02
8.11720E+02	5.44330E-02	4.96510E-01	2.70270E-02	6.64820E-02
8.11820E+02	5.11620E-02	4.96520E-01	2.54030E-02	6.24880E-02
8.11920E+02	4.81150E-02	4.96520E-01	2.38900E-02	5.87660E-02
8.12020E+02	4.62480E-02	4.96530E-01	2.29640E-02	5.64870E-02
8.12120E+02	4.43050E-02	4.96550E-01	2.20000E-02	5.41160E-02
8.12220E+02	4.23720E-02	4.96560E-01	2.10400E-02	5.17560E-02
8.12320E+02	4.02350E-02	4.96580E-01	1.99800E-02	4.91480E-02
8.12420E+02	3.89340E-02	4.96590E-01	1.93340E-02	4.75590E-02
8.12520E+02	3.67660E-02	4.96600E-01	1.82580E-02	4.49120E-02
8.12620E+02	3.47280E-02	4.96620E-01	1.72470E-02	4.24240E-02
8.12720E+02	3.28210E-02	4.96630E-01	1.63000E-02	4.00950E-02
8.12820E+02	3.10410E-02	4.96650E-01	1.54160E-02	3.79220E-02
8.12920E+02	2.93840E-02	4.96660E-01	1.45940E-02	3.58990E-02
8.13020E+02	2.78450E-02	4.96680E-01	1.38300E-02	3.40190E-02
8.13120E+02	2.64130E-02	4.96700E-01	1.31190E-02	3.22710E-02

8.13220E+02	2.50770E-02	4.96710E-01	1.24560E-02	3.06410E-02
8.13320E+02	2.38270E-02	4.96730E-01	1.18360E-02	2.91140E-02
8.13420E+02	2.26490E-02	4.96750E-01	1.12510E-02	2.76760E-02
8.13520E+02	2.15310E-02	4.96770E-01	1.06960E-02	2.63110E-02
8.13620E+02	2.04650E-02	4.96790E-01	1.01670E-02	2.50090E-02
8.13720E+02	1.94420E-02	4.96810E-01	9.65870E-03	2.37590E-02
8.13820E+02	1.84570E-02	4.96830E-01	9.17010E-03	2.25570E-02
8.13920E+02	1.75110E-02	4.96840E-01	8.70040E-03	2.14020E-02
8.14020E+02	1.66050E-02	4.96860E-01	8.25020E-03	2.02940E-02
8.14120E+02	1.57420E-02	4.96840E-01	7.82140E-03	1.92390E-02
8.14220E+02	1.49290E-02	4.96820E-01	7.41690E-03	1.82440E-02
8.14320E+02	1.41690E-02	4.96810E-01	7.03930E-03	1.73160E-02
8.14420E+02	1.34680E-02	4.96790E-01	6.69060E-03	1.64580E-02
8.14520E+02	1.28270E-02	4.96780E-01	6.37200E-03	1.56740E-02
8.14620E+02	1.22460E-02	4.96760E-01	6.08330E-03	1.49640E-02
8.14720E+02	1.17220E-02	4.96740E-01	5.82280E-03	1.43230E-02
8.14820E+02	1.12490E-02	4.96730E-01	5.58750E-03	1.37450E-02
8.14920E+02	1.08180E-02	4.96710E-01	5.37350E-03	1.32180E-02
8.15020E+02	1.04210E-02	4.96700E-01	5.17600E-03	1.27320E-02
8.15120E+02	1.00460E-02	4.96690E-01	4.99000E-03	1.22750E-02
8.15220E+02	9.68590E-03	4.96680E-01	4.81080E-03	1.18340E-02
8.15320E+02	9.33130E-03	4.96670E-01	4.63450E-03	1.14000E-02
8.15420E+02	8.97730E-03	4.96660E-01	4.45860E-03	1.09680E-02
8.15520E+02	8.62140E-03	4.96650E-01	4.28180E-03	1.05330E-02
8.15620E+02	8.26410E-03	4.96630E-01	4.10430E-03	1.00960E-02
8.15720E+02	7.90870E-03	4.96620E-01	3.92770E-03	9.66140E-03
8.15820E+02	7.56030E-03	4.96610E-01	3.75450E-03	9.23560E-03
8.15920E+02	7.22540E-03	4.96600E-01	3.58810E-03	8.82630E-03
8.16020E+02	6.91070E-03	4.96590E-01	3.43180E-03	8.44170E-03
8.16120E+02	6.62250E-03	4.96600E-01	3.28880E-03	8.08990E-03
8.16220E+02	6.36560E-03	4.96620E-01	3.16120E-03	7.77620E-03
8.16320E+02	6.14230E-03	4.96630E-01	3.05040E-03	7.50360E-03
8.16420E+02	5.95270E-03	4.96640E-01	2.95630E-03	7.27210E-03
8.16520E+02	5.79390E-03	4.96650E-01	2.87760E-03	7.07840E-03
8.16620E+02	5.66090E-03	4.96670E-01	2.81160E-03	6.91610E-03
8.16720E+02	5.54670E-03	4.96680E-01	2.75490E-03	6.77680E-03
8.16820E+02	5.44330E-03	4.96690E-01	2.70360E-03	6.65050E-03
8.16920E+02	5.34230E-03	4.96700E-01	2.65350E-03	6.52730E-03
8.17020E+02	5.23630E-03	4.96710E-01	2.60100E-03	6.39800E-03
8.17120E+02	5.11930E-03	4.96730E-01	2.54290E-03	6.25520E-03
8.17220E+02	4.98740E-03	4.96740E-01	2.47740E-03	6.09410E-03
8.17320E+02	4.83890E-03	4.96750E-01	2.40380E-03	5.91290E-03
8.17420E+02	4.67480E-03	4.96770E-01	2.32230E-03	5.71250E-03

8.17520E+02	4.49820E-03	4.96780E-01	2.23460E-03	5.49690E-03
8.17620E+02	4.31380E-03	4.96790E-01	2.14310E-03	5.27170E-03
8.17720E+02	4.12740E-03	4.96810E-01	2.05050E-03	5.04400E-03
8.17820E+02	3.94500E-03	4.96820E-01	1.95990E-03	4.82120E-03
8.17920E+02	3.77210E-03	4.96830E-01	1.87410E-03	4.61000E-03
8.18020E+02	3.61280E-03	4.96820E-01	1.79490E-03	4.41520E-03
8.18120E+02	3.46640E-03	4.96740E-01	1.72190E-03	4.23560E-03
8.18220E+02	3.33020E-03	4.96650E-01	1.65400E-03	4.06850E-03
8.18320E+02	3.20270E-03	4.96570E-01	1.59040E-03	3.91200E-03
8.18420E+02	3.08000E-03	4.96490E-01	1.52920E-03	3.76150E-03
8.18520E+02	2.95680E-03	4.96400E-01	1.46780E-03	3.61050E-03
8.18620E+02	2.82800E-03	4.96320E-01	1.40360E-03	3.45260E-03
8.18720E+02	2.68890E-03	4.96240E-01	1.33430E-03	3.28230E-03
8.18820E+02	2.53710E-03	4.96150E-01	1.25880E-03	3.09650E-03
8.18920E+02	2.37260E-03	4.96070E-01	1.17700E-03	2.89510E-03
8.19020E+02	2.19800E-03	4.95980E-01	1.09020E-03	2.68170E-03
8.19120E+02	2.01910E-03	4.95900E-01	1.00130E-03	2.46290E-03
8.19220E+02	1.84350E-03	4.95810E-01	9.14040E-04	2.24840E-03
8.19320E+02	1.68060E-03	4.95730E-01	8.33100E-04	2.04930E-03
8.19420E+02	1.53950E-03	4.95650E-01	7.63070E-04	1.87700E-03
8.19520E+02	1.42890E-03	4.95560E-01	7.08120E-04	1.74190E-03
8.19620E+02	1.35510E-03	4.95480E-01	6.71440E-04	1.65160E-03
8.19720E+02	1.32180E-03	4.95400E-01	6.54820E-04	1.61080E-03
8.19820E+02	1.32930E-03	4.95310E-01	6.58400E-04	1.61960E-03
8.19920E+02	1.37400E-03	4.95240E-01	6.80480E-04	1.67390E-03
8.20020E+02	1.44910E-03	4.95190E-01	7.17550E-04	1.76510E-03
8.20120E+02	1.54480E-03	4.95170E-01	7.64930E-04	1.88160E-03
8.20220E+02	1.65270E-03	4.95160E-01	8.18370E-04	2.01310E-03
8.20320E+02	1.76420E-03	4.95150E-01	8.73560E-04	2.14880E-03
8.20420E+02	1.86820E-03	4.95140E-01	9.25030E-04	2.27540E-03
8.20520E+02	1.95650E-03	4.95130E-01	9.68710E-04	2.38290E-03
8.20620E+02	2.02420E-03	4.95110E-01	1.00220E-03	2.46530E-03
8.20720E+02	2.06960E-03	4.95100E-01	1.02470E-03	2.52060E-03
8.20820E+02	2.09400E-03	4.95090E-01	1.03670E-03	2.55020E-03
8.20920E+02	2.10040E-03	4.95080E-01	1.03990E-03	2.55800E-03
8.21020E+02	2.09340E-03	4.95070E-01	1.03640E-03	2.54940E-03
8.21120E+02	2.07780E-03	4.95060E-01	1.02860E-03	2.53020E-03
8.21220E+02	2.05760E-03	4.95050E-01	1.01860E-03	2.50560E-03
8.21320E+02	2.03560E-03	4.95040E-01	1.00770E-03	2.47880E-03
8.21420E+02	2.01280E-03	4.95030E-01	9.96400E-04	2.45100E-03
8.21520E+02	1.98830E-03	4.95020E-01	9.84230E-04	2.42110E-03
8.21620E+02	1.95910E-03	4.95010E-01	9.69780E-04	2.38550E-03
8.21720E+02	1.92130E-03	4.95000E-01	9.51040E-04	2.33940E-03

8.21820E+02	1.87030E-03	4.95000E-01	9.25810E-04	2.27740E-03
8.21920E+02	1.80230E-03	4.94990E-01	8.92140E-04	2.19450E-03
8.22020E+02	1.71650E-03	4.95000E-01	8.49690E-04	2.09010E-03
8.22120E+02	1.80370E-03	4.95020E-01	8.92880E-04	2.19630E-03
8.22220E+02	1.60900E-03	4.95050E-01	7.96520E-04	1.95930E-03
8.22320E+02	1.42370E-03	4.95070E-01	7.04840E-04	1.73380E-03
8.22420E+02	1.24450E-03	4.95090E-01	6.16150E-04	1.51560E-03
8.22520E+02	1.06330E-03	4.95120E-01	5.26440E-04	1.29500E-03
8.22620E+02	8.70730E-04	4.95140E-01	4.31130E-04	1.06050E-03
8.22720E+02	6.61340E-04	4.95160E-01	3.27470E-04	8.05520E-04
8.22820E+02	4.36900E-04	4.95180E-01	2.16340E-04	5.32180E-04
8.22920E+02	2.08630E-04	4.95210E-01	1.03310E-04	2.54140E-04
8.23020E+02	2.76110E-05	4.95230E-01	1.36740E-05	3.36350E-05
8.23120E+02	0.00000E+00	4.95250E-01	0.00000E+00	0.00000E+00
Channel 11				
Wavenumber	HIRS Filter Transmittance	Optical Element Transmittance	Product of the HIRS Filter and Optical Element Transmittances	Normalized Value of Column 4
1.32700E+03	0.00000E+00	2.93930E-01	0.00000E+00	0.00000E+00
1.32710E+03	1.33140E-03	2.93980E-01	3.91400E-04	1.66440E-03
1.32720E+03	1.49220E-03	2.94030E-01	4.38730E-04	1.86570E-03
1.32730E+03	1.65370E-03	2.94070E-01	4.86320E-04	2.06810E-03
1.32740E+03	1.81220E-03	2.94110E-01	5.33000E-04	2.26660E-03
1.32750E+03	1.96390E-03	2.94160E-01	5.77690E-04	2.45660E-03
1.32760E+03	2.10550E-03	2.94200E-01	6.19440E-04	2.63420E-03
1.32770E+03	2.23410E-03	2.94250E-01	6.57390E-04	2.79550E-03
1.32780E+03	2.34760E-03	2.94290E-01	6.90870E-04	2.93790E-03
1.32790E+03	2.44410E-03	2.94330E-01	7.19370E-04	3.05910E-03
1.32800E+03	2.52250E-03	2.94380E-01	7.42570E-04	3.15780E-03
1.32810E+03	2.58230E-03	2.94390E-01	7.60200E-04	3.23280E-03
1.32820E+03	2.62360E-03	2.94410E-01	7.72400E-04	3.28460E-03
1.32830E+03	2.64700E-03	2.94420E-01	7.79320E-04	3.31410E-03
1.32840E+03	2.65360E-03	2.94430E-01	7.81310E-04	3.32250E-03
1.32850E+03	2.64500E-03	2.94450E-01	7.78820E-04	3.31190E-03
1.32860E+03	2.62320E-03	2.94460E-01	7.72430E-04	3.28480E-03
1.32870E+03	2.59020E-03	2.94470E-01	7.62750E-04	3.24360E-03
1.32880E+03	2.54850E-03	2.94490E-01	7.50510E-04	3.19150E-03
1.32890E+03	2.50050E-03	2.94500E-01	7.36400E-04	3.13160E-03
1.32900E+03	2.44870E-03	2.94510E-01	7.21160E-04	3.06680E-03
1.32910E+03	2.39520E-03	2.94520E-01	7.05450E-04	2.99990E-03
1.32920E+03	2.34240E-03	2.94530E-01	6.89910E-04	2.93380E-03
1.32930E+03	2.29210E-03	2.94540E-01	6.75090E-04	2.87080E-03

1.32940E+03	2.24590E-03	2.94540E-01	6.61510E-04	2.81310E-03
1.32950E+03	2.20510E-03	2.94550E-01	6.49510E-04	2.76210E-03
1.32960E+03	2.17070E-03	2.94550E-01	6.39400E-04	2.71910E-03
1.32970E+03	2.14330E-03	2.94560E-01	6.31340E-04	2.68480E-03
1.32980E+03	2.12320E-03	2.94570E-01	6.25440E-04	2.65970E-03
1.32990E+03	2.11040E-03	2.94570E-01	6.21660E-04	2.64360E-03
1.33000E+03	2.10460E-03	2.94580E-01	6.19970E-04	2.63640E-03
1.33010E+03	2.10530E-03	2.94550E-01	6.20120E-04	2.63710E-03
1.33020E+03	2.11200E-03	2.94520E-01	6.22030E-04	2.64520E-03
1.33030E+03	2.12390E-03	2.94500E-01	6.25480E-04	2.65980E-03
1.33040E+03	2.14040E-03	2.94470E-01	6.30280E-04	2.68030E-03
1.33050E+03	2.16080E-03	2.94440E-01	6.36220E-04	2.70550E-03
1.33060E+03	2.18460E-03	2.94410E-01	6.43170E-04	2.73510E-03
1.33070E+03	2.21140E-03	2.94380E-01	6.51000E-04	2.76840E-03
1.33080E+03	2.24100E-03	2.94360E-01	6.59660E-04	2.80520E-03
1.33090E+03	2.27350E-03	2.94330E-01	6.69150E-04	2.84550E-03
1.33100E+03	2.30910E-03	2.94290E-01	6.79550E-04	2.88980E-03
1.33110E+03	2.34820E-03	2.94240E-01	6.90950E-04	2.93830E-03
1.33120E+03	2.39170E-03	2.94190E-01	7.03620E-04	2.99220E-03
1.33130E+03	2.44020E-03	2.94140E-01	7.17770E-04	3.05230E-03
1.33140E+03	2.49480E-03	2.94090E-01	7.33710E-04	3.12010E-03
1.33150E+03	2.55650E-03	2.94040E-01	7.51700E-04	3.19660E-03
1.33160E+03	2.62610E-03	2.93990E-01	7.72050E-04	3.28320E-03
1.33170E+03	2.70470E-03	2.93940E-01	7.95010E-04	3.38080E-03
1.33180E+03	2.79300E-03	2.93880E-01	8.20820E-04	3.49050E-03
1.33190E+03	2.89150E-03	2.93830E-01	8.49630E-04	3.61310E-03
1.33200E+03	3.00070E-03	2.93780E-01	8.81560E-04	3.74890E-03
1.33210E+03	3.12060E-03	2.93740E-01	9.16650E-04	3.89800E-03
1.33220E+03	3.25110E-03	2.93690E-01	9.54810E-04	4.06030E-03
1.33230E+03	3.39140E-03	2.93650E-01	9.95880E-04	4.23500E-03
1.33240E+03	3.54100E-03	2.93600E-01	1.03960E-03	4.42110E-03
1.33250E+03	3.69870E-03	2.93550E-01	1.08580E-03	4.61730E-03
1.33260E+03	3.86340E-03	2.93510E-01	1.13390E-03	4.82210E-03
1.33270E+03	4.03340E-03	2.93460E-01	1.18370E-03	5.03350E-03
1.33280E+03	4.20750E-03	2.93420E-01	1.23460E-03	5.25000E-03
1.33290E+03	4.38400E-03	2.93370E-01	1.28610E-03	5.46930E-03
1.33300E+03	4.56150E-03	2.93310E-01	1.33790E-03	5.68950E-03
1.33310E+03	4.73870E-03	2.93240E-01	1.38960E-03	5.90930E-03
1.33320E+03	4.91460E-03	2.93180E-01	1.44090E-03	6.12730E-03
1.33330E+03	5.08840E-03	2.93110E-01	1.49150E-03	6.34250E-03
1.33340E+03	5.25970E-03	2.93050E-01	1.54130E-03	6.55460E-03
1.33350E+03	5.42840E-03	2.92980E-01	1.59040E-03	6.76330E-03
1.33360E+03	5.59490E-03	2.92920E-01	1.63880E-03	6.96920E-03

1.33370E+03	5.75990E-03	2.92850E-01	1.68680E-03	7.17310E-03
1.33380E+03	5.92440E-03	2.92790E-01	1.73460E-03	7.37640E-03
1.33390E+03	6.09000E-03	2.92720E-01	1.78270E-03	7.58090E-03
1.33400E+03	6.25840E-03	2.92650E-01	1.83150E-03	7.78860E-03
1.33410E+03	6.43120E-03	2.92540E-01	1.88140E-03	8.00060E-03
1.33420E+03	6.61070E-03	2.92430E-01	1.93310E-03	8.22070E-03
1.33430E+03	6.79860E-03	2.92310E-01	1.98730E-03	8.45110E-03
1.33440E+03	6.99690E-03	2.92200E-01	2.04450E-03	8.69430E-03
1.33450E+03	7.20730E-03	2.92090E-01	2.10520E-03	8.95230E-03
1.33460E+03	7.43120E-03	2.91980E-01	2.16980E-03	9.22690E-03
1.33470E+03	7.66980E-03	2.91870E-01	2.23860E-03	9.51950E-03
1.33480E+03	7.92390E-03	2.91750E-01	2.31180E-03	9.83110E-03
1.33490E+03	8.19380E-03	2.91650E-01	2.38970E-03	1.01620E-02
1.33500E+03	8.47950E-03	2.91540E-01	2.47210E-03	1.05130E-02
1.33510E+03	8.78060E-03	2.91440E-01	2.55900E-03	1.08820E-02
1.33520E+03	9.09630E-03	2.91330E-01	2.65010E-03	1.12690E-02
1.33530E+03	9.42550E-03	2.91230E-01	2.74500E-03	1.16730E-02
1.33540E+03	9.76710E-03	2.91130E-01	2.84350E-03	1.20920E-02
1.33550E+03	1.01200E-02	2.91020E-01	2.94500E-03	1.25240E-02
1.33560E+03	1.04820E-02	2.90920E-01	3.04930E-03	1.29670E-02
1.33570E+03	1.08520E-02	2.90820E-01	3.15600E-03	1.34210E-02
1.33580E+03	1.12300E-02	2.90710E-01	3.26460E-03	1.38830E-02
1.33590E+03	1.16140E-02	2.90610E-01	3.37510E-03	1.43530E-02
1.33600E+03	1.20040E-02	2.90500E-01	3.48720E-03	1.48290E-02
1.33610E+03	1.24000E-02	2.90390E-01	3.60090E-03	1.53130E-02
1.33620E+03	1.28030E-02	2.90280E-01	3.71640E-03	1.58040E-02
1.33630E+03	1.32130E-02	2.90160E-01	3.83400E-03	1.63040E-02
1.33640E+03	1.36330E-02	2.90040E-01	3.95410E-03	1.68150E-02
1.33650E+03	1.40630E-02	2.89930E-01	4.07730E-03	1.73390E-02
1.33660E+03	1.45070E-02	2.89810E-01	4.20430E-03	1.78790E-02
1.33670E+03	1.49660E-02	2.89700E-01	4.33570E-03	1.84380E-02
1.33680E+03	1.54450E-02	2.89590E-01	4.47270E-03	1.90200E-02
1.33690E+03	1.59450E-02	2.89500E-01	4.61610E-03	1.96300E-02
1.33700E+03	1.64700E-02	2.89410E-01	4.76640E-03	2.02690E-02
1.33710E+03	1.70220E-02	2.89320E-01	4.92470E-03	2.09420E-02
1.33720E+03	1.76040E-02	2.89220E-01	5.09160E-03	2.16520E-02
1.33730E+03	1.82190E-02	2.89130E-01	5.26770E-03	2.24010E-02
1.33740E+03	1.88680E-02	2.89040E-01	5.45360E-03	2.31910E-02
1.33750E+03	1.95530E-02	2.88950E-01	5.64980E-03	2.40260E-02
1.33760E+03	2.02740E-02	2.88860E-01	5.85640E-03	2.49040E-02
1.33770E+03	2.10330E-02	2.88770E-01	6.07380E-03	2.58290E-02
1.33780E+03	2.18300E-02	2.88680E-01	6.30190E-03	2.67990E-02
1.33790E+03	2.26650E-02	2.88590E-01	6.54080E-03	2.78150E-02

1.33800E+03	2.35370E-02	2.88500E-01	6.79030E-03	2.88760E-02
1.33810E+03	2.44460E-02	2.88440E-01	7.05110E-03	2.99850E-02
1.33820E+03	2.53920E-02	2.88380E-01	7.32250E-03	3.11390E-02
1.33830E+03	2.63740E-02	2.88330E-01	7.60440E-03	3.23380E-02
1.33840E+03	2.73930E-02	2.88270E-01	7.89670E-03	3.35810E-02
1.33850E+03	2.84500E-02	2.88210E-01	8.19970E-03	3.48690E-02
1.33860E+03	2.95450E-02	2.88160E-01	8.51370E-03	3.62050E-02
1.33870E+03	3.06810E-02	2.88110E-01	8.83930E-03	3.75890E-02
1.33880E+03	3.18590E-02	2.88070E-01	9.17750E-03	3.90270E-02
1.33890E+03	3.30820E-02	2.88030E-01	9.52880E-03	4.05210E-02
1.33900E+03	3.43560E-02	2.87990E-01	9.89430E-03	4.20760E-02
1.33910E+03	3.56840E-02	2.87950E-01	1.02750E-02	4.36960E-02
1.33920E+03	3.70710E-02	2.87910E-01	1.06730E-02	4.53880E-02
1.33930E+03	3.85240E-02	2.87870E-01	1.10900E-02	4.71600E-02
1.33940E+03	4.00480E-02	2.87830E-01	1.15270E-02	4.90190E-02
1.33950E+03	4.16490E-02	2.87790E-01	1.19860E-02	5.09720E-02
1.33960E+03	4.33340E-02	2.87750E-01	1.24700E-02	5.30270E-02
1.33970E+03	4.51100E-02	2.87710E-01	1.29790E-02	5.51920E-02
1.33980E+03	4.69810E-02	2.87670E-01	1.35150E-02	5.74740E-02
1.33990E+03	4.89560E-02	2.87630E-01	1.40810E-02	5.98810E-02
1.34000E+03	5.10370E-02	2.87590E-01	1.46780E-02	6.24180E-02
1.34010E+03	5.32310E-02	2.87530E-01	1.53060E-02	6.50880E-02
1.34020E+03	5.55420E-02	2.87470E-01	1.59670E-02	6.78990E-02
1.34030E+03	5.79730E-02	2.87410E-01	1.66620E-02	7.08550E-02
1.34040E+03	6.05270E-02	2.87350E-01	1.73920E-02	7.39620E-02
1.34050E+03	6.32070E-02	2.87290E-01	1.81590E-02	7.72200E-02
1.34060E+03	6.60160E-02	2.87230E-01	1.89620E-02	8.06350E-02
1.34070E+03	6.89550E-02	2.87190E-01	1.98030E-02	8.42120E-02
1.34080E+03	7.20270E-02	2.87140E-01	2.06820E-02	8.79510E-02
1.34090E+03	7.52350E-02	2.87100E-01	2.16000E-02	9.18540E-02
1.34100E+03	7.85800E-02	2.87060E-01	2.25570E-02	9.59240E-02
1.34110E+03	8.20660E-02	2.87020E-01	2.35540E-02	1.00170E-01
1.34120E+03	8.56980E-02	2.86980E-01	2.45930E-02	1.04580E-01
1.34130E+03	8.94790E-02	2.86930E-01	2.56750E-02	1.09180E-01
1.34140E+03	9.34160E-02	2.86890E-01	2.68000E-02	1.13970E-01
1.34150E+03	9.75160E-02	2.86850E-01	2.79720E-02	1.18950E-01
1.34160E+03	1.01780E-01	2.86810E-01	2.91930E-02	1.24140E-01
1.34170E+03	1.06230E-01	2.86770E-01	3.04640E-02	1.29550E-01
1.34180E+03	1.10870E-01	2.86720E-01	3.17890E-02	1.35180E-01
1.34190E+03	1.15700E-01	2.86680E-01	3.31700E-02	1.41060E-01
1.34200E+03	1.20750E-01	2.86640E-01	3.46110E-02	1.47180E-01
1.34210E+03	1.26010E-01	2.86580E-01	3.61120E-02	1.53570E-01
1.34220E+03	1.31500E-01	2.86530E-01	3.76800E-02	1.60230E-01

1.34230E+03	1.37240E-01	2.86470E-01	3.93150E-02	1.67190E-01
1.34240E+03	1.43220E-01	2.86420E-01	4.10220E-02	1.74450E-01
1.34250E+03	1.49470E-01	2.86360E-01	4.28020E-02	1.82020E-01
1.34260E+03	1.55980E-01	2.86320E-01	4.46610E-02	1.89920E-01
1.34270E+03	1.62770E-01	2.86280E-01	4.65990E-02	1.98160E-01
1.34280E+03	1.69840E-01	2.86250E-01	4.86160E-02	2.06740E-01
1.34290E+03	1.77190E-01	2.86210E-01	5.07140E-02	2.15660E-01
1.34300E+03	1.84830E-01	2.86180E-01	5.28930E-02	2.24930E-01
1.34310E+03	1.92740E-01	2.86150E-01	5.51530E-02	2.34540E-01
1.34320E+03	2.00950E-01	2.86110E-01	5.74940E-02	2.44490E-01
1.34330E+03	2.09430E-01	2.86080E-01	5.99130E-02	2.54780E-01
1.34340E+03	2.18180E-01	2.86050E-01	6.24100E-02	2.65400E-01
1.34350E+03	2.27200E-01	2.86020E-01	6.49830E-02	2.76340E-01
1.34360E+03	2.36480E-01	2.85980E-01	6.76300E-02	2.87600E-01
1.34370E+03	2.46010E-01	2.85950E-01	7.03480E-02	2.99150E-01
1.34380E+03	2.55790E-01	2.85920E-01	7.31350E-02	3.11010E-01
1.34390E+03	2.65800E-01	2.85880E-01	7.59880E-02	3.23140E-01
1.34400E+03	2.76040E-01	2.85850E-01	7.89050E-02	3.35540E-01
1.34410E+03	2.86490E-01	2.85790E-01	8.18740E-02	3.48170E-01
1.34420E+03	2.97140E-01	2.85730E-01	8.49010E-02	3.61040E-01
1.34430E+03	3.08000E-01	2.85660E-01	8.79840E-02	3.74150E-01
1.34440E+03	3.19040E-01	2.85600E-01	9.11190E-02	3.87480E-01
1.34450E+03	3.30270E-01	2.85540E-01	9.43050E-02	4.01030E-01
1.34460E+03	3.41670E-01	2.85480E-01	9.75390E-02	4.14790E-01
1.34470E+03	3.53240E-01	2.85410E-01	1.00820E-01	4.28740E-01
1.34480E+03	3.64970E-01	2.85350E-01	1.04140E-01	4.42880E-01
1.34490E+03	3.76850E-01	2.85290E-01	1.07510E-01	4.57190E-01
1.34500E+03	3.88870E-01	2.85230E-01	1.10920E-01	4.71670E-01
1.34510E+03	4.01030E-01	2.85160E-01	1.14360E-01	4.86310E-01
1.34520E+03	4.13300E-01	2.85100E-01	1.17830E-01	5.01090E-01
1.34530E+03	4.25690E-01	2.85040E-01	1.21340E-01	5.16000E-01
1.34540E+03	4.38180E-01	2.84980E-01	1.24870E-01	5.31010E-01
1.34550E+03	4.50750E-01	2.84910E-01	1.28420E-01	5.46130E-01
1.34560E+03	4.63380E-01	2.84850E-01	1.32000E-01	5.61310E-01
1.34570E+03	4.76070E-01	2.84790E-01	1.35580E-01	5.76550E-01
1.34580E+03	4.88780E-01	2.84730E-01	1.39170E-01	5.91810E-01
1.34590E+03	5.01490E-01	2.84660E-01	1.42760E-01	6.07070E-01
1.34600E+03	5.14190E-01	2.84600E-01	1.46340E-01	6.22310E-01
1.34610E+03	5.26850E-01	2.84560E-01	1.49920E-01	6.37530E-01
1.34620E+03	5.39440E-01	2.84510E-01	1.53480E-01	6.52660E-01
1.34630E+03	5.51940E-01	2.84470E-01	1.57010E-01	6.67670E-01
1.34640E+03	5.64320E-01	2.84420E-01	1.60500E-01	6.82540E-01
1.34650E+03	5.76560E-01	2.84360E-01	1.63950E-01	6.97190E-01

1.34660E+03	5.88630E-01	2.84300E-01	1.67340E-01	7.11640E-01
1.34670E+03	6.00510E-01	2.84230E-01	1.70690E-01	7.25840E-01
1.34680E+03	6.12190E-01	2.84170E-01	1.73970E-01	7.39790E-01
1.34690E+03	6.23630E-01	2.84110E-01	1.77180E-01	7.53450E-01
1.34700E+03	6.34820E-01	2.84050E-01	1.80320E-01	7.66810E-01
1.34710E+03	6.45760E-01	2.83980E-01	1.83380E-01	7.79840E-01
1.34720E+03	6.56410E-01	2.83920E-01	1.86370E-01	7.92530E-01
1.34730E+03	6.66780E-01	2.83850E-01	1.89270E-01	8.04870E-01
1.34740E+03	6.76860E-01	2.83790E-01	1.92090E-01	8.16850E-01
1.34750E+03	6.86630E-01	2.83730E-01	1.94820E-01	8.28450E-01
1.34760E+03	6.96090E-01	2.83660E-01	1.97460E-01	8.39690E-01
1.34770E+03	7.05250E-01	2.83600E-01	2.00010E-01	8.50550E-01
1.34780E+03	7.14100E-01	2.83540E-01	2.02470E-01	8.61020E-01
1.34790E+03	7.22640E-01	2.83470E-01	2.04850E-01	8.71120E-01
1.34800E+03	7.30860E-01	2.83410E-01	2.07130E-01	8.80840E-01
1.34810E+03	7.38780E-01	2.83360E-01	2.09340E-01	8.90220E-01
1.34820E+03	7.46380E-01	2.83310E-01	2.11460E-01	8.99230E-01
1.34830E+03	7.53680E-01	2.83260E-01	2.13490E-01	9.07860E-01
1.34840E+03	7.60660E-01	2.83200E-01	2.15420E-01	9.16060E-01
1.34850E+03	7.67330E-01	2.83130E-01	2.17250E-01	9.23870E-01
1.34860E+03	7.73690E-01	2.83060E-01	2.19000E-01	9.31290E-01
1.34870E+03	7.79740E-01	2.82990E-01	2.20650E-01	9.38340E-01
1.34880E+03	7.85470E-01	2.82920E-01	2.22220E-01	9.44990E-01
1.34890E+03	7.90870E-01	2.82840E-01	2.23690E-01	9.51260E-01
1.34900E+03	7.95960E-01	2.82770E-01	2.25080E-01	9.57140E-01
1.34910E+03	8.00710E-01	2.82700E-01	2.26360E-01	9.62620E-01
1.34920E+03	8.05140E-01	2.82630E-01	2.27560E-01	9.67700E-01
1.34930E+03	8.09250E-01	2.82560E-01	2.28660E-01	9.72390E-01
1.34940E+03	8.13020E-01	2.82490E-01	2.29670E-01	9.76680E-01
1.34950E+03	8.16460E-01	2.82420E-01	2.30590E-01	9.80570E-01
1.34960E+03	8.19580E-01	2.82350E-01	2.31410E-01	9.84070E-01
1.34970E+03	8.22380E-01	2.82280E-01	2.32140E-01	9.87180E-01
1.34980E+03	8.24870E-01	2.82210E-01	2.32780E-01	9.89920E-01
1.34990E+03	8.27050E-01	2.82140E-01	2.33340E-01	9.92290E-01
1.35000E+03	8.28940E-01	2.82070E-01	2.33820E-01	9.94300E-01
1.35010E+03	8.30550E-01	2.82000E-01	2.34210E-01	9.96000E-01
1.35020E+03	8.31890E-01	2.81930E-01	2.34540E-01	9.97380E-01
1.35030E+03	8.32990E-01	2.81860E-01	2.34790E-01	9.98430E-01
1.35040E+03	8.33860E-01	2.81780E-01	2.34960E-01	9.99180E-01
1.35050E+03	8.34510E-01	2.81700E-01	2.35080E-01	9.99680E-01
1.35060E+03	8.34980E-01	2.81620E-01	2.35140E-01	9.99940E-01
1.35070E+03	8.35270E-01	2.81530E-01	2.35160E-01	1.00000E+00
1.35080E+03	8.35400E-01	2.81450E-01	2.35130E-01	9.99870E-01

1.35090E+03	8.35400E-01	2.81370E-01	2.35060E-01	9.99580E-01
1.35100E+03	8.35280E-01	2.81290E-01	2.34960E-01	9.99150E-01
1.35110E+03	8.35060E-01	2.81210E-01	2.34830E-01	9.98600E-01
1.35120E+03	8.34740E-01	2.81130E-01	2.34670E-01	9.97940E-01
1.35130E+03	8.34350E-01	2.81050E-01	2.34490E-01	9.97190E-01
1.35140E+03	8.33890E-01	2.80970E-01	2.34300E-01	9.96350E-01
1.35150E+03	8.33370E-01	2.80890E-01	2.34080E-01	9.95440E-01
1.35160E+03	8.32790E-01	2.80810E-01	2.33850E-01	9.94470E-01
1.35170E+03	8.32160E-01	2.80730E-01	2.33610E-01	9.93440E-01
1.35180E+03	8.31480E-01	2.80650E-01	2.33350E-01	9.92340E-01
1.35190E+03	8.30750E-01	2.80570E-01	2.33080E-01	9.91190E-01
1.35200E+03	8.29980E-01	2.80490E-01	2.32800E-01	9.89980E-01
1.35210E+03	8.29150E-01	2.80400E-01	2.32500E-01	9.88690E-01
1.35220E+03	8.28270E-01	2.80310E-01	2.32170E-01	9.87320E-01
1.35230E+03	8.27330E-01	2.80200E-01	2.31820E-01	9.85810E-01
1.35240E+03	8.26340E-01	2.80090E-01	2.31450E-01	9.84240E-01
1.35250E+03	8.25300E-01	2.79970E-01	2.31060E-01	9.82590E-01
1.35260E+03	8.24200E-01	2.79860E-01	2.30660E-01	9.80890E-01
1.35270E+03	8.23050E-01	2.79750E-01	2.30250E-01	9.79120E-01
1.35280E+03	8.21840E-01	2.79630E-01	2.29820E-01	9.77290E-01
1.35290E+03	8.20590E-01	2.79520E-01	2.29370E-01	9.75410E-01
1.35300E+03	8.19300E-01	2.79410E-01	2.28920E-01	9.73480E-01
1.35310E+03	8.17970E-01	2.79290E-01	2.28450E-01	9.71500E-01
1.35320E+03	8.16620E-01	2.79180E-01	2.27980E-01	9.69500E-01
1.35330E+03	8.15240E-01	2.79070E-01	2.27510E-01	9.67470E-01
1.35340E+03	8.13860E-01	2.78950E-01	2.27030E-01	9.65430E-01
1.35350E+03	8.12480E-01	2.78840E-01	2.26550E-01	9.63400E-01
1.35360E+03	8.11100E-01	2.78720E-01	2.26070E-01	9.61370E-01
1.35370E+03	8.09740E-01	2.78610E-01	2.25600E-01	9.59370E-01
1.35380E+03	8.08410E-01	2.78490E-01	2.25140E-01	9.57390E-01
1.35390E+03	8.07110E-01	2.78380E-01	2.24680E-01	9.55450E-01
1.35400E+03	8.05840E-01	2.78260E-01	2.24240E-01	9.53560E-01
1.35410E+03	8.04620E-01	2.78170E-01	2.23820E-01	9.51810E-01
1.35420E+03	8.03440E-01	2.78070E-01	2.23410E-01	9.50050E-01
1.35430E+03	8.02310E-01	2.77950E-01	2.23010E-01	9.48330E-01
1.35440E+03	8.01220E-01	2.77840E-01	2.22610E-01	9.46670E-01
1.35450E+03	8.00180E-01	2.77730E-01	2.22240E-01	9.45060E-01
1.35460E+03	7.99180E-01	2.77620E-01	2.21870E-01	9.43500E-01
1.35470E+03	7.98220E-01	2.77510E-01	2.21510E-01	9.41980E-01
1.35480E+03	7.97290E-01	2.77400E-01	2.21160E-01	9.40500E-01
1.35490E+03	7.96380E-01	2.77280E-01	2.20820E-01	9.39050E-01
1.35500E+03	7.95490E-01	2.77170E-01	2.20490E-01	9.37630E-01
1.35510E+03	7.94620E-01	2.77060E-01	2.20160E-01	9.36220E-01

1.35520E+03	7.93750E-01	2.76950E-01	2.19830E-01	9.34820E-01
1.35530E+03	7.92890E-01	2.76840E-01	2.19500E-01	9.33430E-01
1.35540E+03	7.92020E-01	2.76720E-01	2.19170E-01	9.32030E-01
1.35550E+03	7.91150E-01	2.76610E-01	2.18840E-01	9.30630E-01
1.35560E+03	7.90270E-01	2.76500E-01	2.18510E-01	9.29220E-01
1.35570E+03	7.89390E-01	2.76390E-01	2.18180E-01	9.27800E-01
1.35580E+03	7.88490E-01	2.76280E-01	2.17840E-01	9.26370E-01
1.35590E+03	7.87590E-01	2.76160E-01	2.17500E-01	9.24930E-01
1.35600E+03	7.86680E-01	2.76050E-01	2.17160E-01	9.23490E-01
1.35610E+03	7.85770E-01	2.75930E-01	2.16820E-01	9.22010E-01
1.35620E+03	7.84870E-01	2.75800E-01	2.16470E-01	9.20530E-01
1.35630E+03	7.83970E-01	2.75670E-01	2.16120E-01	9.19050E-01
1.35640E+03	7.83100E-01	2.75550E-01	2.15780E-01	9.17610E-01
1.35650E+03	7.82240E-01	2.75420E-01	2.15450E-01	9.16180E-01
1.35660E+03	7.81420E-01	2.75290E-01	2.15120E-01	9.14800E-01
1.35670E+03	7.80630E-01	2.75170E-01	2.14800E-01	9.13450E-01
1.35680E+03	7.79880E-01	2.75040E-01	2.14500E-01	9.12150E-01
1.35690E+03	7.79180E-01	2.74910E-01	2.14210E-01	9.10910E-01
1.35700E+03	7.78520E-01	2.74790E-01	2.13930E-01	9.09730E-01
1.35710E+03	7.77920E-01	2.74660E-01	2.13660E-01	9.08610E-01
1.35720E+03	7.77370E-01	2.74540E-01	2.13420E-01	9.07550E-01
1.35730E+03	7.76870E-01	2.74410E-01	2.13180E-01	9.06560E-01
1.35740E+03	7.76430E-01	2.74290E-01	2.12960E-01	9.05620E-01
1.35750E+03	7.76030E-01	2.74160E-01	2.12760E-01	9.04750E-01
1.35760E+03	7.75690E-01	2.74040E-01	2.12570E-01	9.03940E-01
1.35770E+03	7.75390E-01	2.73910E-01	2.12390E-01	9.03180E-01
1.35780E+03	7.75130E-01	2.73790E-01	2.12220E-01	9.02460E-01
1.35790E+03	7.74900E-01	2.73660E-01	2.12060E-01	9.01790E-01
1.35800E+03	7.74710E-01	2.73550E-01	2.11920E-01	9.01190E-01
1.35810E+03	7.74550E-01	2.73500E-01	2.11840E-01	9.00850E-01
1.35820E+03	7.74410E-01	2.73450E-01	2.11760E-01	9.00530E-01
1.35830E+03	7.74290E-01	2.73400E-01	2.11700E-01	9.00240E-01
1.35840E+03	7.74190E-01	2.73360E-01	2.11630E-01	8.99960E-01
1.35850E+03	7.74110E-01	2.73310E-01	2.11570E-01	8.99710E-01
1.35860E+03	7.74040E-01	2.73260E-01	2.11520E-01	8.99480E-01
1.35870E+03	7.73990E-01	2.73220E-01	2.11470E-01	8.99260E-01
1.35880E+03	7.73950E-01	2.73170E-01	2.11420E-01	8.99060E-01
1.35890E+03	7.73930E-01	2.73120E-01	2.11380E-01	8.98870E-01
1.35900E+03	7.73920E-01	2.73070E-01	2.11340E-01	8.98710E-01
1.35910E+03	7.73930E-01	2.73030E-01	2.11310E-01	8.98580E-01
1.35920E+03	7.73970E-01	2.72980E-01	2.11280E-01	8.98470E-01
1.35930E+03	7.74030E-01	2.72940E-01	2.11260E-01	8.98390E-01
1.35940E+03	7.74130E-01	2.72890E-01	2.11250E-01	8.98350E-01

1.35950E+03	7.74250E-01	2.72840E-01	2.11250E-01	8.98340E-01
1.35960E+03	7.74410E-01	2.72800E-01	2.11260E-01	8.98380E-01
1.35970E+03	7.74600E-01	2.72750E-01	2.11280E-01	8.98450E-01
1.35980E+03	7.74830E-01	2.72710E-01	2.11300E-01	8.98570E-01
1.35990E+03	7.75100E-01	2.72660E-01	2.11340E-01	8.98730E-01
1.36000E+03	7.75400E-01	2.72650E-01	2.11420E-01	8.99050E-01
1.36010E+03	7.75740E-01	2.72600E-01	2.11470E-01	8.99260E-01
1.36020E+03	7.76110E-01	2.72540E-01	2.11520E-01	8.99500E-01
1.36030E+03	7.76500E-01	2.72480E-01	2.11580E-01	8.99770E-01
1.36040E+03	7.76920E-01	2.72430E-01	2.11650E-01	9.00060E-01
1.36050E+03	7.77360E-01	2.72370E-01	2.11730E-01	9.00370E-01
1.36060E+03	7.77800E-01	2.72310E-01	2.11800E-01	9.00700E-01
1.36070E+03	7.78250E-01	2.72250E-01	2.11880E-01	9.01030E-01
1.36080E+03	7.78700E-01	2.72200E-01	2.11960E-01	9.01360E-01
1.36090E+03	7.79140E-01	2.72140E-01	2.12030E-01	9.01680E-01
1.36100E+03	7.79560E-01	2.72080E-01	2.12110E-01	9.01980E-01
1.36110E+03	7.79960E-01	2.72030E-01	2.12170E-01	9.02260E-01
1.36120E+03	7.80340E-01	2.71970E-01	2.12230E-01	9.02500E-01
1.36130E+03	7.80680E-01	2.71910E-01	2.12280E-01	9.02710E-01
1.36140E+03	7.80990E-01	2.71860E-01	2.12320E-01	9.02880E-01
1.36150E+03	7.81250E-01	2.71800E-01	2.12340E-01	9.03000E-01
1.36160E+03	7.81480E-01	2.71740E-01	2.12360E-01	9.03070E-01
1.36170E+03	7.81670E-01	2.71690E-01	2.12370E-01	9.03100E-01
1.36180E+03	7.81810E-01	2.71630E-01	2.12360E-01	9.03080E-01
1.36190E+03	7.81920E-01	2.71600E-01	2.12370E-01	9.03110E-01
1.36200E+03	7.81990E-01	2.71580E-01	2.12370E-01	9.03120E-01
1.36210E+03	7.82020E-01	2.71610E-01	2.12410E-01	9.03260E-01
1.36220E+03	7.82020E-01	2.71650E-01	2.12430E-01	9.03380E-01
1.36230E+03	7.82000E-01	2.71680E-01	2.12450E-01	9.03460E-01
1.36240E+03	7.81940E-01	2.71720E-01	2.12470E-01	9.03520E-01
1.36250E+03	7.81870E-01	2.71750E-01	2.12480E-01	9.03560E-01
1.36260E+03	7.81780E-01	2.71790E-01	2.12480E-01	9.03570E-01
1.36270E+03	7.81680E-01	2.71820E-01	2.12480E-01	9.03570E-01
1.36280E+03	7.81560E-01	2.71860E-01	2.12470E-01	9.03550E-01
1.36290E+03	7.81430E-01	2.71890E-01	2.12470E-01	9.03520E-01
1.36300E+03	7.81290E-01	2.71930E-01	2.12460E-01	9.03470E-01
1.36310E+03	7.81140E-01	2.71960E-01	2.12440E-01	9.03410E-01
1.36320E+03	7.80970E-01	2.72000E-01	2.12420E-01	9.03330E-01
1.36330E+03	7.80790E-01	2.72030E-01	2.12400E-01	9.03230E-01
1.36340E+03	7.80590E-01	2.72060E-01	2.12370E-01	9.03110E-01
1.36350E+03	7.80360E-01	2.72100E-01	2.12340E-01	9.02960E-01
1.36360E+03	7.80110E-01	2.72130E-01	2.12290E-01	9.02780E-01
1.36370E+03	7.79820E-01	2.72170E-01	2.12240E-01	9.02560E-01

1.36380E+03	7.79500E-01	2.72210E-01	2.12190E-01	9.02330E-01
1.36390E+03	7.79130E-01	2.72270E-01	2.12130E-01	9.02090E-01
1.36400E+03	7.78720E-01	2.72320E-01	2.12060E-01	9.01800E-01
1.36410E+03	7.78250E-01	2.72310E-01	2.11930E-01	9.01230E-01
1.36420E+03	7.77730E-01	2.72310E-01	2.11780E-01	9.00600E-01
1.36430E+03	7.77150E-01	2.72300E-01	2.11620E-01	8.99900E-01
1.36440E+03	7.76510E-01	2.72290E-01	2.11440E-01	8.99130E-01
1.36450E+03	7.75820E-01	2.72280E-01	2.11240E-01	8.98290E-01
1.36460E+03	7.75060E-01	2.72270E-01	2.11030E-01	8.97390E-01
1.36470E+03	7.74250E-01	2.72260E-01	2.10800E-01	8.96420E-01
1.36480E+03	7.73380E-01	2.72250E-01	2.10550E-01	8.95380E-01
1.36490E+03	7.72460E-01	2.72240E-01	2.10300E-01	8.94290E-01
1.36500E+03	7.71500E-01	2.72230E-01	2.10030E-01	8.93150E-01
1.36510E+03	7.70490E-01	2.72230E-01	2.09750E-01	8.91960E-01
1.36520E+03	7.69460E-01	2.72220E-01	2.09460E-01	8.90730E-01
1.36530E+03	7.68400E-01	2.72210E-01	2.09160E-01	8.89460E-01
1.36540E+03	7.67310E-01	2.72200E-01	2.08860E-01	8.88180E-01
1.36550E+03	7.66220E-01	2.72190E-01	2.08550E-01	8.86880E-01
1.36560E+03	7.65110E-01	2.72180E-01	2.08250E-01	8.85570E-01
1.36570E+03	7.64000E-01	2.72170E-01	2.07940E-01	8.84250E-01
1.36580E+03	7.62900E-01	2.72140E-01	2.07620E-01	8.82900E-01
1.36590E+03	7.61790E-01	2.72120E-01	2.07300E-01	8.81550E-01
1.36600E+03	7.60700E-01	2.72100E-01	2.06990E-01	8.80220E-01
1.36610E+03	7.59620E-01	2.72170E-01	2.06740E-01	8.79180E-01
1.36620E+03	7.58540E-01	2.72250E-01	2.06510E-01	8.78190E-01
1.36630E+03	7.57470E-01	2.72330E-01	2.06280E-01	8.77210E-01
1.36640E+03	7.56420E-01	2.72400E-01	2.06050E-01	8.76230E-01
1.36650E+03	7.55360E-01	2.72480E-01	2.05820E-01	8.75260E-01
1.36660E+03	7.54310E-01	2.72560E-01	2.05590E-01	8.74290E-01
1.36670E+03	7.53260E-01	2.72640E-01	2.05370E-01	8.73320E-01
1.36680E+03	7.52200E-01	2.72720E-01	2.05140E-01	8.72350E-01
1.36690E+03	7.51130E-01	2.72790E-01	2.04910E-01	8.71360E-01
1.36700E+03	7.50060E-01	2.72870E-01	2.04670E-01	8.70370E-01
1.36710E+03	7.48970E-01	2.72950E-01	2.04430E-01	8.69350E-01
1.36720E+03	7.47870E-01	2.73030E-01	2.04190E-01	8.68320E-01
1.36730E+03	7.46750E-01	2.73110E-01	2.03940E-01	8.67270E-01
1.36740E+03	7.45610E-01	2.73190E-01	2.03690E-01	8.66200E-01
1.36750E+03	7.44460E-01	2.73270E-01	2.03440E-01	8.65120E-01
1.36760E+03	7.43300E-01	2.73350E-01	2.03180E-01	8.64020E-01
1.36770E+03	7.42130E-01	2.73410E-01	2.02910E-01	8.62860E-01
1.36780E+03	7.40960E-01	2.73470E-01	2.02630E-01	8.61680E-01
1.36790E+03	7.39790E-01	2.73530E-01	2.02350E-01	8.60510E-01
1.36800E+03	7.38630E-01	2.73590E-01	2.02080E-01	8.59340E-01

1.36810E+03	7.37490E-01	2.73610E-01	2.01790E-01	8.58100E-01
1.36820E+03	7.36370E-01	2.73640E-01	2.01500E-01	8.56880E-01
1.36830E+03	7.35280E-01	2.73670E-01	2.01220E-01	8.55700E-01
1.36840E+03	7.34230E-01	2.73690E-01	2.00950E-01	8.54560E-01
1.36850E+03	7.33230E-01	2.73720E-01	2.00700E-01	8.53480E-01
1.36860E+03	7.32280E-01	2.73750E-01	2.00460E-01	8.52460E-01
1.36870E+03	7.31390E-01	2.73770E-01	2.00240E-01	8.51510E-01
1.36880E+03	7.30570E-01	2.73800E-01	2.00030E-01	8.50630E-01
1.36890E+03	7.29820E-01	2.73830E-01	1.99840E-01	8.49840E-01
1.36900E+03	7.29130E-01	2.73850E-01	1.99680E-01	8.49130E-01
1.36910E+03	7.28530E-01	2.73880E-01	1.99530E-01	8.48500E-01
1.36920E+03	7.28000E-01	2.73900E-01	1.99400E-01	8.47960E-01
1.36930E+03	7.27540E-01	2.73930E-01	1.99300E-01	8.47510E-01
1.36940E+03	7.27160E-01	2.73960E-01	1.99210E-01	8.47140E-01
1.36950E+03	7.26860E-01	2.73980E-01	1.99140E-01	8.46860E-01
1.36960E+03	7.26620E-01	2.74000E-01	1.99090E-01	8.46640E-01
1.36970E+03	7.26450E-01	2.74010E-01	1.99050E-01	8.46480E-01
1.36980E+03	7.26350E-01	2.74020E-01	1.99030E-01	8.46390E-01
1.36990E+03	7.26310E-01	2.74030E-01	1.99030E-01	8.46380E-01
1.37000E+03	7.26330E-01	2.74040E-01	1.99040E-01	8.46430E-01
1.37010E+03	7.26410E-01	2.74040E-01	1.99060E-01	8.46520E-01
1.37020E+03	7.26540E-01	2.74040E-01	1.99100E-01	8.46670E-01
1.37030E+03	7.26730E-01	2.74030E-01	1.99150E-01	8.46880E-01
1.37040E+03	7.26970E-01	2.74030E-01	1.99210E-01	8.47160E-01
1.37050E+03	7.27280E-01	2.74030E-01	1.99300E-01	8.47510E-01
1.37060E+03	7.27640E-01	2.74030E-01	1.99390E-01	8.47920E-01
1.37070E+03	7.28060E-01	2.74030E-01	1.99510E-01	8.48410E-01
1.37080E+03	7.28550E-01	2.74030E-01	1.99640E-01	8.48970E-01
1.37090E+03	7.29100E-01	2.74020E-01	1.99790E-01	8.49610E-01
1.37100E+03	7.29730E-01	2.74020E-01	1.99960E-01	8.50340E-01
1.37110E+03	7.30430E-01	2.74020E-01	2.00150E-01	8.51150E-01
1.37120E+03	7.31220E-01	2.74010E-01	2.00360E-01	8.52050E-01
1.37130E+03	7.32090E-01	2.74010E-01	2.00600E-01	8.53050E-01
1.37140E+03	7.33050E-01	2.74010E-01	2.00860E-01	8.54160E-01
1.37150E+03	7.34100E-01	2.74000E-01	2.01140E-01	8.55370E-01
1.37160E+03	7.35250E-01	2.73990E-01	2.01450E-01	8.56680E-01
1.37170E+03	7.36490E-01	2.73990E-01	2.01790E-01	8.58110E-01
1.37180E+03	7.37830E-01	2.73980E-01	2.02150E-01	8.59650E-01
1.37190E+03	7.39260E-01	2.73970E-01	2.02540E-01	8.61290E-01
1.37200E+03	7.40790E-01	2.73970E-01	2.02950E-01	8.63050E-01
1.37210E+03	7.42400E-01	2.73990E-01	2.03410E-01	8.65000E-01
1.37220E+03	7.44100E-01	2.74010E-01	2.03890E-01	8.67050E-01
1.37230E+03	7.45880E-01	2.74030E-01	2.04400E-01	8.69200E-01

1.37240E+03	7.47740E-01	2.74060E-01	2.04920E-01	8.71440E-01
1.37250E+03	7.49660E-01	2.74080E-01	2.05470E-01	8.73760E-01
1.37260E+03	7.51650E-01	2.74110E-01	2.06030E-01	8.76150E-01
1.37270E+03	7.53690E-01	2.74130E-01	2.06610E-01	8.78600E-01
1.37280E+03	7.55780E-01	2.74150E-01	2.07200E-01	8.81120E-01
1.37290E+03	7.57910E-01	2.74180E-01	2.07800E-01	8.83680E-01
1.37300E+03	7.60080E-01	2.74200E-01	2.08410E-01	8.86280E-01
1.37310E+03	7.62270E-01	2.74230E-01	2.09040E-01	8.88930E-01
1.37320E+03	7.64500E-01	2.74250E-01	2.09670E-01	8.91600E-01
1.37330E+03	7.66740E-01	2.74280E-01	2.10300E-01	8.94300E-01
1.37340E+03	7.69000E-01	2.74300E-01	2.10940E-01	8.97030E-01
1.37350E+03	7.71280E-01	2.74340E-01	2.11590E-01	8.99800E-01
1.37360E+03	7.73570E-01	2.74380E-01	2.12250E-01	9.02600E-01
1.37370E+03	7.75870E-01	2.74420E-01	2.12910E-01	9.05410E-01
1.37380E+03	7.78180E-01	2.74450E-01	2.13570E-01	9.08230E-01
1.37390E+03	7.80500E-01	2.74490E-01	2.14240E-01	9.11060E-01
1.37400E+03	7.82830E-01	2.74530E-01	2.14910E-01	9.13910E-01
1.37410E+03	7.85170E-01	2.74550E-01	2.15570E-01	9.16710E-01
1.37420E+03	7.87510E-01	2.74570E-01	2.16230E-01	9.19510E-01
1.37430E+03	7.89860E-01	2.74590E-01	2.16890E-01	9.22330E-01
1.37440E+03	7.92210E-01	2.74620E-01	2.17550E-01	9.25150E-01
1.37450E+03	7.94560E-01	2.74640E-01	2.18220E-01	9.27960E-01
1.37460E+03	7.96910E-01	2.74660E-01	2.18880E-01	9.30780E-01
1.37470E+03	7.99250E-01	2.74680E-01	2.19540E-01	9.33590E-01
1.37480E+03	8.01570E-01	2.74700E-01	2.20190E-01	9.36380E-01
1.37490E+03	8.03880E-01	2.74730E-01	2.20850E-01	9.39150E-01
1.37500E+03	8.06160E-01	2.74750E-01	2.21490E-01	9.41890E-01
1.37510E+03	8.08410E-01	2.74770E-01	2.22130E-01	9.44620E-01
1.37520E+03	8.10630E-01	2.74800E-01	2.22760E-01	9.47300E-01
1.37530E+03	8.12800E-01	2.74830E-01	2.23380E-01	9.49920E-01
1.37540E+03	8.14910E-01	2.74870E-01	2.24000E-01	9.52550E-01
1.37550E+03	8.16960E-01	2.74920E-01	2.24600E-01	9.55120E-01
1.37560E+03	8.18950E-01	2.74970E-01	2.25190E-01	9.57620E-01
1.37570E+03	8.20860E-01	2.75020E-01	2.25760E-01	9.60030E-01
1.37580E+03	8.22690E-01	2.75080E-01	2.26300E-01	9.62350E-01
1.37590E+03	8.24440E-01	2.75130E-01	2.26830E-01	9.64580E-01
1.37600E+03	8.26090E-01	2.75180E-01	2.27320E-01	9.66690E-01
1.37610E+03	8.27660E-01	2.75230E-01	2.27790E-01	9.68700E-01
1.37620E+03	8.29130E-01	2.75280E-01	2.28240E-01	9.70590E-01
1.37630E+03	8.30500E-01	2.75330E-01	2.28660E-01	9.72370E-01
1.37640E+03	8.31770E-01	2.75380E-01	2.29050E-01	9.74030E-01
1.37650E+03	8.32940E-01	2.75430E-01	2.29410E-01	9.75580E-01
1.37660E+03	8.34010E-01	2.75480E-01	2.29750E-01	9.77010E-01

1.37670E+03	8.34990E-01	2.75520E-01	2.30060E-01	9.78330E-01
1.37680E+03	8.35860E-01	2.75570E-01	2.30340E-01	9.79530E-01
1.37690E+03	8.36640E-01	2.75620E-01	2.30600E-01	9.80620E-01
1.37700E+03	8.37320E-01	2.75670E-01	2.30830E-01	9.81590E-01
1.37710E+03	8.37900E-01	2.75720E-01	2.31030E-01	9.82440E-01
1.37720E+03	8.38380E-01	2.75770E-01	2.31200E-01	9.83180E-01
1.37730E+03	8.38760E-01	2.75820E-01	2.31350E-01	9.83810E-01
1.37740E+03	8.39050E-01	2.75870E-01	2.31470E-01	9.84310E-01
1.37750E+03	8.39220E-01	2.75920E-01	2.31560E-01	9.84690E-01
1.37760E+03	8.39300E-01	2.75970E-01	2.31620E-01	9.84950E-01
1.37770E+03	8.39260E-01	2.76010E-01	2.31650E-01	9.85080E-01
1.37780E+03	8.39100E-01	2.76060E-01	2.31640E-01	9.85070E-01
1.37790E+03	8.38820E-01	2.76110E-01	2.31610E-01	9.84910E-01
1.37800E+03	8.38420E-01	2.76160E-01	2.31540E-01	9.84610E-01
1.37810E+03	8.37880E-01	2.76220E-01	2.31440E-01	9.84190E-01
1.37820E+03	8.37200E-01	2.76280E-01	2.31300E-01	9.83600E-01
1.37830E+03	8.36370E-01	2.76330E-01	2.31120E-01	9.82830E-01
1.37840E+03	8.35400E-01	2.76390E-01	2.30900E-01	9.81890E-01
1.37850E+03	8.34260E-01	2.76450E-01	2.30630E-01	9.80750E-01
1.37860E+03	8.32950E-01	2.76510E-01	2.30320E-01	9.79420E-01
1.37870E+03	8.31470E-01	2.76560E-01	2.29950E-01	9.77880E-01
1.37880E+03	8.29820E-01	2.76620E-01	2.29540E-01	9.76140E-01
1.37890E+03	8.27980E-01	2.76680E-01	2.29080E-01	9.74180E-01
1.37900E+03	8.25950E-01	2.76740E-01	2.28570E-01	9.71990E-01
1.37910E+03	8.23730E-01	2.76790E-01	2.28000E-01	9.69590E-01
1.37920E+03	8.21320E-01	2.76850E-01	2.27380E-01	9.66930E-01
1.37930E+03	8.18710E-01	2.76860E-01	2.26670E-01	9.63920E-01
1.37940E+03	8.15900E-01	2.76880E-01	2.25910E-01	9.60670E-01
1.37950E+03	8.12890E-01	2.76900E-01	2.25090E-01	9.57190E-01
1.37960E+03	8.09670E-01	2.76920E-01	2.24210E-01	9.53460E-01
1.37970E+03	8.06240E-01	2.76940E-01	2.23280E-01	9.49490E-01
1.37980E+03	8.02610E-01	2.76950E-01	2.22290E-01	9.45270E-01
1.37990E+03	7.98770E-01	2.76970E-01	2.21230E-01	9.40800E-01
1.38000E+03	7.94710E-01	2.76990E-01	2.20120E-01	9.36080E-01
1.38010E+03	7.90430E-01	2.76980E-01	2.18930E-01	9.31020E-01
1.38020E+03	7.85940E-01	2.76970E-01	2.17680E-01	9.25700E-01
1.38030E+03	7.81230E-01	2.76970E-01	2.16370E-01	9.20130E-01
1.38040E+03	7.76290E-01	2.76960E-01	2.15000E-01	9.14290E-01
1.38050E+03	7.71130E-01	2.76950E-01	2.13570E-01	9.08190E-01
1.38060E+03	7.65740E-01	2.76940E-01	2.12070E-01	9.01820E-01
1.38070E+03	7.60120E-01	2.76930E-01	2.10500E-01	8.95170E-01
1.38080E+03	7.54260E-01	2.76930E-01	2.08880E-01	8.88250E-01
1.38090E+03	7.48170E-01	2.76920E-01	2.07180E-01	8.81050E-01

1.38100E+03	7.41840E-01	2.76910E-01	2.05420E-01	8.73560E-01
1.38110E+03	7.35270E-01	2.76900E-01	2.03600E-01	8.65810E-01
1.38120E+03	7.28460E-01	2.76870E-01	2.01690E-01	8.57680E-01
1.38130E+03	7.21410E-01	2.76830E-01	1.99710E-01	8.49250E-01
1.38140E+03	7.14120E-01	2.76790E-01	1.97660E-01	8.40540E-01
1.38150E+03	7.06590E-01	2.76740E-01	1.95540E-01	8.31560E-01
1.38160E+03	6.98830E-01	2.76700E-01	1.93370E-01	8.22290E-01
1.38170E+03	6.90830E-01	2.76660E-01	1.91120E-01	8.12750E-01
1.38180E+03	6.82600E-01	2.76620E-01	1.88820E-01	8.02950E-01
1.38190E+03	6.74150E-01	2.76570E-01	1.86450E-01	7.92880E-01
1.38200E+03	6.65470E-01	2.76530E-01	1.84020E-01	7.82560E-01
1.38210E+03	6.56580E-01	2.76470E-01	1.81530E-01	7.71940E-01
1.38220E+03	6.47480E-01	2.76410E-01	1.78970E-01	7.61070E-01
1.38230E+03	6.38180E-01	2.76350E-01	1.76360E-01	7.49980E-01
1.38240E+03	6.28690E-01	2.76290E-01	1.73700E-01	7.38660E-01
1.38250E+03	6.19010E-01	2.76230E-01	1.70990E-01	7.27120E-01
1.38260E+03	6.09140E-01	2.76170E-01	1.68230E-01	7.15380E-01
1.38270E+03	5.99110E-01	2.76110E-01	1.65420E-01	7.03450E-01
1.38280E+03	5.88910E-01	2.76050E-01	1.62570E-01	6.91320E-01
1.38290E+03	5.78570E-01	2.75990E-01	1.59680E-01	6.79030E-01
1.38300E+03	5.68080E-01	2.75930E-01	1.56750E-01	6.66570E-01
1.38310E+03	5.57450E-01	2.75860E-01	1.53780E-01	6.53950E-01
1.38320E+03	5.46710E-01	2.75790E-01	1.50780E-01	6.41180E-01
1.38330E+03	5.35850E-01	2.75720E-01	1.47750E-01	6.28290E-01
1.38340E+03	5.24900E-01	2.75650E-01	1.44690E-01	6.15290E-01
1.38350E+03	5.13850E-01	2.75580E-01	1.41610E-01	6.02190E-01
1.38360E+03	5.02740E-01	2.75510E-01	1.38510E-01	5.89010E-01
1.38370E+03	4.91560E-01	2.75440E-01	1.35400E-01	5.75770E-01
1.38380E+03	4.80340E-01	2.75370E-01	1.32270E-01	5.62490E-01
1.38390E+03	4.69090E-01	2.75300E-01	1.29140E-01	5.49180E-01
1.38400E+03	4.57830E-01	2.75230E-01	1.26010E-01	5.35860E-01
1.38410E+03	4.46570E-01	2.75130E-01	1.22870E-01	5.22490E-01
1.38420E+03	4.35330E-01	2.75030E-01	1.19730E-01	5.09160E-01
1.38430E+03	4.24130E-01	2.74930E-01	1.16610E-01	4.95870E-01
1.38440E+03	4.12980E-01	2.74830E-01	1.13500E-01	4.82660E-01
1.38450E+03	4.01900E-01	2.74730E-01	1.10420E-01	4.69540E-01
1.38460E+03	3.90910E-01	2.74630E-01	1.07360E-01	4.56530E-01
1.38470E+03	3.80020E-01	2.74530E-01	1.04330E-01	4.43650E-01
1.38480E+03	3.69240E-01	2.74430E-01	1.01330E-01	4.30920E-01
1.38490E+03	3.58600E-01	2.74330E-01	9.83760E-02	4.18340E-01
1.38500E+03	3.48100E-01	2.74230E-01	9.54610E-02	4.05950E-01
1.38510E+03	3.37760E-01	2.74140E-01	9.25920E-02	3.93750E-01
1.38520E+03	3.27580E-01	2.74040E-01	8.97700E-02	3.81750E-01

1.38530E+03	3.17580E-01	2.73940E-01	8.69980E-02	3.69960E-01
1.38540E+03	3.07750E-01	2.73850E-01	8.42770E-02	3.58390E-01
1.38550E+03	2.98110E-01	2.73750E-01	8.16090E-02	3.47040E-01
1.38560E+03	2.88660E-01	2.73660E-01	7.89940E-02	3.35920E-01
1.38570E+03	2.79410E-01	2.73560E-01	7.64350E-02	3.25040E-01
1.38580E+03	2.70340E-01	2.73470E-01	7.39290E-02	3.14390E-01
1.38590E+03	2.61470E-01	2.73370E-01	7.14790E-02	3.03970E-01
1.38600E+03	2.52800E-01	2.73270E-01	6.90840E-02	2.93780E-01
1.38610E+03	2.44320E-01	2.73200E-01	6.67470E-02	2.83840E-01
1.38620E+03	2.36030E-01	2.73120E-01	6.44630E-02	2.74130E-01
1.38630E+03	2.27930E-01	2.73040E-01	6.22320E-02	2.64640E-01
1.38640E+03	2.20010E-01	2.72960E-01	6.00540E-02	2.55380E-01
1.38650E+03	2.12280E-01	2.72880E-01	5.79280E-02	2.46340E-01
1.38660E+03	2.04740E-01	2.72800E-01	5.58530E-02	2.37520E-01
1.38670E+03	1.97380E-01	2.72720E-01	5.38300E-02	2.28910E-01
1.38680E+03	1.90200E-01	2.72650E-01	5.18570E-02	2.20520E-01
1.38690E+03	1.83200E-01	2.72570E-01	4.99360E-02	2.12350E-01
1.38700E+03	1.76390E-01	2.72480E-01	4.80640E-02	2.04390E-01
1.38710E+03	1.69760E-01	2.72390E-01	4.62430E-02	1.96650E-01
1.38720E+03	1.63320E-01	2.72300E-01	4.44730E-02	1.89120E-01
1.38730E+03	1.57060E-01	2.72220E-01	4.27550E-02	1.81820E-01
1.38740E+03	1.51000E-01	2.72130E-01	4.10900E-02	1.74740E-01
1.38750E+03	1.45120E-01	2.72040E-01	3.94770E-02	1.67880E-01
1.38760E+03	1.39430E-01	2.71950E-01	3.79170E-02	1.61240E-01
1.38770E+03	1.33930E-01	2.71870E-01	3.64100E-02	1.54830E-01
1.38780E+03	1.28620E-01	2.71780E-01	3.49560E-02	1.48650E-01
1.38790E+03	1.23500E-01	2.71690E-01	3.35540E-02	1.42690E-01
1.38800E+03	1.18570E-01	2.71600E-01	3.22050E-02	1.36950E-01
1.38810E+03	1.13830E-01	2.71490E-01	3.09040E-02	1.31420E-01
1.38820E+03	1.09270E-01	2.71380E-01	2.96540E-02	1.26110E-01
1.38830E+03	1.04890E-01	2.71270E-01	2.84550E-02	1.21000E-01
1.38840E+03	1.00690E-01	2.71160E-01	2.73030E-02	1.16110E-01
1.38850E+03	9.66550E-02	2.71050E-01	2.61980E-02	1.11410E-01
1.38860E+03	9.27830E-02	2.70940E-01	2.51390E-02	1.06900E-01
1.38870E+03	8.90690E-02	2.70830E-01	2.41230E-02	1.02580E-01
1.38880E+03	8.55050E-02	2.70720E-01	2.31480E-02	9.84370E-02
1.38890E+03	8.20840E-02	2.70610E-01	2.22120E-02	9.44590E-02
1.38900E+03	7.87990E-02	2.70490E-01	2.13140E-02	9.06390E-02
1.38910E+03	7.56430E-02	2.70370E-01	2.04520E-02	8.69720E-02
1.38920E+03	7.26110E-02	2.70260E-01	1.96240E-02	8.34500E-02
1.38930E+03	6.96960E-02	2.70140E-01	1.88280E-02	8.00650E-02
1.38940E+03	6.68930E-02	2.70020E-01	1.80630E-02	7.68120E-02
1.38950E+03	6.41970E-02	2.69910E-01	1.73270E-02	7.36850E-02

1.38960E+03	6.16050E-02	2.69790E-01	1.66200E-02	7.06790E-02
1.38970E+03	5.91130E-02	2.69670E-01	1.59410E-02	6.77900E-02
1.38980E+03	5.67180E-02	2.69560E-01	1.52890E-02	6.50150E-02
1.38990E+03	5.44170E-02	2.69440E-01	1.46620E-02	6.23510E-02
1.39000E+03	5.22100E-02	2.69320E-01	1.40610E-02	5.97960E-02
1.39010E+03	5.00950E-02	2.69190E-01	1.34850E-02	5.73440E-02
1.39020E+03	4.80690E-02	2.69050E-01	1.29330E-02	5.49970E-02
1.39030E+03	4.61320E-02	2.68910E-01	1.24050E-02	5.27540E-02
1.39040E+03	4.42830E-02	2.68770E-01	1.19020E-02	5.06130E-02
1.39050E+03	4.25190E-02	2.68630E-01	1.14220E-02	4.85720E-02
1.39060E+03	4.08380E-02	2.68490E-01	1.09650E-02	4.66280E-02
1.39070E+03	3.92380E-02	2.68360E-01	1.05300E-02	4.47780E-02
1.39080E+03	3.77160E-02	2.68220E-01	1.01160E-02	4.30190E-02
1.39090E+03	3.62680E-02	2.68090E-01	9.72300E-03	4.13470E-02
1.39100E+03	3.48910E-02	2.67950E-01	9.34910E-03	3.97570E-02
1.39110E+03	3.35790E-02	2.67820E-01	8.99320E-03	3.82440E-02
1.39120E+03	3.23280E-02	2.67690E-01	8.65400E-03	3.68010E-02
1.39130E+03	3.11330E-02	2.67560E-01	8.33010E-03	3.54240E-02
1.39140E+03	2.99900E-02	2.67430E-01	8.02030E-03	3.41060E-02
1.39150E+03	2.88930E-02	2.67300E-01	7.72310E-03	3.28430E-02
1.39160E+03	2.78380E-02	2.67170E-01	7.43740E-03	3.16280E-02
1.39170E+03	2.68200E-02	2.67040E-01	7.16200E-03	3.04560E-02
1.39180E+03	2.58360E-02	2.66910E-01	6.89580E-03	2.93240E-02
1.39190E+03	2.48820E-02	2.66780E-01	6.63800E-03	2.82280E-02
1.39200E+03	2.39570E-02	2.66650E-01	6.38800E-03	2.71650E-02
1.39210E+03	2.30580E-02	2.66530E-01	6.14570E-03	2.61340E-02
1.39220E+03	2.21850E-02	2.66410E-01	5.91040E-03	2.51340E-02
1.39230E+03	2.13370E-02	2.66300E-01	5.68210E-03	2.41630E-02
1.39240E+03	2.05160E-02	2.66180E-01	5.46110E-03	2.32230E-02
1.39250E+03	1.97230E-02	2.66060E-01	5.24750E-03	2.23150E-02
1.39260E+03	1.89580E-02	2.65950E-01	5.04190E-03	2.14410E-02
1.39270E+03	1.82250E-02	2.65830E-01	4.84490E-03	2.06030E-02
1.39280E+03	1.75250E-02	2.65720E-01	4.65690E-03	1.98040E-02
1.39290E+03	1.68610E-02	2.65610E-01	4.47860E-03	1.90450E-02
1.39300E+03	1.62340E-02	2.65500E-01	4.31030E-03	1.83290E-02
1.39310E+03	1.56460E-02	2.65400E-01	4.15240E-03	1.76580E-02
1.39320E+03	1.50970E-02	2.65290E-01	4.00520E-03	1.70320E-02
1.39330E+03	1.45890E-02	2.65180E-01	3.86870E-03	1.64520E-02
1.39340E+03	1.41200E-02	2.65070E-01	3.74270E-03	1.59160E-02
1.39350E+03	1.36880E-02	2.64970E-01	3.62690E-03	1.54230E-02
1.39360E+03	1.32920E-02	2.64860E-01	3.52060E-03	1.49710E-02
1.39370E+03	1.29290E-02	2.64750E-01	3.42300E-03	1.45560E-02
1.39380E+03	1.25950E-02	2.64640E-01	3.33310E-03	1.41740E-02

1.39390E+03	1.22850E-02	2.64540E-01	3.24980E-03	1.38200E-02
1.39400E+03	1.19950E-02	2.64430E-01	3.17180E-03	1.34880E-02
1.39410E+03	1.17190E-02	2.64320E-01	3.09750E-03	1.31720E-02
1.39420E+03	1.14530E-02	2.64200E-01	3.02590E-03	1.28680E-02
1.39430E+03	1.11920E-02	2.64080E-01	2.95550E-03	1.25680E-02
1.39440E+03	1.09300E-02	2.63970E-01	2.88520E-03	1.22690E-02
1.39450E+03	1.06640E-02	2.63850E-01	2.81380E-03	1.19660E-02
1.39460E+03	1.03910E-02	2.63740E-01	2.74060E-03	1.16540E-02
1.39470E+03	1.01080E-02	2.63640E-01	2.66490E-03	1.13330E-02
1.39480E+03	9.81350E-03	2.63550E-01	2.58630E-03	1.09980E-02
1.39490E+03	9.50700E-03	2.63460E-01	2.50470E-03	1.06510E-02
1.39500E+03	9.18900E-03	2.63370E-01	2.42010E-03	1.02910E-02
1.39510E+03	8.86120E-03	2.63280E-01	2.33300E-03	9.92090E-03
1.39520E+03	8.52610E-03	2.63190E-01	2.24400E-03	9.54250E-03
1.39530E+03	8.18690E-03	2.63100E-01	2.15400E-03	9.15980E-03
1.39540E+03	7.84770E-03	2.63010E-01	2.06400E-03	8.77730E-03
1.39550E+03	7.51260E-03	2.62920E-01	1.97520E-03	8.39980E-03
1.39560E+03	7.18640E-03	2.62840E-01	1.88890E-03	8.03240E-03
1.39570E+03	6.87370E-03	2.62750E-01	1.80600E-03	7.68020E-03
1.39580E+03	6.57880E-03	2.62660E-01	1.72800E-03	7.34830E-03
1.39590E+03	6.30560E-03	2.62570E-01	1.65570E-03	7.04080E-03
1.39600E+03	6.05750E-03	2.62490E-01	1.59000E-03	6.76150E-03
1.39610E+03	5.83700E-03	2.62370E-01	1.53150E-03	6.51260E-03
1.39620E+03	5.64570E-03	2.62260E-01	1.48060E-03	6.29640E-03
1.39630E+03	5.48410E-03	2.62150E-01	1.43760E-03	6.11350E-03
1.39640E+03	5.35190E-03	2.62030E-01	1.40240E-03	5.96350E-03
1.39650E+03	5.24740E-03	2.61920E-01	1.37440E-03	5.84460E-03
1.39660E+03	5.16840E-03	2.61820E-01	1.35320E-03	5.75450E-03
1.39670E+03	5.11140E-03	2.61740E-01	1.33790E-03	5.68930E-03
1.39680E+03	5.07250E-03	2.61660E-01	1.32730E-03	5.64420E-03
1.39690E+03	5.04700E-03	2.61580E-01	1.32020E-03	5.61420E-03
1.39700E+03	5.03010E-03	2.61500E-01	1.31540E-03	5.59370E-03
1.39710E+03	5.01680E-03	2.61430E-01	1.31150E-03	5.57720E-03
1.39720E+03	5.00210E-03	2.61350E-01	1.30730E-03	5.55930E-03
1.39730E+03	4.98150E-03	2.61270E-01	1.30150E-03	5.53480E-03
1.39740E+03	4.95110E-03	2.61190E-01	1.29320E-03	5.49920E-03
1.39750E+03	4.90720E-03	2.61110E-01	1.28140E-03	5.44900E-03
1.39760E+03	4.84760E-03	2.61040E-01	1.26540E-03	5.38120E-03
1.39770E+03	4.77050E-03	2.60960E-01	1.24490E-03	5.29400E-03
1.39780E+03	4.67550E-03	2.60880E-01	1.21980E-03	5.18700E-03
1.39790E+03	4.56290E-03	2.60800E-01	1.19000E-03	5.06050E-03
1.39800E+03	4.43400E-03	2.60730E-01	1.15610E-03	4.91630E-03
1.39810E+03	4.29120E-03	2.60720E-01	1.11880E-03	4.75770E-03

1.39820E+03	4.13760E-03	2.60700E-01	1.07870E-03	4.58710E-03
1.39830E+03	3.97680E-03	2.60680E-01	1.03670E-03	4.40850E-03
1.39840E+03	3.81280E-03	2.60670E-01	9.93880E-04	4.22650E-03
1.39850E+03	3.65010E-03	2.60660E-01	9.51440E-04	4.04600E-03
1.39860E+03	3.49310E-03	2.60690E-01	9.10610E-04	3.87240E-03
1.39870E+03	3.34580E-03	2.60720E-01	8.72330E-04	3.70960E-03
1.39880E+03	3.21230E-03	2.60750E-01	8.37610E-04	3.56190E-03
1.39890E+03	3.09560E-03	2.60780E-01	8.07280E-04	3.43300E-03
1.39900E+03	2.99850E-03	2.60810E-01	7.82060E-04	3.32570E-03
1.39910E+03	2.92260E-03	2.60840E-01	7.62350E-04	3.24190E-03
1.39920E+03	2.86890E-03	2.60870E-01	7.48400E-04	3.18260E-03
1.39930E+03	2.83700E-03	2.60900E-01	7.40180E-04	3.14760E-03
1.39940E+03	2.82610E-03	2.60930E-01	7.37420E-04	3.13590E-03
1.39950E+03	2.83400E-03	2.60960E-01	7.39570E-04	3.14500E-03
1.39960E+03	2.85820E-03	2.60990E-01	7.45950E-04	3.17220E-03
1.39970E+03	2.89490E-03	2.61020E-01	7.55620E-04	3.21330E-03
1.39980E+03	2.94010E-03	2.61050E-01	7.67530E-04	3.26390E-03
1.39990E+03	2.98950E-03	2.61080E-01	7.80500E-04	3.31910E-03
1.40000E+03	3.03840E-03	2.61110E-01	7.93340E-04	3.37370E-03
1.40010E+03	3.08190E-03	2.61100E-01	8.04700E-04	3.42200E-03
1.40020E+03	3.11580E-03	2.61100E-01	8.13530E-04	3.45950E-03
1.40030E+03	3.13570E-03	2.61090E-01	8.18710E-04	3.48160E-03
1.40040E+03	3.13810E-03	2.61090E-01	8.19330E-04	3.48420E-03
1.40050E+03	3.12000E-03	2.61110E-01	8.14660E-04	3.46430E-03
1.40060E+03	3.07930E-03	2.61130E-01	8.04080E-04	3.41940E-03
1.40070E+03	3.01460E-03	2.61140E-01	7.87230E-04	3.34770E-03
1.40080E+03	2.92550E-03	2.61160E-01	7.64040E-04	3.24910E-03
1.40090E+03	2.81270E-03	2.61180E-01	7.34630E-04	3.12400E-03
1.40100E+03	2.67760E-03	2.61200E-01	6.99400E-04	2.97420E-03
1.40110E+03	2.52260E-03	2.61220E-01	6.58950E-04	2.80220E-03
1.40120E+03	2.35080E-03	2.61240E-01	6.14120E-04	2.61150E-03
1.40130E+03	2.16590E-03	2.61260E-01	5.65850E-04	2.40630E-03
1.40140E+03	1.97230E-03	2.61280E-01	5.15310E-04	2.19140E-03
1.40150E+03	1.77460E-03	2.61300E-01	4.63690E-04	1.97190E-03
1.40160E+03	1.57770E-03	2.61320E-01	4.12290E-04	1.75330E-03
1.40170E+03	1.38660E-03	2.61340E-01	3.62380E-04	1.54100E-03
1.40180E+03	1.20610E-03	2.61360E-01	3.15230E-04	1.34050E-03
1.40190E+03	1.04060E-03	2.61380E-01	2.71990E-04	1.15660E-03
1.40200E+03	8.94310E-04	2.61400E-01	2.33770E-04	9.94100E-04
1.40210E+03	7.70620E-04	2.61420E-01	2.01460E-04	8.56710E-04
1.40220E+03	6.72500E-04	2.61450E-01	1.75830E-04	7.47710E-04
1.40230E+03	6.02020E-04	2.61480E-01	1.57420E-04	6.69420E-04
1.40240E+03	5.60600E-04	2.61500E-01	1.46600E-04	6.23410E-04

1.40250E+03	5.48680E-04	2.61510E-01	1.43490E-04	6.10180E-04
1.40260E+03	5.66110E-04	2.61530E-01	1.48050E-04	6.29590E-04
1.40270E+03	6.11650E-04	2.61540E-01	1.59970E-04	6.80270E-04
1.40280E+03	6.83530E-04	2.61550E-01	1.78780E-04	7.60250E-04
1.40290E+03	7.79160E-04	2.61560E-01	2.03800E-04	8.66660E-04
1.40300E+03	8.95500E-04	2.61570E-01	2.34240E-04	9.96110E-04
1.40310E+03	1.02890E-03	2.61590E-01	2.69150E-04	1.14450E-03
1.40320E+03	1.17560E-03	2.61600E-01	3.07540E-04	1.30780E-03
1.40330E+03	0.00000E+00	2.61610E-01	0.00000E+00	0.00000E+00
Channel 12				
Wavenumber	HIRS Filter Transmittance	Optical Element Transmittance	Product of the HIRS Filter and Optical Element Transmittances	Normalized Value of Column 4
1.49120E+03	0.00000E+00	2.50970E-01	0.00000E+00	0.00000E+00
1.49130E+03	1.51990E-04	2.50750E-01	3.81120E-05	2.16760E-04
1.49140E+03	3.04460E-04	2.50530E-01	7.62750E-05	4.33820E-04
1.49150E+03	5.34930E-04	2.50300E-01	1.33890E-04	7.61540E-04
1.49160E+03	7.92920E-04	2.50080E-01	1.98290E-04	1.12780E-03
1.49170E+03	1.06330E-03	2.49860E-01	2.65670E-04	1.51100E-03
1.49180E+03	1.33580E-03	2.49630E-01	3.33460E-04	1.89660E-03
1.49190E+03	1.60140E-03	2.49410E-01	3.99420E-04	2.27170E-03
1.49200E+03	1.85200E-03	2.49190E-01	4.61510E-04	2.62490E-03
1.49210E+03	2.08040E-03	2.48860E-01	5.17710E-04	2.94450E-03
1.49220E+03	2.28030E-03	2.48520E-01	5.66710E-04	3.22320E-03
1.49230E+03	1.91750E-03	2.48190E-01	4.75900E-04	2.70670E-03
1.49240E+03	2.01350E-03	2.47850E-01	4.99060E-04	2.83840E-03
1.49250E+03	2.09770E-03	2.47520E-01	5.19220E-04	2.95310E-03
1.49260E+03	2.16720E-03	2.47190E-01	5.35700E-04	3.04690E-03
1.49270E+03	2.22190E-03	2.46850E-01	5.48470E-04	3.11950E-03
1.49280E+03	2.26250E-03	2.46520E-01	5.57740E-04	3.17220E-03
1.49290E+03	2.29050E-03	2.46190E-01	5.63900E-04	3.20730E-03
1.49300E+03	2.30810E-03	2.45860E-01	5.67470E-04	3.22750E-03
1.49310E+03	2.31780E-03	2.45570E-01	5.69190E-04	3.23740E-03
1.49320E+03	2.32250E-03	2.45290E-01	5.69690E-04	3.24020E-03
1.49330E+03	2.32540E-03	2.45010E-01	5.69750E-04	3.24050E-03
1.49340E+03	2.32990E-03	2.44730E-01	5.70190E-04	3.24300E-03
1.49350E+03	2.33940E-03	2.44450E-01	5.71860E-04	3.25250E-03
1.49360E+03	2.35730E-03	2.44160E-01	5.75560E-04	3.27360E-03
1.49370E+03	2.38670E-03	2.43880E-01	5.82070E-04	3.31060E-03
1.49380E+03	2.43050E-03	2.43600E-01	5.92060E-04	3.36740E-03
1.49390E+03	2.49120E-03	2.43320E-01	6.06160E-04	3.44760E-03
1.49400E+03	2.57090E-03	2.43040E-01	6.24830E-04	3.55380E-03

1.49410E+03	2.67120E-03	2.42830E-01	6.48650E-04	3.68930E-03
1.49420E+03	2.79320E-03	2.42630E-01	6.77710E-04	3.85460E-03
1.49430E+03	2.93730E-03	2.42440E-01	7.12120E-04	4.05020E-03
1.49440E+03	3.10380E-03	2.42240E-01	7.51860E-04	4.27630E-03
1.49450E+03	3.29220E-03	2.42040E-01	7.96850E-04	4.53220E-03
1.49460E+03	3.50170E-03	2.41840E-01	8.46860E-04	4.81660E-03
1.49470E+03	3.73120E-03	2.41640E-01	9.01620E-04	5.12810E-03
1.49480E+03	3.97930E-03	2.41440E-01	9.60780E-04	5.46460E-03
1.49490E+03	4.24450E-03	2.41250E-01	1.02400E-03	5.82390E-03
1.49500E+03	4.52510E-03	2.41080E-01	1.09090E-03	6.20470E-03
1.49510E+03	4.81950E-03	2.40930E-01	1.16120E-03	6.60430E-03
1.49520E+03	5.12630E-03	2.40780E-01	1.23430E-03	7.02040E-03
1.49530E+03	5.44410E-03	2.40630E-01	1.31000E-03	7.45090E-03
1.49540E+03	5.77170E-03	2.40480E-01	1.38800E-03	7.89430E-03
1.49550E+03	6.10830E-03	2.40330E-01	1.46800E-03	8.34940E-03
1.49560E+03	6.45320E-03	2.40180E-01	1.54990E-03	8.81540E-03
1.49570E+03	6.80620E-03	2.40030E-01	1.63370E-03	9.29180E-03
1.49580E+03	7.16740E-03	2.39880E-01	1.71930E-03	9.77880E-03
1.49590E+03	7.53730E-03	2.39730E-01	1.80690E-03	1.02770E-02
1.49600E+03	7.91650E-03	2.39580E-01	1.89660E-03	1.07870E-02
1.49610E+03	8.30620E-03	2.39490E-01	1.98930E-03	1.13140E-02
1.49620E+03	8.70760E-03	2.39410E-01	2.08460E-03	1.18570E-02
1.49630E+03	9.12220E-03	2.39320E-01	2.18310E-03	1.24170E-02
1.49640E+03	9.55160E-03	2.39230E-01	2.28510E-03	1.29970E-02
1.49650E+03	9.99770E-03	2.39150E-01	2.39090E-03	1.35990E-02
1.49660E+03	1.04620E-02	2.39060E-01	2.50110E-03	1.42250E-02
1.49670E+03	1.09470E-02	2.38970E-01	2.61600E-03	1.48790E-02
1.49680E+03	1.14530E-02	2.38890E-01	2.73600E-03	1.55610E-02
1.49690E+03	1.19820E-02	2.38780E-01	2.86120E-03	1.62730E-02
1.49700E+03	1.25370E-02	2.38650E-01	2.99190E-03	1.70170E-02
1.49710E+03	1.31170E-02	2.38510E-01	3.12850E-03	1.77940E-02
1.49720E+03	1.37240E-02	2.38380E-01	3.27140E-03	1.86070E-02
1.49730E+03	1.43590E-02	2.38240E-01	3.42080E-03	1.94560E-02
1.49740E+03	1.50220E-02	2.38110E-01	3.57680E-03	2.03430E-02
1.49750E+03	1.57150E-02	2.37970E-01	3.73960E-03	2.12690E-02
1.49760E+03	1.64370E-02	2.37830E-01	3.90920E-03	2.22340E-02
1.49770E+03	1.71890E-02	2.37700E-01	4.08580E-03	2.32380E-02
1.49780E+03	1.79720E-02	2.37560E-01	4.26950E-03	2.42830E-02
1.49790E+03	1.87860E-02	2.37430E-01	4.46030E-03	2.53690E-02
1.49800E+03	1.96320E-02	2.37290E-01	4.65850E-03	2.64950E-02
1.49810E+03	2.05100E-02	2.37150E-01	4.86410E-03	2.76650E-02
1.49820E+03	2.14210E-02	2.37020E-01	5.07730E-03	2.88780E-02
1.49830E+03	2.23670E-02	2.36880E-01	5.29840E-03	3.01350E-02

1.49840E+03	2.33480E-02	2.36750E-01	5.52770E-03	3.14390E-02
1.49850E+03	2.43660E-02	2.36610E-01	5.76540E-03	3.27910E-02
1.49860E+03	2.54230E-02	2.36480E-01	6.01190E-03	3.41930E-02
1.49870E+03	2.65200E-02	2.36340E-01	6.26770E-03	3.56480E-02
1.49880E+03	2.76590E-02	2.36180E-01	6.53250E-03	3.71540E-02
1.49890E+03	2.88420E-02	2.35940E-01	6.80490E-03	3.87040E-02
1.49900E+03	3.00720E-02	2.35690E-01	7.08780E-03	4.03130E-02
1.49910E+03	3.03960E-02	2.35440E-01	7.15650E-03	4.07030E-02
1.49920E+03	3.16610E-02	2.35200E-01	7.44650E-03	4.23530E-02
1.49930E+03	3.29830E-02	2.34950E-01	7.74930E-03	4.40750E-02
1.49940E+03	3.43650E-02	2.34700E-01	8.06560E-03	4.58740E-02
1.49950E+03	3.58120E-02	2.34460E-01	8.39640E-03	4.77560E-02
1.49960E+03	3.73260E-02	2.34210E-01	8.74230E-03	4.97230E-02
1.49970E+03	3.89110E-02	2.33970E-01	9.10380E-03	5.17790E-02
1.49980E+03	4.05680E-02	2.33720E-01	9.48150E-03	5.39270E-02
1.49990E+03	4.22990E-02	2.33470E-01	9.87560E-03	5.61690E-02
1.50000E+03	4.41050E-02	2.33220E-01	1.02860E-02	5.85050E-02
1.50010E+03	4.59870E-02	2.32950E-01	1.07130E-02	6.09300E-02
1.50020E+03	4.79450E-02	2.32680E-01	1.11560E-02	6.34500E-02
1.50030E+03	4.99810E-02	2.32400E-01	1.16160E-02	6.60660E-02
1.50040E+03	5.20930E-02	2.32130E-01	1.20920E-02	6.87770E-02
1.50050E+03	5.42840E-02	2.31860E-01	1.25860E-02	7.15840E-02
1.50060E+03	5.65530E-02	2.31580E-01	1.30970E-02	7.44890E-02
1.50070E+03	5.89020E-02	2.31310E-01	1.36250E-02	7.74920E-02
1.50080E+03	6.13340E-02	2.30980E-01	1.41670E-02	8.05750E-02
1.50090E+03	6.38520E-02	2.30640E-01	1.47270E-02	8.37600E-02
1.50100E+03	6.64590E-02	2.30300E-01	1.53050E-02	8.70520E-02
1.50110E+03	6.91610E-02	2.29960E-01	1.59040E-02	9.04570E-02
1.50120E+03	7.19640E-02	2.29620E-01	1.65240E-02	9.39840E-02
1.50130E+03	7.48750E-02	2.29280E-01	1.71680E-02	9.76420E-02
1.50140E+03	7.79030E-02	2.28940E-01	1.78350E-02	1.01440E-01
1.50150E+03	8.10570E-02	2.28600E-01	1.85300E-02	1.05390E-01
1.50160E+03	8.43480E-02	2.28270E-01	1.92540E-02	1.09510E-01
1.50170E+03	8.77840E-02	2.27930E-01	2.00090E-02	1.13800E-01
1.50180E+03	9.13790E-02	2.27590E-01	2.07970E-02	1.18290E-01
1.50190E+03	9.51430E-02	2.27250E-01	2.16210E-02	1.22970E-01
1.50200E+03	9.90860E-02	2.26920E-01	2.24840E-02	1.27880E-01
1.50210E+03	1.03220E-01	2.26550E-01	2.33840E-02	1.33000E-01
1.50220E+03	1.07550E-01	2.26180E-01	2.43260E-02	1.38360E-01
1.50230E+03	1.12090E-01	2.25810E-01	2.53120E-02	1.43960E-01
1.50240E+03	1.16850E-01	2.25450E-01	2.63430E-02	1.49830E-01
1.50250E+03	1.21820E-01	2.25080E-01	2.74200E-02	1.55950E-01
1.50260E+03	1.27020E-01	2.24720E-01	2.85440E-02	1.62350E-01

1.50270E+03	1.32440E-01	2.24370E-01	2.97160E-02	1.69010E-01
1.50280E+03	1.38100E-01	2.24020E-01	3.09360E-02	1.75950E-01
1.50290E+03	1.43970E-01	2.23680E-01	3.22030E-02	1.83160E-01
1.50300E+03	1.50060E-01	2.23340E-01	3.35140E-02	1.90610E-01
1.50310E+03	1.56360E-01	2.23000E-01	3.48680E-02	1.98320E-01
1.50320E+03	1.62870E-01	2.22660E-01	3.62640E-02	2.06260E-01
1.50330E+03	1.69570E-01	2.22320E-01	3.76990E-02	2.14420E-01
1.50340E+03	1.76460E-01	2.21980E-01	3.91700E-02	2.22780E-01
1.50350E+03	1.83520E-01	2.21640E-01	4.06750E-02	2.31340E-01
1.50360E+03	1.90740E-01	2.21300E-01	4.22110E-02	2.40080E-01
1.50370E+03	1.98120E-01	2.20960E-01	4.37750E-02	2.48980E-01
1.50380E+03	2.05620E-01	2.20620E-01	4.53650E-02	2.58020E-01
1.50390E+03	2.13260E-01	2.20280E-01	4.69770E-02	2.67190E-01
1.50400E+03	2.21010E-01	2.19940E-01	4.86090E-02	2.76470E-01
1.50410E+03	2.28860E-01	2.19650E-01	5.02680E-02	2.85910E-01
1.50420E+03	2.36810E-01	2.19360E-01	5.19450E-02	2.95440E-01
1.50430E+03	2.44850E-01	2.19060E-01	5.36370E-02	3.05070E-01
1.50440E+03	2.52970E-01	2.18770E-01	5.53430E-02	3.14770E-01
1.50450E+03	2.61170E-01	2.18480E-01	5.70610E-02	3.24540E-01
1.50460E+03	2.69450E-01	2.18210E-01	5.87960E-02	3.34410E-01
1.50470E+03	2.77800E-01	2.17980E-01	6.05550E-02	3.44410E-01
1.50480E+03	2.86230E-01	2.17750E-01	6.23260E-02	3.54490E-01
1.50490E+03	2.94740E-01	2.17520E-01	6.41110E-02	3.64640E-01
1.50500E+03	3.03330E-01	2.17280E-01	6.59100E-02	3.74870E-01
1.50510E+03	3.12010E-01	2.17050E-01	6.77220E-02	3.85180E-01
1.50520E+03	3.20770E-01	2.16820E-01	6.95490E-02	3.95570E-01
1.50530E+03	3.29620E-01	2.16590E-01	7.13910E-02	4.06050E-01
1.50540E+03	3.38560E-01	2.16360E-01	7.32490E-02	4.16610E-01
1.50550E+03	3.47600E-01	2.16120E-01	7.51240E-02	4.27280E-01
1.50560E+03	3.56730E-01	2.15890E-01	7.70150E-02	4.38030E-01
1.50570E+03	3.65950E-01	2.15660E-01	7.89220E-02	4.48880E-01
1.50580E+03	3.75270E-01	2.15430E-01	8.08440E-02	4.59810E-01
1.50590E+03	3.84680E-01	2.15200E-01	8.27820E-02	4.70830E-01
1.50600E+03	3.94170E-01	2.14970E-01	8.47320E-02	4.81930E-01
1.50610E+03	4.03730E-01	2.14790E-01	8.67180E-02	4.93220E-01
1.50620E+03	4.13350E-01	2.14620E-01	8.87140E-02	5.04570E-01
1.50630E+03	4.23030E-01	2.14450E-01	9.07190E-02	5.15970E-01
1.50640E+03	4.32740E-01	2.14280E-01	9.27280E-02	5.27400E-01
1.50650E+03	4.42480E-01	2.14110E-01	9.47380E-02	5.38830E-01
1.50660E+03	4.52220E-01	2.14030E-01	9.67880E-02	5.50500E-01
1.50670E+03	4.61960E-01	2.13950E-01	9.88350E-02	5.62140E-01
1.50680E+03	4.71660E-01	2.13870E-01	1.00870E-01	5.73730E-01
1.50690E+03	4.81310E-01	2.13790E-01	1.02900E-01	5.85260E-01

1.50700E+03	4.90900E-01	2.13710E-01	1.04910E-01	5.96690E-01
1.50710E+03	5.00410E-01	2.13630E-01	1.06900E-01	6.08010E-01
1.50720E+03	5.09800E-01	2.13550E-01	1.08870E-01	6.19200E-01
1.50730E+03	5.19080E-01	2.13470E-01	1.10810E-01	6.30230E-01
1.50740E+03	5.28220E-01	2.13390E-01	1.12720E-01	6.41080E-01
1.50750E+03	5.37210E-01	2.13310E-01	1.14590E-01	6.51750E-01
1.50760E+03	5.46040E-01	2.13220E-01	1.16430E-01	6.62210E-01
1.50770E+03	5.54690E-01	2.13140E-01	1.18230E-01	6.72440E-01
1.50780E+03	5.63160E-01	2.13060E-01	1.19990E-01	6.82450E-01
1.50790E+03	5.71430E-01	2.12980E-01	1.21710E-01	6.92210E-01
1.50800E+03	5.79510E-01	2.12900E-01	1.23380E-01	7.01730E-01
1.50810E+03	5.87380E-01	2.12820E-01	1.25010E-01	7.11000E-01
1.50820E+03	5.95050E-01	2.12740E-01	1.26590E-01	7.20010E-01
1.50830E+03	6.02500E-01	2.12660E-01	1.28130E-01	7.28760E-01
1.50840E+03	6.09750E-01	2.12580E-01	1.29620E-01	7.37250E-01
1.50850E+03	6.16790E-01	2.12600E-01	1.31130E-01	7.45820E-01
1.50860E+03	6.23610E-01	2.12660E-01	1.32620E-01	7.54290E-01
1.50870E+03	6.30240E-01	2.12720E-01	1.34060E-01	7.62510E-01
1.50880E+03	6.36650E-01	2.12780E-01	1.35470E-01	7.70490E-01
1.50890E+03	6.42870E-01	2.12840E-01	1.36830E-01	7.78230E-01
1.50900E+03	6.48880E-01	2.12900E-01	1.38150E-01	7.85720E-01
1.50910E+03	6.54690E-01	2.12960E-01	1.39420E-01	7.92990E-01
1.50920E+03	6.60310E-01	2.13020E-01	1.40660E-01	8.00020E-01
1.50930E+03	6.65730E-01	2.13080E-01	1.41850E-01	8.06820E-01
1.50940E+03	6.70960E-01	2.13140E-01	1.43010E-01	8.13380E-01
1.50950E+03	6.76000E-01	2.13200E-01	1.44120E-01	8.19720E-01
1.50960E+03	6.80840E-01	2.13260E-01	1.45200E-01	8.25820E-01
1.50970E+03	6.85490E-01	2.13320E-01	1.46230E-01	8.31700E-01
1.50980E+03	6.89960E-01	2.13380E-01	1.47220E-01	8.37350E-01
1.50990E+03	6.94230E-01	2.13440E-01	1.48180E-01	8.42780E-01
1.51000E+03	6.98320E-01	2.13500E-01	1.49090E-01	8.47980E-01
1.51010E+03	7.02220E-01	2.13580E-01	1.49980E-01	8.53030E-01
1.51020E+03	7.05950E-01	2.13660E-01	1.50830E-01	8.57860E-01
1.51030E+03	7.09490E-01	2.13740E-01	1.51640E-01	8.62480E-01
1.51040E+03	7.12850E-01	2.13840E-01	1.52440E-01	8.67010E-01
1.51050E+03	7.16050E-01	2.13990E-01	1.53230E-01	8.71500E-01
1.51060E+03	7.19070E-01	2.14140E-01	1.53980E-01	8.75800E-01
1.51070E+03	7.21940E-01	2.14290E-01	1.54700E-01	8.79900E-01
1.51080E+03	7.24650E-01	2.14440E-01	1.55390E-01	8.83820E-01
1.51090E+03	7.27210E-01	2.14590E-01	1.56050E-01	8.87560E-01
1.51100E+03	7.29630E-01	2.14740E-01	1.56680E-01	8.91130E-01
1.51110E+03	7.31910E-01	2.14890E-01	1.57280E-01	8.94550E-01
1.51120E+03	7.34070E-01	2.15040E-01	1.57850E-01	8.97820E-01

1.51130E+03	7.36110E-01	2.15190E-01	1.58400E-01	9.00940E-01
1.51140E+03	7.38050E-01	2.15340E-01	1.58930E-01	9.03940E-01
1.51150E+03	7.39880E-01	2.15490E-01	1.59440E-01	9.06810E-01
1.51160E+03	7.41610E-01	2.15640E-01	1.59920E-01	9.09570E-01
1.51170E+03	7.43260E-01	2.15790E-01	1.60390E-01	9.12220E-01
1.51180E+03	7.44820E-01	2.15940E-01	1.60840E-01	9.14770E-01
1.51190E+03	7.46310E-01	2.16090E-01	1.61270E-01	9.17230E-01
1.51200E+03	7.47730E-01	2.16240E-01	1.61690E-01	9.19620E-01
1.51210E+03	7.49080E-01	2.16400E-01	1.62100E-01	9.21990E-01
1.51220E+03	7.50370E-01	2.16570E-01	1.62510E-01	9.24280E-01
1.51230E+03	7.51610E-01	2.16720E-01	1.62890E-01	9.26470E-01
1.51240E+03	7.52780E-01	2.16800E-01	1.63210E-01	9.28250E-01
1.51250E+03	7.53910E-01	2.16880E-01	1.63510E-01	9.29980E-01
1.51260E+03	7.54980E-01	2.16960E-01	1.63800E-01	9.31640E-01
1.51270E+03	7.56010E-01	2.17040E-01	1.64080E-01	9.33250E-01
1.51280E+03	7.56980E-01	2.17120E-01	1.64360E-01	9.34790E-01
1.51290E+03	7.57920E-01	2.17200E-01	1.64620E-01	9.36280E-01
1.51300E+03	7.58800E-01	2.17280E-01	1.64870E-01	9.37710E-01
1.51310E+03	7.59640E-01	2.17350E-01	1.65110E-01	9.39080E-01
1.51320E+03	7.60440E-01	2.17430E-01	1.65340E-01	9.40410E-01
1.51330E+03	7.61200E-01	2.17510E-01	1.65570E-01	9.41690E-01
1.51340E+03	7.61930E-01	2.17580E-01	1.65780E-01	9.42920E-01
1.51350E+03	7.62620E-01	2.17660E-01	1.65990E-01	9.44110E-01
1.51360E+03	7.63280E-01	2.17740E-01	1.66200E-01	9.45260E-01
1.51370E+03	7.63910E-01	2.17820E-01	1.66390E-01	9.46370E-01
1.51380E+03	7.64520E-01	2.17890E-01	1.66580E-01	9.47460E-01
1.51390E+03	7.65100E-01	2.17970E-01	1.66770E-01	9.48520E-01
1.51400E+03	7.65670E-01	2.18050E-01	1.66950E-01	9.49560E-01
1.51410E+03	7.66220E-01	2.18120E-01	1.67130E-01	9.50560E-01
1.51420E+03	7.66760E-01	2.18190E-01	1.67300E-01	9.51560E-01
1.51430E+03	7.67290E-01	2.18140E-01	1.67370E-01	9.51960E-01
1.51440E+03	7.67810E-01	2.18040E-01	1.67420E-01	9.52200E-01
1.51450E+03	7.68330E-01	2.17950E-01	1.67460E-01	9.52440E-01
1.51460E+03	7.68840E-01	2.17860E-01	1.67500E-01	9.52670E-01
1.51470E+03	7.69340E-01	2.17770E-01	1.67540E-01	9.52890E-01
1.51480E+03	7.69830E-01	2.17680E-01	1.67570E-01	9.53100E-01
1.51490E+03	7.70320E-01	2.17580E-01	1.67610E-01	9.53300E-01
1.51500E+03	7.70790E-01	2.17490E-01	1.67640E-01	9.53480E-01
1.51510E+03	7.71250E-01	2.17400E-01	1.67670E-01	9.53630E-01
1.51520E+03	7.71690E-01	2.17300E-01	1.67690E-01	9.53760E-01
1.51530E+03	7.72110E-01	2.17210E-01	1.67710E-01	9.53860E-01
1.51540E+03	7.72500E-01	2.17110E-01	1.67720E-01	9.53930E-01
1.51550E+03	7.72860E-01	2.17020E-01	1.67730E-01	9.53960E-01

1.51560E+03	7.73190E-01	2.16920E-01	1.67720E-01	9.53950E-01
1.51570E+03	7.73490E-01	2.16830E-01	1.67720E-01	9.53900E-01
1.51580E+03	7.73750E-01	2.16730E-01	1.67700E-01	9.53800E-01
1.51590E+03	7.73980E-01	2.16640E-01	1.67670E-01	9.53660E-01
1.51600E+03	7.74170E-01	2.16540E-01	1.67640E-01	9.53470E-01
1.51610E+03	7.74320E-01	2.16490E-01	1.67630E-01	9.53440E-01
1.51620E+03	7.74440E-01	2.16400E-01	1.67590E-01	9.53160E-01
1.51630E+03	7.74530E-01	2.16260E-01	1.67500E-01	9.52650E-01
1.51640E+03	7.74590E-01	2.16120E-01	1.67400E-01	9.52120E-01
1.51650E+03	7.74640E-01	2.15980E-01	1.67300E-01	9.51550E-01
1.51660E+03	7.74670E-01	2.15840E-01	1.67200E-01	9.50980E-01
1.51670E+03	7.74700E-01	2.15700E-01	1.67100E-01	9.50390E-01
1.51680E+03	7.74730E-01	2.15550E-01	1.67000E-01	9.49810E-01
1.51690E+03	7.74770E-01	2.15410E-01	1.66900E-01	9.49240E-01
1.51700E+03	7.74830E-01	2.15270E-01	1.66800E-01	9.48700E-01
1.51710E+03	7.74910E-01	2.15130E-01	1.66710E-01	9.48190E-01
1.51720E+03	7.75040E-01	2.15000E-01	1.66630E-01	9.47720E-01
1.51730E+03	7.75190E-01	2.14860E-01	1.66550E-01	9.47300E-01
1.51740E+03	7.75390E-01	2.14720E-01	1.66490E-01	9.46930E-01
1.51750E+03	7.75640E-01	2.14580E-01	1.66430E-01	9.46610E-01
1.51760E+03	7.75930E-01	2.14440E-01	1.66390E-01	9.46360E-01
1.51770E+03	7.76270E-01	2.14300E-01	1.66350E-01	9.46150E-01
1.51780E+03	7.76650E-01	2.14160E-01	1.66330E-01	9.46000E-01
1.51790E+03	7.77070E-01	2.14020E-01	1.66310E-01	9.45890E-01
1.51800E+03	7.77520E-01	2.13880E-01	1.66300E-01	9.45820E-01
1.51810E+03	7.78000E-01	2.13770E-01	1.66320E-01	9.45940E-01
1.51820E+03	7.78480E-01	2.13690E-01	1.66360E-01	9.46170E-01
1.51830E+03	7.78960E-01	2.13610E-01	1.66400E-01	9.46400E-01
1.51840E+03	7.79430E-01	2.13530E-01	1.66430E-01	9.46610E-01
1.51850E+03	7.79880E-01	2.13450E-01	1.66470E-01	9.46800E-01
1.51860E+03	7.80290E-01	2.13370E-01	1.66490E-01	9.46930E-01
1.51870E+03	7.80640E-01	2.13290E-01	1.66500E-01	9.47000E-01
1.51880E+03	7.80930E-01	2.13210E-01	1.66500E-01	9.47000E-01
1.51890E+03	7.81150E-01	2.13130E-01	1.66480E-01	9.46900E-01
1.51900E+03	7.81280E-01	2.13050E-01	1.66450E-01	9.46700E-01
1.51910E+03	7.81320E-01	2.12960E-01	1.66390E-01	9.46380E-01
1.51920E+03	7.81260E-01	2.12880E-01	1.66320E-01	9.45950E-01
1.51930E+03	7.81100E-01	2.12800E-01	1.66220E-01	9.45390E-01
1.51940E+03	7.80830E-01	2.12720E-01	1.66100E-01	9.44710E-01
1.51950E+03	7.80470E-01	2.12640E-01	1.65960E-01	9.43910E-01
1.51960E+03	7.80020E-01	2.12560E-01	1.65800E-01	9.43000E-01
1.51970E+03	7.79480E-01	2.12480E-01	1.65620E-01	9.41990E-01
1.51980E+03	7.78860E-01	2.12400E-01	1.65430E-01	9.40890E-01

1.51990E+03	7.78190E-01	2.12320E-01	1.65220E-01	9.39720E-01
1.52000E+03	7.77470E-01	2.12230E-01	1.65010E-01	9.38490E-01
1.52010E+03	7.76710E-01	2.12260E-01	1.64870E-01	9.37700E-01
1.52020E+03	7.75950E-01	2.12290E-01	1.64730E-01	9.36900E-01
1.52030E+03	7.75180E-01	2.12320E-01	1.64590E-01	9.36110E-01
1.52040E+03	7.74440E-01	2.12350E-01	1.64450E-01	9.35340E-01
1.52050E+03	7.73740E-01	2.12380E-01	1.64320E-01	9.34610E-01
1.52060E+03	7.73090E-01	2.12410E-01	1.64210E-01	9.33960E-01
1.52070E+03	7.72500E-01	2.12440E-01	1.64110E-01	9.33380E-01
1.52080E+03	7.72000E-01	2.12460E-01	1.64020E-01	9.32900E-01
1.52090E+03	7.71590E-01	2.12490E-01	1.63960E-01	9.32530E-01
1.52100E+03	7.71270E-01	2.12520E-01	1.63910E-01	9.32270E-01
1.52110E+03	7.71050E-01	2.12550E-01	1.63890E-01	9.32130E-01
1.52120E+03	7.70940E-01	2.12580E-01	1.63880E-01	9.32110E-01
1.52130E+03	7.70920E-01	2.12610E-01	1.63900E-01	9.32210E-01
1.52140E+03	7.71000E-01	2.12630E-01	1.63940E-01	9.32430E-01
1.52150E+03	7.71170E-01	2.12660E-01	1.64000E-01	9.32750E-01
1.52160E+03	7.71410E-01	2.12690E-01	1.64070E-01	9.33170E-01
1.52170E+03	7.71720E-01	2.12720E-01	1.64160E-01	9.33670E-01
1.52180E+03	7.72080E-01	2.12750E-01	1.64260E-01	9.34230E-01
1.52190E+03	7.72470E-01	2.12780E-01	1.64360E-01	9.34830E-01
1.52200E+03	7.72890E-01	2.12870E-01	1.64530E-01	9.35770E-01
1.52210E+03	7.73310E-01	2.13020E-01	1.64730E-01	9.36910E-01
1.52220E+03	7.73710E-01	2.13160E-01	1.64930E-01	9.38050E-01
1.52230E+03	7.74090E-01	2.13310E-01	1.65120E-01	9.39150E-01
1.52240E+03	7.74430E-01	2.13450E-01	1.65310E-01	9.40200E-01
1.52250E+03	7.74720E-01	2.13600E-01	1.65480E-01	9.41190E-01
1.52260E+03	7.74950E-01	2.13740E-01	1.65640E-01	9.42100E-01
1.52270E+03	7.75100E-01	2.13890E-01	1.65790E-01	9.42930E-01
1.52280E+03	7.75180E-01	2.14040E-01	1.65910E-01	9.43660E-01
1.52290E+03	7.75170E-01	2.14180E-01	1.66030E-01	9.44300E-01
1.52300E+03	7.75090E-01	2.14330E-01	1.66120E-01	9.44830E-01
1.52310E+03	7.74920E-01	2.14470E-01	1.66200E-01	9.45280E-01
1.52320E+03	7.74680E-01	2.14620E-01	1.66260E-01	9.45630E-01
1.52330E+03	7.74370E-01	2.14770E-01	1.66310E-01	9.45900E-01
1.52340E+03	7.73990E-01	2.14910E-01	1.66340E-01	9.46090E-01
1.52350E+03	7.73560E-01	2.15060E-01	1.66360E-01	9.46210E-01
1.52360E+03	7.73090E-01	2.15210E-01	1.66380E-01	9.46280E-01
1.52370E+03	7.72580E-01	2.15350E-01	1.66380E-01	9.46300E-01
1.52380E+03	7.72060E-01	2.15500E-01	1.66380E-01	9.46300E-01
1.52390E+03	7.71510E-01	2.15680E-01	1.66400E-01	9.46400E-01
1.52400E+03	7.70970E-01	2.15890E-01	1.66440E-01	9.46670E-01
1.52410E+03	7.70430E-01	2.16100E-01	1.66490E-01	9.46930E-01

1.52420E+03	7.69900E-01	2.16310E-01	1.66540E-01	9.47210E-01
1.52430E+03	7.69400E-01	2.16520E-01	1.66590E-01	9.47520E-01
1.52440E+03	7.68930E-01	2.16730E-01	1.66650E-01	9.47860E-01
1.52450E+03	7.68480E-01	2.16950E-01	1.66720E-01	9.48230E-01
1.52460E+03	7.68070E-01	2.17160E-01	1.66790E-01	9.48640E-01
1.52470E+03	7.67700E-01	2.17370E-01	1.66870E-01	9.49100E-01
1.52480E+03	7.67360E-01	2.17580E-01	1.66960E-01	9.49600E-01
1.52490E+03	7.67050E-01	2.17790E-01	1.67050E-01	9.50140E-01
1.52500E+03	7.66770E-01	2.18000E-01	1.67160E-01	9.50720E-01
1.52510E+03	7.66530E-01	2.18210E-01	1.67260E-01	9.51340E-01
1.52520E+03	7.66310E-01	2.18420E-01	1.67380E-01	9.51980E-01
1.52530E+03	7.66120E-01	2.18630E-01	1.67500E-01	9.52660E-01
1.52540E+03	7.65940E-01	2.18840E-01	1.67620E-01	9.53360E-01
1.52550E+03	7.65790E-01	2.19050E-01	1.67750E-01	9.54080E-01
1.52560E+03	7.65650E-01	2.19260E-01	1.67880E-01	9.54820E-01
1.52570E+03	7.65520E-01	2.19470E-01	1.68010E-01	9.55580E-01
1.52580E+03	7.65410E-01	2.19680E-01	1.68150E-01	9.56350E-01
1.52590E+03	7.65310E-01	2.19890E-01	1.68280E-01	9.57130E-01
1.52600E+03	7.65230E-01	2.20100E-01	1.68420E-01	9.57930E-01
1.52610E+03	7.65160E-01	2.20310E-01	1.68570E-01	9.58750E-01
1.52620E+03	7.65110E-01	2.20520E-01	1.68720E-01	9.59600E-01
1.52630E+03	7.65070E-01	2.20730E-01	1.68870E-01	9.60480E-01
1.52640E+03	7.65060E-01	2.20940E-01	1.69030E-01	9.61370E-01
1.52650E+03	7.65080E-01	2.21150E-01	1.69190E-01	9.62300E-01
1.52660E+03	7.65120E-01	2.21350E-01	1.69360E-01	9.63270E-01
1.52670E+03	7.65190E-01	2.21560E-01	1.69540E-01	9.64270E-01
1.52680E+03	7.65290E-01	2.21770E-01	1.69720E-01	9.65300E-01
1.52690E+03	7.65420E-01	2.21980E-01	1.69910E-01	9.66380E-01
1.52700E+03	7.65580E-01	2.22190E-01	1.70110E-01	9.67490E-01
1.52710E+03	7.65770E-01	2.22400E-01	1.70310E-01	9.68630E-01
1.52720E+03	7.65990E-01	2.22600E-01	1.70510E-01	9.69800E-01
1.52730E+03	7.66230E-01	2.22810E-01	1.70720E-01	9.71010E-01
1.52740E+03	7.66490E-01	2.23010E-01	1.70940E-01	9.72230E-01
1.52750E+03	7.66770E-01	2.23220E-01	1.71160E-01	9.73470E-01
1.52760E+03	7.67050E-01	2.23420E-01	1.71380E-01	9.74720E-01
1.52770E+03	7.67330E-01	2.23630E-01	1.71600E-01	9.75970E-01
1.52780E+03	7.67600E-01	2.23790E-01	1.71780E-01	9.77030E-01
1.52790E+03	7.67860E-01	2.23940E-01	1.71960E-01	9.78030E-01
1.52800E+03	7.68110E-01	2.24100E-01	1.72130E-01	9.79000E-01
1.52810E+03	7.68320E-01	2.24200E-01	1.72250E-01	9.79710E-01
1.52820E+03	7.68510E-01	2.24300E-01	1.72370E-01	9.80390E-01
1.52830E+03	7.68660E-01	2.24400E-01	1.72480E-01	9.81010E-01
1.52840E+03	7.68770E-01	2.24490E-01	1.72580E-01	9.81590E-01

1.52850E+03	7.68840E-01	2.24590E-01	1.72680E-01	9.82120E-01
1.52860E+03	7.68880E-01	2.24690E-01	1.72760E-01	9.82600E-01
1.52870E+03	7.68880E-01	2.24790E-01	1.72840E-01	9.83030E-01
1.52880E+03	7.68850E-01	2.24890E-01	1.72910E-01	9.83420E-01
1.52890E+03	7.68800E-01	2.24980E-01	1.72970E-01	9.83780E-01
1.52900E+03	7.68730E-01	2.25080E-01	1.73030E-01	9.84110E-01
1.52910E+03	7.68660E-01	2.25170E-01	1.73080E-01	9.84430E-01
1.52920E+03	7.68580E-01	2.25270E-01	1.73140E-01	9.84740E-01
1.52930E+03	7.68520E-01	2.25360E-01	1.73200E-01	9.85070E-01
1.52940E+03	7.68480E-01	2.25460E-01	1.73260E-01	9.85430E-01
1.52950E+03	7.68470E-01	2.25550E-01	1.73330E-01	9.85820E-01
1.52960E+03	7.68500E-01	2.25640E-01	1.73410E-01	9.86270E-01
1.52970E+03	7.68590E-01	2.25690E-01	1.73460E-01	9.86580E-01
1.52980E+03	7.68730E-01	2.25690E-01	1.73490E-01	9.86760E-01
1.52990E+03	7.68940E-01	2.25690E-01	1.73540E-01	9.87030E-01
1.53000E+03	7.69220E-01	2.25690E-01	1.73600E-01	9.87380E-01
1.53010E+03	7.69570E-01	2.25700E-01	1.73690E-01	9.87890E-01
1.53020E+03	7.69990E-01	2.25710E-01	1.73800E-01	9.88490E-01
1.53030E+03	7.70470E-01	2.25730E-01	1.73920E-01	9.89180E-01
1.53040E+03	7.71020E-01	2.25740E-01	1.74050E-01	9.89950E-01
1.53050E+03	7.71620E-01	2.25760E-01	1.74200E-01	9.90780E-01
1.53060E+03	7.72270E-01	2.25770E-01	1.74360E-01	9.91670E-01
1.53070E+03	7.72950E-01	2.25780E-01	1.74520E-01	9.92600E-01
1.53080E+03	7.73650E-01	2.25800E-01	1.74690E-01	9.93550E-01
1.53090E+03	7.74360E-01	2.25810E-01	1.74860E-01	9.94520E-01
1.53100E+03	7.75070E-01	2.25820E-01	1.75020E-01	9.95470E-01
1.53110E+03	7.75750E-01	2.25830E-01	1.75190E-01	9.96400E-01
1.53120E+03	7.76410E-01	2.25840E-01	1.75340E-01	9.97290E-01
1.53130E+03	7.77020E-01	2.25850E-01	1.75490E-01	9.98120E-01
1.53140E+03	7.77580E-01	2.25860E-01	1.75620E-01	9.98880E-01
1.53150E+03	7.78070E-01	2.25870E-01	1.75740E-01	9.99550E-01
1.53160E+03	7.78490E-01	2.25850E-01	1.75820E-01	1.00000E+00
1.53170E+03	7.78830E-01	2.25720E-01	1.75790E-01	9.99850E-01
1.53180E+03	7.79100E-01	2.25580E-01	1.75750E-01	9.99600E-01
1.53190E+03	7.79290E-01	2.25450E-01	1.75690E-01	9.99240E-01
1.53200E+03	7.79400E-01	2.25310E-01	1.75610E-01	9.98790E-01
1.53210E+03	7.79450E-01	2.25180E-01	1.75510E-01	9.98260E-01
1.53220E+03	7.79430E-01	2.25040E-01	1.75410E-01	9.97640E-01
1.53230E+03	7.79360E-01	2.24910E-01	1.75290E-01	9.96960E-01
1.53240E+03	7.79250E-01	2.24770E-01	1.75160E-01	9.96220E-01
1.53250E+03	7.79120E-01	2.24640E-01	1.75020E-01	9.95450E-01
1.53260E+03	7.78970E-01	2.24500E-01	1.74880E-01	9.94650E-01
1.53270E+03	7.78820E-01	2.24370E-01	1.74740E-01	9.93860E-01

1.53280E+03	7.78680E-01	2.24230E-01	1.74600E-01	9.93080E-01
1.53290E+03	7.78570E-01	2.24100E-01	1.74470E-01	9.92340E-01
1.53300E+03	7.78500E-01	2.23960E-01	1.74350E-01	9.91640E-01
1.53310E+03	7.78470E-01	2.23820E-01	1.74240E-01	9.91000E-01
1.53320E+03	7.78510E-01	2.23680E-01	1.74140E-01	9.90440E-01
1.53330E+03	7.78610E-01	2.23540E-01	1.74050E-01	9.89950E-01
1.53340E+03	7.78780E-01	2.23410E-01	1.73980E-01	9.89560E-01
1.53350E+03	7.79030E-01	2.23270E-01	1.73930E-01	9.89260E-01
1.53360E+03	7.79340E-01	2.23010E-01	1.73800E-01	9.88530E-01
1.53370E+03	7.79730E-01	2.22750E-01	1.73680E-01	9.87840E-01
1.53380E+03	7.80190E-01	2.22480E-01	1.73570E-01	9.87230E-01
1.53390E+03	7.80710E-01	2.22210E-01	1.73480E-01	9.86700E-01
1.53400E+03	7.81290E-01	2.21940E-01	1.73400E-01	9.86230E-01
1.53410E+03	7.81920E-01	2.21610E-01	1.73280E-01	9.85560E-01
1.53420E+03	7.82580E-01	2.21280E-01	1.73170E-01	9.84930E-01
1.53430E+03	7.83270E-01	2.20960E-01	1.73070E-01	9.84340E-01
1.53440E+03	7.83980E-01	2.20630E-01	1.72970E-01	9.83770E-01
1.53450E+03	7.84700E-01	2.20300E-01	1.72870E-01	9.83220E-01
1.53460E+03	7.85420E-01	2.19970E-01	1.72770E-01	9.82660E-01
1.53470E+03	7.86130E-01	2.19650E-01	1.72670E-01	9.82090E-01
1.53480E+03	7.86830E-01	2.19320E-01	1.72570E-01	9.81490E-01
1.53490E+03	7.87510E-01	2.18990E-01	1.72460E-01	9.80870E-01
1.53500E+03	7.88160E-01	2.18660E-01	1.72340E-01	9.80220E-01
1.53510E+03	7.88780E-01	2.18340E-01	1.72220E-01	9.79520E-01
1.53520E+03	7.89370E-01	2.18010E-01	1.72090E-01	9.78790E-01
1.53530E+03	7.89920E-01	2.17690E-01	1.71950E-01	9.78010E-01
1.53540E+03	7.90440E-01	2.17360E-01	1.71810E-01	9.77190E-01
1.53550E+03	7.90930E-01	2.17020E-01	1.71650E-01	9.76260E-01
1.53560E+03	7.91380E-01	2.16670E-01	1.71470E-01	9.75260E-01
1.53570E+03	7.91800E-01	2.16330E-01	1.71290E-01	9.74210E-01
1.53580E+03	7.92190E-01	2.15980E-01	1.71100E-01	9.73130E-01
1.53590E+03	7.92550E-01	2.15630E-01	1.70900E-01	9.72010E-01
1.53600E+03	7.92870E-01	2.15290E-01	1.70690E-01	9.70850E-01
1.53610E+03	7.93160E-01	2.14920E-01	1.70460E-01	9.69530E-01
1.53620E+03	7.93420E-01	2.14550E-01	1.70220E-01	9.68170E-01
1.53630E+03	7.93640E-01	2.14170E-01	1.69980E-01	9.66770E-01
1.53640E+03	7.93820E-01	2.13810E-01	1.69720E-01	9.65320E-01
1.53650E+03	7.93960E-01	2.13440E-01	1.69460E-01	9.63820E-01
1.53660E+03	7.94050E-01	2.13070E-01	1.69190E-01	9.62260E-01
1.53670E+03	7.94090E-01	2.12700E-01	1.68900E-01	9.60640E-01
1.53680E+03	7.94060E-01	2.12330E-01	1.68600E-01	9.58950E-01
1.53690E+03	7.93970E-01	2.11960E-01	1.68290E-01	9.57180E-01
1.53700E+03	7.93810E-01	2.11600E-01	1.67970E-01	9.55340E-01

1.53710E+03	7.93580E-01	2.11230E-01	1.67630E-01	9.53410E-01
1.53720E+03	7.93270E-01	2.10870E-01	1.67270E-01	9.51390E-01
1.53730E+03	7.92880E-01	2.10500E-01	1.66900E-01	9.49270E-01
1.53740E+03	7.92410E-01	2.10180E-01	1.66550E-01	9.47240E-01
1.53750E+03	7.91860E-01	2.09910E-01	1.66220E-01	9.45390E-01
1.53760E+03	7.91230E-01	2.09650E-01	1.65880E-01	9.43460E-01
1.53770E+03	7.90530E-01	2.09380E-01	1.65520E-01	9.41440E-01
1.53780E+03	7.89770E-01	2.09120E-01	1.65160E-01	9.39350E-01
1.53790E+03	7.88960E-01	2.08860E-01	1.64780E-01	9.37210E-01
1.53800E+03	7.88110E-01	2.08600E-01	1.64400E-01	9.35040E-01
1.53810E+03	7.87220E-01	2.08390E-01	1.64050E-01	9.33030E-01
1.53820E+03	7.86320E-01	2.08170E-01	1.63690E-01	9.31010E-01
1.53830E+03	7.85430E-01	2.07960E-01	1.63330E-01	9.28990E-01
1.53840E+03	7.84550E-01	2.07740E-01	1.62980E-01	9.26990E-01
1.53850E+03	7.83700E-01	2.07530E-01	1.62640E-01	9.25040E-01
1.53860E+03	7.82900E-01	2.07320E-01	1.62310E-01	9.23150E-01
1.53870E+03	7.82160E-01	2.07110E-01	1.61990E-01	9.21340E-01
1.53880E+03	7.81500E-01	2.06890E-01	1.61690E-01	9.19610E-01
1.53890E+03	7.80920E-01	2.06680E-01	1.61400E-01	9.17990E-01
1.53900E+03	7.80450E-01	2.06470E-01	1.61140E-01	9.16490E-01
1.53910E+03	7.80070E-01	2.06260E-01	1.60900E-01	9.15110E-01
1.53920E+03	7.79800E-01	2.06050E-01	1.60670E-01	9.13860E-01
1.53930E+03	7.79630E-01	2.05850E-01	1.60490E-01	9.12790E-01
1.53940E+03	7.79560E-01	2.05780E-01	1.60420E-01	9.12420E-01
1.53950E+03	7.79600E-01	2.05720E-01	1.60380E-01	9.12160E-01
1.53960E+03	7.79720E-01	2.05650E-01	1.60350E-01	9.12010E-01
1.53970E+03	7.79920E-01	2.05590E-01	1.60340E-01	9.11950E-01
1.53980E+03	7.80180E-01	2.05520E-01	1.60340E-01	9.11970E-01
1.53990E+03	7.80490E-01	2.05450E-01	1.60360E-01	9.12040E-01
1.54000E+03	7.80830E-01	2.05390E-01	1.60370E-01	9.12150E-01
1.54010E+03	7.81190E-01	2.05320E-01	1.60390E-01	9.12240E-01
1.54020E+03	7.81540E-01	2.05250E-01	1.60410E-01	9.12330E-01
1.54030E+03	7.81870E-01	2.05170E-01	1.60420E-01	9.12400E-01
1.54040E+03	7.82160E-01	2.05100E-01	1.60420E-01	9.12430E-01
1.54050E+03	7.82400E-01	2.05030E-01	1.60420E-01	9.12390E-01
1.54060E+03	7.82570E-01	2.04960E-01	1.60400E-01	9.12270E-01
1.54070E+03	7.82660E-01	2.04890E-01	1.60360E-01	9.12070E-01
1.54080E+03	7.82660E-01	2.04820E-01	1.60310E-01	9.11760E-01
1.54090E+03	7.82570E-01	2.04750E-01	1.60230E-01	9.11340E-01
1.54100E+03	7.82380E-01	2.04680E-01	1.60140E-01	9.10810E-01
1.54110E+03	7.82100E-01	2.04610E-01	1.60030E-01	9.10170E-01
1.54120E+03	7.81720E-01	2.04540E-01	1.59900E-01	9.09420E-01
1.54130E+03	7.81250E-01	2.04600E-01	1.59840E-01	9.09130E-01

1.54140E+03	7.80700E-01	2.04690E-01	1.59800E-01	9.08880E-01
1.54150E+03	7.80070E-01	2.04780E-01	1.59740E-01	9.08540E-01
1.54160E+03	7.79380E-01	2.04860E-01	1.59670E-01	9.08120E-01
1.54170E+03	7.78630E-01	2.04950E-01	1.59580E-01	9.07650E-01
1.54180E+03	7.77850E-01	2.05040E-01	1.59490E-01	9.07120E-01
1.54190E+03	7.77030E-01	2.05130E-01	1.59390E-01	9.06570E-01
1.54200E+03	7.76200E-01	2.05220E-01	1.59290E-01	9.05990E-01
1.54210E+03	7.75360E-01	2.05320E-01	1.59200E-01	9.05470E-01
1.54220E+03	7.74530E-01	2.05420E-01	1.59110E-01	9.04940E-01
1.54230E+03	7.73700E-01	2.05530E-01	1.59020E-01	9.04430E-01
1.54240E+03	7.72890E-01	2.05630E-01	1.58930E-01	9.03930E-01
1.54250E+03	7.72100E-01	2.05730E-01	1.58850E-01	9.03460E-01
1.54260E+03	7.71330E-01	2.05840E-01	1.58770E-01	9.03000E-01
1.54270E+03	7.70570E-01	2.05940E-01	1.58690E-01	9.02570E-01
1.54280E+03	7.69840E-01	2.06040E-01	1.58620E-01	9.02160E-01
1.54290E+03	7.69110E-01	2.06140E-01	1.58550E-01	9.01760E-01
1.54300E+03	7.68400E-01	2.06250E-01	1.58480E-01	9.01370E-01
1.54310E+03	7.67670E-01	2.06350E-01	1.58410E-01	9.00970E-01
1.54320E+03	7.66940E-01	2.06520E-01	1.58390E-01	9.00840E-01
1.54330E+03	7.66190E-01	2.06740E-01	1.58410E-01	9.00960E-01
1.54340E+03	7.65420E-01	2.06970E-01	1.58420E-01	9.01040E-01
1.54350E+03	7.64600E-01	2.07200E-01	1.58430E-01	9.01080E-01
1.54360E+03	7.63740E-01	2.07430E-01	1.58420E-01	9.01060E-01
1.54370E+03	7.62830E-01	2.07660E-01	1.58410E-01	9.00970E-01
1.54380E+03	7.61860E-01	2.07890E-01	1.58380E-01	9.00820E-01
1.54390E+03	7.60830E-01	2.08120E-01	1.58340E-01	9.00590E-01
1.54400E+03	7.59730E-01	2.08350E-01	1.58290E-01	9.00280E-01
1.54410E+03	7.58570E-01	2.08530E-01	1.58180E-01	8.99670E-01
1.54420E+03	7.57340E-01	2.08700E-01	1.58060E-01	8.98990E-01
1.54430E+03	7.56050E-01	2.08880E-01	1.57930E-01	8.98220E-01
1.54440E+03	7.54700E-01	2.09060E-01	1.57780E-01	8.97390E-01
1.54450E+03	7.53300E-01	2.09240E-01	1.57620E-01	8.96480E-01
1.54460E+03	7.51850E-01	2.09420E-01	1.57450E-01	8.95520E-01
1.54470E+03	7.50370E-01	2.09590E-01	1.57270E-01	8.94500E-01
1.54480E+03	7.48850E-01	2.09770E-01	1.57090E-01	8.93450E-01
1.54490E+03	7.47310E-01	2.09950E-01	1.56890E-01	8.92360E-01
1.54500E+03	7.45750E-01	2.10120E-01	1.56700E-01	8.91250E-01
1.54510E+03	7.44180E-01	2.10310E-01	1.56500E-01	8.90140E-01
1.54520E+03	7.42600E-01	2.10510E-01	1.56330E-01	8.89130E-01
1.54530E+03	7.41030E-01	2.10720E-01	1.56150E-01	8.88130E-01
1.54540E+03	7.39470E-01	2.10930E-01	1.55970E-01	8.87120E-01
1.54550E+03	7.37910E-01	2.11130E-01	1.55800E-01	8.86120E-01
1.54560E+03	7.36360E-01	2.11340E-01	1.55620E-01	8.85120E-01

1.54570E+03	7.34820E-01	2.11550E-01	1.55450E-01	8.84130E-01
1.54580E+03	7.33280E-01	2.11750E-01	1.55270E-01	8.83140E-01
1.54590E+03	7.31750E-01	2.11960E-01	1.55100E-01	8.82150E-01
1.54600E+03	7.30220E-01	2.12160E-01	1.54930E-01	8.81150E-01
1.54610E+03	7.28680E-01	2.12350E-01	1.54730E-01	8.80060E-01
1.54620E+03	7.27140E-01	2.12530E-01	1.54540E-01	8.78960E-01
1.54630E+03	7.25570E-01	2.12710E-01	1.54340E-01	8.77830E-01
1.54640E+03	7.23990E-01	2.12900E-01	1.54140E-01	8.76660E-01
1.54650E+03	7.22380E-01	2.13080E-01	1.53930E-01	8.75470E-01
1.54660E+03	7.20750E-01	2.13260E-01	1.53710E-01	8.74230E-01
1.54670E+03	7.19080E-01	2.13440E-01	1.53480E-01	8.72940E-01
1.54680E+03	7.17370E-01	2.13620E-01	1.53250E-01	8.71610E-01
1.54690E+03	7.15620E-01	2.13800E-01	1.53000E-01	8.70220E-01
1.54700E+03	7.13840E-01	2.13980E-01	1.52750E-01	8.68780E-01
1.54710E+03	7.12010E-01	2.14060E-01	1.52410E-01	8.66880E-01
1.54720E+03	7.10150E-01	2.14130E-01	1.52060E-01	8.64880E-01
1.54730E+03	7.08260E-01	2.14190E-01	1.51700E-01	8.62840E-01
1.54740E+03	7.06330E-01	2.14260E-01	1.51340E-01	8.60750E-01
1.54750E+03	7.04380E-01	2.14320E-01	1.50970E-01	8.58630E-01
1.54760E+03	7.02400E-01	2.14390E-01	1.50590E-01	8.56480E-01
1.54770E+03	7.00400E-01	2.14450E-01	1.50200E-01	8.54300E-01
1.54780E+03	6.98400E-01	2.14520E-01	1.49820E-01	8.52110E-01
1.54790E+03	6.96380E-01	2.14580E-01	1.49430E-01	8.49900E-01
1.54800E+03	6.94360E-01	2.14650E-01	1.49040E-01	8.47690E-01
1.54810E+03	6.92340E-01	2.14720E-01	1.48660E-01	8.45510E-01
1.54820E+03	6.90320E-01	2.14790E-01	1.48280E-01	8.43340E-01
1.54830E+03	6.88310E-01	2.14870E-01	1.47900E-01	8.41170E-01
1.54840E+03	6.86310E-01	2.14940E-01	1.47520E-01	8.39010E-01
1.54850E+03	6.84320E-01	2.15010E-01	1.47140E-01	8.36860E-01
1.54860E+03	6.82330E-01	2.15090E-01	1.46760E-01	8.34720E-01
1.54870E+03	6.80360E-01	2.15160E-01	1.46390E-01	8.32580E-01
1.54880E+03	6.78400E-01	2.15230E-01	1.46010E-01	8.30460E-01
1.54890E+03	6.76450E-01	2.15300E-01	1.45640E-01	8.28340E-01
1.54900E+03	6.74500E-01	2.15260E-01	1.45190E-01	8.25780E-01
1.54910E+03	6.72560E-01	2.15130E-01	1.44690E-01	8.22930E-01
1.54920E+03	6.70630E-01	2.15000E-01	1.44190E-01	8.20090E-01
1.54930E+03	6.68710E-01	2.14880E-01	1.43690E-01	8.17260E-01
1.54940E+03	6.66800E-01	2.14750E-01	1.43200E-01	8.14440E-01
1.54950E+03	6.64890E-01	2.14620E-01	1.42700E-01	8.11640E-01
1.54960E+03	6.63010E-01	2.14500E-01	1.42210E-01	8.08860E-01
1.54970E+03	6.61140E-01	2.14370E-01	1.41730E-01	8.06100E-01
1.54980E+03	6.59300E-01	2.14240E-01	1.41250E-01	8.03380E-01
1.54990E+03	6.57490E-01	2.14120E-01	1.40780E-01	8.00690E-01

1.55000E+03	6.55710E-01	2.13990E-01	1.40310E-01	7.98060E-01
1.55010E+03	6.53980E-01	2.13850E-01	1.39850E-01	7.95430E-01
1.55020E+03	6.52310E-01	2.13710E-01	1.39400E-01	7.92860E-01
1.55030E+03	6.50690E-01	2.13560E-01	1.38960E-01	7.90380E-01
1.55040E+03	6.49150E-01	2.13420E-01	1.38540E-01	7.87980E-01
1.55050E+03	6.47690E-01	2.13280E-01	1.38140E-01	7.85690E-01
1.55060E+03	6.46320E-01	2.13140E-01	1.37760E-01	7.83500E-01
1.55070E+03	6.45040E-01	2.13000E-01	1.37390E-01	7.81430E-01
1.55080E+03	6.43870E-01	2.12850E-01	1.37050E-01	7.79490E-01
1.55090E+03	6.42800E-01	2.12650E-01	1.36690E-01	7.77460E-01
1.55100E+03	6.41840E-01	2.12320E-01	1.36270E-01	7.75080E-01
1.55110E+03	6.40990E-01	2.11980E-01	1.35880E-01	7.72820E-01
1.55120E+03	6.40260E-01	2.11640E-01	1.35510E-01	7.70710E-01
1.55130E+03	6.39630E-01	2.11310E-01	1.35160E-01	7.68730E-01
1.55140E+03	6.39110E-01	2.10970E-01	1.34830E-01	7.66880E-01
1.55150E+03	6.38700E-01	2.10640E-01	1.34530E-01	7.65170E-01
1.55160E+03	6.38380E-01	2.10300E-01	1.34250E-01	7.63570E-01
1.55170E+03	6.38160E-01	2.09960E-01	1.33990E-01	7.62090E-01
1.55180E+03	6.38020E-01	2.09630E-01	1.33750E-01	7.60710E-01
1.55190E+03	6.37970E-01	2.09290E-01	1.33520E-01	7.59420E-01
1.55200E+03	6.37990E-01	2.08960E-01	1.33310E-01	7.58230E-01
1.55210E+03	6.38080E-01	2.08580E-01	1.33090E-01	7.56970E-01
1.55220E+03	6.38240E-01	2.08210E-01	1.32880E-01	7.55790E-01
1.55230E+03	6.38450E-01	2.07830E-01	1.32690E-01	7.54690E-01
1.55240E+03	6.38730E-01	2.07460E-01	1.32510E-01	7.53650E-01
1.55250E+03	6.39060E-01	2.07080E-01	1.32340E-01	7.52690E-01
1.55260E+03	6.39460E-01	2.06710E-01	1.32180E-01	7.51790E-01
1.55270E+03	6.39920E-01	2.06330E-01	1.32040E-01	7.50970E-01
1.55280E+03	6.40450E-01	2.05950E-01	1.31900E-01	7.50190E-01
1.55290E+03	6.41050E-01	2.05470E-01	1.31720E-01	7.49170E-01
1.55300E+03	6.41740E-01	2.05000E-01	1.31560E-01	7.48240E-01
1.55310E+03	6.42520E-01	2.04530E-01	1.31410E-01	7.47420E-01
1.55320E+03	6.43400E-01	2.04050E-01	1.31290E-01	7.46710E-01
1.55330E+03	6.44390E-01	2.03580E-01	1.31180E-01	7.46120E-01
1.55340E+03	6.45500E-01	2.03110E-01	1.31110E-01	7.45670E-01
1.55350E+03	6.46730E-01	2.02640E-01	1.31050E-01	7.45370E-01
1.55360E+03	6.48100E-01	2.02160E-01	1.31020E-01	7.45210E-01
1.55370E+03	6.49600E-01	2.01690E-01	1.31020E-01	7.45200E-01
1.55380E+03	6.51250E-01	2.01230E-01	1.31050E-01	7.45350E-01
1.55390E+03	6.53030E-01	2.00760E-01	1.31100E-01	7.45650E-01
1.55400E+03	6.54960E-01	2.00290E-01	1.31180E-01	7.46100E-01
1.55410E+03	6.57000E-01	1.99880E-01	1.31320E-01	7.46920E-01
1.55420E+03	6.59170E-01	1.99480E-01	1.31490E-01	7.47880E-01

1.55430E+03	6.61440E-01	1.99080E-01	1.31680E-01	7.48930E-01
1.55440E+03	6.63790E-01	1.98680E-01	1.31880E-01	7.50080E-01
1.55450E+03	6.66210E-01	1.98270E-01	1.32090E-01	7.51290E-01
1.55460E+03	6.68670E-01	1.97870E-01	1.32310E-01	7.52540E-01
1.55470E+03	6.71140E-01	1.97470E-01	1.32530E-01	7.53790E-01
1.55480E+03	6.73600E-01	1.97110E-01	1.32770E-01	7.55170E-01
1.55490E+03	6.76000E-01	1.96770E-01	1.33010E-01	7.56540E-01
1.55500E+03	6.78330E-01	1.96420E-01	1.33240E-01	7.57800E-01
1.55510E+03	6.80540E-01	1.96070E-01	1.33440E-01	7.58940E-01
1.55520E+03	6.82610E-01	1.95730E-01	1.33610E-01	7.59910E-01
1.55530E+03	6.84500E-01	1.95380E-01	1.33740E-01	7.60670E-01
1.55540E+03	6.86190E-01	1.95040E-01	1.33830E-01	7.61200E-01
1.55550E+03	6.87630E-01	1.94700E-01	1.33880E-01	7.61450E-01
1.55560E+03	6.88800E-01	1.94350E-01	1.33870E-01	7.61410E-01
1.55570E+03	6.89690E-01	1.94010E-01	1.33810E-01	7.61040E-01
1.55580E+03	6.90260E-01	1.93670E-01	1.33680E-01	7.60320E-01
1.55590E+03	6.90500E-01	1.93320E-01	1.33490E-01	7.59240E-01
1.55600E+03	6.90400E-01	1.92980E-01	1.33230E-01	7.57780E-01
1.55610E+03	6.89930E-01	1.92660E-01	1.32920E-01	7.56020E-01
1.55620E+03	6.89090E-01	1.92350E-01	1.32540E-01	7.53860E-01
1.55630E+03	6.87880E-01	1.92030E-01	1.32090E-01	7.51290E-01
1.55640E+03	6.86290E-01	1.91710E-01	1.31570E-01	7.48320E-01
1.55650E+03	6.84320E-01	1.91400E-01	1.30980E-01	7.44940E-01
1.55660E+03	6.81960E-01	1.91080E-01	1.30310E-01	7.41140E-01
1.55670E+03	6.79220E-01	1.90850E-01	1.29630E-01	7.37290E-01
1.55680E+03	6.76110E-01	1.90710E-01	1.28940E-01	7.33390E-01
1.55690E+03	6.72630E-01	1.90580E-01	1.28190E-01	7.29080E-01
1.55700E+03	6.68770E-01	1.90440E-01	1.27360E-01	7.24380E-01
1.55710E+03	6.64560E-01	1.90300E-01	1.26470E-01	7.19300E-01
1.55720E+03	6.59980E-01	1.90170E-01	1.25510E-01	7.13830E-01
1.55730E+03	6.55050E-01	1.90030E-01	1.24480E-01	7.07990E-01
1.55740E+03	6.49760E-01	1.89890E-01	1.23390E-01	7.01770E-01
1.55750E+03	6.44130E-01	1.89760E-01	1.22230E-01	6.95190E-01
1.55760E+03	6.38150E-01	1.89620E-01	1.21010E-01	6.88240E-01
1.55770E+03	6.31830E-01	1.89480E-01	1.19720E-01	6.80930E-01
1.55780E+03	6.25170E-01	1.89350E-01	1.18370E-01	6.73270E-01
1.55790E+03	6.18170E-01	1.89210E-01	1.16960E-01	6.65250E-01
1.55800E+03	6.10830E-01	1.89070E-01	1.15490E-01	6.56880E-01
1.55810E+03	6.03170E-01	1.88960E-01	1.13970E-01	6.48240E-01
1.55820E+03	5.95170E-01	1.88850E-01	1.12400E-01	6.39270E-01
1.55830E+03	5.86850E-01	1.88730E-01	1.10760E-01	6.29950E-01
1.55840E+03	5.78220E-01	1.88620E-01	1.09060E-01	6.20310E-01
1.55850E+03	5.69280E-01	1.88510E-01	1.07310E-01	6.10360E-01

1.55860E+03	5.60040E-01	1.88430E-01	1.05530E-01	6.00220E-01
1.55870E+03	5.50530E-01	1.88520E-01	1.03780E-01	5.90280E-01
1.55880E+03	5.40740E-01	1.88600E-01	1.01990E-01	5.80050E-01
1.55890E+03	5.30710E-01	1.88690E-01	1.00140E-01	5.69550E-01
1.55900E+03	5.20440E-01	1.88770E-01	9.82450E-02	5.58780E-01
1.55910E+03	5.09980E-01	1.88850E-01	9.63110E-02	5.47780E-01
1.55920E+03	4.99320E-01	1.88940E-01	9.43400E-02	5.36570E-01
1.55930E+03	4.88510E-01	1.89020E-01	9.23380E-02	5.25180E-01
1.55940E+03	4.77560E-01	1.89100E-01	9.03080E-02	5.13640E-01
1.55950E+03	4.66500E-01	1.89190E-01	8.82560E-02	5.01970E-01
1.55960E+03	4.55370E-01	1.89270E-01	8.61870E-02	4.90200E-01
1.55970E+03	4.44180E-01	1.89350E-01	8.41070E-02	4.78370E-01
1.55980E+03	4.32960E-01	1.89440E-01	8.20190E-02	4.66490E-01
1.55990E+03	4.21750E-01	1.89520E-01	7.99290E-02	4.54600E-01
1.56000E+03	4.10550E-01	1.89600E-01	7.78400E-02	4.42720E-01
1.56010E+03	3.99400E-01	1.89650E-01	7.57470E-02	4.30820E-01
1.56020E+03	3.88310E-01	1.89710E-01	7.36640E-02	4.18970E-01
1.56030E+03	3.77290E-01	1.89760E-01	7.15960E-02	4.07210E-01
1.56040E+03	3.66380E-01	1.89810E-01	6.95450E-02	3.95540E-01
1.56050E+03	3.55580E-01	1.89870E-01	6.75130E-02	3.83990E-01
1.56060E+03	3.44890E-01	1.90030E-01	6.55390E-02	3.72760E-01
1.56070E+03	3.34330E-01	1.90200E-01	6.35900E-02	3.61670E-01
1.56080E+03	3.23910E-01	1.90370E-01	6.16620E-02	3.50710E-01
1.56090E+03	3.13630E-01	1.90540E-01	5.97580E-02	3.39880E-01
1.56100E+03	3.03490E-01	1.90710E-01	5.78770E-02	3.29180E-01
1.56110E+03	2.93490E-01	1.90880E-01	5.60200E-02	3.18620E-01
1.56120E+03	2.83630E-01	1.91050E-01	5.41870E-02	3.08190E-01
1.56130E+03	2.73920E-01	1.91220E-01	5.23790E-02	2.97910E-01
1.56140E+03	2.64360E-01	1.91390E-01	5.05950E-02	2.87760E-01
1.56150E+03	2.54950E-01	1.91560E-01	4.88360E-02	2.77760E-01
1.56160E+03	2.45680E-01	1.91720E-01	4.71020E-02	2.67900E-01
1.56170E+03	2.36560E-01	1.91890E-01	4.53940E-02	2.58180E-01
1.56180E+03	2.27600E-01	1.92060E-01	4.37130E-02	2.48620E-01
1.56190E+03	2.18790E-01	1.92230E-01	4.20590E-02	2.39210E-01
1.56200E+03	2.10150E-01	1.92400E-01	4.04330E-02	2.29970E-01
1.56210E+03	2.01690E-01	1.92580E-01	3.88410E-02	2.20910E-01
1.56220E+03	1.93400E-01	1.92760E-01	3.72800E-02	2.12030E-01
1.56230E+03	1.85300E-01	1.92950E-01	3.57520E-02	2.03350E-01
1.56240E+03	1.77400E-01	1.93130E-01	3.42600E-02	1.94860E-01
1.56250E+03	1.69700E-01	1.93340E-01	3.28110E-02	1.86610E-01
1.56260E+03	1.62230E-01	1.93580E-01	3.14030E-02	1.78610E-01
1.56270E+03	1.54980E-01	1.93810E-01	3.00370E-02	1.70840E-01
1.56280E+03	1.47970E-01	1.94040E-01	2.87130E-02	1.63310E-01

1.56290E+03	1.41220E-01	1.94280E-01	2.74350E-02	1.56040E-01
1.56300E+03	1.34710E-01	1.94510E-01	2.62030E-02	1.49030E-01
1.56310E+03	1.28470E-01	1.94740E-01	2.50180E-02	1.42300E-01
1.56320E+03	1.22500E-01	1.94970E-01	2.38830E-02	1.35840E-01
1.56330E+03	1.16790E-01	1.95200E-01	2.27980E-02	1.29670E-01
1.56340E+03	1.11360E-01	1.95440E-01	2.17630E-02	1.23780E-01
1.56350E+03	1.06190E-01	1.95670E-01	2.07780E-02	1.18180E-01
1.56360E+03	1.01290E-01	1.95900E-01	1.98420E-02	1.12860E-01
1.56370E+03	9.66480E-02	1.96130E-01	1.89560E-02	1.07810E-01
1.56380E+03	9.22590E-02	1.96360E-01	1.81160E-02	1.03040E-01
1.56390E+03	8.81130E-02	1.96590E-01	1.73220E-02	9.85230E-02
1.56400E+03	8.41980E-02	1.96830E-01	1.65720E-02	9.42580E-02
1.56410E+03	8.05040E-02	1.97070E-01	1.58650E-02	9.02320E-02
1.56420E+03	7.70160E-02	1.97310E-01	1.51960E-02	8.64280E-02
1.56430E+03	7.37210E-02	1.97550E-01	1.45630E-02	8.28310E-02
1.56440E+03	7.06050E-02	1.97780E-01	1.39640E-02	7.94210E-02
1.56450E+03	6.76530E-02	1.97980E-01	1.33940E-02	7.61780E-02
1.56460E+03	6.48520E-02	1.98180E-01	1.28520E-02	7.30970E-02
1.56470E+03	6.21870E-02	1.98380E-01	1.23360E-02	7.01640E-02
1.56480E+03	5.96460E-02	1.98580E-01	1.18440E-02	6.73660E-02
1.56490E+03	5.72180E-02	1.98780E-01	1.13740E-02	6.46880E-02
1.56500E+03	5.48910E-02	1.98980E-01	1.09220E-02	6.21210E-02
1.56510E+03	5.26570E-02	1.99180E-01	1.04880E-02	5.96520E-02
1.56520E+03	5.05080E-02	1.99370E-01	1.00700E-02	5.72740E-02
1.56530E+03	4.84360E-02	1.99570E-01	9.66650E-03	5.49790E-02
1.56540E+03	4.64370E-02	1.99770E-01	9.27670E-03	5.27620E-02
1.56550E+03	4.45070E-02	1.99970E-01	8.89990E-03	5.06190E-02
1.56560E+03	4.26420E-02	2.00170E-01	8.53540E-03	4.85460E-02
1.56570E+03	4.08400E-02	2.00360E-01	8.18290E-03	4.65410E-02
1.56580E+03	3.91020E-02	2.00560E-01	7.84230E-03	4.46040E-02
1.56590E+03	3.74250E-02	2.00760E-01	7.51340E-03	4.27330E-02
1.56600E+03	3.58110E-02	2.00960E-01	7.19640E-03	4.09300E-02
1.56610E+03	3.42580E-02	2.01170E-01	6.89170E-03	3.91980E-02
1.56620E+03	3.27700E-02	2.01380E-01	6.59920E-03	3.75330E-02
1.56630E+03	3.13440E-02	2.01590E-01	6.31880E-03	3.59390E-02
1.56640E+03	3.11390E-02	2.01670E-01	6.27980E-03	3.57170E-02
1.56650E+03	2.98360E-02	2.01740E-01	6.01920E-03	3.42350E-02
1.56660E+03	2.85930E-02	2.01820E-01	5.77060E-03	3.28210E-02
1.56670E+03	2.74090E-02	2.01890E-01	5.53370E-03	3.14740E-02
1.56680E+03	2.62830E-02	2.01970E-01	5.30840E-03	3.01920E-02
1.56690E+03	2.52140E-02	2.02040E-01	5.09430E-03	2.89750E-02
1.56700E+03	2.42010E-02	2.02120E-01	4.89140E-03	2.78200E-02
1.56710E+03	2.32420E-02	2.02190E-01	4.69920E-03	2.67270E-02

1.56720E+03	2.23350E-02	2.02260E-01	4.51740E-03	2.56940E-02
1.56730E+03	2.14800E-02	2.02330E-01	4.34590E-03	2.47180E-02
1.56740E+03	2.06730E-02	2.02400E-01	4.18420E-03	2.37980E-02
1.56750E+03	1.99130E-02	2.02470E-01	4.03180E-03	2.29310E-02
1.56760E+03	1.91980E-02	2.02540E-01	3.88840E-03	2.21160E-02
1.56770E+03	1.85260E-02	2.02610E-01	3.75360E-03	2.13490E-02
1.56780E+03	1.78950E-02	2.02680E-01	3.62690E-03	2.06280E-02
1.56790E+03	1.73000E-02	2.02750E-01	3.50760E-03	1.99500E-02
1.56800E+03	1.67410E-02	2.02820E-01	3.39540E-03	1.93120E-02
1.56810E+03	1.62150E-02	2.02880E-01	3.28960E-03	1.87100E-02
1.56820E+03	1.57180E-02	2.02940E-01	3.18980E-03	1.81420E-02
1.56830E+03	1.52480E-02	2.02900E-01	3.09380E-03	1.75960E-02
1.56840E+03	1.48030E-02	2.02810E-01	3.00210E-03	1.70750E-02
1.56850E+03	1.43790E-02	2.02720E-01	2.91490E-03	1.65790E-02
1.56860E+03	1.39740E-02	2.02630E-01	2.83160E-03	1.61050E-02
1.56870E+03	1.35860E-02	2.02550E-01	2.75170E-03	1.56510E-02
1.56880E+03	1.32110E-02	2.02460E-01	2.67470E-03	1.52130E-02
1.56890E+03	1.28480E-02	2.02370E-01	2.60010E-03	1.47880E-02
1.56900E+03	1.24940E-02	2.02280E-01	2.52740E-03	1.43750E-02
1.56910E+03	1.21480E-02	2.02190E-01	2.45620E-03	1.39700E-02
1.56920E+03	1.18060E-02	2.02110E-01	2.38610E-03	1.35710E-02
1.56930E+03	1.14680E-02	2.02020E-01	2.31680E-03	1.31770E-02
1.56940E+03	1.11330E-02	2.01930E-01	2.24810E-03	1.27860E-02
1.56950E+03	1.07990E-02	2.01840E-01	2.17970E-03	1.23970E-02
1.56960E+03	1.04660E-02	2.01750E-01	2.11150E-03	1.20090E-02
1.56970E+03	1.01330E-02	2.01660E-01	2.04330E-03	1.16220E-02
1.56980E+03	9.79940E-03	2.01570E-01	1.97520E-03	1.12340E-02
1.56990E+03	9.46620E-03	2.01470E-01	1.90720E-03	1.08470E-02
1.57000E+03	9.13360E-03	2.01380E-01	1.83940E-03	1.04620E-02
1.57010E+03	8.80250E-03	2.01310E-01	1.77200E-03	1.00780E-02
1.57020E+03	8.47400E-03	2.01210E-01	1.70510E-03	9.69780E-03
1.57030E+03	8.14940E-03	2.01090E-01	1.63880E-03	9.32080E-03
1.57040E+03	7.83020E-03	2.00980E-01	1.57370E-03	8.95060E-03
1.57050E+03	7.51830E-03	2.00860E-01	1.51010E-03	8.58890E-03
1.57060E+03	7.21530E-03	2.00740E-01	1.44840E-03	8.23800E-03
1.57070E+03	6.92320E-03	2.00620E-01	1.38890E-03	7.89980E-03
1.57080E+03	6.64370E-03	2.00500E-01	1.33210E-03	7.57640E-03
1.57090E+03	6.37840E-03	2.00390E-01	1.27810E-03	7.26960E-03
1.57100E+03	6.12900E-03	2.00270E-01	1.22740E-03	6.98120E-03
1.57110E+03	5.89660E-03	2.00150E-01	1.18020E-03	6.71250E-03
1.57120E+03	5.68210E-03	2.00030E-01	1.13660E-03	6.46460E-03
1.57130E+03	5.48630E-03	1.99910E-01	1.09680E-03	6.23810E-03
1.57140E+03	5.30930E-03	1.99790E-01	1.06080E-03	6.03320E-03

1.57150E+03	5.15080E-03	1.99680E-01	1.02850E-03	5.84970E-03
1.57160E+03	5.01040E-03	1.99560E-01	9.99860E-04	5.68680E-03
1.57170E+03	4.88700E-03	1.99440E-01	9.74650E-04	5.54340E-03
1.57180E+03	4.77920E-03	1.99320E-01	9.52580E-04	5.41790E-03
1.57190E+03	4.68530E-03	1.99200E-01	9.33300E-04	5.30820E-03
1.57200E+03	4.60320E-03	1.99080E-01	9.16390E-04	5.21210E-03
1.57210E+03	4.53060E-03	1.98940E-01	9.01300E-04	5.12630E-03
1.57220E+03	4.46510E-03	1.98840E-01	8.87860E-04	5.04980E-03
1.57230E+03	4.40410E-03	1.98750E-01	8.75320E-04	4.97850E-03
1.57240E+03	4.34500E-03	1.98660E-01	8.63170E-04	4.90940E-03
1.57250E+03	4.28540E-03	1.98560E-01	8.50920E-04	4.83970E-03
1.57260E+03	4.22280E-03	1.98470E-01	8.38100E-04	4.76680E-03
1.57270E+03	4.15520E-03	1.98380E-01	8.24300E-04	4.68830E-03
1.57280E+03	4.08090E-03	1.98290E-01	8.09180E-04	4.60230E-03
1.57290E+03	3.99840E-03	1.98190E-01	7.92450E-04	4.50710E-03
1.57300E+03	3.90680E-03	1.98100E-01	7.73940E-04	4.40190E-03
1.57310E+03	3.80580E-03	1.98000E-01	7.53560E-04	4.28590E-03
1.57320E+03	3.69520E-03	1.97910E-01	7.31320E-04	4.15950E-03
1.57330E+03	3.57580E-03	1.97820E-01	7.07350E-04	4.02310E-03
1.57340E+03	3.44850E-03	1.97720E-01	6.81850E-04	3.87810E-03
1.57350E+03	3.31480E-03	1.97630E-01	6.55100E-04	3.72600E-03
1.57360E+03	3.17660E-03	1.97530E-01	6.27480E-04	3.56890E-03
1.57370E+03	3.03590E-03	1.97440E-01	5.99400E-04	3.40920E-03
1.57380E+03	2.89510E-03	1.97350E-01	5.71330E-04	3.24950E-03
1.57390E+03	2.75650E-03	1.97250E-01	5.43730E-04	3.09250E-03
1.57400E+03	2.62260E-03	1.97160E-01	5.17070E-04	2.94090E-03
1.57410E+03	2.49560E-03	1.97120E-01	4.91920E-04	2.79790E-03
1.57420E+03	2.37750E-03	1.97090E-01	4.68570E-04	2.66500E-03
1.57430E+03	2.27010E-03	1.97050E-01	4.47330E-04	2.54420E-03
1.57440E+03	2.17480E-03	1.97020E-01	4.28490E-04	2.43710E-03
1.57450E+03	2.09260E-03	1.96990E-01	4.12230E-04	2.34460E-03
1.57460E+03	2.02410E-03	1.96960E-01	3.98650E-04	2.26740E-03
1.57470E+03	1.96910E-03	1.96920E-01	3.87760E-04	2.20540E-03
1.57480E+03	1.92720E-03	1.96890E-01	3.79440E-04	2.15810E-03
1.57490E+03	1.89730E-03	1.96860E-01	3.73490E-04	2.12430E-03
1.57500E+03	1.87790E-03	1.96820E-01	3.69620E-04	2.10230E-03
1.57510E+03	1.86720E-03	1.96790E-01	3.67440E-04	2.08990E-03
1.57520E+03	1.86270E-03	1.96760E-01	3.66510E-04	2.08450E-03
1.57530E+03	1.86200E-03	1.96720E-01	3.66310E-04	2.08340E-03
1.57540E+03	1.86240E-03	1.96690E-01	3.66300E-04	2.08340E-03
1.57550E+03	1.86090E-03	1.96650E-01	3.65950E-04	2.08140E-03
1.57560E+03	1.85490E-03	1.96620E-01	3.64710E-04	2.07430E-03
1.57570E+03	1.84180E-03	1.96590E-01	3.62060E-04	2.05930E-03

1.57580E+03	1.81930E-03	1.96550E-01	3.57580E-04	2.03380E-03
1.57590E+03	1.78560E-03	1.96520E-01	3.50890E-04	1.99570E-03
1.57600E+03	1.73920E-03	1.96500E-01	3.41760E-04	1.94380E-03
1.57610E+03	1.67940E-03	1.96520E-01	3.30040E-04	1.87710E-03
1.57620E+03	1.60630E-03	1.96530E-01	3.15680E-04	1.79550E-03
1.57630E+03	1.53020E-03	1.96540E-01	3.00750E-04	1.71060E-03
1.57640E+03	1.45690E-03	1.96550E-01	2.86360E-04	1.62870E-03
1.57650E+03	1.38440E-03	1.96560E-01	2.72130E-04	1.54780E-03
1.57660E+03	1.31100E-03	1.96570E-01	2.57710E-04	1.46570E-03
1.57670E+03	1.23490E-03	1.96580E-01	2.42760E-04	1.38070E-03
1.57680E+03	1.15470E-03	1.96590E-01	2.27000E-04	1.29110E-03
1.57690E+03	1.06930E-03	1.96600E-01	2.10220E-04	1.19560E-03
1.57700E+03	9.77960E-04	1.96610E-01	1.92280E-04	1.09360E-03
1.57710E+03	8.81110E-04	1.96620E-01	1.73250E-04	9.85360E-04
1.57720E+03	8.83430E-05	1.96630E-01	1.73710E-05	9.88000E-05
1.57730E+03	1.15680E-04	1.96640E-01	2.27480E-05	1.29380E-04
1.57740E+03	2.70770E-04	1.96650E-01	5.32480E-05	3.02860E-04
1.57750E+03	3.90680E-04	1.96660E-01	7.68330E-05	4.37000E-04
1.57760E+03	4.68760E-04	1.96670E-01	9.21920E-05	5.24350E-04
1.57770E+03	5.01680E-04	1.96680E-01	9.86720E-05	5.61210E-04
1.57780E+03	4.88160E-04	1.96690E-01	9.60170E-05	5.46110E-04
1.57790E+03	4.29130E-04	1.96710E-01	8.44150E-05	4.80120E-04
1.57800E+03	3.29010E-04	1.96760E-01	6.47370E-05	3.68200E-04
1.57810E+03	2.04240E-04	1.96780E-01	4.01900E-05	2.28590E-04
1.57820E+03	0.00000E+00	1.96790E-01	0.00000E+00	0.00000E+00

Channel 13

Wavenumber	HIRS Filter Transmittance	Optical Element Transmittance	Product of the HIRS Filter and Optical Element Transmittances	Normalized Value of Column 4
2.16170E+03	0.00000E+00	5.90390E-01	0.00000E+00	0.00000E+00
2.16180E+03	1.49510E-04	5.90510E-01	8.82860E-05	2.14160E-04
2.16190E+03	3.33330E-04	5.90640E-01	1.96880E-04	4.77580E-04
2.16200E+03	5.56540E-04	5.90760E-01	3.28780E-04	7.97550E-04
2.16210E+03	7.44030E-04	5.90850E-01	4.39610E-04	1.06640E-03
2.16220E+03	8.73440E-04	5.90940E-01	5.16150E-04	1.25200E-03
2.16230E+03	9.30410E-04	5.91030E-01	5.49900E-04	1.33390E-03
2.16240E+03	9.05880E-04	5.91120E-01	5.35480E-04	1.29890E-03
2.16250E+03	7.96390E-04	5.91210E-01	4.70830E-04	1.14210E-03
2.16260E+03	6.04950E-04	5.91290E-01	3.57700E-04	8.67700E-04
2.16270E+03	3.44530E-04	5.91380E-01	2.03750E-04	4.94250E-04
2.16280E+03	1.23150E-03	5.91470E-01	7.28420E-04	1.76700E-03
2.16290E+03	1.36100E-03	5.91560E-01	8.05100E-04	1.95300E-03

2.16300E+03	1.47780E-03	5.91650E-01	8.74360E-04	2.12100E-03
2.16310E+03	1.57840E-03	5.91740E-01	9.33990E-04	2.26560E-03
2.16320E+03	1.66320E-03	5.91840E-01	9.84320E-04	2.38770E-03
2.16330E+03	1.73470E-03	5.91930E-01	1.02680E-03	2.49080E-03
2.16340E+03	1.79670E-03	5.92020E-01	1.06370E-03	2.58030E-03
2.16350E+03	1.85420E-03	5.92110E-01	1.09790E-03	2.66330E-03
2.16360E+03	1.91290E-03	5.92200E-01	1.13280E-03	2.74800E-03
2.16370E+03	1.97870E-03	5.92300E-01	1.17200E-03	2.84300E-03
2.16380E+03	2.05740E-03	5.92390E-01	1.21880E-03	2.95650E-03
2.16390E+03	2.14950E-03	5.92480E-01	1.27350E-03	3.08930E-03
2.16400E+03	2.23360E-03	5.92570E-01	1.32360E-03	3.21060E-03
2.16410E+03	2.30700E-03	5.92630E-01	1.36720E-03	3.31640E-03
2.16420E+03	2.37110E-03	5.92690E-01	1.40530E-03	3.40900E-03
2.16430E+03	2.42860E-03	5.92740E-01	1.43950E-03	3.49190E-03
2.16440E+03	2.48230E-03	5.92780E-01	1.47150E-03	3.56950E-03
2.16450E+03	2.53560E-03	5.92830E-01	1.50320E-03	3.64640E-03
2.16460E+03	2.59200E-03	5.92880E-01	1.53680E-03	3.72780E-03
2.16470E+03	2.65500E-03	5.92920E-01	1.57420E-03	3.81870E-03
2.16480E+03	2.72780E-03	5.92970E-01	1.61750E-03	3.92370E-03
2.16490E+03	2.81330E-03	5.93020E-01	1.66840E-03	4.04700E-03
2.16500E+03	2.91370E-03	5.93070E-01	1.72800E-03	4.19180E-03
2.16510E+03	3.03050E-03	5.93130E-01	1.79750E-03	4.36030E-03
2.16520E+03	3.16450E-03	5.93190E-01	1.87710E-03	4.55350E-03
2.16530E+03	3.31550E-03	5.93260E-01	1.96690E-03	4.77130E-03
2.16540E+03	3.48270E-03	5.93320E-01	2.06640E-03	5.01250E-03
2.16550E+03	3.66470E-03	5.93380E-01	2.17460E-03	5.27500E-03
2.16560E+03	3.85930E-03	5.93430E-01	2.29020E-03	5.55550E-03
2.16570E+03	4.06400E-03	5.93480E-01	2.41190E-03	5.85070E-03
2.16580E+03	4.27610E-03	5.93530E-01	2.53800E-03	6.15660E-03
2.16590E+03	4.49250E-03	5.93580E-01	2.66670E-03	6.46870E-03
2.16600E+03	4.71020E-03	5.93630E-01	2.79610E-03	6.78280E-03
2.16610E+03	4.92640E-03	5.93670E-01	2.92470E-03	7.09460E-03
2.16620E+03	5.13850E-03	5.93710E-01	3.05080E-03	7.40050E-03
2.16630E+03	5.34440E-03	5.93750E-01	3.17320E-03	7.69740E-03
2.16640E+03	5.54240E-03	5.93790E-01	3.29100E-03	7.98320E-03
2.16650E+03	5.73170E-03	5.93830E-01	3.40360E-03	8.25630E-03
2.16660E+03	5.91170E-03	5.93870E-01	3.51070E-03	8.51620E-03
2.16670E+03	6.08260E-03	5.93910E-01	3.61250E-03	8.76310E-03
2.16680E+03	6.24520E-03	5.93950E-01	3.70930E-03	8.99790E-03
2.16690E+03	6.40050E-03	5.93980E-01	3.80180E-03	9.22220E-03
2.16700E+03	6.54990E-03	5.94020E-01	3.89080E-03	9.43820E-03
2.16710E+03	6.69530E-03	5.94060E-01	3.97740E-03	9.64830E-03
2.16720E+03	6.83880E-03	5.94090E-01	4.06290E-03	9.85550E-03

2.16730E+03	6.98240E-03	5.94130E-01	4.14840E-03	1.00630E-02
2.16740E+03	7.12850E-03	5.94160E-01	4.23550E-03	1.02740E-02
2.16750E+03	7.27940E-03	5.94200E-01	4.32540E-03	1.04920E-02
2.16760E+03	7.43760E-03	5.94230E-01	4.41960E-03	1.07210E-02
2.16770E+03	7.60520E-03	5.94270E-01	4.51950E-03	1.09630E-02
2.16780E+03	7.78450E-03	5.94300E-01	4.62640E-03	1.12220E-02
2.16790E+03	7.97760E-03	5.94340E-01	4.74140E-03	1.15010E-02
2.16800E+03	8.18620E-03	5.94370E-01	4.86560E-03	1.18030E-02
2.16810E+03	8.41200E-03	5.94390E-01	5.00000E-03	1.21290E-02
2.16820E+03	8.65640E-03	5.94410E-01	5.14550E-03	1.24820E-02
2.16830E+03	8.92060E-03	5.94430E-01	5.30270E-03	1.28630E-02
2.16840E+03	9.20550E-03	5.94440E-01	5.47220E-03	1.32740E-02
2.16850E+03	9.51170E-03	5.94460E-01	5.65430E-03	1.37160E-02
2.16860E+03	9.83940E-03	5.94480E-01	5.84930E-03	1.41890E-02
2.16870E+03	1.01890E-02	5.94480E-01	6.05690E-03	1.46930E-02
2.16880E+03	1.05590E-02	5.94490E-01	6.27710E-03	1.52270E-02
2.16890E+03	1.09490E-02	5.94500E-01	6.50940E-03	1.57900E-02
2.16900E+03	1.13590E-02	5.94510E-01	6.75330E-03	1.63820E-02
2.16910E+03	1.17880E-02	5.94520E-01	7.00810E-03	1.70000E-02
2.16920E+03	1.22330E-02	5.94530E-01	7.27300E-03	1.76430E-02
2.16930E+03	1.26940E-02	5.94540E-01	7.54730E-03	1.83080E-02
2.16940E+03	1.31700E-02	5.94550E-01	7.83020E-03	1.89940E-02
2.16950E+03	1.36590E-02	5.94560E-01	8.12110E-03	1.97000E-02
2.16960E+03	1.41600E-02	5.94570E-01	8.41940E-03	2.04230E-02
2.16970E+03	1.46740E-02	5.94580E-01	8.72480E-03	2.11640E-02
2.16980E+03	1.51990E-02	5.94590E-01	9.03740E-03	2.19230E-02
2.16990E+03	1.57370E-02	5.94600E-01	9.35710E-03	2.26980E-02
2.17000E+03	1.62870E-02	5.94610E-01	9.68450E-03	2.34920E-02
2.17010E+03	1.68520E-02	5.94630E-01	1.00200E-02	2.43070E-02
2.17020E+03	1.74320E-02	5.94640E-01	1.03660E-02	2.51450E-02
2.17030E+03	1.80300E-02	5.94660E-01	1.07220E-02	2.60080E-02
2.17040E+03	1.86480E-02	5.94670E-01	1.10890E-02	2.69000E-02
2.17050E+03	1.92890E-02	5.94690E-01	1.14710E-02	2.78260E-02
2.17060E+03	1.99560E-02	5.94710E-01	1.18680E-02	2.87890E-02
2.17070E+03	2.06520E-02	5.94720E-01	1.22820E-02	2.97940E-02
2.17080E+03	2.13800E-02	5.94740E-01	1.27150E-02	3.08450E-02
2.17090E+03	2.21420E-02	5.94800E-01	1.31700E-02	3.19480E-02
2.17100E+03	2.29430E-02	5.94850E-01	1.36480E-02	3.31060E-02
2.17110E+03	2.37830E-02	5.94900E-01	1.41490E-02	3.43210E-02
2.17120E+03	2.46670E-02	5.94940E-01	1.46750E-02	3.55990E-02
2.17130E+03	2.55960E-02	5.94990E-01	1.52290E-02	3.69430E-02
2.17140E+03	2.53440E-02	5.95030E-01	1.50800E-02	3.65820E-02
2.17150E+03	2.63510E-02	5.95070E-01	1.56810E-02	3.80370E-02

2.17160E+03	2.74350E-02	5.95120E-01	1.63270E-02	3.96060E-02
2.17170E+03	2.85970E-02	5.95160E-01	1.70200E-02	4.12860E-02
2.17180E+03	2.98310E-02	5.95210E-01	1.77560E-02	4.30710E-02
2.17190E+03	3.11340E-02	5.95250E-01	1.85320E-02	4.49550E-02
2.17200E+03	3.24970E-02	5.95290E-01	1.93450E-02	4.69270E-02
2.17210E+03	3.39160E-02	5.95330E-01	2.01910E-02	4.89800E-02
2.17220E+03	3.53840E-02	5.95370E-01	2.10670E-02	5.11020E-02
2.17230E+03	3.68950E-02	5.95420E-01	2.19680E-02	5.32890E-02
2.17240E+03	3.84480E-02	5.95460E-01	2.28940E-02	5.55350E-02
2.17250E+03	4.00400E-02	5.95500E-01	2.38440E-02	5.78390E-02
2.17260E+03	4.16740E-02	5.95540E-01	2.48180E-02	6.02030E-02
2.17270E+03	4.33530E-02	5.95580E-01	2.58200E-02	6.26330E-02
2.17280E+03	4.50840E-02	5.95620E-01	2.68530E-02	6.51390E-02
2.17290E+03	4.68760E-02	5.95660E-01	2.79220E-02	6.77320E-02
2.17300E+03	4.87380E-02	5.95700E-01	2.90330E-02	7.04270E-02
2.17310E+03	5.06810E-02	5.95790E-01	3.01950E-02	7.32470E-02
2.17320E+03	5.27170E-02	5.95880E-01	3.14130E-02	7.62010E-02
2.17330E+03	5.48560E-02	5.95970E-01	3.26930E-02	7.93050E-02
2.17340E+03	5.71070E-02	5.96070E-01	3.40400E-02	8.25720E-02
2.17350E+03	5.94790E-02	5.96160E-01	3.54590E-02	8.60140E-02
2.17360E+03	6.19750E-02	5.96250E-01	3.69530E-02	8.96390E-02
2.17370E+03	6.46010E-02	5.96340E-01	3.85250E-02	9.34510E-02
2.17380E+03	6.73570E-02	5.96440E-01	4.01740E-02	9.74530E-02
2.17390E+03	7.02430E-02	5.96530E-01	4.19020E-02	1.01640E-01
2.17400E+03	7.32570E-02	5.96620E-01	4.37070E-02	1.06020E-01
2.17410E+03	7.63950E-02	5.96670E-01	4.55830E-02	1.10570E-01
2.17420E+03	7.96550E-02	5.96710E-01	4.75310E-02	1.15300E-01
2.17430E+03	8.30340E-02	5.96750E-01	4.95500E-02	1.20200E-01
2.17440E+03	8.65290E-02	5.96790E-01	5.16400E-02	1.25270E-01
2.17450E+03	9.01390E-02	5.96830E-01	5.37980E-02	1.30500E-01
2.17460E+03	9.38650E-02	5.96880E-01	5.60260E-02	1.35900E-01
2.17470E+03	9.77080E-02	5.96920E-01	5.83230E-02	1.41480E-01
2.17480E+03	1.01670E-01	5.96960E-01	6.06930E-02	1.47230E-01
2.17490E+03	1.05760E-01	5.97000E-01	6.31380E-02	1.53160E-01
2.17500E+03	1.09970E-01	5.97040E-01	6.56590E-02	1.59270E-01
2.17510E+03	1.14320E-01	5.97090E-01	6.82610E-02	1.65590E-01
2.17520E+03	1.18810E-01	5.97130E-01	7.09450E-02	1.72100E-01
2.17530E+03	1.23440E-01	5.97160E-01	7.37110E-02	1.78800E-01
2.17540E+03	1.28200E-01	5.97200E-01	7.65630E-02	1.85720E-01
2.17550E+03	1.33110E-01	5.97240E-01	7.95000E-02	1.92850E-01
2.17560E+03	1.38160E-01	5.97280E-01	8.25210E-02	2.00180E-01
2.17570E+03	1.43350E-01	5.97320E-01	8.56240E-02	2.07700E-01
2.17580E+03	1.48660E-01	5.97360E-01	8.88060E-02	2.15420E-01

2.17590E+03	1.54100E-01	5.97400E-01	9.20630E-02	2.23320E-01
2.17600E+03	1.59670E-01	5.97450E-01	9.53930E-02	2.31400E-01
2.17610E+03	1.65340E-01	5.97520E-01	9.87950E-02	2.39650E-01
2.17620E+03	1.71130E-01	5.97580E-01	1.02260E-01	2.48070E-01
2.17630E+03	1.77020E-01	5.97650E-01	1.05800E-01	2.56640E-01
2.17640E+03	1.83020E-01	5.97720E-01	1.09390E-01	2.65360E-01
2.17650E+03	1.89120E-01	5.97790E-01	1.13050E-01	2.74230E-01
2.17660E+03	1.95320E-01	5.97860E-01	1.16770E-01	2.83270E-01
2.17670E+03	2.01640E-01	5.97920E-01	1.20560E-01	2.92460E-01
2.17680E+03	2.08070E-01	5.97990E-01	1.24420E-01	3.01820E-01
2.17690E+03	2.14620E-01	5.98060E-01	1.28350E-01	3.11350E-01
2.17700E+03	2.21290E-01	5.98130E-01	1.32360E-01	3.21070E-01
2.17710E+03	2.28090E-01	5.98200E-01	1.36440E-01	3.30970E-01
2.17720E+03	2.35010E-01	5.98260E-01	1.40600E-01	3.41060E-01
2.17730E+03	2.42070E-01	5.98330E-01	1.44840E-01	3.51340E-01
2.17740E+03	2.49240E-01	5.98400E-01	1.49150E-01	3.61790E-01
2.17750E+03	2.56530E-01	5.98430E-01	1.53520E-01	3.72400E-01
2.17760E+03	2.63920E-01	5.98460E-01	1.57950E-01	3.83150E-01
2.17770E+03	2.71400E-01	5.98500E-01	1.62430E-01	3.94030E-01
2.17780E+03	2.78950E-01	5.98530E-01	1.66960E-01	4.05010E-01
2.17790E+03	2.86550E-01	5.98560E-01	1.71520E-01	4.16060E-01
2.17800E+03	2.94170E-01	5.98610E-01	1.76100E-01	4.27170E-01
2.17810E+03	3.01800E-01	5.98730E-01	1.80700E-01	4.38330E-01
2.17820E+03	3.09420E-01	5.98840E-01	1.85290E-01	4.49480E-01
2.17830E+03	3.17000E-01	5.98950E-01	1.89870E-01	4.60570E-01
2.17840E+03	3.24520E-01	5.99070E-01	1.94410E-01	4.71590E-01
2.17850E+03	3.31980E-01	5.99180E-01	1.98910E-01	4.82520E-01
2.17860E+03	3.39350E-01	5.99290E-01	2.03370E-01	4.93320E-01
2.17870E+03	3.46620E-01	5.99410E-01	2.07770E-01	5.04000E-01
2.17880E+03	3.53800E-01	5.99520E-01	2.12110E-01	5.14530E-01
2.17890E+03	3.60880E-01	5.99630E-01	2.16400E-01	5.24930E-01
2.17900E+03	3.67860E-01	5.99750E-01	2.20620E-01	5.35180E-01
2.17910E+03	3.74730E-01	5.99860E-01	2.24790E-01	5.45280E-01
2.17920E+03	3.81510E-01	5.99970E-01	2.28900E-01	5.55250E-01
2.17930E+03	3.88200E-01	6.00080E-01	2.32950E-01	5.65090E-01
2.17940E+03	3.94800E-01	6.00200E-01	2.36950E-01	5.74800E-01
2.17950E+03	4.01300E-01	6.00310E-01	2.40910E-01	5.84380E-01
2.17960E+03	4.07730E-01	6.00420E-01	2.44810E-01	5.93860E-01
2.17970E+03	4.14080E-01	6.00510E-01	2.48660E-01	6.03190E-01
2.17980E+03	4.20360E-01	6.00590E-01	2.52460E-01	6.12420E-01
2.17990E+03	4.26550E-01	6.00680E-01	2.56220E-01	6.21530E-01
2.18000E+03	4.32670E-01	6.00760E-01	2.59930E-01	6.30530E-01
2.18010E+03	4.38720E-01	6.00800E-01	2.63580E-01	6.39380E-01

2.18020E+03	4.44680E-01	6.00840E-01	2.67180E-01	6.48120E-01
2.18030E+03	4.50570E-01	6.00880E-01	2.70730E-01	6.56740E-01
2.18040E+03	4.56360E-01	6.00920E-01	2.74240E-01	6.65240E-01
2.18050E+03	4.62080E-01	6.00960E-01	2.77690E-01	6.73610E-01
2.18060E+03	4.67700E-01	6.01000E-01	2.81090E-01	6.81850E-01
2.18070E+03	4.73220E-01	6.01040E-01	2.84430E-01	6.89950E-01
2.18080E+03	4.78650E-01	6.01080E-01	2.87710E-01	6.97910E-01
2.18090E+03	4.83970E-01	6.01120E-01	2.90920E-01	7.05710E-01
2.18100E+03	4.89170E-01	6.01160E-01	2.94070E-01	7.13350E-01
2.18110E+03	4.94250E-01	6.01210E-01	2.97150E-01	7.20810E-01
2.18120E+03	4.99210E-01	6.01250E-01	3.00150E-01	7.28090E-01
2.18130E+03	5.04030E-01	6.01290E-01	3.03070E-01	7.35170E-01
2.18140E+03	5.08710E-01	6.01330E-01	3.05900E-01	7.42050E-01
2.18150E+03	5.13240E-01	6.01370E-01	3.08650E-01	7.48700E-01
2.18160E+03	5.17620E-01	6.01410E-01	3.11300E-01	7.55140E-01
2.18170E+03	5.21840E-01	6.01450E-01	3.13860E-01	7.61350E-01
2.18180E+03	5.25900E-01	6.01490E-01	3.16320E-01	7.67330E-01
2.18190E+03	5.29800E-01	6.01570E-01	3.18710E-01	7.73120E-01
2.18200E+03	5.33550E-01	6.01640E-01	3.21010E-01	7.78690E-01
2.18210E+03	5.37150E-01	6.01730E-01	3.23220E-01	7.84060E-01
2.18220E+03	5.40610E-01	6.01820E-01	3.25350E-01	7.89230E-01
2.18230E+03	5.43940E-01	6.01910E-01	3.27410E-01	7.94210E-01
2.18240E+03	5.47160E-01	6.02000E-01	3.29390E-01	7.99010E-01
2.18250E+03	5.50260E-01	6.02080E-01	3.31300E-01	8.03660E-01
2.18260E+03	5.53270E-01	6.02170E-01	3.33160E-01	8.08170E-01
2.18270E+03	5.56190E-01	6.02260E-01	3.34970E-01	8.12560E-01
2.18280E+03	5.59040E-01	6.02350E-01	3.36740E-01	8.16850E-01
2.18290E+03	5.61820E-01	6.02440E-01	3.38460E-01	8.21030E-01
2.18300E+03	5.64540E-01	6.02520E-01	3.40150E-01	8.25120E-01
2.18310E+03	5.67200E-01	6.02610E-01	3.41800E-01	8.29130E-01
2.18320E+03	5.69810E-01	6.02700E-01	3.43420E-01	8.33050E-01
2.18330E+03	5.72350E-01	6.02780E-01	3.45000E-01	8.36890E-01
2.18340E+03	5.74820E-01	6.02870E-01	3.46540E-01	8.40620E-01
2.18350E+03	5.77220E-01	6.02950E-01	3.48040E-01	8.44260E-01
2.18360E+03	5.79550E-01	6.03040E-01	3.49490E-01	8.47790E-01
2.18370E+03	5.81800E-01	6.03130E-01	3.50900E-01	8.51200E-01
2.18380E+03	5.83970E-01	6.03210E-01	3.52260E-01	8.54500E-01
2.18390E+03	5.86060E-01	6.03300E-01	3.53570E-01	8.57670E-01
2.18400E+03	5.88060E-01	6.03390E-01	3.54830E-01	8.60730E-01
2.18410E+03	5.89990E-01	6.03480E-01	3.56050E-01	8.63690E-01
2.18420E+03	5.91850E-01	6.03570E-01	3.57220E-01	8.66530E-01
2.18430E+03	5.93650E-01	6.03660E-01	3.58360E-01	8.69300E-01
2.18440E+03	5.95400E-01	6.03750E-01	3.59470E-01	8.71990E-01

2.18450E+03	5.97100E-01	6.03840E-01	3.60550E-01	8.74620E-01
2.18460E+03	5.98790E-01	6.03930E-01	3.61620E-01	8.77210E-01
2.18470E+03	6.00450E-01	6.04020E-01	3.62680E-01	8.79780E-01
2.18480E+03	6.02110E-01	6.04110E-01	3.63740E-01	8.82340E-01
2.18490E+03	6.03760E-01	6.04200E-01	3.64790E-01	8.84890E-01
2.18500E+03	6.05420E-01	6.04290E-01	3.65850E-01	8.87450E-01
2.18510E+03	6.07080E-01	6.04340E-01	3.66880E-01	8.89970E-01
2.18520E+03	6.08740E-01	6.04400E-01	3.67920E-01	8.92480E-01
2.18530E+03	6.10390E-01	6.04450E-01	3.68950E-01	8.94990E-01
2.18540E+03	6.12040E-01	6.04500E-01	3.69980E-01	8.97480E-01
2.18550E+03	6.13670E-01	6.04560E-01	3.71000E-01	8.99950E-01
2.18560E+03	6.15270E-01	6.04610E-01	3.72000E-01	9.02390E-01
2.18570E+03	6.16840E-01	6.04670E-01	3.72990E-01	9.04780E-01
2.18580E+03	6.18380E-01	6.04720E-01	3.73950E-01	9.07110E-01
2.18590E+03	6.19890E-01	6.04780E-01	3.74890E-01	9.09400E-01
2.18600E+03	6.21360E-01	6.04830E-01	3.75810E-01	9.11640E-01
2.18610E+03	6.22800E-01	6.04870E-01	3.76710E-01	9.13810E-01
2.18620E+03	6.24230E-01	6.04900E-01	3.77600E-01	9.15960E-01
2.18630E+03	6.25650E-01	6.04950E-01	3.78490E-01	9.18120E-01
2.18640E+03	6.27080E-01	6.05010E-01	3.79390E-01	9.20310E-01
2.18650E+03	6.28530E-01	6.05080E-01	3.80310E-01	9.22540E-01
2.18660E+03	6.30020E-01	6.05140E-01	3.81250E-01	9.24830E-01
2.18670E+03	6.31560E-01	6.05210E-01	3.82230E-01	9.27190E-01
2.18680E+03	6.33160E-01	6.05270E-01	3.83240E-01	9.29640E-01
2.18690E+03	6.34830E-01	6.05340E-01	3.84290E-01	9.32190E-01
2.18700E+03	6.36570E-01	6.05400E-01	3.85380E-01	9.34840E-01
2.18710E+03	6.38370E-01	6.05470E-01	3.86520E-01	9.37600E-01
2.18720E+03	6.40240E-01	6.05540E-01	3.87690E-01	9.40440E-01
2.18730E+03	6.42140E-01	6.05610E-01	3.88890E-01	9.43350E-01
2.18740E+03	6.44080E-01	6.05680E-01	3.90110E-01	9.46300E-01
2.18750E+03	6.46030E-01	6.05750E-01	3.91330E-01	9.49270E-01
2.18760E+03	6.47960E-01	6.05820E-01	3.92540E-01	9.52220E-01
2.18770E+03	6.49860E-01	6.05890E-01	3.93740E-01	9.55120E-01
2.18780E+03	6.51710E-01	6.05960E-01	3.94910E-01	9.57950E-01
2.18790E+03	6.53490E-01	6.06030E-01	3.96030E-01	9.60670E-01
2.18800E+03	6.55180E-01	6.06100E-01	3.97110E-01	9.63290E-01
2.18810E+03	6.56780E-01	6.06270E-01	3.98190E-01	9.65900E-01
2.18820E+03	6.58290E-01	6.06430E-01	3.99200E-01	9.68370E-01
2.18830E+03	6.59690E-01	6.06590E-01	4.00160E-01	9.70700E-01
2.18840E+03	6.61000E-01	6.06750E-01	4.01070E-01	9.72890E-01
2.18850E+03	6.62230E-01	6.06940E-01	4.01930E-01	9.74980E-01
2.18860E+03	6.63370E-01	6.07120E-01	4.02740E-01	9.76960E-01
2.18870E+03	6.64450E-01	6.07300E-01	4.03520E-01	9.78850E-01

2.18880E+03	6.65480E-01	6.07480E-01	4.04270E-01	9.80660E-01
2.18890E+03	6.66470E-01	6.07660E-01	4.04990E-01	9.82410E-01
2.18900E+03	6.67430E-01	6.07850E-01	4.05690E-01	9.84110E-01
2.18910E+03	6.68360E-01	6.08030E-01	4.06380E-01	9.85790E-01
2.18920E+03	6.69270E-01	6.08220E-01	4.07060E-01	9.87430E-01
2.18930E+03	6.70150E-01	6.08400E-01	4.07720E-01	9.89040E-01
2.18940E+03	6.71020E-01	6.08580E-01	4.08370E-01	9.90610E-01
2.18950E+03	6.71840E-01	6.08770E-01	4.09000E-01	9.92130E-01
2.18960E+03	6.72630E-01	6.08950E-01	4.09600E-01	9.93590E-01
2.18970E+03	6.73350E-01	6.09140E-01	4.10170E-01	9.94960E-01
2.18980E+03	6.74010E-01	6.09320E-01	4.10690E-01	9.96240E-01
2.18990E+03	6.74590E-01	6.09510E-01	4.11170E-01	9.97390E-01
2.19000E+03	6.75070E-01	6.09690E-01	4.11580E-01	9.98400E-01
2.19010E+03	6.75440E-01	6.09750E-01	4.11850E-01	9.99060E-01
2.19020E+03	6.75710E-01	6.09810E-01	4.12060E-01	9.99550E-01
2.19030E+03	6.75850E-01	6.09880E-01	4.12180E-01	9.99860E-01
2.19040E+03	6.75880E-01	6.09940E-01	4.12240E-01	1.00000E+00
2.19050E+03	6.75790E-01	6.10000E-01	4.12230E-01	9.99970E-01
2.19060E+03	6.75580E-01	6.10060E-01	4.12140E-01	9.99760E-01
2.19070E+03	6.75270E-01	6.10120E-01	4.12000E-01	9.99400E-01
2.19080E+03	6.74860E-01	6.10180E-01	4.11790E-01	9.98900E-01
2.19090E+03	6.74370E-01	6.10240E-01	4.11530E-01	9.98260E-01
2.19100E+03	6.73790E-01	6.10300E-01	4.11220E-01	9.97510E-01
2.19110E+03	6.73150E-01	6.10360E-01	4.10860E-01	9.96660E-01
2.19120E+03	6.72450E-01	6.10420E-01	4.10480E-01	9.95710E-01
2.19130E+03	6.71690E-01	6.10480E-01	4.10050E-01	9.94690E-01
2.19140E+03	6.70890E-01	6.10540E-01	4.09600E-01	9.93600E-01
2.19150E+03	6.70040E-01	6.10600E-01	4.09120E-01	9.92430E-01
2.19160E+03	6.69140E-01	6.10660E-01	4.08610E-01	9.91200E-01
2.19170E+03	6.68200E-01	6.10710E-01	4.08080E-01	9.89900E-01
2.19180E+03	6.67200E-01	6.10770E-01	4.07510E-01	9.88520E-01
2.19190E+03	6.66150E-01	6.10830E-01	4.06900E-01	9.87050E-01
2.19200E+03	6.65030E-01	6.10890E-01	4.06260E-01	9.85490E-01
2.19210E+03	6.63840E-01	6.10890E-01	4.05530E-01	9.83730E-01
2.19220E+03	6.62570E-01	6.10890E-01	4.04750E-01	9.81840E-01
2.19230E+03	6.61210E-01	6.10830E-01	4.03890E-01	9.79740E-01
2.19240E+03	6.59770E-01	6.10760E-01	4.02960E-01	9.77470E-01
2.19250E+03	6.58220E-01	6.10680E-01	4.01960E-01	9.75060E-01
2.19260E+03	6.56580E-01	6.10600E-01	4.00910E-01	9.72510E-01
2.19270E+03	6.54830E-01	6.10530E-01	3.99790E-01	9.69800E-01
2.19280E+03	6.52990E-01	6.10450E-01	3.98620E-01	9.66950E-01
2.19290E+03	6.51040E-01	6.10350E-01	3.97370E-01	9.63920E-01
2.19300E+03	6.49000E-01	6.10260E-01	3.96060E-01	9.60740E-01

2.19310E+03	6.46870E-01	6.10160E-01	3.94690E-01	9.57430E-01
2.19320E+03	6.44640E-01	6.10060E-01	3.93270E-01	9.53980E-01
2.19330E+03	6.42330E-01	6.09970E-01	3.91800E-01	9.50410E-01
2.19340E+03	6.39940E-01	6.09870E-01	3.90280E-01	9.46730E-01
2.19350E+03	6.37480E-01	6.09770E-01	3.88720E-01	9.42930E-01
2.19360E+03	6.34940E-01	6.09670E-01	3.87100E-01	9.39020E-01
2.19370E+03	6.32320E-01	6.09580E-01	3.85450E-01	9.35010E-01
2.19380E+03	6.29630E-01	6.09480E-01	3.83750E-01	9.30880E-01
2.19390E+03	6.26860E-01	6.09380E-01	3.82000E-01	9.26640E-01
2.19400E+03	6.24010E-01	6.09300E-01	3.80210E-01	9.22300E-01
2.19410E+03	6.21070E-01	6.09340E-01	3.78440E-01	9.18010E-01
2.19420E+03	6.18030E-01	6.09380E-01	3.76620E-01	9.13580E-01
2.19430E+03	6.14890E-01	6.09420E-01	3.74730E-01	9.09000E-01
2.19440E+03	6.11630E-01	6.09460E-01	3.72770E-01	9.04240E-01
2.19450E+03	6.08250E-01	6.09510E-01	3.70730E-01	8.99310E-01
2.19460E+03	6.04750E-01	6.09550E-01	3.68620E-01	8.94190E-01
2.19470E+03	6.01110E-01	6.09590E-01	3.66430E-01	8.88870E-01
2.19480E+03	5.97340E-01	6.09630E-01	3.64160E-01	8.83360E-01
2.19490E+03	5.93440E-01	6.09670E-01	3.61800E-01	8.77650E-01
2.19500E+03	5.89410E-01	6.09710E-01	3.59370E-01	8.71750E-01
2.19510E+03	5.85260E-01	6.09810E-01	3.56900E-01	8.65740E-01
2.19520E+03	5.80990E-01	6.09910E-01	3.54350E-01	8.59570E-01
2.19530E+03	5.76620E-01	6.10010E-01	3.51740E-01	8.53240E-01
2.19540E+03	5.72160E-01	6.10100E-01	3.49080E-01	8.46780E-01
2.19550E+03	5.67620E-01	6.10200E-01	3.46360E-01	8.40190E-01
2.19560E+03	5.63010E-01	6.10300E-01	3.43600E-01	8.33500E-01
2.19570E+03	5.58340E-01	6.10400E-01	3.40810E-01	8.26720E-01
2.19580E+03	5.53610E-01	6.10500E-01	3.37980E-01	8.19850E-01
2.19590E+03	5.48830E-01	6.10590E-01	3.35110E-01	8.12900E-01
2.19600E+03	5.44000E-01	6.10690E-01	3.32220E-01	8.05880E-01
2.19610E+03	5.39120E-01	6.10750E-01	3.29260E-01	7.98710E-01
2.19620E+03	5.34160E-01	6.10790E-01	3.26260E-01	7.91430E-01
2.19630E+03	5.29140E-01	6.10830E-01	3.23210E-01	7.84040E-01
2.19640E+03	5.24020E-01	6.10870E-01	3.20110E-01	7.76510E-01
2.19650E+03	5.18800E-01	6.10920E-01	3.16940E-01	7.68830E-01
2.19660E+03	5.13470E-01	6.10960E-01	3.13710E-01	7.60980E-01
2.19670E+03	5.08010E-01	6.11000E-01	3.10390E-01	7.52940E-01
2.19680E+03	5.02410E-01	6.11050E-01	3.07000E-01	7.44700E-01
2.19690E+03	4.96670E-01	6.11090E-01	3.03510E-01	7.36250E-01
2.19700E+03	4.90800E-01	6.11130E-01	2.99940E-01	7.27590E-01
2.19710E+03	4.84790E-01	6.11180E-01	2.96290E-01	7.18730E-01
2.19720E+03	4.78650E-01	6.11230E-01	2.92570E-01	7.09700E-01
2.19730E+03	4.72410E-01	6.11220E-01	2.88750E-01	7.00440E-01

2.19740E+03	4.66080E-01	6.11220E-01	2.84880E-01	6.91050E-01
2.19750E+03	4.59690E-01	6.11210E-01	2.80970E-01	6.81550E-01
2.19760E+03	4.53250E-01	6.11200E-01	2.77030E-01	6.72000E-01
2.19770E+03	4.46780E-01	6.11200E-01	2.73070E-01	6.62410E-01
2.19780E+03	4.40310E-01	6.11190E-01	2.69120E-01	6.52810E-01
2.19790E+03	4.33850E-01	6.11190E-01	2.65170E-01	6.43230E-01
2.19800E+03	4.27420E-01	6.11180E-01	2.61230E-01	6.33680E-01
2.19810E+03	4.21010E-01	6.11130E-01	2.57290E-01	6.24130E-01
2.19820E+03	4.14630E-01	6.11090E-01	2.53380E-01	6.14630E-01
2.19830E+03	4.08270E-01	6.11040E-01	2.49470E-01	6.05150E-01
2.19840E+03	4.01920E-01	6.10990E-01	2.45570E-01	5.95690E-01
2.19850E+03	3.95570E-01	6.10940E-01	2.41670E-01	5.86230E-01
2.19860E+03	3.89190E-01	6.10890E-01	2.37750E-01	5.76730E-01
2.19870E+03	3.82760E-01	6.10850E-01	2.33810E-01	5.67170E-01
2.19880E+03	3.76290E-01	6.10800E-01	2.29840E-01	5.57530E-01
2.19890E+03	3.69740E-01	6.10750E-01	2.25820E-01	5.47780E-01
2.19900E+03	3.63120E-01	6.10700E-01	2.21760E-01	5.37930E-01
2.19910E+03	3.56410E-01	6.10660E-01	2.17640E-01	5.27950E-01
2.19920E+03	3.49630E-01	6.10610E-01	2.13480E-01	5.17860E-01
2.19930E+03	3.42770E-01	6.10560E-01	2.09290E-01	5.07680E-01
2.19940E+03	3.35870E-01	6.10510E-01	2.05060E-01	4.97420E-01
2.19950E+03	3.28940E-01	6.10560E-01	2.00840E-01	4.87190E-01
2.19960E+03	3.22000E-01	6.10610E-01	1.96620E-01	4.76950E-01
2.19970E+03	3.15080E-01	6.10660E-01	1.92410E-01	4.66730E-01
2.19980E+03	3.08190E-01	6.10710E-01	1.88220E-01	4.56570E-01
2.19990E+03	3.01370E-01	6.10760E-01	1.84070E-01	4.46500E-01
2.20000E+03	2.94630E-01	6.10820E-01	1.79960E-01	4.36550E-01
2.20010E+03	2.87980E-01	6.10990E-01	1.75950E-01	4.26820E-01
2.20020E+03	2.81420E-01	6.11170E-01	1.71990E-01	4.17220E-01
2.20030E+03	2.74960E-01	6.11340E-01	1.68090E-01	4.07750E-01
2.20040E+03	2.68580E-01	6.11520E-01	1.64240E-01	3.98410E-01
2.20050E+03	2.62280E-01	6.11690E-01	1.60430E-01	3.89170E-01
2.20060E+03	2.56030E-01	6.11860E-01	1.56660E-01	3.80010E-01
2.20070E+03	2.49830E-01	6.12040E-01	1.52900E-01	3.70900E-01
2.20080E+03	2.43640E-01	6.12210E-01	1.49160E-01	3.61830E-01
2.20090E+03	2.37460E-01	6.12390E-01	1.45420E-01	3.52750E-01
2.20100E+03	2.31280E-01	6.12560E-01	1.41670E-01	3.43670E-01
2.20110E+03	2.25090E-01	6.12730E-01	1.37920E-01	3.34550E-01
2.20120E+03	2.18880E-01	6.12910E-01	1.34150E-01	3.25420E-01
2.20130E+03	2.12660E-01	6.13080E-01	1.30380E-01	3.16260E-01
2.20140E+03	2.06440E-01	6.13260E-01	1.26600E-01	3.07110E-01
2.20150E+03	2.00260E-01	6.13430E-01	1.22840E-01	2.97990E-01
2.20160E+03	1.94110E-01	6.13600E-01	1.19110E-01	2.88930E-01

2.20170E+03	1.88040E-01	6.13710E-01	1.15400E-01	2.79940E-01
2.20180E+03	1.82070E-01	6.13820E-01	1.11760E-01	2.71090E-01
2.20190E+03	1.76210E-01	6.13930E-01	1.08180E-01	2.62430E-01
2.20200E+03	1.70510E-01	6.14040E-01	1.04700E-01	2.53980E-01
2.20210E+03	1.64970E-01	6.14230E-01	1.01330E-01	2.45800E-01
2.20220E+03	1.59610E-01	6.14430E-01	9.80670E-02	2.37890E-01
2.20230E+03	1.54430E-01	6.14630E-01	9.49160E-02	2.30240E-01
2.20240E+03	1.49440E-01	6.14820E-01	9.18770E-02	2.22870E-01
2.20250E+03	1.44630E-01	6.15020E-01	8.89480E-02	2.15770E-01
2.20260E+03	1.39990E-01	6.15220E-01	8.61220E-02	2.08910E-01
2.20270E+03	1.35510E-01	6.15420E-01	8.33930E-02	2.02290E-01
2.20280E+03	1.31170E-01	6.15610E-01	8.07510E-02	1.95880E-01
2.20290E+03	1.26970E-01	6.15810E-01	7.81860E-02	1.89660E-01
2.20300E+03	1.22870E-01	6.16010E-01	7.56910E-02	1.83610E-01
2.20310E+03	1.18890E-01	6.16200E-01	7.32570E-02	1.77710E-01
2.20320E+03	1.14990E-01	6.16400E-01	7.08800E-02	1.71940E-01
2.20330E+03	1.11180E-01	6.16590E-01	6.85540E-02	1.66300E-01
2.20340E+03	1.07460E-01	6.16790E-01	6.62800E-02	1.60780E-01
2.20350E+03	1.03820E-01	6.16990E-01	6.40580E-02	1.55390E-01
2.20360E+03	1.00280E-01	6.17180E-01	6.18880E-02	1.50130E-01
2.20370E+03	9.68190E-02	6.17380E-01	5.97730E-02	1.45000E-01
2.20380E+03	9.34580E-02	6.17570E-01	5.77170E-02	1.40010E-01
2.20390E+03	9.01960E-02	6.17740E-01	5.57180E-02	1.35160E-01
2.20400E+03	8.70350E-02	6.17920E-01	5.37800E-02	1.30460E-01
2.20410E+03	8.39720E-02	6.18100E-01	5.19030E-02	1.25900E-01
2.20420E+03	8.10040E-02	6.18280E-01	5.00830E-02	1.21490E-01
2.20430E+03	7.81240E-02	6.18360E-01	4.83090E-02	1.17190E-01
2.20440E+03	7.53230E-02	6.18440E-01	4.65830E-02	1.13000E-01
2.20450E+03	7.25920E-02	6.18510E-01	4.48990E-02	1.08910E-01
2.20460E+03	6.99210E-02	6.18590E-01	4.32520E-02	1.04920E-01
2.20470E+03	6.73020E-02	6.18660E-01	4.16370E-02	1.01000E-01
2.20480E+03	6.47270E-02	6.18730E-01	4.00490E-02	9.71490E-02
2.20490E+03	6.21950E-02	6.18810E-01	3.84860E-02	9.33590E-02
2.20500E+03	5.97050E-02	6.18880E-01	3.69500E-02	8.96330E-02
2.20510E+03	5.72650E-02	6.18960E-01	3.54450E-02	8.59810E-02
2.20520E+03	5.48830E-02	6.19050E-01	3.39750E-02	8.24150E-02
2.20530E+03	5.25730E-02	6.19130E-01	3.25490E-02	7.89570E-02
2.20540E+03	5.03500E-02	6.19210E-01	3.11770E-02	7.56290E-02
2.20550E+03	4.82320E-02	6.19290E-01	2.98700E-02	7.24570E-02
2.20560E+03	4.62340E-02	6.19380E-01	2.86360E-02	6.94640E-02
2.20570E+03	4.43700E-02	6.19460E-01	2.74850E-02	6.66720E-02
2.20580E+03	4.26500E-02	6.19540E-01	2.64230E-02	6.40960E-02
2.20590E+03	4.10780E-02	6.19620E-01	2.54530E-02	6.17430E-02

2.20600E+03	3.96540E-02	6.19710E-01	2.45740E-02	5.96100E-02
2.20610E+03	3.83680E-02	6.19760E-01	2.37790E-02	5.76810E-02
2.20620E+03	3.72060E-02	6.19800E-01	2.30600E-02	5.59390E-02
2.20630E+03	3.61480E-02	6.19850E-01	2.24060E-02	5.43520E-02
2.20640E+03	3.51680E-02	6.19900E-01	2.18010E-02	5.28840E-02
2.20650E+03	3.42400E-02	6.19950E-01	2.12270E-02	5.14920E-02
2.20660E+03	3.33350E-02	6.20000E-01	2.06680E-02	5.01350E-02
2.20670E+03	3.24270E-02	6.20040E-01	2.01060E-02	4.87720E-02
2.20680E+03	3.14920E-02	6.20090E-01	1.95280E-02	4.73700E-02
2.20690E+03	3.05130E-02	6.20140E-01	1.89220E-02	4.59010E-02
2.20700E+03	2.94790E-02	6.20190E-01	1.82830E-02	4.43500E-02
2.20710E+03	2.83870E-02	6.20240E-01	1.76070E-02	4.27100E-02
2.20720E+03	2.72400E-02	6.20300E-01	1.68970E-02	4.09880E-02
2.20730E+03	2.60490E-02	6.20350E-01	1.61600E-02	3.92000E-02
2.20740E+03	2.49120E-02	6.20400E-01	1.54550E-02	3.74910E-02
2.20750E+03	2.39470E-02	6.20460E-01	1.48580E-02	3.60420E-02
2.20760E+03	2.30040E-02	6.20510E-01	1.42740E-02	3.46260E-02
2.20770E+03	2.20830E-02	6.20570E-01	1.37040E-02	3.32430E-02
2.20780E+03	2.11850E-02	6.20620E-01	1.31480E-02	3.18940E-02
2.20790E+03	2.03110E-02	6.20680E-01	1.26060E-02	3.05800E-02
2.20800E+03	1.94610E-02	6.20730E-01	1.20800E-02	2.93030E-02
2.20810E+03	1.86380E-02	6.20770E-01	1.15700E-02	2.80650E-02
2.20820E+03	1.78420E-02	6.20810E-01	1.10770E-02	2.68700E-02
2.20830E+03	1.70780E-02	6.20800E-01	1.06020E-02	2.57170E-02
2.20840E+03	1.63450E-02	6.20800E-01	1.01470E-02	2.46140E-02
2.20850E+03	1.56460E-02	6.20800E-01	9.71280E-03	2.35610E-02
2.20860E+03	1.49830E-02	6.20790E-01	9.30120E-03	2.25630E-02
2.20870E+03	1.43570E-02	6.20790E-01	8.91280E-03	2.16200E-02
2.20880E+03	1.37700E-02	6.20780E-01	8.54830E-03	2.07360E-02
2.20890E+03	1.32220E-02	6.20780E-01	8.20810E-03	1.99110E-02
2.20900E+03	1.27140E-02	6.20770E-01	7.89220E-03	1.91450E-02
2.20910E+03	1.22430E-02	6.20770E-01	7.60030E-03	1.84360E-02
2.20920E+03	1.18110E-02	6.20770E-01	7.33170E-03	1.77850E-02
2.20930E+03	1.14140E-02	6.20770E-01	7.08560E-03	1.71880E-02
2.20940E+03	1.10520E-02	6.20770E-01	6.86040E-03	1.66420E-02
2.20950E+03	1.07200E-02	6.20770E-01	6.65490E-03	1.61430E-02
2.20960E+03	1.04180E-02	6.20770E-01	6.46730E-03	1.56880E-02
2.20970E+03	1.01420E-02	6.20770E-01	6.29590E-03	1.52720E-02
2.20980E+03	9.88910E-03	6.20770E-01	6.13880E-03	1.48910E-02
2.20990E+03	9.65630E-03	6.20770E-01	5.99430E-03	1.45410E-02
2.21000E+03	9.44100E-03	6.20770E-01	5.86070E-03	1.42170E-02
2.21010E+03	9.24040E-03	6.20800E-01	5.73640E-03	1.39150E-02
2.21020E+03	9.05190E-03	6.20840E-01	5.61980E-03	1.36320E-02

2.21030E+03	8.87320E-03	6.20870E-01	5.50910E-03	1.33640E-02
2.21040E+03	8.70200E-03	6.20900E-01	5.40310E-03	1.31070E-02
2.21050E+03	8.53630E-03	6.21030E-01	5.30130E-03	1.28600E-02
2.21060E+03	8.37400E-03	6.21150E-01	5.20150E-03	1.26180E-02
2.21070E+03	8.21340E-03	6.21270E-01	5.10280E-03	1.23780E-02
2.21080E+03	8.05270E-03	6.21400E-01	5.00400E-03	1.21380E-02
2.21090E+03	7.89030E-03	6.21520E-01	4.90400E-03	1.18960E-02
2.21100E+03	7.72470E-03	6.21650E-01	4.80200E-03	1.16490E-02
2.21110E+03	7.55460E-03	6.21800E-01	4.69740E-03	1.13950E-02
2.21120E+03	7.37870E-03	6.21950E-01	4.58920E-03	1.11320E-02
2.21130E+03	7.19640E-03	6.22100E-01	4.47690E-03	1.08600E-02
2.21140E+03	7.00720E-03	6.22250E-01	4.36020E-03	1.05770E-02
2.21150E+03	6.81110E-03	6.22400E-01	4.23920E-03	1.02830E-02
2.21160E+03	6.60860E-03	6.22550E-01	4.11420E-03	9.98010E-03
2.21170E+03	6.40070E-03	6.22700E-01	3.98570E-03	9.66850E-03
2.21180E+03	6.18890E-03	6.22860E-01	3.85480E-03	9.35080E-03
2.21190E+03	5.97500E-03	6.23010E-01	3.72250E-03	9.02990E-03
2.21200E+03	5.76140E-03	6.23160E-01	3.59030E-03	8.70910E-03
2.21210E+03	5.55050E-03	6.23320E-01	3.45970E-03	8.39240E-03
2.21220E+03	5.34470E-03	6.23480E-01	3.33230E-03	8.08340E-03
2.21230E+03	5.14660E-03	6.23640E-01	3.20960E-03	7.78580E-03
2.21240E+03	4.95850E-03	6.23800E-01	3.09310E-03	7.50320E-03
2.21250E+03	4.78230E-03	6.23970E-01	2.98400E-03	7.23850E-03
2.21260E+03	4.61950E-03	6.24130E-01	2.88310E-03	6.99380E-03
2.21270E+03	4.47080E-03	6.24260E-01	2.79100E-03	6.77020E-03
2.21280E+03	4.33650E-03	6.24390E-01	2.70770E-03	6.56820E-03
2.21290E+03	4.21610E-03	6.24530E-01	2.63300E-03	6.38710E-03
2.21300E+03	4.10820E-03	6.24660E-01	2.56620E-03	6.22500E-03
2.21310E+03	4.01110E-03	6.24790E-01	2.50610E-03	6.07920E-03
2.21320E+03	3.92260E-03	6.24920E-01	2.45130E-03	5.94630E-03
2.21330E+03	3.84010E-03	6.25060E-01	2.40030E-03	5.82260E-03
2.21340E+03	3.76110E-03	6.25200E-01	2.35150E-03	5.70410E-03
2.21350E+03	3.68320E-03	6.25340E-01	2.30330E-03	5.58720E-03
2.21360E+03	3.60420E-03	6.25480E-01	2.25440E-03	5.46860E-03
2.21370E+03	3.52250E-03	6.25620E-01	2.20380E-03	5.34580E-03
2.21380E+03	3.43690E-03	6.25760E-01	2.15070E-03	5.21710E-03
2.21390E+03	3.34700E-03	6.25900E-01	2.09490E-03	5.08160E-03
2.21400E+03	3.25270E-03	6.26040E-01	2.03630E-03	4.93970E-03
2.21410E+03	3.15500E-03	6.26170E-01	1.97550E-03	4.79220E-03
2.21420E+03	3.05500E-03	6.26300E-01	1.91330E-03	4.64130E-03
2.21430E+03	2.95450E-03	6.26430E-01	1.85080E-03	4.48950E-03
2.21440E+03	2.85560E-03	6.26560E-01	1.78920E-03	4.34020E-03
2.21450E+03	2.76060E-03	6.26690E-01	1.73000E-03	4.19660E-03

2.21460E+03	2.67160E-03	6.26820E-01	1.67460E-03	4.06220E-03
2.21470E+03	2.59060E-03	6.26950E-01	1.62420E-03	3.93990E-03
2.21480E+03	2.51920E-03	6.27080E-01	1.57970E-03	3.83200E-03
2.21490E+03	2.45820E-03	6.27180E-01	1.54180E-03	3.73990E-03
2.21500E+03	2.40830E-03	6.27280E-01	1.51060E-03	3.66440E-03
2.21510E+03	2.36900E-03	6.27380E-01	1.48630E-03	3.60540E-03
2.21520E+03	2.34000E-03	6.27490E-01	1.46830E-03	3.56170E-03
2.21530E+03	2.31990E-03	6.27600E-01	1.45590E-03	3.53170E-03
2.21540E+03	2.30730E-03	6.27710E-01	1.44830E-03	3.51320E-03
2.21550E+03	2.30050E-03	6.27810E-01	1.44430E-03	3.50350E-03
2.21560E+03	2.29770E-03	6.27920E-01	1.44280E-03	3.49980E-03
2.21570E+03	2.29700E-03	6.28030E-01	1.44260E-03	3.49930E-03
2.21580E+03	2.29660E-03	6.28140E-01	1.44260E-03	3.49930E-03
2.21590E+03	2.29490E-03	6.28240E-01	1.44170E-03	3.49730E-03
2.21600E+03	2.29060E-03	6.28350E-01	1.43930E-03	3.49130E-03
2.21610E+03	2.28270E-03	6.28450E-01	1.43460E-03	3.47990E-03
2.21620E+03	2.27080E-03	6.28540E-01	1.42730E-03	3.46220E-03
2.21630E+03	2.25450E-03	6.28640E-01	1.41730E-03	3.43800E-03
2.21640E+03	2.23400E-03	6.28730E-01	1.40460E-03	3.40720E-03
2.21650E+03	2.20950E-03	6.28830E-01	1.38940E-03	3.37030E-03
2.21660E+03	2.18140E-03	6.28930E-01	1.37190E-03	3.32790E-03
2.21670E+03	2.14990E-03	6.29020E-01	1.35230E-03	3.28050E-03
2.21680E+03	2.11540E-03	6.29120E-01	1.33080E-03	3.22820E-03
2.21690E+03	2.07760E-03	6.29210E-01	1.30730E-03	3.17110E-03
2.21700E+03	2.03660E-03	6.29310E-01	1.28160E-03	3.10890E-03
2.21710E+03	1.99180E-03	6.29410E-01	1.25370E-03	3.04110E-03
2.21720E+03	1.94280E-03	6.29520E-01	1.22310E-03	2.96680E-03
2.21730E+03	1.88910E-03	6.29630E-01	1.18940E-03	2.88530E-03
2.21740E+03	1.83000E-03	6.29730E-01	1.15240E-03	2.79550E-03
2.21750E+03	1.76490E-03	6.29840E-01	1.11160E-03	2.69650E-03
2.21760E+03	1.69320E-03	6.29950E-01	1.06660E-03	2.58740E-03
2.21770E+03	1.61450E-03	6.30050E-01	1.01720E-03	2.46750E-03
2.21780E+03	1.52860E-03	6.30160E-01	9.63270E-04	2.33670E-03
2.21790E+03	1.43570E-03	6.30260E-01	9.04880E-04	2.19500E-03
2.21800E+03	1.33680E-03	6.30380E-01	8.42720E-04	2.04420E-03
2.21810E+03	1.37000E-03	6.30500E-01	8.63750E-04	2.09530E-03
2.21820E+03	1.37900E-03	6.30620E-01	8.69660E-04	2.10960E-03
2.21830E+03	1.36790E-03	6.30740E-01	8.62820E-04	2.09300E-03
2.21840E+03	1.32680E-03	6.30860E-01	8.37060E-04	2.03050E-03
2.21850E+03	1.24800E-03	6.30990E-01	7.87480E-04	1.91020E-03
2.21860E+03	1.12670E-03	6.31110E-01	7.11080E-04	1.72490E-03
2.21870E+03	9.61960E-04	6.31230E-01	6.07220E-04	1.47300E-03
2.21880E+03	7.57310E-04	6.31350E-01	4.78130E-04	1.15980E-03

2.21890E+03	5.22110E-04	6.31480E-01	3.29700E-04	7.99770E-04
2.21900E+03	2.77820E-04	6.31600E-01	1.75470E-04	4.25650E-04
2.21910E+03	0.00000E+00	6.31720E-01	0.00000E+00	0.00000E+00
Channel 14				
Wavenumber	HIRS Filter Transmittance	Optical Element Transmittance	Product of the HIRS Filter and Optical Element Transmittances	Normalized Value of Column 4
2.17980E+03	0.00000E+00	6.00590E-01	0.00000E+00	0.00000E+00
2.17990E+03	5.29230E-04	6.00680E-01	3.17900E-04	8.05640E-04
2.18000E+03	4.09970E-04	6.00760E-01	2.46290E-04	6.24160E-04
2.18010E+03	3.97010E-04	6.00800E-01	2.38520E-04	6.04480E-04
2.18020E+03	4.94690E-04	6.00840E-01	2.97230E-04	7.53260E-04
2.18030E+03	6.98050E-04	6.00880E-01	4.19440E-04	1.06300E-03
2.18040E+03	9.94060E-04	6.00920E-01	5.97350E-04	1.51390E-03
2.18050E+03	1.36260E-03	6.00960E-01	8.18890E-04	2.07530E-03
2.18060E+03	1.77820E-03	6.01000E-01	1.06870E-03	2.70840E-03
2.18070E+03	2.21130E-03	6.01040E-01	1.32910E-03	3.36830E-03
2.18080E+03	2.63120E-03	6.01080E-01	1.58160E-03	4.00810E-03
2.18090E+03	2.23090E-03	6.01120E-01	1.34110E-03	3.39870E-03
2.18100E+03	2.31010E-03	6.01160E-01	1.38880E-03	3.51950E-03
2.18110E+03	2.38920E-03	6.01210E-01	1.43640E-03	3.64030E-03
2.18120E+03	2.46780E-03	6.01250E-01	1.48370E-03	3.76020E-03
2.18130E+03	2.54550E-03	6.01290E-01	1.53060E-03	3.87890E-03
2.18140E+03	2.62260E-03	6.01330E-01	1.57700E-03	3.99660E-03
2.18150E+03	2.69930E-03	6.01370E-01	1.62330E-03	4.11380E-03
2.18160E+03	2.77630E-03	6.01410E-01	1.66970E-03	4.23150E-03
2.18170E+03	2.85430E-03	6.01450E-01	1.71670E-03	4.35070E-03
2.18180E+03	2.93430E-03	6.01490E-01	1.76490E-03	4.47280E-03
2.18190E+03	3.01700E-03	6.01570E-01	1.81490E-03	4.59950E-03
2.18200E+03	3.10360E-03	6.01640E-01	1.86720E-03	4.73210E-03
2.18210E+03	3.19480E-03	6.01730E-01	1.92240E-03	4.87200E-03
2.18220E+03	3.29160E-03	6.01820E-01	1.98090E-03	5.02020E-03
2.18230E+03	3.39450E-03	6.01910E-01	2.04320E-03	5.17790E-03
2.18240E+03	3.50400E-03	6.02000E-01	2.10940E-03	5.34570E-03
2.18250E+03	3.62030E-03	6.02080E-01	2.17970E-03	5.52400E-03
2.18260E+03	3.74340E-03	6.02170E-01	2.25420E-03	5.71270E-03
2.18270E+03	3.87310E-03	6.02260E-01	2.33260E-03	5.91140E-03
2.18280E+03	4.00870E-03	6.02350E-01	2.41460E-03	6.11930E-03
2.18290E+03	4.14940E-03	6.02440E-01	2.49980E-03	6.33510E-03
2.18300E+03	4.29420E-03	6.02520E-01	2.58740E-03	6.55710E-03
2.18310E+03	4.44180E-03	6.02610E-01	2.67670E-03	6.78350E-03
2.18320E+03	4.59080E-03	6.02700E-01	2.76690E-03	7.01200E-03

2.18330E+03	4.73960E-03	6.02780E-01	2.85690E-03	7.24030E-03
2.18340E+03	4.88650E-03	6.02870E-01	2.94590E-03	7.46580E-03
2.18350E+03	5.03010E-03	6.02950E-01	3.03290E-03	7.68620E-03
2.18360E+03	5.16860E-03	6.03040E-01	3.11690E-03	7.89910E-03
2.18370E+03	5.30080E-03	6.03130E-01	3.19710E-03	8.10220E-03
2.18380E+03	5.42540E-03	6.03210E-01	3.27270E-03	8.29380E-03
2.18390E+03	5.54120E-03	6.03300E-01	3.34300E-03	8.47210E-03
2.18400E+03	5.64760E-03	6.03390E-01	3.40770E-03	8.63610E-03
2.18410E+03	5.74400E-03	6.03480E-01	3.46640E-03	8.78480E-03
2.18420E+03	5.83010E-03	6.03570E-01	3.51890E-03	8.91780E-03
2.18430E+03	5.90610E-03	6.03660E-01	3.56520E-03	9.03530E-03
2.18440E+03	5.97210E-03	6.03750E-01	3.60560E-03	9.13760E-03
2.18450E+03	6.02870E-03	6.03840E-01	3.64030E-03	9.22560E-03
2.18460E+03	6.07670E-03	6.03930E-01	3.66990E-03	9.30040E-03
2.18470E+03	6.11700E-03	6.04020E-01	3.69480E-03	9.36360E-03
2.18480E+03	6.15080E-03	6.04110E-01	3.71580E-03	9.41680E-03
2.18490E+03	6.17940E-03	6.04200E-01	3.73360E-03	9.46190E-03
2.18500E+03	6.20410E-03	6.04290E-01	3.74900E-03	9.50110E-03
2.18510E+03	6.22630E-03	6.04340E-01	3.76280E-03	9.53600E-03
2.18520E+03	6.24760E-03	6.04400E-01	3.77600E-03	9.56950E-03
2.18530E+03	6.26970E-03	6.04450E-01	3.78970E-03	9.60410E-03
2.18540E+03	6.29410E-03	6.04500E-01	3.80480E-03	9.64250E-03
2.18550E+03	6.32270E-03	6.04560E-01	3.82250E-03	9.68720E-03
2.18560E+03	6.35740E-03	6.04610E-01	3.84380E-03	9.74110E-03
2.18570E+03	6.39990E-03	6.04670E-01	3.86980E-03	9.80720E-03
2.18580E+03	6.45240E-03	6.04720E-01	3.90190E-03	9.88850E-03
2.18590E+03	6.51670E-03	6.04780E-01	3.94120E-03	9.98800E-03
2.18600E+03	6.59510E-03	6.04830E-01	3.98890E-03	1.01090E-02
2.18610E+03	6.68950E-03	6.04870E-01	4.04620E-03	1.02540E-02
2.18620E+03	6.80180E-03	6.04900E-01	4.11450E-03	1.04270E-02
2.18630E+03	6.93400E-03	6.04950E-01	4.19470E-03	1.06310E-02
2.18640E+03	7.08760E-03	6.05010E-01	4.28810E-03	1.08670E-02
2.18650E+03	7.26410E-03	6.05080E-01	4.39530E-03	1.11390E-02
2.18660E+03	7.46430E-03	6.05140E-01	4.51700E-03	1.14470E-02
2.18670E+03	7.68900E-03	6.05210E-01	4.65350E-03	1.17930E-02
2.18680E+03	7.93830E-03	6.05270E-01	4.80480E-03	1.21770E-02
2.18690E+03	8.21170E-03	6.05340E-01	4.97090E-03	1.25980E-02
2.18700E+03	8.50850E-03	6.05400E-01	5.15100E-03	1.30540E-02
2.18710E+03	8.82700E-03	6.05470E-01	5.34450E-03	1.35440E-02
2.18720E+03	9.16540E-03	6.05540E-01	5.55000E-03	1.40650E-02
2.18730E+03	9.52130E-03	6.05610E-01	5.76620E-03	1.46130E-02
2.18740E+03	9.89210E-03	6.05680E-01	5.99140E-03	1.51840E-02
2.18750E+03	1.02750E-02	6.05750E-01	6.22390E-03	1.57730E-02

2.18760E+03	1.06660E-02	6.05820E-01	6.46190E-03	1.63760E-02
2.18770E+03	1.10640E-02	6.05890E-01	6.70370E-03	1.69890E-02
2.18780E+03	1.14650E-02	6.05960E-01	6.94740E-03	1.76070E-02
2.18790E+03	1.18670E-02	6.06030E-01	7.19190E-03	1.82260E-02
2.18800E+03	1.22690E-02	6.06100E-01	7.43600E-03	1.88450E-02
2.18810E+03	1.26680E-02	6.06270E-01	7.67990E-03	1.94630E-02
2.18820E+03	1.30640E-02	6.06430E-01	7.92240E-03	2.00780E-02
2.18830E+03	1.34580E-02	6.06590E-01	8.16350E-03	2.06890E-02
2.18840E+03	1.38500E-02	6.06750E-01	8.40380E-03	2.12970E-02
2.18850E+03	1.42430E-02	6.06940E-01	8.64450E-03	2.19070E-02
2.18860E+03	1.46380E-02	6.07120E-01	8.88670E-03	2.25210E-02
2.18870E+03	1.50370E-02	6.07300E-01	9.13210E-03	2.31430E-02
2.18880E+03	1.54460E-02	6.07480E-01	9.38290E-03	2.37790E-02
2.18890E+03	1.58660E-02	6.07660E-01	9.64110E-03	2.44330E-02
2.18900E+03	1.63020E-02	6.07850E-01	9.90910E-03	2.51120E-02
2.18910E+03	1.67570E-02	6.08030E-01	1.01890E-02	2.58220E-02
2.18920E+03	1.72360E-02	6.08220E-01	1.04830E-02	2.65680E-02
2.18930E+03	1.77410E-02	6.08400E-01	1.07940E-02	2.73550E-02
2.18940E+03	1.82760E-02	6.08580E-01	1.11230E-02	2.81880E-02
2.18950E+03	1.88430E-02	6.08770E-01	1.14710E-02	2.90710E-02
2.18960E+03	1.94440E-02	6.08950E-01	1.18410E-02	3.00070E-02
2.18970E+03	2.00810E-02	6.09140E-01	1.22320E-02	3.10000E-02
2.18980E+03	2.07560E-02	6.09320E-01	1.26470E-02	3.20510E-02
2.18990E+03	2.14690E-02	6.09510E-01	1.30850E-02	3.31620E-02
2.19000E+03	2.22200E-02	6.09690E-01	1.35480E-02	3.43330E-02
2.19010E+03	2.30120E-02	6.09750E-01	1.40320E-02	3.55600E-02
2.19020E+03	2.38440E-02	6.09810E-01	1.45400E-02	3.68490E-02
2.19030E+03	2.47160E-02	6.09880E-01	1.50740E-02	3.82010E-02
2.19040E+03	2.56300E-02	6.09940E-01	1.56330E-02	3.96170E-02
2.19050E+03	2.65860E-02	6.10000E-01	1.62170E-02	4.10990E-02
2.19060E+03	2.75850E-02	6.10060E-01	1.68290E-02	4.26490E-02
2.19070E+03	2.86300E-02	6.10120E-01	1.74680E-02	4.42680E-02
2.19080E+03	2.97220E-02	6.10180E-01	1.81360E-02	4.59620E-02
2.19090E+03	3.08640E-02	6.10240E-01	1.88340E-02	4.77310E-02
2.19100E+03	3.10900E-02	6.10300E-01	1.89740E-02	4.80860E-02
2.19110E+03	3.24310E-02	6.10360E-01	1.97950E-02	5.01650E-02
2.19120E+03	3.38140E-02	6.10420E-01	2.06410E-02	5.23090E-02
2.19130E+03	3.52290E-02	6.10480E-01	2.15070E-02	5.45040E-02
2.19140E+03	3.66700E-02	6.10540E-01	2.23890E-02	5.67390E-02
2.19150E+03	3.81350E-02	6.10600E-01	2.32850E-02	5.90100E-02
2.19160E+03	3.96230E-02	6.10660E-01	2.41960E-02	6.13190E-02
2.19170E+03	4.11400E-02	6.10710E-01	2.51250E-02	6.36730E-02
2.19180E+03	4.26960E-02	6.10770E-01	2.60780E-02	6.60880E-02

2.19190E+03	4.43050E-02	6.10830E-01	2.70630E-02	6.85850E-02
2.19200E+03	4.59810E-02	6.10890E-01	2.80890E-02	7.11860E-02
2.19210E+03	4.77410E-02	6.10890E-01	2.91650E-02	7.39120E-02
2.19220E+03	4.96040E-02	6.10890E-01	3.03020E-02	7.67950E-02
2.19230E+03	5.15840E-02	6.10830E-01	3.15090E-02	7.98530E-02
2.19240E+03	5.36960E-02	6.10760E-01	3.27950E-02	8.31110E-02
2.19250E+03	5.59480E-02	6.10680E-01	3.41660E-02	8.65870E-02
2.19260E+03	5.83480E-02	6.10600E-01	3.56270E-02	9.02890E-02
2.19270E+03	6.08950E-02	6.10530E-01	3.71780E-02	9.42190E-02
2.19280E+03	6.35880E-02	6.10450E-01	3.88170E-02	9.83730E-02
2.19290E+03	6.64180E-02	6.10350E-01	4.05390E-02	1.02740E-01
2.19300E+03	6.93780E-02	6.10260E-01	4.23380E-02	1.07300E-01
2.19310E+03	7.24550E-02	6.10160E-01	4.42090E-02	1.12040E-01
2.19320E+03	7.56390E-02	6.10060E-01	4.61450E-02	1.16940E-01
2.19330E+03	7.89210E-02	6.09970E-01	4.81390E-02	1.22000E-01
2.19340E+03	8.22940E-02	6.09870E-01	5.01880E-02	1.27190E-01
2.19350E+03	8.57550E-02	6.09770E-01	5.22910E-02	1.32520E-01
2.19360E+03	8.93070E-02	6.09670E-01	5.44480E-02	1.37990E-01
2.19370E+03	9.29580E-02	6.09580E-01	5.66650E-02	1.43610E-01
2.19380E+03	9.67220E-02	6.09480E-01	5.89500E-02	1.49400E-01
2.19390E+03	1.00620E-01	6.09380E-01	6.13130E-02	1.55380E-01
2.19400E+03	1.04660E-01	6.09300E-01	6.37690E-02	1.61610E-01
2.19410E+03	1.08880E-01	6.09340E-01	6.63440E-02	1.68130E-01
2.19420E+03	1.13300E-01	6.09380E-01	6.90420E-02	1.74970E-01
2.19430E+03	1.17940E-01	6.09420E-01	7.18750E-02	1.82150E-01
2.19440E+03	1.22820E-01	6.09460E-01	7.48570E-02	1.89710E-01
2.19450E+03	1.27970E-01	6.09510E-01	7.79980E-02	1.97670E-01
2.19460E+03	1.33380E-01	6.09550E-01	8.13030E-02	2.06040E-01
2.19470E+03	1.39070E-01	6.09590E-01	8.47740E-02	2.14840E-01
2.19480E+03	1.45020E-01	6.09630E-01	8.84080E-02	2.24050E-01
2.19490E+03	1.51230E-01	6.09670E-01	9.22020E-02	2.33660E-01
2.19500E+03	1.57680E-01	6.09710E-01	9.61420E-02	2.43650E-01
2.19510E+03	1.64360E-01	6.09810E-01	1.00230E-01	2.54000E-01
2.19520E+03	1.71230E-01	6.09910E-01	1.04430E-01	2.64660E-01
2.19530E+03	1.78260E-01	6.10010E-01	1.08740E-01	2.75580E-01
2.19540E+03	1.85440E-01	6.10100E-01	1.13140E-01	2.86720E-01
2.19550E+03	1.92730E-01	6.10200E-01	1.17610E-01	2.98050E-01
2.19560E+03	2.00120E-01	6.10300E-01	1.22130E-01	3.09520E-01
2.19570E+03	2.07580E-01	6.10400E-01	1.26710E-01	3.21110E-01
2.19580E+03	2.15110E-01	6.10500E-01	1.31320E-01	3.32810E-01
2.19590E+03	2.22690E-01	6.10590E-01	1.35980E-01	3.44600E-01
2.19600E+03	2.30330E-01	6.10690E-01	1.40660E-01	3.56480E-01
2.19610E+03	2.38030E-01	6.10750E-01	1.45380E-01	3.68430E-01

2.19620E+03	2.45800E-01	6.10790E-01	1.50130E-01	3.80470E-01
2.19630E+03	2.53630E-01	6.10830E-01	1.54930E-01	3.92630E-01
2.19640E+03	2.61550E-01	6.10870E-01	1.59780E-01	4.04910E-01
2.19650E+03	2.69560E-01	6.10920E-01	1.64680E-01	4.17330E-01
2.19660E+03	2.77650E-01	6.10960E-01	1.69630E-01	4.29900E-01
2.19670E+03	2.85840E-01	6.11000E-01	1.74650E-01	4.42600E-01
2.19680E+03	2.94110E-01	6.11050E-01	1.79710E-01	4.55440E-01
2.19690E+03	3.02450E-01	6.11090E-01	1.84820E-01	4.68390E-01
2.19700E+03	3.10850E-01	6.11130E-01	1.89970E-01	4.81440E-01
2.19710E+03	3.19280E-01	6.11180E-01	1.95140E-01	4.94540E-01
2.19720E+03	3.27730E-01	6.11230E-01	2.00320E-01	5.07660E-01
2.19730E+03	3.36160E-01	6.11220E-01	2.05470E-01	5.20710E-01
2.19740E+03	3.44540E-01	6.11220E-01	2.10590E-01	5.33680E-01
2.19750E+03	3.52850E-01	6.11210E-01	2.15660E-01	5.46550E-01
2.19760E+03	3.61060E-01	6.11200E-01	2.20680E-01	5.59270E-01
2.19770E+03	3.69150E-01	6.11200E-01	2.25630E-01	5.71800E-01
2.19780E+03	3.77110E-01	6.11190E-01	2.30490E-01	5.84120E-01
2.19790E+03	3.84930E-01	6.11190E-01	2.35270E-01	5.96230E-01
2.19800E+03	3.92610E-01	6.11180E-01	2.39950E-01	6.08110E-01
2.19810E+03	4.00140E-01	6.11130E-01	2.44540E-01	6.19730E-01
2.19820E+03	4.07540E-01	6.11090E-01	2.49040E-01	6.31130E-01
2.19830E+03	4.14810E-01	6.11040E-01	2.53470E-01	6.42350E-01
2.19840E+03	4.21980E-01	6.10990E-01	2.57830E-01	6.53400E-01
2.19850E+03	4.29060E-01	6.10940E-01	2.62130E-01	6.64310E-01
2.19860E+03	4.36060E-01	6.10890E-01	2.66380E-01	6.75090E-01
2.19870E+03	4.42980E-01	6.10850E-01	2.70600E-01	6.85760E-01
2.19880E+03	4.49850E-01	6.10800E-01	2.74770E-01	6.96340E-01
2.19890E+03	4.56670E-01	6.10750E-01	2.78910E-01	7.06830E-01
2.19900E+03	4.63410E-01	6.10700E-01	2.83010E-01	7.17220E-01
2.19910E+03	4.70090E-01	6.10660E-01	2.87060E-01	7.27500E-01
2.19920E+03	4.76680E-01	6.10610E-01	2.91070E-01	7.37640E-01
2.19930E+03	4.83160E-01	6.10560E-01	2.95000E-01	7.47610E-01
2.19940E+03	4.89510E-01	6.10510E-01	2.98850E-01	7.57380E-01
2.19950E+03	4.95700E-01	6.10560E-01	3.02660E-01	7.67020E-01
2.19960E+03	5.01710E-01	6.10610E-01	3.06350E-01	7.76380E-01
2.19970E+03	5.07510E-01	6.10660E-01	3.09920E-01	7.85410E-01
2.19980E+03	5.13080E-01	6.10710E-01	3.13340E-01	7.94100E-01
2.19990E+03	5.18400E-01	6.10760E-01	3.16620E-01	8.02400E-01
2.20000E+03	5.23470E-01	6.10820E-01	3.19740E-01	8.10320E-01
2.20010E+03	5.28270E-01	6.10990E-01	3.22770E-01	8.17980E-01
2.20020E+03	5.32800E-01	6.11170E-01	3.25630E-01	8.25240E-01
2.20030E+03	5.37080E-01	6.11340E-01	3.28340E-01	8.32100E-01
2.20040E+03	5.41110E-01	6.11520E-01	3.30900E-01	8.38580E-01

2.20050E+03	5.44910E-01	6.11690E-01	3.33310E-01	8.44710E-01
2.20060E+03	5.48490E-01	6.11860E-01	3.35600E-01	8.50510E-01
2.20070E+03	5.51880E-01	6.12040E-01	3.37770E-01	8.56010E-01
2.20080E+03	5.55100E-01	6.12210E-01	3.39840E-01	8.61250E-01
2.20090E+03	5.58160E-01	6.12390E-01	3.41810E-01	8.66240E-01
2.20100E+03	5.61080E-01	6.12560E-01	3.43700E-01	8.71020E-01
2.20110E+03	5.63870E-01	6.12730E-01	3.45500E-01	8.75600E-01
2.20120E+03	5.66530E-01	6.12910E-01	3.47230E-01	8.79980E-01
2.20130E+03	5.69080E-01	6.13080E-01	3.48890E-01	8.84190E-01
2.20140E+03	5.71500E-01	6.13260E-01	3.50480E-01	8.88200E-01
2.20150E+03	5.73800E-01	6.13430E-01	3.51980E-01	8.92020E-01
2.20160E+03	5.75960E-01	6.13600E-01	3.53410E-01	8.95640E-01
2.20170E+03	5.77980E-01	6.13710E-01	3.54710E-01	8.98940E-01
2.20180E+03	5.79850E-01	6.13820E-01	3.55930E-01	9.02010E-01
2.20190E+03	5.81560E-01	6.13930E-01	3.57040E-01	9.04840E-01
2.20200E+03	5.83110E-01	6.14040E-01	3.58050E-01	9.07410E-01
2.20210E+03	5.84490E-01	6.14230E-01	3.59010E-01	9.09830E-01
2.20220E+03	5.85700E-01	6.14430E-01	3.59870E-01	9.12000E-01
2.20230E+03	5.86740E-01	6.14630E-01	3.60620E-01	9.13920E-01
2.20240E+03	5.87620E-01	6.14820E-01	3.61280E-01	9.15580E-01
2.20250E+03	5.88340E-01	6.15020E-01	3.61840E-01	9.17010E-01
2.20260E+03	5.88930E-01	6.15220E-01	3.62320E-01	9.18210E-01
2.20270E+03	5.89380E-01	6.15420E-01	3.62710E-01	9.19210E-01
2.20280E+03	5.89720E-01	6.15610E-01	3.63040E-01	9.20040E-01
2.20290E+03	5.89950E-01	6.15810E-01	3.63300E-01	9.20700E-01
2.20300E+03	5.90100E-01	6.16010E-01	3.63510E-01	9.21220E-01
2.20310E+03	5.90170E-01	6.16200E-01	3.63660E-01	9.21620E-01
2.20320E+03	5.90160E-01	6.16400E-01	3.63780E-01	9.21910E-01
2.20330E+03	5.90100E-01	6.16590E-01	3.63850E-01	9.22100E-01
2.20340E+03	5.89990E-01	6.16790E-01	3.63900E-01	9.22220E-01
2.20350E+03	5.89820E-01	6.16990E-01	3.63910E-01	9.22250E-01
2.20360E+03	5.89610E-01	6.17180E-01	3.63900E-01	9.22210E-01
2.20370E+03	5.89360E-01	6.17380E-01	3.63860E-01	9.22110E-01
2.20380E+03	5.89070E-01	6.17570E-01	3.63790E-01	9.21950E-01
2.20390E+03	5.88740E-01	6.17740E-01	3.63690E-01	9.21700E-01
2.20400E+03	5.88390E-01	6.17920E-01	3.63580E-01	9.21400E-01
2.20410E+03	5.88010E-01	6.18100E-01	3.63450E-01	9.21080E-01
2.20420E+03	5.87620E-01	6.18280E-01	3.63310E-01	9.20740E-01
2.20430E+03	5.87230E-01	6.18360E-01	3.63120E-01	9.20240E-01
2.20440E+03	5.86840E-01	6.18440E-01	3.62930E-01	9.19750E-01
2.20450E+03	5.86480E-01	6.18510E-01	3.62750E-01	9.19300E-01
2.20460E+03	5.86160E-01	6.18590E-01	3.62590E-01	9.18900E-01
2.20470E+03	5.85890E-01	6.18660E-01	3.62470E-01	9.18590E-01

2.20480E+03	5.85680E-01	6.18730E-01	3.62380E-01	9.18370E-01
2.20490E+03	5.85550E-01	6.18810E-01	3.62340E-01	9.18270E-01
2.20500E+03	5.85490E-01	6.18880E-01	3.62350E-01	9.18290E-01
2.20510E+03	5.85530E-01	6.18960E-01	3.62420E-01	9.18470E-01
2.20520E+03	5.85650E-01	6.19050E-01	3.62550E-01	9.18790E-01
2.20530E+03	5.85870E-01	6.19130E-01	3.62730E-01	9.19250E-01
2.20540E+03	5.86160E-01	6.19210E-01	3.62960E-01	9.19840E-01
2.20550E+03	5.86530E-01	6.19290E-01	3.63240E-01	9.20540E-01
2.20560E+03	5.86970E-01	6.19380E-01	3.63560E-01	9.21360E-01
2.20570E+03	5.87470E-01	6.19460E-01	3.63910E-01	9.22260E-01
2.20580E+03	5.88010E-01	6.19540E-01	3.64300E-01	9.23220E-01
2.20590E+03	5.88580E-01	6.19620E-01	3.64700E-01	9.24250E-01
2.20600E+03	5.89180E-01	6.19710E-01	3.65120E-01	9.25310E-01
2.20610E+03	5.89790E-01	6.19760E-01	3.65530E-01	9.26340E-01
2.20620E+03	5.90410E-01	6.19800E-01	3.65940E-01	9.27390E-01
2.20630E+03	5.91050E-01	6.19850E-01	3.66360E-01	9.28460E-01
2.20640E+03	5.91690E-01	6.19900E-01	3.66790E-01	9.29540E-01
2.20650E+03	5.92350E-01	6.19950E-01	3.67220E-01	9.30640E-01
2.20660E+03	5.93020E-01	6.20000E-01	3.67670E-01	9.31770E-01
2.20670E+03	5.93720E-01	6.20040E-01	3.68130E-01	9.32940E-01
2.20680E+03	5.94440E-01	6.20090E-01	3.68610E-01	9.34160E-01
2.20690E+03	5.95210E-01	6.20140E-01	3.69110E-01	9.35440E-01
2.20700E+03	5.96020E-01	6.20190E-01	3.69650E-01	9.36780E-01
2.20710E+03	5.96880E-01	6.20240E-01	3.70210E-01	9.38220E-01
2.20720E+03	5.97800E-01	6.20300E-01	3.70810E-01	9.39730E-01
2.20730E+03	5.98760E-01	6.20350E-01	3.71440E-01	9.41330E-01
2.20740E+03	5.99770E-01	6.20400E-01	3.72100E-01	9.43000E-01
2.20750E+03	6.00820E-01	6.20460E-01	3.72780E-01	9.44730E-01
2.20760E+03	6.01900E-01	6.20510E-01	3.73490E-01	9.46520E-01
2.20770E+03	6.03000E-01	6.20570E-01	3.74210E-01	9.48340E-01
2.20780E+03	6.04120E-01	6.20620E-01	3.74930E-01	9.50180E-01
2.20790E+03	6.05240E-01	6.20680E-01	3.75660E-01	9.52020E-01
2.20800E+03	6.06340E-01	6.20730E-01	3.76370E-01	9.53830E-01
2.20810E+03	6.07420E-01	6.20770E-01	3.77070E-01	9.55600E-01
2.20820E+03	6.08480E-01	6.20810E-01	3.77750E-01	9.57310E-01
2.20830E+03	6.09490E-01	6.20800E-01	3.78380E-01	9.58910E-01
2.20840E+03	6.10470E-01	6.20800E-01	3.78980E-01	9.60440E-01
2.20850E+03	6.11420E-01	6.20800E-01	3.79560E-01	9.61920E-01
2.20860E+03	6.12330E-01	6.20790E-01	3.80130E-01	9.63340E-01
2.20870E+03	6.13210E-01	6.20790E-01	3.80670E-01	9.64720E-01
2.20880E+03	6.14070E-01	6.20780E-01	3.81200E-01	9.66070E-01
2.20890E+03	6.14920E-01	6.20780E-01	3.81730E-01	9.67410E-01
2.20900E+03	6.15780E-01	6.20770E-01	3.82260E-01	9.68740E-01

2.20910E+03	6.16640E-01	6.20770E-01	3.82790E-01	9.70100E-01
2.20920E+03	6.17520E-01	6.20770E-01	3.83340E-01	9.71480E-01
2.20930E+03	6.18430E-01	6.20770E-01	3.83900E-01	9.72910E-01
2.20940E+03	6.19360E-01	6.20770E-01	3.84480E-01	9.74370E-01
2.20950E+03	6.20320E-01	6.20770E-01	3.85080E-01	9.75890E-01
2.20960E+03	6.21320E-01	6.20770E-01	3.85690E-01	9.77450E-01
2.20970E+03	6.22330E-01	6.20770E-01	3.86320E-01	9.79050E-01
2.20980E+03	6.23370E-01	6.20770E-01	3.86970E-01	9.80680E-01
2.20990E+03	6.24410E-01	6.20770E-01	3.87610E-01	9.82320E-01
2.21000E+03	6.25460E-01	6.20770E-01	3.88260E-01	9.83960E-01
2.21010E+03	6.26480E-01	6.20800E-01	3.88920E-01	9.85630E-01
2.21020E+03	6.27480E-01	6.20840E-01	3.89560E-01	9.87260E-01
2.21030E+03	6.28440E-01	6.20870E-01	3.90180E-01	9.88820E-01
2.21040E+03	6.29340E-01	6.20900E-01	3.90760E-01	9.90300E-01
2.21050E+03	6.30180E-01	6.21030E-01	3.91360E-01	9.91820E-01
2.21060E+03	6.30950E-01	6.21150E-01	3.91910E-01	9.93220E-01
2.21070E+03	6.31630E-01	6.21270E-01	3.92420E-01	9.94490E-01
2.21080E+03	6.32230E-01	6.21400E-01	3.92870E-01	9.95630E-01
2.21090E+03	6.32740E-01	6.21520E-01	3.93260E-01	9.96630E-01
2.21100E+03	6.33150E-01	6.21650E-01	3.93590E-01	9.97480E-01
2.21110E+03	6.33470E-01	6.21800E-01	3.93890E-01	9.98230E-01
2.21120E+03	6.33710E-01	6.21950E-01	3.94130E-01	9.98840E-01
2.21130E+03	6.33850E-01	6.22100E-01	3.94320E-01	9.99310E-01
2.21140E+03	6.33920E-01	6.22250E-01	3.94450E-01	9.99650E-01
2.21150E+03	6.33900E-01	6.22400E-01	3.94540E-01	9.99880E-01
2.21160E+03	6.33820E-01	6.22550E-01	3.94590E-01	9.99990E-01
2.21170E+03	6.33670E-01	6.22700E-01	3.94590E-01	1.00000E+00
2.21180E+03	6.33460E-01	6.22860E-01	3.94560E-01	9.99910E-01
2.21190E+03	6.33200E-01	6.23010E-01	3.94490E-01	9.99740E-01
2.21200E+03	6.32880E-01	6.23160E-01	3.94390E-01	9.99480E-01
2.21210E+03	6.32520E-01	6.23320E-01	3.94260E-01	9.99170E-01
2.21220E+03	6.32110E-01	6.23480E-01	3.94110E-01	9.98780E-01
2.21230E+03	6.31650E-01	6.23640E-01	3.93930E-01	9.98310E-01
2.21240E+03	6.31150E-01	6.23800E-01	3.93710E-01	9.97770E-01
2.21250E+03	6.30590E-01	6.23970E-01	3.93470E-01	9.97150E-01
2.21260E+03	6.29980E-01	6.24130E-01	3.93190E-01	9.96440E-01
2.21270E+03	6.29300E-01	6.24260E-01	3.92850E-01	9.95580E-01
2.21280E+03	6.28550E-01	6.24390E-01	3.92470E-01	9.94610E-01
2.21290E+03	6.27730E-01	6.24530E-01	3.92030E-01	9.93510E-01
2.21300E+03	6.26800E-01	6.24660E-01	3.91540E-01	9.92270E-01
2.21310E+03	6.25780E-01	6.24790E-01	3.90980E-01	9.90850E-01
2.21320E+03	6.24630E-01	6.24920E-01	3.90350E-01	9.89250E-01
2.21330E+03	6.23350E-01	6.25060E-01	3.89630E-01	9.87440E-01

2.21340E+03	6.21930E-01	6.25200E-01	3.88830E-01	9.85400E-01
2.21350E+03	6.20350E-01	6.25340E-01	3.87930E-01	9.83110E-01
2.21360E+03	6.18600E-01	6.25480E-01	3.86920E-01	9.80560E-01
2.21370E+03	6.16670E-01	6.25620E-01	3.85800E-01	9.77720E-01
2.21380E+03	6.14550E-01	6.25760E-01	3.84560E-01	9.74580E-01
2.21390E+03	6.12250E-01	6.25900E-01	3.83210E-01	9.71150E-01
2.21400E+03	6.09760E-01	6.26040E-01	3.81730E-01	9.67410E-01
2.21410E+03	6.07080E-01	6.26170E-01	3.80130E-01	9.63360E-01
2.21420E+03	6.04220E-01	6.26300E-01	3.78420E-01	9.59020E-01
2.21430E+03	6.01180E-01	6.26430E-01	3.76590E-01	9.54390E-01
2.21440E+03	5.97970E-01	6.26560E-01	3.74660E-01	9.49490E-01
2.21450E+03	5.94600E-01	6.26690E-01	3.72630E-01	9.44340E-01
2.21460E+03	5.91090E-01	6.26820E-01	3.70500E-01	9.38960E-01
2.21470E+03	5.87440E-01	6.26950E-01	3.68290E-01	9.33360E-01
2.21480E+03	5.83670E-01	6.27080E-01	3.66010E-01	9.27560E-01
2.21490E+03	5.79780E-01	6.27180E-01	3.63620E-01	9.21520E-01
2.21500E+03	5.75790E-01	6.27280E-01	3.61180E-01	9.15320E-01
2.21510E+03	5.71690E-01	6.27380E-01	3.58670E-01	9.08970E-01
2.21520E+03	5.67500E-01	6.27490E-01	3.56100E-01	9.02450E-01
2.21530E+03	5.63210E-01	6.27600E-01	3.53470E-01	8.95790E-01
2.21540E+03	5.58820E-01	6.27710E-01	3.50780E-01	8.88960E-01
2.21550E+03	5.54340E-01	6.27810E-01	3.48020E-01	8.81980E-01
2.21560E+03	5.49750E-01	6.27920E-01	3.45200E-01	8.74830E-01
2.21570E+03	5.45060E-01	6.28030E-01	3.42310E-01	8.67510E-01
2.21580E+03	5.40250E-01	6.28140E-01	3.39350E-01	8.60000E-01
2.21590E+03	5.35320E-01	6.28240E-01	3.36310E-01	8.52310E-01
2.21600E+03	5.30270E-01	6.28350E-01	3.33200E-01	8.44410E-01
2.21610E+03	5.25100E-01	6.28450E-01	3.30000E-01	8.36300E-01
2.21620E+03	5.19800E-01	6.28540E-01	3.26720E-01	8.27990E-01
2.21630E+03	5.14370E-01	6.28640E-01	3.23350E-01	8.19470E-01
2.21640E+03	5.08820E-01	6.28730E-01	3.19910E-01	8.10740E-01
2.21650E+03	5.03140E-01	6.28830E-01	3.16390E-01	8.01820E-01
2.21660E+03	4.97340E-01	6.28930E-01	3.12790E-01	7.92690E-01
2.21670E+03	4.91420E-01	6.29020E-01	3.09110E-01	7.83380E-01
2.21680E+03	4.85390E-01	6.29120E-01	3.05370E-01	7.73880E-01
2.21690E+03	4.79250E-01	6.29210E-01	3.01550E-01	7.64200E-01
2.21700E+03	4.73000E-01	6.29310E-01	2.97660E-01	7.54360E-01
2.21710E+03	4.66650E-01	6.29410E-01	2.93720E-01	7.44360E-01
2.21720E+03	4.60200E-01	6.29520E-01	2.89710E-01	7.34200E-01
2.21730E+03	4.53660E-01	6.29630E-01	2.85630E-01	7.23880E-01
2.21740E+03	4.47020E-01	6.29730E-01	2.81500E-01	7.13400E-01
2.21750E+03	4.40290E-01	6.29840E-01	2.77310E-01	7.02780E-01
2.21760E+03	4.33470E-01	6.29950E-01	2.73060E-01	6.92010E-01

2.21770E+03	4.26560E-01	6.30050E-01	2.68760E-01	6.81100E-01
2.21780E+03	4.19580E-01	6.30160E-01	2.64400E-01	6.70060E-01
2.21790E+03	4.12520E-01	6.30260E-01	2.60000E-01	6.58900E-01
2.21800E+03	4.05400E-01	6.30380E-01	2.55550E-01	6.47640E-01
2.21810E+03	3.98220E-01	6.30500E-01	2.51080E-01	6.36300E-01
2.21820E+03	3.91000E-01	6.30620E-01	2.46570E-01	6.24880E-01
2.21830E+03	3.83750E-01	6.30740E-01	2.42040E-01	6.13410E-01
2.21840E+03	3.76470E-01	6.30860E-01	2.37500E-01	6.01900E-01
2.21850E+03	3.69200E-01	6.30990E-01	2.32960E-01	5.90380E-01
2.21860E+03	3.61930E-01	6.31110E-01	2.28420E-01	5.78870E-01
2.21870E+03	3.54680E-01	6.31230E-01	2.23890E-01	5.67390E-01
2.21880E+03	3.47470E-01	6.31350E-01	2.19370E-01	5.55950E-01
2.21890E+03	3.40290E-01	6.31480E-01	2.14880E-01	5.44570E-01
2.21900E+03	3.33140E-01	6.31600E-01	2.10410E-01	5.33250E-01
2.21910E+03	3.26050E-01	6.31720E-01	2.05970E-01	5.21980E-01
2.21920E+03	3.18980E-01	6.31840E-01	2.01550E-01	5.10770E-01
2.21930E+03	3.11960E-01	6.31920E-01	1.97130E-01	4.99590E-01
2.21940E+03	3.04950E-01	6.32010E-01	1.92730E-01	4.88440E-01
2.21950E+03	2.97970E-01	6.32100E-01	1.88350E-01	4.77320E-01
2.21960E+03	2.91000E-01	6.32180E-01	1.83960E-01	4.66210E-01
2.21970E+03	2.84020E-01	6.32270E-01	1.79580E-01	4.55100E-01
2.21980E+03	2.77040E-01	6.32360E-01	1.75190E-01	4.43970E-01
2.21990E+03	2.70050E-01	6.32440E-01	1.70790E-01	4.32830E-01
2.22000E+03	2.63050E-01	6.32530E-01	1.66390E-01	4.21670E-01
2.22010E+03	2.56050E-01	6.32590E-01	1.61980E-01	4.10490E-01
2.22020E+03	2.49050E-01	6.32660E-01	1.57560E-01	3.99310E-01
2.22030E+03	2.42070E-01	6.32730E-01	1.53160E-01	3.88160E-01
2.22040E+03	2.35120E-01	6.32810E-01	1.48790E-01	3.77060E-01
2.22050E+03	2.28230E-01	6.32880E-01	1.44440E-01	3.66050E-01
2.22060E+03	2.21410E-01	6.32960E-01	1.40140E-01	3.55160E-01
2.22070E+03	2.14690E-01	6.33030E-01	1.35910E-01	3.44430E-01
2.22080E+03	2.08100E-01	6.33110E-01	1.31750E-01	3.33880E-01
2.22090E+03	2.01640E-01	6.33180E-01	1.27680E-01	3.23570E-01
2.22100E+03	1.95350E-01	6.33260E-01	1.23710E-01	3.13500E-01
2.22110E+03	1.89230E-01	6.33330E-01	1.19840E-01	3.03720E-01
2.22120E+03	1.83290E-01	6.33400E-01	1.16100E-01	2.94220E-01
2.22130E+03	1.77530E-01	6.33470E-01	1.12460E-01	2.85010E-01
2.22140E+03	1.71960E-01	6.33550E-01	1.08950E-01	2.76100E-01
2.22150E+03	1.66570E-01	6.33650E-01	1.05550E-01	2.67480E-01
2.22160E+03	1.61340E-01	6.33760E-01	1.02250E-01	2.59130E-01
2.22170E+03	1.56260E-01	6.33870E-01	9.90470E-02	2.51010E-01
2.22180E+03	1.51310E-01	6.33980E-01	9.59290E-02	2.43110E-01
2.22190E+03	1.46490E-01	6.34080E-01	9.28850E-02	2.35400E-01

2.22200E+03	1.41760E-01	6.34190E-01	8.99050E-02	2.27840E-01
2.22210E+03	1.37130E-01	6.34280E-01	8.69790E-02	2.20430E-01
2.22220E+03	1.32580E-01	6.34370E-01	8.41030E-02	2.13140E-01
2.22230E+03	1.28100E-01	6.34470E-01	8.12730E-02	2.05970E-01
2.22240E+03	1.23690E-01	6.34560E-01	7.84870E-02	1.98910E-01
2.22250E+03	1.19350E-01	6.34650E-01	7.57480E-02	1.91970E-01
2.22260E+03	1.15100E-01	6.34750E-01	7.30580E-02	1.85150E-01
2.22270E+03	1.10930E-01	6.34840E-01	7.04250E-02	1.78480E-01
2.22280E+03	1.06870E-01	6.34930E-01	6.78550E-02	1.71960E-01
2.22290E+03	1.02920E-01	6.35030E-01	6.53580E-02	1.65630E-01
2.22300E+03	9.91000E-02	6.35120E-01	6.29400E-02	1.59510E-01
2.22310E+03	9.54180E-02	6.35210E-01	6.06110E-02	1.53600E-01
2.22320E+03	9.18840E-02	6.35310E-01	5.83750E-02	1.47940E-01
2.22330E+03	8.85050E-02	6.35400E-01	5.62360E-02	1.42520E-01
2.22340E+03	8.52810E-02	6.35490E-01	5.41960E-02	1.37350E-01
2.22350E+03	8.22130E-02	6.35590E-01	5.22540E-02	1.32420E-01
2.22360E+03	7.92940E-02	6.35680E-01	5.04050E-02	1.27740E-01
2.22370E+03	7.65140E-02	6.35750E-01	4.86440E-02	1.23280E-01
2.22380E+03	7.38630E-02	6.35820E-01	4.69630E-02	1.19020E-01
2.22390E+03	7.13260E-02	6.35890E-01	4.53550E-02	1.14940E-01
2.22400E+03	6.88890E-02	6.35960E-01	4.38110E-02	1.11030E-01
2.22410E+03	6.65380E-02	6.36050E-01	4.23220E-02	1.07250E-01
2.22420E+03	6.42600E-02	6.36140E-01	4.08790E-02	1.03600E-01
2.22430E+03	6.20450E-02	6.36230E-01	3.94750E-02	1.00040E-01
2.22440E+03	5.98840E-02	6.36320E-01	3.81060E-02	9.65700E-02
2.22450E+03	5.77720E-02	6.36410E-01	3.67670E-02	9.31770E-02
2.22460E+03	5.57080E-02	6.36500E-01	3.54580E-02	8.98600E-02
2.22470E+03	5.36910E-02	6.36590E-01	3.41790E-02	8.66200E-02
2.22480E+03	5.17250E-02	6.36680E-01	3.29330E-02	8.34610E-02
2.22490E+03	4.98160E-02	6.36770E-01	3.17210E-02	8.03900E-02
2.22500E+03	4.79670E-02	6.36860E-01	3.05480E-02	7.74180E-02
2.22510E+03	4.61850E-02	6.36950E-01	2.94180E-02	7.45520E-02
2.22520E+03	4.44740E-02	6.37040E-01	2.83320E-02	7.18000E-02
2.22530E+03	4.28380E-02	6.37130E-01	2.72930E-02	6.91680E-02
2.22540E+03	4.12760E-02	6.37220E-01	2.63020E-02	6.66570E-02
2.22550E+03	3.97900E-02	6.37310E-01	2.53590E-02	6.42650E-02
2.22560E+03	3.83750E-02	6.37390E-01	2.44600E-02	6.19890E-02
2.22570E+03	3.70270E-02	6.37480E-01	2.36040E-02	5.98190E-02
2.22580E+03	3.57390E-02	6.37570E-01	2.27860E-02	5.77460E-02
2.22590E+03	3.45030E-02	6.37660E-01	2.20010E-02	5.57570E-02
2.22600E+03	3.33130E-02	6.37730E-01	2.12450E-02	5.38400E-02
2.22610E+03	3.21610E-02	6.37760E-01	2.05110E-02	5.19810E-02
2.22620E+03	3.10420E-02	6.37790E-01	1.97980E-02	5.01740E-02

2.22630E+03	3.05980E-02	6.37820E-01	1.95160E-02	4.94590E-02
2.22640E+03	2.95240E-02	6.37850E-01	1.88320E-02	4.77260E-02
2.22650E+03	2.84960E-02	6.37880E-01	1.81770E-02	4.60660E-02
2.22660E+03	2.75120E-02	6.37910E-01	1.75500E-02	4.44770E-02
2.22670E+03	2.65700E-02	6.37940E-01	1.69500E-02	4.29550E-02
2.22680E+03	2.56670E-02	6.37970E-01	1.63750E-02	4.14980E-02
2.22690E+03	2.48020E-02	6.38000E-01	1.58240E-02	4.01010E-02
2.22700E+03	2.39720E-02	6.38030E-01	1.52950E-02	3.87610E-02
2.22710E+03	2.31760E-02	6.38060E-01	1.47870E-02	3.74750E-02
2.22720E+03	2.24100E-02	6.38080E-01	1.43000E-02	3.62390E-02
2.22730E+03	2.16740E-02	6.38100E-01	1.38300E-02	3.50500E-02
2.22740E+03	2.09660E-02	6.38110E-01	1.33790E-02	3.39050E-02
2.22750E+03	2.02850E-02	6.38130E-01	1.29440E-02	3.28040E-02
2.22760E+03	1.96290E-02	6.38140E-01	1.25260E-02	3.17440E-02
2.22770E+03	1.89980E-02	6.38150E-01	1.21240E-02	3.07250E-02
2.22780E+03	1.83920E-02	6.38170E-01	1.17370E-02	2.97460E-02
2.22790E+03	1.78110E-02	6.38180E-01	1.13670E-02	2.88060E-02
2.22800E+03	1.72550E-02	6.38190E-01	1.10120E-02	2.79070E-02
2.22810E+03	1.67230E-02	6.38270E-01	1.06740E-02	2.70500E-02
2.22820E+03	1.62160E-02	6.38350E-01	1.03520E-02	2.62340E-02
2.22830E+03	1.57340E-02	6.38430E-01	1.00450E-02	2.54570E-02
2.22840E+03	1.52770E-02	6.38510E-01	9.75450E-03	2.47210E-02
2.22850E+03	1.48440E-02	6.38580E-01	9.47920E-03	2.40230E-02
2.22860E+03	1.44350E-02	6.38660E-01	9.21890E-03	2.33630E-02
2.22870E+03	1.40480E-02	6.38740E-01	8.97310E-03	2.27400E-02
2.22880E+03	1.36830E-02	6.38820E-01	8.74100E-03	2.21520E-02
2.22890E+03	1.33380E-02	6.38900E-01	8.52180E-03	2.15970E-02
2.22900E+03	1.30120E-02	6.38980E-01	8.31460E-03	2.10710E-02
2.22910E+03	1.27030E-02	6.39050E-01	8.11820E-03	2.05740E-02
2.22920E+03	1.24100E-02	6.39130E-01	7.93160E-03	2.01010E-02
2.22930E+03	1.21300E-02	6.39200E-01	7.75380E-03	1.96500E-02
2.22940E+03	1.18630E-02	6.39280E-01	7.58370E-03	1.92190E-02
2.22950E+03	1.16060E-02	6.39360E-01	7.42040E-03	1.88050E-02
2.22960E+03	1.13590E-02	6.39430E-01	7.26300E-03	1.84060E-02
2.22970E+03	1.11190E-02	6.39500E-01	7.11070E-03	1.80200E-02
2.22980E+03	1.08870E-02	6.39570E-01	6.96290E-03	1.76460E-02
2.22990E+03	1.06610E-02	6.39650E-01	6.81910E-03	1.72820E-02
2.23000E+03	1.04400E-02	6.39720E-01	6.67880E-03	1.69260E-02
2.23010E+03	1.02250E-02	6.39940E-01	6.54310E-03	1.65820E-02
2.23020E+03	1.00130E-02	6.40160E-01	6.41000E-03	1.62450E-02
2.23030E+03	9.80550E-03	6.40380E-01	6.27920E-03	1.59130E-02
2.23040E+03	9.60090E-03	6.40600E-01	6.15030E-03	1.55870E-02
2.23050E+03	9.39870E-03	6.40830E-01	6.02290E-03	1.52640E-02

2.23060E+03	9.19830E-03	6.41050E-01	5.89650E-03	1.49430E-02
2.23070E+03	8.99890E-03	6.41270E-01	5.77080E-03	1.46250E-02
2.23080E+03	8.79990E-03	6.41490E-01	5.64510E-03	1.43060E-02
2.23090E+03	8.60070E-03	6.41720E-01	5.51920E-03	1.39870E-02
2.23100E+03	8.40050E-03	6.41940E-01	5.39260E-03	1.36660E-02
2.23110E+03	8.19900E-03	6.42160E-01	5.26510E-03	1.33430E-02
2.23120E+03	7.99610E-03	6.42390E-01	5.13660E-03	1.30170E-02
2.23130E+03	7.79180E-03	6.42610E-01	5.00710E-03	1.26890E-02
2.23140E+03	7.58650E-03	6.42830E-01	4.87680E-03	1.23590E-02
2.23150E+03	7.38110E-03	6.43050E-01	4.74650E-03	1.20290E-02
2.23160E+03	7.17670E-03	6.43280E-01	4.61660E-03	1.17000E-02
2.23170E+03	6.97490E-03	6.43500E-01	4.48840E-03	1.13750E-02
2.23180E+03	6.77750E-03	6.43720E-01	4.36280E-03	1.10570E-02
2.23190E+03	6.58660E-03	6.43950E-01	4.24140E-03	1.07490E-02
2.23200E+03	6.40460E-03	6.44160E-01	4.12560E-03	1.04550E-02
2.23210E+03	6.23360E-03	6.44290E-01	4.01630E-03	1.01780E-02
2.23220E+03	6.07610E-03	6.44420E-01	3.91550E-03	9.92300E-03
2.23230E+03	5.93400E-03	6.44550E-01	3.82480E-03	9.69300E-03
2.23240E+03	5.80920E-03	6.44680E-01	3.74510E-03	9.49100E-03
2.23250E+03	5.70310E-03	6.44780E-01	3.67720E-03	9.31900E-03
2.23260E+03	5.61630E-03	6.44880E-01	3.62180E-03	9.17870E-03
2.23270E+03	5.54940E-03	6.44980E-01	3.57920E-03	9.07070E-03
2.23280E+03	5.50180E-03	6.45080E-01	3.54910E-03	8.99430E-03
2.23290E+03	5.47260E-03	6.45180E-01	3.53080E-03	8.94800E-03
2.23300E+03	5.46020E-03	6.45280E-01	3.52330E-03	8.92910E-03
2.23310E+03	5.46240E-03	6.45380E-01	3.52540E-03	8.93420E-03
2.23320E+03	5.47680E-03	6.45480E-01	3.53520E-03	8.95910E-03
2.23330E+03	5.50020E-03	6.45580E-01	3.55090E-03	8.99890E-03
2.23340E+03	5.52960E-03	6.45690E-01	3.57040E-03	9.04830E-03
2.23350E+03	5.56150E-03	6.45790E-01	3.59160E-03	9.10200E-03
2.23360E+03	5.59270E-03	6.45890E-01	3.61230E-03	9.15450E-03
2.23370E+03	5.62000E-03	6.45990E-01	3.63050E-03	9.20070E-03
2.23380E+03	5.64060E-03	6.46090E-01	3.64430E-03	9.23570E-03
2.23390E+03	5.65180E-03	6.46200E-01	3.65210E-03	9.25550E-03
2.23400E+03	5.65150E-03	6.46300E-01	3.65250E-03	9.25650E-03
2.23410E+03	5.63810E-03	6.46380E-01	3.64430E-03	9.23570E-03
2.23420E+03	5.61050E-03	6.46450E-01	3.62690E-03	9.19170E-03
2.23430E+03	5.56810E-03	6.46530E-01	3.60000E-03	9.12330E-03
2.23440E+03	5.51080E-03	6.46610E-01	3.56330E-03	9.03050E-03
2.23450E+03	5.43890E-03	6.46690E-01	3.51730E-03	8.91380E-03
2.23460E+03	5.35340E-03	6.46770E-01	3.46240E-03	8.77470E-03
2.23470E+03	5.25540E-03	6.46800E-01	3.39920E-03	8.61450E-03
2.23480E+03	5.14650E-03	6.46830E-01	3.32890E-03	8.43640E-03

2.23490E+03	5.02840E-03	6.46860E-01	3.25270E-03	8.24310E-03
2.23500E+03	4.90310E-03	6.46900E-01	3.17180E-03	8.03820E-03
2.23510E+03	4.77270E-03	6.46940E-01	3.08770E-03	7.82500E-03
2.23520E+03	4.63950E-03	6.46980E-01	3.00170E-03	7.60710E-03
2.23530E+03	4.50560E-03	6.47030E-01	2.91520E-03	7.38800E-03
2.23540E+03	4.37310E-03	6.47070E-01	2.82970E-03	7.17120E-03
2.23550E+03	4.24410E-03	6.47120E-01	2.74640E-03	6.96010E-03
2.23560E+03	4.12050E-03	6.47160E-01	2.66660E-03	6.75790E-03
2.23570E+03	4.00390E-03	6.47200E-01	2.59140E-03	6.56720E-03
2.23580E+03	3.89600E-03	6.47250E-01	2.52160E-03	6.39050E-03
2.23590E+03	3.79770E-03	6.47290E-01	2.45820E-03	6.22970E-03
2.23600E+03	3.70990E-03	6.47340E-01	2.40160E-03	6.08620E-03
2.23610E+03	3.63310E-03	6.47440E-01	2.35220E-03	5.96120E-03
2.23620E+03	3.56740E-03	6.47530E-01	2.31000E-03	5.85430E-03
2.23630E+03	3.51250E-03	6.47630E-01	2.27480E-03	5.76510E-03
2.23640E+03	3.46770E-03	6.47730E-01	2.24610E-03	5.69230E-03
2.23650E+03	3.43180E-03	6.47830E-01	2.22320E-03	5.63430E-03
2.23660E+03	3.40350E-03	6.47920E-01	2.20520E-03	5.58850E-03
2.23670E+03	3.38080E-03	6.48020E-01	2.19080E-03	5.55220E-03
2.23680E+03	3.36190E-03	6.48100E-01	2.17880E-03	5.52170E-03
2.23690E+03	3.34440E-03	6.48180E-01	2.16780E-03	5.49380E-03
2.23700E+03	3.32610E-03	6.48270E-01	2.15620E-03	5.46440E-03
2.23710E+03	3.30480E-03	6.48350E-01	2.14270E-03	5.43010E-03
2.23720E+03	3.27820E-03	6.48430E-01	2.12570E-03	5.38710E-03
2.23730E+03	3.24450E-03	6.48510E-01	2.10410E-03	5.33240E-03
2.23740E+03	3.20210E-03	6.48590E-01	2.07690E-03	5.26330E-03
2.23750E+03	3.14980E-03	6.48670E-01	2.04320E-03	5.17800E-03
2.23760E+03	3.08690E-03	6.48750E-01	2.00260E-03	5.07520E-03
2.23770E+03	3.01310E-03	6.48830E-01	1.95500E-03	4.95460E-03
2.23780E+03	2.92900E-03	6.48910E-01	1.90060E-03	4.81680E-03
2.23790E+03	2.83530E-03	6.48990E-01	1.84010E-03	4.66330E-03
2.23800E+03	2.73350E-03	6.49070E-01	1.77420E-03	4.49630E-03
2.23810E+03	2.62540E-03	6.49090E-01	1.70410E-03	4.31870E-03
2.23820E+03	2.51330E-03	6.49120E-01	1.63140E-03	4.13450E-03
2.23830E+03	3.17110E-03	6.49140E-01	2.05850E-03	5.21680E-03
2.23840E+03	3.09410E-03	6.49170E-01	2.00860E-03	5.09040E-03
2.23850E+03	2.94280E-03	6.49190E-01	1.91050E-03	4.84160E-03
2.23860E+03	2.71890E-03	6.49220E-01	1.76510E-03	4.47330E-03
2.23870E+03	2.43130E-03	6.49240E-01	1.57850E-03	4.00030E-03
2.23880E+03	2.09570E-03	6.49270E-01	1.36070E-03	3.44830E-03
2.23890E+03	1.73320E-03	6.49290E-01	1.12540E-03	2.85200E-03
2.23900E+03	1.36910E-03	6.49310E-01	8.88960E-04	2.25290E-03
2.23910E+03	1.03000E-03	6.49380E-01	6.68830E-04	1.69500E-03

2.23920E+03	7.42180E-04	6.49440E-01	4.82000E-04	1.22150E-03
2.23930E+03	0.00000E+00	6.49500E-01	0.00000E+00	0.00000E+00
Channel 15				
Wavenumber	HIRS Filter Transmittance	Optical Element Transmittance	Product of the HIRS Filter and Optical Element Transmittances	Normalized Value of Column 4
2.20300E+03	0.00000E+00	6.16010E-01	0.00000E+00	0.00000E+00
2.20310E+03	2.25930E-03	6.16200E-01	1.39220E-03	2.74410E-03
2.20320E+03	2.23010E-03	6.16400E-01	1.37460E-03	2.70940E-03
2.20330E+03	2.30850E-03	6.16590E-01	1.42340E-03	2.80560E-03
2.20340E+03	2.48800E-03	6.16790E-01	1.53460E-03	3.02480E-03
2.20350E+03	2.75680E-03	6.16990E-01	1.70090E-03	3.35250E-03
2.20360E+03	3.02760E-03	6.17180E-01	1.86860E-03	3.68300E-03
2.20370E+03	3.08930E-03	6.17380E-01	1.90730E-03	3.75940E-03
2.20380E+03	3.13810E-03	6.17570E-01	1.93800E-03	3.81990E-03
2.20390E+03	3.18820E-03	6.17740E-01	1.96950E-03	3.88200E-03
2.20400E+03	3.23420E-03	6.17920E-01	1.99840E-03	3.93900E-03
2.20410E+03	3.28160E-03	6.18100E-01	2.02830E-03	3.99790E-03
2.20420E+03	3.33900E-03	6.18280E-01	2.06440E-03	4.06910E-03
2.20430E+03	3.38890E-03	6.18360E-01	2.09560E-03	4.13040E-03
2.20440E+03	3.43870E-03	6.18440E-01	2.12660E-03	4.19170E-03
2.20450E+03	3.48120E-03	6.18510E-01	2.15320E-03	4.24400E-03
2.20460E+03	3.53050E-03	6.18590E-01	2.18390E-03	4.30470E-03
2.20470E+03	3.55760E-03	6.18660E-01	2.20090E-03	4.33820E-03
2.20480E+03	3.60340E-03	6.18730E-01	2.22960E-03	4.39460E-03
2.20490E+03	3.66610E-03	6.18810E-01	2.26860E-03	4.47150E-03
2.20500E+03	3.74290E-03	6.18880E-01	2.31640E-03	4.56570E-03
2.20510E+03	3.83060E-03	6.18960E-01	2.37100E-03	4.67340E-03
2.20520E+03	3.92580E-03	6.19050E-01	2.43020E-03	4.79010E-03
2.20530E+03	4.02450E-03	6.19130E-01	2.49170E-03	4.91130E-03
2.20540E+03	4.12320E-03	6.19210E-01	2.55310E-03	5.03240E-03
2.20550E+03	4.21830E-03	6.19290E-01	2.61230E-03	5.14900E-03
2.20560E+03	4.30660E-03	6.19380E-01	2.66740E-03	5.25760E-03
2.20570E+03	4.38570E-03	6.19460E-01	2.71680E-03	5.35490E-03
2.20580E+03	4.45380E-03	6.19540E-01	2.75930E-03	5.43870E-03
2.20590E+03	4.50980E-03	6.19620E-01	2.79440E-03	5.50780E-03
2.20600E+03	4.55350E-03	6.19710E-01	2.82180E-03	5.56200E-03
2.20610E+03	4.58560E-03	6.19760E-01	2.84200E-03	5.60170E-03
2.20620E+03	4.60750E-03	6.19800E-01	2.85580E-03	5.62880E-03
2.20630E+03	4.62130E-03	6.19850E-01	2.86450E-03	5.64610E-03
2.20640E+03	4.62940E-03	6.19900E-01	2.86980E-03	5.65650E-03
2.20650E+03	4.63500E-03	6.19950E-01	2.87350E-03	5.66370E-03

2.20660E+03	4.64110E-03	6.20000E-01	2.87750E-03	5.67170E-03
2.20670E+03	4.65100E-03	6.20040E-01	2.88380E-03	5.68410E-03
2.20680E+03	4.66740E-03	6.20090E-01	2.89420E-03	5.70470E-03
2.20690E+03	4.69300E-03	6.20140E-01	2.91030E-03	5.73640E-03
2.20700E+03	4.72980E-03	6.20190E-01	2.93340E-03	5.78180E-03
2.20710E+03	4.77910E-03	6.20240E-01	2.96420E-03	5.84260E-03
2.20720E+03	4.84150E-03	6.20300E-01	3.00320E-03	5.91940E-03
2.20730E+03	4.91690E-03	6.20350E-01	3.05020E-03	6.01200E-03
2.20740E+03	5.00410E-03	6.20400E-01	3.10460E-03	6.11930E-03
2.20750E+03	5.10170E-03	6.20460E-01	3.16540E-03	6.23910E-03
2.20760E+03	5.20710E-03	6.20510E-01	3.23110E-03	6.36870E-03
2.20770E+03	5.31770E-03	6.20570E-01	3.30000E-03	6.50450E-03
2.20780E+03	5.43030E-03	6.20620E-01	3.37020E-03	6.64280E-03
2.20790E+03	5.54160E-03	6.20680E-01	3.43960E-03	6.77960E-03
2.20800E+03	5.64850E-03	6.20730E-01	3.50620E-03	6.91090E-03
2.20810E+03	5.74800E-03	6.20770E-01	3.56820E-03	7.03300E-03
2.20820E+03	5.83750E-03	6.20810E-01	3.62400E-03	7.14310E-03
2.20830E+03	5.91530E-03	6.20800E-01	3.67220E-03	7.23820E-03
2.20840E+03	5.98000E-03	6.20800E-01	3.71240E-03	7.31730E-03
2.20850E+03	6.03120E-03	6.20800E-01	3.74420E-03	7.37990E-03
2.20860E+03	6.06940E-03	6.20790E-01	3.76780E-03	7.42660E-03
2.20870E+03	6.09570E-03	6.20790E-01	3.78410E-03	7.45870E-03
2.20880E+03	6.11200E-03	6.20780E-01	3.79420E-03	7.47860E-03
2.20890E+03	6.12080E-03	6.20780E-01	3.79970E-03	7.48940E-03
2.20900E+03	6.12540E-03	6.20770E-01	3.80250E-03	7.49490E-03
2.20910E+03	6.12890E-03	6.20770E-01	3.80460E-03	7.49920E-03
2.20920E+03	6.13490E-03	6.20770E-01	3.80840E-03	7.50650E-03
2.20930E+03	6.14690E-03	6.20770E-01	3.81580E-03	7.52120E-03
2.20940E+03	6.16800E-03	6.20770E-01	3.82890E-03	7.54700E-03
2.20950E+03	6.20090E-03	6.20770E-01	3.84930E-03	7.58720E-03
2.20960E+03	6.24780E-03	6.20770E-01	3.87840E-03	7.64460E-03
2.20970E+03	6.31000E-03	6.20770E-01	3.91700E-03	7.72070E-03
2.20980E+03	6.38810E-03	6.20770E-01	3.96550E-03	7.81630E-03
2.20990E+03	6.48190E-03	6.20770E-01	4.02370E-03	7.93100E-03
2.21000E+03	6.59020E-03	6.20770E-01	4.09100E-03	8.06360E-03
2.21010E+03	6.71120E-03	6.20800E-01	4.16630E-03	8.21200E-03
2.21020E+03	6.84220E-03	6.20840E-01	4.24790E-03	8.37280E-03
2.21030E+03	6.98020E-03	6.20870E-01	4.33380E-03	8.54220E-03
2.21040E+03	7.12170E-03	6.20900E-01	4.42190E-03	8.71580E-03
2.21050E+03	7.26300E-03	6.21030E-01	4.51050E-03	8.89040E-03
2.21060E+03	7.40040E-03	6.21150E-01	4.59680E-03	9.06050E-03
2.21070E+03	7.53050E-03	6.21270E-01	4.67850E-03	9.22160E-03
2.21080E+03	7.65030E-03	6.21400E-01	4.75390E-03	9.37010E-03

2.21090E+03	7.75710E-03	6.21520E-01	4.82120E-03	9.50290E-03
2.21100E+03	7.84920E-03	6.21650E-01	4.87940E-03	9.61760E-03
2.21110E+03	7.92550E-03	6.21800E-01	4.92810E-03	9.71340E-03
2.21120E+03	7.98560E-03	6.21950E-01	4.96660E-03	9.78950E-03
2.21130E+03	8.03010E-03	6.22100E-01	4.99550E-03	9.84640E-03
2.21140E+03	8.06010E-03	6.22250E-01	5.01540E-03	9.88550E-03
2.21150E+03	8.07750E-03	6.22400E-01	5.02750E-03	9.90940E-03
2.21160E+03	8.08490E-03	6.22550E-01	5.03320E-03	9.92080E-03
2.21170E+03	8.08490E-03	6.22700E-01	5.03450E-03	9.92320E-03
2.21180E+03	8.08060E-03	6.22860E-01	5.03300E-03	9.92040E-03
2.21190E+03	8.07510E-03	6.23010E-01	5.03080E-03	9.91600E-03
2.21200E+03	8.07120E-03	6.23160E-01	5.02960E-03	9.91360E-03
2.21210E+03	8.07150E-03	6.23320E-01	5.03110E-03	9.91660E-03
2.21220E+03	8.07820E-03	6.23480E-01	5.03660E-03	9.92740E-03
2.21230E+03	8.09280E-03	6.23640E-01	5.04700E-03	9.94790E-03
2.21240E+03	8.11620E-03	6.23800E-01	5.06290E-03	9.97930E-03
2.21250E+03	8.14870E-03	6.23970E-01	5.08450E-03	1.00220E-02
2.21260E+03	8.18980E-03	6.24130E-01	5.11150E-03	1.00750E-02
2.21270E+03	8.23860E-03	6.24260E-01	5.14300E-03	1.01370E-02
2.21280E+03	8.29330E-03	6.24390E-01	5.17830E-03	1.02070E-02
2.21290E+03	8.35210E-03	6.24530E-01	5.21610E-03	1.02810E-02
2.21300E+03	8.41270E-03	6.24660E-01	5.25510E-03	1.03580E-02
2.21310E+03	8.47280E-03	6.24790E-01	5.29370E-03	1.04340E-02
2.21320E+03	8.53010E-03	6.24920E-01	5.33070E-03	1.05070E-02
2.21330E+03	8.58250E-03	6.25060E-01	5.36460E-03	1.05740E-02
2.21340E+03	8.62850E-03	6.25200E-01	5.39450E-03	1.06330E-02
2.21350E+03	8.66680E-03	6.25340E-01	5.41970E-03	1.06820E-02
2.21360E+03	8.69690E-03	6.25480E-01	5.43970E-03	1.07220E-02
2.21370E+03	8.71890E-03	6.25620E-01	5.45470E-03	1.07510E-02
2.21380E+03	8.73360E-03	6.25760E-01	5.46510E-03	1.07720E-02
2.21390E+03	8.74260E-03	6.25900E-01	5.47200E-03	1.07850E-02
2.21400E+03	8.74780E-03	6.26040E-01	5.47640E-03	1.07940E-02
2.21410E+03	8.75180E-03	6.26170E-01	5.48010E-03	1.08020E-02
2.21420E+03	8.75760E-03	6.26300E-01	5.48480E-03	1.08110E-02
2.21430E+03	8.76830E-03	6.26430E-01	5.49270E-03	1.08260E-02
2.21440E+03	8.78720E-03	6.26560E-01	5.50570E-03	1.08520E-02
2.21450E+03	8.81750E-03	6.26690E-01	5.52590E-03	1.08920E-02
2.21460E+03	8.86210E-03	6.26820E-01	5.55490E-03	1.09490E-02
2.21470E+03	8.92340E-03	6.26950E-01	5.59450E-03	1.10270E-02
2.21480E+03	9.00340E-03	6.27080E-01	5.64580E-03	1.11280E-02
2.21490E+03	9.10330E-03	6.27180E-01	5.70940E-03	1.12530E-02
2.21500E+03	9.22390E-03	6.27280E-01	5.78590E-03	1.14040E-02
2.21510E+03	9.36500E-03	6.27380E-01	5.87540E-03	1.15810E-02

2.21520E+03	9.52580E-03	6.27490E-01	5.97740E-03	1.17820E-02
2.21530E+03	9.70510E-03	6.27600E-01	6.09090E-03	1.20050E-02
2.21540E+03	9.90090E-03	6.27710E-01	6.21490E-03	1.22500E-02
2.21550E+03	1.01110E-02	6.27810E-01	6.34780E-03	1.25120E-02
2.21560E+03	1.03330E-02	6.27920E-01	6.48800E-03	1.27880E-02
2.21570E+03	1.05630E-02	6.28030E-01	6.63410E-03	1.30760E-02
2.21580E+03	1.08010E-02	6.28140E-01	6.78420E-03	1.33720E-02
2.21590E+03	1.10420E-02	6.28240E-01	6.93710E-03	1.36730E-02
2.21600E+03	1.12860E-02	6.28350E-01	7.09130E-03	1.39770E-02
2.21610E+03	1.15300E-02	6.28450E-01	7.24600E-03	1.42820E-02
2.21620E+03	1.17740E-02	6.28540E-01	7.40060E-03	1.45870E-02
2.21630E+03	1.20180E-02	6.28640E-01	7.55500E-03	1.48910E-02
2.21640E+03	1.22620E-02	6.28730E-01	7.70970E-03	1.51960E-02
2.21650E+03	1.25080E-02	6.28830E-01	7.86510E-03	1.55020E-02
2.21660E+03	1.27560E-02	6.28930E-01	8.02240E-03	1.58130E-02
2.21670E+03	1.30090E-02	6.29020E-01	8.18310E-03	1.61290E-02
2.21680E+03	1.32700E-02	6.29120E-01	8.34860E-03	1.64560E-02
2.21690E+03	1.35420E-02	6.29210E-01	8.52090E-03	1.67950E-02
2.21700E+03	1.38280E-02	6.29310E-01	8.70190E-03	1.71520E-02
2.21710E+03	1.41300E-02	6.29410E-01	8.89340E-03	1.75290E-02
2.21720E+03	1.44510E-02	6.29520E-01	9.09700E-03	1.79310E-02
2.21730E+03	1.47930E-02	6.29630E-01	9.31430E-03	1.83590E-02
2.21740E+03	1.51590E-02	6.29730E-01	9.54630E-03	1.88160E-02
2.21750E+03	1.55500E-02	6.29840E-01	9.79390E-03	1.93040E-02
2.21760E+03	1.59660E-02	6.29950E-01	1.00580E-02	1.98240E-02
2.21770E+03	1.64070E-02	6.30050E-01	1.03370E-02	2.03750E-02
2.21780E+03	1.68730E-02	6.30160E-01	1.06330E-02	2.09580E-02
2.21790E+03	1.73630E-02	6.30260E-01	1.09430E-02	2.15700E-02
2.21800E+03	1.78750E-02	6.30380E-01	1.12680E-02	2.22090E-02
2.21810E+03	1.84070E-02	6.30500E-01	1.16050E-02	2.28750E-02
2.21820E+03	1.89560E-02	6.30620E-01	1.19540E-02	2.35630E-02
2.21830E+03	1.95220E-02	6.30740E-01	1.23130E-02	2.42700E-02
2.21840E+03	2.01000E-02	6.30860E-01	1.26810E-02	2.49940E-02
2.21850E+03	2.06900E-02	6.30990E-01	1.30550E-02	2.57330E-02
2.21860E+03	2.12900E-02	6.31110E-01	1.34360E-02	2.64840E-02
2.21870E+03	2.18980E-02	6.31230E-01	1.38230E-02	2.72450E-02
2.21880E+03	2.25140E-02	6.31350E-01	1.42140E-02	2.80170E-02
2.21890E+03	2.31390E-02	6.31480E-01	1.46120E-02	2.88000E-02
2.21900E+03	2.37720E-02	6.31600E-01	1.50140E-02	2.95940E-02
2.21910E+03	2.44160E-02	6.31720E-01	1.54240E-02	3.04020E-02
2.21920E+03	2.50730E-02	6.31840E-01	1.58420E-02	3.12260E-02
2.21930E+03	2.51320E-02	6.31920E-01	1.58820E-02	3.13030E-02
2.21940E+03	2.61210E-02	6.32010E-01	1.65080E-02	3.25390E-02

2.21950E+03	2.71100E-02	6.32100E-01	1.71360E-02	3.37760E-02
2.21960E+03	2.80840E-02	6.32180E-01	1.77540E-02	3.49950E-02
2.21970E+03	2.90300E-02	6.32270E-01	1.83550E-02	3.61780E-02
2.21980E+03	2.99370E-02	6.32360E-01	1.89310E-02	3.73140E-02
2.21990E+03	3.07970E-02	6.32440E-01	1.94770E-02	3.83900E-02
2.22000E+03	3.16050E-02	6.32530E-01	1.99910E-02	3.94040E-02
2.22010E+03	3.23630E-02	6.32590E-01	2.04730E-02	4.03520E-02
2.22020E+03	3.30750E-02	6.32660E-01	2.09250E-02	4.12450E-02
2.22030E+03	3.37510E-02	6.32730E-01	2.13550E-02	4.20930E-02
2.22040E+03	3.44050E-02	6.32810E-01	2.17720E-02	4.29130E-02
2.22050E+03	3.50550E-02	6.32880E-01	2.21850E-02	4.37290E-02
2.22060E+03	3.57200E-02	6.32960E-01	2.26090E-02	4.45640E-02
2.22070E+03	3.64260E-02	6.33030E-01	2.30590E-02	4.54500E-02
2.22080E+03	3.71950E-02	6.33110E-01	2.35480E-02	4.64150E-02
2.22090E+03	3.80530E-02	6.33180E-01	2.40940E-02	4.74910E-02
2.22100E+03	3.90230E-02	6.33260E-01	2.47120E-02	4.87080E-02
2.22110E+03	4.01280E-02	6.33330E-01	2.54140E-02	5.00930E-02
2.22120E+03	4.13860E-02	6.33400E-01	2.62140E-02	5.16700E-02
2.22130E+03	4.28150E-02	6.33470E-01	2.71220E-02	5.34590E-02
2.22140E+03	4.44240E-02	6.33550E-01	2.81440E-02	5.54740E-02
2.22150E+03	4.62210E-02	6.33650E-01	2.92880E-02	5.77280E-02
2.22160E+03	4.82080E-02	6.33760E-01	3.05520E-02	6.02200E-02
2.22170E+03	5.03830E-02	6.33870E-01	3.19360E-02	6.29480E-02
2.22180E+03	5.27400E-02	6.33980E-01	3.34360E-02	6.59030E-02
2.22190E+03	5.52660E-02	6.34080E-01	3.50430E-02	6.90720E-02
2.22200E+03	5.79500E-02	6.34190E-01	3.67510E-02	7.24380E-02
2.22210E+03	6.07740E-02	6.34280E-01	3.85480E-02	7.59800E-02
2.22220E+03	6.37230E-02	6.34370E-01	4.04240E-02	7.96780E-02
2.22230E+03	6.67790E-02	6.34470E-01	4.23690E-02	8.35120E-02
2.22240E+03	6.99270E-02	6.34560E-01	4.43730E-02	8.74610E-02
2.22250E+03	7.31510E-02	6.34650E-01	4.64260E-02	9.15070E-02
2.22260E+03	7.64420E-02	6.34750E-01	4.85210E-02	9.56370E-02
2.22270E+03	7.97900E-02	6.34840E-01	5.06540E-02	9.98420E-02
2.22280E+03	8.31940E-02	6.34930E-01	5.28220E-02	1.04120E-01
2.22290E+03	8.66520E-02	6.35030E-01	5.50260E-02	1.08460E-01
2.22300E+03	9.01710E-02	6.35120E-01	5.72690E-02	1.12880E-01
2.22310E+03	9.37600E-02	6.35210E-01	5.95570E-02	1.17390E-01
2.22320E+03	9.74320E-02	6.35310E-01	6.18990E-02	1.22010E-01
2.22330E+03	1.01200E-01	6.35400E-01	6.43040E-02	1.26750E-01
2.22340E+03	1.05090E-01	6.35490E-01	6.67870E-02	1.31640E-01
2.22350E+03	1.09120E-01	6.35590E-01	6.93580E-02	1.36710E-01
2.22360E+03	1.13320E-01	6.35680E-01	7.20330E-02	1.41980E-01
2.22370E+03	1.17690E-01	6.35750E-01	7.48210E-02	1.47480E-01

2.22380E+03	1.22260E-01	6.35820E-01	7.77370E-02	1.53220E-01
2.22390E+03	1.27060E-01	6.35890E-01	8.07940E-02	1.59250E-01
2.22400E+03	1.32080E-01	6.35960E-01	8.39980E-02	1.65560E-01
2.22410E+03	1.37350E-01	6.36050E-01	8.73610E-02	1.72190E-01
2.22420E+03	1.42870E-01	6.36140E-01	9.08830E-02	1.79130E-01
2.22430E+03	1.48630E-01	6.36230E-01	9.45640E-02	1.86390E-01
2.22440E+03	1.54650E-01	6.36320E-01	9.84050E-02	1.93960E-01
2.22450E+03	1.60900E-01	6.36410E-01	1.02400E-01	2.01840E-01
2.22460E+03	1.67390E-01	6.36500E-01	1.06540E-01	2.10000E-01
2.22470E+03	1.74090E-01	6.36590E-01	1.10820E-01	2.18440E-01
2.22480E+03	1.80990E-01	6.36680E-01	1.15230E-01	2.27130E-01
2.22490E+03	1.88070E-01	6.36770E-01	1.19760E-01	2.36050E-01
2.22500E+03	1.95320E-01	6.36860E-01	1.24390E-01	2.45180E-01
2.22510E+03	2.02710E-01	6.36950E-01	1.29120E-01	2.54500E-01
2.22520E+03	2.10240E-01	6.37040E-01	1.33930E-01	2.63980E-01
2.22530E+03	2.17880E-01	6.37130E-01	1.38820E-01	2.73620E-01
2.22540E+03	2.25620E-01	6.37220E-01	1.43770E-01	2.83380E-01
2.22550E+03	2.33460E-01	6.37310E-01	1.48790E-01	2.93270E-01
2.22560E+03	2.41390E-01	6.37390E-01	1.53860E-01	3.03270E-01
2.22570E+03	2.49410E-01	6.37480E-01	1.59000E-01	3.13390E-01
2.22580E+03	2.57520E-01	6.37570E-01	1.64190E-01	3.23620E-01
2.22590E+03	2.65720E-01	6.37660E-01	1.69440E-01	3.33970E-01
2.22600E+03	2.74020E-01	6.37730E-01	1.74750E-01	3.44440E-01
2.22610E+03	2.82430E-01	6.37760E-01	1.80120E-01	3.55030E-01
2.22620E+03	2.90950E-01	6.37790E-01	1.85570E-01	3.65760E-01
2.22630E+03	2.99600E-01	6.37820E-01	1.91090E-01	3.76650E-01
2.22640E+03	3.08390E-01	6.37850E-01	1.96700E-01	3.87710E-01
2.22650E+03	3.17300E-01	6.37880E-01	2.02400E-01	3.98940E-01
2.22660E+03	3.26360E-01	6.37910E-01	2.08190E-01	4.10350E-01
2.22670E+03	3.35560E-01	6.37940E-01	2.14070E-01	4.21940E-01
2.22680E+03	3.44890E-01	6.37970E-01	2.20030E-01	4.33690E-01
2.22690E+03	3.54350E-01	6.38000E-01	2.26070E-01	4.45600E-01
2.22700E+03	3.63910E-01	6.38030E-01	2.32190E-01	4.57650E-01
2.22710E+03	3.73570E-01	6.38060E-01	2.38360E-01	4.69820E-01
2.22720E+03	3.83310E-01	6.38080E-01	2.44580E-01	4.82080E-01
2.22730E+03	3.93080E-01	6.38100E-01	2.50830E-01	4.94390E-01
2.22740E+03	4.02880E-01	6.38110E-01	2.57090E-01	5.06730E-01
2.22750E+03	4.12680E-01	6.38130E-01	2.63340E-01	5.19050E-01
2.22760E+03	4.22430E-01	6.38140E-01	2.69570E-01	5.31340E-01
2.22770E+03	4.32120E-01	6.38150E-01	2.75760E-01	5.43540E-01
2.22780E+03	4.41720E-01	6.38170E-01	2.81890E-01	5.55620E-01
2.22790E+03	4.51210E-01	6.38180E-01	2.87950E-01	5.67570E-01
2.22800E+03	4.60550E-01	6.38190E-01	2.93920E-01	5.79340E-01

2.22810E+03	4.69750E-01	6.38270E-01	2.99830E-01	5.90980E-01
2.22820E+03	4.78780E-01	6.38350E-01	3.05630E-01	6.02410E-01
2.22830E+03	4.87640E-01	6.38430E-01	3.11320E-01	6.13630E-01
2.22840E+03	4.96320E-01	6.38510E-01	3.16900E-01	6.24630E-01
2.22850E+03	5.04820E-01	6.38580E-01	3.22370E-01	6.35410E-01
2.22860E+03	5.13160E-01	6.38660E-01	3.27740E-01	6.45980E-01
2.22870E+03	5.21330E-01	6.38740E-01	3.33000E-01	6.56360E-01
2.22880E+03	5.29360E-01	6.38820E-01	3.38170E-01	6.66540E-01
2.22890E+03	5.37250E-01	6.38900E-01	3.43250E-01	6.76560E-01
2.22900E+03	5.45020E-01	6.38980E-01	3.48250E-01	6.86430E-01
2.22910E+03	5.52670E-01	6.39050E-01	3.53190E-01	6.96150E-01
2.22920E+03	5.60230E-01	6.39130E-01	3.58060E-01	7.05750E-01
2.22930E+03	5.67700E-01	6.39200E-01	3.62870E-01	7.15240E-01
2.22940E+03	5.75080E-01	6.39280E-01	3.67640E-01	7.24630E-01
2.22950E+03	5.82380E-01	6.39360E-01	3.72350E-01	7.33910E-01
2.22960E+03	5.89590E-01	6.39430E-01	3.77000E-01	7.43090E-01
2.22970E+03	5.96710E-01	6.39500E-01	3.81600E-01	7.52150E-01
2.22980E+03	6.03730E-01	6.39570E-01	3.86130E-01	7.61080E-01
2.22990E+03	6.10630E-01	6.39650E-01	3.90590E-01	7.69870E-01
2.23000E+03	6.17400E-01	6.39720E-01	3.94960E-01	7.78480E-01
2.23010E+03	6.24010E-01	6.39940E-01	3.99330E-01	7.87090E-01
2.23020E+03	6.30440E-01	6.40160E-01	4.03580E-01	7.95480E-01
2.23030E+03	6.36680E-01	6.40380E-01	4.07720E-01	8.03630E-01
2.23040E+03	6.42700E-01	6.40600E-01	4.11720E-01	8.11510E-01
2.23050E+03	6.48480E-01	6.40830E-01	4.15560E-01	8.19090E-01
2.23060E+03	6.54000E-01	6.41050E-01	4.19250E-01	8.26360E-01
2.23070E+03	6.59260E-01	6.41270E-01	4.22770E-01	8.33290E-01
2.23080E+03	6.64240E-01	6.41490E-01	4.26110E-01	8.39880E-01
2.23090E+03	6.68940E-01	6.41720E-01	4.29270E-01	8.46110E-01
2.23100E+03	6.73350E-01	6.41940E-01	4.32250E-01	8.51990E-01
2.23110E+03	6.77490E-01	6.42160E-01	4.35060E-01	8.57520E-01
2.23120E+03	6.81360E-01	6.42390E-01	4.37700E-01	8.62720E-01
2.23130E+03	6.84980E-01	6.42610E-01	4.40180E-01	8.67610E-01
2.23140E+03	6.88370E-01	6.42830E-01	4.42510E-01	8.72210E-01
2.23150E+03	6.91550E-01	6.43050E-01	4.44710E-01	8.76540E-01
2.23160E+03	6.94540E-01	6.43280E-01	4.46780E-01	8.80630E-01
2.23170E+03	6.97360E-01	6.43500E-01	4.48750E-01	8.84520E-01
2.23180E+03	7.00040E-01	6.43720E-01	4.50630E-01	8.88220E-01
2.23190E+03	7.02600E-01	6.43950E-01	4.52440E-01	8.91780E-01
2.23200E+03	7.05060E-01	6.44160E-01	4.54170E-01	8.95190E-01
2.23210E+03	7.07430E-01	6.44290E-01	4.55790E-01	8.98380E-01
2.23220E+03	7.09730E-01	6.44420E-01	4.57360E-01	9.01480E-01
2.23230E+03	7.11960E-01	6.44550E-01	4.58890E-01	9.04500E-01

2.23240E+03	7.14140E-01	6.44680E-01	4.60390E-01	9.07450E-01
2.23250E+03	7.16250E-01	6.44780E-01	4.61820E-01	9.10280E-01
2.23260E+03	7.18310E-01	6.44880E-01	4.63220E-01	9.13030E-01
2.23270E+03	7.20290E-01	6.44980E-01	4.64570E-01	9.15690E-01
2.23280E+03	7.22200E-01	6.45080E-01	4.65870E-01	9.18260E-01
2.23290E+03	7.24010E-01	6.45180E-01	4.67120E-01	9.20710E-01
2.23300E+03	7.25730E-01	6.45280E-01	4.68300E-01	9.23040E-01
2.23310E+03	7.27340E-01	6.45380E-01	4.69410E-01	9.25230E-01
2.23320E+03	7.28830E-01	6.45480E-01	4.70450E-01	9.27280E-01
2.23330E+03	7.30190E-01	6.45580E-01	4.71400E-01	9.29160E-01
2.23340E+03	7.31430E-01	6.45690E-01	4.72270E-01	9.30870E-01
2.23350E+03	7.32530E-01	6.45790E-01	4.73060E-01	9.32420E-01
2.23360E+03	7.33500E-01	6.45890E-01	4.73760E-01	9.33810E-01
2.23370E+03	7.34350E-01	6.45990E-01	4.74390E-01	9.35040E-01
2.23380E+03	7.35100E-01	6.46090E-01	4.74940E-01	9.36130E-01
2.23390E+03	7.35740E-01	6.46200E-01	4.75430E-01	9.37100E-01
2.23400E+03	7.36310E-01	6.46300E-01	4.75880E-01	9.37980E-01
2.23410E+03	7.36820E-01	6.46380E-01	4.76270E-01	9.38740E-01
2.23420E+03	7.37300E-01	6.46450E-01	4.76630E-01	9.39460E-01
2.23430E+03	7.37760E-01	6.46530E-01	4.76990E-01	9.40170E-01
2.23440E+03	7.38230E-01	6.46610E-01	4.77350E-01	9.40880E-01
2.23450E+03	7.38730E-01	6.46690E-01	4.77730E-01	9.41630E-01
2.23460E+03	7.39270E-01	6.46770E-01	4.78140E-01	9.42430E-01
2.23470E+03	7.39870E-01	6.46800E-01	4.78550E-01	9.43240E-01
2.23480E+03	7.40530E-01	6.46830E-01	4.79000E-01	9.44140E-01
2.23490E+03	7.41270E-01	6.46860E-01	4.79500E-01	9.45120E-01
2.23500E+03	7.42090E-01	6.46900E-01	4.80050E-01	9.46210E-01
2.23510E+03	7.42980E-01	6.46940E-01	4.80660E-01	9.47410E-01
2.23520E+03	7.43930E-01	6.46980E-01	4.81310E-01	9.48690E-01
2.23530E+03	7.44940E-01	6.47030E-01	4.81990E-01	9.50040E-01
2.23540E+03	7.45980E-01	6.47070E-01	4.82700E-01	9.51430E-01
2.23550E+03	7.47050E-01	6.47120E-01	4.83430E-01	9.52860E-01
2.23560E+03	7.48120E-01	6.47160E-01	4.84160E-01	9.54290E-01
2.23570E+03	7.49180E-01	6.47200E-01	4.84870E-01	9.55710E-01
2.23580E+03	7.50210E-01	6.47250E-01	4.85570E-01	9.57090E-01
2.23590E+03	7.51200E-01	6.47290E-01	4.86240E-01	9.58410E-01
2.23600E+03	7.52120E-01	6.47340E-01	4.86880E-01	9.59660E-01
2.23610E+03	7.52970E-01	6.47440E-01	4.87500E-01	9.60890E-01
2.23620E+03	7.53750E-01	6.47530E-01	4.88080E-01	9.62030E-01
2.23630E+03	7.54450E-01	6.47630E-01	4.88600E-01	9.63060E-01
2.23640E+03	7.55060E-01	6.47730E-01	4.89080E-01	9.63990E-01
2.23650E+03	7.55610E-01	6.47830E-01	4.89500E-01	9.64830E-01
2.23660E+03	7.56090E-01	6.47920E-01	4.89890E-01	9.65590E-01

2.23670E+03	7.56520E-01	6.48020E-01	4.90240E-01	9.66280E-01
2.23680E+03	7.56910E-01	6.48100E-01	4.90550E-01	9.66900E-01
2.23690E+03	7.57270E-01	6.48180E-01	4.90850E-01	9.67490E-01
2.23700E+03	7.57640E-01	6.48270E-01	4.91150E-01	9.68080E-01
2.23710E+03	7.58010E-01	6.48350E-01	4.91450E-01	9.68680E-01
2.23720E+03	7.58410E-01	6.48430E-01	4.91770E-01	9.69310E-01
2.23730E+03	7.58850E-01	6.48510E-01	4.92120E-01	9.70000E-01
2.23740E+03	7.59340E-01	6.48590E-01	4.92500E-01	9.70740E-01
2.23750E+03	7.59890E-01	6.48670E-01	4.92920E-01	9.71570E-01
2.23760E+03	7.60500E-01	6.48750E-01	4.93380E-01	9.72470E-01
2.23770E+03	7.61180E-01	6.48830E-01	4.93880E-01	9.73460E-01
2.23780E+03	7.61920E-01	6.48910E-01	4.94420E-01	9.74520E-01
2.23790E+03	7.62710E-01	6.48990E-01	4.95000E-01	9.75660E-01
2.23800E+03	7.63560E-01	6.49070E-01	4.95600E-01	9.76860E-01
2.23810E+03	7.64450E-01	6.49090E-01	4.96200E-01	9.78030E-01
2.23820E+03	7.65360E-01	6.49120E-01	4.96810E-01	9.79230E-01
2.23830E+03	7.66280E-01	6.49140E-01	4.97430E-01	9.80450E-01
2.23840E+03	7.67200E-01	6.49170E-01	4.98040E-01	9.81670E-01
2.23850E+03	7.68120E-01	6.49190E-01	4.98660E-01	9.82880E-01
2.23860E+03	7.69010E-01	6.49220E-01	4.99250E-01	9.84050E-01
2.23870E+03	7.69870E-01	6.49240E-01	4.99830E-01	9.85190E-01
2.23880E+03	7.70680E-01	6.49270E-01	5.00380E-01	9.86270E-01
2.23890E+03	7.71450E-01	6.49290E-01	5.00900E-01	9.87290E-01
2.23900E+03	7.72180E-01	6.49310E-01	5.01390E-01	9.88260E-01
2.23910E+03	7.72850E-01	6.49380E-01	5.01870E-01	9.89220E-01
2.23920E+03	7.73480E-01	6.49440E-01	5.02330E-01	9.90110E-01
2.23930E+03	7.74060E-01	6.49500E-01	5.02750E-01	9.90950E-01
2.23940E+03	7.74600E-01	6.49570E-01	5.03160E-01	9.91740E-01
2.23950E+03	7.75110E-01	6.49630E-01	5.03530E-01	9.92490E-01
2.23960E+03	7.75590E-01	6.49700E-01	5.03900E-01	9.93200E-01
2.23970E+03	7.76040E-01	6.49760E-01	5.04240E-01	9.93880E-01
2.23980E+03	7.76480E-01	6.49820E-01	5.04570E-01	9.94540E-01
2.23990E+03	7.76900E-01	6.49890E-01	5.04890E-01	9.95170E-01
2.24000E+03	7.77300E-01	6.49960E-01	5.05210E-01	9.95790E-01
2.24010E+03	7.77680E-01	6.50090E-01	5.05560E-01	9.96480E-01
2.24020E+03	7.78040E-01	6.50220E-01	5.05900E-01	9.97140E-01
2.24030E+03	7.78370E-01	6.50350E-01	5.06210E-01	9.97770E-01
2.24040E+03	7.78660E-01	6.50480E-01	5.06510E-01	9.98350E-01
2.24050E+03	7.78910E-01	6.50610E-01	5.06770E-01	9.98860E-01
2.24060E+03	7.79090E-01	6.50740E-01	5.06990E-01	9.99300E-01
2.24070E+03	7.79210E-01	6.50880E-01	5.07170E-01	9.99650E-01
2.24080E+03	7.79230E-01	6.51010E-01	5.07290E-01	9.99890E-01
2.24090E+03	7.79160E-01	6.51140E-01	5.07340E-01	1.00000E+00

2.24100E+03	7.78990E-01	6.51270E-01	5.07330E-01	9.99970E-01
2.24110E+03	7.78690E-01	6.51400E-01	5.07240E-01	9.99800E-01
2.24120E+03	7.78260E-01	6.51540E-01	5.07070E-01	9.99450E-01
2.24130E+03	7.77700E-01	6.51660E-01	5.06800E-01	9.98930E-01
2.24140E+03	7.77010E-01	6.51790E-01	5.06440E-01	9.98220E-01
2.24150E+03	7.76170E-01	6.51910E-01	5.05990E-01	9.97340E-01
2.24160E+03	7.75210E-01	6.52030E-01	5.05460E-01	9.96290E-01
2.24170E+03	7.74110E-01	6.52160E-01	5.04840E-01	9.95070E-01
2.24180E+03	7.72890E-01	6.52280E-01	5.04140E-01	9.93690E-01
2.24190E+03	7.71570E-01	6.52400E-01	5.03370E-01	9.92180E-01
2.24200E+03	7.70140E-01	6.52530E-01	5.02540E-01	9.90520E-01
2.24210E+03	7.68620E-01	6.52610E-01	5.01610E-01	9.88690E-01
2.24220E+03	7.67020E-01	6.52690E-01	5.00630E-01	9.86760E-01
2.24230E+03	7.65360E-01	6.52770E-01	4.99600E-01	9.84740E-01
2.24240E+03	7.63650E-01	6.52850E-01	4.98550E-01	9.82660E-01
2.24250E+03	7.61880E-01	6.52930E-01	4.97460E-01	9.80510E-01
2.24260E+03	7.60090E-01	6.53010E-01	4.96350E-01	9.78320E-01
2.24270E+03	7.58260E-01	6.53090E-01	4.95210E-01	9.76090E-01
2.24280E+03	7.56400E-01	6.53170E-01	4.94060E-01	9.73820E-01
2.24290E+03	7.54520E-01	6.53250E-01	4.92890E-01	9.71510E-01
2.24300E+03	7.52600E-01	6.53330E-01	4.91700E-01	9.69160E-01
2.24310E+03	7.50650E-01	6.53410E-01	4.90490E-01	9.66770E-01
2.24320E+03	7.48670E-01	6.53490E-01	4.89250E-01	9.64330E-01
2.24330E+03	7.46630E-01	6.53570E-01	4.87980E-01	9.61820E-01
2.24340E+03	7.44530E-01	6.53650E-01	4.86660E-01	9.59240E-01
2.24350E+03	7.42360E-01	6.53720E-01	4.85300E-01	9.56540E-01
2.24360E+03	7.40100E-01	6.53790E-01	4.83870E-01	9.53740E-01
2.24370E+03	7.37750E-01	6.53860E-01	4.82390E-01	9.50810E-01
2.24380E+03	7.35280E-01	6.53940E-01	4.80830E-01	9.47740E-01
2.24390E+03	7.32700E-01	6.54000E-01	4.79190E-01	9.44500E-01
2.24400E+03	7.29980E-01	6.54080E-01	4.77460E-01	9.41100E-01
2.24410E+03	7.27110E-01	6.54060E-01	4.75570E-01	9.37380E-01
2.24420E+03	7.24080E-01	6.54030E-01	4.73580E-01	9.33440E-01
2.24430E+03	7.20890E-01	6.54010E-01	4.71470E-01	9.29290E-01
2.24440E+03	7.17530E-01	6.53980E-01	4.69250E-01	9.24920E-01
2.24450E+03	7.13990E-01	6.53960E-01	4.66920E-01	9.20320E-01
2.24460E+03	7.10260E-01	6.53930E-01	4.64460E-01	9.15480E-01
2.24470E+03	7.06340E-01	6.53910E-01	4.61880E-01	9.10390E-01
2.24480E+03	7.02230E-01	6.53880E-01	4.59170E-01	9.05050E-01
2.24490E+03	6.97920E-01	6.53860E-01	4.56340E-01	8.99470E-01
2.24500E+03	6.93410E-01	6.53830E-01	4.53370E-01	8.93620E-01
2.24510E+03	6.88710E-01	6.53780E-01	4.50260E-01	8.87490E-01
2.24520E+03	6.83800E-01	6.53730E-01	4.47030E-01	8.81110E-01

2.24530E+03	6.78700E-01	6.53680E-01	4.43660E-01	8.74470E-01
2.24540E+03	6.73410E-01	6.53650E-01	4.40170E-01	8.67600E-01
2.24550E+03	6.67920E-01	6.53610E-01	4.36560E-01	8.60480E-01
2.24560E+03	6.62240E-01	6.53580E-01	4.32830E-01	8.53120E-01
2.24570E+03	6.56370E-01	6.53610E-01	4.29010E-01	8.45590E-01
2.24580E+03	6.50310E-01	6.53630E-01	4.25060E-01	8.37820E-01
2.24590E+03	6.44080E-01	6.53660E-01	4.21010E-01	8.29820E-01
2.24600E+03	6.37670E-01	6.53690E-01	4.16840E-01	8.21620E-01
2.24610E+03	6.31090E-01	6.53780E-01	4.12600E-01	8.13250E-01
2.24620E+03	6.24350E-01	6.53870E-01	4.08250E-01	8.04680E-01
2.24630E+03	6.17460E-01	6.53960E-01	4.03790E-01	7.95900E-01
2.24640E+03	6.10410E-01	6.54050E-01	3.99240E-01	7.86920E-01
2.24650E+03	6.03220E-01	6.54140E-01	3.94590E-01	7.77760E-01
2.24660E+03	5.95900E-01	6.54230E-01	3.89860E-01	7.68430E-01
2.24670E+03	5.88450E-01	6.54320E-01	3.85040E-01	7.58920E-01
2.24680E+03	5.80880E-01	6.54410E-01	3.80130E-01	7.49260E-01
2.24690E+03	5.73200E-01	6.54500E-01	3.75160E-01	7.39450E-01
2.24700E+03	5.65400E-01	6.54590E-01	3.70110E-01	7.29500E-01
2.24710E+03	5.57510E-01	6.54680E-01	3.64990E-01	7.19410E-01
2.24720E+03	5.49510E-01	6.54770E-01	3.59800E-01	7.09190E-01
2.24730E+03	5.41420E-01	6.54860E-01	3.54560E-01	6.98850E-01
2.24740E+03	5.33240E-01	6.54950E-01	3.49250E-01	6.88390E-01
2.24750E+03	5.24980E-01	6.55040E-01	3.43890E-01	6.77820E-01
2.24760E+03	5.16640E-01	6.55130E-01	3.38470E-01	6.67130E-01
2.24770E+03	5.08210E-01	6.55230E-01	3.32990E-01	6.56350E-01
2.24780E+03	4.99720E-01	6.55320E-01	3.27470E-01	6.45470E-01
2.24790E+03	4.91160E-01	6.55370E-01	3.21890E-01	6.34460E-01
2.24800E+03	4.82530E-01	6.55420E-01	3.16260E-01	6.23370E-01
2.24810E+03	4.73850E-01	6.55500E-01	3.10610E-01	6.12230E-01
2.24820E+03	4.65120E-01	6.55570E-01	3.04920E-01	6.01020E-01
2.24830E+03	4.56350E-01	6.55650E-01	2.99210E-01	5.89750E-01
2.24840E+03	4.47560E-01	6.55720E-01	2.93470E-01	5.78450E-01
2.24850E+03	4.38740E-01	6.55800E-01	2.87730E-01	5.67120E-01
2.24860E+03	4.29920E-01	6.55870E-01	2.81970E-01	5.55780E-01
2.24870E+03	4.21100E-01	6.55950E-01	2.76220E-01	5.44440E-01
2.24880E+03	4.12300E-01	6.56020E-01	2.70480E-01	5.33130E-01
2.24890E+03	4.03530E-01	6.56100E-01	2.64750E-01	5.21840E-01
2.24900E+03	3.94800E-01	6.56170E-01	2.59060E-01	5.10610E-01
2.24910E+03	3.86120E-01	6.56250E-01	2.53390E-01	4.99440E-01
2.24920E+03	3.77500E-01	6.56320E-01	2.47760E-01	4.88340E-01
2.24930E+03	3.68940E-01	6.56390E-01	2.42170E-01	4.77330E-01
2.24940E+03	3.60460E-01	6.56460E-01	2.36630E-01	4.66410E-01
2.24950E+03	3.52060E-01	6.56530E-01	2.31140E-01	4.55590E-01

2.24960E+03	3.43730E-01	6.56610E-01	2.25700E-01	4.44860E-01
2.24970E+03	3.35480E-01	6.56680E-01	2.20300E-01	4.34230E-01
2.24980E+03	3.27300E-01	6.56750E-01	2.14960E-01	4.23690E-01
2.24990E+03	3.19190E-01	6.56820E-01	2.09650E-01	4.13240E-01
2.25000E+03	3.11150E-01	6.56900E-01	2.04390E-01	4.02870E-01
2.25010E+03	3.03160E-01	6.56890E-01	1.99140E-01	3.92520E-01
2.25020E+03	2.95220E-01	6.56870E-01	1.93920E-01	3.82220E-01
2.25030E+03	2.87320E-01	6.56850E-01	1.88720E-01	3.71980E-01
2.25040E+03	2.79460E-01	6.56830E-01	1.83560E-01	3.61800E-01
2.25050E+03	2.71630E-01	6.56810E-01	1.78410E-01	3.51650E-01
2.25060E+03	2.63840E-01	6.56790E-01	1.73280E-01	3.41550E-01
2.25070E+03	2.56070E-01	6.56770E-01	1.68180E-01	3.31500E-01
2.25080E+03	2.48350E-01	6.56750E-01	1.63110E-01	3.21490E-01
2.25090E+03	2.40680E-01	6.56740E-01	1.58060E-01	3.11550E-01
2.25100E+03	2.33060E-01	6.56720E-01	1.53060E-01	3.01680E-01
2.25110E+03	2.25520E-01	6.56700E-01	1.48100E-01	2.91910E-01
2.25120E+03	2.18070E-01	6.56670E-01	1.43200E-01	2.82260E-01
2.25130E+03	2.10730E-01	6.56650E-01	1.38370E-01	2.72740E-01
2.25140E+03	2.03510E-01	6.56630E-01	1.33630E-01	2.63400E-01
2.25150E+03	1.96450E-01	6.56610E-01	1.28990E-01	2.54250E-01
2.25160E+03	1.89570E-01	6.56590E-01	1.24470E-01	2.45330E-01
2.25170E+03	1.82880E-01	6.56570E-01	1.20070E-01	2.36670E-01
2.25180E+03	1.76410E-01	6.56550E-01	1.15820E-01	2.28290E-01
2.25190E+03	1.70170E-01	6.56530E-01	1.11720E-01	2.20200E-01
2.25200E+03	1.64170E-01	6.56510E-01	1.07780E-01	2.12440E-01
2.25210E+03	1.58430E-01	6.56520E-01	1.04010E-01	2.05020E-01
2.25220E+03	1.52950E-01	6.56540E-01	1.00420E-01	1.97930E-01
2.25230E+03	1.47730E-01	6.56530E-01	9.69890E-02	1.91170E-01
2.25240E+03	1.42760E-01	6.56530E-01	9.37280E-02	1.84740E-01
2.25250E+03	1.38040E-01	6.56520E-01	9.06270E-02	1.78630E-01
2.25260E+03	1.33550E-01	6.56510E-01	8.76770E-02	1.72820E-01
2.25270E+03	1.29270E-01	6.56510E-01	8.48660E-02	1.67280E-01
2.25280E+03	1.25180E-01	6.56500E-01	8.21800E-02	1.61980E-01
2.25290E+03	1.21260E-01	6.56500E-01	7.96040E-02	1.56900E-01
2.25300E+03	1.17480E-01	6.56490E-01	7.71210E-02	1.52010E-01
2.25310E+03	1.13810E-01	6.56490E-01	7.47150E-02	1.47270E-01
2.25320E+03	1.10240E-01	6.56480E-01	7.23710E-02	1.42650E-01
2.25330E+03	1.06740E-01	6.56480E-01	7.00730E-02	1.38120E-01
2.25340E+03	1.03290E-01	6.56470E-01	6.78080E-02	1.33650E-01
2.25350E+03	9.98770E-02	6.56470E-01	6.55660E-02	1.29230E-01
2.25360E+03	9.64880E-02	6.56470E-01	6.33410E-02	1.24850E-01
2.25370E+03	9.31160E-02	6.56460E-01	6.11270E-02	1.20480E-01
2.25380E+03	8.97580E-02	6.56460E-01	5.89220E-02	1.16140E-01

2.25390E+03	8.64160E-02	6.56450E-01	5.67280E-02	1.11810E-01
2.25400E+03	8.30980E-02	6.56450E-01	5.45490E-02	1.07520E-01
2.25410E+03	7.98120E-02	6.56460E-01	5.23930E-02	1.03270E-01
2.25420E+03	7.65730E-02	6.56470E-01	5.02680E-02	9.90800E-02
2.25430E+03	7.33960E-02	6.56470E-01	4.81830E-02	9.49700E-02
2.25440E+03	7.02980E-02	6.56480E-01	4.61490E-02	9.09620E-02
2.25450E+03	6.72950E-02	6.56560E-01	4.41840E-02	8.70880E-02
2.25460E+03	6.44060E-02	6.56640E-01	4.22920E-02	8.33590E-02
2.25470E+03	6.16440E-02	6.56720E-01	4.04830E-02	7.97940E-02
2.25480E+03	5.90230E-02	6.56780E-01	3.87650E-02	7.64080E-02
2.25490E+03	5.65520E-02	6.56850E-01	3.71460E-02	7.32160E-02
2.25500E+03	5.42360E-02	6.56910E-01	3.56290E-02	7.02260E-02
2.25510E+03	5.20800E-02	6.56990E-01	3.42160E-02	6.74410E-02
2.25520E+03	5.00800E-02	6.57070E-01	3.29060E-02	6.48590E-02
2.25530E+03	4.82320E-02	6.57140E-01	3.16950E-02	6.24720E-02
2.25540E+03	4.65250E-02	6.57220E-01	3.05770E-02	6.02690E-02
2.25550E+03	4.49500E-02	6.57290E-01	2.95450E-02	5.82350E-02
2.25560E+03	4.34900E-02	6.57370E-01	2.85890E-02	5.63500E-02
2.25570E+03	4.21290E-02	6.57450E-01	2.76980E-02	5.45940E-02
2.25580E+03	4.08520E-02	6.57520E-01	2.68610E-02	5.29450E-02
2.25590E+03	3.96410E-02	6.57600E-01	2.60680E-02	5.13810E-02
2.25600E+03	3.84800E-02	6.57680E-01	2.53080E-02	4.98820E-02
2.25610E+03	3.73550E-02	6.57800E-01	2.45720E-02	4.84330E-02
2.25620E+03	3.62540E-02	6.57940E-01	2.38530E-02	4.70150E-02
2.25630E+03	3.51660E-02	6.58070E-01	2.31420E-02	4.56140E-02
2.25640E+03	3.40870E-02	6.58210E-01	2.24360E-02	4.42230E-02
2.25650E+03	3.30120E-02	6.58340E-01	2.17330E-02	4.28370E-02
2.25660E+03	3.19410E-02	6.58480E-01	2.10320E-02	4.14560E-02
2.25670E+03	3.08780E-02	6.58640E-01	2.03370E-02	4.00860E-02
2.25680E+03	2.98270E-02	6.58800E-01	1.96500E-02	3.87320E-02
2.25690E+03	2.87970E-02	6.58960E-01	1.89760E-02	3.74030E-02
2.25700E+03	2.77960E-02	6.59130E-01	1.83210E-02	3.61120E-02
2.25710E+03	2.68340E-02	6.59280E-01	1.76910E-02	3.48700E-02
2.25720E+03	2.59200E-02	6.59440E-01	1.70930E-02	3.36900E-02
2.25730E+03	2.62730E-02	6.59600E-01	1.73290E-02	3.41570E-02
2.25740E+03	2.55740E-02	6.59760E-01	1.68730E-02	3.32570E-02
2.25750E+03	2.50630E-02	6.59920E-01	1.65390E-02	3.26000E-02
2.25760E+03	2.48980E-02	6.60080E-01	1.64350E-02	3.23940E-02
2.25770E+03	2.42440E-02	6.60240E-01	1.60070E-02	3.15500E-02
2.25780E+03	2.36090E-02	6.60400E-01	1.55910E-02	3.07310E-02
2.25790E+03	2.29910E-02	6.60560E-01	1.51870E-02	2.99340E-02
2.25800E+03	2.23900E-02	6.60720E-01	1.47940E-02	2.91590E-02
2.25810E+03	2.18070E-02	6.60880E-01	1.44120E-02	2.84060E-02

2.25820E+03	2.12400E-02	6.61040E-01	1.40400E-02	2.76740E-02
2.25830E+03	2.06900E-02	6.61200E-01	1.36800E-02	2.69640E-02
2.25840E+03	2.01570E-02	6.61370E-01	1.33310E-02	2.62770E-02
2.25850E+03	1.96440E-02	6.61530E-01	1.29950E-02	2.56130E-02
2.25860E+03	1.91490E-02	6.61690E-01	1.26710E-02	2.49740E-02
2.25870E+03	1.86740E-02	6.61850E-01	1.23590E-02	2.43610E-02
2.25880E+03	1.82190E-02	6.62010E-01	1.20610E-02	2.37730E-02
2.25890E+03	1.77840E-02	6.62100E-01	1.17750E-02	2.32090E-02
2.25900E+03	1.73700E-02	6.62180E-01	1.15020E-02	2.26710E-02
2.25910E+03	1.69760E-02	6.62270E-01	1.12420E-02	2.21590E-02
2.25920E+03	1.66010E-02	6.62350E-01	1.09960E-02	2.16730E-02
2.25930E+03	1.62440E-02	6.62430E-01	1.07610E-02	2.12100E-02
2.25940E+03	1.59050E-02	6.62520E-01	1.05380E-02	2.07700E-02
2.25950E+03	1.55830E-02	6.62600E-01	1.03250E-02	2.03510E-02
2.25960E+03	1.52740E-02	6.62680E-01	1.01220E-02	1.99510E-02
2.25970E+03	1.49790E-02	6.62770E-01	9.92770E-03	1.95680E-02
2.25980E+03	1.46960E-02	6.62850E-01	9.74120E-03	1.92000E-02
2.25990E+03	1.44230E-02	6.62940E-01	9.56150E-03	1.88460E-02
2.26000E+03	1.41590E-02	6.63020E-01	9.38770E-03	1.85040E-02
2.26010E+03	1.39030E-02	6.63120E-01	9.21940E-03	1.81720E-02
2.26020E+03	1.36540E-02	6.63220E-01	9.05560E-03	1.78490E-02
2.26030E+03	1.34110E-02	6.63330E-01	8.89600E-03	1.75340E-02
2.26040E+03	1.31740E-02	6.63430E-01	8.74020E-03	1.72270E-02
2.26050E+03	1.29430E-02	6.63500E-01	8.58770E-03	1.69270E-02
2.26060E+03	1.27170E-02	6.63580E-01	8.43880E-03	1.66330E-02
2.26070E+03	1.24970E-02	6.63650E-01	8.29360E-03	1.63470E-02
2.26080E+03	1.22830E-02	6.63730E-01	8.15230E-03	1.60680E-02
2.26090E+03	1.20740E-02	6.63800E-01	8.01480E-03	1.57980E-02
2.26100E+03	1.18720E-02	6.63880E-01	7.88160E-03	1.55350E-02
2.26110E+03	1.16760E-02	6.64010E-01	7.75320E-03	1.52820E-02
2.26120E+03	1.14870E-02	6.64140E-01	7.62930E-03	1.50380E-02
2.26130E+03	1.13050E-02	6.64270E-01	7.50960E-03	1.48020E-02
2.26140E+03	1.11290E-02	6.64400E-01	7.39420E-03	1.45740E-02
2.26150E+03	1.09590E-02	6.64530E-01	7.28280E-03	1.43550E-02
2.26160E+03	1.07950E-02	6.64670E-01	7.17510E-03	1.41430E-02
2.26170E+03	1.06360E-02	6.64800E-01	7.07070E-03	1.39370E-02
2.26180E+03	1.04810E-02	6.64930E-01	6.96910E-03	1.37360E-02
2.26190E+03	1.03300E-02	6.65060E-01	6.86990E-03	1.35410E-02
2.26200E+03	1.01810E-02	6.65200E-01	6.77230E-03	1.33490E-02
2.26210E+03	1.00340E-02	6.65360E-01	6.67630E-03	1.31590E-02
2.26220E+03	9.88870E-03	6.65510E-01	6.58100E-03	1.29720E-02
2.26230E+03	9.74390E-03	6.65670E-01	6.48630E-03	1.27850E-02
2.26240E+03	9.59960E-03	6.65830E-01	6.39170E-03	1.25980E-02

2.26250E+03	9.45570E-03	6.65990E-01	6.29740E-03	1.24130E-02
2.26260E+03	9.31240E-03	6.66150E-01	6.20350E-03	1.22270E-02
2.26270E+03	9.17030E-03	6.66310E-01	6.11030E-03	1.20440E-02
2.26280E+03	9.03000E-03	6.66470E-01	6.01820E-03	1.18620E-02
2.26290E+03	8.89260E-03	6.66630E-01	5.92810E-03	1.16850E-02
2.26300E+03	8.75930E-03	6.66790E-01	5.84060E-03	1.15120E-02
2.26310E+03	8.63150E-03	6.66950E-01	5.75680E-03	1.13470E-02
2.26320E+03	8.51080E-03	6.67110E-01	5.67760E-03	1.11910E-02
2.26330E+03	8.39870E-03	6.67280E-01	5.60430E-03	1.10460E-02
2.26340E+03	8.29650E-03	6.67460E-01	5.53760E-03	1.09150E-02
2.26350E+03	8.20580E-03	6.67640E-01	5.47850E-03	1.07980E-02
2.26360E+03	8.12760E-03	6.67810E-01	5.42770E-03	1.06980E-02
2.26370E+03	8.06280E-03	6.67990E-01	5.38590E-03	1.06160E-02
2.26380E+03	8.01210E-03	6.68160E-01	5.35340E-03	1.05520E-02
2.26390E+03	7.97550E-03	6.68340E-01	5.33040E-03	1.05060E-02
2.26400E+03	7.95300E-03	6.68500E-01	5.31660E-03	1.04790E-02
2.26410E+03	7.94380E-03	6.68600E-01	5.31120E-03	1.04690E-02
2.26420E+03	7.94710E-03	6.68700E-01	5.31420E-03	1.04750E-02
2.26430E+03	7.96150E-03	6.68800E-01	5.32470E-03	1.04950E-02
2.26440E+03	7.98530E-03	6.68910E-01	5.34140E-03	1.05280E-02
2.26450E+03	8.01670E-03	6.69010E-01	5.36320E-03	1.05710E-02
2.26460E+03	8.05360E-03	6.69110E-01	5.38870E-03	1.06210E-02
2.26470E+03	8.09380E-03	6.69210E-01	5.41650E-03	1.06760E-02
2.26480E+03	8.13510E-03	6.69310E-01	5.44490E-03	1.07320E-02
2.26490E+03	8.17530E-03	6.69410E-01	5.47270E-03	1.07870E-02
2.26500E+03	8.21240E-03	6.69520E-01	5.49840E-03	1.08380E-02
2.26510E+03	8.24450E-03	6.69610E-01	5.52060E-03	1.08810E-02
2.26520E+03	8.26990E-03	6.69690E-01	5.53830E-03	1.09160E-02
2.26530E+03	8.28720E-03	6.69780E-01	5.55060E-03	1.09400E-02
2.26540E+03	8.29530E-03	6.69850E-01	5.55660E-03	1.09520E-02
2.26550E+03	8.29320E-03	6.69830E-01	5.55500E-03	1.09490E-02
2.26560E+03	8.28050E-03	6.69810E-01	5.54630E-03	1.09320E-02
2.26570E+03	8.25670E-03	6.69790E-01	5.53020E-03	1.09000E-02
2.26580E+03	8.22180E-03	6.69770E-01	5.50670E-03	1.08540E-02
2.26590E+03	8.17580E-03	6.69740E-01	5.47570E-03	1.07930E-02
2.26600E+03	8.11880E-03	6.69720E-01	5.43730E-03	1.07170E-02
2.26610E+03	8.05120E-03	6.69680E-01	5.39180E-03	1.06270E-02
2.26620E+03	7.97330E-03	6.69650E-01	5.33930E-03	1.05240E-02
2.26630E+03	7.88530E-03	6.69610E-01	5.28010E-03	1.04070E-02
2.26640E+03	7.78770E-03	6.69570E-01	5.21440E-03	1.02780E-02
2.26650E+03	7.68070E-03	6.69530E-01	5.14250E-03	1.01360E-02
2.26660E+03	7.56460E-03	6.69500E-01	5.06450E-03	9.98230E-03
2.26670E+03	7.43950E-03	6.69460E-01	4.98050E-03	9.81680E-03

2.26680E+03	7.30580E-03	6.69420E-01	4.89070E-03	9.63980E-03
2.26690E+03	7.16380E-03	6.69390E-01	4.79540E-03	9.45190E-03
2.26700E+03	7.01380E-03	6.69350E-01	4.69460E-03	9.25340E-03
2.26710E+03	6.85620E-03	6.69310E-01	4.58890E-03	9.04490E-03
2.26720E+03	6.69160E-03	6.69270E-01	4.47850E-03	8.82730E-03
2.26730E+03	6.52090E-03	6.69230E-01	4.36390E-03	8.60150E-03
2.26740E+03	6.34490E-03	6.69190E-01	4.24590E-03	8.36900E-03
2.26750E+03	6.16500E-03	6.69150E-01	4.12530E-03	8.13120E-03
2.26760E+03	5.98260E-03	6.69100E-01	4.00300E-03	7.89000E-03
2.26770E+03	5.79920E-03	6.69050E-01	3.88000E-03	7.64760E-03
2.26780E+03	5.61670E-03	6.69000E-01	3.75760E-03	7.40650E-03
2.26790E+03	5.43720E-03	6.68950E-01	3.63720E-03	7.16910E-03
2.26800E+03	5.26250E-03	6.68900E-01	3.52010E-03	6.93820E-03
2.26810E+03	5.09470E-03	6.68840E-01	3.40750E-03	6.71640E-03
2.26820E+03	4.93580E-03	6.68770E-01	3.30090E-03	6.50630E-03
2.26830E+03	4.78770E-03	6.68700E-01	3.20160E-03	6.31040E-03
2.26840E+03	4.65190E-03	6.68640E-01	3.11040E-03	6.13070E-03
2.26850E+03	4.52950E-03	6.68570E-01	3.02830E-03	5.96890E-03
2.26860E+03	4.42160E-03	6.68500E-01	2.95580E-03	5.82610E-03
2.26870E+03	4.32840E-03	6.68440E-01	2.89330E-03	5.70280E-03
2.26880E+03	4.24990E-03	6.68370E-01	2.84050E-03	5.59880E-03
2.26890E+03	4.18560E-03	6.68300E-01	2.79720E-03	5.51350E-03
2.26900E+03	4.13430E-03	6.68240E-01	2.76270E-03	5.44540E-03
2.26910E+03	4.09450E-03	6.68170E-01	2.73590E-03	5.39250E-03
2.26920E+03	4.06450E-03	6.68100E-01	2.71550E-03	5.35240E-03
2.26930E+03	4.04190E-03	6.68040E-01	2.70010E-03	5.32210E-03
2.26940E+03	4.02440E-03	6.67970E-01	2.68820E-03	5.29850E-03
2.26950E+03	4.00950E-03	6.67900E-01	2.67790E-03	5.27830E-03
2.26960E+03	3.99470E-03	6.67840E-01	2.66780E-03	5.25830E-03
2.26970E+03	3.97770E-03	6.67770E-01	2.65620E-03	5.23550E-03
2.26980E+03	3.95650E-03	6.67700E-01	2.64170E-03	5.20700E-03
2.26990E+03	3.92940E-03	6.67710E-01	2.62370E-03	5.17140E-03
2.27000E+03	3.89520E-03	6.67760E-01	2.60100E-03	5.12680E-03
2.27010E+03	3.85320E-03	6.67970E-01	2.57380E-03	5.07310E-03
2.27020E+03	3.80340E-03	6.68180E-01	2.54130E-03	5.00910E-03
2.27030E+03	3.74610E-03	6.68390E-01	2.50380E-03	4.93520E-03
2.27040E+03	3.68230E-03	6.68600E-01	2.46200E-03	4.85270E-03
2.27050E+03	3.61370E-03	6.68770E-01	2.41680E-03	4.76360E-03
2.27060E+03	3.54210E-03	6.68800E-01	2.36900E-03	4.66940E-03
2.27070E+03	3.46990E-03	6.68830E-01	2.32080E-03	4.57430E-03
2.27080E+03	3.39940E-03	6.68860E-01	2.27370E-03	4.48160E-03
2.27090E+03	3.33330E-03	6.68890E-01	2.22960E-03	4.39470E-03
2.27100E+03	3.27400E-03	6.68920E-01	2.19010E-03	4.31670E-03

2.27110E+03	3.22390E-03	6.68950E-01	2.15660E-03	4.25080E-03
2.27120E+03	3.18480E-03	6.68980E-01	2.13060E-03	4.19940E-03
2.27130E+03	3.15830E-03	6.69010E-01	2.11290E-03	4.16470E-03
2.27140E+03	3.14540E-03	6.69030E-01	2.10440E-03	4.14780E-03
2.27150E+03	3.14250E-03	6.69060E-01	2.10250E-03	4.14420E-03
2.27160E+03	3.13960E-03	6.69090E-01	2.10070E-03	4.14060E-03
2.27170E+03	3.13680E-03	6.69120E-01	2.09890E-03	4.13700E-03
2.27180E+03	3.13390E-03	6.69150E-01	2.09700E-03	4.13340E-03
2.27190E+03	3.13100E-03	6.69170E-01	2.09520E-03	4.12980E-03
2.27200E+03	3.12820E-03	6.69200E-01	2.09340E-03	4.12620E-03
2.27210E+03	3.12530E-03	6.69170E-01	2.09140E-03	4.12220E-03
2.27220E+03	3.12240E-03	6.69140E-01	2.08930E-03	4.11820E-03
2.27230E+03	3.11960E-03	6.69110E-01	2.08730E-03	4.11420E-03
2.27240E+03	3.11670E-03	6.69070E-01	2.08530E-03	4.11020E-03
2.27250E+03	3.11380E-03	6.69040E-01	2.08330E-03	4.10620E-03
2.27260E+03	3.11350E-03	6.69010E-01	2.08300E-03	4.10570E-03
2.27270E+03	3.11070E-03	6.68980E-01	2.08100E-03	4.10170E-03
2.27280E+03	3.10780E-03	6.68950E-01	2.07900E-03	4.09770E-03
2.27290E+03	3.10490E-03	6.68910E-01	2.07690E-03	4.09370E-03
2.27300E+03	3.10210E-03	6.68880E-01	2.07490E-03	4.08980E-03
2.27310E+03	3.09920E-03	6.68850E-01	2.07290E-03	4.08580E-03
2.27320E+03	3.09630E-03	6.68820E-01	2.07090E-03	4.08180E-03
2.27330E+03	3.09350E-03	6.68790E-01	2.06890E-03	4.07780E-03
2.27340E+03	3.09060E-03	6.68750E-01	2.06680E-03	4.07380E-03
2.27350E+03	3.08770E-03	6.68720E-01	2.06480E-03	4.06980E-03
2.27360E+03	3.08490E-03	6.68680E-01	2.06280E-03	4.06580E-03
2.27370E+03	3.08200E-03	6.68640E-01	2.06070E-03	4.06180E-03
2.27380E+03	3.07910E-03	6.68600E-01	2.05870E-03	4.05780E-03
2.27390E+03	3.07620E-03	6.68570E-01	2.05670E-03	4.05380E-03
2.27400E+03	3.07340E-03	6.68530E-01	2.05460E-03	4.04980E-03
2.27410E+03	3.07050E-03	6.68510E-01	2.05270E-03	4.04590E-03
2.27420E+03	3.06760E-03	6.68490E-01	2.05070E-03	4.04200E-03
2.27430E+03	3.06480E-03	6.68420E-01	2.04850E-03	4.03780E-03
2.27440E+03	3.06190E-03	6.68350E-01	2.04640E-03	4.03360E-03
2.27450E+03	3.05900E-03	6.68280E-01	2.04430E-03	4.02940E-03
2.27460E+03	3.05610E-03	6.68210E-01	2.04220E-03	4.02520E-03
2.27470E+03	3.05330E-03	6.68140E-01	2.04000E-03	4.02100E-03
2.27480E+03	3.05040E-03	6.68080E-01	2.03790E-03	4.01680E-03
2.27490E+03	2.96830E-03	6.68010E-01	1.98280E-03	3.90820E-03
2.27500E+03	2.63670E-03	6.67940E-01	1.76110E-03	3.47130E-03
2.27510E+03	2.39660E-03	6.67890E-01	1.60070E-03	3.15500E-03
2.27520E+03	0.00000E+00	6.67830E-01	0.00000E+00	0.00000E+00
Channel 16				

Wavenumber	HIRS Filter Transmittance	Optical Element Transmittance	Product of the HIRS Filter and Optical Element Transmittances	Normalized Value of Column 4
2.21190E+03	0.00000E+00	6.23010E-01	0.00000E+00	0.00000E+00
2.21200E+03	4.24280E-04	6.23160E-01	2.64390E-04	5.09430E-04
2.21210E+03	4.22370E-04	6.23320E-01	2.63270E-04	5.07270E-04
2.21220E+03	3.99420E-04	6.23480E-01	2.49030E-04	4.79830E-04
2.21230E+03	3.59260E-04	6.23640E-01	2.24050E-04	4.31690E-04
2.21240E+03	3.06040E-04	6.23800E-01	1.90910E-04	3.67840E-04
2.21250E+03	2.44500E-04	6.23970E-01	1.52560E-04	2.93940E-04
2.21260E+03	1.80160E-04	6.24130E-01	1.12450E-04	2.16660E-04
2.21270E+03	1.21160E-04	6.24260E-01	7.56330E-05	1.45730E-04
2.21280E+03	8.62670E-05	6.24390E-01	5.38640E-05	1.03780E-04
2.21290E+03	1.00850E-04	6.24530E-01	6.29820E-05	1.21350E-04
2.21300E+03	3.21150E-04	6.24660E-01	2.00610E-04	3.86530E-04
2.21310E+03	3.33070E-04	6.24790E-01	2.08100E-04	4.00960E-04
2.21320E+03	3.48900E-04	6.24920E-01	2.18040E-04	4.20110E-04
2.21330E+03	3.70250E-04	6.25060E-01	2.31430E-04	4.45920E-04
2.21340E+03	3.98500E-04	6.25200E-01	2.49140E-04	4.80040E-04
2.21350E+03	4.34760E-04	6.25340E-01	2.71870E-04	5.23840E-04
2.21360E+03	4.79840E-04	6.25480E-01	3.00130E-04	5.78290E-04
2.21370E+03	5.34130E-04	6.25620E-01	3.34160E-04	6.43860E-04
2.21380E+03	5.97500E-04	6.25760E-01	3.73890E-04	7.20400E-04
2.21390E+03	6.68750E-04	6.25900E-01	4.18570E-04	8.06490E-04
2.21400E+03	7.45350E-04	6.26040E-01	4.66610E-04	8.99060E-04
2.21410E+03	8.25490E-04	6.26170E-01	5.16900E-04	9.95950E-04
2.21420E+03	9.08460E-04	6.26300E-01	5.68970E-04	1.09630E-03
2.21430E+03	9.93760E-04	6.26430E-01	6.22520E-04	1.19950E-03
2.21440E+03	1.08090E-03	6.26560E-01	6.77250E-04	1.30490E-03
2.21450E+03	1.16940E-03	6.26690E-01	7.32850E-04	1.41200E-03
2.21460E+03	1.25860E-03	6.26820E-01	7.88930E-04	1.52010E-03
2.21470E+03	1.34800E-03	6.26950E-01	8.45100E-04	1.62830E-03
2.21480E+03	1.43670E-03	6.27080E-01	9.00920E-04	1.73590E-03
2.21490E+03	1.52410E-03	6.27180E-01	9.55910E-04	1.84180E-03
2.21500E+03	1.60950E-03	6.27280E-01	1.00960E-03	1.94530E-03
2.21510E+03	1.69200E-03	6.27380E-01	1.06160E-03	2.04540E-03
2.21520E+03	1.77100E-03	6.27490E-01	1.11130E-03	2.14120E-03
2.21530E+03	1.84560E-03	6.27600E-01	1.15830E-03	2.23170E-03
2.21540E+03	1.91510E-03	6.27710E-01	1.20210E-03	2.31630E-03
2.21550E+03	1.97920E-03	6.27810E-01	1.24250E-03	2.39410E-03
2.21560E+03	2.03720E-03	6.27920E-01	1.27920E-03	2.46470E-03
2.21570E+03	2.08890E-03	6.28030E-01	1.31190E-03	2.52770E-03

2.21580E+03	2.13410E-03	6.28140E-01	1.34050E-03	2.58290E-03
2.21590E+03	2.17300E-03	6.28240E-01	1.36520E-03	2.63040E-03
2.21600E+03	2.20560E-03	6.28350E-01	1.38590E-03	2.67030E-03
2.21610E+03	2.23210E-03	6.28450E-01	1.40270E-03	2.70280E-03
2.21620E+03	2.25290E-03	6.28540E-01	1.41600E-03	2.72840E-03
2.21630E+03	2.26840E-03	6.28640E-01	1.42600E-03	2.74750E-03
2.21640E+03	2.27890E-03	6.28730E-01	1.43280E-03	2.76080E-03
2.21650E+03	2.28510E-03	6.28830E-01	1.43690E-03	2.76860E-03
2.21660E+03	2.28730E-03	6.28930E-01	1.43850E-03	2.77170E-03
2.21670E+03	2.28600E-03	6.29020E-01	1.43800E-03	2.77060E-03
2.21680E+03	2.28180E-03	6.29120E-01	1.43550E-03	2.76600E-03
2.21690E+03	2.27520E-03	6.29210E-01	1.43160E-03	2.75830E-03
2.21700E+03	2.26670E-03	6.29310E-01	1.42640E-03	2.74840E-03
2.21710E+03	2.25670E-03	6.29410E-01	1.42040E-03	2.73680E-03
2.21720E+03	2.24600E-03	6.29520E-01	1.41390E-03	2.72420E-03
2.21730E+03	2.23490E-03	6.29630E-01	1.40720E-03	2.71130E-03
2.21740E+03	2.22410E-03	6.29730E-01	1.40060E-03	2.69870E-03
2.21750E+03	2.21420E-03	6.29840E-01	1.39460E-03	2.68710E-03
2.21760E+03	2.20580E-03	6.29950E-01	1.38950E-03	2.67730E-03
2.21770E+03	2.19950E-03	6.30050E-01	1.38580E-03	2.67010E-03
2.21780E+03	2.19580E-03	6.30160E-01	1.38370E-03	2.66610E-03
2.21790E+03	2.19540E-03	6.30260E-01	1.38370E-03	2.66600E-03
2.21800E+03	2.19890E-03	6.30380E-01	1.38610E-03	2.67070E-03
2.21810E+03	2.20680E-03	6.30500E-01	1.39140E-03	2.68090E-03
2.21820E+03	2.21980E-03	6.30620E-01	1.39980E-03	2.69710E-03
2.21830E+03	2.23820E-03	6.30740E-01	1.41170E-03	2.72000E-03
2.21840E+03	2.26240E-03	6.30860E-01	1.42730E-03	2.75000E-03
2.21850E+03	2.29270E-03	6.30990E-01	1.44670E-03	2.78740E-03
2.21860E+03	2.32930E-03	6.31110E-01	1.47000E-03	2.83240E-03
2.21870E+03	2.37200E-03	6.31230E-01	1.49730E-03	2.88490E-03
2.21880E+03	2.42070E-03	6.31350E-01	1.52830E-03	2.94470E-03
2.21890E+03	2.47490E-03	6.31480E-01	1.56280E-03	3.01120E-03
2.21900E+03	2.53420E-03	6.31600E-01	1.60060E-03	3.08400E-03
2.21910E+03	2.59780E-03	6.31720E-01	1.64110E-03	3.16200E-03
2.21920E+03	2.66500E-03	6.31840E-01	1.68390E-03	3.24440E-03
2.21930E+03	2.73490E-03	6.31920E-01	1.72830E-03	3.33000E-03
2.21940E+03	2.80650E-03	6.32010E-01	1.77380E-03	3.41760E-03
2.21950E+03	2.87900E-03	6.32100E-01	1.81980E-03	3.50630E-03
2.21960E+03	2.95130E-03	6.32180E-01	1.86580E-03	3.59500E-03
2.21970E+03	3.02280E-03	6.32270E-01	1.91120E-03	3.68250E-03
2.21980E+03	3.09260E-03	6.32360E-01	1.95560E-03	3.76810E-03
2.21990E+03	3.16030E-03	6.32440E-01	1.99870E-03	3.85100E-03
2.22000E+03	3.22530E-03	6.32530E-01	2.04010E-03	3.93080E-03

2.22010E+03	3.28750E-03	6.32590E-01	2.07970E-03	4.00710E-03
2.22020E+03	3.34690E-03	6.32660E-01	2.11740E-03	4.07980E-03
2.22030E+03	3.40360E-03	6.32730E-01	2.15350E-03	4.14940E-03
2.22040E+03	3.45790E-03	6.32810E-01	2.18820E-03	4.21610E-03
2.22050E+03	3.51040E-03	6.32880E-01	2.22160E-03	4.28060E-03
2.22060E+03	3.56170E-03	6.32960E-01	2.25440E-03	4.34370E-03
2.22070E+03	3.61260E-03	6.33030E-01	2.28690E-03	4.40640E-03
2.22080E+03	3.66400E-03	6.33110E-01	2.31970E-03	4.46960E-03
2.22090E+03	3.71660E-03	6.33180E-01	2.35330E-03	4.53430E-03
2.22100E+03	3.77120E-03	6.33260E-01	2.38820E-03	4.60150E-03
2.22110E+03	3.82860E-03	6.33330E-01	2.42480E-03	4.67200E-03
2.22120E+03	3.88920E-03	6.33400E-01	2.46340E-03	4.74650E-03
2.22130E+03	3.95350E-03	6.33470E-01	2.50440E-03	4.82550E-03
2.22140E+03	4.02170E-03	6.33550E-01	2.54790E-03	4.90920E-03
2.22150E+03	4.09370E-03	6.33650E-01	2.59400E-03	4.99810E-03
2.22160E+03	4.16960E-03	6.33760E-01	2.64250E-03	5.09150E-03
2.22170E+03	4.24880E-03	6.33870E-01	2.69320E-03	5.18920E-03
2.22180E+03	4.33100E-03	6.33980E-01	2.74580E-03	5.29050E-03
2.22190E+03	4.41560E-03	6.34080E-01	2.79990E-03	5.39480E-03
2.22200E+03	4.50200E-03	6.34190E-01	2.85510E-03	5.50110E-03
2.22210E+03	4.58940E-03	6.34280E-01	2.91100E-03	5.60880E-03
2.22220E+03	4.67730E-03	6.34370E-01	2.96710E-03	5.71700E-03
2.22230E+03	4.76490E-03	6.34470E-01	3.02320E-03	5.82500E-03
2.22240E+03	4.85200E-03	6.34560E-01	3.07890E-03	5.93240E-03
2.22250E+03	4.93820E-03	6.34650E-01	3.13410E-03	6.03860E-03
2.22260E+03	5.02340E-03	6.34750E-01	3.18860E-03	6.14370E-03
2.22270E+03	5.10750E-03	6.34840E-01	3.24250E-03	6.24750E-03
2.22280E+03	5.19100E-03	6.34930E-01	3.29600E-03	6.35060E-03
2.22290E+03	5.27440E-03	6.35030E-01	3.34940E-03	6.45350E-03
2.22300E+03	5.35820E-03	6.35120E-01	3.40310E-03	6.55700E-03
2.22310E+03	5.44350E-03	6.35210E-01	3.45780E-03	6.66230E-03
2.22320E+03	5.53110E-03	6.35310E-01	3.51390E-03	6.77060E-03
2.22330E+03	5.62220E-03	6.35400E-01	3.57230E-03	6.88310E-03
2.22340E+03	5.71790E-03	6.35490E-01	3.63370E-03	7.00130E-03
2.22350E+03	5.81930E-03	6.35590E-01	3.69870E-03	7.12660E-03
2.22360E+03	5.92750E-03	6.35680E-01	3.76800E-03	7.26010E-03
2.22370E+03	6.04340E-03	6.35750E-01	3.84210E-03	7.40280E-03
2.22380E+03	6.16770E-03	6.35820E-01	3.92160E-03	7.55600E-03
2.22390E+03	6.30120E-03	6.35890E-01	4.00680E-03	7.72030E-03
2.22400E+03	6.44420E-03	6.35960E-01	4.09820E-03	7.89640E-03
2.22410E+03	6.59690E-03	6.36050E-01	4.19600E-03	8.08470E-03
2.22420E+03	6.75960E-03	6.36140E-01	4.30010E-03	8.28530E-03
2.22430E+03	6.93210E-03	6.36230E-01	4.41040E-03	8.49790E-03

2.22440E+03	7.11420E-03	6.36320E-01	4.52690E-03	8.72230E-03
2.22450E+03	7.30550E-03	6.36410E-01	4.64930E-03	8.95820E-03
2.22460E+03	7.50590E-03	6.36500E-01	4.77750E-03	9.20520E-03
2.22470E+03	7.71490E-03	6.36590E-01	4.91120E-03	9.46290E-03
2.22480E+03	7.93220E-03	6.36680E-01	5.05030E-03	9.73080E-03
2.22490E+03	8.15770E-03	6.36770E-01	5.19460E-03	1.00090E-02
2.22500E+03	8.39120E-03	6.36860E-01	5.34410E-03	1.02970E-02
2.22510E+03	8.63300E-03	6.36950E-01	5.49880E-03	1.05950E-02
2.22520E+03	8.88330E-03	6.37040E-01	5.65900E-03	1.09040E-02
2.22530E+03	9.14270E-03	6.37130E-01	5.82510E-03	1.12240E-02
2.22540E+03	9.41180E-03	6.37220E-01	5.99740E-03	1.15560E-02
2.22550E+03	9.69170E-03	6.37310E-01	6.17660E-03	1.19010E-02
2.22560E+03	9.98340E-03	6.37390E-01	6.36340E-03	1.22610E-02
2.22570E+03	1.02880E-02	6.37480E-01	6.55860E-03	1.26370E-02
2.22580E+03	1.06080E-02	6.37570E-01	6.76310E-03	1.30310E-02
2.22590E+03	1.09430E-02	6.37660E-01	6.97790E-03	1.34450E-02
2.22600E+03	1.12960E-02	6.37730E-01	7.20360E-03	1.38800E-02
2.22610E+03	1.16670E-02	6.37760E-01	7.44100E-03	1.43370E-02
2.22620E+03	1.20590E-02	6.37790E-01	7.69120E-03	1.48190E-02
2.22630E+03	1.24720E-02	6.37820E-01	7.95510E-03	1.53280E-02
2.22640E+03	1.29080E-02	6.37850E-01	8.23340E-03	1.58640E-02
2.22650E+03	1.33670E-02	6.37880E-01	8.52670E-03	1.64290E-02
2.22660E+03	1.38500E-02	6.37910E-01	8.83540E-03	1.70240E-02
2.22670E+03	1.43590E-02	6.37940E-01	9.15980E-03	1.76490E-02
2.22680E+03	1.48910E-02	6.37970E-01	9.50030E-03	1.83050E-02
2.22690E+03	1.54500E-02	6.38000E-01	9.85690E-03	1.89920E-02
2.22700E+03	1.60340E-02	6.38030E-01	1.02300E-02	1.97110E-02
2.22710E+03	1.66420E-02	6.38060E-01	1.06190E-02	2.04600E-02
2.22720E+03	1.72770E-02	6.38080E-01	1.10240E-02	2.12410E-02
2.22730E+03	1.79360E-02	6.38100E-01	1.14450E-02	2.20520E-02
2.22740E+03	1.86200E-02	6.38110E-01	1.18820E-02	2.28940E-02
2.22750E+03	1.93300E-02	6.38130E-01	1.23350E-02	2.37660E-02
2.22760E+03	2.00640E-02	6.38140E-01	1.28040E-02	2.46700E-02
2.22770E+03	2.08240E-02	6.38150E-01	1.32890E-02	2.56040E-02
2.22780E+03	2.16090E-02	6.38170E-01	1.37900E-02	2.65710E-02
2.22790E+03	2.24210E-02	6.38180E-01	1.43090E-02	2.75700E-02
2.22800E+03	2.32600E-02	6.38190E-01	1.48440E-02	2.86020E-02
2.22810E+03	2.41270E-02	6.38270E-01	1.54000E-02	2.96720E-02
2.22820E+03	2.50240E-02	6.38350E-01	1.59740E-02	3.07780E-02
2.22830E+03	2.53780E-02	6.38430E-01	1.62020E-02	3.12180E-02
2.22840E+03	2.62840E-02	6.38510E-01	1.67830E-02	3.23360E-02
2.22850E+03	2.72250E-02	6.38580E-01	1.73850E-02	3.34970E-02
2.22860E+03	2.82030E-02	6.38660E-01	1.80120E-02	3.47050E-02

2.22870E+03	2.92220E-02	6.38740E-01	1.86660E-02	3.59650E-02
2.22880E+03	3.02860E-02	6.38820E-01	1.93470E-02	3.72780E-02
2.22890E+03	3.13970E-02	6.38900E-01	2.00590E-02	3.86500E-02
2.22900E+03	3.25570E-02	6.38980E-01	2.08030E-02	4.00830E-02
2.22910E+03	3.37680E-02	6.39050E-01	2.15790E-02	4.15790E-02
2.22920E+03	3.50320E-02	6.39130E-01	2.23900E-02	4.31410E-02
2.22930E+03	3.63520E-02	6.39200E-01	2.32370E-02	4.47720E-02
2.22940E+03	3.77300E-02	6.39280E-01	2.41200E-02	4.64740E-02
2.22950E+03	3.91680E-02	6.39360E-01	2.50420E-02	4.82510E-02
2.22960E+03	4.06690E-02	6.39430E-01	2.60050E-02	5.01060E-02
2.22970E+03	4.22380E-02	6.39500E-01	2.70110E-02	5.20440E-02
2.22980E+03	4.38770E-02	6.39570E-01	2.80630E-02	5.40700E-02
2.22990E+03	4.55930E-02	6.39650E-01	2.91630E-02	5.61910E-02
2.23000E+03	4.73910E-02	6.39720E-01	3.03170E-02	5.84140E-02
2.23010E+03	4.92780E-02	6.39940E-01	3.15350E-02	6.07610E-02
2.23020E+03	5.12600E-02	6.40160E-01	3.28150E-02	6.32270E-02
2.23030E+03	5.33460E-02	6.40380E-01	3.41620E-02	6.58220E-02
2.23040E+03	5.55420E-02	6.40600E-01	3.55800E-02	6.85550E-02
2.23050E+03	5.78550E-02	6.40830E-01	3.70750E-02	7.14360E-02
2.23060E+03	6.02950E-02	6.41050E-01	3.86520E-02	7.44730E-02
2.23070E+03	6.28660E-02	6.41270E-01	4.03140E-02	7.76770E-02
2.23080E+03	6.55760E-02	6.41490E-01	4.20660E-02	8.10530E-02
2.23090E+03	6.84290E-02	6.41720E-01	4.39120E-02	8.46090E-02
2.23100E+03	7.14300E-02	6.41940E-01	4.58540E-02	8.83500E-02
2.23110E+03	7.45820E-02	6.42160E-01	4.78940E-02	9.22810E-02
2.23120E+03	7.78870E-02	6.42390E-01	5.00330E-02	9.64030E-02
2.23130E+03	8.13460E-02	6.42610E-01	5.22740E-02	1.00720E-01
2.23140E+03	8.49600E-02	6.42830E-01	5.46150E-02	1.05230E-01
2.23150E+03	8.87270E-02	6.43050E-01	5.70560E-02	1.09940E-01
2.23160E+03	9.26480E-02	6.43280E-01	5.95990E-02	1.14830E-01
2.23170E+03	9.67220E-02	6.43500E-01	6.22410E-02	1.19920E-01
2.23180E+03	1.00950E-01	6.43720E-01	6.49820E-02	1.25210E-01
2.23190E+03	1.05320E-01	6.43950E-01	6.78230E-02	1.30680E-01
2.23200E+03	1.09850E-01	6.44160E-01	7.07630E-02	1.36350E-01
2.23210E+03	1.14540E-01	6.44290E-01	7.37950E-02	1.42190E-01
2.23220E+03	1.19380E-01	6.44420E-01	7.69290E-02	1.48220E-01
2.23230E+03	1.24380E-01	6.44550E-01	8.01670E-02	1.54460E-01
2.23240E+03	1.29540E-01	6.44680E-01	8.35130E-02	1.60910E-01
2.23250E+03	1.34880E-01	6.44780E-01	8.69690E-02	1.67570E-01
2.23260E+03	1.40400E-01	6.44880E-01	9.05410E-02	1.74450E-01
2.23270E+03	1.46110E-01	6.44980E-01	9.42350E-02	1.81570E-01
2.23280E+03	1.52010E-01	6.45080E-01	9.80570E-02	1.88930E-01
2.23290E+03	1.58110E-01	6.45180E-01	1.02010E-01	1.96550E-01

2.23300E+03	1.64430E-01	6.45280E-01	1.06110E-01	2.04440E-01
2.23310E+03	1.70970E-01	6.45380E-01	1.10340E-01	2.12610E-01
2.23320E+03	1.77740E-01	6.45480E-01	1.14730E-01	2.21050E-01
2.23330E+03	1.84730E-01	6.45580E-01	1.19260E-01	2.29790E-01
2.23340E+03	1.91960E-01	6.45690E-01	1.23950E-01	2.38810E-01
2.23350E+03	1.99420E-01	6.45790E-01	1.28780E-01	2.48130E-01
2.23360E+03	2.07100E-01	6.45890E-01	1.33760E-01	2.57730E-01
2.23370E+03	2.15010E-01	6.45990E-01	1.38890E-01	2.67620E-01
2.23380E+03	2.23130E-01	6.46090E-01	1.44160E-01	2.77770E-01
2.23390E+03	2.31450E-01	6.46200E-01	1.49560E-01	2.88180E-01
2.23400E+03	2.39970E-01	6.46300E-01	1.55090E-01	2.98830E-01
2.23410E+03	2.48660E-01	6.46380E-01	1.60730E-01	3.09690E-01
2.23420E+03	2.57510E-01	6.46450E-01	1.66470E-01	3.20750E-01
2.23430E+03	2.66500E-01	6.46530E-01	1.72300E-01	3.31990E-01
2.23440E+03	2.75620E-01	6.46610E-01	1.78220E-01	3.43390E-01
2.23450E+03	2.84850E-01	6.46690E-01	1.84210E-01	3.54930E-01
2.23460E+03	2.94170E-01	6.46770E-01	1.90260E-01	3.66590E-01
2.23470E+03	3.03570E-01	6.46800E-01	1.96350E-01	3.78320E-01
2.23480E+03	3.13020E-01	6.46830E-01	2.02470E-01	3.90120E-01
2.23490E+03	3.22530E-01	6.46860E-01	2.08630E-01	4.01990E-01
2.23500E+03	3.32070E-01	6.46900E-01	2.14820E-01	4.13900E-01
2.23510E+03	3.41640E-01	6.46940E-01	2.21020E-01	4.25860E-01
2.23520E+03	3.51230E-01	6.46980E-01	2.27240E-01	4.37840E-01
2.23530E+03	3.60830E-01	6.47030E-01	2.33470E-01	4.49840E-01
2.23540E+03	3.70430E-01	6.47070E-01	2.39700E-01	4.61840E-01
2.23550E+03	3.80040E-01	6.47120E-01	2.45930E-01	4.73850E-01
2.23560E+03	3.89640E-01	6.47160E-01	2.52160E-01	4.85860E-01
2.23570E+03	3.99240E-01	6.47200E-01	2.58390E-01	4.97850E-01
2.23580E+03	4.08820E-01	6.47250E-01	2.64610E-01	5.09840E-01
2.23590E+03	4.18380E-01	6.47290E-01	2.70820E-01	5.21800E-01
2.23600E+03	4.27930E-01	6.47340E-01	2.77010E-01	5.33740E-01
2.23610E+03	4.37440E-01	6.47440E-01	2.83210E-01	5.45690E-01
2.23620E+03	4.46910E-01	6.47530E-01	2.89390E-01	5.57590E-01
2.23630E+03	4.56340E-01	6.47630E-01	2.95540E-01	5.69440E-01
2.23640E+03	4.65710E-01	6.47730E-01	3.01660E-01	5.81220E-01
2.23650E+03	4.75020E-01	6.47830E-01	3.07730E-01	5.92920E-01
2.23660E+03	4.84240E-01	6.47920E-01	3.13750E-01	6.04530E-01
2.23670E+03	4.93380E-01	6.48020E-01	3.19720E-01	6.16030E-01
2.23680E+03	5.02410E-01	6.48100E-01	3.25610E-01	6.27380E-01
2.23690E+03	5.11330E-01	6.48180E-01	3.31440E-01	6.38610E-01
2.23700E+03	5.20130E-01	6.48270E-01	3.37180E-01	6.49680E-01
2.23710E+03	5.28800E-01	6.48350E-01	3.42840E-01	6.60580E-01
2.23720E+03	5.37320E-01	6.48430E-01	3.48410E-01	6.71310E-01

2.23730E+03	5.45690E-01	6.48510E-01	3.53890E-01	6.81860E-01
2.23740E+03	5.53910E-01	6.48590E-01	3.59260E-01	6.92220E-01
2.23750E+03	5.61980E-01	6.48670E-01	3.64540E-01	7.02380E-01
2.23760E+03	5.69880E-01	6.48750E-01	3.69710E-01	7.12350E-01
2.23770E+03	5.77620E-01	6.48830E-01	3.74780E-01	7.22110E-01
2.23780E+03	5.85190E-01	6.48910E-01	3.79740E-01	7.31670E-01
2.23790E+03	5.92600E-01	6.48990E-01	3.84600E-01	7.41030E-01
2.23800E+03	5.99850E-01	6.49070E-01	3.89350E-01	7.50180E-01
2.23810E+03	6.06940E-01	6.49090E-01	3.93960E-01	7.59070E-01
2.23820E+03	6.13860E-01	6.49120E-01	3.98470E-01	7.67760E-01
2.23830E+03	6.20610E-01	6.49140E-01	4.02870E-01	7.76230E-01
2.23840E+03	6.27200E-01	6.49170E-01	4.07160E-01	7.84500E-01
2.23850E+03	6.33610E-01	6.49190E-01	4.11330E-01	7.92550E-01
2.23860E+03	6.39850E-01	6.49220E-01	4.15400E-01	8.00380E-01
2.23870E+03	6.45890E-01	6.49240E-01	4.19340E-01	8.07980E-01
2.23880E+03	6.51750E-01	6.49270E-01	4.23160E-01	8.15330E-01
2.23890E+03	6.57410E-01	6.49290E-01	4.26850E-01	8.22440E-01
2.23900E+03	6.62850E-01	6.49310E-01	4.30400E-01	8.29280E-01
2.23910E+03	6.68080E-01	6.49380E-01	4.33840E-01	8.35900E-01
2.23920E+03	6.73080E-01	6.49440E-01	4.37120E-01	8.42240E-01
2.23930E+03	6.77840E-01	6.49500E-01	4.40260E-01	8.48280E-01
2.23940E+03	6.82350E-01	6.49570E-01	4.43230E-01	8.54010E-01
2.23950E+03	6.86620E-01	6.49630E-01	4.46050E-01	8.59440E-01
2.23960E+03	6.90630E-01	6.49700E-01	4.48700E-01	8.64540E-01
2.23970E+03	6.94390E-01	6.49760E-01	4.51180E-01	8.69330E-01
2.23980E+03	6.97890E-01	6.49820E-01	4.53510E-01	8.73800E-01
2.23990E+03	7.01150E-01	6.49890E-01	4.55670E-01	8.77970E-01
2.24000E+03	7.04160E-01	6.49960E-01	4.57670E-01	8.81830E-01
2.24010E+03	7.06940E-01	6.50090E-01	4.59570E-01	8.85490E-01
2.24020E+03	7.09500E-01	6.50220E-01	4.61330E-01	8.88870E-01
2.24030E+03	7.11850E-01	6.50350E-01	4.62950E-01	8.92000E-01
2.24040E+03	7.14000E-01	6.50480E-01	4.64450E-01	8.94880E-01
2.24050E+03	7.15990E-01	6.50610E-01	4.65830E-01	8.97550E-01
2.24060E+03	7.17810E-01	6.50740E-01	4.67110E-01	9.00010E-01
2.24070E+03	7.19490E-01	6.50880E-01	4.68300E-01	9.02300E-01
2.24080E+03	7.21040E-01	6.51010E-01	4.69400E-01	9.04440E-01
2.24090E+03	7.22490E-01	6.51140E-01	4.70440E-01	9.06430E-01
2.24100E+03	7.23840E-01	6.51270E-01	4.71410E-01	9.08310E-01
2.24110E+03	7.25100E-01	6.51400E-01	4.72340E-01	9.10090E-01
2.24120E+03	7.26300E-01	6.51540E-01	4.73210E-01	9.11780E-01
2.24130E+03	7.27440E-01	6.51660E-01	4.74040E-01	9.13380E-01
2.24140E+03	7.28520E-01	6.51790E-01	4.74840E-01	9.14910E-01
2.24150E+03	7.29560E-01	6.51910E-01	4.75610E-01	9.16390E-01

2.24160E+03	7.30550E-01	6.52030E-01	4.76340E-01	9.17810E-01
2.24170E+03	7.31510E-01	6.52160E-01	4.77060E-01	9.19190E-01
2.24180E+03	7.32430E-01	6.52280E-01	4.77750E-01	9.20520E-01
2.24190E+03	7.33310E-01	6.52400E-01	4.78420E-01	9.21810E-01
2.24200E+03	7.34170E-01	6.52530E-01	4.79070E-01	9.23050E-01
2.24210E+03	7.34990E-01	6.52610E-01	4.79660E-01	9.24200E-01
2.24220E+03	7.35780E-01	6.52690E-01	4.80240E-01	9.25310E-01
2.24230E+03	7.36550E-01	6.52770E-01	4.80790E-01	9.26380E-01
2.24240E+03	7.37280E-01	6.52850E-01	4.81330E-01	9.27420E-01
2.24250E+03	7.37990E-01	6.52930E-01	4.81860E-01	9.28430E-01
2.24260E+03	7.38680E-01	6.53010E-01	4.82370E-01	9.29420E-01
2.24270E+03	7.39360E-01	6.53090E-01	4.82870E-01	9.30380E-01
2.24280E+03	7.40010E-01	6.53170E-01	4.83360E-01	9.31320E-01
2.24290E+03	7.40660E-01	6.53250E-01	4.83840E-01	9.32250E-01
2.24300E+03	7.41300E-01	6.53330E-01	4.84320E-01	9.33170E-01
2.24310E+03	7.41940E-01	6.53410E-01	4.84790E-01	9.34090E-01
2.24320E+03	7.42580E-01	6.53490E-01	4.85270E-01	9.35010E-01
2.24330E+03	7.43220E-01	6.53570E-01	4.85750E-01	9.35930E-01
2.24340E+03	7.43860E-01	6.53650E-01	4.86230E-01	9.36850E-01
2.24350E+03	7.44510E-01	6.53720E-01	4.86700E-01	9.37770E-01
2.24360E+03	7.45160E-01	6.53790E-01	4.87180E-01	9.38690E-01
2.24370E+03	7.45820E-01	6.53860E-01	4.87660E-01	9.39620E-01
2.24380E+03	7.46480E-01	6.53940E-01	4.88150E-01	9.40550E-01
2.24390E+03	7.47150E-01	6.54000E-01	4.88640E-01	9.41500E-01
2.24400E+03	7.47820E-01	6.54080E-01	4.89130E-01	9.42440E-01
2.24410E+03	7.48490E-01	6.54060E-01	4.89560E-01	9.43270E-01
2.24420E+03	7.49180E-01	6.54030E-01	4.89990E-01	9.44100E-01
2.24430E+03	7.49860E-01	6.54010E-01	4.90420E-01	9.44930E-01
2.24440E+03	7.50560E-01	6.53980E-01	4.90860E-01	9.45770E-01
2.24450E+03	7.51270E-01	6.53960E-01	4.91300E-01	9.46630E-01
2.24460E+03	7.52000E-01	6.53930E-01	4.91760E-01	9.47500E-01
2.24470E+03	7.52740E-01	6.53910E-01	4.92220E-01	9.48410E-01
2.24480E+03	7.53510E-01	6.53880E-01	4.92710E-01	9.49340E-01
2.24490E+03	7.54320E-01	6.53860E-01	4.93220E-01	9.50320E-01
2.24500E+03	7.55160E-01	6.53830E-01	4.93750E-01	9.51350E-01
2.24510E+03	7.56050E-01	6.53780E-01	4.94290E-01	9.52400E-01
2.24520E+03	7.57000E-01	6.53730E-01	4.94870E-01	9.53510E-01
2.24530E+03	7.57990E-01	6.53680E-01	4.95490E-01	9.54690E-01
2.24540E+03	7.59050E-01	6.53650E-01	4.96150E-01	9.55970E-01
2.24550E+03	7.60170E-01	6.53610E-01	4.96850E-01	9.57330E-01
2.24560E+03	7.61340E-01	6.53580E-01	4.97600E-01	9.58760E-01
2.24570E+03	7.62570E-01	6.53610E-01	4.98420E-01	9.60350E-01
2.24580E+03	7.63860E-01	6.53630E-01	4.99280E-01	9.62010E-01

2.24590E+03	7.65190E-01	6.53660E-01	5.00170E-01	9.63710E-01
2.24600E+03	7.66550E-01	6.53690E-01	5.01090E-01	9.65490E-01
2.24610E+03	7.67930E-01	6.53780E-01	5.02060E-01	9.67360E-01
2.24620E+03	7.69330E-01	6.53870E-01	5.03040E-01	9.69250E-01
2.24630E+03	7.70720E-01	6.53960E-01	5.04020E-01	9.71130E-01
2.24640E+03	7.72090E-01	6.54050E-01	5.04990E-01	9.73000E-01
2.24650E+03	7.73430E-01	6.54140E-01	5.05930E-01	9.74820E-01
2.24660E+03	7.74720E-01	6.54230E-01	5.06850E-01	9.76580E-01
2.24670E+03	7.75950E-01	6.54320E-01	5.07720E-01	9.78270E-01
2.24680E+03	7.77120E-01	6.54410E-01	5.08560E-01	9.79870E-01
2.24690E+03	7.78210E-01	6.54500E-01	5.09340E-01	9.81380E-01
2.24700E+03	7.79230E-01	6.54590E-01	5.10070E-01	9.82800E-01
2.24710E+03	7.80160E-01	6.54680E-01	5.10750E-01	9.84110E-01
2.24720E+03	7.81010E-01	6.54770E-01	5.11380E-01	9.85320E-01
2.24730E+03	7.81790E-01	6.54860E-01	5.11960E-01	9.86440E-01
2.24740E+03	7.82500E-01	6.54950E-01	5.12500E-01	9.87470E-01
2.24750E+03	7.83140E-01	6.55040E-01	5.12990E-01	9.88420E-01
2.24760E+03	7.83730E-01	6.55130E-01	5.13450E-01	9.89300E-01
2.24770E+03	7.84290E-01	6.55230E-01	5.13880E-01	9.90140E-01
2.24780E+03	7.84810E-01	6.55320E-01	5.14300E-01	9.90940E-01
2.24790E+03	7.85310E-01	6.55370E-01	5.14670E-01	9.91650E-01
2.24800E+03	7.85800E-01	6.55420E-01	5.15030E-01	9.92350E-01
2.24810E+03	7.86290E-01	6.55500E-01	5.15410E-01	9.93080E-01
2.24820E+03	7.86770E-01	6.55570E-01	5.15790E-01	9.93810E-01
2.24830E+03	7.87260E-01	6.55650E-01	5.16170E-01	9.94540E-01
2.24840E+03	7.87750E-01	6.55720E-01	5.16550E-01	9.95270E-01
2.24850E+03	7.88240E-01	6.55800E-01	5.16920E-01	9.96000E-01
2.24860E+03	7.88710E-01	6.55870E-01	5.17290E-01	9.96710E-01
2.24870E+03	7.89160E-01	6.55950E-01	5.17650E-01	9.97400E-01
2.24880E+03	7.89580E-01	6.56020E-01	5.17980E-01	9.98040E-01
2.24890E+03	7.89950E-01	6.56100E-01	5.18290E-01	9.98620E-01
2.24900E+03	7.90260E-01	6.56170E-01	5.18550E-01	9.99130E-01
2.24910E+03	7.90490E-01	6.56250E-01	5.18760E-01	9.99530E-01
2.24920E+03	7.90640E-01	6.56320E-01	5.18910E-01	9.99820E-01
2.24930E+03	7.90680E-01	6.56390E-01	5.18990E-01	9.99980E-01
2.24940E+03	7.90600E-01	6.56460E-01	5.19000E-01	1.00000E+00
2.24950E+03	7.90410E-01	6.56530E-01	5.18930E-01	9.99870E-01
2.24960E+03	7.90090E-01	6.56610E-01	5.18780E-01	9.99570E-01
2.24970E+03	7.89650E-01	6.56680E-01	5.18550E-01	9.99120E-01
2.24980E+03	7.89080E-01	6.56750E-01	5.18230E-01	9.98510E-01
2.24990E+03	7.88390E-01	6.56820E-01	5.17830E-01	9.97750E-01
2.25000E+03	7.87590E-01	6.56900E-01	5.17370E-01	9.96850E-01
2.25010E+03	7.86700E-01	6.56890E-01	5.16770E-01	9.95700E-01

2.25020E+03	7.85710E-01	6.56870E-01	5.16110E-01	9.94420E-01
2.25030E+03	7.84650E-01	6.56850E-01	5.15400E-01	9.93050E-01
2.25040E+03	7.83520E-01	6.56830E-01	5.14640E-01	9.91600E-01
2.25050E+03	7.82350E-01	6.56810E-01	5.13860E-01	9.90090E-01
2.25060E+03	7.81140E-01	6.56790E-01	5.13050E-01	9.88520E-01
2.25070E+03	7.79890E-01	6.56770E-01	5.12210E-01	9.86920E-01
2.25080E+03	7.78620E-01	6.56750E-01	5.11360E-01	9.85280E-01
2.25090E+03	7.77320E-01	6.56740E-01	5.10490E-01	9.83610E-01
2.25100E+03	7.75990E-01	6.56720E-01	5.09610E-01	9.81900E-01
2.25110E+03	7.74630E-01	6.56700E-01	5.08690E-01	9.80140E-01
2.25120E+03	7.73210E-01	6.56670E-01	5.07750E-01	9.78320E-01
2.25130E+03	7.71740E-01	6.56650E-01	5.06760E-01	9.76420E-01
2.25140E+03	7.70180E-01	6.56630E-01	5.05720E-01	9.74420E-01
2.25150E+03	7.68510E-01	6.56610E-01	5.04620E-01	9.72280E-01
2.25160E+03	7.66730E-01	6.56590E-01	5.03430E-01	9.69990E-01
2.25170E+03	7.64790E-01	6.56570E-01	5.02140E-01	9.67520E-01
2.25180E+03	7.62690E-01	6.56550E-01	5.00750E-01	9.64820E-01
2.25190E+03	7.60390E-01	6.56530E-01	4.99220E-01	9.61890E-01
2.25200E+03	7.57890E-01	6.56510E-01	4.97560E-01	9.58690E-01
2.25210E+03	7.55150E-01	6.56520E-01	4.95770E-01	9.55250E-01
2.25220E+03	7.52170E-01	6.56540E-01	4.93830E-01	9.51500E-01
2.25230E+03	7.48950E-01	6.56530E-01	4.91710E-01	9.47410E-01
2.25240E+03	7.45460E-01	6.56530E-01	4.89420E-01	9.43000E-01
2.25250E+03	7.41730E-01	6.56520E-01	4.86960E-01	9.38260E-01
2.25260E+03	7.37740E-01	6.56510E-01	4.84330E-01	9.33200E-01
2.25270E+03	7.33500E-01	6.56510E-01	4.81550E-01	9.27840E-01
2.25280E+03	7.29040E-01	6.56500E-01	4.78620E-01	9.22190E-01
2.25290E+03	7.24350E-01	6.56500E-01	4.75530E-01	9.16250E-01
2.25300E+03	7.19460E-01	6.56490E-01	4.72320E-01	9.10060E-01
2.25310E+03	7.14380E-01	6.56490E-01	4.68980E-01	9.03630E-01
2.25320E+03	7.09140E-01	6.56480E-01	4.65540E-01	8.96980E-01
2.25330E+03	7.03730E-01	6.56480E-01	4.61990E-01	8.90140E-01
2.25340E+03	6.98190E-01	6.56470E-01	4.58340E-01	8.83120E-01
2.25350E+03	6.92510E-01	6.56470E-01	4.54610E-01	8.75940E-01
2.25360E+03	6.86720E-01	6.56470E-01	4.50810E-01	8.68600E-01
2.25370E+03	6.80810E-01	6.56460E-01	4.46920E-01	8.61120E-01
2.25380E+03	6.74780E-01	6.56460E-01	4.42970E-01	8.53500E-01
2.25390E+03	6.68650E-01	6.56450E-01	4.38940E-01	8.45730E-01
2.25400E+03	6.62400E-01	6.56450E-01	4.34830E-01	8.37830E-01
2.25410E+03	6.56030E-01	6.56460E-01	4.30660E-01	8.29780E-01
2.25420E+03	6.49530E-01	6.56470E-01	4.26400E-01	8.21570E-01
2.25430E+03	6.42890E-01	6.56470E-01	4.22040E-01	8.13180E-01
2.25440E+03	6.36110E-01	6.56480E-01	4.17590E-01	8.04610E-01

2.25450E+03	6.29160E-01	6.56560E-01	4.13090E-01	7.95920E-01
2.25460E+03	6.22060E-01	6.56640E-01	4.08470E-01	7.87030E-01
2.25470E+03	6.14780E-01	6.56720E-01	4.03740E-01	7.77910E-01
2.25480E+03	6.07320E-01	6.56780E-01	3.98880E-01	7.68550E-01
2.25490E+03	5.99690E-01	6.56850E-01	3.93910E-01	7.58970E-01
2.25500E+03	5.91880E-01	6.56910E-01	3.88820E-01	7.49160E-01
2.25510E+03	5.83910E-01	6.56990E-01	3.83620E-01	7.39150E-01
2.25520E+03	5.75770E-01	6.57070E-01	3.78320E-01	7.28930E-01
2.25530E+03	5.67480E-01	6.57140E-01	3.72910E-01	7.18520E-01
2.25540E+03	5.59050E-01	6.57220E-01	3.67420E-01	7.07930E-01
2.25550E+03	5.50500E-01	6.57290E-01	3.61840E-01	6.97180E-01
2.25560E+03	5.41840E-01	6.57370E-01	3.56190E-01	6.86300E-01
2.25570E+03	5.33110E-01	6.57450E-01	3.50490E-01	6.75310E-01
2.25580E+03	5.24300E-01	6.57520E-01	3.44740E-01	6.64240E-01
2.25590E+03	5.15450E-01	6.57600E-01	3.38960E-01	6.53100E-01
2.25600E+03	5.06570E-01	6.57680E-01	3.33160E-01	6.41920E-01
2.25610E+03	4.97670E-01	6.57800E-01	3.27370E-01	6.30770E-01
2.25620E+03	4.88770E-01	6.57940E-01	3.21580E-01	6.19610E-01
2.25630E+03	4.79870E-01	6.58070E-01	3.15790E-01	6.08460E-01
2.25640E+03	4.71000E-01	6.58210E-01	3.10010E-01	5.97330E-01
2.25650E+03	4.62140E-01	6.58340E-01	3.04240E-01	5.86210E-01
2.25660E+03	4.53300E-01	6.58480E-01	2.98490E-01	5.75120E-01
2.25670E+03	4.44480E-01	6.58640E-01	2.92750E-01	5.64070E-01
2.25680E+03	4.35690E-01	6.58800E-01	2.87030E-01	5.53050E-01
2.25690E+03	4.26900E-01	6.58960E-01	2.81310E-01	5.42030E-01
2.25700E+03	4.18130E-01	6.59130E-01	2.75600E-01	5.31020E-01
2.25710E+03	4.09360E-01	6.59280E-01	2.69880E-01	5.20010E-01
2.25720E+03	4.00590E-01	6.59440E-01	2.64160E-01	5.08990E-01
2.25730E+03	3.91810E-01	6.59600E-01	2.58440E-01	4.97950E-01
2.25740E+03	3.83020E-01	6.59760E-01	2.52700E-01	4.86900E-01
2.25750E+03	3.74220E-01	6.59920E-01	2.46960E-01	4.75830E-01
2.25760E+03	3.65410E-01	6.60080E-01	2.41200E-01	4.64740E-01
2.25770E+03	3.56590E-01	6.60240E-01	2.35440E-01	4.53630E-01
2.25780E+03	3.47770E-01	6.60400E-01	2.29670E-01	4.42520E-01
2.25790E+03	3.38960E-01	6.60560E-01	2.23900E-01	4.31410E-01
2.25800E+03	3.30170E-01	6.60720E-01	2.18150E-01	4.20320E-01
2.25810E+03	3.21400E-01	6.60880E-01	2.12410E-01	4.09260E-01
2.25820E+03	3.12680E-01	6.61040E-01	2.06690E-01	3.98250E-01
2.25830E+03	3.04020E-01	6.61200E-01	2.01020E-01	3.87320E-01
2.25840E+03	2.95430E-01	6.61370E-01	1.95390E-01	3.76470E-01
2.25850E+03	2.86930E-01	6.61530E-01	1.89810E-01	3.65730E-01
2.25860E+03	2.78540E-01	6.61690E-01	1.84310E-01	3.55120E-01
2.25870E+03	2.70280E-01	6.61850E-01	1.78880E-01	3.44670E-01

2.25880E+03	2.62140E-01	6.62010E-01	1.73540E-01	3.34380E-01
2.25890E+03	2.54160E-01	6.62100E-01	1.68280E-01	3.24230E-01
2.25900E+03	2.46330E-01	6.62180E-01	1.63110E-01	3.14280E-01
2.25910E+03	2.38660E-01	6.62270E-01	1.58060E-01	3.04540E-01
2.25920E+03	2.31160E-01	6.62350E-01	1.53110E-01	2.95010E-01
2.25930E+03	2.23840E-01	6.62430E-01	1.48280E-01	2.85700E-01
2.25940E+03	2.16690E-01	6.62520E-01	1.43560E-01	2.76610E-01
2.25950E+03	2.09720E-01	6.62600E-01	1.38960E-01	2.67740E-01
2.25960E+03	2.02920E-01	6.62680E-01	1.34470E-01	2.59090E-01
2.25970E+03	1.96290E-01	6.62770E-01	1.30090E-01	2.50660E-01
2.25980E+03	1.89820E-01	6.62850E-01	1.25820E-01	2.42430E-01
2.25990E+03	1.83520E-01	6.62940E-01	1.21660E-01	2.34410E-01
2.26000E+03	1.77370E-01	6.63020E-01	1.17600E-01	2.26590E-01
2.26010E+03	1.71380E-01	6.63120E-01	1.13650E-01	2.18970E-01
2.26020E+03	1.65540E-01	6.63220E-01	1.09790E-01	2.11540E-01
2.26030E+03	1.59840E-01	6.63330E-01	1.06030E-01	2.04290E-01
2.26040E+03	1.54290E-01	6.63430E-01	1.02360E-01	1.97230E-01
2.26050E+03	1.48880E-01	6.63500E-01	9.87840E-02	1.90330E-01
2.26060E+03	1.43610E-01	6.63580E-01	9.52980E-02	1.83620E-01
2.26070E+03	1.38480E-01	6.63650E-01	9.19040E-02	1.77080E-01
2.26080E+03	1.33490E-01	6.63730E-01	8.86020E-02	1.70720E-01
2.26090E+03	1.28640E-01	6.63800E-01	8.53920E-02	1.64530E-01
2.26100E+03	1.23930E-01	6.63880E-01	8.22740E-02	1.58520E-01
2.26110E+03	1.19360E-01	6.64010E-01	7.92550E-02	1.52710E-01
2.26120E+03	1.14930E-01	6.64140E-01	7.63280E-02	1.47070E-01
2.26130E+03	1.10630E-01	6.64270E-01	7.34910E-02	1.41600E-01
2.26140E+03	1.06480E-01	6.64400E-01	7.07460E-02	1.36310E-01
2.26150E+03	1.02460E-01	6.64530E-01	6.80900E-02	1.31190E-01
2.26160E+03	9.85810E-02	6.64670E-01	6.55230E-02	1.26250E-01
2.26170E+03	9.48300E-02	6.64800E-01	6.30420E-02	1.21470E-01
2.26180E+03	9.12070E-02	6.64930E-01	6.06460E-02	1.16850E-01
2.26190E+03	8.77100E-02	6.65060E-01	5.83320E-02	1.12390E-01
2.26200E+03	8.43340E-02	6.65200E-01	5.60990E-02	1.08090E-01
2.26210E+03	8.10750E-02	6.65360E-01	5.39440E-02	1.03940E-01
2.26220E+03	7.79300E-02	6.65510E-01	5.18630E-02	9.99290E-02
2.26230E+03	7.48950E-02	6.65670E-01	4.98550E-02	9.60600E-02
2.26240E+03	7.19670E-02	6.65830E-01	4.79180E-02	9.23270E-02
2.26250E+03	6.91440E-02	6.65990E-01	4.60490E-02	8.87270E-02
2.26260E+03	6.64230E-02	6.66150E-01	4.42480E-02	8.52560E-02
2.26270E+03	6.38050E-02	6.66310E-01	4.25140E-02	8.19150E-02
2.26280E+03	6.12880E-02	6.66470E-01	4.08470E-02	7.87020E-02
2.26290E+03	5.88710E-02	6.66630E-01	3.92450E-02	7.56170E-02
2.26300E+03	5.65560E-02	6.66790E-01	3.77110E-02	7.26610E-02

2.26310E+03	5.43430E-02	6.66950E-01	3.62440E-02	6.98340E-02
2.26320E+03	5.22320E-02	6.67110E-01	3.48450E-02	6.71380E-02
2.26330E+03	5.02240E-02	6.67280E-01	3.35140E-02	6.45730E-02
2.26340E+03	4.83180E-02	6.67460E-01	3.22500E-02	6.21390E-02
2.26350E+03	4.65140E-02	6.67640E-01	3.10540E-02	5.98350E-02
2.26360E+03	4.48090E-02	6.67810E-01	2.99240E-02	5.76570E-02
2.26370E+03	4.32010E-02	6.67990E-01	2.88580E-02	5.56030E-02
2.26380E+03	4.16870E-02	6.68160E-01	2.78540E-02	5.36680E-02
2.26390E+03	4.02600E-02	6.68340E-01	2.69070E-02	5.18440E-02
2.26400E+03	3.89150E-02	6.68500E-01	2.60140E-02	5.01240E-02
2.26410E+03	3.76430E-02	6.68600E-01	2.51680E-02	4.84940E-02
2.26420E+03	3.64380E-02	6.68700E-01	2.43660E-02	4.69480E-02
2.26430E+03	3.52900E-02	6.68800E-01	2.36020E-02	4.54760E-02
2.26440E+03	3.41890E-02	6.68910E-01	2.28690E-02	4.40640E-02
2.26450E+03	3.31270E-02	6.69010E-01	2.21620E-02	4.27020E-02
2.26460E+03	3.20940E-02	6.69110E-01	2.14750E-02	4.13770E-02
2.26470E+03	3.10820E-02	6.69210E-01	2.08010E-02	4.00780E-02
2.26480E+03	3.00840E-02	6.69310E-01	2.01350E-02	3.87960E-02
2.26490E+03	2.90920E-02	6.69410E-01	1.94750E-02	3.75240E-02
2.26500E+03	2.81030E-02	6.69520E-01	1.88160E-02	3.62540E-02
2.26510E+03	2.71130E-02	6.69610E-01	1.81550E-02	3.49810E-02
2.26520E+03	2.61220E-02	6.69690E-01	1.74930E-02	3.37060E-02
2.26530E+03	2.51280E-02	6.69780E-01	1.68300E-02	3.24280E-02
2.26540E+03	2.41350E-02	6.69850E-01	1.61670E-02	3.11500E-02
2.26550E+03	2.31460E-02	6.69830E-01	1.55040E-02	2.98730E-02
2.26560E+03	2.21660E-02	6.69810E-01	1.48470E-02	2.86070E-02
2.26570E+03	2.12020E-02	6.69790E-01	1.42010E-02	2.73620E-02
2.26580E+03	2.02600E-02	6.69770E-01	1.35700E-02	2.61460E-02
2.26590E+03	1.99850E-02	6.69740E-01	1.33850E-02	2.57900E-02
2.26600E+03	1.92020E-02	6.69720E-01	1.28600E-02	2.47780E-02
2.26610E+03	1.84520E-02	6.69680E-01	1.23570E-02	2.38090E-02
2.26620E+03	1.77360E-02	6.69650E-01	1.18770E-02	2.28840E-02
2.26630E+03	1.70560E-02	6.69610E-01	1.14210E-02	2.20050E-02
2.26640E+03	1.64130E-02	6.69570E-01	1.09890E-02	2.11740E-02
2.26650E+03	1.58060E-02	6.69530E-01	1.05830E-02	2.03910E-02
2.26660E+03	1.52380E-02	6.69500E-01	1.02020E-02	1.96560E-02
2.26670E+03	1.47060E-02	6.69460E-01	9.84490E-03	1.89690E-02
2.26680E+03	1.42100E-02	6.69420E-01	9.51230E-03	1.83280E-02
2.26690E+03	1.37480E-02	6.69390E-01	9.20290E-03	1.77320E-02
2.26700E+03	1.33200E-02	6.69350E-01	8.91550E-03	1.71780E-02
2.26710E+03	1.29220E-02	6.69310E-01	8.64850E-03	1.66640E-02
2.26720E+03	1.25520E-02	6.69270E-01	8.40050E-03	1.61860E-02
2.26730E+03	1.22080E-02	6.69230E-01	8.16970E-03	1.57410E-02

2.26740E+03	1.18860E-02	6.69190E-01	7.95410E-03	1.53260E-02
2.26750E+03	1.15850E-02	6.69150E-01	7.75210E-03	1.49370E-02
2.26760E+03	1.13010E-02	6.69100E-01	7.56160E-03	1.45700E-02
2.26770E+03	1.10320E-02	6.69050E-01	7.38090E-03	1.42210E-02
2.26780E+03	1.07750E-02	6.69000E-01	7.20840E-03	1.38890E-02
2.26790E+03	1.05280E-02	6.68950E-01	7.04250E-03	1.35690E-02
2.26800E+03	1.02880E-02	6.68900E-01	6.88190E-03	1.32600E-02
2.26810E+03	1.00550E-02	6.68840E-01	6.72530E-03	1.29580E-02
2.26820E+03	9.82660E-03	6.68770E-01	6.57180E-03	1.26620E-02
2.26830E+03	9.60130E-03	6.68700E-01	6.42040E-03	1.23710E-02
2.26840E+03	9.37820E-03	6.68640E-01	6.27060E-03	1.20820E-02
2.26850E+03	9.15630E-03	6.68570E-01	6.12160E-03	1.17950E-02
2.26860E+03	8.93480E-03	6.68500E-01	5.97300E-03	1.15090E-02
2.26870E+03	8.71330E-03	6.68440E-01	5.82430E-03	1.12220E-02
2.26880E+03	8.49110E-03	6.68370E-01	5.67520E-03	1.09350E-02
2.26890E+03	8.26770E-03	6.68300E-01	5.52540E-03	1.06460E-02
2.26900E+03	8.04270E-03	6.68240E-01	5.37450E-03	1.03550E-02
2.26910E+03	7.81570E-03	6.68170E-01	5.22220E-03	1.00620E-02
2.26920E+03	7.58620E-03	6.68100E-01	5.06840E-03	9.76570E-03
2.26930E+03	7.35400E-03	6.68040E-01	4.91280E-03	9.46580E-03
2.26940E+03	7.11890E-03	6.67970E-01	4.75520E-03	9.16220E-03
2.26950E+03	6.88060E-03	6.67900E-01	4.59560E-03	8.85470E-03
2.26960E+03	6.63930E-03	6.67840E-01	4.43400E-03	8.54330E-03
2.26970E+03	6.39520E-03	6.67770E-01	4.27050E-03	8.22840E-03
2.26980E+03	6.14880E-03	6.67700E-01	4.10560E-03	7.91060E-03
2.26990E+03	5.90100E-03	6.67710E-01	3.94020E-03	7.59180E-03
2.27000E+03	5.65280E-03	6.67760E-01	3.77470E-03	7.27300E-03
2.27010E+03	5.40570E-03	6.67970E-01	3.61080E-03	6.95720E-03
2.27020E+03	5.16140E-03	6.68180E-01	3.44870E-03	6.64490E-03
2.27030E+03	4.92200E-03	6.68390E-01	3.28980E-03	6.33870E-03
2.27040E+03	4.68980E-03	6.68600E-01	3.13560E-03	6.04160E-03
2.27050E+03	4.46740E-03	6.68770E-01	2.98770E-03	5.75660E-03
2.27060E+03	4.25740E-03	6.68800E-01	2.84740E-03	5.48630E-03
2.27070E+03	4.06260E-03	6.68830E-01	2.71720E-03	5.23550E-03
2.27080E+03	3.88570E-03	6.68860E-01	2.59900E-03	5.00770E-03
2.27090E+03	3.72910E-03	6.68890E-01	2.49440E-03	4.80610E-03
2.27100E+03	3.59520E-03	6.68920E-01	2.40490E-03	4.63370E-03
2.27110E+03	3.48580E-03	6.68950E-01	2.33180E-03	4.49300E-03
2.27120E+03	3.40240E-03	6.68980E-01	2.27610E-03	4.38560E-03
2.27130E+03	3.34580E-03	6.69010E-01	2.23830E-03	4.31280E-03
2.27140E+03	3.31610E-03	6.69030E-01	2.21860E-03	4.27470E-03
2.27150E+03	3.31290E-03	6.69060E-01	2.21660E-03	4.27080E-03
2.27160E+03	3.33510E-03	6.69090E-01	2.23150E-03	4.29950E-03

2.27170E+03	3.38050E-03	6.69120E-01	2.26200E-03	4.35830E-03
2.27180E+03	3.44680E-03	6.69150E-01	2.30640E-03	4.44400E-03
2.27190E+03	3.53080E-03	6.69170E-01	2.36270E-03	4.55240E-03
2.27200E+03	3.62860E-03	6.69200E-01	2.42830E-03	4.67880E-03
2.27210E+03	3.73640E-03	6.69170E-01	2.50030E-03	4.81750E-03
2.27220E+03	3.84980E-03	6.69140E-01	2.57600E-03	4.96340E-03
2.27230E+03	3.96420E-03	6.69110E-01	2.65250E-03	5.11070E-03
2.27240E+03	4.07540E-03	6.69070E-01	2.72680E-03	5.25390E-03
2.27250E+03	4.17920E-03	6.69040E-01	2.79600E-03	5.38730E-03
2.27260E+03	4.27160E-03	6.69010E-01	2.85770E-03	5.50620E-03
2.27270E+03	4.34930E-03	6.68980E-01	2.90960E-03	5.60610E-03
2.27280E+03	4.40950E-03	6.68950E-01	2.94970E-03	5.68340E-03
2.27290E+03	4.44990E-03	6.68910E-01	2.97660E-03	5.73520E-03
2.27300E+03	4.46910E-03	6.68880E-01	2.98930E-03	5.75970E-03
2.27310E+03	4.46640E-03	6.68850E-01	2.98730E-03	5.75590E-03
2.27320E+03	4.44180E-03	6.68820E-01	2.97070E-03	5.72390E-03
2.27330E+03	4.39600E-03	6.68790E-01	2.94000E-03	5.66470E-03
2.27340E+03	4.33040E-03	6.68750E-01	2.89600E-03	5.57990E-03
2.27350E+03	4.24700E-03	6.68720E-01	2.84000E-03	5.47210E-03
2.27360E+03	4.14810E-03	6.68680E-01	2.77380E-03	5.34440E-03
2.27370E+03	4.03650E-03	6.68640E-01	2.69900E-03	5.20040E-03
2.27380E+03	3.91510E-03	6.68600E-01	2.61760E-03	5.04360E-03
2.27390E+03	3.78660E-03	6.68570E-01	2.53160E-03	4.87790E-03
2.27400E+03	3.65400E-03	6.68530E-01	2.44280E-03	4.70680E-03
2.27410E+03	3.51990E-03	6.68510E-01	2.35310E-03	4.53390E-03
2.27420E+03	3.38640E-03	6.68490E-01	2.26380E-03	4.36180E-03
2.27430E+03	3.25550E-03	6.68420E-01	2.17600E-03	4.19280E-03
2.27440E+03	3.12850E-03	6.68350E-01	2.09090E-03	4.02880E-03
2.27450E+03	3.00640E-03	6.68280E-01	2.00910E-03	3.87110E-03
2.27460E+03	2.88940E-03	6.68210E-01	1.93070E-03	3.72010E-03
2.27470E+03	2.77760E-03	6.68140E-01	1.85590E-03	3.57580E-03
2.27480E+03	2.67050E-03	6.68080E-01	1.78410E-03	3.43760E-03
2.27490E+03	2.56720E-03	6.68010E-01	1.71490E-03	3.30420E-03
2.27500E+03	2.46650E-03	6.67940E-01	1.64750E-03	3.17430E-03
2.27510E+03	2.36730E-03	6.67890E-01	1.58110E-03	3.04640E-03
2.27520E+03	2.26810E-03	6.67830E-01	1.51470E-03	2.91850E-03
2.27530E+03	2.16770E-03	6.67780E-01	1.44760E-03	2.78920E-03
2.27540E+03	2.06500E-03	6.67730E-01	1.37890E-03	2.65680E-03
2.27550E+03	1.95910E-03	6.67680E-01	1.30810E-03	2.52030E-03
2.27560E+03	1.84940E-03	6.67630E-01	1.23470E-03	2.37900E-03
2.27570E+03	1.73580E-03	6.67580E-01	1.15880E-03	2.23270E-03
2.27580E+03	1.61850E-03	6.67520E-01	1.08040E-03	2.08170E-03
2.27590E+03	1.50350E-03	6.67470E-01	1.00350E-03	1.93360E-03

2.27600E+03	1.39160E-03	6.67420E-01	9.28820E-04	1.78960E-03
2.27610E+03	1.28080E-03	6.67430E-01	8.54830E-04	1.64710E-03
2.27620E+03	1.16940E-03	6.67440E-01	7.80480E-04	1.50380E-03
2.27630E+03	1.05790E-03	6.67440E-01	7.06070E-04	1.36040E-03
2.27640E+03	9.50650E-04	6.67450E-01	6.34510E-04	1.22260E-03
2.27650E+03	8.51610E-04	6.67550E-01	5.68490E-04	1.09540E-03
2.27660E+03	7.63480E-04	6.67660E-01	5.09750E-04	9.82170E-04
2.27670E+03	6.88570E-04	6.67770E-01	4.59800E-04	8.85940E-04
2.27680E+03	6.28760E-04	6.67880E-01	4.19940E-04	8.09120E-04
2.27690E+03	5.85570E-04	6.67980E-01	3.91150E-04	7.53660E-04
2.27700E+03	5.59980E-04	6.68100E-01	3.74120E-04	7.20850E-04
2.27710E+03	5.52480E-04	6.68240E-01	3.69190E-04	7.11350E-04
2.27720E+03	5.62940E-04	6.68390E-01	3.76260E-04	7.24970E-04
2.27730E+03	5.90650E-04	6.68540E-01	3.94870E-04	7.60830E-04
2.27740E+03	6.34330E-04	6.68690E-01	4.24170E-04	8.17280E-04
2.27750E+03	6.92150E-04	6.68840E-01	4.62930E-04	8.91970E-04
2.27760E+03	7.61760E-04	6.68990E-01	5.09610E-04	9.81900E-04
2.27770E+03	8.40450E-04	6.69130E-01	5.62370E-04	1.08360E-03
2.27780E+03	9.25160E-04	6.69280E-01	6.19190E-04	1.19300E-03
2.27790E+03	1.01260E-03	6.69430E-01	6.77880E-04	1.30610E-03
2.27800E+03	1.09440E-03	6.69580E-01	7.32800E-04	1.41190E-03
2.27810E+03	1.16740E-03	6.69680E-01	7.81790E-04	1.50630E-03
2.27820E+03	1.23220E-03	6.69780E-01	8.25300E-04	1.59020E-03
2.27830E+03	1.28930E-03	6.69880E-01	8.63710E-04	1.66420E-03
2.27840E+03	1.33800E-03	6.69990E-01	8.96470E-04	1.72730E-03
2.27850E+03	1.37420E-03	6.70090E-01	9.20850E-04	1.77430E-03
2.27860E+03	1.39480E-03	6.70190E-01	9.34780E-04	1.80110E-03
2.27870E+03	1.39850E-03	6.70240E-01	9.37300E-04	1.80600E-03
2.27880E+03	1.38480E-03	6.70290E-01	9.28200E-04	1.78840E-03
2.27890E+03	1.35430E-03	6.70340E-01	9.07830E-04	1.74920E-03
2.27900E+03	1.30970E-03	6.70390E-01	8.77990E-04	1.69170E-03
2.27910E+03	1.25760E-03	6.70430E-01	8.43160E-04	1.62460E-03
2.27920E+03	1.20000E-03	6.70480E-01	8.04580E-04	1.55030E-03
2.27930E+03	1.13650E-03	6.70530E-01	7.62060E-04	1.46830E-03
2.27940E+03	1.06670E-03	6.70570E-01	7.15310E-04	1.37820E-03
2.27950E+03	9.90390E-04	6.70620E-01	6.64180E-04	1.27970E-03
2.27960E+03	9.07580E-04	6.70670E-01	6.08680E-04	1.17280E-03
2.27970E+03	8.18850E-04	6.70720E-01	5.49220E-04	1.05820E-03
2.27980E+03	7.28920E-04	6.70760E-01	4.88930E-04	9.42060E-04
2.27990E+03	6.46570E-04	6.70810E-01	4.33730E-04	8.35690E-04
2.28000E+03	5.75640E-04	6.70850E-01	3.86170E-04	7.44060E-04
2.28010E+03	5.18780E-04	6.70850E-01	3.48030E-04	6.70570E-04
2.28020E+03	4.78090E-04	6.70860E-01	3.20730E-04	6.17980E-04

2.28030E+03	4.55090E-04	6.70870E-01	3.05310E-04	5.88260E-04
2.28040E+03	4.50730E-04	6.70870E-01	3.02380E-04	5.82620E-04
2.28050E+03	4.65290E-04	6.70880E-01	3.12160E-04	6.01460E-04
2.28060E+03	4.98460E-04	6.70890E-01	3.34410E-04	6.44340E-04
2.28070E+03	5.49270E-04	6.70890E-01	3.68500E-04	7.10020E-04
2.28080E+03	6.16150E-04	6.70900E-01	4.13370E-04	7.96480E-04
2.28090E+03	6.96930E-04	6.70880E-01	4.67550E-04	9.00870E-04
2.28100E+03	7.88770E-04	6.70860E-01	5.29150E-04	1.01960E-03
2.28110E+03	8.86930E-04	6.70850E-01	5.94990E-04	1.14640E-03
2.28120E+03	9.82970E-04	6.70830E-01	6.59410E-04	1.27050E-03
2.28130E+03	1.07370E-03	6.70820E-01	7.20240E-04	1.38770E-03
2.28140E+03	1.15840E-03	6.70800E-01	7.77040E-04	1.49720E-03
2.28150E+03	1.23690E-03	6.70790E-01	8.29720E-04	1.59870E-03
2.28160E+03	1.30950E-03	6.70770E-01	8.78360E-04	1.69240E-03
2.28170E+03	1.37630E-03	6.70760E-01	9.23170E-04	1.77870E-03
2.28180E+03	1.43760E-03	6.70740E-01	9.64260E-04	1.85790E-03
2.28190E+03	1.48980E-03	6.70730E-01	9.99230E-04	1.92530E-03
2.28200E+03	1.52550E-03	6.70710E-01	1.02320E-03	1.97140E-03
2.28210E+03	1.54270E-03	6.70750E-01	1.03470E-03	1.99370E-03
2.28220E+03	1.54060E-03	6.70790E-01	1.03340E-03	1.99110E-03
2.28230E+03	1.51930E-03	6.70830E-01	1.01920E-03	1.96380E-03
2.28240E+03	1.47990E-03	6.70870E-01	9.92810E-04	1.91290E-03
2.28250E+03	1.42680E-03	6.70910E-01	9.57240E-04	1.84440E-03
2.28260E+03	1.36800E-03	6.70950E-01	9.17840E-04	1.76850E-03
2.28270E+03	1.30470E-03	6.70990E-01	8.75460E-04	1.68680E-03
2.28280E+03	1.23690E-03	6.71040E-01	8.30030E-04	1.59930E-03
2.28290E+03	1.16460E-03	6.71100E-01	7.81550E-04	1.50590E-03
2.28300E+03	9.62720E-04	6.71150E-01	6.46130E-04	1.24500E-03
2.28310E+03	7.44770E-04	6.71240E-01	4.99920E-04	9.63230E-04
2.28320E+03	5.33810E-04	6.71320E-01	3.58360E-04	6.90480E-04
2.28330E+03	3.37710E-04	6.71410E-01	2.26740E-04	4.36880E-04
2.28340E+03	1.69270E-04	6.71490E-01	1.13670E-04	2.19010E-04
2.28350E+03	9.52870E-05	6.71580E-01	6.39930E-05	1.23300E-04
2.28360E+03	1.80910E-04	6.71660E-01	1.21510E-04	2.34130E-04
2.28370E+03	2.78530E-04	6.71750E-01	1.87100E-04	3.60510E-04
2.28380E+03	3.53570E-04	6.71840E-01	2.37540E-04	4.57690E-04
2.28390E+03	4.02010E-04	6.71920E-01	2.70120E-04	5.20460E-04
2.28400E+03	0.00000E+00	6.72010E-01	0.00000E+00	0.00000E+00
Channel 17				
Wavenumber	HIRS Filter Transmittance	Optical Element Transmittance	Product of the HIRS Filter and Optical Element Transmittances	Normalized Value of Column 4

2.38620E+03	0.00000E+00	6.80770E-01	0.00000E+00	0.00000E+00
2.38630E+03	9.87850E-04	6.80750E-01	6.72480E-04	1.31480E-03
2.38640E+03	8.51770E-04	6.80730E-01	5.79830E-04	1.13370E-03
2.38650E+03	7.32630E-04	6.80770E-01	4.98750E-04	9.75170E-04
2.38660E+03	6.33560E-04	6.80810E-01	4.31330E-04	8.43350E-04
2.38670E+03	5.56770E-04	6.80840E-01	3.79070E-04	7.41170E-04
2.38680E+03	5.03100E-04	6.80880E-01	3.42550E-04	6.69760E-04
2.38690E+03	4.71670E-04	6.80910E-01	3.21170E-04	6.27950E-04
2.38700E+03	4.60770E-04	6.80950E-01	3.13760E-04	6.13470E-04
2.38710E+03	4.68970E-04	6.80980E-01	3.19360E-04	6.24410E-04
2.38720E+03	4.95640E-04	6.81010E-01	3.37540E-04	6.59960E-04
2.38730E+03	5.40890E-04	6.81040E-01	3.68370E-04	7.20240E-04
2.38740E+03	6.04510E-04	6.81070E-01	4.11710E-04	8.04990E-04
2.38750E+03	6.85170E-04	6.81100E-01	4.66670E-04	9.12440E-04
2.38760E+03	7.80670E-04	6.81130E-01	5.31740E-04	1.03970E-03
2.38770E+03	8.88230E-04	6.81160E-01	6.05030E-04	1.18300E-03
2.38780E+03	1.00490E-03	6.81190E-01	6.84550E-04	1.33840E-03
2.38790E+03	1.12830E-03	6.81230E-01	7.68630E-04	1.50280E-03
2.38800E+03	1.25670E-03	6.81260E-01	8.56110E-04	1.67390E-03
2.38810E+03	1.38910E-03	6.81250E-01	9.46300E-04	1.85020E-03
2.38820E+03	1.52570E-03	6.81250E-01	1.03930E-03	2.03210E-03
2.38830E+03	2.69010E-03	6.81250E-01	1.83260E-03	3.58310E-03
2.38840E+03	2.89470E-03	6.81240E-01	1.97200E-03	3.85570E-03
2.38850E+03	3.11510E-03	6.81240E-01	2.12210E-03	4.14920E-03
2.38860E+03	3.35020E-03	6.81240E-01	2.28230E-03	4.46230E-03
2.38870E+03	3.59880E-03	6.81220E-01	2.45160E-03	4.79340E-03
2.38880E+03	3.85970E-03	6.81210E-01	2.62920E-03	5.14070E-03
2.38890E+03	4.13130E-03	6.81190E-01	2.81420E-03	5.50240E-03
2.38900E+03	4.41230E-03	6.81180E-01	3.00550E-03	5.87650E-03
2.38910E+03	4.70120E-03	6.81160E-01	3.20230E-03	6.26110E-03
2.38920E+03	4.99680E-03	6.81140E-01	3.40350E-03	6.65460E-03
2.38930E+03	5.29770E-03	6.81120E-01	3.60840E-03	7.05510E-03
2.38940E+03	5.60280E-03	6.81110E-01	3.81610E-03	7.46120E-03
2.38950E+03	5.91100E-03	6.81090E-01	4.02590E-03	7.87150E-03
2.38960E+03	6.22150E-03	6.81070E-01	4.23730E-03	8.28480E-03
2.38970E+03	6.53360E-03	6.81050E-01	4.44970E-03	8.70020E-03
2.38980E+03	6.84690E-03	6.81040E-01	4.66300E-03	9.11710E-03
2.38990E+03	7.16120E-03	6.81020E-01	4.87690E-03	9.53540E-03
2.39000E+03	7.47660E-03	6.81000E-01	5.09160E-03	9.95510E-03
2.39010E+03	7.79340E-03	6.80920E-01	5.30660E-03	1.03760E-02
2.39020E+03	8.11190E-03	6.80830E-01	5.52290E-03	1.07980E-02
2.39030E+03	8.43280E-03	6.80750E-01	5.74070E-03	1.12240E-02
2.39040E+03	8.75680E-03	6.80670E-01	5.96050E-03	1.16540E-02

2.39050E+03	9.08450E-03	6.80580E-01	6.18270E-03	1.20890E-02
2.39060E+03	1.03710E-02	6.80500E-01	7.05770E-03	1.37990E-02
2.39070E+03	1.08280E-02	6.80420E-01	7.36720E-03	1.44040E-02
2.39080E+03	1.12510E-02	6.80330E-01	7.65460E-03	1.49660E-02
2.39090E+03	1.16400E-02	6.80200E-01	7.91750E-03	1.54800E-02
2.39100E+03	1.19920E-02	6.80060E-01	8.15540E-03	1.59450E-02
2.39110E+03	1.23070E-02	6.79920E-01	8.36790E-03	1.63610E-02
2.39120E+03	1.25870E-02	6.79780E-01	8.55620E-03	1.67290E-02
2.39130E+03	1.28330E-02	6.79650E-01	8.72190E-03	1.70530E-02
2.39140E+03	1.30500E-02	6.79510E-01	8.86740E-03	1.73380E-02
2.39150E+03	1.32420E-02	6.79370E-01	8.99620E-03	1.75890E-02
2.39160E+03	1.34160E-02	6.79230E-01	9.11230E-03	1.78160E-02
2.39170E+03	1.35770E-02	6.79090E-01	9.21990E-03	1.80270E-02
2.39180E+03	1.37330E-02	6.78950E-01	9.32410E-03	1.82310E-02
2.39190E+03	1.38920E-02	6.78810E-01	9.42980E-03	1.84370E-02
2.39200E+03	1.40590E-02	6.78670E-01	9.54180E-03	1.86560E-02
2.39210E+03	1.42430E-02	6.78640E-01	9.66620E-03	1.88990E-02
2.39220E+03	1.44500E-02	6.78610E-01	9.80580E-03	1.91720E-02
2.39230E+03	1.46840E-02	6.78580E-01	9.96420E-03	1.94820E-02
2.39240E+03	1.49500E-02	6.78560E-01	1.01440E-02	1.98340E-02
2.39250E+03	1.52510E-02	6.78530E-01	1.03480E-02	2.02330E-02
2.39260E+03	1.55890E-02	6.78500E-01	1.05770E-02	2.06810E-02
2.39270E+03	1.59660E-02	6.78470E-01	1.08320E-02	2.11790E-02
2.39280E+03	1.63790E-02	6.78440E-01	1.11120E-02	2.17270E-02
2.39290E+03	1.68290E-02	6.78410E-01	1.14170E-02	2.23220E-02
2.39300E+03	1.73120E-02	6.78380E-01	1.17440E-02	2.29620E-02
2.39310E+03	1.78260E-02	6.78360E-01	1.20930E-02	2.36440E-02
2.39320E+03	1.83680E-02	6.78350E-01	1.24600E-02	2.43620E-02
2.39330E+03	1.89340E-02	6.78340E-01	1.28430E-02	2.51110E-02
2.39340E+03	1.95200E-02	6.78320E-01	1.32410E-02	2.58890E-02
2.39350E+03	2.01240E-02	6.78310E-01	1.36500E-02	2.66890E-02
2.39360E+03	2.07430E-02	6.78300E-01	1.40700E-02	2.75100E-02
2.39370E+03	2.13760E-02	6.78290E-01	1.44990E-02	2.83480E-02
2.39380E+03	2.20220E-02	6.78270E-01	1.49370E-02	2.92040E-02
2.39390E+03	2.26810E-02	6.78260E-01	1.53840E-02	3.00780E-02
2.39400E+03	2.33550E-02	6.78250E-01	1.58410E-02	3.09720E-02
2.39410E+03	2.40470E-02	6.78220E-01	1.63090E-02	3.18870E-02
2.39420E+03	2.47590E-02	6.78190E-01	1.67910E-02	3.28300E-02
2.39430E+03	2.54960E-02	6.78160E-01	1.72900E-02	3.38060E-02
2.39440E+03	2.62610E-02	6.78130E-01	1.78090E-02	3.48200E-02
2.39450E+03	2.70600E-02	6.78100E-01	1.83500E-02	3.58770E-02
2.39460E+03	2.78970E-02	6.78070E-01	1.89160E-02	3.69850E-02
2.39470E+03	2.87740E-02	6.78040E-01	1.95100E-02	3.81460E-02

2.39480E+03	2.96950E-02	6.78020E-01	2.01340E-02	3.93660E-02
2.39490E+03	3.06630E-02	6.78000E-01	2.07890E-02	4.06470E-02
2.39500E+03	3.16770E-02	6.77980E-01	2.14760E-02	4.19900E-02
2.39510E+03	3.27360E-02	6.77950E-01	2.21930E-02	4.33930E-02
2.39520E+03	3.38400E-02	6.77910E-01	2.29410E-02	4.48540E-02
2.39530E+03	3.49850E-02	6.77930E-01	2.37180E-02	4.63730E-02
2.39540E+03	3.61670E-02	6.77960E-01	2.45200E-02	4.79410E-02
2.39550E+03	3.73790E-02	6.77980E-01	2.53430E-02	4.95500E-02
2.39560E+03	3.86180E-02	6.78010E-01	2.61830E-02	5.11940E-02
2.39570E+03	3.98750E-02	6.78040E-01	2.70370E-02	5.28630E-02
2.39580E+03	4.11460E-02	6.78060E-01	2.78990E-02	5.45490E-02
2.39590E+03	4.24240E-02	6.78090E-01	2.87670E-02	5.62450E-02
2.39600E+03	4.37040E-02	6.78110E-01	2.96360E-02	5.79440E-02
2.39610E+03	4.49820E-02	6.78070E-01	3.05010E-02	5.96360E-02
2.39620E+03	4.62570E-02	6.78030E-01	3.13630E-02	6.13220E-02
2.39630E+03	4.75270E-02	6.77980E-01	3.22220E-02	6.30010E-02
2.39640E+03	4.87930E-02	6.77930E-01	3.30790E-02	6.46760E-02
2.39650E+03	5.00580E-02	6.77890E-01	3.39340E-02	6.63480E-02
2.39660E+03	5.13270E-02	6.77840E-01	3.47910E-02	6.80240E-02
2.39670E+03	5.26040E-02	6.77790E-01	3.56540E-02	6.97120E-02
2.39680E+03	5.38960E-02	6.77750E-01	3.65280E-02	7.14200E-02
2.39690E+03	5.52110E-02	6.77700E-01	3.74170E-02	7.31580E-02
2.39700E+03	5.65580E-02	6.77650E-01	3.83270E-02	7.49370E-02
2.39710E+03	5.79440E-02	6.77610E-01	3.92640E-02	7.67680E-02
2.39720E+03	5.93770E-02	6.77570E-01	4.02320E-02	7.86610E-02
2.39730E+03	6.08630E-02	6.77520E-01	4.12360E-02	8.06260E-02
2.39740E+03	6.24090E-02	6.77480E-01	4.22810E-02	8.26680E-02
2.39750E+03	6.40190E-02	6.77420E-01	4.33680E-02	8.47930E-02
2.39760E+03	6.56960E-02	6.77360E-01	4.45000E-02	8.70070E-02
2.39770E+03	6.74410E-02	6.77300E-01	4.56780E-02	8.93100E-02
2.39780E+03	6.92540E-02	6.77250E-01	4.69020E-02	9.17030E-02
2.39790E+03	7.11340E-02	6.77190E-01	4.81710E-02	9.41840E-02
2.39800E+03	7.30780E-02	6.77130E-01	4.94830E-02	9.67500E-02
2.39810E+03	7.50830E-02	6.77120E-01	5.08400E-02	9.94020E-02
2.39820E+03	7.71450E-02	6.77110E-01	5.22360E-02	1.02130E-01
2.39830E+03	7.92610E-02	6.77110E-01	5.36680E-02	1.04930E-01
2.39840E+03	8.14290E-02	6.77100E-01	5.51350E-02	1.07800E-01
2.39850E+03	8.36450E-02	6.77100E-01	5.66360E-02	1.10730E-01
2.39860E+03	8.59090E-02	6.77090E-01	5.81680E-02	1.13730E-01
2.39870E+03	8.82230E-02	6.77090E-01	5.97340E-02	1.16790E-01
2.39880E+03	9.05870E-02	6.77080E-01	6.13350E-02	1.19920E-01
2.39890E+03	9.30080E-02	6.77080E-01	6.29730E-02	1.23130E-01
2.39900E+03	9.54890E-02	6.77070E-01	6.46530E-02	1.26410E-01

2.39910E+03	9.80390E-02	6.77070E-01	6.63800E-02	1.29790E-01
2.39920E+03	1.00670E-01	6.77070E-01	6.81580E-02	1.33260E-01
2.39930E+03	1.03380E-01	6.77070E-01	6.99950E-02	1.36850E-01
2.39940E+03	1.06190E-01	6.77070E-01	7.18950E-02	1.40570E-01
2.39950E+03	1.09100E-01	6.77070E-01	7.38660E-02	1.44420E-01
2.39960E+03	1.12120E-01	6.77060E-01	7.59110E-02	1.48420E-01
2.39970E+03	1.15260E-01	6.77020E-01	7.80330E-02	1.52570E-01
2.39980E+03	1.18520E-01	6.76980E-01	8.02380E-02	1.56880E-01
2.39990E+03	1.21910E-01	6.76940E-01	8.25280E-02	1.61360E-01
2.40000E+03	1.25430E-01	6.76920E-01	8.49050E-02	1.66010E-01
2.40010E+03	1.29070E-01	6.76940E-01	8.73720E-02	1.70830E-01
2.40020E+03	1.32830E-01	6.76960E-01	8.99200E-02	1.75810E-01
2.40030E+03	1.36700E-01	6.76990E-01	9.25450E-02	1.80950E-01
2.40040E+03	1.40680E-01	6.77010E-01	9.52410E-02	1.86220E-01
2.40050E+03	1.44750E-01	6.77030E-01	9.80000E-02	1.91610E-01
2.40060E+03	1.48900E-01	6.77060E-01	1.00820E-01	1.97120E-01
2.40070E+03	1.53130E-01	6.77080E-01	1.03680E-01	2.02720E-01
2.40080E+03	1.57420E-01	6.77100E-01	1.06590E-01	2.08400E-01
2.40090E+03	1.61750E-01	6.77120E-01	1.09530E-01	2.14150E-01
2.40100E+03	1.66130E-01	6.77150E-01	1.12500E-01	2.19960E-01
2.40110E+03	1.70550E-01	6.77170E-01	1.15490E-01	2.25810E-01
2.40120E+03	1.74990E-01	6.77200E-01	1.18500E-01	2.31700E-01
2.40130E+03	1.79460E-01	6.77220E-01	1.21540E-01	2.37630E-01
2.40140E+03	1.83970E-01	6.77250E-01	1.24590E-01	2.43600E-01
2.40150E+03	1.88500E-01	6.77270E-01	1.27670E-01	2.49610E-01
2.40160E+03	1.93070E-01	6.77290E-01	1.30770E-01	2.55680E-01
2.40170E+03	1.97690E-01	6.77320E-01	1.33900E-01	2.61800E-01
2.40180E+03	2.02360E-01	6.77340E-01	1.37070E-01	2.68000E-01
2.40190E+03	2.07100E-01	6.77310E-01	1.40270E-01	2.74260E-01
2.40200E+03	2.11920E-01	6.77280E-01	1.43530E-01	2.80630E-01
2.40210E+03	2.16820E-01	6.77230E-01	1.46840E-01	2.87100E-01
2.40220E+03	2.21820E-01	6.77180E-01	1.50210E-01	2.93700E-01
2.40230E+03	2.26920E-01	6.77120E-01	1.53660E-01	3.00430E-01
2.40240E+03	2.32140E-01	6.77070E-01	1.57170E-01	3.07310E-01
2.40250E+03	2.37470E-01	6.77020E-01	1.60770E-01	3.14340E-01
2.40260E+03	2.42920E-01	6.76970E-01	1.64450E-01	3.21530E-01
2.40270E+03	2.48480E-01	6.76920E-01	1.68200E-01	3.28870E-01
2.40280E+03	2.54150E-01	6.76870E-01	1.72030E-01	3.36350E-01
2.40290E+03	2.59930E-01	6.76820E-01	1.75930E-01	3.43970E-01
2.40300E+03	2.65810E-01	6.76770E-01	1.79890E-01	3.51720E-01
2.40310E+03	2.71770E-01	6.76710E-01	1.83910E-01	3.59590E-01
2.40320E+03	2.77810E-01	6.76650E-01	1.87980E-01	3.67550E-01
2.40330E+03	2.83920E-01	6.76590E-01	1.92100E-01	3.75590E-01

2.40340E+03	2.90070E-01	6.76540E-01	1.96240E-01	3.83700E-01
2.40350E+03	2.96270E-01	6.76480E-01	2.00420E-01	3.91860E-01
2.40360E+03	3.02500E-01	6.76420E-01	2.04610E-01	4.00060E-01
2.40370E+03	3.08740E-01	6.76360E-01	2.08820E-01	4.08290E-01
2.40380E+03	3.15000E-01	6.76300E-01	2.13040E-01	4.16530E-01
2.40390E+03	3.21260E-01	6.76250E-01	2.17250E-01	4.24780E-01
2.40400E+03	3.27530E-01	6.76190E-01	2.21470E-01	4.33020E-01
2.40410E+03	3.33790E-01	6.76200E-01	2.25710E-01	4.41310E-01
2.40420E+03	3.40050E-01	6.76200E-01	2.29940E-01	4.49590E-01
2.40430E+03	3.46310E-01	6.76190E-01	2.34180E-01	4.57860E-01
2.40440E+03	3.52570E-01	6.76190E-01	2.38410E-01	4.66140E-01
2.40450E+03	3.58830E-01	6.76190E-01	2.42640E-01	4.74410E-01
2.40460E+03	3.65100E-01	6.76180E-01	2.46870E-01	4.82690E-01
2.40470E+03	3.71370E-01	6.76180E-01	2.51110E-01	4.90980E-01
2.40480E+03	3.77650E-01	6.76170E-01	2.55350E-01	4.99270E-01
2.40490E+03	3.83930E-01	6.76170E-01	2.59600E-01	5.07570E-01
2.40500E+03	3.90220E-01	6.76160E-01	2.63850E-01	5.15890E-01
2.40510E+03	3.96520E-01	6.76190E-01	2.68120E-01	5.24230E-01
2.40520E+03	4.02820E-01	6.76210E-01	2.72390E-01	5.32580E-01
2.40530E+03	4.09110E-01	6.76230E-01	2.76660E-01	5.40920E-01
2.40540E+03	4.15400E-01	6.76250E-01	2.80920E-01	5.49250E-01
2.40550E+03	4.21670E-01	6.76280E-01	2.85170E-01	5.57560E-01
2.40560E+03	4.27920E-01	6.76300E-01	2.89400E-01	5.65850E-01
2.40570E+03	4.34150E-01	6.76320E-01	2.93620E-01	5.74090E-01
2.40580E+03	4.40330E-01	6.76340E-01	2.97810E-01	5.82290E-01
2.40590E+03	4.46470E-01	6.76370E-01	3.01980E-01	5.90420E-01
2.40600E+03	4.52560E-01	6.76400E-01	3.06110E-01	5.98500E-01
2.40610E+03	4.58590E-01	6.76480E-01	3.10230E-01	6.06550E-01
2.40620E+03	4.64560E-01	6.76560E-01	3.14300E-01	6.14530E-01
2.40630E+03	4.70470E-01	6.76680E-01	3.18350E-01	6.22450E-01
2.40640E+03	4.76310E-01	6.76790E-01	3.22360E-01	6.30280E-01
2.40650E+03	4.82080E-01	6.76900E-01	3.26320E-01	6.38030E-01
2.40660E+03	4.87790E-01	6.77010E-01	3.30240E-01	6.45690E-01
2.40670E+03	4.93440E-01	6.77120E-01	3.34120E-01	6.53280E-01
2.40680E+03	4.99030E-01	6.77240E-01	3.37960E-01	6.60780E-01
2.40690E+03	5.04560E-01	6.77350E-01	3.41760E-01	6.68210E-01
2.40700E+03	5.10030E-01	6.77460E-01	3.45530E-01	6.75580E-01
2.40710E+03	5.15450E-01	6.77580E-01	3.49260E-01	6.82880E-01
2.40720E+03	5.20820E-01	6.77700E-01	3.52960E-01	6.90110E-01
2.40730E+03	5.26140E-01	6.77820E-01	3.56630E-01	6.97280E-01
2.40740E+03	5.31410E-01	6.77940E-01	3.60260E-01	7.04390E-01
2.40750E+03	5.36630E-01	6.78050E-01	3.63860E-01	7.11420E-01
2.40760E+03	5.41780E-01	6.78170E-01	3.67420E-01	7.18390E-01

2.40770E+03	5.46880E-01	6.78290E-01	3.70940E-01	7.25270E-01
2.40780E+03	5.51910E-01	6.78410E-01	3.74420E-01	7.32070E-01
2.40790E+03	5.56860E-01	6.78530E-01	3.77850E-01	7.38770E-01
2.40800E+03	5.61730E-01	6.78650E-01	3.81220E-01	7.45360E-01
2.40810E+03	5.66510E-01	6.78780E-01	3.84530E-01	7.51840E-01
2.40820E+03	5.71180E-01	6.78900E-01	3.87780E-01	7.58180E-01
2.40830E+03	5.75750E-01	6.79030E-01	3.90950E-01	7.64380E-01
2.40840E+03	5.80190E-01	6.79150E-01	3.94040E-01	7.70430E-01
2.40850E+03	5.84510E-01	6.79030E-01	3.96900E-01	7.76020E-01
2.40860E+03	5.88700E-01	6.78900E-01	3.99670E-01	7.81440E-01
2.40870E+03	5.92750E-01	6.78780E-01	4.02350E-01	7.86670E-01
2.40880E+03	5.96670E-01	6.78650E-01	4.04930E-01	7.91720E-01
2.40890E+03	6.00440E-01	6.78530E-01	4.07420E-01	7.96590E-01
2.40900E+03	6.04090E-01	6.78410E-01	4.09820E-01	8.01280E-01
2.40910E+03	6.07600E-01	6.78280E-01	4.12120E-01	8.05780E-01
2.40920E+03	6.10980E-01	6.78150E-01	4.14340E-01	8.10120E-01
2.40930E+03	6.14250E-01	6.78030E-01	4.16480E-01	8.14310E-01
2.40940E+03	6.17420E-01	6.77900E-01	4.18550E-01	8.18350E-01
2.40950E+03	6.20480E-01	6.77770E-01	4.20540E-01	8.22250E-01
2.40960E+03	6.23460E-01	6.77650E-01	4.22480E-01	8.26040E-01
2.40970E+03	6.26360E-01	6.77520E-01	4.24370E-01	8.29730E-01
2.40980E+03	6.29190E-01	6.77400E-01	4.26210E-01	8.33330E-01
2.40990E+03	6.31970E-01	6.77270E-01	4.28020E-01	8.36860E-01
2.41000E+03	6.34710E-01	6.77140E-01	4.29780E-01	8.40320E-01
2.41010E+03	6.37400E-01	6.76970E-01	4.31500E-01	8.43680E-01
2.41020E+03	6.40050E-01	6.76810E-01	4.33190E-01	8.46980E-01
2.41030E+03	6.42670E-01	6.76650E-01	4.34860E-01	8.50250E-01
2.41040E+03	6.45260E-01	6.76480E-01	4.36510E-01	8.53470E-01
2.41050E+03	6.47820E-01	6.76320E-01	4.38130E-01	8.56640E-01
2.41060E+03	6.50340E-01	6.76150E-01	4.39730E-01	8.59760E-01
2.41070E+03	6.52820E-01	6.76000E-01	4.41310E-01	8.62850E-01
2.41080E+03	6.55250E-01	6.75850E-01	4.42850E-01	8.65870E-01
2.41090E+03	6.57630E-01	6.75700E-01	4.44360E-01	8.68820E-01
2.41100E+03	6.59950E-01	6.75550E-01	4.45830E-01	8.71690E-01
2.41110E+03	6.62210E-01	6.75400E-01	4.47250E-01	8.74470E-01
2.41120E+03	6.64390E-01	6.75240E-01	4.48620E-01	8.77150E-01
2.41130E+03	6.66490E-01	6.75090E-01	4.49940E-01	8.79730E-01
2.41140E+03	6.68520E-01	6.74930E-01	4.51200E-01	8.82200E-01
2.41150E+03	6.70460E-01	6.74780E-01	4.52410E-01	8.84560E-01
2.41160E+03	6.72320E-01	6.74620E-01	4.53560E-01	8.86800E-01
2.41170E+03	6.74090E-01	6.74470E-01	4.54650E-01	8.88950E-01
2.41180E+03	6.75790E-01	6.74310E-01	4.55700E-01	8.90980E-01
2.41190E+03	6.77430E-01	6.74160E-01	4.56690E-01	8.92930E-01

2.41200E+03	6.79000E-01	6.74010E-01	4.57650E-01	8.94800E-01
2.41210E+03	6.80510E-01	6.73830E-01	4.58550E-01	8.96560E-01
2.41220E+03	6.81990E-01	6.73650E-01	4.59430E-01	8.98270E-01
2.41230E+03	6.83440E-01	6.73470E-01	4.60280E-01	8.99940E-01
2.41240E+03	6.84870E-01	6.73300E-01	4.61120E-01	9.01580E-01
2.41250E+03	6.86290E-01	6.73120E-01	4.61950E-01	9.03210E-01
2.41260E+03	6.87710E-01	6.72940E-01	4.62780E-01	9.04840E-01
2.41270E+03	6.89130E-01	6.72760E-01	4.63620E-01	9.06480E-01
2.41280E+03	6.90580E-01	6.72580E-01	4.64470E-01	9.08140E-01
2.41290E+03	6.92040E-01	6.72450E-01	4.65360E-01	9.09880E-01
2.41300E+03	6.93520E-01	6.72320E-01	4.66260E-01	9.11640E-01
2.41310E+03	6.95020E-01	6.72180E-01	4.67180E-01	9.13440E-01
2.41320E+03	6.96530E-01	6.72050E-01	4.68110E-01	9.15250E-01
2.41330E+03	6.98060E-01	6.71920E-01	4.69040E-01	9.17080E-01
2.41340E+03	6.99590E-01	6.71790E-01	4.69980E-01	9.18910E-01
2.41350E+03	7.01120E-01	6.71660E-01	4.70910E-01	9.20730E-01
2.41360E+03	7.02640E-01	6.71520E-01	4.71840E-01	9.22540E-01
2.41370E+03	7.04130E-01	6.71390E-01	4.72750E-01	9.24330E-01
2.41380E+03	7.05600E-01	6.71260E-01	4.73640E-01	9.26070E-01
2.41390E+03	7.07030E-01	6.71140E-01	4.74520E-01	9.27790E-01
2.41400E+03	7.08420E-01	6.71040E-01	4.75380E-01	9.29470E-01
2.41410E+03	7.09770E-01	6.70910E-01	4.76200E-01	9.31060E-01
2.41420E+03	7.11080E-01	6.70790E-01	4.76980E-01	9.32600E-01
2.41430E+03	7.12330E-01	6.70670E-01	4.77740E-01	9.34080E-01
2.41440E+03	7.13550E-01	6.70540E-01	4.78460E-01	9.35500E-01
2.41450E+03	7.14730E-01	6.70420E-01	4.79170E-01	9.36870E-01
2.41460E+03	7.15890E-01	6.70290E-01	4.79850E-01	9.38210E-01
2.41470E+03	7.17020E-01	6.70170E-01	4.80520E-01	9.39530E-01
2.41480E+03	7.18150E-01	6.70040E-01	4.81190E-01	9.40830E-01
2.41490E+03	7.19280E-01	6.69920E-01	4.81860E-01	9.42130E-01
2.41500E+03	7.20420E-01	6.69800E-01	4.82530E-01	9.43450E-01
2.41510E+03	7.21580E-01	6.69760E-01	4.83290E-01	9.44920E-01
2.41520E+03	7.22770E-01	6.69720E-01	4.84060E-01	9.46430E-01
2.41530E+03	7.24000E-01	6.69690E-01	4.84850E-01	9.47990E-01
2.41540E+03	7.25270E-01	6.69650E-01	4.85680E-01	9.49600E-01
2.41550E+03	7.26580E-01	6.69610E-01	4.86520E-01	9.51260E-01
2.41560E+03	7.27920E-01	6.69580E-01	4.87400E-01	9.52970E-01
2.41570E+03	7.29310E-01	6.69540E-01	4.88300E-01	9.54730E-01
2.41580E+03	7.30720E-01	6.69500E-01	4.89220E-01	9.56530E-01
2.41590E+03	7.32160E-01	6.69470E-01	4.90150E-01	9.58350E-01
2.41600E+03	7.33600E-01	6.69460E-01	4.91120E-01	9.60230E-01
2.41610E+03	7.35050E-01	6.69570E-01	4.92170E-01	9.62290E-01
2.41620E+03	7.36490E-01	6.69680E-01	4.93210E-01	9.64330E-01

2.41630E+03	7.37900E-01	6.69790E-01	4.94240E-01	9.66340E-01
2.41640E+03	7.39290E-01	6.69900E-01	4.95240E-01	9.68310E-01
2.41650E+03	7.40630E-01	6.70000E-01	4.96230E-01	9.70230E-01
2.41660E+03	7.41930E-01	6.70110E-01	4.97180E-01	9.72080E-01
2.41670E+03	7.43170E-01	6.70220E-01	4.98090E-01	9.73870E-01
2.41680E+03	7.44360E-01	6.70330E-01	4.98970E-01	9.75590E-01
2.41690E+03	7.45490E-01	6.70440E-01	4.99810E-01	9.77230E-01
2.41700E+03	7.46570E-01	6.70550E-01	5.00610E-01	9.78800E-01
2.41710E+03	7.47600E-01	6.70650E-01	5.01380E-01	9.80290E-01
2.41720E+03	7.48570E-01	6.70750E-01	5.02110E-01	9.81720E-01
2.41730E+03	7.49510E-01	6.70870E-01	5.02820E-01	9.83120E-01
2.41740E+03	7.50410E-01	6.70980E-01	5.03510E-01	9.84460E-01
2.41750E+03	7.51270E-01	6.71100E-01	5.04180E-01	9.85770E-01
2.41760E+03	7.52110E-01	6.71210E-01	5.04830E-01	9.87040E-01
2.41770E+03	7.52930E-01	6.71330E-01	5.05460E-01	9.88280E-01
2.41780E+03	7.53720E-01	6.71440E-01	5.06080E-01	9.89490E-01
2.41790E+03	7.54490E-01	6.71560E-01	5.06680E-01	9.90670E-01
2.41800E+03	7.55240E-01	6.71670E-01	5.07270E-01	9.91820E-01
2.41810E+03	7.55960E-01	6.71750E-01	5.07820E-01	9.92890E-01
2.41820E+03	7.56650E-01	6.71820E-01	5.08330E-01	9.93890E-01
2.41830E+03	7.57290E-01	6.71880E-01	5.08810E-01	9.94830E-01
2.41840E+03	7.57890E-01	6.71950E-01	5.09270E-01	9.95720E-01
2.41850E+03	7.58440E-01	6.72020E-01	5.09690E-01	9.96540E-01
2.41860E+03	7.58930E-01	6.72080E-01	5.10070E-01	9.97290E-01
2.41870E+03	7.59360E-01	6.72150E-01	5.10400E-01	9.97940E-01
2.41880E+03	7.59710E-01	6.72220E-01	5.10690E-01	9.98510E-01
2.41890E+03	7.59990E-01	6.72280E-01	5.10930E-01	9.98970E-01
2.41900E+03	7.60200E-01	6.72350E-01	5.11120E-01	9.99350E-01
2.41910E+03	7.60350E-01	6.72410E-01	5.11260E-01	9.99630E-01
2.41920E+03	7.60420E-01	6.72470E-01	5.11360E-01	9.99820E-01
2.41930E+03	7.60450E-01	6.72530E-01	5.11420E-01	9.99940E-01
2.41940E+03	7.60420E-01	6.72590E-01	5.11450E-01	1.00000E+00
2.41950E+03	7.60360E-01	6.72600E-01	5.11420E-01	9.99930E-01
2.41960E+03	7.60280E-01	6.72600E-01	5.11360E-01	9.99820E-01
2.41970E+03	7.60180E-01	6.72610E-01	5.11300E-01	9.99700E-01
2.41980E+03	7.60080E-01	6.72610E-01	5.11230E-01	9.99570E-01
2.41990E+03	7.59980E-01	6.72610E-01	5.11170E-01	9.99450E-01
2.42000E+03	7.59900E-01	6.72620E-01	5.11130E-01	9.99360E-01
2.42010E+03	7.59850E-01	6.72530E-01	5.11020E-01	9.99150E-01
2.42020E+03	7.59810E-01	6.72420E-01	5.10910E-01	9.98930E-01
2.42030E+03	7.59790E-01	6.72310E-01	5.10810E-01	9.98740E-01
2.42040E+03	7.59780E-01	6.72200E-01	5.10720E-01	9.98570E-01
2.42050E+03	7.59780E-01	6.72090E-01	5.10640E-01	9.98410E-01

2.42060E+03	7.59780E-01	6.71980E-01	5.10550E-01	9.98240E-01
2.42070E+03	7.59750E-01	6.71870E-01	5.10450E-01	9.98040E-01
2.42080E+03	7.59690E-01	6.71750E-01	5.10330E-01	9.97790E-01
2.42090E+03	7.59580E-01	6.71640E-01	5.10170E-01	9.97480E-01
2.42100E+03	7.59400E-01	6.71530E-01	5.09960E-01	9.97080E-01
2.42110E+03	7.59130E-01	6.71420E-01	5.09700E-01	9.96570E-01
2.42120E+03	7.58770E-01	6.71310E-01	5.09370E-01	9.95930E-01
2.42130E+03	7.58300E-01	6.71200E-01	5.08970E-01	9.95140E-01
2.42140E+03	7.57710E-01	6.71090E-01	5.08490E-01	9.94200E-01
2.42150E+03	7.57000E-01	6.70980E-01	5.07930E-01	9.93100E-01
2.42160E+03	7.56160E-01	6.70870E-01	5.07280E-01	9.91840E-01
2.42170E+03	7.55200E-01	6.70770E-01	5.06560E-01	9.90440E-01
2.42180E+03	7.54120E-01	6.70670E-01	5.05770E-01	9.88880E-01
2.42190E+03	7.52940E-01	6.70570E-01	5.04900E-01	9.87180E-01
2.42200E+03	7.51660E-01	6.70470E-01	5.03960E-01	9.85350E-01
2.42210E+03	7.50290E-01	6.70420E-01	5.03010E-01	9.83480E-01
2.42220E+03	7.48850E-01	6.70370E-01	5.02000E-01	9.81520E-01
2.42230E+03	7.47360E-01	6.70320E-01	5.00960E-01	9.79490E-01
2.42240E+03	7.45820E-01	6.70270E-01	4.99900E-01	9.77400E-01
2.42250E+03	7.44240E-01	6.70220E-01	4.98800E-01	9.75270E-01
2.42260E+03	7.42650E-01	6.70170E-01	4.97700E-01	9.73110E-01
2.42270E+03	7.41040E-01	6.70120E-01	4.96580E-01	9.70920E-01
2.42280E+03	7.39420E-01	6.70070E-01	4.95460E-01	9.68730E-01
2.42290E+03	7.37790E-01	6.70030E-01	4.94340E-01	9.66530E-01
2.42300E+03	7.36150E-01	6.69970E-01	4.93200E-01	9.64300E-01
2.42310E+03	7.34490E-01	6.69920E-01	4.92050E-01	9.62050E-01
2.42320E+03	7.32810E-01	6.69870E-01	4.90880E-01	9.59770E-01
2.42330E+03	7.31090E-01	6.69810E-01	4.89700E-01	9.57460E-01
2.42340E+03	7.29350E-01	6.69760E-01	4.88490E-01	9.55090E-01
2.42350E+03	7.27550E-01	6.69710E-01	4.87240E-01	9.52660E-01
2.42360E+03	7.25700E-01	6.69650E-01	4.85960E-01	9.50160E-01
2.42370E+03	7.23780E-01	6.69600E-01	4.84640E-01	9.47570E-01
2.42380E+03	7.21790E-01	6.69550E-01	4.83270E-01	9.44900E-01
2.42390E+03	7.19730E-01	6.69410E-01	4.81790E-01	9.42000E-01
2.42400E+03	7.17590E-01	6.69270E-01	4.80260E-01	9.39010E-01
2.42410E+03	7.15370E-01	6.69210E-01	4.78730E-01	9.36020E-01
2.42420E+03	7.13070E-01	6.69160E-01	4.77160E-01	9.32940E-01
2.42430E+03	7.10710E-01	6.69100E-01	4.75530E-01	9.29770E-01
2.42440E+03	7.08280E-01	6.69050E-01	4.73870E-01	9.26510E-01
2.42450E+03	7.05780E-01	6.68990E-01	4.72160E-01	9.23170E-01
2.42460E+03	7.03230E-01	6.68930E-01	4.70420E-01	9.19760E-01
2.42470E+03	7.00640E-01	6.68880E-01	4.68640E-01	9.16290E-01
2.42480E+03	6.98000E-01	6.68820E-01	4.66840E-01	9.12760E-01

2.42490E+03	6.95320E-01	6.68770E-01	4.65010E-01	9.09190E-01
2.42500E+03	6.92610E-01	6.68710E-01	4.63160E-01	9.05570E-01
2.42510E+03	6.89870E-01	6.68670E-01	4.61290E-01	9.01920E-01
2.42520E+03	6.87090E-01	6.68620E-01	4.59400E-01	8.98220E-01
2.42530E+03	6.84280E-01	6.68570E-01	4.57490E-01	8.94490E-01
2.42540E+03	6.81430E-01	6.68520E-01	4.55550E-01	8.90700E-01
2.42550E+03	6.78550E-01	6.68470E-01	4.53590E-01	8.86870E-01
2.42560E+03	6.75610E-01	6.68430E-01	4.51600E-01	8.82970E-01
2.42570E+03	6.72630E-01	6.68380E-01	4.49570E-01	8.79000E-01
2.42580E+03	6.69580E-01	6.68330E-01	4.47500E-01	8.74960E-01
2.42590E+03	6.66480E-01	6.68280E-01	4.45400E-01	8.70840E-01
2.42600E+03	6.63310E-01	6.68230E-01	4.43250E-01	8.66640E-01
2.42610E+03	6.60080E-01	6.68240E-01	4.41090E-01	8.62430E-01
2.42620E+03	6.56780E-01	6.68250E-01	4.38890E-01	8.58130E-01
2.42630E+03	6.53420E-01	6.68260E-01	4.36650E-01	8.53740E-01
2.42640E+03	6.49990E-01	6.68260E-01	4.34360E-01	8.49270E-01
2.42650E+03	6.46510E-01	6.68270E-01	4.32040E-01	8.44730E-01
2.42660E+03	6.42970E-01	6.68280E-01	4.29680E-01	8.40120E-01
2.42670E+03	6.39390E-01	6.68290E-01	4.27300E-01	8.35460E-01
2.42680E+03	6.35780E-01	6.68290E-01	4.24890E-01	8.30740E-01
2.42690E+03	6.32130E-01	6.68300E-01	4.22450E-01	8.25990E-01
2.42700E+03	6.28460E-01	6.68310E-01	4.20000E-01	8.21200E-01
2.42710E+03	6.24770E-01	6.68310E-01	4.17540E-01	8.16380E-01
2.42720E+03	6.21060E-01	6.68310E-01	4.15060E-01	8.11540E-01
2.42730E+03	6.17340E-01	6.68320E-01	4.12580E-01	8.06680E-01
2.42740E+03	6.13610E-01	6.68320E-01	4.10080E-01	8.01800E-01
2.42750E+03	6.09850E-01	6.68320E-01	4.07580E-01	7.96900E-01
2.42760E+03	6.06080E-01	6.68330E-01	4.05060E-01	7.91970E-01
2.42770E+03	6.02280E-01	6.68330E-01	4.02520E-01	7.87010E-01
2.42780E+03	5.98450E-01	6.68330E-01	3.99960E-01	7.82010E-01
2.42790E+03	5.94580E-01	6.68340E-01	3.97380E-01	7.76960E-01
2.42800E+03	5.90660E-01	6.68340E-01	3.94760E-01	7.71850E-01
2.42810E+03	5.86700E-01	6.68320E-01	3.92110E-01	7.66650E-01
2.42820E+03	5.82680E-01	6.68310E-01	3.89410E-01	7.61380E-01
2.42830E+03	5.78600E-01	6.68370E-01	3.86720E-01	7.56120E-01
2.42840E+03	5.74470E-01	6.68430E-01	3.83990E-01	7.50780E-01
2.42850E+03	5.70270E-01	6.68490E-01	3.81220E-01	7.45360E-01
2.42860E+03	5.66020E-01	6.68550E-01	3.78410E-01	7.39870E-01
2.42870E+03	5.61720E-01	6.68610E-01	3.75570E-01	7.34320E-01
2.42880E+03	5.57370E-01	6.68670E-01	3.72700E-01	7.28710E-01
2.42890E+03	5.52990E-01	6.68730E-01	3.69810E-01	7.23050E-01
2.42900E+03	5.48590E-01	6.68790E-01	3.66890E-01	7.17350E-01
2.42910E+03	5.44170E-01	6.68860E-01	3.63970E-01	7.11650E-01

2.42920E+03	5.39750E-01	6.68920E-01	3.61050E-01	7.05930E-01
2.42930E+03	5.35330E-01	6.68990E-01	3.58130E-01	7.00220E-01
2.42940E+03	5.30920E-01	6.69050E-01	3.55210E-01	6.94520E-01
2.42950E+03	5.26530E-01	6.69110E-01	3.52310E-01	6.88840E-01
2.42960E+03	5.22160E-01	6.69180E-01	3.49420E-01	6.83180E-01
2.42970E+03	5.17800E-01	6.69240E-01	3.46530E-01	6.77550E-01
2.42980E+03	5.13460E-01	6.69300E-01	3.43660E-01	6.71930E-01
2.42990E+03	5.09140E-01	6.69370E-01	3.40800E-01	6.66340E-01
2.43000E+03	5.04820E-01	6.69430E-01	3.37940E-01	6.60750E-01
2.43010E+03	5.00500E-01	6.69450E-01	3.35060E-01	6.55110E-01
2.43020E+03	4.96160E-01	6.69470E-01	3.32160E-01	6.49450E-01
2.43030E+03	4.91800E-01	6.69480E-01	3.29250E-01	6.43750E-01
2.43040E+03	4.87410E-01	6.69490E-01	3.26310E-01	6.38010E-01
2.43050E+03	4.82980E-01	6.69430E-01	3.23320E-01	6.32160E-01
2.43060E+03	4.78500E-01	6.69380E-01	3.20300E-01	6.26240E-01
2.43070E+03	4.73960E-01	6.69330E-01	3.17230E-01	6.20260E-01
2.43080E+03	4.69370E-01	6.69270E-01	3.14130E-01	6.14200E-01
2.43090E+03	4.64720E-01	6.69220E-01	3.11000E-01	6.08060E-01
2.43100E+03	4.60010E-01	6.69160E-01	3.07830E-01	6.01860E-01
2.43110E+03	4.55260E-01	6.69110E-01	3.04620E-01	5.95600E-01
2.43120E+03	4.50470E-01	6.69060E-01	3.01390E-01	5.89280E-01
2.43130E+03	4.45640E-01	6.69010E-01	2.98140E-01	5.82930E-01
2.43140E+03	4.40800E-01	6.68960E-01	2.94880E-01	5.76550E-01
2.43150E+03	4.35940E-01	6.68920E-01	2.91610E-01	5.70150E-01
2.43160E+03	4.31090E-01	6.68870E-01	2.88340E-01	5.63760E-01
2.43170E+03	4.26250E-01	6.68820E-01	2.85080E-01	5.57390E-01
2.43180E+03	4.21430E-01	6.68770E-01	2.81840E-01	5.51050E-01
2.43190E+03	4.16640E-01	6.68720E-01	2.78610E-01	5.44740E-01
2.43200E+03	4.11880E-01	6.68670E-01	2.75410E-01	5.38490E-01
2.43210E+03	4.07160E-01	6.68630E-01	2.72240E-01	5.32280E-01
2.43220E+03	4.02480E-01	6.68580E-01	2.69090E-01	5.26130E-01
2.43230E+03	3.97830E-01	6.68540E-01	2.65970E-01	5.20020E-01
2.43240E+03	3.93210E-01	6.68500E-01	2.62860E-01	5.13950E-01
2.43250E+03	3.88610E-01	6.68460E-01	2.59770E-01	5.07900E-01
2.43260E+03	3.84020E-01	6.68420E-01	2.56690E-01	5.01880E-01
2.43270E+03	3.79440E-01	6.68410E-01	2.53620E-01	4.95880E-01
2.43280E+03	3.74850E-01	6.68400E-01	2.50550E-01	4.89880E-01
2.43290E+03	3.70250E-01	6.68390E-01	2.47470E-01	4.83860E-01
2.43300E+03	3.65630E-01	6.68380E-01	2.44380E-01	4.77810E-01
2.43310E+03	3.60980E-01	6.68380E-01	2.41270E-01	4.71740E-01
2.43320E+03	3.56310E-01	6.68370E-01	2.38140E-01	4.65620E-01
2.43330E+03	3.51600E-01	6.68360E-01	2.35000E-01	4.59470E-01
2.43340E+03	3.46880E-01	6.68350E-01	2.31840E-01	4.53290E-01

2.43350E+03	3.42130E-01	6.68340E-01	2.28660E-01	4.47080E-01
2.43360E+03	3.37360E-01	6.68340E-01	2.25470E-01	4.40850E-01
2.43370E+03	3.32590E-01	6.68330E-01	2.22280E-01	4.34610E-01
2.43380E+03	3.27830E-01	6.68320E-01	2.19100E-01	4.28380E-01
2.43390E+03	3.23080E-01	6.68310E-01	2.15920E-01	4.22170E-01
2.43400E+03	3.18360E-01	6.68310E-01	2.12770E-01	4.16000E-01
2.43410E+03	3.13680E-01	6.68360E-01	2.09650E-01	4.09920E-01
2.43420E+03	3.09050E-01	6.68420E-01	2.06570E-01	4.03890E-01
2.43430E+03	3.04470E-01	6.68470E-01	2.03530E-01	3.97940E-01
2.43440E+03	2.99960E-01	6.68520E-01	2.00530E-01	3.92070E-01
2.43450E+03	2.95510E-01	6.68570E-01	1.97570E-01	3.86290E-01
2.43460E+03	2.91130E-01	6.68620E-01	1.94660E-01	3.80590E-01
2.43470E+03	2.86820E-01	6.68670E-01	1.91790E-01	3.74990E-01
2.43480E+03	2.82580E-01	6.68720E-01	1.88960E-01	3.69460E-01
2.43490E+03	2.78390E-01	6.68800E-01	1.86190E-01	3.64030E-01
2.43500E+03	2.74260E-01	6.68880E-01	1.83450E-01	3.58670E-01
2.43510E+03	2.70180E-01	6.68990E-01	1.80750E-01	3.53390E-01
2.43520E+03	2.66130E-01	6.69100E-01	1.78070E-01	3.48160E-01
2.43530E+03	2.62120E-01	6.69210E-01	1.75420E-01	3.42970E-01
2.43540E+03	2.58140E-01	6.69320E-01	1.72780E-01	3.37820E-01
2.43550E+03	2.54170E-01	6.69430E-01	1.70150E-01	3.32680E-01
2.43560E+03	2.50220E-01	6.69540E-01	1.67530E-01	3.27570E-01
2.43570E+03	2.46280E-01	6.69660E-01	1.64920E-01	3.22460E-01
2.43580E+03	2.42350E-01	6.69770E-01	1.62320E-01	3.17370E-01
2.43590E+03	2.38430E-01	6.69880E-01	1.59720E-01	3.12290E-01
2.43600E+03	2.34520E-01	6.69980E-01	1.57120E-01	3.07210E-01
2.43610E+03	2.30620E-01	6.70020E-01	1.54520E-01	3.02120E-01
2.43620E+03	2.26740E-01	6.70050E-01	1.51930E-01	2.97060E-01
2.43630E+03	2.22880E-01	6.70090E-01	1.49350E-01	2.92020E-01
2.43640E+03	2.19050E-01	6.70130E-01	1.46790E-01	2.87010E-01
2.43650E+03	2.15250E-01	6.70160E-01	1.44250E-01	2.82040E-01
2.43660E+03	2.11480E-01	6.70200E-01	1.41730E-01	2.77120E-01
2.43670E+03	2.07750E-01	6.70230E-01	1.39240E-01	2.72240E-01
2.43680E+03	2.04050E-01	6.70270E-01	1.36770E-01	2.67420E-01
2.43690E+03	2.00410E-01	6.70310E-01	1.34330E-01	2.62650E-01
2.43700E+03	1.96800E-01	6.70340E-01	1.31920E-01	2.57940E-01
2.43710E+03	1.93240E-01	6.70220E-01	1.29510E-01	2.53220E-01
2.43720E+03	1.89720E-01	6.70100E-01	1.27130E-01	2.48570E-01
2.43730E+03	1.86240E-01	6.69970E-01	1.24780E-01	2.43960E-01
2.43740E+03	1.82800E-01	6.69850E-01	1.22450E-01	2.39410E-01
2.43750E+03	1.79400E-01	6.69730E-01	1.20150E-01	2.34920E-01
2.43760E+03	1.76030E-01	6.69610E-01	1.17870E-01	2.30470E-01
2.43770E+03	1.72700E-01	6.69490E-01	1.15620E-01	2.26060E-01

2.43780E+03	1.69400E-01	6.69360E-01	1.13390E-01	2.21710E-01
2.43790E+03	1.66140E-01	6.69240E-01	1.11190E-01	2.17400E-01
2.43800E+03	1.62910E-01	6.69120E-01	1.09010E-01	2.13130E-01
2.43810E+03	1.59710E-01	6.69010E-01	1.06850E-01	2.08910E-01
2.43820E+03	1.56550E-01	6.68900E-01	1.04720E-01	2.04750E-01
2.43830E+03	1.53430E-01	6.68810E-01	1.02620E-01	2.00640E-01
2.43840E+03	1.50350E-01	6.68730E-01	1.00540E-01	1.96580E-01
2.43850E+03	1.47310E-01	6.68640E-01	9.84950E-02	1.92580E-01
2.43860E+03	1.44310E-01	6.68550E-01	9.64780E-02	1.88630E-01
2.43870E+03	1.41360E-01	6.68460E-01	9.44910E-02	1.84750E-01
2.43880E+03	1.38450E-01	6.68370E-01	9.25360E-02	1.80930E-01
2.43890E+03	1.35590E-01	6.68280E-01	9.06130E-02	1.77170E-01
2.43900E+03	1.32780E-01	6.68190E-01	8.87200E-02	1.73470E-01
2.43910E+03	1.30010E-01	6.68100E-01	8.68580E-02	1.69830E-01
2.43920E+03	1.27280E-01	6.68010E-01	8.50260E-02	1.66240E-01
2.43930E+03	1.24600E-01	6.67990E-01	8.32290E-02	1.62730E-01
2.43940E+03	1.21950E-01	6.67960E-01	8.14580E-02	1.59270E-01
2.43950E+03	1.19340E-01	6.67940E-01	7.97110E-02	1.55850E-01
2.43960E+03	1.16760E-01	6.67910E-01	7.79860E-02	1.52480E-01
2.43970E+03	1.14220E-01	6.67890E-01	7.62830E-02	1.49150E-01
2.43980E+03	1.11700E-01	6.67860E-01	7.45990E-02	1.45860E-01
2.43990E+03	1.09210E-01	6.67840E-01	7.29350E-02	1.42600E-01
2.44000E+03	1.06750E-01	6.67820E-01	7.12900E-02	1.39390E-01
2.44010E+03	1.04320E-01	6.67820E-01	6.96690E-02	1.36220E-01
2.44020E+03	1.01930E-01	6.67830E-01	6.80690E-02	1.33090E-01
2.44030E+03	9.95640E-02	6.67830E-01	6.64910E-02	1.30000E-01
2.44040E+03	9.72400E-02	6.67830E-01	6.49400E-02	1.26970E-01
2.44050E+03	9.49570E-02	6.67830E-01	6.34150E-02	1.23990E-01
2.44060E+03	9.27190E-02	6.67840E-01	6.19210E-02	1.21070E-01
2.44070E+03	9.05300E-02	6.67840E-01	6.04600E-02	1.18210E-01
2.44080E+03	8.83930E-02	6.67840E-01	5.90330E-02	1.15420E-01
2.44090E+03	8.63100E-02	6.67840E-01	5.76420E-02	1.12700E-01
2.44100E+03	8.42830E-02	6.67850E-01	5.62880E-02	1.10060E-01
2.44110E+03	8.23130E-02	6.67850E-01	5.49720E-02	1.07480E-01
2.44120E+03	8.03980E-02	6.67850E-01	5.36930E-02	1.04980E-01
2.44130E+03	7.85370E-02	6.67850E-01	5.24510E-02	1.02550E-01
2.44140E+03	7.67280E-02	6.67850E-01	5.12430E-02	1.00190E-01
2.44150E+03	7.49670E-02	6.67940E-01	5.00740E-02	9.79050E-02
2.44160E+03	7.32510E-02	6.68040E-01	4.89340E-02	9.56770E-02
2.44170E+03	7.15750E-02	6.68130E-01	4.78210E-02	9.35010E-02
2.44180E+03	6.99350E-02	6.68230E-01	4.67320E-02	9.13710E-02
2.44190E+03	6.83270E-02	6.68320E-01	4.56640E-02	8.92830E-02
2.44200E+03	6.67490E-02	6.68410E-01	4.46160E-02	8.72330E-02

2.44210E+03	6.51980E-02	6.68530E-01	4.35870E-02	8.52220E-02
2.44220E+03	6.36740E-02	6.68650E-01	4.25760E-02	8.32450E-02
2.44230E+03	6.21780E-02	6.68770E-01	4.15820E-02	8.13020E-02
2.44240E+03	6.07100E-02	6.68890E-01	4.06080E-02	7.93970E-02
2.44250E+03	5.92740E-02	6.69000E-01	3.96540E-02	7.75320E-02
2.44260E+03	5.78730E-02	6.69120E-01	3.87240E-02	7.57140E-02
2.44270E+03	5.65120E-02	6.69240E-01	3.78200E-02	7.39470E-02
2.44280E+03	5.51970E-02	6.69360E-01	3.69460E-02	7.22380E-02
2.44290E+03	5.39300E-02	6.69480E-01	3.61050E-02	7.05930E-02
2.44300E+03	5.27180E-02	6.69590E-01	3.53000E-02	6.90180E-02
2.44310E+03	5.15640E-02	6.69710E-01	3.45330E-02	6.75180E-02
2.44320E+03	5.04690E-02	6.69820E-01	3.38050E-02	6.60960E-02
2.44330E+03	4.94350E-02	6.69930E-01	3.31180E-02	6.47530E-02
2.44340E+03	4.84600E-02	6.70050E-01	3.24710E-02	6.34870E-02
2.44350E+03	4.75420E-02	6.70160E-01	3.18610E-02	6.22950E-02
2.44360E+03	4.66760E-02	6.70270E-01	3.12860E-02	6.11700E-02
2.44370E+03	4.58550E-02	6.70390E-01	3.07410E-02	6.01040E-02
2.44380E+03	4.50720E-02	6.70500E-01	3.02200E-02	5.90870E-02
2.44390E+03	4.43160E-02	6.70610E-01	2.97190E-02	5.81060E-02
2.44400E+03	4.35790E-02	6.70710E-01	2.92290E-02	5.71490E-02
2.44410E+03	4.28510E-02	6.70780E-01	2.87430E-02	5.61990E-02
2.44420E+03	4.21210E-02	6.70840E-01	2.82560E-02	5.52470E-02
2.44430E+03	4.13800E-02	6.70910E-01	2.77620E-02	5.42810E-02
2.44440E+03	4.06220E-02	6.70980E-01	2.72570E-02	5.32920E-02
2.44450E+03	3.98400E-02	6.71040E-01	2.67350E-02	5.22720E-02
2.44460E+03	3.90310E-02	6.71110E-01	2.61940E-02	5.12150E-02
2.44470E+03	3.81930E-02	6.71180E-01	2.56340E-02	5.01200E-02
2.44480E+03	3.73260E-02	6.71240E-01	2.50540E-02	4.89870E-02
2.44490E+03	3.64330E-02	6.71310E-01	2.44580E-02	4.78200E-02
2.44500E+03	3.55190E-02	6.71380E-01	2.38470E-02	4.66250E-02
2.44510E+03	3.45910E-02	6.71370E-01	2.32230E-02	4.54060E-02
2.44520E+03	3.36560E-02	6.71370E-01	2.25960E-02	4.41790E-02
2.44530E+03	3.27240E-02	6.71370E-01	2.19700E-02	4.29550E-02
2.44540E+03	3.18020E-02	6.71370E-01	2.13510E-02	4.17460E-02
2.44550E+03	3.09000E-02	6.71360E-01	2.07450E-02	4.05620E-02
2.44560E+03	3.00260E-02	6.71360E-01	2.01580E-02	3.94130E-02
2.44570E+03	2.91850E-02	6.71360E-01	1.95940E-02	3.83100E-02
2.44580E+03	2.83830E-02	6.71360E-01	1.90550E-02	3.72560E-02
2.44590E+03	2.76220E-02	6.71220E-01	1.85400E-02	3.62500E-02
2.44600E+03	2.69020E-02	6.71090E-01	1.80540E-02	3.52990E-02
2.44610E+03	2.62240E-02	6.70900E-01	1.75940E-02	3.43990E-02
2.44620E+03	2.55820E-02	6.70710E-01	1.71580E-02	3.35480E-02
2.44630E+03	2.49730E-02	6.70520E-01	1.67450E-02	3.27400E-02

2.44640E+03	2.43890E-02	6.70330E-01	1.63490E-02	3.19650E-02
2.44650E+03	2.38230E-02	6.70130E-01	1.59650E-02	3.12140E-02
2.44660E+03	2.32670E-02	6.69940E-01	1.55880E-02	3.04770E-02
2.44670E+03	2.27130E-02	6.69750E-01	1.52120E-02	2.97430E-02
2.44680E+03	2.21540E-02	6.69560E-01	1.48330E-02	2.90020E-02
2.44690E+03	2.15820E-02	6.69370E-01	1.44470E-02	2.82460E-02
2.44700E+03	2.09940E-02	6.69170E-01	1.40490E-02	2.74680E-02
2.44710E+03	2.03860E-02	6.68990E-01	1.36380E-02	2.66650E-02
2.44720E+03	1.97560E-02	6.68800E-01	1.32130E-02	2.58340E-02
2.44730E+03	1.91060E-02	6.68610E-01	1.27750E-02	2.49770E-02
2.44740E+03	1.84390E-02	6.68430E-01	1.23250E-02	2.40980E-02
2.44750E+03	1.77590E-02	6.68240E-01	1.18670E-02	2.32020E-02
2.44760E+03	1.70720E-02	6.68050E-01	1.14050E-02	2.22990E-02
2.44770E+03	1.63870E-02	6.67870E-01	1.09440E-02	2.13990E-02
2.44780E+03	1.57130E-02	6.67680E-01	1.04910E-02	2.05120E-02
2.44790E+03	1.50580E-02	6.67490E-01	1.00510E-02	1.96520E-02
2.44800E+03	1.44320E-02	6.67320E-01	9.63080E-03	1.88300E-02
2.44810E+03	1.38440E-02	6.67280E-01	9.23780E-03	1.80620E-02
2.44820E+03	1.33010E-02	6.67240E-01	8.87490E-03	1.73520E-02
2.44830E+03	1.28100E-02	6.67200E-01	8.54690E-03	1.67110E-02
2.44840E+03	1.23770E-02	6.67160E-01	8.25710E-03	1.61440E-02
2.44850E+03	1.20040E-02	6.67120E-01	8.00770E-03	1.56570E-02
2.44860E+03	1.16930E-02	6.67080E-01	7.79980E-03	1.52500E-02
2.44870E+03	1.14430E-02	6.67030E-01	7.63310E-03	1.49240E-02
2.44880E+03	1.12540E-02	6.66990E-01	7.50620E-03	1.46760E-02
2.44890E+03	1.11200E-02	6.66950E-01	7.41660E-03	1.45010E-02
2.44900E+03	1.10370E-02	6.66910E-01	7.36070E-03	1.43920E-02
2.44910E+03	1.09980E-02	6.66870E-01	7.33420E-03	1.43400E-02
2.44920E+03	1.09950E-02	6.66830E-01	7.33210E-03	1.43360E-02
2.44930E+03	1.10220E-02	6.66790E-01	7.34910E-03	1.43690E-02
2.44940E+03	1.10680E-02	6.66750E-01	7.37960E-03	1.44290E-02
2.44950E+03	1.11270E-02	6.66700E-01	7.41810E-03	1.45040E-02
2.44960E+03	1.11890E-02	6.66660E-01	7.45940E-03	1.45850E-02
2.44970E+03	1.12490E-02	6.66620E-01	7.49850E-03	1.46610E-02
2.44980E+03	1.12980E-02	6.66580E-01	7.53090E-03	1.47250E-02
2.44990E+03	1.13310E-02	6.66540E-01	7.55280E-03	1.47670E-02
2.45000E+03	1.13440E-02	6.66490E-01	7.56070E-03	1.47830E-02
2.45010E+03	1.13320E-02	6.66530E-01	7.55280E-03	1.47670E-02
2.45020E+03	1.12910E-02	6.66580E-01	7.52650E-03	1.47160E-02
2.45030E+03	1.12200E-02	6.66750E-01	7.48100E-03	1.46270E-02
2.45040E+03	1.11170E-02	6.66920E-01	7.41430E-03	1.44970E-02
2.45050E+03	1.09820E-02	6.67090E-01	7.32580E-03	1.43230E-02
2.45060E+03	1.08130E-02	6.67270E-01	7.21530E-03	1.41070E-02

2.45070E+03	1.06130E-02	6.67440E-01	7.08360E-03	1.38500E-02
2.45080E+03	1.03820E-02	6.67610E-01	6.93120E-03	1.35520E-02
2.45090E+03	1.01220E-02	6.67780E-01	6.75940E-03	1.32160E-02
2.45100E+03	8.65160E-03	6.67950E-01	5.77880E-03	1.12990E-02
2.45110E+03	8.46080E-03	6.68120E-01	5.65290E-03	1.10530E-02
2.45120E+03	8.26640E-03	6.68290E-01	5.52440E-03	1.08010E-02
2.45130E+03	8.06770E-03	6.68470E-01	5.39300E-03	1.05440E-02
2.45140E+03	7.86400E-03	6.68640E-01	5.25820E-03	1.02810E-02
2.45150E+03	7.65500E-03	6.68810E-01	5.11980E-03	1.00100E-02
2.45160E+03	7.44030E-03	6.68980E-01	4.97750E-03	9.73200E-03
2.45170E+03	7.21990E-03	6.69160E-01	4.83120E-03	9.44610E-03
2.45180E+03	6.99380E-03	6.69330E-01	4.68120E-03	9.15270E-03
2.45190E+03	6.76230E-03	6.69500E-01	4.52740E-03	8.85200E-03
2.45200E+03	6.52580E-03	6.69680E-01	4.37010E-03	8.54450E-03
2.45210E+03	6.28480E-03	6.69750E-01	4.20920E-03	8.23000E-03
2.45220E+03	6.04000E-03	6.69830E-01	4.04580E-03	7.91040E-03
2.45230E+03	5.79240E-03	6.69910E-01	3.88040E-03	7.58690E-03
2.45240E+03	4.88640E-03	6.69990E-01	3.27380E-03	6.40110E-03
2.45250E+03	4.59680E-03	6.69900E-01	3.07940E-03	6.02090E-03
2.45260E+03	4.32610E-03	6.69820E-01	2.89770E-03	5.66560E-03
2.45270E+03	4.07370E-03	6.69730E-01	2.72830E-03	5.33430E-03
2.45280E+03	3.83840E-03	6.69650E-01	2.57030E-03	5.02560E-03
2.45290E+03	3.61840E-03	6.69560E-01	2.42270E-03	4.73690E-03
2.45300E+03	3.41160E-03	6.69480E-01	2.28400E-03	4.46570E-03
2.45310E+03	3.21580E-03	6.69400E-01	2.15260E-03	4.20890E-03
2.45320E+03	3.02860E-03	6.69310E-01	2.02710E-03	3.96330E-03
2.45330E+03	2.84770E-03	6.69230E-01	1.90580E-03	3.72620E-03
2.45340E+03	2.67120E-03	6.69150E-01	1.78740E-03	3.49480E-03
2.45350E+03	2.49720E-03	6.69070E-01	1.67080E-03	3.26680E-03
2.45360E+03	2.32440E-03	6.68990E-01	1.55500E-03	3.04030E-03
2.45370E+03	2.15180E-03	6.68910E-01	1.43940E-03	2.81420E-03
2.45380E+03	1.97890E-03	6.68830E-01	1.32350E-03	2.58780E-03
2.45390E+03	1.80580E-03	6.68750E-01	1.20770E-03	2.36120E-03
2.45400E+03	1.63350E-03	6.68670E-01	1.09220E-03	2.13550E-03
2.45410E+03	1.46310E-03	6.68580E-01	9.78180E-04	1.91250E-03
2.45420E+03	1.29680E-03	6.68490E-01	8.66890E-04	1.69500E-03
2.45430E+03	1.13730E-03	6.68410E-01	7.60210E-04	1.48640E-03
2.45440E+03	0.00000E+00	6.68320E-01	0.00000E+00	0.00000E+00
Channel 18				
Wavenumber	HIRS Filter Transmittance	Optical Element Transmittance	Product of the HIRS Filter and Optical Element Transmittances	Normalized Value of Column 4

2.45760E+03	0.00000E+00	6.69010E-01	0.00000E+00	0.00000E+00
2.45770E+03	2.30950E-03	6.69150E-01	1.54540E-03	3.21830E-03
2.45780E+03	2.04700E-03	6.69290E-01	1.37010E-03	2.85310E-03
2.45790E+03	1.80550E-03	6.69430E-01	1.20870E-03	2.51710E-03
2.45800E+03	1.58980E-03	6.69570E-01	1.06450E-03	2.21680E-03
2.45810E+03	1.40420E-03	6.69650E-01	9.40350E-04	1.95830E-03
2.45820E+03	1.25270E-03	6.69710E-01	8.38910E-04	1.74700E-03
2.45830E+03	1.13830E-03	6.69760E-01	7.62400E-04	1.58770E-03
2.45840E+03	1.06380E-03	6.69820E-01	7.12540E-04	1.48390E-03
2.45850E+03	1.03090E-03	6.69870E-01	6.90560E-04	1.43810E-03
2.45860E+03	1.04060E-03	6.69930E-01	6.97100E-04	1.45170E-03
2.45870E+03	1.09300E-03	6.69980E-01	7.32290E-04	1.52500E-03
2.45880E+03	1.18740E-03	6.70030E-01	7.95570E-04	1.65680E-03
2.45890E+03	1.32200E-03	6.70090E-01	8.85830E-04	1.84470E-03
2.45900E+03	1.49420E-03	6.70140E-01	1.00140E-03	2.08530E-03
2.45910E+03	1.70080E-03	6.70180E-01	1.13980E-03	2.37370E-03
2.45920E+03	1.93760E-03	6.70220E-01	1.29860E-03	2.70430E-03
2.45930E+03	2.19990E-03	6.70260E-01	1.47450E-03	3.07060E-03
2.45940E+03	2.48240E-03	6.70300E-01	1.66390E-03	3.46520E-03
2.45950E+03	2.77950E-03	6.70340E-01	1.86320E-03	3.88020E-03
2.45960E+03	3.08530E-03	6.70380E-01	2.06840E-03	4.30740E-03
2.45970E+03	3.31280E-03	6.70420E-01	2.22100E-03	4.62520E-03
2.45980E+03	3.36000E-03	6.70460E-01	2.25270E-03	4.69130E-03
2.45990E+03	3.40910E-03	6.70500E-01	2.28580E-03	4.76010E-03
2.46000E+03	3.45990E-03	6.70540E-01	2.32000E-03	4.83140E-03
2.46010E+03	3.51210E-03	6.70570E-01	2.35510E-03	4.90450E-03
2.46020E+03	3.56540E-03	6.70600E-01	2.39100E-03	4.97920E-03
2.46030E+03	3.61950E-03	6.70640E-01	2.42740E-03	5.05510E-03
2.46040E+03	3.67420E-03	6.70670E-01	2.46420E-03	5.13170E-03
2.46050E+03	3.72900E-03	6.70710E-01	2.50110E-03	5.20860E-03
2.46060E+03	3.78380E-03	6.70760E-01	2.53800E-03	5.28540E-03
2.46070E+03	3.83820E-03	6.70810E-01	2.57470E-03	5.36170E-03
2.46080E+03	3.89180E-03	6.70850E-01	2.61080E-03	5.43700E-03
2.46090E+03	3.94430E-03	6.70900E-01	2.64630E-03	5.51090E-03
2.46100E+03	3.99560E-03	6.70950E-01	2.68080E-03	5.58280E-03
2.46110E+03	4.04510E-03	6.71000E-01	2.71430E-03	5.65250E-03
2.46120E+03	4.09280E-03	6.71040E-01	2.74640E-03	5.71950E-03
2.46130E+03	4.13830E-03	6.71060E-01	2.77700E-03	5.78320E-03
2.46140E+03	4.18140E-03	6.71080E-01	2.80600E-03	5.84350E-03
2.46150E+03	4.22190E-03	6.71090E-01	2.83330E-03	5.90030E-03
2.46160E+03	4.25970E-03	6.71110E-01	2.85870E-03	5.95330E-03
2.46170E+03	4.29460E-03	6.71130E-01	2.88220E-03	6.00230E-03
2.46180E+03	4.32670E-03	6.71140E-01	2.90380E-03	6.04730E-03

2.46190E+03	4.35590E-03	6.71160E-01	2.92350E-03	6.08820E-03
2.46200E+03	4.38230E-03	6.71170E-01	2.94130E-03	6.12520E-03
2.46210E+03	4.40590E-03	6.71180E-01	2.95710E-03	6.15830E-03
2.46220E+03	4.42700E-03	6.71170E-01	2.97120E-03	6.18760E-03
2.46230E+03	4.44560E-03	6.71170E-01	2.98380E-03	6.21370E-03
2.46240E+03	4.46220E-03	6.71160E-01	2.99480E-03	6.23680E-03
2.46250E+03	4.47690E-03	6.71160E-01	3.00470E-03	6.25740E-03
2.46260E+03	4.49020E-03	6.71160E-01	3.01360E-03	6.27590E-03
2.46270E+03	4.50230E-03	6.71150E-01	3.02180E-03	6.29280E-03
2.46280E+03	4.51380E-03	6.71150E-01	3.02940E-03	6.30880E-03
2.46290E+03	4.52510E-03	6.71140E-01	3.03700E-03	6.32450E-03
2.46300E+03	4.53650E-03	6.71140E-01	3.04460E-03	6.34040E-03
2.46310E+03	4.54850E-03	6.71130E-01	3.05260E-03	6.35720E-03
2.46320E+03	4.56160E-03	6.71120E-01	3.06140E-03	6.37540E-03
2.46330E+03	4.57620E-03	6.71120E-01	3.07120E-03	6.39580E-03
2.46340E+03	4.59280E-03	6.71110E-01	3.08220E-03	6.41880E-03
2.46350E+03	4.61150E-03	6.71100E-01	3.09480E-03	6.44500E-03
2.46360E+03	4.63290E-03	6.71090E-01	3.10910E-03	6.47480E-03
2.46370E+03	4.65720E-03	6.71080E-01	3.12540E-03	6.50870E-03
2.46380E+03	4.68470E-03	6.71070E-01	3.14380E-03	6.54690E-03
2.46390E+03	4.71540E-03	6.71070E-01	3.16430E-03	6.58980E-03
2.46400E+03	4.74950E-03	6.71060E-01	3.18720E-03	6.63740E-03
2.46410E+03	4.78710E-03	6.71030E-01	3.21230E-03	6.68960E-03
2.46420E+03	4.82820E-03	6.70990E-01	3.23970E-03	6.74660E-03
2.46430E+03	4.87260E-03	6.70950E-01	3.26930E-03	6.80840E-03
2.46440E+03	4.92030E-03	6.70910E-01	3.30110E-03	6.87460E-03
2.46450E+03	4.97110E-03	6.70880E-01	3.33500E-03	6.94520E-03
2.46460E+03	5.02470E-03	6.70840E-01	3.37070E-03	7.01960E-03
2.46470E+03	5.08070E-03	6.70800E-01	3.40820E-03	7.09750E-03
2.46480E+03	5.13900E-03	6.70760E-01	3.44700E-03	7.17850E-03
2.46490E+03	5.19910E-03	6.70720E-01	3.48720E-03	7.26200E-03
2.46500E+03	5.26060E-03	6.70690E-01	3.52820E-03	7.34760E-03
2.46510E+03	5.32320E-03	6.70630E-01	3.56990E-03	7.43430E-03
2.46520E+03	5.38640E-03	6.70570E-01	3.61200E-03	7.52200E-03
2.46530E+03	5.44990E-03	6.70510E-01	3.65420E-03	7.60990E-03
2.46540E+03	5.51330E-03	6.70450E-01	3.69640E-03	7.69770E-03
2.46550E+03	5.57620E-03	6.70390E-01	3.73820E-03	7.78490E-03
2.46560E+03	5.63830E-03	6.70330E-01	3.77950E-03	7.87080E-03
2.46570E+03	5.69930E-03	6.70270E-01	3.82010E-03	7.95540E-03
2.46580E+03	5.75900E-03	6.70220E-01	3.85980E-03	8.03800E-03
2.46590E+03	5.81710E-03	6.70170E-01	3.89850E-03	8.11860E-03
2.46600E+03	5.87360E-03	6.70120E-01	3.93600E-03	8.19680E-03
2.46610E+03	5.92830E-03	6.70070E-01	3.97240E-03	8.27260E-03

2.46620E+03	5.98120E-03	6.70030E-01	4.00760E-03	8.34590E-03
2.46630E+03	6.03230E-03	6.69990E-01	4.04160E-03	8.41670E-03
2.46640E+03	6.08160E-03	6.69950E-01	4.07440E-03	8.48500E-03
2.46650E+03	6.12940E-03	6.69910E-01	4.10610E-03	8.55100E-03
2.46660E+03	6.17560E-03	6.69870E-01	4.13680E-03	8.61500E-03
2.46670E+03	6.22050E-03	6.69830E-01	4.16660E-03	8.67710E-03
2.46680E+03	6.26420E-03	6.69790E-01	4.19570E-03	8.73760E-03
2.46690E+03	6.30720E-03	6.69740E-01	4.22420E-03	8.79690E-03
2.46700E+03	6.34940E-03	6.69700E-01	4.25220E-03	8.85530E-03
2.46710E+03	6.39130E-03	6.69660E-01	4.28000E-03	8.91320E-03
2.46720E+03	6.43310E-03	6.69610E-01	4.30770E-03	8.97080E-03
2.46730E+03	6.47490E-03	6.69570E-01	4.33540E-03	9.02850E-03
2.46740E+03	6.51700E-03	6.69520E-01	4.36330E-03	9.08660E-03
2.46750E+03	6.55960E-03	6.69480E-01	4.39150E-03	9.14540E-03
2.46760E+03	6.60290E-03	6.69430E-01	4.42020E-03	9.20510E-03
2.46770E+03	6.64690E-03	6.69390E-01	4.44940E-03	9.26590E-03
2.46780E+03	6.69180E-03	6.69340E-01	4.47910E-03	9.32790E-03
2.46790E+03	6.73760E-03	6.69310E-01	4.50950E-03	9.39120E-03
2.46800E+03	6.78440E-03	6.69280E-01	4.54060E-03	9.45590E-03
2.46810E+03	6.83190E-03	6.69320E-01	4.57270E-03	9.52270E-03
2.46820E+03	6.88030E-03	6.69350E-01	4.60530E-03	9.59060E-03
2.46830E+03	6.92930E-03	6.69380E-01	4.63830E-03	9.65930E-03
2.46840E+03	6.97880E-03	6.69410E-01	4.67170E-03	9.72880E-03
2.46850E+03	7.02860E-03	6.69450E-01	4.70530E-03	9.79880E-03
2.46860E+03	7.07860E-03	6.69480E-01	4.73900E-03	9.86890E-03
2.46870E+03	7.12840E-03	6.69510E-01	4.77260E-03	9.93890E-03
2.46880E+03	7.17790E-03	6.69550E-01	4.80600E-03	1.00080E-02
2.46890E+03	7.22690E-03	6.69580E-01	4.83900E-03	1.00770E-02
2.46900E+03	7.27510E-03	6.69610E-01	4.87150E-03	1.01450E-02
2.46910E+03	7.32220E-03	6.69640E-01	4.90330E-03	1.02110E-02
2.46920E+03	7.36820E-03	6.69680E-01	4.93430E-03	1.02760E-02
2.46930E+03	7.41280E-03	6.69710E-01	4.96440E-03	1.03380E-02
2.46940E+03	7.45600E-03	6.69740E-01	4.99360E-03	1.03990E-02
2.46950E+03	7.49750E-03	6.69770E-01	5.02160E-03	1.04580E-02
2.46960E+03	7.53750E-03	6.69800E-01	5.04860E-03	1.05140E-02
2.46970E+03	7.57580E-03	6.69820E-01	5.07450E-03	1.05680E-02
2.46980E+03	7.61260E-03	6.69850E-01	5.09930E-03	1.06190E-02
2.46990E+03	7.64800E-03	6.69880E-01	5.12320E-03	1.06690E-02
2.47000E+03	7.68200E-03	6.69910E-01	5.14620E-03	1.07170E-02
2.47010E+03	7.71490E-03	6.69970E-01	5.16880E-03	1.07640E-02
2.47020E+03	7.74710E-03	6.70030E-01	5.19080E-03	1.08100E-02
2.47030E+03	7.77870E-03	6.70090E-01	5.21240E-03	1.08550E-02
2.47040E+03	7.81010E-03	6.70150E-01	5.23400E-03	1.09000E-02

2.47050E+03	7.84170E-03	6.70210E-01	5.25560E-03	1.09450E-02
2.47060E+03	7.87390E-03	6.70270E-01	5.27770E-03	1.09910E-02
2.47070E+03	7.90720E-03	6.70330E-01	5.30040E-03	1.10380E-02
2.47080E+03	7.94180E-03	6.70390E-01	5.32410E-03	1.10880E-02
2.47090E+03	7.97840E-03	6.70450E-01	5.34910E-03	1.11400E-02
2.47100E+03	8.01720E-03	6.70510E-01	5.37570E-03	1.11950E-02
2.47110E+03	8.05880E-03	6.70570E-01	5.40400E-03	1.12540E-02
2.47120E+03	8.10360E-03	6.70630E-01	5.43450E-03	1.13170E-02
2.47130E+03	8.15180E-03	6.70690E-01	5.46730E-03	1.13860E-02
2.47140E+03	8.20380E-03	6.70750E-01	5.50270E-03	1.14590E-02
2.47150E+03	8.26000E-03	6.70810E-01	5.54090E-03	1.15390E-02
2.47160E+03	8.32060E-03	6.70860E-01	5.58200E-03	1.16250E-02
2.47170E+03	8.38580E-03	6.70920E-01	5.62620E-03	1.17170E-02
2.47180E+03	8.45560E-03	6.70980E-01	5.67360E-03	1.18150E-02
2.47190E+03	8.53030E-03	6.71040E-01	5.72420E-03	1.19210E-02
2.47200E+03	8.60980E-03	6.71100E-01	5.77800E-03	1.20330E-02
2.47210E+03	8.69420E-03	6.71110E-01	5.83480E-03	1.21510E-02
2.47220E+03	8.78330E-03	6.71130E-01	5.89470E-03	1.22760E-02
2.47230E+03	8.87700E-03	6.71200E-01	5.95820E-03	1.24080E-02
2.47240E+03	8.97510E-03	6.71260E-01	6.02460E-03	1.25460E-02
2.47250E+03	9.07740E-03	6.71330E-01	6.09390E-03	1.26910E-02
2.47260E+03	9.18370E-03	6.71390E-01	6.16580E-03	1.28400E-02
2.47270E+03	9.29350E-03	6.71460E-01	6.24020E-03	1.29950E-02
2.47280E+03	9.40670E-03	6.71520E-01	6.31680E-03	1.31550E-02
2.47290E+03	9.52280E-03	6.71590E-01	6.39540E-03	1.33180E-02
2.47300E+03	9.64140E-03	6.71650E-01	6.47570E-03	1.34860E-02
2.47310E+03	9.76220E-03	6.71720E-01	6.55750E-03	1.36560E-02
2.47320E+03	9.88480E-03	6.71790E-01	6.64050E-03	1.38290E-02
2.47330E+03	1.00090E-02	6.71860E-01	6.72460E-03	1.40040E-02
2.47340E+03	1.01340E-02	6.71930E-01	6.80920E-03	1.41800E-02
2.47350E+03	1.02600E-02	6.72000E-01	6.89450E-03	1.43580E-02
2.47360E+03	1.03860E-02	6.72060E-01	6.98000E-03	1.45360E-02
2.47370E+03	1.05120E-02	6.72130E-01	7.06550E-03	1.47140E-02
2.47380E+03	1.06380E-02	6.72200E-01	7.15090E-03	1.48920E-02
2.47390E+03	1.07640E-02	6.72270E-01	7.23620E-03	1.50690E-02
2.47400E+03	1.08890E-02	6.72340E-01	7.32100E-03	1.52460E-02
2.47410E+03	1.10130E-02	6.72440E-01	7.40570E-03	1.54220E-02
2.47420E+03	1.11370E-02	6.72560E-01	7.49000E-03	1.55980E-02
2.47430E+03	1.12590E-02	6.72670E-01	7.57370E-03	1.57720E-02
2.47440E+03	1.13810E-02	6.72790E-01	7.65680E-03	1.59450E-02
2.47450E+03	1.15020E-02	6.72810E-01	7.73840E-03	1.61150E-02
2.47460E+03	1.16220E-02	6.72840E-01	7.81950E-03	1.62840E-02
2.47470E+03	1.17410E-02	6.72860E-01	7.90010E-03	1.64520E-02

2.47480E+03	1.18600E-02	6.72890E-01	7.98030E-03	1.66190E-02
2.47490E+03	1.19780E-02	6.72910E-01	8.06030E-03	1.67860E-02
2.47500E+03	1.20970E-02	6.72940E-01	8.14020E-03	1.69520E-02
2.47510E+03	1.22150E-02	6.73010E-01	8.22080E-03	1.71200E-02
2.47520E+03	1.23340E-02	6.73080E-01	8.30170E-03	1.72880E-02
2.47530E+03	1.24530E-02	6.73150E-01	8.38290E-03	1.74580E-02
2.47540E+03	1.25740E-02	6.73220E-01	8.46490E-03	1.76280E-02
2.47550E+03	1.26950E-02	6.73290E-01	8.54760E-03	1.78000E-02
2.47560E+03	1.28180E-02	6.73370E-01	8.63140E-03	1.79750E-02
2.47570E+03	1.29430E-02	6.73440E-01	8.71640E-03	1.81520E-02
2.47580E+03	1.30700E-02	6.73510E-01	8.80290E-03	1.83320E-02
2.47590E+03	1.31990E-02	6.73580E-01	8.89090E-03	1.85150E-02
2.47600E+03	1.33310E-02	6.73660E-01	8.98080E-03	1.87030E-02
2.47610E+03	1.34660E-02	6.73770E-01	9.07310E-03	1.88950E-02
2.47620E+03	1.36040E-02	6.73870E-01	9.16740E-03	1.90910E-02
2.47630E+03	1.37450E-02	6.73980E-01	9.26390E-03	1.92920E-02
2.47640E+03	1.38890E-02	6.74090E-01	9.36260E-03	1.94980E-02
2.47650E+03	1.40370E-02	6.74190E-01	9.46380E-03	1.97080E-02
2.47660E+03	1.41890E-02	6.74300E-01	9.56740E-03	1.99240E-02
2.47670E+03	1.43440E-02	6.74370E-01	9.67300E-03	2.01440E-02
2.47680E+03	1.45020E-02	6.74450E-01	9.78100E-03	2.03690E-02
2.47690E+03	1.46640E-02	6.74520E-01	9.89140E-03	2.05990E-02
2.47700E+03	1.48300E-02	6.74590E-01	1.00040E-02	2.08340E-02
2.47710E+03	1.49990E-02	6.74660E-01	1.01190E-02	2.10740E-02
2.47720E+03	1.51720E-02	6.74730E-01	1.02370E-02	2.13190E-02
2.47730E+03	1.53480E-02	6.74810E-01	1.03570E-02	2.15680E-02
2.47740E+03	1.55260E-02	6.74880E-01	1.04780E-02	2.18210E-02
2.47750E+03	1.57080E-02	6.74950E-01	1.06020E-02	2.20790E-02
2.47760E+03	1.58920E-02	6.75020E-01	1.07270E-02	2.23400E-02
2.47770E+03	1.60780E-02	6.75090E-01	1.08540E-02	2.26040E-02
2.47780E+03	1.62670E-02	6.75160E-01	1.09830E-02	2.28720E-02
2.47790E+03	1.64570E-02	6.75230E-01	1.11130E-02	2.31420E-02
2.47800E+03	1.66490E-02	6.75300E-01	1.12430E-02	2.34150E-02
2.47810E+03	1.68430E-02	6.75280E-01	1.13740E-02	2.36860E-02
2.47820E+03	1.70380E-02	6.75250E-01	1.15050E-02	2.39590E-02
2.47830E+03	1.72330E-02	6.75220E-01	1.16360E-02	2.42320E-02
2.47840E+03	1.74300E-02	6.75180E-01	1.17680E-02	2.45070E-02
2.47850E+03	1.76260E-02	6.75150E-01	1.19000E-02	2.47830E-02
2.47860E+03	1.78240E-02	6.75120E-01	1.20330E-02	2.50590E-02
2.47870E+03	1.80210E-02	6.75090E-01	1.21660E-02	2.53350E-02
2.47880E+03	1.82190E-02	6.75050E-01	1.22990E-02	2.56120E-02
2.47890E+03	1.84160E-02	6.75080E-01	1.24330E-02	2.58910E-02
2.47900E+03	1.86150E-02	6.75120E-01	1.25670E-02	2.61710E-02

2.47910E+03	1.88130E-02	6.75150E-01	1.27010E-02	2.64510E-02
2.47920E+03	1.90110E-02	6.75180E-01	1.28360E-02	2.67310E-02
2.47930E+03	1.92100E-02	6.75210E-01	1.29710E-02	2.70120E-02
2.47940E+03	1.94100E-02	6.75240E-01	1.31060E-02	2.72930E-02
2.47950E+03	1.96100E-02	6.75270E-01	1.32420E-02	2.75760E-02
2.47960E+03	1.98110E-02	6.75300E-01	1.33790E-02	2.78610E-02
2.47970E+03	2.00140E-02	6.75330E-01	1.35160E-02	2.81470E-02
2.47980E+03	2.02190E-02	6.75360E-01	1.36550E-02	2.84360E-02
2.47990E+03	2.04250E-02	6.75390E-01	1.37950E-02	2.87290E-02
2.48000E+03	2.06350E-02	6.75420E-01	1.39370E-02	2.90240E-02
2.48010E+03	2.08470E-02	6.75430E-01	1.40810E-02	2.93240E-02
2.48020E+03	2.10630E-02	6.75450E-01	1.42270E-02	2.96280E-02
2.48030E+03	2.12840E-02	6.75460E-01	1.43760E-02	2.99390E-02
2.48040E+03	2.15090E-02	6.75480E-01	1.45290E-02	3.02560E-02
2.48050E+03	2.17390E-02	6.75490E-01	1.46840E-02	3.05810E-02
2.48060E+03	2.19750E-02	6.75510E-01	1.48440E-02	3.09130E-02
2.48070E+03	2.22180E-02	6.75520E-01	1.50080E-02	3.12550E-02
2.48080E+03	2.24670E-02	6.75520E-01	1.51770E-02	3.16060E-02
2.48090E+03	2.27240E-02	6.75520E-01	1.53510E-02	3.19680E-02
2.48100E+03	2.29900E-02	6.75520E-01	1.55300E-02	3.23420E-02
2.48110E+03	2.32640E-02	6.75570E-01	1.57170E-02	3.27300E-02
2.48120E+03	2.35480E-02	6.75610E-01	1.59100E-02	3.31320E-02
2.48130E+03	2.38420E-02	6.75660E-01	1.61090E-02	3.35480E-02
2.48140E+03	2.41470E-02	6.75710E-01	1.63160E-02	3.39780E-02
2.48150E+03	2.44620E-02	6.75750E-01	1.65300E-02	3.44250E-02
2.48160E+03	2.47890E-02	6.75800E-01	1.67530E-02	3.48870E-02
2.48170E+03	2.51280E-02	6.75850E-01	1.69830E-02	3.53670E-02
2.48180E+03	2.54800E-02	6.75890E-01	1.72220E-02	3.58650E-02
2.48190E+03	2.58440E-02	6.75940E-01	1.74690E-02	3.63800E-02
2.48200E+03	2.62220E-02	6.75990E-01	1.77260E-02	3.69150E-02
2.48210E+03	2.66140E-02	6.76080E-01	1.79930E-02	3.74710E-02
2.48220E+03	2.70190E-02	6.76190E-01	1.82700E-02	3.80480E-02
2.48230E+03	2.74390E-02	6.76290E-01	1.85570E-02	3.86450E-02
2.48240E+03	2.78730E-02	6.76390E-01	1.88530E-02	3.92620E-02
2.48250E+03	2.83220E-02	6.76500E-01	1.91600E-02	3.99010E-02
2.48260E+03	2.87870E-02	6.76600E-01	1.94770E-02	4.05610E-02
2.48270E+03	2.92660E-02	6.76700E-01	1.98040E-02	4.12420E-02
2.48280E+03	2.97600E-02	6.76810E-01	2.01420E-02	4.19450E-02
2.48290E+03	3.02690E-02	6.76910E-01	2.04890E-02	4.26690E-02
2.48300E+03	3.07940E-02	6.77010E-01	2.08480E-02	4.34160E-02
2.48310E+03	3.13340E-02	6.77120E-01	2.12170E-02	4.41840E-02
2.48320E+03	3.18890E-02	6.77220E-01	2.15960E-02	4.49740E-02
2.48330E+03	3.24590E-02	6.77290E-01	2.19840E-02	4.57830E-02

2.48340E+03	3.30450E-02	6.77360E-01	2.23830E-02	4.66130E-02
2.48350E+03	3.36450E-02	6.77440E-01	2.27920E-02	4.74650E-02
2.48360E+03	3.42600E-02	6.77510E-01	2.32110E-02	4.83380E-02
2.48370E+03	3.48890E-02	6.77580E-01	2.36400E-02	4.92310E-02
2.48380E+03	3.53390E-02	6.77650E-01	2.39480E-02	4.98710E-02
2.48390E+03	3.60380E-02	6.77720E-01	2.44230E-02	5.08620E-02
2.48400E+03	3.67310E-02	6.77790E-01	2.48950E-02	5.18450E-02
2.48410E+03	3.74180E-02	6.77830E-01	2.53630E-02	5.28180E-02
2.48420E+03	3.80990E-02	6.77860E-01	2.58260E-02	5.37830E-02
2.48430E+03	3.87760E-02	6.77900E-01	2.62860E-02	5.47420E-02
2.48440E+03	3.94490E-02	6.77940E-01	2.67440E-02	5.56950E-02
2.48450E+03	4.01200E-02	6.77980E-01	2.72000E-02	5.66450E-02
2.48460E+03	4.07900E-02	6.78010E-01	2.76560E-02	5.75940E-02
2.48470E+03	4.14610E-02	6.78050E-01	2.81130E-02	5.85450E-02
2.48480E+03	4.21370E-02	6.78090E-01	2.85720E-02	5.95020E-02
2.48490E+03	4.28180E-02	6.78130E-01	2.90360E-02	6.04680E-02
2.48500E+03	4.35090E-02	6.78170E-01	2.95060E-02	6.14470E-02
2.48510E+03	4.42110E-02	6.78190E-01	2.99830E-02	6.24410E-02
2.48520E+03	4.49270E-02	6.78210E-01	3.04700E-02	6.34540E-02
2.48530E+03	4.56590E-02	6.78230E-01	3.09670E-02	6.44900E-02
2.48540E+03	4.64090E-02	6.78260E-01	3.14770E-02	6.55520E-02
2.48550E+03	4.71800E-02	6.78250E-01	3.20000E-02	6.66400E-02
2.48560E+03	4.79720E-02	6.78240E-01	3.25370E-02	6.77580E-02
2.48570E+03	4.87870E-02	6.78240E-01	3.30890E-02	6.89090E-02
2.48580E+03	4.96260E-02	6.78230E-01	3.36580E-02	7.00930E-02
2.48590E+03	5.04890E-02	6.78220E-01	3.42430E-02	7.13110E-02
2.48600E+03	5.13760E-02	6.78220E-01	3.48440E-02	7.25640E-02
2.48610E+03	5.22870E-02	6.78210E-01	3.54610E-02	7.38490E-02
2.48620E+03	5.32210E-02	6.78190E-01	3.60940E-02	7.51660E-02
2.48630E+03	5.41750E-02	6.78180E-01	3.67400E-02	7.65120E-02
2.48640E+03	5.51500E-02	6.78160E-01	3.74010E-02	7.78870E-02
2.48650E+03	5.61420E-02	6.78150E-01	3.80730E-02	7.92870E-02
2.48660E+03	5.71500E-02	6.78140E-01	3.87560E-02	8.07090E-02
2.48670E+03	5.81720E-02	6.78120E-01	3.94480E-02	8.21500E-02
2.48680E+03	5.92040E-02	6.78110E-01	4.01470E-02	8.36060E-02
2.48690E+03	6.02450E-02	6.78090E-01	4.08520E-02	8.50750E-02
2.48700E+03	6.12930E-02	6.78080E-01	4.15610E-02	8.65520E-02
2.48710E+03	6.23440E-02	6.78070E-01	4.22740E-02	8.80350E-02
2.48720E+03	6.33970E-02	6.78050E-01	4.29870E-02	8.95210E-02
2.48730E+03	6.44510E-02	6.78040E-01	4.37010E-02	9.10070E-02
2.48740E+03	6.55040E-02	6.78030E-01	4.44140E-02	9.24920E-02
2.48750E+03	6.65550E-02	6.78020E-01	4.51250E-02	9.39730E-02
2.48760E+03	6.76030E-02	6.78000E-01	4.58350E-02	9.54520E-02

2.48770E+03	6.86490E-02	6.77960E-01	4.65410E-02	9.69220E-02
2.48780E+03	6.96920E-02	6.77920E-01	4.72460E-02	9.83900E-02
2.48790E+03	7.07350E-02	6.77880E-01	4.79500E-02	9.98560E-02
2.48800E+03	7.17790E-02	6.77830E-01	4.86540E-02	1.01320E-01
2.48810E+03	7.28260E-02	6.77770E-01	4.93600E-02	1.02790E-01
2.48820E+03	7.38780E-02	6.77710E-01	5.00680E-02	1.04270E-01
2.48830E+03	7.49390E-02	6.77650E-01	5.07830E-02	1.05760E-01
2.48840E+03	7.60120E-02	6.77590E-01	5.15050E-02	1.07260E-01
2.48850E+03	7.71010E-02	6.77530E-01	5.22380E-02	1.08790E-01
2.48860E+03	7.82090E-02	6.77470E-01	5.29850E-02	1.10340E-01
2.48870E+03	7.93410E-02	6.77410E-01	5.37470E-02	1.11930E-01
2.48880E+03	8.05010E-02	6.77350E-01	5.45280E-02	1.13550E-01
2.48890E+03	8.16930E-02	6.77300E-01	5.53300E-02	1.15230E-01
2.48900E+03	8.29210E-02	6.77240E-01	5.61570E-02	1.16950E-01
2.48910E+03	8.41880E-02	6.77180E-01	5.70100E-02	1.18720E-01
2.48920E+03	8.54990E-02	6.77120E-01	5.78930E-02	1.20560E-01
2.48930E+03	8.68570E-02	6.77060E-01	5.88070E-02	1.22470E-01
2.48940E+03	8.82630E-02	6.77000E-01	5.97540E-02	1.24440E-01
2.48950E+03	8.97210E-02	6.76940E-01	6.07360E-02	1.26480E-01
2.48960E+03	9.12310E-02	6.76880E-01	6.17530E-02	1.28600E-01
2.48970E+03	9.27940E-02	6.76830E-01	6.28060E-02	1.30790E-01
2.48980E+03	9.44120E-02	6.76770E-01	6.38950E-02	1.33060E-01
2.48990E+03	9.60830E-02	6.76760E-01	6.50240E-02	1.35410E-01
2.49000E+03	9.78060E-02	6.76750E-01	6.61900E-02	1.37840E-01
2.49010E+03	9.95800E-02	6.76720E-01	6.73880E-02	1.40340E-01
2.49020E+03	1.01400E-01	6.76700E-01	6.86200E-02	1.42900E-01
2.49030E+03	1.03270E-01	6.76680E-01	6.98820E-02	1.45530E-01
2.49040E+03	1.05180E-01	6.76660E-01	7.11730E-02	1.48220E-01
2.49050E+03	1.07130E-01	6.76640E-01	7.24910E-02	1.50960E-01
2.49060E+03	1.09120E-01	6.76620E-01	7.38330E-02	1.53760E-01
2.49070E+03	1.11140E-01	6.76600E-01	7.51960E-02	1.56600E-01
2.49080E+03	1.13180E-01	6.76580E-01	7.65770E-02	1.59470E-01
2.49090E+03	1.15250E-01	6.76560E-01	7.79740E-02	1.62380E-01
2.49100E+03	1.17340E-01	6.76530E-01	7.93830E-02	1.65320E-01
2.49110E+03	1.19440E-01	6.76520E-01	8.08030E-02	1.68270E-01
2.49120E+03	1.21550E-01	6.76500E-01	8.22310E-02	1.71250E-01
2.49130E+03	1.23680E-01	6.76480E-01	8.36650E-02	1.74230E-01
2.49140E+03	1.25810E-01	6.76460E-01	8.51020E-02	1.77230E-01
2.49150E+03	1.27940E-01	6.76440E-01	8.65410E-02	1.80220E-01
2.49160E+03	1.30070E-01	6.76420E-01	8.79820E-02	1.83220E-01
2.49170E+03	1.32200E-01	6.76400E-01	8.94220E-02	1.86220E-01
2.49180E+03	1.34340E-01	6.76390E-01	9.08630E-02	1.89220E-01
2.49190E+03	1.36470E-01	6.76370E-01	9.23030E-02	1.92220E-01

2.49200E+03	1.38600E-01	6.76350E-01	9.37440E-02	1.95220E-01
2.49210E+03	1.40740E-01	6.76420E-01	9.51990E-02	1.98250E-01
2.49220E+03	1.42880E-01	6.76510E-01	9.66580E-02	2.01290E-01
2.49230E+03	1.45020E-01	6.76590E-01	9.81220E-02	2.04340E-01
2.49240E+03	1.47180E-01	6.76670E-01	9.95910E-02	2.07400E-01
2.49250E+03	1.49340E-01	6.76750E-01	1.01070E-01	2.10480E-01
2.49260E+03	1.51530E-01	6.76830E-01	1.02560E-01	2.13580E-01
2.49270E+03	1.53730E-01	6.76900E-01	1.04060E-01	2.16700E-01
2.49280E+03	1.55950E-01	6.76980E-01	1.05580E-01	2.19860E-01
2.49290E+03	1.58200E-01	6.77060E-01	1.07110E-01	2.23060E-01
2.49300E+03	1.60480E-01	6.77130E-01	1.08670E-01	2.26300E-01
2.49310E+03	1.62790E-01	6.77210E-01	1.10240E-01	2.29580E-01
2.49320E+03	1.65140E-01	6.77290E-01	1.11850E-01	2.32920E-01
2.49330E+03	1.67530E-01	6.77370E-01	1.13480E-01	2.36320E-01
2.49340E+03	1.69960E-01	6.77450E-01	1.15140E-01	2.39770E-01
2.49350E+03	1.72430E-01	6.77520E-01	1.16820E-01	2.43290E-01
2.49360E+03	1.74940E-01	6.77600E-01	1.18540E-01	2.46870E-01
2.49370E+03	1.77510E-01	6.77680E-01	1.20290E-01	2.50510E-01
2.49380E+03	1.80120E-01	6.77760E-01	1.22080E-01	2.54230E-01
2.49390E+03	1.82780E-01	6.77840E-01	1.23890E-01	2.58010E-01
2.49400E+03	1.85480E-01	6.77920E-01	1.25740E-01	2.61850E-01
2.49410E+03	1.88220E-01	6.77950E-01	1.27610E-01	2.65740E-01
2.49420E+03	1.91010E-01	6.77980E-01	1.29500E-01	2.69690E-01
2.49430E+03	1.93840E-01	6.78050E-01	1.31430E-01	2.73710E-01
2.49440E+03	1.96710E-01	6.78120E-01	1.33390E-01	2.77790E-01
2.49450E+03	1.99610E-01	6.78190E-01	1.35380E-01	2.81920E-01
2.49460E+03	2.02550E-01	6.78270E-01	1.37380E-01	2.86100E-01
2.49470E+03	2.05510E-01	6.78340E-01	1.39410E-01	2.90320E-01
2.49480E+03	2.08500E-01	6.78410E-01	1.41450E-01	2.94570E-01
2.49490E+03	2.11510E-01	6.78490E-01	1.43510E-01	2.98860E-01
2.49500E+03	2.14540E-01	6.78560E-01	1.45580E-01	3.03170E-01
2.49510E+03	2.17590E-01	6.78580E-01	1.47650E-01	3.07490E-01
2.49520E+03	2.20650E-01	6.78610E-01	1.49730E-01	3.11820E-01
2.49530E+03	2.23720E-01	6.78640E-01	1.51820E-01	3.16170E-01
2.49540E+03	2.26790E-01	6.78660E-01	1.53910E-01	3.20530E-01
2.49550E+03	2.29870E-01	6.78690E-01	1.56010E-01	3.24890E-01
2.49560E+03	2.32950E-01	6.78710E-01	1.58110E-01	3.29260E-01
2.49570E+03	2.36040E-01	6.78740E-01	1.60210E-01	3.33630E-01
2.49580E+03	2.39120E-01	6.78760E-01	1.62310E-01	3.38010E-01
2.49590E+03	2.42200E-01	6.78790E-01	1.64410E-01	3.42380E-01
2.49600E+03	2.45290E-01	6.78820E-01	1.66500E-01	3.46740E-01
2.49610E+03	2.48360E-01	6.78860E-01	1.68610E-01	3.51120E-01
2.49620E+03	2.51440E-01	6.78920E-01	1.70710E-01	3.55500E-01

2.49630E+03	2.54520E-01	6.78960E-01	1.72810E-01	3.59880E-01
2.49640E+03	2.57600E-01	6.79010E-01	1.74910E-01	3.64250E-01
2.49650E+03	2.60670E-01	6.78950E-01	1.76980E-01	3.68570E-01
2.49660E+03	2.63750E-01	6.78900E-01	1.79060E-01	3.72890E-01
2.49670E+03	2.66820E-01	6.78850E-01	1.81130E-01	3.77210E-01
2.49680E+03	2.69900E-01	6.78800E-01	1.83210E-01	3.81540E-01
2.49690E+03	2.72980E-01	6.78750E-01	1.85290E-01	3.85860E-01
2.49700E+03	2.76070E-01	6.78700E-01	1.87370E-01	3.90200E-01
2.49710E+03	2.79160E-01	6.78650E-01	1.89450E-01	3.94530E-01
2.49720E+03	2.82250E-01	6.78590E-01	1.91540E-01	3.98880E-01
2.49730E+03	2.85350E-01	6.78540E-01	1.93620E-01	4.03220E-01
2.49740E+03	2.88460E-01	6.78490E-01	1.95720E-01	4.07580E-01
2.49750E+03	2.91570E-01	6.78430E-01	1.97810E-01	4.11940E-01
2.49760E+03	2.94690E-01	6.78380E-01	1.99910E-01	4.16310E-01
2.49770E+03	2.97810E-01	6.78330E-01	2.02010E-01	4.20690E-01
2.49780E+03	3.00930E-01	6.78270E-01	2.04120E-01	4.25070E-01
2.49790E+03	3.04060E-01	6.78220E-01	2.06220E-01	4.29460E-01
2.49800E+03	3.07200E-01	6.78170E-01	2.08330E-01	4.33850E-01
2.49810E+03	3.10330E-01	6.78170E-01	2.10460E-01	4.38280E-01
2.49820E+03	3.13470E-01	6.78170E-01	2.12590E-01	4.42710E-01
2.49830E+03	3.16610E-01	6.78170E-01	2.14710E-01	4.47140E-01
2.49840E+03	3.19750E-01	6.78170E-01	2.16840E-01	4.51570E-01
2.49850E+03	3.22880E-01	6.78170E-01	2.18970E-01	4.56000E-01
2.49860E+03	3.26020E-01	6.78170E-01	2.21090E-01	4.60430E-01
2.49870E+03	3.29150E-01	6.78060E-01	2.23180E-01	4.64780E-01
2.49880E+03	3.32280E-01	6.77950E-01	2.25270E-01	4.69130E-01
2.49890E+03	3.35400E-01	6.77850E-01	2.27350E-01	4.73470E-01
2.49900E+03	3.38530E-01	6.77740E-01	2.29430E-01	4.77800E-01
2.49910E+03	3.41650E-01	6.77630E-01	2.31510E-01	4.82120E-01
2.49920E+03	3.44760E-01	6.77530E-01	2.33590E-01	4.86440E-01
2.49930E+03	3.47870E-01	6.77420E-01	2.35660E-01	4.90760E-01
2.49940E+03	3.50980E-01	6.77310E-01	2.37730E-01	4.95070E-01
2.49950E+03	3.54090E-01	6.77210E-01	2.39790E-01	4.99370E-01
2.49960E+03	3.57190E-01	6.77100E-01	2.41860E-01	5.03670E-01
2.49970E+03	3.60300E-01	6.76990E-01	2.43920E-01	5.07970E-01
2.49980E+03	3.63400E-01	6.76890E-01	2.45980E-01	5.12260E-01
2.49990E+03	3.66500E-01	6.76780E-01	2.48040E-01	5.16550E-01
2.50000E+03	3.69610E-01	6.76680E-01	2.50110E-01	5.20850E-01
2.50010E+03	3.72710E-01	6.76530E-01	2.52150E-01	5.25110E-01
2.50020E+03	3.75820E-01	6.76390E-01	2.54200E-01	5.29380E-01
2.50030E+03	3.78930E-01	6.76250E-01	2.56250E-01	5.33640E-01
2.50040E+03	3.82040E-01	6.76110E-01	2.58300E-01	5.37910E-01
2.50050E+03	3.85150E-01	6.75970E-01	2.60350E-01	5.42180E-01

2.50060E+03	3.88270E-01	6.75820E-01	2.62400E-01	5.46450E-01
2.50070E+03	3.91380E-01	6.75680E-01	2.64450E-01	5.50720E-01
2.50080E+03	3.94500E-01	6.75540E-01	2.66500E-01	5.54980E-01
2.50090E+03	3.97610E-01	6.75520E-01	2.68590E-01	5.59350E-01
2.50100E+03	4.00720E-01	6.75500E-01	2.70690E-01	5.63710E-01
2.50110E+03	4.03830E-01	6.75480E-01	2.72780E-01	5.68070E-01
2.50120E+03	4.06930E-01	6.75460E-01	2.74870E-01	5.72420E-01
2.50130E+03	4.10030E-01	6.75440E-01	2.76950E-01	5.76760E-01
2.50140E+03	4.13120E-01	6.75420E-01	2.79030E-01	5.81080E-01
2.50150E+03	4.16200E-01	6.75400E-01	2.81100E-01	5.85390E-01
2.50160E+03	4.19260E-01	6.75380E-01	2.83160E-01	5.89690E-01
2.50170E+03	4.22320E-01	6.75340E-01	2.85210E-01	5.93950E-01
2.50180E+03	4.25350E-01	6.75310E-01	2.87240E-01	5.98180E-01
2.50190E+03	4.28370E-01	6.75270E-01	2.89260E-01	6.02400E-01
2.50200E+03	4.31370E-01	6.75230E-01	2.91270E-01	6.06580E-01
2.50210E+03	4.34350E-01	6.75190E-01	2.93270E-01	6.10740E-01
2.50220E+03	4.37300E-01	6.75160E-01	2.95250E-01	6.14860E-01
2.50230E+03	4.40240E-01	6.75120E-01	2.97210E-01	6.18950E-01
2.50240E+03	4.43150E-01	6.75080E-01	2.99160E-01	6.23010E-01
2.50250E+03	4.46040E-01	6.75050E-01	3.01100E-01	6.27040E-01
2.50260E+03	4.48900E-01	6.75010E-01	3.03010E-01	6.31030E-01
2.50270E+03	4.51740E-01	6.74970E-01	3.04910E-01	6.34990E-01
2.50280E+03	4.54560E-01	6.74940E-01	3.06800E-01	6.38910E-01
2.50290E+03	4.57350E-01	6.74900E-01	3.08670E-01	6.42810E-01
2.50300E+03	4.60130E-01	6.74870E-01	3.10520E-01	6.46670E-01
2.50310E+03	4.62880E-01	6.74870E-01	3.12380E-01	6.50540E-01
2.50320E+03	4.65620E-01	6.74870E-01	3.14230E-01	6.54390E-01
2.50330E+03	4.68340E-01	6.74870E-01	3.16060E-01	6.58210E-01
2.50340E+03	4.71040E-01	6.74870E-01	3.17890E-01	6.62010E-01
2.50350E+03	4.73730E-01	6.74870E-01	3.19700E-01	6.65790E-01
2.50360E+03	4.76400E-01	6.74870E-01	3.21510E-01	6.69550E-01
2.50370E+03	4.79070E-01	6.74870E-01	3.23310E-01	6.73300E-01
2.50380E+03	4.81730E-01	6.74870E-01	3.25100E-01	6.77030E-01
2.50390E+03	4.84370E-01	6.74880E-01	3.26890E-01	6.80760E-01
2.50400E+03	4.87020E-01	6.74880E-01	3.28680E-01	6.84470E-01
2.50410E+03	4.89650E-01	6.74880E-01	3.30450E-01	6.88170E-01
2.50420E+03	4.92280E-01	6.74870E-01	3.32230E-01	6.91870E-01
2.50430E+03	4.94910E-01	6.74870E-01	3.34000E-01	6.95560E-01
2.50440E+03	4.97530E-01	6.74870E-01	3.35770E-01	6.99250E-01
2.50450E+03	5.00160E-01	6.74870E-01	3.37540E-01	7.02930E-01
2.50460E+03	5.02770E-01	6.74870E-01	3.39300E-01	7.06610E-01
2.50470E+03	5.05390E-01	6.74860E-01	3.41070E-01	7.10280E-01
2.50480E+03	5.08000E-01	6.74860E-01	3.42830E-01	7.13940E-01

2.50490E+03	5.10600E-01	6.74860E-01	3.44580E-01	7.17600E-01
2.50500E+03	5.13200E-01	6.74860E-01	3.46340E-01	7.21250E-01
2.50510E+03	5.15790E-01	6.74900E-01	3.48110E-01	7.24940E-01
2.50520E+03	5.18380E-01	6.74940E-01	3.49870E-01	7.28620E-01
2.50530E+03	5.20960E-01	6.74900E-01	3.51600E-01	7.32200E-01
2.50540E+03	5.23540E-01	6.74860E-01	3.53310E-01	7.35780E-01
2.50550E+03	5.26100E-01	6.74820E-01	3.55020E-01	7.39330E-01
2.50560E+03	5.28650E-01	6.74780E-01	3.56720E-01	7.42880E-01
2.50570E+03	5.31200E-01	6.74740E-01	3.58420E-01	7.46410E-01
2.50580E+03	5.33730E-01	6.74700E-01	3.60110E-01	7.49930E-01
2.50590E+03	5.36260E-01	6.74660E-01	3.61790E-01	7.53430E-01
2.50600E+03	5.38770E-01	6.74620E-01	3.63470E-01	7.56920E-01
2.50610E+03	5.41280E-01	6.74670E-01	3.65180E-01	7.60490E-01
2.50620E+03	5.43770E-01	6.74720E-01	3.66890E-01	7.64060E-01
2.50630E+03	5.46260E-01	6.74770E-01	3.68600E-01	7.67620E-01
2.50640E+03	5.48740E-01	6.74830E-01	3.70300E-01	7.71160E-01
2.50650E+03	5.51210E-01	6.74880E-01	3.72000E-01	7.74700E-01
2.50660E+03	5.53670E-01	6.74930E-01	3.73690E-01	7.78220E-01
2.50670E+03	5.56130E-01	6.74990E-01	3.75380E-01	7.81740E-01
2.50680E+03	5.58590E-01	6.75040E-01	3.77070E-01	7.85260E-01
2.50690E+03	5.61040E-01	6.75100E-01	3.78760E-01	7.88760E-01
2.50700E+03	5.63490E-01	6.75150E-01	3.80440E-01	7.92270E-01
2.50710E+03	5.65940E-01	6.75200E-01	3.82120E-01	7.95770E-01
2.50720E+03	5.68380E-01	6.75240E-01	3.83800E-01	7.99260E-01
2.50730E+03	5.70830E-01	6.75290E-01	3.85470E-01	8.02750E-01
2.50740E+03	5.73270E-01	6.75330E-01	3.87150E-01	8.06240E-01
2.50750E+03	5.75710E-01	6.75400E-01	3.88830E-01	8.09750E-01
2.50760E+03	5.78150E-01	6.75470E-01	3.90520E-01	8.13260E-01
2.50770E+03	5.80590E-01	6.75530E-01	3.92200E-01	8.16770E-01
2.50780E+03	5.83020E-01	6.75600E-01	3.93890E-01	8.20270E-01
2.50790E+03	5.85450E-01	6.75660E-01	3.95560E-01	8.23770E-01
2.50800E+03	5.87870E-01	6.75730E-01	3.97240E-01	8.27250E-01
2.50810E+03	5.90280E-01	6.75720E-01	3.98860E-01	8.30640E-01
2.50820E+03	5.92680E-01	6.75680E-01	4.00460E-01	8.33970E-01
2.50830E+03	5.95070E-01	6.75640E-01	4.02050E-01	8.37280E-01
2.50840E+03	5.97440E-01	6.75600E-01	4.03630E-01	8.40570E-01
2.50850E+03	5.99790E-01	6.75560E-01	4.05200E-01	8.43830E-01
2.50860E+03	6.02130E-01	6.75520E-01	4.06750E-01	8.47060E-01
2.50870E+03	6.04440E-01	6.75480E-01	4.08290E-01	8.50260E-01
2.50880E+03	6.06720E-01	6.75440E-01	4.09810E-01	8.53430E-01
2.50890E+03	6.08980E-01	6.75400E-01	4.11310E-01	8.56550E-01
2.50900E+03	6.11210E-01	6.75360E-01	4.12790E-01	8.59640E-01
2.50910E+03	6.13410E-01	6.75320E-01	4.14250E-01	8.62670E-01

2.50920E+03	6.15580E-01	6.75270E-01	4.15680E-01	8.65660E-01
2.50930E+03	6.17710E-01	6.75230E-01	4.17100E-01	8.68610E-01
2.50940E+03	6.19810E-01	6.75190E-01	4.18490E-01	8.71500E-01
2.50950E+03	6.21870E-01	6.75150E-01	4.19850E-01	8.74350E-01
2.50960E+03	6.23900E-01	6.75100E-01	4.21200E-01	8.77150E-01
2.50970E+03	6.25900E-01	6.75040E-01	4.22510E-01	8.79880E-01
2.50980E+03	6.27860E-01	6.74990E-01	4.23800E-01	8.82560E-01
2.50990E+03	6.29790E-01	6.74930E-01	4.25060E-01	8.85200E-01
2.51000E+03	6.31690E-01	6.74860E-01	4.26310E-01	8.87790E-01
2.51010E+03	6.33570E-01	6.74750E-01	4.27500E-01	8.90280E-01
2.51020E+03	6.35420E-01	6.74640E-01	4.28680E-01	8.92730E-01
2.51030E+03	6.37240E-01	6.74530E-01	4.29840E-01	8.95140E-01
2.51040E+03	6.39050E-01	6.74420E-01	4.30990E-01	8.97530E-01
2.51050E+03	6.40830E-01	6.74310E-01	4.32120E-01	8.99890E-01
2.51060E+03	6.42600E-01	6.74200E-01	4.33240E-01	9.02230E-01
2.51070E+03	6.44360E-01	6.74080E-01	4.34350E-01	9.04550E-01
2.51080E+03	6.46100E-01	6.73970E-01	4.35460E-01	9.06840E-01
2.51090E+03	6.47840E-01	6.73860E-01	4.36550E-01	9.09130E-01
2.51100E+03	6.49560E-01	6.73750E-01	4.37650E-01	9.11400E-01
2.51110E+03	6.51280E-01	6.73640E-01	4.38730E-01	9.13670E-01
2.51120E+03	6.53000E-01	6.73530E-01	4.39810E-01	9.15920E-01
2.51130E+03	6.54700E-01	6.73420E-01	4.40890E-01	9.18160E-01
2.51140E+03	6.56400E-01	6.73310E-01	4.41970E-01	9.20400E-01
2.51150E+03	6.58100E-01	6.73200E-01	4.43040E-01	9.22630E-01
2.51160E+03	6.59790E-01	6.73090E-01	4.44100E-01	9.24840E-01
2.51170E+03	6.61470E-01	6.72980E-01	4.45160E-01	9.27050E-01
2.51180E+03	6.63140E-01	6.72870E-01	4.46210E-01	9.29230E-01
2.51190E+03	6.64800E-01	6.72830E-01	4.47300E-01	9.31500E-01
2.51200E+03	6.66440E-01	6.72800E-01	4.48380E-01	9.33760E-01
2.51210E+03	6.68070E-01	6.72880E-01	4.49530E-01	9.36140E-01
2.51220E+03	6.69670E-01	6.72950E-01	4.50660E-01	9.38500E-01
2.51230E+03	6.71260E-01	6.73020E-01	4.51770E-01	9.40820E-01
2.51240E+03	6.72820E-01	6.73090E-01	4.52870E-01	9.43110E-01
2.51250E+03	6.74350E-01	6.73170E-01	4.53950E-01	9.45360E-01
2.51260E+03	6.75850E-01	6.73240E-01	4.55010E-01	9.47560E-01
2.51270E+03	6.77320E-01	6.73310E-01	4.56050E-01	9.49720E-01
2.51280E+03	6.78750E-01	6.73380E-01	4.57060E-01	9.51840E-01
2.51290E+03	6.80150E-01	6.73460E-01	4.58050E-01	9.53900E-01
2.51300E+03	6.81510E-01	6.73530E-01	4.59020E-01	9.55910E-01
2.51310E+03	6.82830E-01	6.73600E-01	4.59950E-01	9.57860E-01
2.51320E+03	6.84100E-01	6.73680E-01	4.60870E-01	9.59760E-01
2.51330E+03	6.85340E-01	6.73750E-01	4.61750E-01	9.61600E-01
2.51340E+03	6.86540E-01	6.73830E-01	4.62610E-01	9.63400E-01

2.51350E+03	6.87700E-01	6.73900E-01	4.63450E-01	9.65130E-01
2.51360E+03	6.88830E-01	6.73980E-01	4.64260E-01	9.66820E-01
2.51370E+03	6.89920E-01	6.74050E-01	4.65040E-01	9.68450E-01
2.51380E+03	6.90970E-01	6.74130E-01	4.65810E-01	9.70040E-01
2.51390E+03	6.92000E-01	6.74210E-01	4.66550E-01	9.71590E-01
2.51400E+03	6.92990E-01	6.74280E-01	4.67270E-01	9.73100E-01
2.51410E+03	6.93960E-01	6.74310E-01	4.67950E-01	9.74500E-01
2.51420E+03	6.94910E-01	6.74320E-01	4.68590E-01	9.75840E-01
2.51430E+03	6.95830E-01	6.74320E-01	4.69220E-01	9.77150E-01
2.51440E+03	6.96740E-01	6.74330E-01	4.69830E-01	9.78430E-01
2.51450E+03	6.97640E-01	6.74330E-01	4.70440E-01	9.79690E-01
2.51460E+03	6.98510E-01	6.74330E-01	4.71030E-01	9.80930E-01
2.51470E+03	6.99380E-01	6.74340E-01	4.71620E-01	9.82160E-01
2.51480E+03	7.00240E-01	6.74340E-01	4.72200E-01	9.83370E-01
2.51490E+03	7.01090E-01	6.74350E-01	4.72780E-01	9.84560E-01
2.51500E+03	7.01920E-01	6.74350E-01	4.73340E-01	9.85740E-01
2.51510E+03	7.02750E-01	6.74340E-01	4.73890E-01	9.86890E-01
2.51520E+03	7.03570E-01	6.74330E-01	4.74430E-01	9.88010E-01
2.51530E+03	7.04370E-01	6.74310E-01	4.74970E-01	9.89130E-01
2.51540E+03	7.05170E-01	6.74300E-01	4.75490E-01	9.90220E-01
2.51550E+03	7.05940E-01	6.74280E-01	4.76000E-01	9.91280E-01
2.51560E+03	7.06690E-01	6.74270E-01	4.76500E-01	9.92320E-01
2.51570E+03	7.07430E-01	6.74260E-01	4.76990E-01	9.93330E-01
2.51580E+03	7.08130E-01	6.74240E-01	4.77450E-01	9.94300E-01
2.51590E+03	7.08810E-01	6.74230E-01	4.77900E-01	9.95230E-01
2.51600E+03	7.09450E-01	6.74220E-01	4.78320E-01	9.96110E-01
2.51610E+03	7.10050E-01	6.74230E-01	4.78740E-01	9.96980E-01
2.51620E+03	7.10610E-01	6.74250E-01	4.79120E-01	9.97780E-01
2.51630E+03	7.11120E-01	6.74140E-01	4.79390E-01	9.98330E-01
2.51640E+03	7.11580E-01	6.74030E-01	4.79620E-01	9.98820E-01
2.51650E+03	7.11980E-01	6.73920E-01	4.79820E-01	9.99220E-01
2.51660E+03	7.12330E-01	6.73810E-01	4.79970E-01	9.99550E-01
2.51670E+03	7.12620E-01	6.73700E-01	4.80090E-01	9.99790E-01
2.51680E+03	7.12840E-01	6.73590E-01	4.80160E-01	9.99940E-01
2.51690E+03	7.13000E-01	6.73480E-01	4.80190E-01	1.00000E+00
2.51700E+03	7.13100E-01	6.73370E-01	4.80180E-01	9.99970E-01
2.51710E+03	7.13120E-01	6.73260E-01	4.80120E-01	9.99850E-01
2.51720E+03	7.13090E-01	6.73150E-01	4.80020E-01	9.99640E-01
2.51730E+03	7.12990E-01	6.73050E-01	4.79870E-01	9.99340E-01
2.51740E+03	7.12820E-01	6.72940E-01	4.79690E-01	9.98960E-01
2.51750E+03	7.12600E-01	6.72830E-01	4.79460E-01	9.98480E-01
2.51760E+03	7.12320E-01	6.72730E-01	4.79190E-01	9.97930E-01
2.51770E+03	7.11980E-01	6.72620E-01	4.78890E-01	9.97300E-01

2.51780E+03	7.11590E-01	6.72510E-01	4.78560E-01	9.96600E-01
2.51790E+03	7.11160E-01	6.72410E-01	4.78190E-01	9.95830E-01
2.51800E+03	7.10680E-01	6.72300E-01	4.77790E-01	9.95010E-01
2.51810E+03	7.10170E-01	6.72290E-01	4.77440E-01	9.94270E-01
2.51820E+03	7.09620E-01	6.72280E-01	4.77060E-01	9.93480E-01
2.51830E+03	7.09030E-01	6.72270E-01	4.76660E-01	9.92650E-01
2.51840E+03	7.08430E-01	6.72250E-01	4.76240E-01	9.91780E-01
2.51850E+03	7.07800E-01	6.72170E-01	4.75760E-01	9.90770E-01
2.51860E+03	7.07150E-01	6.72080E-01	4.75260E-01	9.89740E-01
2.51870E+03	7.06480E-01	6.72000E-01	4.74760E-01	9.88680E-01
2.51880E+03	7.05800E-01	6.71910E-01	4.74240E-01	9.87610E-01
2.51890E+03	7.05110E-01	6.71830E-01	4.73720E-01	9.86520E-01
2.51900E+03	7.04410E-01	6.71740E-01	4.73190E-01	9.85410E-01
2.51910E+03	7.03700E-01	6.71660E-01	4.72650E-01	9.84300E-01
2.51920E+03	7.02980E-01	6.71580E-01	4.72110E-01	9.83180E-01
2.51930E+03	7.02260E-01	6.71500E-01	4.71560E-01	9.82040E-01
2.51940E+03	7.01520E-01	6.71410E-01	4.71010E-01	9.80880E-01
2.51950E+03	7.00770E-01	6.71330E-01	4.70450E-01	9.79720E-01
2.51960E+03	7.00010E-01	6.71250E-01	4.69880E-01	9.78530E-01
2.51970E+03	6.99230E-01	6.71170E-01	4.69300E-01	9.77320E-01
2.51980E+03	6.98430E-01	6.71080E-01	4.68710E-01	9.76090E-01
2.51990E+03	6.97620E-01	6.71000E-01	4.68100E-01	9.74830E-01
2.52000E+03	6.96780E-01	6.70900E-01	4.67470E-01	9.73510E-01
2.52010E+03	6.95910E-01	6.70750E-01	4.66780E-01	9.72080E-01
2.52020E+03	6.95010E-01	6.70600E-01	4.66070E-01	9.70600E-01
2.52030E+03	6.94080E-01	6.70450E-01	4.65340E-01	9.69080E-01
2.52040E+03	6.93110E-01	6.70300E-01	4.64590E-01	9.67510E-01
2.52050E+03	6.92100E-01	6.70140E-01	4.63810E-01	9.65880E-01
2.52060E+03	6.91050E-01	6.69990E-01	4.63000E-01	9.64200E-01
2.52070E+03	6.89960E-01	6.69880E-01	4.62190E-01	9.62520E-01
2.52080E+03	6.88820E-01	6.69770E-01	4.61350E-01	9.60770E-01
2.52090E+03	6.87630E-01	6.69660E-01	4.60480E-01	9.58950E-01
2.52100E+03	6.86400E-01	6.69550E-01	4.59580E-01	9.57070E-01
2.52110E+03	6.85110E-01	6.69440E-01	4.58640E-01	9.55120E-01
2.52120E+03	6.83780E-01	6.69320E-01	4.57670E-01	9.53100E-01
2.52130E+03	6.82400E-01	6.69210E-01	4.56660E-01	9.51010E-01
2.52140E+03	6.80970E-01	6.69090E-01	4.55630E-01	9.48860E-01
2.52150E+03	6.79490E-01	6.68980E-01	4.54570E-01	9.46640E-01
2.52160E+03	6.77970E-01	6.68860E-01	4.53470E-01	9.44360E-01
2.52170E+03	6.76410E-01	6.68750E-01	4.52350E-01	9.42020E-01
2.52180E+03	6.74800E-01	6.68630E-01	4.51200E-01	9.39620E-01
2.52190E+03	6.73160E-01	6.68520E-01	4.50020E-01	9.37170E-01
2.52200E+03	6.71470E-01	6.68410E-01	4.48820E-01	9.34670E-01

2.52210E+03	6.69760E-01	6.68300E-01	4.47600E-01	9.32130E-01
2.52220E+03	6.68010E-01	6.68190E-01	4.46360E-01	9.29550E-01
2.52230E+03	6.66230E-01	6.68080E-01	4.45100E-01	9.26920E-01
2.52240E+03	6.64430E-01	6.67980E-01	4.43820E-01	9.24260E-01
2.52250E+03	6.62590E-01	6.67870E-01	4.42530E-01	9.21570E-01
2.52260E+03	6.60740E-01	6.67760E-01	4.41220E-01	9.18840E-01
2.52270E+03	6.58860E-01	6.67660E-01	4.39890E-01	9.16080E-01
2.52280E+03	6.56960E-01	6.67550E-01	4.38560E-01	9.13300E-01
2.52290E+03	6.55040E-01	6.67530E-01	4.37260E-01	9.10610E-01
2.52300E+03	6.53100E-01	6.67520E-01	4.35960E-01	9.07890E-01
2.52310E+03	6.51140E-01	6.67500E-01	4.34640E-01	9.05140E-01
2.52320E+03	6.49170E-01	6.67480E-01	4.33310E-01	9.02370E-01
2.52330E+03	6.47170E-01	6.67470E-01	4.31960E-01	8.99570E-01
2.52340E+03	6.45150E-01	6.67450E-01	4.30600E-01	8.96740E-01
2.52350E+03	6.43110E-01	6.67430E-01	4.29230E-01	8.93880E-01
2.52360E+03	6.41050E-01	6.67410E-01	4.27850E-01	8.90990E-01
2.52370E+03	6.38970E-01	6.67400E-01	4.26440E-01	8.88070E-01
2.52380E+03	6.36860E-01	6.67380E-01	4.25030E-01	8.85120E-01
2.52390E+03	6.34720E-01	6.67360E-01	4.23590E-01	8.82130E-01
2.52400E+03	6.32560E-01	6.67350E-01	4.22140E-01	8.79120E-01
2.52410E+03	6.30380E-01	6.67370E-01	4.20690E-01	8.76100E-01
2.52420E+03	6.28160E-01	6.67380E-01	4.19220E-01	8.73040E-01
2.52430E+03	6.25910E-01	6.67400E-01	4.17730E-01	8.69940E-01
2.52440E+03	6.23640E-01	6.67410E-01	4.16220E-01	8.66790E-01
2.52450E+03	6.21330E-01	6.67430E-01	4.14690E-01	8.63600E-01
2.52460E+03	6.18990E-01	6.67450E-01	4.13140E-01	8.60370E-01
2.52470E+03	6.16610E-01	6.67460E-01	4.11570E-01	8.57090E-01
2.52480E+03	6.14210E-01	6.67480E-01	4.09970E-01	8.53760E-01
2.52490E+03	6.11770E-01	6.67490E-01	4.08350E-01	8.50390E-01
2.52500E+03	6.09290E-01	6.67510E-01	4.06710E-01	8.46970E-01
2.52510E+03	6.06780E-01	6.67560E-01	4.05070E-01	8.43550E-01
2.52520E+03	6.04240E-01	6.67620E-01	4.03400E-01	8.40090E-01
2.52530E+03	6.01670E-01	6.67670E-01	4.01720E-01	8.36580E-01
2.52540E+03	5.99070E-01	6.67720E-01	4.00010E-01	8.33030E-01
2.52550E+03	5.96430E-01	6.67810E-01	3.98300E-01	8.29460E-01
2.52560E+03	5.93760E-01	6.67930E-01	3.96590E-01	8.25900E-01
2.52570E+03	5.91060E-01	6.68060E-01	3.94860E-01	8.22300E-01
2.52580E+03	5.88330E-01	6.68180E-01	3.93110E-01	8.18650E-01
2.52590E+03	5.85570E-01	6.68300E-01	3.91340E-01	8.14960E-01
2.52600E+03	5.82770E-01	6.68430E-01	3.89540E-01	8.11230E-01
2.52610E+03	5.79950E-01	6.68550E-01	3.87730E-01	8.07440E-01
2.52620E+03	5.77090E-01	6.68680E-01	3.85890E-01	8.03610E-01
2.52630E+03	5.74200E-01	6.68800E-01	3.84030E-01	7.99740E-01

2.52640E+03	5.71280E-01	6.68930E-01	3.82140E-01	7.95820E-01
2.52650E+03	5.68320E-01	6.69050E-01	3.80240E-01	7.91850E-01
2.52660E+03	5.65330E-01	6.69180E-01	3.78310E-01	7.87830E-01
2.52670E+03	5.62310E-01	6.69300E-01	3.76350E-01	7.83760E-01
2.52680E+03	5.59250E-01	6.69430E-01	3.74380E-01	7.79640E-01
2.52690E+03	5.56150E-01	6.69550E-01	3.72370E-01	7.75470E-01
2.52700E+03	5.53010E-01	6.69670E-01	3.70340E-01	7.71240E-01
2.52710E+03	5.49840E-01	6.69810E-01	3.68280E-01	7.66960E-01
2.52720E+03	5.46620E-01	6.69940E-01	3.66200E-01	7.62620E-01
2.52730E+03	5.43360E-01	6.69980E-01	3.64040E-01	7.58120E-01
2.52740E+03	5.40060E-01	6.70030E-01	3.61860E-01	7.53570E-01
2.52750E+03	5.36710E-01	6.70080E-01	3.59640E-01	7.48950E-01
2.52760E+03	5.33330E-01	6.70120E-01	3.57400E-01	7.44280E-01
2.52770E+03	5.29900E-01	6.70170E-01	3.55120E-01	7.39540E-01
2.52780E+03	5.26420E-01	6.70210E-01	3.52820E-01	7.34740E-01
2.52790E+03	5.22910E-01	6.70260E-01	3.50480E-01	7.29890E-01
2.52800E+03	5.19350E-01	6.70310E-01	3.48120E-01	7.24970E-01
2.52810E+03	5.15750E-01	6.70410E-01	3.45760E-01	7.20060E-01
2.52820E+03	5.12110E-01	6.70520E-01	3.43380E-01	7.15090E-01
2.52830E+03	5.08430E-01	6.70620E-01	3.40970E-01	7.10070E-01
2.52840E+03	5.04720E-01	6.70730E-01	3.38530E-01	7.04990E-01
2.52850E+03	5.00970E-01	6.70830E-01	3.36070E-01	6.99870E-01
2.52860E+03	4.97200E-01	6.70940E-01	3.33590E-01	6.94700E-01
2.52870E+03	4.93390E-01	6.71040E-01	3.31090E-01	6.89490E-01
2.52880E+03	4.89560E-01	6.71150E-01	3.28570E-01	6.84240E-01
2.52890E+03	4.85700E-01	6.71250E-01	3.26030E-01	6.78960E-01
2.52900E+03	4.81820E-01	6.71360E-01	3.23480E-01	6.73640E-01
2.52910E+03	4.77930E-01	6.71460E-01	3.20910E-01	6.68300E-01
2.52920E+03	4.74020E-01	6.71560E-01	3.18330E-01	6.62930E-01
2.52930E+03	4.70100E-01	6.71660E-01	3.15750E-01	6.57540E-01
2.52940E+03	4.66160E-01	6.71770E-01	3.13150E-01	6.52140E-01
2.52950E+03	4.62220E-01	6.71800E-01	3.10520E-01	6.46650E-01
2.52960E+03	4.58260E-01	6.71830E-01	3.07880E-01	6.41150E-01
2.52970E+03	4.54310E-01	6.71860E-01	3.05230E-01	6.35650E-01
2.52980E+03	4.50340E-01	6.71890E-01	3.02580E-01	6.30130E-01
2.52990E+03	4.46380E-01	6.71930E-01	2.99930E-01	6.24610E-01
2.53000E+03	4.42400E-01	6.71960E-01	2.97280E-01	6.19080E-01
2.53010E+03	4.38430E-01	6.71980E-01	2.94610E-01	6.13540E-01
2.53020E+03	4.34450E-01	6.72000E-01	2.91950E-01	6.07990E-01
2.53030E+03	4.30460E-01	6.72020E-01	2.89280E-01	6.02430E-01
2.53040E+03	4.26470E-01	6.72040E-01	2.86610E-01	5.96860E-01
2.53050E+03	4.22470E-01	6.72070E-01	2.83930E-01	5.91290E-01
2.53060E+03	4.18470E-01	6.72090E-01	2.81250E-01	5.85700E-01

2.53070E+03	4.14450E-01	6.72110E-01	2.78560E-01	5.80100E-01
2.53080E+03	4.10430E-01	6.72130E-01	2.75860E-01	5.74480E-01
2.53090E+03	4.06390E-01	6.72160E-01	2.73150E-01	5.68850E-01
2.53100E+03	4.02330E-01	6.72180E-01	2.70440E-01	5.63190E-01
2.53110E+03	3.98270E-01	6.72200E-01	2.67710E-01	5.57520E-01
2.53120E+03	3.94180E-01	6.72220E-01	2.64980E-01	5.51820E-01
2.53130E+03	3.90080E-01	6.72240E-01	2.62230E-01	5.46100E-01
2.53140E+03	3.85970E-01	6.72270E-01	2.59470E-01	5.40360E-01
2.53150E+03	3.81840E-01	6.72290E-01	2.56700E-01	5.34590E-01
2.53160E+03	3.77690E-01	6.72310E-01	2.53920E-01	5.28800E-01
2.53170E+03	3.73520E-01	6.72350E-01	2.51140E-01	5.23000E-01
2.53180E+03	3.69340E-01	6.72390E-01	2.48340E-01	5.17170E-01
2.53190E+03	3.65150E-01	6.72430E-01	2.45540E-01	5.11330E-01
2.53200E+03	3.60940E-01	6.72470E-01	2.42720E-01	5.05480E-01
2.53210E+03	3.56730E-01	6.72480E-01	2.39890E-01	4.99580E-01
2.53220E+03	3.52510E-01	6.72480E-01	2.37050E-01	4.93660E-01
2.53230E+03	3.48280E-01	6.72410E-01	2.34190E-01	4.87700E-01
2.53240E+03	3.44060E-01	6.72350E-01	2.31330E-01	4.81740E-01
2.53250E+03	3.39830E-01	6.72280E-01	2.28460E-01	4.75780E-01
2.53260E+03	3.35620E-01	6.72220E-01	2.25610E-01	4.69830E-01
2.53270E+03	3.31410E-01	6.72150E-01	2.22760E-01	4.63900E-01
2.53280E+03	3.27220E-01	6.72090E-01	2.19920E-01	4.57990E-01
2.53290E+03	3.23040E-01	6.72020E-01	2.17090E-01	4.52100E-01
2.53300E+03	3.18890E-01	6.71960E-01	2.14280E-01	4.46240E-01
2.53310E+03	3.14750E-01	6.71900E-01	2.11480E-01	4.40420E-01
2.53320E+03	3.10650E-01	6.71840E-01	2.08710E-01	4.34630E-01
2.53330E+03	3.06570E-01	6.71780E-01	2.05950E-01	4.28890E-01
2.53340E+03	3.02520E-01	6.71720E-01	2.03210E-01	4.23190E-01
2.53350E+03	2.98510E-01	6.71660E-01	2.00490E-01	4.17530E-01
2.53360E+03	2.94530E-01	6.71600E-01	1.97800E-01	4.11930E-01
2.53370E+03	2.90580E-01	6.71540E-01	1.95130E-01	4.06370E-01
2.53380E+03	2.86670E-01	6.71470E-01	1.92490E-01	4.00860E-01
2.53390E+03	2.82790E-01	6.71460E-01	1.89880E-01	3.95430E-01
2.53400E+03	2.78950E-01	6.71440E-01	1.87300E-01	3.90050E-01
2.53410E+03	2.75140E-01	6.71390E-01	1.84720E-01	3.84690E-01
2.53420E+03	2.71360E-01	6.71330E-01	1.82170E-01	3.79370E-01
2.53430E+03	2.67610E-01	6.71270E-01	1.79640E-01	3.74100E-01
2.53440E+03	2.63890E-01	6.71210E-01	1.77120E-01	3.68860E-01
2.53450E+03	2.60190E-01	6.71150E-01	1.74630E-01	3.63660E-01
2.53460E+03	2.56520E-01	6.71090E-01	1.72140E-01	3.58490E-01
2.53470E+03	2.52860E-01	6.71030E-01	1.69680E-01	3.53350E-01
2.53480E+03	2.49230E-01	6.70960E-01	1.67220E-01	3.48240E-01
2.53490E+03	2.45600E-01	6.70900E-01	1.64780E-01	3.43150E-01

2.53500E+03	2.42000E-01	6.70840E-01	1.62340E-01	3.38080E-01
2.53510E+03	2.38400E-01	6.70760E-01	1.59910E-01	3.33010E-01
2.53520E+03	2.34810E-01	6.70670E-01	1.57480E-01	3.27960E-01
2.53530E+03	2.31230E-01	6.70590E-01	1.55060E-01	3.22920E-01
2.53540E+03	2.27660E-01	6.70510E-01	1.52640E-01	3.17880E-01
2.53550E+03	2.24090E-01	6.70420E-01	1.50230E-01	3.12860E-01
2.53560E+03	2.20530E-01	6.70340E-01	1.47830E-01	3.07850E-01
2.53570E+03	2.16970E-01	6.70250E-01	1.45430E-01	3.02850E-01
2.53580E+03	2.13430E-01	6.70170E-01	1.43030E-01	2.97870E-01
2.53590E+03	2.09890E-01	6.70090E-01	1.40640E-01	2.92890E-01
2.53600E+03	2.06370E-01	6.70000E-01	1.38270E-01	2.87940E-01
2.53610E+03	2.02860E-01	6.70060E-01	1.35930E-01	2.83070E-01
2.53620E+03	1.99360E-01	6.70120E-01	1.33600E-01	2.78220E-01
2.53630E+03	1.95890E-01	6.70180E-01	1.31280E-01	2.73390E-01
2.53640E+03	1.92440E-01	6.70240E-01	1.28980E-01	2.68610E-01
2.53650E+03	1.89020E-01	6.70300E-01	1.26700E-01	2.63860E-01
2.53660E+03	1.85640E-01	6.70360E-01	1.24440E-01	2.59150E-01
2.53670E+03	1.82280E-01	6.70420E-01	1.22210E-01	2.54500E-01
2.53680E+03	1.78980E-01	6.70480E-01	1.20000E-01	2.49900E-01
2.53690E+03	1.75710E-01	6.70540E-01	1.17820E-01	2.45370E-01
2.53700E+03	1.72500E-01	6.70590E-01	1.15680E-01	2.40900E-01
2.53710E+03	1.69340E-01	6.70660E-01	1.13570E-01	2.36510E-01
2.53720E+03	1.66230E-01	6.70720E-01	1.11500E-01	2.32190E-01
2.53730E+03	1.63190E-01	6.70780E-01	1.09470E-01	2.27970E-01
2.53740E+03	1.60210E-01	6.70850E-01	1.07480E-01	2.23820E-01
2.53750E+03	1.57300E-01	6.70910E-01	1.05530E-01	2.19770E-01
2.53760E+03	1.54450E-01	6.70980E-01	1.03630E-01	2.15810E-01
2.53770E+03	1.51670E-01	6.71040E-01	1.01780E-01	2.11950E-01
2.53780E+03	1.48960E-01	6.71100E-01	9.99660E-02	2.08180E-01
2.53790E+03	1.46310E-01	6.71170E-01	9.82020E-02	2.04510E-01
2.53800E+03	1.43740E-01	6.71230E-01	9.64820E-02	2.00930E-01
2.53810E+03	1.41230E-01	6.71330E-01	9.48130E-02	1.97450E-01
2.53820E+03	1.38790E-01	6.71440E-01	9.31880E-02	1.94070E-01
2.53830E+03	1.36410E-01	6.71480E-01	9.15960E-02	1.90750E-01
2.53840E+03	1.34090E-01	6.71520E-01	9.00440E-02	1.87520E-01
2.53850E+03	1.31830E-01	6.71560E-01	8.85310E-02	1.84370E-01
2.53860E+03	1.29620E-01	6.71600E-01	8.70530E-02	1.81290E-01
2.53870E+03	1.27460E-01	6.71630E-01	8.56090E-02	1.78280E-01
2.53880E+03	1.25350E-01	6.71670E-01	8.41960E-02	1.75340E-01
2.53890E+03	1.23280E-01	6.71710E-01	8.28110E-02	1.72450E-01
2.53900E+03	1.21250E-01	6.71750E-01	8.14520E-02	1.69620E-01
2.53910E+03	1.19260E-01	6.71790E-01	8.01170E-02	1.66840E-01
2.53920E+03	1.17290E-01	6.71830E-01	7.88010E-02	1.64100E-01

2.53930E+03	1.15350E-01	6.71870E-01	7.75040E-02	1.61400E-01
2.53940E+03	1.13440E-01	6.71910E-01	7.62220E-02	1.58730E-01
2.53950E+03	1.11550E-01	6.71950E-01	7.49540E-02	1.56090E-01
2.53960E+03	1.09670E-01	6.71990E-01	7.36980E-02	1.53480E-01
2.53970E+03	1.07810E-01	6.72030E-01	7.24520E-02	1.50880E-01
2.53980E+03	1.05960E-01	6.72070E-01	7.12140E-02	1.48300E-01
2.53990E+03	1.04130E-01	6.72110E-01	6.99840E-02	1.45740E-01
2.54000E+03	1.02300E-01	6.72150E-01	6.87600E-02	1.43190E-01
2.54010E+03	1.00480E-01	6.72120E-01	6.75350E-02	1.40640E-01
2.54020E+03	9.86730E-02	6.72080E-01	6.63160E-02	1.38100E-01
2.54030E+03	9.68740E-02	6.72040E-01	6.51030E-02	1.35580E-01
2.54040E+03	9.50850E-02	6.72000E-01	6.38970E-02	1.33070E-01
2.54050E+03	9.33060E-02	6.71870E-01	6.26900E-02	1.30550E-01
2.54060E+03	9.15390E-02	6.71740E-01	6.14910E-02	1.28060E-01
2.54070E+03	8.97860E-02	6.71610E-01	6.03010E-02	1.25580E-01
2.54080E+03	8.80470E-02	6.71480E-01	5.91220E-02	1.23120E-01
2.54090E+03	8.63250E-02	6.71350E-01	5.79550E-02	1.20690E-01
2.54100E+03	8.46220E-02	6.71220E-01	5.68000E-02	1.18290E-01
2.54110E+03	8.29410E-02	6.71100E-01	5.56610E-02	1.15910E-01
2.54120E+03	8.12820E-02	6.70970E-01	5.45380E-02	1.13580E-01
2.54130E+03	8.14990E-02	6.70840E-01	5.46730E-02	1.13860E-01
2.54140E+03	7.99890E-02	6.70710E-01	5.36490E-02	1.11730E-01
2.54150E+03	7.85030E-02	6.70580E-01	5.26430E-02	1.09630E-01
2.54160E+03	7.70430E-02	6.70460E-01	5.16540E-02	1.07570E-01
2.54170E+03	7.56080E-02	6.70340E-01	5.06830E-02	1.05550E-01
2.54180E+03	7.41980E-02	6.70210E-01	4.97290E-02	1.03560E-01
2.54190E+03	7.28140E-02	6.70090E-01	4.87920E-02	1.01610E-01
2.54200E+03	7.14560E-02	6.69970E-01	4.78730E-02	9.96960E-02
2.54210E+03	7.01230E-02	6.69820E-01	4.69700E-02	9.78150E-02
2.54220E+03	6.88160E-02	6.69660E-01	4.60840E-02	9.59700E-02
2.54230E+03	6.75350E-02	6.69500E-01	4.52150E-02	9.41610E-02
2.54240E+03	6.62800E-02	6.69350E-01	4.43640E-02	9.23890E-02
2.54250E+03	6.50500E-02	6.69190E-01	4.35310E-02	9.06540E-02
2.54260E+03	6.38460E-02	6.69040E-01	4.27150E-02	8.89550E-02
2.54270E+03	6.26680E-02	6.68900E-01	4.19180E-02	8.72950E-02
2.54280E+03	6.15140E-02	6.68760E-01	4.11380E-02	8.56710E-02
2.54290E+03	6.03860E-02	6.68620E-01	4.03750E-02	8.40820E-02
2.54300E+03	5.92820E-02	6.68480E-01	3.96290E-02	8.25280E-02
2.54310E+03	5.82030E-02	6.68340E-01	3.88990E-02	8.10090E-02
2.54320E+03	5.71470E-02	6.68200E-01	3.81860E-02	7.95220E-02
2.54330E+03	5.61150E-02	6.68060E-01	3.74880E-02	7.80700E-02
2.54340E+03	5.51060E-02	6.67910E-01	3.68060E-02	7.66490E-02
2.54350E+03	5.41190E-02	6.67770E-01	3.61390E-02	7.52600E-02

2.54360E+03	5.31540E-02	6.67630E-01	3.54870E-02	7.39020E-02
2.54370E+03	5.22100E-02	6.67480E-01	3.48490E-02	7.25740E-02
2.54380E+03	5.12860E-02	6.67340E-01	3.42250E-02	7.12750E-02
2.54390E+03	5.03830E-02	6.67200E-01	3.36150E-02	7.00040E-02
2.54400E+03	4.94980E-02	6.67050E-01	3.30180E-02	6.87600E-02
2.54410E+03	4.86330E-02	6.67010E-01	3.24380E-02	6.75530E-02
2.54420E+03	4.77850E-02	6.66980E-01	3.18720E-02	6.63730E-02
2.54430E+03	4.69550E-02	6.66950E-01	3.13160E-02	6.52170E-02
2.54440E+03	4.61410E-02	6.66920E-01	3.07720E-02	6.40840E-02
2.54450E+03	4.53440E-02	6.66890E-01	3.02390E-02	6.29730E-02
2.54460E+03	4.45620E-02	6.66860E-01	2.97170E-02	6.18850E-02
2.54470E+03	4.37960E-02	6.66830E-01	2.92040E-02	6.08180E-02
2.54480E+03	4.30440E-02	6.66800E-01	2.87010E-02	5.97710E-02
2.54490E+03	4.23060E-02	6.66780E-01	2.82090E-02	5.87460E-02
2.54500E+03	4.15820E-02	6.66770E-01	2.77260E-02	5.77400E-02
2.54510E+03	4.08720E-02	6.66780E-01	2.72530E-02	5.67540E-02
2.54520E+03	4.01750E-02	6.66780E-01	2.67880E-02	5.57860E-02
2.54530E+03	3.94900E-02	6.66790E-01	2.63320E-02	5.48360E-02
2.54540E+03	3.88190E-02	6.66790E-01	2.58840E-02	5.39040E-02
2.54550E+03	3.81590E-02	6.66800E-01	2.54440E-02	5.29880E-02
2.54560E+03	3.75120E-02	6.66800E-01	2.50130E-02	5.20900E-02
2.54570E+03	3.68760E-02	6.66810E-01	2.45890E-02	5.12070E-02
2.54580E+03	3.62520E-02	6.66820E-01	2.41730E-02	5.03410E-02
2.54590E+03	3.56390E-02	6.66820E-01	2.37650E-02	4.94900E-02
2.54600E+03	3.50370E-02	6.66830E-01	2.33640E-02	4.86550E-02
2.54610E+03	3.44470E-02	6.66860E-01	2.29710E-02	4.78380E-02
2.54620E+03	3.38670E-02	6.66900E-01	2.25860E-02	4.70360E-02
2.54630E+03	3.32980E-02	6.66940E-01	2.22080E-02	4.62480E-02
2.54640E+03	3.27390E-02	6.66980E-01	2.18370E-02	4.54750E-02
2.54650E+03	3.21910E-02	6.67020E-01	2.14720E-02	4.47160E-02
2.54660E+03	3.16520E-02	6.67060E-01	2.11140E-02	4.39700E-02
2.54670E+03	3.11230E-02	6.67100E-01	2.07630E-02	4.32380E-02
2.54680E+03	3.06040E-02	6.67140E-01	2.04170E-02	4.25190E-02
2.54690E+03	3.00940E-02	6.67180E-01	2.00780E-02	4.18130E-02
2.54700E+03	2.95930E-02	6.67230E-01	1.97450E-02	4.11190E-02
2.54710E+03	2.91000E-02	6.67220E-01	1.94160E-02	4.04340E-02
2.54720E+03	2.86160E-02	6.67220E-01	1.90930E-02	3.97620E-02
2.54730E+03	2.81400E-02	6.67210E-01	1.87760E-02	3.91000E-02
2.54740E+03	2.76720E-02	6.67210E-01	1.84630E-02	3.84500E-02
2.54750E+03	2.72120E-02	6.67200E-01	1.81560E-02	3.78100E-02
2.54760E+03	2.67600E-02	6.67200E-01	1.78540E-02	3.71820E-02
2.54770E+03	2.63150E-02	6.67190E-01	1.75570E-02	3.65630E-02
2.54780E+03	2.58770E-02	6.67190E-01	1.72650E-02	3.59540E-02

2.54790E+03	2.54460E-02	6.67180E-01	1.69770E-02	3.53550E-02
2.54800E+03	2.50220E-02	6.67180E-01	1.66940E-02	3.47660E-02
2.54810E+03	2.46060E-02	6.67130E-01	1.64150E-02	3.41850E-02
2.54820E+03	2.41960E-02	6.67060E-01	1.61400E-02	3.36120E-02
2.54830E+03	2.37920E-02	6.66990E-01	1.58690E-02	3.30480E-02
2.54840E+03	2.33960E-02	6.66920E-01	1.56030E-02	3.24940E-02
2.54850E+03	2.30070E-02	6.66850E-01	1.53420E-02	3.19500E-02
2.54860E+03	2.26240E-02	6.66780E-01	1.50850E-02	3.14150E-02
2.54870E+03	2.22490E-02	6.66710E-01	1.48330E-02	3.08910E-02
2.54880E+03	2.18800E-02	6.66640E-01	1.45860E-02	3.03760E-02
2.54890E+03	2.15190E-02	6.66570E-01	1.43440E-02	2.98720E-02
2.54900E+03	2.11650E-02	6.66500E-01	1.41070E-02	2.93770E-02
2.54910E+03	2.08190E-02	6.66430E-01	1.38740E-02	2.88940E-02
2.54920E+03	2.04800E-02	6.66360E-01	1.36470E-02	2.84200E-02
2.54930E+03	2.01490E-02	6.66300E-01	1.34250E-02	2.79590E-02
2.54940E+03	1.98250E-02	6.66250E-01	1.32090E-02	2.75070E-02
2.54950E+03	1.95100E-02	6.66200E-01	1.29970E-02	2.70670E-02
2.54960E+03	1.92020E-02	6.66150E-01	1.27910E-02	2.66380E-02
2.54970E+03	1.89010E-02	6.66100E-01	1.25900E-02	2.62190E-02
2.54980E+03	1.86090E-02	6.66050E-01	1.23940E-02	2.58110E-02
2.54990E+03	1.83240E-02	6.66000E-01	1.22030E-02	2.54140E-02
2.55000E+03	1.80460E-02	6.65950E-01	1.20180E-02	2.50270E-02
2.55010E+03	1.77760E-02	6.65910E-01	1.18370E-02	2.46510E-02
2.55020E+03	1.75130E-02	6.65880E-01	1.16610E-02	2.42850E-02
2.55030E+03	1.72560E-02	6.65840E-01	1.14900E-02	2.39280E-02
2.55040E+03	1.70070E-02	6.65810E-01	1.13230E-02	2.35810E-02
2.55050E+03	1.67640E-02	6.65770E-01	1.11610E-02	2.32420E-02
2.55060E+03	1.65260E-02	6.65740E-01	1.10020E-02	2.29120E-02
2.55070E+03	1.62950E-02	6.65700E-01	1.08480E-02	2.25900E-02
2.55080E+03	1.60690E-02	6.65670E-01	1.06970E-02	2.22760E-02
2.55090E+03	1.58480E-02	6.65630E-01	1.05490E-02	2.19680E-02
2.55100E+03	1.56320E-02	6.65600E-01	1.04040E-02	2.16670E-02
2.55110E+03	1.54190E-02	6.65560E-01	1.02630E-02	2.13720E-02
2.55120E+03	1.52110E-02	6.65530E-01	1.01240E-02	2.10820E-02
2.55130E+03	1.50070E-02	6.65500E-01	9.98710E-03	2.07980E-02
2.55140E+03	1.48060E-02	6.65470E-01	9.85280E-03	2.05190E-02
2.55150E+03	1.46080E-02	6.65490E-01	9.72150E-03	2.02450E-02
2.55160E+03	1.44130E-02	6.65510E-01	9.59210E-03	1.99760E-02
2.55170E+03	1.42210E-02	6.65530E-01	9.46450E-03	1.97100E-02
2.55180E+03	1.40310E-02	6.65550E-01	9.33870E-03	1.94480E-02
2.55190E+03	1.38440E-02	6.65580E-01	9.21450E-03	1.91890E-02
2.55200E+03	1.36600E-02	6.65600E-01	9.09200E-03	1.89340E-02
2.55210E+03	1.34780E-02	6.65680E-01	8.97190E-03	1.86840E-02

2.55220E+03	1.32980E-02	6.65760E-01	8.85340E-03	1.84370E-02
2.55230E+03	1.31210E-02	6.65840E-01	8.73670E-03	1.81940E-02
2.55240E+03	1.29470E-02	6.65910E-01	8.62170E-03	1.79550E-02
2.55250E+03	1.27760E-02	6.65990E-01	8.50860E-03	1.77190E-02
2.55260E+03	1.26070E-02	6.66070E-01	8.39750E-03	1.74880E-02
2.55270E+03	1.24420E-02	6.66150E-01	8.28850E-03	1.72610E-02
2.55280E+03	1.22810E-02	6.66230E-01	8.18170E-03	1.70390E-02
2.55290E+03	1.21230E-02	6.66300E-01	8.07730E-03	1.68210E-02
2.55300E+03	1.19680E-02	6.66370E-01	7.97540E-03	1.66090E-02
2.55310E+03	1.18180E-02	6.66440E-01	7.87610E-03	1.64020E-02
2.55320E+03	1.16720E-02	6.66510E-01	7.77970E-03	1.62010E-02
2.55330E+03	1.15310E-02	6.66580E-01	7.68630E-03	1.60070E-02
2.55340E+03	1.13940E-02	6.66650E-01	7.59580E-03	1.58180E-02
2.55350E+03	1.12620E-02	6.66720E-01	7.50850E-03	1.56370E-02
2.55360E+03	1.11340E-02	6.66790E-01	7.42430E-03	1.54610E-02
2.55370E+03	1.10120E-02	6.66850E-01	7.34330E-03	1.52920E-02
2.55380E+03	1.08940E-02	6.66910E-01	7.26550E-03	1.51300E-02
2.55390E+03	1.07810E-02	6.66980E-01	7.19090E-03	1.49750E-02
2.55400E+03	1.06730E-02	6.67040E-01	7.11950E-03	1.48270E-02
2.55410E+03	1.05700E-02	6.67080E-01	7.05110E-03	1.46840E-02
2.55420E+03	1.04720E-02	6.67110E-01	6.98570E-03	1.45480E-02
2.55430E+03	1.03770E-02	6.67150E-01	6.92320E-03	1.44180E-02
2.55440E+03	1.02880E-02	6.67180E-01	6.86370E-03	1.42940E-02
2.55450E+03	1.02020E-02	6.67220E-01	6.80680E-03	1.41750E-02
2.55460E+03	1.01200E-02	6.67250E-01	6.75250E-03	1.40620E-02
2.55470E+03	1.00420E-02	6.67290E-01	6.70070E-03	1.39540E-02
2.55480E+03	9.96690E-03	6.67320E-01	6.65110E-03	1.38510E-02
2.55490E+03	9.89530E-03	6.67360E-01	6.60370E-03	1.37520E-02
2.55500E+03	9.82660E-03	6.67390E-01	6.55820E-03	1.36570E-02
2.55510E+03	9.76060E-03	6.67410E-01	6.51430E-03	1.35660E-02
2.55520E+03	9.69700E-03	6.67440E-01	6.47210E-03	1.34780E-02
2.55530E+03	9.63570E-03	6.67460E-01	6.43140E-03	1.33940E-02
2.55540E+03	9.57650E-03	6.67480E-01	6.39210E-03	1.33120E-02
2.55550E+03	9.51910E-03	6.67510E-01	6.35400E-03	1.32320E-02
2.55560E+03	9.46340E-03	6.67530E-01	6.31710E-03	1.31550E-02
2.55570E+03	9.40920E-03	6.67550E-01	6.28110E-03	1.30810E-02
2.55580E+03	9.35650E-03	6.67570E-01	6.24610E-03	1.30080E-02
2.55590E+03	9.30490E-03	6.67590E-01	6.21190E-03	1.29360E-02
2.55600E+03	9.25450E-03	6.67600E-01	6.17830E-03	1.28660E-02
2.55610E+03	9.20510E-03	6.67520E-01	6.14460E-03	1.27960E-02
2.55620E+03	9.15650E-03	6.67440E-01	6.11140E-03	1.27270E-02
2.55630E+03	9.10870E-03	6.67360E-01	6.07880E-03	1.26590E-02
2.55640E+03	9.06150E-03	6.67280E-01	6.04660E-03	1.25920E-02

2.55650E+03	9.01470E-03	6.67210E-01	6.01470E-03	1.25260E-02
2.55660E+03	8.96830E-03	6.67130E-01	5.98300E-03	1.24600E-02
2.55670E+03	8.92190E-03	6.67050E-01	5.95130E-03	1.23940E-02
2.55680E+03	8.87540E-03	6.66970E-01	5.91960E-03	1.23280E-02
2.55690E+03	8.82860E-03	6.66890E-01	5.88770E-03	1.22610E-02
2.55700E+03	8.78110E-03	6.66810E-01	5.85530E-03	1.21940E-02
2.55710E+03	8.73270E-03	6.66740E-01	5.82240E-03	1.21250E-02
2.55720E+03	8.68300E-03	6.66660E-01	5.78860E-03	1.20550E-02
2.55730E+03	8.63170E-03	6.66580E-01	5.75370E-03	1.19820E-02
2.55740E+03	8.57830E-03	6.66500E-01	5.71750E-03	1.19070E-02
2.55750E+03	8.52260E-03	6.66430E-01	5.67970E-03	1.18280E-02
2.55760E+03	8.46410E-03	6.66350E-01	5.64000E-03	1.17450E-02
2.55770E+03	8.40230E-03	6.66270E-01	5.59820E-03	1.16580E-02
2.55780E+03	8.33680E-03	6.66190E-01	5.55390E-03	1.15660E-02
2.55790E+03	8.26710E-03	6.66120E-01	5.50690E-03	1.14680E-02
2.55800E+03	8.19290E-03	6.66040E-01	5.45680E-03	1.13640E-02
2.55810E+03	8.11380E-03	6.66120E-01	5.40470E-03	1.12550E-02
2.55820E+03	8.02940E-03	6.66190E-01	5.34910E-03	1.11400E-02
2.55830E+03	7.93930E-03	6.66270E-01	5.28970E-03	1.10160E-02
2.55840E+03	7.84330E-03	6.66350E-01	5.22630E-03	1.08840E-02
2.55850E+03	7.74110E-03	6.66420E-01	5.15880E-03	1.07430E-02
2.55860E+03	7.63260E-03	6.66500E-01	5.08710E-03	1.05940E-02
2.55870E+03	7.51770E-03	6.66580E-01	5.01110E-03	1.04360E-02
2.55880E+03	7.39650E-03	6.66650E-01	4.93090E-03	1.02690E-02
2.55890E+03	7.26880E-03	6.66730E-01	4.84630E-03	1.00930E-02
2.55900E+03	7.13500E-03	6.66800E-01	4.75770E-03	9.90790E-03
2.55910E+03	6.99530E-03	6.66890E-01	4.66500E-03	9.71500E-03
2.55920E+03	6.84990E-03	6.66970E-01	4.56860E-03	9.51420E-03
2.55930E+03	6.69930E-03	6.67050E-01	4.46870E-03	9.30610E-03
2.55940E+03	6.54390E-03	6.67130E-01	4.36560E-03	9.09150E-03
2.55950E+03	6.38450E-03	6.67210E-01	4.25970E-03	8.87090E-03
2.55960E+03	6.22140E-03	6.67290E-01	4.15150E-03	8.64550E-03
2.55970E+03	6.05560E-03	6.67370E-01	4.04130E-03	8.41600E-03
2.55980E+03	6.02980E-03	6.67450E-01	4.02460E-03	8.38130E-03
2.55990E+03	5.99040E-03	6.67530E-01	3.99870E-03	8.32740E-03
2.56000E+03	5.94510E-03	6.67620E-01	3.96910E-03	8.26560E-03
2.56010E+03	5.89040E-03	6.67740E-01	3.93330E-03	8.19110E-03
2.56020E+03	5.82290E-03	6.67870E-01	3.88890E-03	8.09880E-03
2.56030E+03	5.73950E-03	6.67980E-01	3.83390E-03	7.98410E-03
2.56040E+03	5.63750E-03	6.68090E-01	3.76640E-03	7.84350E-03
2.56050E+03	5.51490E-03	6.68200E-01	3.68510E-03	7.67420E-03
2.56060E+03	5.37010E-03	6.68310E-01	3.58890E-03	7.47400E-03
2.56070E+03	5.20240E-03	6.68430E-01	3.47740E-03	7.24170E-03

2.56080E+03	5.01150E-03	6.68540E-01	3.35040E-03	6.97720E-03
2.56090E+03	4.79820E-03	6.68650E-01	3.20830E-03	6.68130E-03
2.56100E+03	4.56380E-03	6.68760E-01	3.05210E-03	6.35600E-03
2.56110E+03	4.31040E-03	6.68870E-01	2.88310E-03	6.00410E-03
2.56120E+03	4.04090E-03	6.68980E-01	2.70320E-03	5.62950E-03
2.56130E+03	3.75850E-03	6.69090E-01	2.51480E-03	5.23710E-03
2.56140E+03	3.46750E-03	6.69190E-01	2.32040E-03	4.83230E-03
2.56150E+03	3.17210E-03	6.69300E-01	2.12310E-03	4.42140E-03
2.56160E+03	2.87730E-03	6.69410E-01	1.92610E-03	4.01100E-03
2.56170E+03	2.56710E-03	6.69520E-01	1.71880E-03	3.57930E-03
2.56180E+03	2.05710E-03	6.69630E-01	1.37750E-03	2.86860E-03
2.56190E+03	1.54710E-03	6.69730E-01	1.03610E-03	2.15770E-03
2.56200E+03	1.03800E-03	6.69840E-01	6.95290E-04	1.44790E-03
2.56210E+03	0.00000E+00	6.69830E-01	0.00000E+00	0.00000E+00
Channel 19				
Wavenumber	HIRS Filter Transmittance	Optical Element Transmittance	Product of the HIRS Filter and Optical Element Transmittances	Normalized Value of Column 4
2.54960E+03	0.00000E+00	6.66150E-01	0.00000E+00	0.00000E+00
2.54980E+03	9.74870E-04	6.66050E-01	6.49310E-04	1.25660E-03
2.55000E+03	9.40840E-04	6.65950E-01	6.26550E-04	1.21250E-03
2.55020E+03	9.14940E-04	6.65880E-01	6.09240E-04	1.17900E-03
2.55040E+03	8.96950E-04	6.65810E-01	5.97200E-04	1.15570E-03
2.55060E+03	8.86390E-04	6.65740E-01	5.90100E-04	1.14200E-03
2.55080E+03	8.82720E-04	6.65670E-01	5.87600E-04	1.13710E-03
2.55100E+03	8.85240E-04	6.65600E-01	5.89210E-04	1.14030E-03
2.55120E+03	8.93260E-04	6.65530E-01	5.94490E-04	1.15050E-03
2.55140E+03	9.05970E-04	6.65470E-01	6.02890E-04	1.16670E-03
2.55160E+03	9.22670E-04	6.65510E-01	6.14050E-04	1.18830E-03
2.55180E+03	9.42610E-04	6.65550E-01	6.27360E-04	1.21410E-03
2.55200E+03	9.65180E-04	6.65600E-01	6.42420E-04	1.24320E-03
2.55220E+03	9.89720E-04	6.65760E-01	6.58920E-04	1.27510E-03
2.55240E+03	1.01570E-03	6.65910E-01	6.76390E-04	1.30900E-03
2.55260E+03	1.04260E-03	6.66070E-01	6.94480E-04	1.34400E-03
2.55280E+03	1.09180E-03	6.66230E-01	7.27370E-04	1.40760E-03
2.55300E+03	1.10420E-03	6.66370E-01	7.35820E-04	1.42400E-03
2.55320E+03	1.11810E-03	6.66510E-01	7.45230E-04	1.44220E-03
2.55340E+03	1.13320E-03	6.66650E-01	7.55440E-04	1.46190E-03
2.55360E+03	1.14930E-03	6.66790E-01	7.66350E-04	1.48310E-03
2.55380E+03	1.16630E-03	6.66910E-01	7.77840E-04	1.50530E-03
2.55400E+03	1.18410E-03	6.67040E-01	7.89850E-04	1.52850E-03
2.55420E+03	1.20270E-03	6.67110E-01	8.02300E-04	1.55260E-03

2.55440E+03	1.22190E-03	6.67180E-01	8.15230E-04	1.57760E-03
2.55460E+03	1.24190E-03	6.67250E-01	8.28670E-04	1.60360E-03
2.55480E+03	1.26270E-03	6.67320E-01	8.42650E-04	1.63070E-03
2.55500E+03	1.28450E-03	6.67390E-01	8.57280E-04	1.65900E-03
2.55520E+03	1.30740E-03	6.67440E-01	8.72590E-04	1.68870E-03
2.55540E+03	1.33150E-03	6.67480E-01	8.88750E-04	1.71990E-03
2.55560E+03	1.35710E-03	6.67530E-01	9.05870E-04	1.75310E-03
2.55580E+03	1.38430E-03	6.67570E-01	9.24110E-04	1.78830E-03
2.55600E+03	1.41340E-03	6.67600E-01	9.43570E-04	1.82600E-03
2.55620E+03	1.44460E-03	6.67440E-01	9.64190E-04	1.86590E-03
2.55640E+03	1.47820E-03	6.67280E-01	9.86380E-04	1.90890E-03
2.55660E+03	1.51440E-03	6.67130E-01	1.01030E-03	1.95510E-03
2.55680E+03	1.55340E-03	6.66970E-01	1.03610E-03	2.00500E-03
2.55700E+03	1.59550E-03	6.66810E-01	1.06390E-03	2.05890E-03
2.55720E+03	1.64090E-03	6.66660E-01	1.09390E-03	2.11690E-03
2.55740E+03	1.68970E-03	6.66500E-01	1.12620E-03	2.17940E-03
2.55760E+03	1.74220E-03	6.66350E-01	1.16090E-03	2.24660E-03
2.55780E+03	1.79840E-03	6.66190E-01	1.19810E-03	2.31860E-03
2.55800E+03	1.85850E-03	6.66040E-01	1.23790E-03	2.39550E-03
2.55820E+03	1.92260E-03	6.66190E-01	1.28080E-03	2.47870E-03
2.55840E+03	1.99060E-03	6.66350E-01	1.32640E-03	2.56700E-03
2.55860E+03	2.06260E-03	6.66500E-01	1.37470E-03	2.66030E-03
2.55880E+03	2.13830E-03	6.66650E-01	1.42550E-03	2.75870E-03
2.55900E+03	2.21780E-03	6.66800E-01	1.47890E-03	2.86190E-03
2.55920E+03	2.30080E-03	6.66970E-01	1.53460E-03	2.96970E-03
2.55940E+03	2.38700E-03	6.67130E-01	1.59240E-03	3.08170E-03
2.55960E+03	2.47610E-03	6.67290E-01	1.65230E-03	3.19760E-03
2.55980E+03	2.56790E-03	6.67450E-01	1.71390E-03	3.31680E-03
2.56000E+03	2.66170E-03	6.67620E-01	1.77700E-03	3.43890E-03
2.56020E+03	2.75730E-03	6.67870E-01	1.84150E-03	3.56370E-03
2.56040E+03	2.85410E-03	6.68090E-01	1.90680E-03	3.69000E-03
2.56060E+03	2.95160E-03	6.68310E-01	1.97260E-03	3.81730E-03
2.56080E+03	3.04920E-03	6.68540E-01	2.03850E-03	3.94490E-03
2.56100E+03	3.14640E-03	6.68760E-01	2.10420E-03	4.07200E-03
2.56120E+03	3.24260E-03	6.68980E-01	2.16920E-03	4.19790E-03
2.56140E+03	3.33730E-03	6.69190E-01	2.23330E-03	4.32200E-03
2.56160E+03	3.43000E-03	6.69410E-01	2.29610E-03	4.44340E-03
2.56180E+03	3.52010E-03	6.69630E-01	2.35710E-03	4.56160E-03
2.56200E+03	3.60710E-03	6.69840E-01	2.41620E-03	4.67590E-03
2.56220E+03	3.69070E-03	6.69810E-01	2.47210E-03	4.78400E-03
2.56240E+03	3.77040E-03	6.69780E-01	2.52530E-03	4.88700E-03
2.56260E+03	3.84580E-03	6.69440E-01	2.57450E-03	4.98230E-03
2.56280E+03	3.91670E-03	6.69100E-01	2.62070E-03	5.07150E-03

2.56300E+03	3.98290E-03	6.68750E-01	2.66360E-03	5.15460E-03
2.56320E+03	4.04420E-03	6.68410E-01	2.70320E-03	5.23120E-03
2.56340E+03	4.10050E-03	6.68060E-01	2.73940E-03	5.30130E-03
2.56360E+03	4.15180E-03	6.67710E-01	2.77220E-03	5.36480E-03
2.56380E+03	4.19810E-03	6.67360E-01	2.80170E-03	5.42190E-03
2.56400E+03	4.23970E-03	6.67030E-01	2.82800E-03	5.47280E-03
2.56420E+03	4.27670E-03	6.66810E-01	2.85170E-03	5.51870E-03
2.56440E+03	4.30930E-03	6.66590E-01	2.87260E-03	5.55900E-03
2.56460E+03	4.33800E-03	6.66370E-01	2.89070E-03	5.59420E-03
2.56480E+03	4.36320E-03	6.66090E-01	2.90630E-03	5.62430E-03
2.56500E+03	4.38530E-03	6.65820E-01	2.91980E-03	5.65050E-03
2.56520E+03	4.40490E-03	6.65590E-01	2.93190E-03	5.67380E-03
2.56540E+03	4.42250E-03	6.65360E-01	2.94260E-03	5.69450E-03
2.56560E+03	4.43880E-03	6.65130E-01	2.95240E-03	5.71340E-03
2.56580E+03	4.45430E-03	6.64900E-01	2.96160E-03	5.73140E-03
2.56600E+03	4.46970E-03	6.64670E-01	2.97090E-03	5.74930E-03
2.56620E+03	4.48560E-03	6.64420E-01	2.98030E-03	5.76760E-03
2.56640E+03	4.50280E-03	6.64160E-01	2.99060E-03	5.78740E-03
2.56660E+03	4.52170E-03	6.63910E-01	3.00200E-03	5.80950E-03
2.56680E+03	4.54300E-03	6.63650E-01	3.01500E-03	5.83470E-03
2.56700E+03	4.56730E-03	6.63590E-01	3.03080E-03	5.86520E-03
2.56720E+03	4.59490E-03	6.63520E-01	3.04890E-03	5.90020E-03
2.56740E+03	4.62650E-03	6.63460E-01	3.06950E-03	5.94010E-03
2.56760E+03	4.66230E-03	6.63400E-01	3.09300E-03	5.98550E-03
2.56780E+03	4.70270E-03	6.63330E-01	3.11950E-03	6.03680E-03
2.56800E+03	4.74800E-03	6.63280E-01	3.14920E-03	6.09450E-03
2.56820E+03	4.79830E-03	6.63260E-01	3.18250E-03	6.15890E-03
2.56840E+03	4.85380E-03	6.63240E-01	3.21920E-03	6.22990E-03
2.56860E+03	4.91450E-03	6.63220E-01	3.25940E-03	6.30770E-03
2.56880E+03	4.98040E-03	6.63200E-01	3.30300E-03	6.39210E-03
2.56900E+03	5.05140E-03	6.63190E-01	3.35000E-03	6.48310E-03
2.56920E+03	5.12740E-03	6.63070E-01	3.39980E-03	6.57940E-03
2.56940E+03	5.20820E-03	6.62940E-01	3.45280E-03	6.68180E-03
2.56960E+03	5.29350E-03	6.62820E-01	3.50870E-03	6.79010E-03
2.56980E+03	5.38310E-03	6.62700E-01	3.56740E-03	6.90370E-03
2.57000E+03	5.47660E-03	6.62580E-01	3.62870E-03	7.02230E-03
2.57020E+03	5.57370E-03	6.62420E-01	3.69210E-03	7.14510E-03
2.57040E+03	5.67410E-03	6.62260E-01	3.75770E-03	7.27190E-03
2.57060E+03	5.77720E-03	6.62090E-01	3.82510E-03	7.40230E-03
2.57080E+03	5.88290E-03	6.61930E-01	3.89410E-03	7.53580E-03
2.57100E+03	5.99060E-03	6.61770E-01	3.96440E-03	7.67200E-03
2.57120E+03	6.10010E-03	6.61610E-01	4.03590E-03	7.81030E-03
2.57140E+03	6.21110E-03	6.61540E-01	4.10890E-03	7.95160E-03

2.57160E+03	6.32330E-03	6.61470E-01	4.18270E-03	8.09440E-03
2.57180E+03	6.43630E-03	6.61410E-01	4.25700E-03	8.23820E-03
2.57200E+03	6.55010E-03	6.61340E-01	4.33180E-03	8.38300E-03
2.57220E+03	6.66440E-03	6.61360E-01	4.40760E-03	8.52960E-03
2.57240E+03	6.77910E-03	6.61400E-01	4.48370E-03	8.67690E-03
2.57260E+03	6.89420E-03	6.61430E-01	4.56000E-03	8.82460E-03
2.57280E+03	7.00970E-03	6.61470E-01	4.63670E-03	8.97290E-03
2.57300E+03	7.12560E-03	6.61500E-01	4.71360E-03	9.12180E-03
2.57320E+03	7.24200E-03	6.61540E-01	4.79080E-03	9.27130E-03
2.57340E+03	7.35910E-03	6.61570E-01	4.86860E-03	9.42170E-03
2.57360E+03	7.47700E-03	6.61690E-01	4.94750E-03	9.57440E-03
2.57380E+03	7.59600E-03	6.61810E-01	5.02710E-03	9.72860E-03
2.57400E+03	7.71630E-03	6.61930E-01	5.10770E-03	9.88440E-03
2.57420E+03	7.83820E-03	6.62160E-01	5.19020E-03	1.00440E-02
2.57440E+03	7.96190E-03	6.62400E-01	5.27400E-03	1.02060E-02
2.57460E+03	8.08780E-03	6.62640E-01	5.35930E-03	1.03710E-02
2.57480E+03	8.21600E-03	6.62870E-01	5.44620E-03	1.05400E-02
2.57500E+03	8.34700E-03	6.63110E-01	5.53500E-03	1.07110E-02
2.57520E+03	8.48090E-03	6.63330E-01	5.62570E-03	1.08870E-02
2.57540E+03	8.61800E-03	6.63530E-01	5.71830E-03	1.10660E-02
2.57560E+03	8.75840E-03	6.63730E-01	5.81320E-03	1.12500E-02
2.57580E+03	8.90250E-03	6.63870E-01	5.91010E-03	1.14370E-02
2.57600E+03	9.05020E-03	6.64000E-01	6.00940E-03	1.16290E-02
2.57620E+03	9.20180E-03	6.63970E-01	6.10980E-03	1.18240E-02
2.57640E+03	9.35730E-03	6.63940E-01	6.21280E-03	1.20230E-02
2.57660E+03	9.51680E-03	6.63910E-01	6.31830E-03	1.22270E-02
2.57680E+03	9.68020E-03	6.63890E-01	6.42650E-03	1.24370E-02
2.57700E+03	9.84750E-03	6.63860E-01	6.53730E-03	1.26510E-02
2.57720E+03	1.00190E-02	6.63840E-01	6.65070E-03	1.28710E-02
2.57740E+03	1.01930E-02	6.63820E-01	6.76650E-03	1.30950E-02
2.57760E+03	1.03720E-02	6.63800E-01	6.88480E-03	1.33240E-02
2.57780E+03	1.05540E-02	6.63780E-01	7.00530E-03	1.35570E-02
2.57800E+03	1.07390E-02	6.63770E-01	7.12820E-03	1.37950E-02
2.57820E+03	1.09270E-02	6.63820E-01	7.25370E-03	1.40380E-02
2.57840E+03	1.11180E-02	6.63870E-01	7.38120E-03	1.42840E-02
2.57860E+03	1.13120E-02	6.63920E-01	7.51060E-03	1.45350E-02
2.57880E+03	1.15090E-02	6.63970E-01	7.64170E-03	1.47880E-02
2.57900E+03	1.17080E-02	6.64020E-01	7.77440E-03	1.50450E-02
2.57920E+03	1.19100E-02	6.64080E-01	7.90890E-03	1.53050E-02
2.57940E+03	1.21130E-02	6.64130E-01	8.04490E-03	1.55690E-02
2.57960E+03	1.23190E-02	6.64180E-01	8.18240E-03	1.58350E-02
2.57980E+03	1.25280E-02	6.64240E-01	8.32150E-03	1.61040E-02
2.58000E+03	1.27390E-02	6.64290E-01	8.46210E-03	1.63760E-02

2.58020E+03	1.29520E-02	6.64360E-01	8.60470E-03	1.66520E-02
2.58040E+03	1.31680E-02	6.64430E-01	8.74900E-03	1.69310E-02
2.58060E+03	1.33860E-02	6.64510E-01	8.89520E-03	1.72140E-02
2.58080E+03	1.36080E-02	6.64580E-01	9.04350E-03	1.75010E-02
2.58100E+03	1.38330E-02	6.64660E-01	9.19400E-03	1.77920E-02
2.58120E+03	1.40610E-02	6.64730E-01	9.34700E-03	1.80880E-02
2.58140E+03	1.42940E-02	6.64800E-01	9.50270E-03	1.83900E-02
2.58160E+03	1.45310E-02	6.64870E-01	9.66150E-03	1.86970E-02
2.58180E+03	1.47730E-02	6.64950E-01	9.82350E-03	1.90110E-02
2.58200E+03	1.50210E-02	6.65020E-01	9.98910E-03	1.93310E-02
2.58220E+03	1.52740E-02	6.65050E-01	1.01580E-02	1.96580E-02
2.58240E+03	1.55340E-02	6.65010E-01	1.03300E-02	1.99910E-02
2.58260E+03	1.58000E-02	6.64960E-01	1.05060E-02	2.03320E-02
2.58280E+03	1.60740E-02	6.64920E-01	1.06880E-02	2.06830E-02
2.58300E+03	1.63550E-02	6.64870E-01	1.08740E-02	2.10430E-02
2.58320E+03	1.66450E-02	6.64820E-01	1.10660E-02	2.14140E-02
2.58340E+03	1.69420E-02	6.64770E-01	1.12630E-02	2.17960E-02
2.58360E+03	1.72500E-02	6.64720E-01	1.14660E-02	2.21890E-02
2.58380E+03	1.75660E-02	6.64670E-01	1.16750E-02	2.25940E-02
2.58400E+03	1.78920E-02	6.64630E-01	1.18910E-02	2.30120E-02
2.58420E+03	1.82270E-02	6.64580E-01	1.21130E-02	2.34420E-02
2.58440E+03	1.85730E-02	6.64540E-01	1.23420E-02	2.38850E-02
2.58460E+03	1.89290E-02	6.64370E-01	1.25760E-02	2.43370E-02
2.58480E+03	1.92950E-02	6.64200E-01	1.28160E-02	2.48010E-02
2.58500E+03	1.96710E-02	6.64030E-01	1.30630E-02	2.52790E-02
2.58520E+03	2.00590E-02	6.63810E-01	1.33150E-02	2.57680E-02
2.58540E+03	2.04560E-02	6.63590E-01	1.35750E-02	2.62700E-02
2.58560E+03	2.08640E-02	6.63360E-01	1.38410E-02	2.67850E-02
2.58580E+03	2.12830E-02	6.63140E-01	1.41140E-02	2.73130E-02
2.58600E+03	2.17120E-02	6.62890E-01	1.43920E-02	2.78530E-02
2.58620E+03	2.21510E-02	6.62420E-01	1.46730E-02	2.83960E-02
2.58640E+03	2.26000E-02	6.61960E-01	1.49600E-02	2.89510E-02
2.58660E+03	2.30590E-02	6.61490E-01	1.52530E-02	2.95180E-02
2.58680E+03	2.35280E-02	6.61160E-01	1.55560E-02	3.01040E-02
2.58700E+03	2.40070E-02	6.60830E-01	1.58640E-02	3.07010E-02
2.58720E+03	2.44950E-02	6.60510E-01	1.61790E-02	3.13100E-02
2.58740E+03	2.49930E-02	6.60180E-01	1.65000E-02	3.19310E-02
2.58760E+03	2.55000E-02	6.59860E-01	1.68270E-02	3.25630E-02
2.58780E+03	2.60170E-02	6.59540E-01	1.71590E-02	3.32070E-02
2.58800E+03	2.65430E-02	6.59210E-01	1.74980E-02	3.38620E-02
2.58820E+03	2.70790E-02	6.58880E-01	1.78420E-02	3.45280E-02
2.58840E+03	2.76240E-02	6.58550E-01	1.81920E-02	3.52050E-02
2.58860E+03	2.81780E-02	6.58220E-01	1.85470E-02	3.58930E-02

2.58880E+03	2.87420E-02	6.57890E-01	1.89090E-02	3.65930E-02
2.58900E+03	2.93160E-02	6.57510E-01	1.92750E-02	3.73020E-02
2.58920E+03	2.98990E-02	6.57120E-01	1.96470E-02	3.80220E-02
2.58940E+03	3.04920E-02	6.56730E-01	2.00250E-02	3.87530E-02
2.58960E+03	3.10950E-02	6.56350E-01	2.04090E-02	3.94960E-02
2.58980E+03	3.17090E-02	6.55960E-01	2.08000E-02	4.02520E-02
2.59000E+03	3.23330E-02	6.55570E-01	2.11960E-02	4.10200E-02
2.59020E+03	3.29670E-02	6.55590E-01	2.16130E-02	4.18250E-02
2.59040E+03	3.36120E-02	6.55610E-01	2.20360E-02	4.26450E-02
2.59060E+03	3.42680E-02	6.55620E-01	2.24670E-02	4.34790E-02
2.59080E+03	3.49360E-02	6.55640E-01	2.29050E-02	4.43260E-02
2.59100E+03	3.56150E-02	6.55660E-01	2.33510E-02	4.51890E-02
2.59120E+03	3.63050E-02	6.55720E-01	2.38060E-02	4.60690E-02
2.59140E+03	3.70070E-02	6.55780E-01	2.42680E-02	4.69640E-02
2.59160E+03	3.77210E-02	6.55840E-01	2.47390E-02	4.78750E-02
2.59180E+03	3.84470E-02	6.55900E-01	2.52170E-02	4.88010E-02
2.59200E+03	3.91850E-02	6.55960E-01	2.57040E-02	4.97430E-02
2.59220E+03	3.99360E-02	6.55840E-01	2.61920E-02	5.06870E-02
2.59240E+03	4.06990E-02	6.55710E-01	2.66870E-02	5.16440E-02
2.59260E+03	4.14750E-02	6.55570E-01	2.71900E-02	5.26180E-02
2.59280E+03	4.22640E-02	6.55430E-01	2.77010E-02	5.36070E-02
2.59300E+03	4.30650E-02	6.55300E-01	2.82200E-02	5.46130E-02
2.59320E+03	4.38800E-02	6.55160E-01	2.87480E-02	5.56340E-02
2.59340E+03	4.47080E-02	6.55050E-01	2.92860E-02	5.66750E-02
2.59360E+03	4.55500E-02	6.54950E-01	2.98330E-02	5.77320E-02
2.59380E+03	4.64050E-02	6.54840E-01	3.03880E-02	5.88070E-02
2.59400E+03	4.72740E-02	6.54720E-01	3.09510E-02	5.98970E-02
2.59420E+03	4.81570E-02	6.54470E-01	3.15170E-02	6.09930E-02
2.59440E+03	4.90560E-02	6.54220E-01	3.20930E-02	6.21070E-02
2.59460E+03	4.99680E-02	6.53970E-01	3.26780E-02	6.32390E-02
2.59480E+03	5.03890E-02	6.53720E-01	3.29400E-02	6.37470E-02
2.59500E+03	5.13180E-02	6.53470E-01	3.35350E-02	6.48970E-02
2.59520E+03	5.22590E-02	6.53290E-01	3.41400E-02	6.60690E-02
2.59540E+03	5.32110E-02	6.53120E-01	3.47530E-02	6.72540E-02
2.59560E+03	5.41750E-02	6.52850E-01	3.53690E-02	6.84460E-02
2.59580E+03	5.51530E-02	6.52590E-01	3.59930E-02	6.96530E-02
2.59600E+03	5.61450E-02	6.52330E-01	3.66260E-02	7.08780E-02
2.59620E+03	5.71530E-02	6.52200E-01	3.72750E-02	7.21350E-02
2.59640E+03	5.81770E-02	6.52060E-01	3.79350E-02	7.34120E-02
2.59660E+03	5.92190E-02	6.51930E-01	3.86060E-02	7.47120E-02
2.59680E+03	6.02800E-02	6.51790E-01	3.92900E-02	7.60350E-02
2.59700E+03	6.13630E-02	6.51660E-01	3.99870E-02	7.73840E-02
2.59720E+03	6.24680E-02	6.51520E-01	4.06990E-02	7.87610E-02

2.59740E+03	6.35970E-02	6.51380E-01	4.14260E-02	8.01680E-02
2.59760E+03	6.47520E-02	6.51240E-01	4.21690E-02	8.16070E-02
2.59780E+03	6.59360E-02	6.51050E-01	4.29270E-02	8.30730E-02
2.59800E+03	6.71480E-02	6.50860E-01	4.37040E-02	8.45760E-02
2.59820E+03	6.83920E-02	6.50710E-01	4.45030E-02	8.61230E-02
2.59840E+03	6.96670E-02	6.50570E-01	4.53240E-02	8.77110E-02
2.59860E+03	7.09770E-02	6.50430E-01	4.61660E-02	8.93410E-02
2.59880E+03	7.23220E-02	6.50290E-01	4.70300E-02	9.10140E-02
2.59900E+03	7.37030E-02	6.50070E-01	4.79120E-02	9.27200E-02
2.59920E+03	7.51220E-02	6.49750E-01	4.88110E-02	9.44590E-02
2.59940E+03	7.65790E-02	6.49600E-01	4.97460E-02	9.62690E-02
2.59960E+03	7.80740E-02	6.49460E-01	5.07060E-02	9.81270E-02
2.59980E+03	7.96100E-02	6.49310E-01	5.16910E-02	1.00030E-01
2.60000E+03	8.11850E-02	6.49280E-01	5.27120E-02	1.02010E-01
2.60020E+03	8.28010E-02	6.49450E-01	5.37740E-02	1.04070E-01
2.60040E+03	8.44570E-02	6.49610E-01	5.48640E-02	1.06170E-01
2.60060E+03	8.61530E-02	6.49770E-01	5.59800E-02	1.08330E-01
2.60080E+03	8.78910E-02	6.49940E-01	5.71240E-02	1.10550E-01
2.60100E+03	8.96690E-02	6.50100E-01	5.82940E-02	1.12810E-01
2.60120E+03	9.14870E-02	6.50270E-01	5.94910E-02	1.15130E-01
2.60140E+03	9.33470E-02	6.50430E-01	6.07160E-02	1.17500E-01
2.60160E+03	9.52470E-02	6.50600E-01	6.19670E-02	1.19920E-01
2.60180E+03	9.71870E-02	6.50760E-01	6.32460E-02	1.22390E-01
2.60200E+03	9.91680E-02	6.50930E-01	6.45510E-02	1.24920E-01
2.60220E+03	1.01190E-01	6.50990E-01	6.58740E-02	1.27480E-01
2.60240E+03	1.03250E-01	6.51050E-01	6.72240E-02	1.30090E-01
2.60260E+03	1.05360E-01	6.51120E-01	6.86010E-02	1.32760E-01
2.60280E+03	1.07510E-01	6.51180E-01	7.00060E-02	1.35480E-01
2.60300E+03	1.09700E-01	6.51250E-01	7.14390E-02	1.38250E-01
2.60320E+03	1.11930E-01	6.51310E-01	7.29020E-02	1.41080E-01
2.60340E+03	1.14210E-01	6.51380E-01	7.43940E-02	1.43970E-01
2.60360E+03	1.16530E-01	6.51450E-01	7.59160E-02	1.46910E-01
2.60380E+03	1.18910E-01	6.51520E-01	7.74690E-02	1.49920E-01
2.60400E+03	1.21330E-01	6.51590E-01	7.90560E-02	1.52990E-01
2.60420E+03	1.23800E-01	6.51620E-01	8.06700E-02	1.56110E-01
2.60440E+03	1.26320E-01	6.51600E-01	8.23120E-02	1.59290E-01
2.60460E+03	1.28900E-01	6.51570E-01	8.39880E-02	1.62530E-01
2.60480E+03	1.31530E-01	6.51540E-01	8.57010E-02	1.65850E-01
2.60500E+03	1.34230E-01	6.51520E-01	8.74510E-02	1.69240E-01
2.60520E+03	1.36980E-01	6.51410E-01	8.92280E-02	1.72680E-01
2.60540E+03	1.39790E-01	6.51300E-01	9.10460E-02	1.76190E-01
2.60560E+03	1.42660E-01	6.51200E-01	9.29030E-02	1.79790E-01
2.60580E+03	1.45600E-01	6.51090E-01	9.48020E-02	1.83460E-01

2.60600E+03	1.48610E-01	6.50980E-01	9.67440E-02	1.87220E-01
2.60620E+03	1.51690E-01	6.51020E-01	9.87510E-02	1.91100E-01
2.60640E+03	1.54830E-01	6.51090E-01	1.00810E-01	1.95080E-01
2.60660E+03	1.58040E-01	6.51260E-01	1.02930E-01	1.99180E-01
2.60680E+03	1.61330E-01	6.51440E-01	1.05090E-01	2.03380E-01
2.60700E+03	1.64680E-01	6.51610E-01	1.07310E-01	2.07660E-01
2.60720E+03	1.68110E-01	6.51770E-01	1.09570E-01	2.12040E-01
2.60740E+03	1.71610E-01	6.51930E-01	1.11880E-01	2.16510E-01
2.60760E+03	1.75180E-01	6.52100E-01	1.14230E-01	2.21070E-01
2.60780E+03	1.78820E-01	6.52260E-01	1.16640E-01	2.25720E-01
2.60800E+03	1.82540E-01	6.52390E-01	1.19090E-01	2.30460E-01
2.60820E+03	1.86320E-01	6.52350E-01	1.21550E-01	2.35220E-01
2.60840E+03	1.90180E-01	6.52320E-01	1.24060E-01	2.40070E-01
2.60860E+03	1.94100E-01	6.52280E-01	1.26610E-01	2.45010E-01
2.60880E+03	1.98090E-01	6.52290E-01	1.29210E-01	2.50060E-01
2.60900E+03	2.02150E-01	6.52310E-01	1.31860E-01	2.55180E-01
2.60920E+03	2.06270E-01	6.52310E-01	1.34550E-01	2.60390E-01
2.60940E+03	2.10460E-01	6.52310E-01	1.37290E-01	2.65680E-01
2.60960E+03	2.14710E-01	6.52310E-01	1.40060E-01	2.71040E-01
2.60980E+03	2.19020E-01	6.52320E-01	1.42870E-01	2.76480E-01
2.61000E+03	2.23390E-01	6.52320E-01	1.45720E-01	2.82000E-01
2.61020E+03	2.27820E-01	6.52140E-01	1.48570E-01	2.87510E-01
2.61040E+03	2.32310E-01	6.51940E-01	1.51450E-01	2.93090E-01
2.61060E+03	2.36850E-01	6.51750E-01	1.54370E-01	2.98730E-01
2.61080E+03	2.41450E-01	6.51550E-01	1.57320E-01	3.04440E-01
2.61100E+03	2.46100E-01	6.51100E-01	1.60230E-01	3.10090E-01
2.61120E+03	2.50800E-01	6.50640E-01	1.63180E-01	3.15790E-01
2.61140E+03	2.55560E-01	6.50170E-01	1.66160E-01	3.21560E-01
2.61160E+03	2.60380E-01	6.49710E-01	1.69170E-01	3.27380E-01
2.61180E+03	2.65240E-01	6.49250E-01	1.72210E-01	3.33260E-01
2.61200E+03	2.70160E-01	6.48790E-01	1.75280E-01	3.39200E-01
2.61220E+03	2.75140E-01	6.48340E-01	1.78380E-01	3.45210E-01
2.61240E+03	2.80160E-01	6.47900E-01	1.81520E-01	3.51280E-01
2.61260E+03	2.85240E-01	6.47460E-01	1.84680E-01	3.57400E-01
2.61280E+03	2.90380E-01	6.47020E-01	1.87880E-01	3.63590E-01
2.61300E+03	2.95570E-01	6.46580E-01	1.91110E-01	3.69840E-01
2.61320E+03	3.00810E-01	6.46240E-01	1.94400E-01	3.76200E-01
2.61340E+03	3.06120E-01	6.45890E-01	1.97720E-01	3.82630E-01
2.61360E+03	3.11470E-01	6.45550E-01	2.01070E-01	3.89120E-01
2.61380E+03	3.16890E-01	6.45210E-01	2.04460E-01	3.95670E-01
2.61400E+03	3.22360E-01	6.44900E-01	2.07890E-01	4.02310E-01
2.61420E+03	3.27890E-01	6.44740E-01	2.11410E-01	4.09120E-01
2.61440E+03	3.33480E-01	6.44580E-01	2.14960E-01	4.15990E-01

2.61460E+03	3.39130E-01	6.44420E-01	2.18540E-01	4.22930E-01
2.61480E+03	3.44840E-01	6.44250E-01	2.22160E-01	4.29930E-01
2.61500E+03	3.50600E-01	6.44080E-01	2.25820E-01	4.37000E-01
2.61520E+03	3.56420E-01	6.44000E-01	2.29540E-01	4.44200E-01
2.61540E+03	3.62300E-01	6.43880E-01	2.33280E-01	4.51440E-01
2.61560E+03	3.68230E-01	6.43750E-01	2.37050E-01	4.58750E-01
2.61580E+03	3.74220E-01	6.43630E-01	2.40860E-01	4.66110E-01
2.61600E+03	3.80260E-01	6.43500E-01	2.44700E-01	4.73550E-01
2.61620E+03	3.86350E-01	6.43420E-01	2.48590E-01	4.81070E-01
2.61640E+03	3.92500E-01	6.43350E-01	2.52510E-01	4.88660E-01
2.61660E+03	3.98680E-01	6.43280E-01	2.56460E-01	4.96310E-01
2.61680E+03	4.04910E-01	6.43210E-01	2.60440E-01	5.04020E-01
2.61700E+03	4.11190E-01	6.43140E-01	2.64450E-01	5.11770E-01
2.61720E+03	4.17500E-01	6.43070E-01	2.68480E-01	5.19560E-01
2.61740E+03	4.23840E-01	6.43000E-01	2.72530E-01	5.27400E-01
2.61760E+03	4.30220E-01	6.42900E-01	2.76590E-01	5.35260E-01
2.61780E+03	4.36630E-01	6.42810E-01	2.80670E-01	5.43160E-01
2.61800E+03	4.43060E-01	6.42720E-01	2.84760E-01	5.51080E-01
2.61820E+03	4.49510E-01	6.42530E-01	2.88820E-01	5.58930E-01
2.61840E+03	4.55980E-01	6.42330E-01	2.92890E-01	5.66800E-01
2.61860E+03	4.62460E-01	6.42120E-01	2.96960E-01	5.74670E-01
2.61880E+03	4.68950E-01	6.41920E-01	3.01030E-01	5.82550E-01
2.61900E+03	4.75440E-01	6.41720E-01	3.05100E-01	5.90440E-01
2.61920E+03	4.81940E-01	6.41520E-01	3.09170E-01	5.98310E-01
2.61940E+03	4.88430E-01	6.41310E-01	3.13230E-01	6.06170E-01
2.61960E+03	4.94910E-01	6.41110E-01	3.17290E-01	6.14020E-01
2.61980E+03	5.01380E-01	6.40980E-01	3.21370E-01	6.21930E-01
2.62000E+03	5.07830E-01	6.40860E-01	3.25450E-01	6.29810E-01
2.62020E+03	5.14260E-01	6.40780E-01	3.29530E-01	6.37710E-01
2.62040E+03	5.20670E-01	6.40700E-01	3.33590E-01	6.45570E-01
2.62060E+03	5.27050E-01	6.40620E-01	3.37640E-01	6.53400E-01
2.62080E+03	5.33390E-01	6.40540E-01	3.41660E-01	6.61180E-01
2.62100E+03	5.39700E-01	6.40470E-01	3.45660E-01	6.68920E-01
2.62120E+03	5.45960E-01	6.40390E-01	3.49630E-01	6.76610E-01
2.62140E+03	5.52180E-01	6.40320E-01	3.53570E-01	6.84240E-01
2.62160E+03	5.58360E-01	6.40250E-01	3.57490E-01	6.91820E-01
2.62180E+03	5.64480E-01	6.40180E-01	3.61370E-01	6.99320E-01
2.62200E+03	5.70550E-01	6.40060E-01	3.65190E-01	7.06710E-01
2.62220E+03	5.76560E-01	6.39960E-01	3.68970E-01	7.14040E-01
2.62240E+03	5.82500E-01	6.39850E-01	3.72710E-01	7.21280E-01
2.62260E+03	5.88390E-01	6.39740E-01	3.76420E-01	7.28440E-01
2.62280E+03	5.94210E-01	6.39630E-01	3.80070E-01	7.35520E-01
2.62300E+03	5.99950E-01	6.39520E-01	3.83680E-01	7.42510E-01

2.62320E+03	6.05630E-01	6.39420E-01	3.87250E-01	7.49420E-01
2.62340E+03	6.11230E-01	6.39320E-01	3.90770E-01	7.56230E-01
2.62360E+03	6.16760E-01	6.39210E-01	3.94240E-01	7.62940E-01
2.62380E+03	6.22210E-01	6.39110E-01	3.97660E-01	7.69550E-01
2.62400E+03	6.27580E-01	6.39000E-01	4.01020E-01	7.76070E-01
2.62420E+03	6.32860E-01	6.39030E-01	4.04420E-01	7.82630E-01
2.62440E+03	6.38070E-01	6.39050E-01	4.07760E-01	7.89090E-01
2.62460E+03	6.43190E-01	6.39070E-01	4.11040E-01	7.95450E-01
2.62480E+03	6.48230E-01	6.39090E-01	4.14270E-01	8.01710E-01
2.62500E+03	6.53170E-01	6.39110E-01	4.17450E-01	8.07860E-01
2.62520E+03	6.58040E-01	6.39140E-01	4.20580E-01	8.13910E-01
2.62540E+03	6.62810E-01	6.39170E-01	4.23650E-01	8.19850E-01
2.62560E+03	6.67500E-01	6.39200E-01	4.26670E-01	8.25690E-01
2.62580E+03	6.72100E-01	6.39230E-01	4.29630E-01	8.31420E-01
2.62600E+03	6.76610E-01	6.39270E-01	4.32540E-01	8.37060E-01
2.62620E+03	6.81040E-01	6.39490E-01	4.35520E-01	8.42820E-01
2.62640E+03	6.85370E-01	6.39620E-01	4.38380E-01	8.48350E-01
2.62660E+03	6.89620E-01	6.39750E-01	4.41180E-01	8.53780E-01
2.62680E+03	6.93770E-01	6.39880E-01	4.43930E-01	8.59100E-01
2.62700E+03	6.97840E-01	6.40010E-01	4.46620E-01	8.64310E-01
2.62720E+03	7.01820E-01	6.40150E-01	4.49270E-01	8.69430E-01
2.62740E+03	7.05710E-01	6.40290E-01	4.51850E-01	8.74440E-01
2.62760E+03	7.09510E-01	6.40430E-01	4.54390E-01	8.79330E-01
2.62780E+03	7.13220E-01	6.40560E-01	4.56860E-01	8.84130E-01
2.62800E+03	7.16840E-01	6.40690E-01	4.59270E-01	8.88790E-01
2.62820E+03	7.20380E-01	6.40710E-01	4.61560E-01	8.93210E-01
2.62840E+03	7.23830E-01	6.40740E-01	4.63780E-01	8.97520E-01
2.62860E+03	7.27190E-01	6.40940E-01	4.66080E-01	9.01970E-01
2.62880E+03	7.30460E-01	6.41140E-01	4.68330E-01	9.06320E-01
2.62900E+03	7.33640E-01	6.41350E-01	4.70520E-01	9.10560E-01
2.62920E+03	7.36740E-01	6.41550E-01	4.72660E-01	9.14690E-01
2.62940E+03	7.39750E-01	6.41760E-01	4.74740E-01	9.18720E-01
2.62960E+03	7.42660E-01	6.41960E-01	4.76760E-01	9.22640E-01
2.62980E+03	7.45500E-01	6.42170E-01	4.78730E-01	9.26450E-01
2.63000E+03	7.48240E-01	6.42360E-01	4.80640E-01	9.30140E-01
2.63020E+03	7.50900E-01	6.42410E-01	4.82380E-01	9.33520E-01
2.63040E+03	7.53470E-01	6.42460E-01	4.84070E-01	9.36780E-01
2.63060E+03	7.55950E-01	6.42510E-01	4.85700E-01	9.39940E-01
2.63080E+03	7.58350E-01	6.42340E-01	4.87120E-01	9.42680E-01
2.63100E+03	7.60660E-01	6.42180E-01	4.88480E-01	9.45310E-01
2.63120E+03	7.62880E-01	6.42020E-01	4.89780E-01	9.47830E-01
2.63140E+03	7.65020E-01	6.41850E-01	4.91030E-01	9.50250E-01
2.63160E+03	7.67080E-01	6.41690E-01	4.92230E-01	9.52560E-01

2.63180E+03	7.69060E-01	6.41520E-01	4.93370E-01	9.54770E-01
2.63200E+03	7.70950E-01	6.41360E-01	4.94460E-01	9.56880E-01
2.63220E+03	7.72760E-01	6.41220E-01	4.95510E-01	9.58920E-01
2.63240E+03	7.74500E-01	6.41080E-01	4.96520E-01	9.60870E-01
2.63260E+03	7.76160E-01	6.40940E-01	4.97470E-01	9.62720E-01
2.63280E+03	7.77740E-01	6.40800E-01	4.98380E-01	9.64470E-01
2.63300E+03	7.79260E-01	6.40640E-01	4.99220E-01	9.66100E-01
2.63320E+03	7.80700E-01	6.40470E-01	5.00010E-01	9.67630E-01
2.63340E+03	7.82070E-01	6.40300E-01	5.00760E-01	9.69080E-01
2.63360E+03	7.83380E-01	6.40130E-01	5.01470E-01	9.70450E-01
2.63380E+03	7.84630E-01	6.39970E-01	5.02130E-01	9.71740E-01
2.63400E+03	7.85810E-01	6.39800E-01	5.02760E-01	9.72950E-01
2.63420E+03	7.86940E-01	6.39750E-01	5.03440E-01	9.74270E-01
2.63440E+03	7.88010E-01	6.39700E-01	5.04100E-01	9.75530E-01
2.63460E+03	7.89030E-01	6.39660E-01	5.04710E-01	9.76730E-01
2.63480E+03	7.90000E-01	6.39620E-01	5.05300E-01	9.77870E-01
2.63500E+03	7.90930E-01	6.39580E-01	5.05860E-01	9.78940E-01
2.63520E+03	7.91800E-01	6.39680E-01	5.06500E-01	9.80180E-01
2.63540E+03	7.92640E-01	6.39770E-01	5.07110E-01	9.81370E-01
2.63560E+03	7.93430E-01	6.39870E-01	5.07700E-01	9.82500E-01
2.63580E+03	7.94190E-01	6.39970E-01	5.08260E-01	9.83590E-01
2.63600E+03	7.94920E-01	6.40070E-01	5.08800E-01	9.84640E-01
2.63620E+03	7.95600E-01	6.40040E-01	5.09210E-01	9.85440E-01
2.63640E+03	7.96260E-01	6.39970E-01	5.09580E-01	9.86140E-01
2.63660E+03	7.96880E-01	6.39890E-01	5.09920E-01	9.86810E-01
2.63680E+03	7.97480E-01	6.39820E-01	5.10250E-01	9.87430E-01
2.63700E+03	7.98050E-01	6.39770E-01	5.10560E-01	9.88050E-01
2.63720E+03	7.98590E-01	6.39720E-01	5.10870E-01	9.88650E-01
2.63740E+03	7.99100E-01	6.39340E-01	5.10890E-01	9.88690E-01
2.63760E+03	7.99590E-01	6.38950E-01	5.10900E-01	9.88700E-01
2.63780E+03	8.00050E-01	6.38570E-01	5.10890E-01	9.88670E-01
2.63800E+03	8.00490E-01	6.38180E-01	5.10850E-01	9.88610E-01
2.63820E+03	8.00900E-01	6.37760E-01	5.10780E-01	9.88460E-01
2.63840E+03	8.01290E-01	6.37330E-01	5.10690E-01	9.88290E-01
2.63860E+03	8.01650E-01	6.36910E-01	5.10580E-01	9.88080E-01
2.63880E+03	8.02000E-01	6.36480E-01	5.10460E-01	9.87840E-01
2.63900E+03	8.02310E-01	6.36060E-01	5.10320E-01	9.87580E-01
2.63920E+03	8.02610E-01	6.35640E-01	5.10170E-01	9.87290E-01
2.63940E+03	8.02880E-01	6.35220E-01	5.10010E-01	9.86980E-01
2.63960E+03	8.03140E-01	6.34750E-01	5.09790E-01	9.86560E-01
2.63980E+03	8.03370E-01	6.34290E-01	5.09570E-01	9.86120E-01
2.64000E+03	8.03570E-01	6.33830E-01	5.09330E-01	9.85650E-01
2.64020E+03	8.03760E-01	6.33430E-01	5.09120E-01	9.85270E-01

2.64040E+03	8.03930E-01	6.33030E-01	5.08910E-01	9.84850E-01
2.64060E+03	8.04090E-01	6.32630E-01	5.08690E-01	9.84420E-01
2.64080E+03	8.04220E-01	6.32230E-01	5.08450E-01	9.83960E-01
2.64100E+03	8.04340E-01	6.31830E-01	5.08200E-01	9.83490E-01
2.64120E+03	8.04450E-01	6.31430E-01	5.07950E-01	9.83000E-01
72.64140E+03	8.04540E-01	6.31040E-01	5.07690E-01	9.82490E-01
2.64160E+03	8.04620E-01	6.30640E-01	5.07420E-01	9.81980E-01
2.64180E+03	8.04690E-01	6.30530E-01	5.07380E-01	9.81890E-01
2.64200E+03	8.04760E-01	6.30410E-01	5.07330E-01	9.81790E-01
2.64220E+03	8.04810E-01	6.30260E-01	5.07240E-01	9.81620E-01
2.64240E+03	8.04870E-01	6.30110E-01	5.07150E-01	9.81450E-01
2.64260E+03	8.04920E-01	6.29950E-01	5.07060E-01	9.81270E-01
2.64280E+03	8.04980E-01	6.29800E-01	5.06970E-01	9.81100E-01
2.64300E+03	8.05030E-01	6.29640E-01	5.06880E-01	9.80930E-01
2.64320E+03	8.05090E-01	6.29490E-01	5.06800E-01	9.80760E-01
2.64340E+03	8.05150E-01	6.29340E-01	5.06710E-01	9.80600E-01
2.64360E+03	8.05220E-01	6.29190E-01	5.06640E-01	9.80450E-01
2.64380E+03	8.05300E-01	6.29040E-01	5.06560E-01	9.80310E-01
2.64400E+03	8.05380E-01	6.28750E-01	5.06380E-01	9.79960E-01
2.64420E+03	8.05480E-01	6.28450E-01	5.06200E-01	9.79610E-01
2.64440E+03	8.05590E-01	6.28140E-01	5.06020E-01	9.79260E-01
2.64460E+03	8.05700E-01	6.27850E-01	5.05860E-01	9.78950E-01
2.64480E+03	8.05830E-01	6.27560E-01	5.05710E-01	9.78650E-01
2.64500E+03	8.05970E-01	6.27280E-01	5.05570E-01	9.78380E-01
2.64520E+03	8.06120E-01	6.27040E-01	5.05470E-01	9.78190E-01
2.64540E+03	8.06280E-01	6.26800E-01	5.05380E-01	9.78020E-01
2.64560E+03	8.06450E-01	6.26570E-01	5.05300E-01	9.77860E-01
2.64580E+03	8.06630E-01	6.26330E-01	5.05220E-01	9.77710E-01
2.64600E+03	8.06820E-01	6.26100E-01	5.05150E-01	9.77570E-01
2.64620E+03	8.07030E-01	6.26180E-01	5.05340E-01	9.77950E-01
2.64640E+03	8.07230E-01	6.26260E-01	5.05540E-01	9.78330E-01
2.64660E+03	8.07450E-01	6.26350E-01	5.05740E-01	9.78720E-01
2.64680E+03	8.07670E-01	6.26430E-01	5.05950E-01	9.79110E-01
2.64700E+03	8.07890E-01	6.26510E-01	5.06150E-01	9.79520E-01
2.64720E+03	8.08120E-01	6.26600E-01	5.06370E-01	9.79930E-01
2.64740E+03	8.08350E-01	6.26690E-01	5.06580E-01	9.80350E-01
2.64760E+03	8.08580E-01	6.26780E-01	5.06800E-01	9.80770E-01
2.64780E+03	8.08810E-01	6.26870E-01	5.07020E-01	9.81190E-01
2.64800E+03	8.09040E-01	6.26960E-01	5.07230E-01	9.81610E-01
2.64820E+03	8.09270E-01	6.27160E-01	5.07540E-01	9.82210E-01
2.64840E+03	8.09510E-01	6.27360E-01	5.07850E-01	9.82800E-01
2.64860E+03	8.09740E-01	6.27550E-01	5.08150E-01	9.83390E-01
2.64880E+03	8.09970E-01	6.27750E-01	5.08460E-01	9.83980E-01

2.64900E+03	8.10190E-01	6.27950E-01	5.08760E-01	9.84560E-01
2.64920E+03	8.10420E-01	6.28150E-01	5.09070E-01	9.85150E-01
2.64940E+03	8.10650E-01	6.28350E-01	5.09370E-01	9.85740E-01
2.64960E+03	8.10870E-01	6.28550E-01	5.09680E-01	9.86330E-01
2.64980E+03	8.11100E-01	6.28750E-01	5.09980E-01	9.86930E-01
2.65000E+03	8.11330E-01	6.28950E-01	5.10280E-01	9.87510E-01
2.65020E+03	8.11560E-01	6.28950E-01	5.10430E-01	9.87800E-01
2.65040E+03	8.11790E-01	6.28960E-01	5.10580E-01	9.88090E-01
2.65060E+03	8.12030E-01	6.28750E-01	5.10570E-01	9.88060E-01
2.65080E+03	8.12280E-01	6.28550E-01	5.10550E-01	9.88030E-01
2.65100E+03	8.12530E-01	6.28340E-01	5.10550E-01	9.88010E-01
2.65120E+03	8.12780E-01	6.28140E-01	5.10540E-01	9.88010E-01
2.65140E+03	8.13050E-01	6.27940E-01	5.10550E-01	9.88010E-01
2.65160E+03	8.13320E-01	6.27740E-01	5.10550E-01	9.88030E-01
2.65180E+03	8.13600E-01	6.27540E-01	5.10570E-01	9.88060E-01
2.65200E+03	8.13890E-01	6.27340E-01	5.10590E-01	9.88100E-01
2.65220E+03	8.14200E-01	6.27310E-01	5.10760E-01	9.88420E-01
2.65240E+03	8.14510E-01	6.27320E-01	5.10960E-01	9.88810E-01
2.65260E+03	8.14830E-01	6.27320E-01	5.11160E-01	9.89200E-01
2.65280E+03	8.15160E-01	6.27290E-01	5.11350E-01	9.89560E-01
2.65300E+03	8.15510E-01	6.27270E-01	5.11540E-01	9.89940E-01
2.65320E+03	8.15860E-01	6.27240E-01	5.11730E-01	9.90320E-01
2.65340E+03	8.16220E-01	6.27210E-01	5.11940E-01	9.90710E-01
2.65360E+03	8.16580E-01	6.27180E-01	5.12140E-01	9.91110E-01
2.65380E+03	8.16950E-01	6.27150E-01	5.12350E-01	9.91510E-01
2.65400E+03	8.17330E-01	6.27120E-01	5.12570E-01	9.91920E-01
2.65420E+03	8.17710E-01	6.27180E-01	5.12850E-01	9.92480E-01
2.65440E+03	8.18100E-01	6.27240E-01	5.13140E-01	9.93040E-01
2.65460E+03	8.18480E-01	6.27300E-01	5.13430E-01	9.93610E-01
2.65480E+03	8.18860E-01	6.27370E-01	5.13720E-01	9.94170E-01
2.65500E+03	8.19230E-01	6.27620E-01	5.14170E-01	9.95020E-01
2.65520E+03	8.19600E-01	6.27870E-01	5.14600E-01	9.95870E-01
2.65540E+03	8.19970E-01	6.28120E-01	5.15040E-01	9.96710E-01
2.65560E+03	8.20320E-01	6.28370E-01	5.15460E-01	9.97530E-01
2.65580E+03	8.20660E-01	6.28620E-01	5.15880E-01	9.98350E-01
2.65600E+03	8.20990E-01	6.28820E-01	5.16260E-01	9.99070E-01
2.65620E+03	8.21300E-01	6.28730E-01	5.16370E-01	9.99300E-01
2.65640E+03	8.21600E-01	6.28630E-01	5.16480E-01	9.99510E-01
2.65660E+03	8.21880E-01	6.28540E-01	5.16580E-01	9.99690E-01
2.65680E+03	8.22140E-01	6.28440E-01	5.16670E-01	9.99860E-01
2.65700E+03	8.22380E-01	6.28350E-01	5.16740E-01	1.00000E+00
2.65720E+03	8.22600E-01	6.28170E-01	5.16730E-01	9.99990E-01
2.65740E+03	8.22800E-01	6.28000E-01	5.16710E-01	9.99950E-01

2.65760E+03	8.22970E-01	6.27820E-01	5.16680E-01	9.99880E-01
2.65780E+03	8.23130E-01	6.27650E-01	5.16630E-01	9.99790E-01
2.65800E+03	8.23260E-01	6.27470E-01	5.16570E-01	9.99670E-01
2.65820E+03	8.23360E-01	6.27400E-01	5.16580E-01	9.99690E-01
2.65840E+03	8.23450E-01	6.27340E-01	5.16580E-01	9.99700E-01
2.65860E+03	8.23510E-01	6.27280E-01	5.16570E-01	9.99680E-01
2.65880E+03	8.23560E-01	6.27210E-01	5.16540E-01	9.99620E-01
2.65900E+03	8.23580E-01	6.27140E-01	5.16500E-01	9.99540E-01
2.65920E+03	8.23590E-01	6.27070E-01	5.16450E-01	9.99440E-01
2.65940E+03	8.23570E-01	6.26870E-01	5.16270E-01	9.99100E-01
2.65960E+03	8.23540E-01	6.26660E-01	5.16080E-01	9.98730E-01
2.65980E+03	8.23490E-01	6.26450E-01	5.15880E-01	9.98340E-01
2.66000E+03	8.23430E-01	6.26250E-01	5.15670E-01	9.97930E-01
2.66020E+03	8.23350E-01	6.26070E-01	5.15480E-01	9.97560E-01
2.66040E+03	8.23260E-01	6.25890E-01	5.15270E-01	9.97160E-01
2.66060E+03	8.23150E-01	6.25720E-01	5.15060E-01	9.96760E-01
2.66080E+03	8.23040E-01	6.25540E-01	5.14840E-01	9.96330E-01
2.66100E+03	8.22910E-01	6.25360E-01	5.14620E-01	9.95900E-01
2.66120E+03	8.22780E-01	6.25180E-01	5.14380E-01	9.95440E-01
2.66140E+03	8.22630E-01	6.24990E-01	5.14140E-01	9.94970E-01
2.66160E+03	8.22480E-01	6.25080E-01	5.14110E-01	9.94920E-01
2.66180E+03	8.22310E-01	6.25160E-01	5.14080E-01	9.94850E-01
2.66200E+03	8.22140E-01	6.25240E-01	5.14030E-01	9.94760E-01
2.66220E+03	8.21960E-01	6.25180E-01	5.13870E-01	9.94450E-01
2.66240E+03	8.21780E-01	6.25120E-01	5.13710E-01	9.94130E-01
2.66260E+03	8.21580E-01	6.25060E-01	5.13540E-01	9.93800E-01
2.66280E+03	8.21380E-01	6.25000E-01	5.13360E-01	9.93460E-01
2.66300E+03	8.21160E-01	6.24940E-01	5.13180E-01	9.93100E-01
2.66320E+03	8.20940E-01	6.24880E-01	5.12980E-01	9.92730E-01
2.66340E+03	8.20700E-01	6.24810E-01	5.12790E-01	9.92350E-01
2.66360E+03	8.20460E-01	6.24750E-01	5.12580E-01	9.91950E-01
2.66380E+03	8.20200E-01	6.24580E-01	5.12280E-01	9.91380E-01
2.66400E+03	8.19930E-01	6.24430E-01	5.11990E-01	9.90810E-01
2.66420E+03	8.19650E-01	6.24370E-01	5.11760E-01	9.90360E-01
2.66440E+03	8.19350E-01	6.24300E-01	5.11520E-01	9.89900E-01
2.66460E+03	8.19030E-01	6.24240E-01	5.11270E-01	9.89420E-01
2.66480E+03	8.18700E-01	6.24180E-01	5.11010E-01	9.88920E-01
2.66500E+03	8.18350E-01	6.24110E-01	5.10740E-01	9.88400E-01
2.66520E+03	8.17980E-01	6.24070E-01	5.10480E-01	9.87890E-01
2.66540E+03	8.17600E-01	6.24030E-01	5.10200E-01	9.87350E-01
2.66560E+03	8.17190E-01	6.23990E-01	5.09920E-01	9.86800E-01
2.66580E+03	8.16760E-01	6.23950E-01	5.09620E-01	9.86220E-01
2.66600E+03	8.16310E-01	6.23920E-01	5.09320E-01	9.85640E-01

2.66620E+03	8.15850E-01	6.23970E-01	5.09060E-01	9.85140E-01
2.66640E+03	8.15350E-01	6.24020E-01	5.08800E-01	9.84630E-01
2.66660E+03	8.14840E-01	6.24070E-01	5.08520E-01	9.84090E-01
2.66680E+03	8.14310E-01	6.24120E-01	5.08230E-01	9.83530E-01
2.66700E+03	8.13750E-01	6.24170E-01	5.07920E-01	9.82930E-01
2.66720E+03	8.13180E-01	6.24220E-01	5.07600E-01	9.82310E-01
2.66740E+03	8.12580E-01	6.24270E-01	5.07260E-01	9.81660E-01
2.66760E+03	8.11960E-01	6.24310E-01	5.06920E-01	9.80990E-01
2.66780E+03	8.11320E-01	6.24360E-01	5.06560E-01	9.80290E-01
2.66800E+03	8.10660E-01	6.24410E-01	5.06180E-01	9.79570E-01
2.66820E+03	8.09980E-01	6.24340E-01	5.05700E-01	9.78640E-01
2.66840E+03	8.09290E-01	6.24260E-01	5.05210E-01	9.77690E-01
2.66860E+03	8.08580E-01	6.24190E-01	5.04700E-01	9.76710E-01
2.66880E+03	8.07850E-01	6.24110E-01	5.04190E-01	9.75710E-01
2.66900E+03	8.07100E-01	6.24040E-01	5.03660E-01	9.74690E-01
2.66920E+03	8.06340E-01	6.23960E-01	5.03130E-01	9.73660E-01
2.66940E+03	8.05570E-01	6.23890E-01	5.02590E-01	9.72620E-01
2.66960E+03	8.04790E-01	6.23820E-01	5.02040E-01	9.71560E-01
2.66980E+03	8.03990E-01	6.23750E-01	5.01480E-01	9.70480E-01
2.67000E+03	8.03170E-01	6.23680E-01	5.00920E-01	9.69390E-01
2.67020E+03	8.02350E-01	6.23610E-01	5.00360E-01	9.68290E-01
2.67040E+03	8.01520E-01	6.23710E-01	4.99910E-01	9.67440E-01
2.67060E+03	8.00670E-01	6.23810E-01	4.99470E-01	9.66570E-01
2.67080E+03	7.99820E-01	6.23910E-01	4.99010E-01	9.65690E-01
2.67100E+03	7.98950E-01	6.24010E-01	4.98550E-01	9.64800E-01
2.67120E+03	7.98080E-01	6.24100E-01	4.98080E-01	9.63890E-01
2.67140E+03	7.97190E-01	6.24200E-01	4.97600E-01	9.62970E-01
2.67160E+03	7.96290E-01	6.24290E-01	4.97120E-01	9.62030E-01
2.67180E+03	7.95380E-01	6.24390E-01	4.96630E-01	9.61080E-01
2.67200E+03	7.94460E-01	6.24490E-01	4.96130E-01	9.60110E-01
2.67220E+03	7.93530E-01	6.24500E-01	4.95560E-01	9.59020E-01
2.67240E+03	7.92580E-01	6.24520E-01	4.94980E-01	9.57900E-01
2.67260E+03	7.91620E-01	6.24470E-01	4.94350E-01	9.56670E-01
2.67280E+03	7.90650E-01	6.24430E-01	4.93700E-01	9.55420E-01
2.67300E+03	7.89660E-01	6.24380E-01	4.93050E-01	9.54160E-01
2.67320E+03	7.88660E-01	6.24340E-01	4.92390E-01	9.52880E-01
2.67340E+03	7.87640E-01	6.24300E-01	4.91720E-01	9.51590E-01
2.67360E+03	7.86610E-01	6.24260E-01	4.91050E-01	9.50280E-01
2.67380E+03	7.85560E-01	6.24220E-01	4.90360E-01	9.48950E-01
2.67400E+03	7.84490E-01	6.24180E-01	4.89660E-01	9.47600E-01
2.67420E+03	7.83400E-01	6.24270E-01	4.89060E-01	9.46430E-01
2.67440E+03	7.82300E-01	6.24360E-01	4.88440E-01	9.45240E-01
2.67460E+03	7.81180E-01	6.24460E-01	4.87820E-01	9.44030E-01

2.67480E+03	7.80050E-01	6.24410E-01	4.87070E-01	9.42590E-01
2.67500E+03	7.78900E-01	6.24360E-01	4.86320E-01	9.41130E-01
2.67520E+03	7.77730E-01	6.24300E-01	4.85540E-01	9.39620E-01
2.67540E+03	7.76550E-01	6.24240E-01	4.84750E-01	9.38100E-01
2.67560E+03	7.75350E-01	6.24170E-01	4.83960E-01	9.36560E-01
2.67580E+03	7.74150E-01	6.24110E-01	4.83150E-01	9.35000E-01
2.67600E+03	7.72930E-01	6.24050E-01	4.82340E-01	9.33430E-01
2.67620E+03	7.71690E-01	6.24020E-01	4.81550E-01	9.31910E-01
2.67640E+03	7.70460E-01	6.24000E-01	4.80760E-01	9.30380E-01
2.67660E+03	7.69210E-01	6.23980E-01	4.79970E-01	9.28840E-01
2.67680E+03	7.67960E-01	6.23960E-01	4.79170E-01	9.27300E-01
2.67700E+03	7.66710E-01	6.24030E-01	4.78440E-01	9.25890E-01
2.67720E+03	7.65450E-01	6.24090E-01	4.77710E-01	9.24470E-01
2.67740E+03	7.64200E-01	6.24150E-01	4.76970E-01	9.23040E-01
2.67760E+03	7.62950E-01	6.24210E-01	4.76240E-01	9.21620E-01
2.67780E+03	7.61700E-01	6.24270E-01	4.75510E-01	9.20210E-01
2.67800E+03	7.60460E-01	6.24330E-01	4.74780E-01	9.18800E-01
2.67820E+03	7.59240E-01	6.24370E-01	4.74040E-01	9.17380E-01
2.67840E+03	7.58020E-01	6.24410E-01	4.73310E-01	9.15960E-01
2.67860E+03	7.56810E-01	6.24450E-01	4.72590E-01	9.14570E-01
2.67880E+03	7.55620E-01	6.24490E-01	4.71880E-01	9.13180E-01
2.67900E+03	7.54440E-01	6.24530E-01	4.71170E-01	9.11820E-01
2.67920E+03	7.53280E-01	6.24450E-01	4.70390E-01	9.10310E-01
2.67940E+03	7.52140E-01	6.24370E-01	4.69620E-01	9.08810E-01
2.67960E+03	7.51020E-01	6.24290E-01	4.68860E-01	9.07340E-01
2.67980E+03	7.49920E-01	6.24220E-01	4.68110E-01	9.05890E-01
2.68000E+03	7.48830E-01	6.24140E-01	4.67370E-01	9.04470E-01
2.68020E+03	7.47770E-01	6.23960E-01	4.66580E-01	9.02920E-01
2.68040E+03	7.46720E-01	6.23770E-01	4.65780E-01	9.01380E-01
2.68060E+03	7.45700E-01	6.23570E-01	4.65000E-01	8.99870E-01
2.68080E+03	7.44690E-01	6.23380E-01	4.64220E-01	8.98370E-01
2.68100E+03	7.43700E-01	6.23190E-01	4.63470E-01	8.96910E-01
2.68120E+03	7.42730E-01	6.23000E-01	4.62720E-01	8.95460E-01
2.68140E+03	7.41780E-01	6.23100E-01	4.62210E-01	8.94470E-01
2.68160E+03	7.40850E-01	6.23210E-01	4.61710E-01	8.93500E-01
2.68180E+03	7.39920E-01	6.23320E-01	4.61210E-01	8.92540E-01
2.68200E+03	7.39020E-01	6.23430E-01	4.60730E-01	8.91610E-01
2.68220E+03	7.38120E-01	6.23510E-01	4.60230E-01	8.90640E-01
2.68240E+03	7.37240E-01	6.23590E-01	4.59740E-01	8.89690E-01
2.68260E+03	7.36370E-01	6.23670E-01	4.59250E-01	8.88760E-01
2.68280E+03	7.35510E-01	6.23750E-01	4.58780E-01	8.87830E-01
2.68300E+03	7.34650E-01	6.23830E-01	4.58300E-01	8.86910E-01
2.68320E+03	7.33810E-01	6.23910E-01	4.57830E-01	8.86010E-01

2.68340E+03	7.32970E-01	6.23990E-01	4.57370E-01	8.85110E-01
2.68360E+03	7.32140E-01	6.23930E-01	4.56800E-01	8.84020E-01
2.68380E+03	7.31310E-01	6.23870E-01	4.56250E-01	8.82930E-01
2.68400E+03	7.30490E-01	6.23810E-01	4.55690E-01	8.81860E-01
2.68420E+03	7.29680E-01	6.23780E-01	4.55160E-01	8.80830E-01
2.68440E+03	7.28870E-01	6.23750E-01	4.54630E-01	8.79820E-01
2.68460E+03	7.28070E-01	6.23720E-01	4.54110E-01	8.78810E-01
2.68480E+03	7.27280E-01	6.23690E-01	4.53590E-01	8.77800E-01
2.68500E+03	7.26490E-01	6.23660E-01	4.53080E-01	8.76810E-01
2.68520E+03	7.25710E-01	6.23640E-01	4.52580E-01	8.75850E-01
2.68540E+03	7.24940E-01	6.23630E-01	4.52090E-01	8.74900E-01
2.68560E+03	7.24180E-01	6.23610E-01	4.51610E-01	8.73960E-01
2.68580E+03	7.23430E-01	6.23440E-01	4.51020E-01	8.72820E-01
2.68600E+03	7.22700E-01	6.23270E-01	4.50440E-01	8.71690E-01
2.68620E+03	7.21970E-01	6.23000E-01	4.49790E-01	8.70440E-01
2.68640E+03	7.21270E-01	6.22730E-01	4.49150E-01	8.69210E-01
2.68660E+03	7.20570E-01	6.22460E-01	4.48520E-01	8.67990E-01
2.68680E+03	7.19900E-01	6.22180E-01	4.47910E-01	8.66790E-01
2.68700E+03	7.19240E-01	6.21910E-01	4.47300E-01	8.65620E-01
2.68720E+03	7.18600E-01	6.21640E-01	4.46710E-01	8.64480E-01
2.68740E+03	7.17990E-01	6.21370E-01	4.46130E-01	8.63360E-01
2.68760E+03	7.17390E-01	6.21090E-01	4.45570E-01	8.62270E-01
2.68780E+03	7.16820E-01	6.20820E-01	4.45020E-01	8.61210E-01
2.68800E+03	7.16270E-01	6.20690E-01	4.44580E-01	8.60360E-01
2.68820E+03	7.15750E-01	6.20660E-01	4.44240E-01	8.59690E-01
2.68840E+03	7.15250E-01	6.20640E-01	4.43910E-01	8.59060E-01
2.68860E+03	7.14770E-01	6.20590E-01	4.43580E-01	8.58430E-01
2.68880E+03	7.14330E-01	6.20550E-01	4.43280E-01	8.57830E-01
2.68900E+03	7.13900E-01	6.20510E-01	4.42980E-01	8.57270E-01
2.68920E+03	7.13510E-01	6.20460E-01	4.42700E-01	8.56720E-01
2.68940E+03	7.13140E-01	6.20410E-01	4.42440E-01	8.56210E-01
2.68960E+03	7.12790E-01	6.20360E-01	4.42190E-01	8.55730E-01
2.68980E+03	7.12470E-01	6.20310E-01	4.41950E-01	8.55270E-01
2.69000E+03	7.12180E-01	6.20260E-01	4.41730E-01	8.54850E-01
2.69020E+03	7.11910E-01	6.20040E-01	4.41410E-01	8.54230E-01
2.69040E+03	7.11660E-01	6.19830E-01	4.41110E-01	8.53650E-01
2.69060E+03	7.11440E-01	6.19620E-01	4.40820E-01	8.53090E-01
2.69080E+03	7.11250E-01	6.19410E-01	4.40550E-01	8.52560E-01
2.69100E+03	7.11070E-01	6.19200E-01	4.40290E-01	8.52060E-01
2.69120E+03	7.10920E-01	6.18980E-01	4.40040E-01	8.51580E-01
2.69140E+03	7.10790E-01	6.18760E-01	4.39810E-01	8.51130E-01
2.69160E+03	7.10680E-01	6.18550E-01	4.39590E-01	8.50700E-01
2.69180E+03	7.10600E-01	6.18330E-01	4.39380E-01	8.50300E-01

2.69200E+03	7.10530E-01	6.18110E-01	4.39190E-01	8.49920E-01
2.69220E+03	7.10490E-01	6.17880E-01	4.39000E-01	8.49550E-01
2.69240E+03	7.10460E-01	6.17730E-01	4.38870E-01	8.49310E-01
2.69260E+03	7.10460E-01	6.17570E-01	4.38760E-01	8.49090E-01
2.69280E+03	7.10470E-01	6.17410E-01	4.38650E-01	8.48890E-01
2.69300E+03	7.10510E-01	6.17250E-01	4.38570E-01	8.48720E-01
2.69320E+03	7.10570E-01	6.17100E-01	4.38490E-01	8.48570E-01
2.69340E+03	7.10640E-01	6.16950E-01	4.38430E-01	8.48450E-01
2.69360E+03	7.10740E-01	6.16790E-01	4.38380E-01	8.48350E-01
2.69380E+03	7.10850E-01	6.16640E-01	4.38340E-01	8.48280E-01
2.69400E+03	7.10990E-01	6.16510E-01	4.38330E-01	8.48260E-01
2.69420E+03	7.11140E-01	6.16540E-01	4.38450E-01	8.48490E-01
2.69440E+03	7.11310E-01	6.16580E-01	4.38580E-01	8.48750E-01
2.69460E+03	7.11500E-01	6.16700E-01	4.38790E-01	8.49150E-01
2.69480E+03	7.11710E-01	6.16830E-01	4.39010E-01	8.49570E-01
2.69500E+03	7.11940E-01	6.16960E-01	4.39240E-01	8.50020E-01
2.69520E+03	7.12190E-01	6.17080E-01	4.39480E-01	8.50480E-01
2.69540E+03	7.12450E-01	6.17200E-01	4.39730E-01	8.50960E-01
2.69560E+03	7.12730E-01	6.17320E-01	4.39980E-01	8.51460E-01
2.69580E+03	7.13020E-01	6.17450E-01	4.40250E-01	8.51980E-01
2.69600E+03	7.13330E-01	6.17570E-01	4.40530E-01	8.52530E-01
2.69620E+03	7.13650E-01	6.17710E-01	4.40830E-01	8.53100E-01
2.69640E+03	7.13990E-01	6.17850E-01	4.41130E-01	8.53690E-01
2.69660E+03	7.14330E-01	6.17980E-01	4.41450E-01	8.54290E-01
2.69680E+03	7.14690E-01	6.18110E-01	4.41760E-01	8.54890E-01
2.69700E+03	7.15060E-01	6.18230E-01	4.42070E-01	8.55510E-01
2.69720E+03	7.15430E-01	6.18360E-01	4.42400E-01	8.56140E-01
2.69740E+03	7.15820E-01	6.18500E-01	4.42730E-01	8.56780E-01
2.69760E+03	7.16200E-01	6.18630E-01	4.43060E-01	8.57420E-01
2.69780E+03	7.16590E-01	6.18760E-01	4.43400E-01	8.58070E-01
2.69800E+03	7.16980E-01	6.18890E-01	4.43740E-01	8.58720E-01
2.69820E+03	7.17380E-01	6.18870E-01	4.43960E-01	8.59160E-01
2.69840E+03	7.17770E-01	6.18800E-01	4.44160E-01	8.59540E-01
2.69860E+03	7.18160E-01	6.18740E-01	4.44350E-01	8.59920E-01
2.69880E+03	7.18540E-01	6.18680E-01	4.44550E-01	8.60300E-01
2.69900E+03	7.18920E-01	6.18480E-01	4.44640E-01	8.60470E-01
2.69920E+03	7.19290E-01	6.18270E-01	4.44720E-01	8.60630E-01
2.69940E+03	7.19660E-01	6.18070E-01	4.44800E-01	8.60780E-01
2.69960E+03	7.20010E-01	6.17870E-01	4.44870E-01	8.60920E-01
2.69980E+03	7.20350E-01	6.17670E-01	4.44930E-01	8.61040E-01
2.70000E+03	7.20670E-01	6.17470E-01	4.44990E-01	8.61150E-01
2.70020E+03	7.20980E-01	6.17330E-01	4.45080E-01	8.61330E-01
2.70040E+03	7.21270E-01	6.17190E-01	4.45160E-01	8.61480E-01

2.70060E+03	7.21540E-01	6.17050E-01	4.45230E-01	8.61610E-01
2.70080E+03	7.21790E-01	6.16920E-01	4.45280E-01	8.61710E-01
2.70100E+03	7.22010E-01	6.16780E-01	4.45320E-01	8.61790E-01
2.70120E+03	7.22200E-01	6.16700E-01	4.45380E-01	8.61900E-01
2.70140E+03	7.22370E-01	6.16610E-01	4.45420E-01	8.61990E-01
2.70160E+03	7.22500E-01	6.16530E-01	4.45440E-01	8.62030E-01
2.70180E+03	7.22600E-01	6.16440E-01	4.45450E-01	8.62030E-01
2.70200E+03	7.22670E-01	6.16360E-01	4.45420E-01	8.61990E-01
2.70220E+03	7.22690E-01	6.16250E-01	4.45360E-01	8.61870E-01
2.70240E+03	7.22670E-01	6.16150E-01	4.45270E-01	8.61700E-01
2.70260E+03	7.22610E-01	6.16040E-01	4.45160E-01	8.61480E-01
2.70280E+03	7.22500E-01	6.15940E-01	4.45010E-01	8.61190E-01
2.70300E+03	7.22330E-01	6.15830E-01	4.44830E-01	8.60850E-01
2.70320E+03	7.22110E-01	6.15720E-01	4.44620E-01	8.60430E-01
2.70340E+03	7.21820E-01	6.15630E-01	4.44370E-01	8.59960E-01
2.70360E+03	7.21480E-01	6.15540E-01	4.44090E-01	8.59420E-01
2.70380E+03	7.21060E-01	6.15440E-01	4.43770E-01	8.58800E-01
2.70400E+03	7.20580E-01	6.15350E-01	4.43410E-01	8.58090E-01
2.70420E+03	7.20020E-01	6.15310E-01	4.43030E-01	8.57360E-01
2.70440E+03	7.19390E-01	6.15270E-01	4.42610E-01	8.56550E-01
2.70460E+03	7.18670E-01	6.15230E-01	4.42150E-01	8.55650E-01
2.70480E+03	7.17870E-01	6.15190E-01	4.41620E-01	8.54640E-01
2.70500E+03	7.16980E-01	6.15150E-01	4.41050E-01	8.53520E-01
2.70520E+03	7.16000E-01	6.15110E-01	4.40410E-01	8.52300E-01
2.70540E+03	7.14920E-01	6.15070E-01	4.39720E-01	8.50960E-01
2.70560E+03	7.13740E-01	6.15040E-01	4.38980E-01	8.49520E-01
2.70580E+03	7.12470E-01	6.15010E-01	4.38170E-01	8.47960E-01
2.70600E+03	7.11090E-01	6.14970E-01	4.37300E-01	8.46270E-01
2.70620E+03	7.09600E-01	6.14930E-01	4.36360E-01	8.44450E-01
2.70640E+03	7.08010E-01	6.14890E-01	4.35350E-01	8.42490E-01
2.70660E+03	7.06310E-01	6.14850E-01	4.34270E-01	8.40410E-01
2.70680E+03	7.04500E-01	6.14800E-01	4.33130E-01	8.38190E-01
2.70700E+03	7.02570E-01	6.14760E-01	4.31910E-01	8.35850E-01
2.70720E+03	7.00530E-01	6.14730E-01	4.30640E-01	8.33380E-01
2.70740E+03	6.98370E-01	6.14710E-01	4.29300E-01	8.30780E-01
2.70760E+03	6.96100E-01	6.14680E-01	4.27880E-01	8.28040E-01
2.70780E+03	6.93710E-01	6.14640E-01	4.26380E-01	8.25150E-01
2.70800E+03	6.91210E-01	6.14590E-01	4.24810E-01	8.22090E-01
2.70820E+03	6.88580E-01	6.14450E-01	4.23100E-01	8.18790E-01
2.70840E+03	6.85840E-01	6.14290E-01	4.21310E-01	8.15320E-01
2.70860E+03	6.82980E-01	6.14120E-01	4.19430E-01	8.11690E-01
2.70880E+03	6.80010E-01	6.13950E-01	4.17490E-01	8.07930E-01
2.70900E+03	6.76910E-01	6.13780E-01	4.15470E-01	8.04030E-01

2.70920E+03	6.73700E-01	6.13610E-01	4.13380E-01	7.99990E-01
2.70940E+03	6.70360E-01	6.13430E-01	4.11220E-01	7.95810E-01
2.70960E+03	6.66920E-01	6.13260E-01	4.08990E-01	7.91490E-01
2.70980E+03	6.63350E-01	6.13090E-01	4.06690E-01	7.87040E-01
2.71000E+03	6.59670E-01	6.13070E-01	4.04420E-01	7.82650E-01
2.71020E+03	6.55870E-01	6.13130E-01	4.02130E-01	7.78210E-01
2.71040E+03	6.51950E-01	6.13210E-01	3.99780E-01	7.73660E-01
2.71060E+03	6.47920E-01	6.13280E-01	3.97360E-01	7.68970E-01
2.71080E+03	6.43770E-01	6.13360E-01	3.94860E-01	7.64140E-01
2.71100E+03	6.39500E-01	6.13440E-01	3.92290E-01	7.59170E-01
2.71120E+03	6.35120E-01	6.13510E-01	3.89650E-01	7.54060E-01
2.71140E+03	6.30620E-01	6.13580E-01	3.86940E-01	7.48810E-01
2.71160E+03	6.26010E-01	6.13660E-01	3.84160E-01	7.43420E-01
2.71180E+03	6.21280E-01	6.13730E-01	3.81300E-01	7.37900E-01
2.71200E+03	6.16440E-01	6.13800E-01	3.78370E-01	7.32240E-01
2.71220E+03	6.11490E-01	6.13590E-01	3.75200E-01	7.26100E-01
2.71240E+03	6.06420E-01	6.13370E-01	3.71960E-01	7.19830E-01
2.71260E+03	6.01240E-01	6.13150E-01	3.68650E-01	7.13430E-01
2.71280E+03	5.95960E-01	6.12930E-01	3.65280E-01	7.06900E-01
2.71300E+03	5.90560E-01	6.12710E-01	3.61850E-01	7.00250E-01
2.71320E+03	5.85060E-01	6.12500E-01	3.58350E-01	6.93490E-01
2.71340E+03	5.79460E-01	6.12290E-01	3.54800E-01	6.86600E-01
2.71360E+03	5.73760E-01	6.12070E-01	3.51180E-01	6.79610E-01
2.71380E+03	5.67950E-01	6.11860E-01	3.47510E-01	6.72500E-01
2.71400E+03	5.62050E-01	6.11650E-01	3.43780E-01	6.65280E-01
2.71420E+03	5.56060E-01	6.11590E-01	3.40080E-01	6.58140E-01
2.71440E+03	5.49990E-01	6.11440E-01	3.36280E-01	6.50780E-01
2.71460E+03	5.43820E-01	6.11290E-01	3.32430E-01	6.43330E-01
2.71480E+03	5.37580E-01	6.11130E-01	3.28540E-01	6.35790E-01
2.71500E+03	5.31270E-01	6.10980E-01	3.24590E-01	6.28160E-01
2.71520E+03	5.24880E-01	6.10830E-01	3.20620E-01	6.20460E-01
2.71540E+03	5.18430E-01	6.10690E-01	3.16600E-01	6.12690E-01
2.71560E+03	5.11920E-01	6.10540E-01	3.12550E-01	6.04850E-01
2.71580E+03	5.05360E-01	6.10400E-01	3.08470E-01	5.96950E-01
2.71600E+03	4.98750E-01	6.10260E-01	3.04360E-01	5.89010E-01
2.71620E+03	4.92090E-01	6.10160E-01	3.00260E-01	5.81060E-01
2.71640E+03	4.85400E-01	6.10070E-01	2.96130E-01	5.73070E-01
2.71660E+03	4.78670E-01	6.09910E-01	2.91950E-01	5.64980E-01
2.71680E+03	4.71920E-01	6.09740E-01	2.87750E-01	5.56860E-01
2.71700E+03	4.65150E-01	6.09580E-01	2.83550E-01	5.48730E-01
2.71720E+03	4.58370E-01	6.09420E-01	2.79340E-01	5.40580E-01
2.71740E+03	4.51570E-01	6.09260E-01	2.75130E-01	5.32430E-01
2.71760E+03	4.44770E-01	6.09090E-01	2.70910E-01	5.24260E-01

2.71780E+03	4.37970E-01	6.08910E-01	2.66690E-01	5.16090E-01
2.71800E+03	4.31180E-01	6.08710E-01	2.62460E-01	5.07920E-01
2.71820E+03	4.24390E-01	6.08390E-01	2.58200E-01	4.99670E-01
2.71840E+03	4.17620E-01	6.08070E-01	2.53940E-01	4.91440E-01
2.71860E+03	4.10870E-01	6.07750E-01	2.49710E-01	4.83240E-01
2.71880E+03	4.04140E-01	6.07540E-01	2.45530E-01	4.75150E-01
2.71900E+03	3.97430E-01	6.07330E-01	2.41370E-01	4.67100E-01
2.71920E+03	3.90750E-01	6.07110E-01	2.37230E-01	4.59090E-01
2.71940E+03	3.84100E-01	6.06890E-01	2.33110E-01	4.51120E-01
2.71960E+03	3.77490E-01	6.06670E-01	2.29010E-01	4.43190E-01
2.71980E+03	3.70920E-01	6.06450E-01	2.24940E-01	4.35310E-01
2.72000E+03	3.64380E-01	6.06230E-01	2.20900E-01	4.27480E-01
2.72020E+03	3.57880E-01	6.06100E-01	2.16910E-01	4.19770E-01
2.72040E+03	3.51430E-01	6.05960E-01	2.12950E-01	4.12110E-01
2.72060E+03	3.45030E-01	6.05820E-01	2.09030E-01	4.04510E-01
2.72080E+03	3.38670E-01	6.05690E-01	2.05130E-01	3.96970E-01
2.72100E+03	3.32370E-01	6.05540E-01	2.01260E-01	3.89490E-01
2.72120E+03	3.26120E-01	6.05390E-01	1.97430E-01	3.82070E-01
2.72140E+03	3.19920E-01	6.05240E-01	1.93630E-01	3.74720E-01
2.72160E+03	3.13780E-01	6.05100E-01	1.89870E-01	3.67440E-01
2.72180E+03	3.07710E-01	6.04950E-01	1.86150E-01	3.60230E-01
2.72200E+03	3.01690E-01	6.04820E-01	1.82470E-01	3.53110E-01
2.72220E+03	2.95730E-01	6.04810E-01	1.78860E-01	3.46140E-01
2.72240E+03	2.89850E-01	6.04810E-01	1.75300E-01	3.39250E-01
2.72260E+03	2.84030E-01	6.04800E-01	1.71780E-01	3.32430E-01
2.72280E+03	2.78280E-01	6.04800E-01	1.68300E-01	3.25700E-01
2.72300E+03	2.72600E-01	6.04800E-01	1.64870E-01	3.19050E-01
2.72320E+03	2.67000E-01	6.04830E-01	1.61490E-01	3.12510E-01
2.72340E+03	2.61470E-01	6.04860E-01	1.58150E-01	3.06060E-01
2.72360E+03	2.56030E-01	6.04890E-01	1.54870E-01	2.99700E-01
2.72380E+03	2.50660E-01	6.04930E-01	1.51630E-01	2.93440E-01
2.72400E+03	2.45380E-01	6.04950E-01	1.48440E-01	2.87270E-01
2.72420E+03	2.40180E-01	6.04880E-01	1.45280E-01	2.81150E-01
2.72440E+03	2.35070E-01	6.04810E-01	1.42170E-01	2.75130E-01
2.72460E+03	2.30040E-01	6.04740E-01	1.39110E-01	2.69220E-01
2.72480E+03	2.25100E-01	6.04670E-01	1.36110E-01	2.63410E-01
2.72500E+03	2.20250E-01	6.04600E-01	1.33160E-01	2.57700E-01
2.72520E+03	2.15500E-01	6.04530E-01	1.30270E-01	2.52110E-01
2.72540E+03	2.10830E-01	6.04560E-01	1.27460E-01	2.46660E-01
2.72560E+03	2.06250E-01	6.04590E-01	1.24690E-01	2.41310E-01
2.72580E+03	2.01760E-01	6.04620E-01	1.21990E-01	2.36070E-01
2.72600E+03	1.97360E-01	6.04640E-01	1.19330E-01	2.30930E-01
2.72620E+03	1.93050E-01	6.04590E-01	1.16710E-01	2.25870E-01

2.72640E+03	1.88820E-01	6.04540E-01	1.14150E-01	2.20900E-01
2.72660E+03	1.84690E-01	6.04490E-01	1.11640E-01	2.16050E-01
2.72680E+03	1.80630E-01	6.04440E-01	1.09180E-01	2.11290E-01
2.72700E+03	1.76670E-01	6.04380E-01	1.06770E-01	2.06630E-01
2.72720E+03	1.72780E-01	6.04310E-01	1.04410E-01	2.02060E-01
2.72740E+03	1.68980E-01	6.04250E-01	1.02100E-01	1.97590E-01
2.72760E+03	1.65250E-01	6.04110E-01	9.98310E-02	1.93190E-01
2.72780E+03	1.61610E-01	6.03970E-01	9.76050E-02	1.88890E-01
2.72800E+03	1.58030E-01	6.03840E-01	9.54270E-02	1.84670E-01
2.72820E+03	1.54540E-01	6.03880E-01	9.33210E-02	1.80600E-01
2.72840E+03	1.51110E-01	6.03920E-01	9.12590E-02	1.76610E-01
2.72860E+03	1.47760E-01	6.03960E-01	8.92390E-02	1.72700E-01
2.72880E+03	1.44470E-01	6.04000E-01	8.72600E-02	1.68870E-01
2.72900E+03	1.41250E-01	6.04040E-01	8.53220E-02	1.65120E-01
2.72920E+03	1.38100E-01	6.04080E-01	8.34250E-02	1.61440E-01
2.72940E+03	1.35020E-01	6.04130E-01	8.15670E-02	1.57850E-01
2.72960E+03	1.31990E-01	6.04170E-01	7.97460E-02	1.54330E-01
2.72980E+03	1.29040E-01	6.04200E-01	7.79640E-02	1.50880E-01
2.73000E+03	1.26140E-01	6.04230E-01	7.62180E-02	1.47500E-01
2.73020E+03	1.23310E-01	6.04150E-01	7.44970E-02	1.44170E-01
2.73040E+03	1.20540E-01	6.04060E-01	7.28140E-02	1.40910E-01
2.73060E+03	1.17830E-01	6.03980E-01	7.11680E-02	1.37730E-01
2.73080E+03	1.15180E-01	6.03900E-01	6.95590E-02	1.34610E-01
2.73100E+03	1.12600E-01	6.03820E-01	6.79880E-02	1.31570E-01
2.73120E+03	1.10070E-01	6.03740E-01	6.64540E-02	1.28600E-01
2.73140E+03	1.07600E-01	6.03660E-01	6.49560E-02	1.25700E-01
2.73160E+03	1.05200E-01	6.03580E-01	6.34940E-02	1.22870E-01
2.73180E+03	1.02850E-01	6.03500E-01	6.20690E-02	1.20120E-01
2.73200E+03	1.00560E-01	6.03270E-01	6.06650E-02	1.17400E-01
2.73220E+03	9.83280E-02	6.02880E-01	5.92800E-02	1.14720E-01
2.73240E+03	9.61540E-02	6.02470E-01	5.79300E-02	1.12110E-01
2.73260E+03	9.40350E-02	6.02070E-01	5.66150E-02	1.09560E-01
2.73280E+03	9.19700E-02	6.01660E-01	5.53340E-02	1.07080E-01
2.73300E+03	8.99580E-02	6.01250E-01	5.40870E-02	1.04670E-01
2.73320E+03	8.79980E-02	6.00840E-01	5.28720E-02	1.02320E-01
2.73340E+03	8.60860E-02	6.00420E-01	5.16880E-02	1.00030E-01
2.73360E+03	8.42230E-02	6.00010E-01	5.05340E-02	9.77950E-02
2.73380E+03	8.24040E-02	5.99600E-01	4.94090E-02	9.56170E-02
2.73400E+03	8.06280E-02	5.99180E-01	4.83110E-02	9.34920E-02
2.73420E+03	7.88920E-02	5.98920E-01	4.72500E-02	9.14390E-02
2.73440E+03	7.71950E-02	5.98660E-01	4.62130E-02	8.94330E-02
2.73460E+03	7.55330E-02	5.98400E-01	4.51990E-02	8.74690E-02
2.73480E+03	7.39040E-02	5.98140E-01	4.42040E-02	8.55450E-02

2.73500E+03	7.23050E-02	5.97880E-01	4.32290E-02	8.36580E-02
2.73520E+03	7.07350E-02	5.97640E-01	4.22740E-02	8.18100E-02
2.73540E+03	6.91920E-02	5.97400E-01	4.13350E-02	7.99920E-02
2.73560E+03	6.76720E-02	5.97170E-01	4.04120E-02	7.82050E-02
2.73580E+03	6.61750E-02	5.96930E-01	3.95020E-02	7.64450E-02
2.73600E+03	6.47000E-02	5.96710E-01	3.86070E-02	7.47130E-02
2.73620E+03	6.32450E-02	5.96660E-01	3.77360E-02	7.30270E-02
2.73640E+03	6.18090E-02	5.96740E-01	3.68840E-02	7.13780E-02
2.73660E+03	6.03920E-02	5.96830E-01	3.60430E-02	6.97510E-02
2.73680E+03	5.89930E-02	5.96910E-01	3.52140E-02	6.81460E-02
2.73700E+03	5.76140E-02	5.96990E-01	3.43950E-02	6.65620E-02
2.73720E+03	5.62540E-02	5.97080E-01	3.35880E-02	6.50010E-02
2.73740E+03	5.49150E-02	5.97170E-01	3.27940E-02	6.34630E-02
2.73760E+03	5.35980E-02	5.97260E-01	3.20120E-02	6.19500E-02
2.73780E+03	5.23050E-02	5.97340E-01	3.12440E-02	6.04630E-02
2.73800E+03	5.10360E-02	5.97420E-01	3.04900E-02	5.90050E-02
2.73820E+03	5.09930E-02	5.97410E-01	3.04640E-02	5.89540E-02
2.73840E+03	4.98430E-02	5.97390E-01	2.97760E-02	5.76220E-02
2.73860E+03	4.87240E-02	5.97150E-01	2.90950E-02	5.63060E-02
2.73880E+03	4.76360E-02	5.96920E-01	2.84350E-02	5.50270E-02
2.73900E+03	4.65800E-02	5.96680E-01	2.77930E-02	5.37860E-02
2.73920E+03	4.55570E-02	5.96440E-01	2.71720E-02	5.25830E-02
2.73940E+03	4.45650E-02	5.96200E-01	2.65700E-02	5.14190E-02
2.73960E+03	4.36060E-02	5.95970E-01	2.59880E-02	5.02920E-02
2.73980E+03	4.26790E-02	5.95730E-01	2.54250E-02	4.92020E-02
2.74000E+03	4.17830E-02	5.95490E-01	2.48810E-02	4.81510E-02
2.74020E+03	4.09180E-02	5.95270E-01	2.43580E-02	4.71370E-02
2.74040E+03	4.00840E-02	5.95060E-01	2.38530E-02	4.61600E-02
2.74060E+03	3.92810E-02	5.94840E-01	2.33660E-02	4.52180E-02
2.74080E+03	3.85060E-02	5.94530E-01	2.28930E-02	4.43020E-02
2.74100E+03	3.77580E-02	5.94220E-01	2.24370E-02	4.34200E-02
2.74120E+03	3.70380E-02	5.93910E-01	2.19970E-02	4.25700E-02
2.74140E+03	3.63430E-02	5.93600E-01	2.15730E-02	4.17490E-02
2.74160E+03	3.56720E-02	5.93290E-01	2.11640E-02	4.09570E-02
2.74180E+03	3.50230E-02	5.92990E-01	2.07680E-02	4.01910E-02
2.74200E+03	3.43950E-02	5.92670E-01	2.03850E-02	3.94490E-02
2.74220E+03	3.37860E-02	5.92330E-01	2.00120E-02	3.87280E-02
2.74240E+03	3.31930E-02	5.91980E-01	1.96500E-02	3.80260E-02
2.74260E+03	3.26160E-02	5.91630E-01	1.92970E-02	3.73430E-02
2.74280E+03	3.20510E-02	5.91290E-01	1.89520E-02	3.66750E-02
2.74300E+03	3.14990E-02	5.91040E-01	1.86170E-02	3.60280E-02
2.74320E+03	3.09560E-02	5.90800E-01	1.82890E-02	3.53920E-02
2.74340E+03	3.04200E-02	5.90570E-01	1.79650E-02	3.47670E-02

2.74360E+03	2.98910E-02	5.90330E-01	1.76460E-02	3.41480E-02
2.74380E+03	2.93670E-02	5.90100E-01	1.73290E-02	3.35360E-02
2.74400E+03	2.88450E-02	5.89860E-01	1.70150E-02	3.29270E-02
2.74420E+03	2.83260E-02	5.89550E-01	1.67000E-02	3.23180E-02
2.74440E+03	2.78090E-02	5.89240E-01	1.63860E-02	3.17100E-02
2.74460E+03	2.72910E-02	5.88930E-01	1.60720E-02	3.11030E-02
2.74480E+03	2.67730E-02	5.88620E-01	1.57590E-02	3.04970E-02
2.74500E+03	2.62540E-02	5.88310E-01	1.54450E-02	2.98900E-02
2.74520E+03	2.57340E-02	5.88100E-01	1.51340E-02	2.92870E-02
2.74540E+03	2.52130E-02	5.87890E-01	1.48220E-02	2.86840E-02
2.74560E+03	2.46910E-02	5.87680E-01	1.45100E-02	2.80810E-02
2.74580E+03	2.41690E-02	5.87470E-01	1.41980E-02	2.74770E-02
2.74600E+03	2.36470E-02	5.87280E-01	1.38870E-02	2.68750E-02
2.74620E+03	2.31260E-02	5.87240E-01	1.35800E-02	2.62810E-02
2.74640E+03	2.26060E-02	5.87200E-01	1.32750E-02	2.56890E-02
2.74660E+03	2.20900E-02	5.87160E-01	1.29700E-02	2.51010E-02
2.74680E+03	2.15780E-02	5.87110E-01	1.26690E-02	2.45170E-02
2.74700E+03	2.10710E-02	5.87070E-01	1.23700E-02	2.39390E-02
2.74720E+03	2.05710E-02	5.87020E-01	1.20760E-02	2.33690E-02
2.74740E+03	2.00790E-02	5.86940E-01	1.17850E-02	2.28070E-02
2.74760E+03	1.95960E-02	5.86850E-01	1.15000E-02	2.22550E-02
2.74780E+03	1.91230E-02	5.86770E-01	1.12210E-02	2.17150E-02
2.74800E+03	1.86630E-02	5.86690E-01	1.09490E-02	2.11890E-02
2.74820E+03	1.82150E-02	5.86550E-01	1.06840E-02	2.06760E-02
2.74840E+03	1.77810E-02	5.86410E-01	1.04270E-02	2.01780E-02
2.74860E+03	1.73610E-02	5.86270E-01	1.01790E-02	1.96980E-02
2.74880E+03	1.69580E-02	5.86130E-01	9.93940E-03	1.92350E-02
2.74900E+03	1.65700E-02	5.85990E-01	9.71000E-03	1.87910E-02
2.74920E+03	1.61990E-02	5.85840E-01	9.49030E-03	1.83660E-02
2.74940E+03	1.58450E-02	5.85700E-01	9.28040E-03	1.79600E-02
2.74960E+03	1.55080E-02	5.85440E-01	9.07870E-03	1.75690E-02
2.74980E+03	1.51870E-02	5.85170E-01	8.88680E-03	1.71980E-02
2.75000E+03	1.48820E-02	5.84920E-01	8.70490E-03	1.68460E-02
2.75020E+03	1.45940E-02	5.84720E-01	8.53330E-03	1.65140E-02
2.75040E+03	1.43200E-02	5.84530E-01	8.37050E-03	1.61990E-02
2.75060E+03	1.40610E-02	5.84330E-01	8.21620E-03	1.59000E-02
2.75080E+03	1.38150E-02	5.84140E-01	8.06980E-03	1.56170E-02
2.75100E+03	1.35810E-02	5.83950E-01	7.93060E-03	1.53470E-02
2.75120E+03	1.33580E-02	5.83750E-01	7.79780E-03	1.50900E-02
2.75140E+03	1.31450E-02	5.83560E-01	7.67090E-03	1.48450E-02
2.75160E+03	1.29400E-02	5.83360E-01	7.54890E-03	1.46090E-02
2.75180E+03	1.27430E-02	5.83230E-01	7.43190E-03	1.43820E-02
2.75200E+03	1.25510E-02	5.83090E-01	7.31820E-03	1.41620E-02

2.75220E+03	1.23630E-02	5.83000E-01	7.20780E-03	1.39490E-02
2.75240E+03	1.21790E-02	5.82950E-01	7.09960E-03	1.37390E-02
2.75260E+03	1.19960E-02	5.82900E-01	6.99260E-03	1.35320E-02
2.75280E+03	1.18150E-02	5.82850E-01	6.88610E-03	1.33260E-02
2.75300E+03	1.16330E-02	5.82800E-01	6.77950E-03	1.31200E-02
2.75320E+03	1.14500E-02	5.82740E-01	6.67230E-03	1.29120E-02
2.75340E+03	1.12650E-02	5.82690E-01	6.56390E-03	1.27030E-02
2.75360E+03	1.10780E-02	5.82630E-01	6.45420E-03	1.24900E-02
2.75380E+03	1.08880E-02	5.82580E-01	6.34290E-03	1.22750E-02
2.75400E+03	1.06950E-02	5.82610E-01	6.23070E-03	1.20580E-02
2.75420E+03	1.04980E-02	5.82540E-01	6.11550E-03	1.18350E-02
2.75440E+03	1.02980E-02	5.82470E-01	5.99850E-03	1.16080E-02
2.75460E+03	1.00960E-02	5.82400E-01	5.87970E-03	1.13790E-02
2.75480E+03	9.89020E-03	5.82330E-01	5.75930E-03	1.11460E-02
2.75500E+03	9.68240E-03	5.82260E-01	5.63760E-03	1.09100E-02
2.75520E+03	9.47280E-03	5.82150E-01	5.51460E-03	1.06720E-02
2.75540E+03	9.26210E-03	5.82050E-01	5.39100E-03	1.04330E-02
2.75560E+03	9.05090E-03	5.81940E-01	5.26710E-03	1.01930E-02
2.75580E+03	8.84000E-03	5.81840E-01	5.14340E-03	9.95370E-03
2.75600E+03	8.63030E-03	5.81730E-01	5.02050E-03	9.71570E-03
2.75620E+03	8.42250E-03	5.81500E-01	4.89770E-03	9.47810E-03
2.75640E+03	8.21750E-03	5.81270E-01	4.77650E-03	9.24360E-03
2.75660E+03	8.01600E-03	5.81030E-01	4.65760E-03	9.01340E-03
2.75680E+03	7.81880E-03	5.80800E-01	4.54120E-03	8.78810E-03
2.75700E+03	7.62670E-03	5.80570E-01	4.42780E-03	8.56880E-03
2.75720E+03	7.44020E-03	5.80330E-01	4.31780E-03	8.35590E-03
2.75740E+03	7.26000E-03	5.80090E-01	4.21150E-03	8.15010E-03
2.75760E+03	7.08650E-03	5.79860E-01	4.10910E-03	7.95210E-03
2.75780E+03	6.92000E-03	5.79620E-01	4.01100E-03	7.76210E-03
2.75800E+03	6.76090E-03	5.79380E-01	3.91710E-03	7.58050E-03
2.75820E+03	6.60920E-03	5.79210E-01	3.82810E-03	7.40820E-03
2.75840E+03	6.46500E-03	5.78990E-01	3.74320E-03	7.24390E-03
2.75860E+03	6.32830E-03	5.78770E-01	3.66260E-03	7.08800E-03
2.75880E+03	6.19880E-03	5.78550E-01	3.58630E-03	6.94030E-03
2.75900E+03	6.07630E-03	5.78330E-01	3.51410E-03	6.80050E-03
2.75920E+03	5.96040E-03	5.78120E-01	3.44580E-03	6.66840E-03
2.75940E+03	5.85080E-03	5.77910E-01	3.38120E-03	6.54340E-03
2.75960E+03	5.74680E-03	5.77700E-01	3.31990E-03	6.42480E-03
2.75980E+03	5.64800E-03	5.77490E-01	3.26170E-03	6.31200E-03
2.76000E+03	5.55380E-03	5.77270E-01	3.20610E-03	6.20440E-03
2.76020E+03	5.46360E-03	5.76980E-01	3.15240E-03	6.10050E-03
2.76040E+03	5.37670E-03	5.76680E-01	3.10070E-03	6.00040E-03
2.76060E+03	5.29260E-03	5.76520E-01	3.05130E-03	5.90490E-03

2.76080E+03	5.21070E-03	5.76350E-01	3.00320E-03	5.81180E-03
2.76100E+03	5.13050E-03	5.76180E-01	2.95610E-03	5.72070E-03
2.76120E+03	5.05140E-03	5.76020E-01	2.90970E-03	5.63090E-03
2.76140E+03	4.97300E-03	5.75850E-01	2.86370E-03	5.54190E-03
2.76160E+03	4.89500E-03	5.75690E-01	2.81800E-03	5.45340E-03
2.76180E+03	4.81700E-03	5.75520E-01	2.77230E-03	5.36500E-03
2.76200E+03	4.73880E-03	5.75360E-01	2.72650E-03	5.27640E-03
2.76220E+03	4.66020E-03	5.75200E-01	2.68050E-03	5.18740E-03
2.76240E+03	4.58120E-03	5.75030E-01	2.63430E-03	5.09800E-03
2.76260E+03	4.50170E-03	5.74870E-01	2.58790E-03	5.00810E-03
2.76280E+03	4.42180E-03	5.74830E-01	2.54180E-03	4.91890E-03
2.76300E+03	4.34170E-03	5.74780E-01	2.49550E-03	4.82940E-03
2.76320E+03	4.26140E-03	5.74740E-01	2.44920E-03	4.73980E-03
2.76340E+03	4.18140E-03	5.74700E-01	2.40310E-03	4.65050E-03
2.76360E+03	4.10190E-03	5.74660E-01	2.35720E-03	4.56170E-03
2.76380E+03	4.02310E-03	5.74620E-01	2.31180E-03	4.47380E-03
2.76400E+03	3.94560E-03	5.74580E-01	2.26710E-03	4.38720E-03
2.76420E+03	3.86960E-03	5.74540E-01	2.22320E-03	4.30240E-03
2.76440E+03	3.79550E-03	5.74490E-01	2.18050E-03	4.21970E-03
2.76460E+03	3.72360E-03	5.74440E-01	2.13900E-03	4.13950E-03
2.76480E+03	3.65450E-03	5.74400E-01	2.09910E-03	4.06220E-03
2.76500E+03	3.58830E-03	5.74260E-01	2.06060E-03	3.98770E-03
2.76520E+03	3.52530E-03	5.74190E-01	2.02420E-03	3.91720E-03
2.76540E+03	3.46580E-03	5.74110E-01	1.98980E-03	3.85060E-03
2.76560E+03	3.41000E-03	5.74040E-01	1.95750E-03	3.78810E-03
2.76580E+03	3.35790E-03	5.73960E-01	1.92730E-03	3.72970E-03
2.76600E+03	3.30960E-03	5.73890E-01	1.89930E-03	3.67560E-03
2.76620E+03	3.26510E-03	5.73750E-01	1.87340E-03	3.62530E-03
2.76640E+03	3.22430E-03	5.73610E-01	1.84950E-03	3.57910E-03
2.76660E+03	3.18690E-03	5.73470E-01	1.82760E-03	3.53680E-03
2.76680E+03	3.15290E-03	5.73330E-01	1.80770E-03	3.49820E-03
2.76700E+03	3.12190E-03	5.73180E-01	1.78940E-03	3.46290E-03
2.76720E+03	3.09360E-03	5.72880E-01	1.77220E-03	3.42970E-03
2.76740E+03	3.06750E-03	5.72580E-01	1.75640E-03	3.39900E-03
2.76760E+03	3.04320E-03	5.72280E-01	1.74160E-03	3.37030E-03
2.76780E+03	3.02030E-03	5.71980E-01	1.72750E-03	3.34320E-03
2.76800E+03	2.99820E-03	5.71680E-01	1.71400E-03	3.31700E-03
2.76820E+03	2.97660E-03	5.71500E-01	1.70110E-03	3.29200E-03
2.76840E+03	2.95480E-03	5.71330E-01	1.68820E-03	3.26690E-03
2.76860E+03	2.93230E-03	5.71160E-01	1.67480E-03	3.24120E-03
2.76880E+03	2.90880E-03	5.70990E-01	1.66090E-03	3.21420E-03
2.76900E+03	2.88370E-03	5.70820E-01	1.64610E-03	3.18560E-03
2.76920E+03	2.85670E-03	5.70650E-01	1.63020E-03	3.15470E-03

2.76940E+03	2.82730E-03	5.70470E-01	1.61290E-03	3.12130E-03
2.76960E+03	2.79520E-03	5.70290E-01	1.59410E-03	3.08490E-03
2.76980E+03	2.76020E-03	5.70110E-01	1.57360E-03	3.04530E-03
2.77000E+03	2.72210E-03	5.69930E-01	1.55140E-03	3.00220E-03
2.77020E+03	2.68060E-03	5.69770E-01	1.52730E-03	2.95560E-03
2.77040E+03	2.63560E-03	5.69610E-01	1.50130E-03	2.90530E-03
2.77060E+03	2.58730E-03	5.69460E-01	1.47330E-03	2.85120E-03
2.77080E+03	2.53550E-03	5.69300E-01	1.44350E-03	2.79340E-03
2.77100E+03	2.48040E-03	5.69170E-01	1.41180E-03	2.73210E-03
2.77120E+03	2.42220E-03	5.69030E-01	1.37830E-03	2.66740E-03
2.77140E+03	2.36110E-03	5.68900E-01	1.34330E-03	2.59950E-03
2.77160E+03	2.29750E-03	5.68870E-01	1.30700E-03	2.52930E-03
2.77180E+03	2.23160E-03	5.68830E-01	1.26940E-03	2.45660E-03
2.77200E+03	2.24800E-03	5.68790E-01	1.27860E-03	2.47440E-03
2.77220E+03	2.14290E-03	5.68840E-01	1.21900E-03	2.35900E-03
2.77240E+03	2.03670E-03	5.68880E-01	1.15860E-03	2.24220E-03
2.77260E+03	1.93030E-03	5.68920E-01	1.09820E-03	2.12530E-03
2.77280E+03	1.82490E-03	5.68960E-01	1.03830E-03	2.00940E-03
2.77300E+03	1.72160E-03	5.69010E-01	9.79580E-04	1.89570E-03
2.77320E+03	1.62110E-03	5.69040E-01	9.22500E-04	1.78520E-03
2.77340E+03	1.52460E-03	5.69080E-01	8.67610E-04	1.67900E-03
2.77360E+03	1.43270E-03	5.69120E-01	8.15380E-04	1.57790E-03
2.77380E+03	1.34630E-03	5.69110E-01	7.66180E-04	1.48270E-03
2.77400E+03	1.26600E-03	5.69090E-01	7.20490E-04	1.39430E-03
2.77420E+03	1.19250E-03	5.68960E-01	6.78490E-04	1.31300E-03
2.77440E+03	1.12630E-03	5.68840E-01	6.40660E-04	1.23980E-03
2.77460E+03	1.06770E-03	5.68710E-01	6.07220E-04	1.17510E-03
2.77480E+03	1.01720E-03	5.68580E-01	5.78350E-04	1.11920E-03
2.77500E+03	0.00000E+00	5.68450E-01	0.00000E+00	0.00000E+00

Table D.4-14 contains the pre- and post-launch calibration slope and intercept values for NOAA-18 HIRS/305 Channel 20.

Table D.4-14. NOAA-18 HIRS/305 Channel 20 Slope and Intercept (Albedo %).		
Source	Slope	Intercept
Pre-launch calibration	0.0245088	70.4722
Post-launch calibration	TBD	TBD

AMSU-A only (AMSU-B not flown on NOAA-18):

Table D.4-15. NOAA-18 AMSU-A1 (S/N 109, ID=33) PRT Temperature Conversion Coefficients.
--

	PRT #	f_{k0} (K)	f_{k1} (K/count)	f_{k2} (K/count2)	f_{k3} (K/count3)
Scan Motor A1-1	1	264.1476	1.743266E-03	3.348404E-09	1.664095E-14
Scan Motor A1-2	2	263.1678	1.731684E-03	3.541911E-09	1.427281E-14
Feedhorn A1-1	3	263.4037	1.756592E-03	3.025439E-09	2.592502E-14
Feedhorn A1-2	4	263.7585	1.736896E-03	3.524135E-09	9.021489E-15
RF Mux A1-1	5	263.2661	1.734418E-03	3.627309E-09	1.270486E-14
RF Mux A1-2	6	263.6731	1.710861E-03	3.745664E-09	1.954603E-14
L.O. CH 3	7	263.2463	1.736519E-03	3.450645E-09	1.511849E-14
L.O. CH 4	8	263.0471	1.729353E-03	3.629986E-09	1.108148E-14
L.O. CH 5	9	263.4903	1.732073E-03	3.660650E-09	1.059084E-14
L.O. CH 6	10	263.4986	1.743907E-03	3.378800E-09	1.731537E-14
L.O. CH 7	11	263.4426	1.739730E-03	3.231359E-09	1.741037E-14
L.O. CH 8	12	263.1023	1.739080E-03	3.435317E-09	1.558292E-14
L.O. CH 15	13	262.9301	1.733167E-03	3.619563E-09	1.102405E-14
PLLO #2 CH9-14	14	262.2288	1.782365E-03	3.927203E-09	1.074884E-14
PLLO #1 CH9-14	15	263.3337	1.730256E-03	3.892761E-09	6.229168E-15
Not Used	16	263.3337	1.730256E-03	3.892761E-09	6.229168E-15
Mixer/IF CH 3	17	262.5283	1.728151E-03	3.730241E-09	1.055708E-14
Mixer/IF CH 4	18	262.6262	1.735880E-03	3.482120E-09	1.463006E-14
Mixer/IF CH 5	19	263.0344	1.729980E-03	3.817571E-09	1.028369E-14
Mixer/IF CH 6	20	263.3519	1.737770E-03	3.370750E-09	1.684445E-14
Mixer/IF CH 7	21	263.5179	1.740044E-03	3.604026E-09	8.980608E-15
Mixer/IF CH 8	22	262.9976	1.731195E-03	3.710931E-09	1.056478E-14
Mixer/IF CH9 -14	23	262.8521	1.733479E-03	3.670787E-09	1.256491E-14
Mixer/IF CH 15	24	263.6473	1.747099E-03	3.570097E-09	5.402493E-15
IF Amp.CH11 - 14	25	263.3202	1.739659E-03	3.556506E-09	1.392298E-14
IF Amp. CH 9	26	263.3429	1.735609E-03	3.941727E-09	8.254678E-15
IF Amp. Ch.10	27	263.0992	1.736573E-03	3.728037E-09	1.006676E-14
IF Amp. Ch.11	28	263.4255	1.735551E-03	3.770763E-09	5.931839E-15
DC/DC Converter	29	263.7365	1.730352E-03	4.034858E-09	5.881655E-15
IF Amp. Ch.13	30	263.3358	1.738157E-03	3.671254E-09	1.245797E-14
IF Amp. Ch.14	31	263.1836	1.740586E-03	3.337613E-09	1.651644E-14
IF Amp. Ch.12	32	263.4875	1.735195E-03	3.754301E-09	1.074719E-14
RF Shelf A1-1	33	264.1607	1.745635E-03	3.690702E-09	1.142299E-14
RF Shelf A1-2	34	263.4113	1.743746E-03	3.503678E-09	1.460422E-14
Detector/PreAmp	35	263.7069	1.735678E-03	3.727127E-09	1.026177E-14
A1-1WarmLoad#1	36	254.4792	1.632697E-03	5.925882E-09	2.790891E-14
A1-1WarmLoad#2	37	254.9357	1.632574E-03	5.837758E-09	2.895840E-14
A1-1WarmLoad#3	38	254.6461	1.628482E-03	5.867548E-09	2.882307E-14
A1-1WarmLoad#4	39	254.7101	1.628115E-03	5.919407E-09	2.831376E-14
A1-1WmLdCenter	40	254.6003	1.605916E-03	8.652163E-09	-4.137281E-14
A1-2WarmLoad#1	41	255.4882	1.617997E-03	4.542892E-09	6.722034E-14

A1-2WarmLoad#2	42	254.5689	1.632253E-03	5.841521E-09	2.896778E-14
A1-2WarmLoad#3	43	254.4614	1.630541E-03	5.753884E-09	2.950770E-14
A1-2WarmLoad#4	44	254.7519	1.634664E-03	5.835678E-09	2.836517E-14
A1-2WmLdCenter	45	254.8793	1.635115E-03	5.835015E-09	2.919876E-14

Table D.4-16. NOAA-18 AMSU-A2 (S/N 105, ID=18) PRT Temperature Conversion Coefficients.

	PRT #	f _{k0} (K)	f _{k1} (K/count)	f _{k2} (K/count2)	f _{k3} (K/count3)
Scan Motor	1	263.5758	1.767645E-03	3.794875E-09	1.261675E-14
Feedhorn	2	263.1411	1.764382E-03	3.661103E-09	1.305692E-14
RF Diplexer	3	263.1864	1.752475E-03	3.844197E-09	1.227221E-14
Mixer/IF Ch 1	4	263.8281	1.754974E-03	3.802008E-09	1.077093E-14
Mixer/IF Ch 2	5	263.7458	1.756229E-03	3.727035E-09	1.308870E-14
Ch1 DRO	6	263.9707	1.758280E-03	3.718871E-09	1.248273E-14
Ch2 DRO	7	263.4596	1.756287E-03	3.826887E-09	1.288159E-14
Compensator motor	8	263.9833	1.757519E-03	3.769221E-09	1.130973E-14
Sub Reflector	9	262.8663	1.756615E-03	3.798051E-09	1.160802E-14
DC/DC Converter	10	263.8742	1.763420E-03	3.708442E-09	1.357872E-14
RF Shelf	11	263.9671	1.752322E-03	4.039884E-09	9.326652E-15
Detector Pre-Amp	12	263.4358	1.750480E-03	3.754149E-09	1.171233E-14
Warm Load Ctr	13	254.7616	1.653192E-03	5.988277E-09	3.101395E-14
Warm Load #1	14	254.5737	1.652519E-03	5.994369E-09	3.214458E-14
Warm Load #2	15	254.6311	1.658779E-03	6.059266E-09	3.010172E-14
Warm Load #3	16	254.8459	1.655427E-03	6.099508E-09	3.020449E-14
Warm Load #4	17	254.8488	1.652000E-03	6.055910E-09	3.032410E-14
Warm Load #5	18	254.7966	1.647523E-03	6.068692E-09	2.974657E-14
Warm Load #6	19	253.904	1.657694E-03	5.929873E-09	3.021740E-14

Table D.4-17 contains the measured channel characteristics for NOAA-18 AMSU-A (channels 1-15). The central frequencies are interpolated from the temperature dependent data to 15 C. The f1, f2, f3, and f4 for channels 11-14 are computed from tabulated values. All values are for 15 C. Detailed information on the terminology used in this table can be found in Section 3.3.2.1.

Table D.4-17. NOAA-18 AMSU-A Measured Channel Characteristics.

Ch #	Instrument/Serial #	Central Frequency (GHz)	Central Wavenumber (cm ⁻¹)	I/F Frequencies (GHz)			
				Sideband 1		Sideband 2	
				Begin (f ₁)	End (f ₂)	Begin (f ₃)	End (f ₄)
1*	A2/105	23.80084	0.793910	0.00872	0.13423	N/A	N/A
2*	A2/105	31.39952	1.047375	0.00877	0.08912	N/A	N/A
3*	A1-2/109	50.29974	1.677819	0.00890	0.08900	N/A	N/A
4*	A1-2/109	52.80007	1.761221	0.00912	0.19916	N/A	N/A
5	A1-2/109	53.59597	1.787769	0.03138	0.19886	N/A	N/A
6*	A1-1/109	54.40008	1.814591	0.00915	0.19933	N/A	N/A
7*	A1-1/109	54.94034	1.832612	0.00910	0.19919	N/A	N/A
8*	A1-2/109	55.50025	1.851289	0.00914	0.16402	N/A	N/A

9*	A1-1/109	57.29034	1.911000	0.00911	0.16415	N/A	N/A
10	A1-1/109	57.29034	1.911000	0.17901	0.25534	N/A	N/A
11	A1-1/109	57.29034	1.911000	0.25681	0.29166	0.35266	0.38803
12	A1-1/109	57.29034	1.911000	0.29255	0.30798	0.33633	0.35183
13	A1-1/109	57.29034	1.911000	0.30829	0.31614	0.32822	0.33609
14	A1-1/109	57.29034	1.911000	0.31632	0.31925	0.32531	0.32825
15*	A1-1/109	89.00971	2.969044	0.49208	1.48898	N/A	N/A

* The lower frequency cutoff in these single passband channels is due to the stop band.

MHS:

Table D.4-18. NOAA-18 MHS Coefficients for Converting PRT Resistance (ohms) to PRT Temperature (K).

PRT #	f_{k0}	f_{k1}	f_{k2}	f_{k3}	PIE-A/B
A1	26.94696	2.368751	9.006419E-04	3.214243E-07	PIE-A
A2	26.24873	2.388640	7.144522E-04	8.929389E-07	
A3	26.06646	2.390943	7.194693E-04	7.950231E-07	
A4	28.62364	2.319711	1.376538E-03	-1.211872E-06	
A5	27.82947	2.340279	1.202259E-03	-7.307023E-07	
B1	14.60936	2.715144	-2.309837E-03	1.015388E-05	PIE-B
B2	24.56966	2.436255	2.666393E-04	2.288884E-06	
B3	27.79527	2.341127	1.195957E-03	-7.175381E-07	
B4	27.96775	2.335281	1.260284E-03	-9.481001E-07	
B5	23.94741	2.453856	1.013438E-04	2.807177E-06	

Table D.4-19. NOAA-18 MHS Resistances (ohms) for Three PRT Calibration Channels.

Rcal_1	Rcal_2	Rcal_3	PIE-A or -B
117.987	95.287	80.596	PIE-A
117.995	95.293	80.613	PIE-B

Table D.4-20. NOAA-18 MHS Coefficients for Converting Counts into Temperatures (K).

g_0	g_1	g_2	g_3	g_4
355.9982	-0.239278	-4.85712E-03	3.59838E-05	-8.02652E-08

Note:

1. One set of coefficients applies to 24 housekeeping thermistors.

Table D.4-21. NOAA-18 MHS Coefficients for Converting Counts into Current (amps) for Current Monitors .

Intercept	Slope	Name
0.0	0.01337	RDM Motor
0.0	0.01337	FDM Motor
0.0	0.01681	EE+SM+5V
-0.13640	0.022210	Receiver+8V
-0.09704	0.008207	Receiver+15V
-0.006094	0.001875	Receiver-15V

Note:

1. One set of coefficients applies to three survival thermistors.

Table D.4-22. NOAA-18 MHS Coefficients for Converting Volts into Temperatures (K).

h_0	h_1	h_2	h_3	h_4	h_5
363.4522	-108.10	64.212	-22.8659	4.110	-0.295

Table D.4-23. NOAA-18 MHS Values of the Nonlinearity Parameters u (m^2 -sr- cm^{-1})/mW.

Instru- ment Temp. (See Note 1)	Ch 16	Ch 17	Ch. 18	Ch. 19	Ch. 20	LO (C)
14.4	-1.254186 E-01	-1.53510 2E-02	-5.114453E-02	-4.692729E-02	-7.954219E-03	LO-A
25.4	-5.638002 E-03	-2.39221 3E-04	-2.953739E-02	-2.247278E-02	-2.606214E-03	LO-A
38.1	1.180412 E-02	1.670801 E-02	-1.999693E-02	-1.342902E-02	-5.011249E-04	LO-A
14.4	-7.236113 E-02	-9.90711 4E-04	-3.668495E-02	-4.150773E-02	-9.350563E-03	LO-B
25.4	-2.888378 E-02	9.733833 E-04	-1.885327E-02	-2.785992E-02	-4.907237E-03	LO-B
38.1	3.080002 E-02	3.064643 E-02	-1.339739E-02	-1.900996E-02	3.557148E-03	LO-B

Note:

1. QBS5 temperature.

Channel Number	Wavenumber (cm ⁻¹)	Band-correction factors: $T_w = b + c * T_w$	
		b	c
16	2.968720	0.0	1.0
17	5.236956	0.0	1.0
18	6.114597	0.0	1.0
19	6.114597	-0.0031	1.00027
20	6.348092	0.0	1.0

Channel	Nominal Center Frequency (GHz)	Lower IF -3 dB Frequency (GHz)	Upper IF -3 dB Frequency (GHz)	# Bandpasses
H1	89.000	0.111	1.206	1
H2	157.000	0.112	1.208	1
H3	183.311	0.750	1.210	2
H4	183.311	2.525	3.434	2
H5	190.311	0.113	1.079	1

D.5 MetOp-A

Launch date: October 19, 2006

Operational dates: November 28, 2006 to present

Morning orbit: 2130 LST ascending node, 0930 LST descending node

AVHRR instrument: 6 channels (AVHRR/3): FM 305

Spacecraft ID: 12

Abnormalities:

Up to date information regarding abnormalities on the POES spacecraft and instruments can be found at: <http://www.oso.noaa.gov/poesstatus/>. This website allows a user to search and sort on any POES spacecraft, subsystem or instrument status. Once a user narrows down their window of interest, further details can be obtained by going to the NOAA/NESDIS/Office of Satellite Operations' (OSO) archive of weekly status reports at: <http://noaasis.noaa.gov/NOAASIS/ml/podocs.html>

AVHRR:

Table D.5-1 contains the PRT weighting factors for MetOp-A and Table D.5-2 contains the radiance of space and the coefficients for nonlinear radiance correction quadratic for MetOp-A.

Table D.5-1. MetOp-A PRT Weighting Factors.			
b₁	b₂	b₃	b₄
0.25	0.25	0.25	0.25

Table D.5-2. MetOp-A Radiance of Space and coefficients for nonlinear radiance correction quadratic.				
	N_S	b₀	b₁	b₂
Channel 4	-4.98	5.44	-0.10152	0.00046964
Channel 5	-3.40	3.84	-0.06249	0.00025239

Table D.5-3 contains MetOp-A coefficients d₀, d₁, d₂, d₃ and d₄ that relate temperature, T_{PRT} (Kelvin) of each PRT to count value, C_{PRT}, by the equation:

$$T_{PRT} = d_0 + d_1 C_{PRT} + d_2 C_{PRT}^2 + d_3 C_{PRT}^3 + d_4 C_{PRT}^4$$

Table D.5-3. MetOp-A AVHRR/3 conversion coefficients.					
PRT	d₀	d₁	d₂	d₃	d₄
1	276.6194	0.050919	1.470892 E-06	0	0
2	276.6511	0.050892	1.489000 E-06	0	0
3	276.6597	0.050845	1.520646 E-06	0	0
4	276.3685	0.050992	1.482390 E-06	0	0

Table D.5-4 contains the pre-launch calibration coefficients (albedo representation) for the AVHRR/3 instrument on MetOp-A.

Table D.5-4. MetOp-A AVHRR/3 Pre-launch Calibration Coefficients (Albedo Representation).			
Channel #	Contents	Slope	Intercept
1	Low albedo range (0-25%)	.0053714	-2.171861
	High albedo range (26 - 100%)	0.158723	-54.782424
2	Low albedo range (0-25%)	0.0545174	-2.167
	High albedo range (26 - 100%)	0.16192	-55.91
3A	Low albedo range (0-12.5%)	0.026446	-1.087
	High albedo range (12.6 - 100%)	0.18369	-80.01

Note: The albedo ranges given in parentheses are nominal; the points of intersection of the two regression lines are located at 500.54, 500.40 and 500.56 counts for channels 1, 2, and 3A respectively. This information is based on the data in AVHRR S/N A305 Alignment/ Calibration Handbook (Report 8172845, Rev B), January 2002.

Table D.5-5 contains a summary of the spectral response data as a function of wavenumber for all channels of the MetOp-A AVHRR/3.

Table D.5-5. Summary of MetOp-A AVHRR Spectral Response Data (as a Function of Wavenumber) for Each Channel.				
Channel 1				
The peak wavenumber was at 15480.00 and had a value of 1.00.				
File starting point is at wavenumber = 12050.00.				
File ending point is at wavenumber = 23250.00				
Moment Center Wavenumber = 15850.6296				
Percent line at which curve crosses		Wavenumber (cm ⁻¹)		μm
0.10%		14194.2334		0.7045
1.00%		14406.9287		0.6941
5.00%		14535.3438		0.6880
10.00%		14586.6318		0.6856
20.00%		14637.4912		0.6832
50.00%		14710.2188		0.6798
80.00%		14775.7832		0.6768
80.00%		16748.0781		0.5971
50.00%		17017.4766		0.5876
20.00%		17093.8965		0.5850
10.00%		17138.0957		0.5835
5.00%		17182.9414		0.5820
1.00%		17297.5996		0.5781
0.10%		17506.3652		0.5712
Area Point Limits	Lower (cm ⁻¹)		Upper (cm ⁻¹)	
99%	14605.4856		17109.4749	
96%	14711.0915		17008.1733	
70%	15052.7310		16636.1263	
50%	15292.8144		16397.2981	
0% (area center)	15836.0453		15836.0453	
Crossing	Lower (cm ⁻¹)	Upper (cm ⁻¹)	Width (cm ⁻¹)	Center (cm ⁻¹)
80%	14775.7832	16748.0781	1972.2949	15761.9307
50%	14710.2188	17017.4766	2307.2578	15863.8477
20%	14637.4912	17093.8965	2456.4053	15865.6934
5%	14535.3438	17182.9414	2647.5977	15859.1426
Channel 2				
The peak wavenumber was at 12175.00 and had a value of 1.00				
File starting point is at wavenumber = 9330.00				
File ending point is at wavenumber = 19995.00				
Moment Center Wavenumber = 11975.4347				
Percent line at which curve crosses		Wavenumber (cm ⁻¹)		μm
0.10%		9539.8369		1.0482

1.00%	9884.0996	1.0117		
5.00%	9959.4297	1.0041		
10.00%	9987.1963	1.0013		
20.00%	10012.8027	0.9987		
50.00%	10079.3965	0.9921		
80.00%	10811.5137	0.9249		
80.00%	13327.0508	0.7504		
50.00%	13641.5068	0.7331		
20.00%	13977.9902	0.7154		
10.00%	14090.1572	0.7097		
5.00%	14165.8721	0.7059		
1.00%	14296.5586	0.6995		
0.10%	14431.4648	0.6929		
Area Point Limits	Lower (cm⁻¹)	Upper (cm⁻¹)		
99%	10035.1858	14034.7474		
96%	10134.2620	13826.7512		
70%	10761.7543	13163.9831		
50%	11136.8244	12805.3736		
0% (area center)	11977.1245	11977.1245		
Crossing	Lower (cm⁻¹)	Upper (cm⁻¹)	Width (cm⁻¹)	Center (cm⁻¹)
80%	10811.5137	13327.0508	2515.5371	12069.2822
50%	10079.3965	13641.5068	3562.1104	11860.4512
20%	10012.8027	13977.9902	3965.1875	11995.3965
5%	9959.4297	14165.8721	4206.4424	12062.6504
Channel 3A				
The peak wavenumber was at 6230.00 and had a value of 1.00				
File starting point is at wavenumber = 5785.00				
File ending point is at wavenumber = 6705.00				
Moment Center Wavenumber = 6227.0622				
Percent line at which curve crosses	Wavenumber (cm⁻¹)		µm	
0.10%	5991.6489		1.6690	
1.00%	6052.3462		1.6523	
5.00%	6081.8950		1.6442	
10.00%	6093.0405		1.6412	
20.00%	6103.8584		1.6383	
50.00%	6118.4146		1.6344	
80.00%	6127.5737		1.6320	
80.00%	6326.9775		1.5805	
50.00%	6336.1567		1.5782	
20.00%	6350.1738		1.5748	
10.00%	6360.8052		1.5721	
5.00%	6371.3999		1.5695	
1.00%	6398.6226		1.5628	

0.10%		6439.6523		1.5529	
Area Point Limits		Lower (cm⁻¹)		Upper (cm⁻¹)	
99%		6079.6970		6362.2874	
96%		6103.4610		6339.9847	
70%		6143.1607		6300.9591	
50%		6165.8113		6278.3693	
0% (area center)		6222.2125		6222.2125	
Crossing	Lower (cm⁻¹)	Upper (cm⁻¹)	Width (cm⁻¹)	Center (cm⁻¹)	
80%	6127.5737	6326.9775	199.4038	6227.2754	
50%	6118.4146	6336.1567	217.7422	6227.2856	
20%	6103.8584	6350.1738	246.3154	6227.0161	
5%	6081.8950	6371.3999	289.5049	6226.6475	
Channel 3B					
The peak wavenumber was at 2565.80 and had a value of 1.00					
File starting point is at wavenumber = 2222.80					
File ending point is at wavenumber = 3355.50					
Moment Center Wavenumber = 2689.9123					
Percent line at which curve crosses		Wavenumber (cm⁻¹)		µm	
0.10%		2393.8137		4.1774	
1.00%		2471.2061		4.0466	
5.00%		2507.5103		3.9880	
10.00%		2518.2515		3.9710	
20.00%		2527.9226		3.9558	
50.00%		2540.8977		3.9356	
80.00%		2550.3760		3.9210	
80.00%		2812.3923		3.5557	
50.00%		2844.1921		3.5159	
20.00%		2865.2998		3.4900	
10.00%		2878.7974		3.4737	
5.00%		2892.4202		3.4573	
1.00%		2925.2300		3.4185	
0.10%		2979.0718		3.3568	
Area Point Limits		Lower (cm⁻¹)		Upper (cm⁻¹)	
99%		2509.7672		2885.3508	
96%		2536.2758		2857.5086	
70%		2581.2376		2799.2592	
50%		2611.8592		2764.8957	
0% (area center)		2687.8808		2687.8808	
Crossing	Lower (cm⁻¹)	Upper (cm⁻¹)	Width (cm⁻¹)	Center (cm⁻¹)	
80%	2550.3760	2812.3923	262.0164	2681.3843	
50%	2540.8977	2844.1921	303.2944	2692.5449	
20%	2527.9226	2865.2998	337.3772	2696.6113	
5%	2507.5103	2892.4202	384.9099	2699.9653	

Channel 4				
The peak wavenumber was at 934.30 and had a value of 1.00				
File starting point is at wavenumber = 781.30				
File ending point is at wavenumber = 1136.20				
Moment Center Wavenumber = 926.1104				
Percent line at which curve crosses		Wavenumber (cm⁻¹)		µm
0.10%		853.7050		11.7136
1.00%		863.8912		11.5755
5.00%		870.7056		11.4849
10.00%		873.4853		11.4484
20.00%		876.5002		11.4090
50.00%		882.4297		11.3323
80.00%		891.6080		11.2157
80.00%		961.9097		10.3960
50.00%		967.4245		10.3367
20.00%		974.3810		10.2629
10.00%		978.1237		10.2237
5.00%		981.4305		10.1892
1.00%		988.7534		10.1137
0.10%		999.1293		10.0087
Area Point Limits		Lower (cm⁻¹)		Upper (cm⁻¹)
99%		873.3471		978.6224
96%		879.3612		971.6738
70%		895.4858		955.8015
50%		904.8022		947.4139
0% (area center)		926.5663		926.5663
Crossing	Lower (cm⁻¹)	Upper (cm⁻¹)	Width (cm⁻¹)	Center (cm⁻¹)
80%	891.6080	961.9097	70.3017	926.7588
50%	882.4297	967.4245	84.9948	924.9271
20%	876.5002	974.3810	97.8808	925.4407
5%	870.7056	981.4305	110.7249	926.0681
Channel 5				
The peak wavenumber was at 831.90 and had a value of 1.00				
File starting point is at wavenumber = 714.30				
File ending 999.90				
Moment Center Wavenumber 836.9087				
Percent line at which curve crosses		Wavenumber (cm⁻¹)		µm
0.10%		792.1917		12.6232
1.00%		795.8378		12.5654
5.00%		798.8936		12.5173
10.00%		800.1689		12.4974
20.00%		801.5807		12.4753
50.00%		804.0189		12.4375

80.00%	806.2935	12.4024		
80.00%	862.5563	11.5934		
50.00%	872.2866	11.4641		
20.00%	874.5092	11.4350		
10.00%	875.7759	11.4184		
5.00%	876.9063	11.4037		
1.00%	879.3577	11.3719		
0.10%	882.8216	11.3273		
Area Point Limits	Lower (cm⁻¹)	Upper (cm⁻¹)		
99%	800.1700	874.6133		
96%	803.8251	871.8469		
70%	813.4156	860.7630		
50%	819.9712	853.4426		
0% (area center)	836.3442	836.3442		
Crossing	Lower (cm⁻¹)	Upper (cm⁻¹)	Width (cm⁻¹)	Center (cm⁻¹)
80%	806.2935	862.5563	56.2628	834.4249
50%	804.0189	872.2866	68.2677	838.1528
20%	801.5807	874.5092	72.9284	838.0449
5%	798.8936	876.9063	78.0127	837.9000

Table D.5-6 contains MetOp-A AVHRR/3 solar reflectance channel information such as equivalent width, w , effective central wavelength, λ_e , and in-band solar irradiance, F .

Table D.5-6. MetOp-A AVHRR/3 Solar Reflectance Channel Information.			
Channel	Equivalent Width w (μm)	Effective Wavelength λ_e (μm)	Extraterrestrial Solar Irradiance in Band F (W/m^2)
1	0.084877	0.632815	139.873215
2	0.229421	0.841679	232.919556
3A	0.056998	1.606119	14.016470
Note: These quantities are based on the solar irradiance data of <i>Neckel and Labs</i> (1984), which is a widely used source of such data.			

Table D.5-7 contains the temperature-to-radiance coefficients for MetOp-A AVHRR/3 Channels 3B, 4 and 5.

Table D.5-7. MetOp-A AVHRR/3 Thermal Channel Temperature-to-Radiance Coefficients.			
	v_c	A	B
Channel 3B	2687.0	2.06699	0.996577
Channel 4	927.2	0.55126	0.998509
Channel 5	837.7	0.34716	0.998947

Tables D.5-8 and D.5-9 contain the corresponding spectral response values for MetOp-A AVHRR/3 Channels 1, 2, 3A and Channels 3B, 4 and 5, respectively. Note: Negative response values were caused by system response noise and are to be ignored but are included in the table for completeness.

Table D.5-8. MetOp-A AVHRR/3 spectral Response Values for Channels 1, 2 and 3A.					
Channel 1		Channel 2		Channel 3A	
Wavelength (μm)	Relative Response (percent)	Wavelength (μm)	Relative Response (percent)	Wavelength (μm)	Relative Response (percent)
0.430	-1.78E-03	0.500	1.04E-03	1.490	-4.91E-05
0.432	4.14E-04	0.504	7.10E-04	1.491	-2.67E-05
0.434	5.40E-04	0.508	4.58E-04	1.492	-2.16E-06
0.436	9.78E-04	0.512	2.21E-04	1.493	-1.13E-05
0.438	1.57E-03	0.516	-8.60E-05	1.494	7.99E-06
0.440	-2.74E-04	0.520	2.41E-05	1.495	-1.03E-05
0.442	1.81E-04	0.524	3.90E-04	1.496	-5.20E-06
0.444	1.22E-04	0.528	-1.01E-04	1.497	-1.22E-05
0.446	-1.10E-04	0.532	-1.83E-04	1.498	-3.34E-05
0.448	-1.67E-04	0.536	1.23E-05	1.499	-6.18E-06
0.450	9.36E-04	0.540	4.09E-05	1.500	-3.32E-05
0.452	-4.57E-04	0.544	-5.48E-05	1.501	-1.42E-05
0.454	-7.50E-04	0.548	7.91E-05	1.502	2.89E-06
0.456	1.58E-04	0.552	1.19E-05	1.503	-1.26E-07
0.458	-2.90E-04	0.556	2.41E-05	1.504	7.14E-05
0.460	-5.30E-04	0.560	-9.52E-05	1.505	1.89E-05
0.462	1.60E-04	0.564	-6.16E-05	1.506	5.89E-05
0.464	8.39E-04	0.568	3.23E-05	1.507	4.48E-05
0.466	-3.52E-04	0.572	7.76E-05	1.508	7.86E-05
0.468	-3.16E-04	0.576	-8.99E-05	1.509	4.17E-05
0.470	-2.03E-05	0.580	1.73E-05	1.510	5.86E-05
0.472	-5.81E-04	0.584	3.48E-05	1.511	3.16E-05
0.474	-4.15E-04	0.588	-7.89E-05	1.512	3.26E-05
0.476	-6.18E-04	0.592	2.68E-05	1.513	-2.79E-05
0.478	-3.47E-05	0.596	-2.83E-05	1.514	-8.99E-06
0.480	-2.69E-04	0.600	-2.15E-04	1.515	7.21E-05
0.482	-9.80E-05	0.604	-5.17E-05	1.516	3.44E-05
0.484	-3.70E-04	0.608	-1.23E-04	1.517	-3.47E-05
0.486	1.60E-04	0.612	1.15E-05	1.518	-3.27E-05
0.488	-4.50E-05	0.616	-8.56E-05	1.519	4.79E-06
0.490	3.46E-04	0.620	-7.61E-05	1.520	5.78E-06
0.492	-1.43E-05	0.624	-1.94E-05	1.521	7.08E-05
0.494	-1.90E-04	0.628	-5.18E-05	1.522	3.03E-05
0.496	-2.16E-04	0.632	7.90E-05	1.523	5.58E-05
0.498	-8.36E-05	0.636	-6.45E-05	1.524	-7.25E-05
0.500	-7.41E-04	0.640	2.55E-05	1.525	4.09E-05
0.502	1.78E-04	0.644	1.15E-04	1.526	8.79E-05
0.504	-5.79E-05	0.648	-3.92E-05	1.527	1.84E-05
0.506	2.01E-04	0.652	-3.15E-05	1.528	1.54E-05
0.508	1.07E-04	0.656	7.86E-05	1.529	1.06E-05

0.510	-8.79E-05	0.660	4.82E-05	1.530	5.81E-05
0.512	2.93E-04	0.664	-5.49E-05	1.531	7.74E-05
0.514	6.67E-05	0.668	5.02E-05	1.532	9.29E-05
0.516	-4.02E-04	0.672	4.22E-05	1.533	6.63E-06
0.518	-1.35E-04	0.676	-3.61E-05	1.534	-3.49E-05
0.520	-1.55E-04	0.680	1.66E-05	1.535	2.30E-05
0.522	2.31E-04	0.684	7.01E-05	1.536	7.76E-05
0.524	-2.22E-04	0.688	1.43E-04	1.537	1.81E-05
0.526	7.72E-05	0.692	6.67E-04	1.538	3.53E-05
0.528	1.23E-04	0.696	3.28E-03	1.539	1.28E-04
0.530	-6.89E-05	0.700	1.17E-02	1.540	8.87E-05
0.532	-1.05E-04	0.704	3.29E-02	1.541	1.86E-04
0.534	1.72E-04	0.708	7.45E-02	1.542	1.29E-04
0.536	9.17E-05	0.712	1.39E-01	1.543	1.66E-04
0.538	-3.35E-06	0.716	2.10E-01	1.544	1.37E-04
0.540	1.84E-05	0.720	2.69E-01	1.545	1.94E-04
0.542	1.78E-05	0.724	3.33E-01	1.546	2.93E-04
0.544	-1.14E-04	0.728	4.11E-01	1.547	2.98E-04
0.546	1.14E-04	0.732	4.82E-01	1.548	4.99E-04
0.548	1.22E-04	0.736	5.50E-01	1.549	4.94E-04
0.550	7.28E-05	0.740	6.28E-01	1.550	6.43E-04
0.552	1.96E-04	0.744	7.11E-01	1.551	6.85E-04
0.554	1.24E-04	0.748	7.74E-01	1.552	8.28E-04
0.556	4.03E-05	0.752	8.18E-01	1.553	1.02E-03
0.558	2.79E-04	0.756	8.60E-01	1.554	1.36E-03
0.560	3.77E-04	0.760	8.87E-01	1.555	1.70E-03
0.562	1.71E-04	0.764	9.00E-01	1.556	2.20E-03
0.564	1.51E-04	0.768	8.99E-01	1.557	2.70E-03
0.566	6.84E-04	0.772	8.93E-01	1.558	3.41E-03
0.568	7.11E-04	0.776	8.98E-01	1.559	4.22E-03
0.570	6.84E-04	0.780	9.11E-01	1.560	5.32E-03
0.572	1.29E-03	0.784	9.32E-01	1.561	6.40E-03
0.574	2.29E-03	0.788	9.52E-01	1.562	8.20E-03
0.576	4.54E-03	0.792	9.64E-01	1.563	1.03E-02
0.578	9.56E-03	0.796	9.63E-01	1.564	1.28E-02
0.580	2.14E-02	0.800	9.59E-01	1.565	1.66E-02
0.582	5.06E-02	0.804	9.61E-01	1.566	2.09E-02
0.584	1.26E-01	0.808	9.68E-01	1.567	2.63E-02
0.586	3.00E-01	0.812	9.83E-01	1.568	3.43E-02
0.588	5.41E-01	0.816	9.95E-01	1.569	4.36E-02
0.590	6.74E-01	0.820	1.00E+00	1.570	5.60E-02
0.592	7.08E-01	0.824	9.99E-01	1.571	7.39E-02
0.594	7.30E-01	0.828	9.96E-01	1.572	9.55E-02
0.596	7.72E-01	0.832	9.91E-01	1.573	1.27E-01
0.598	8.23E-01	0.836	9.88E-01	1.574	1.64E-01
0.600	8.63E-01	0.840	9.89E-01	1.575	2.13E-01
0.602	8.85E-01	0.844	9.88E-01	1.576	2.82E-01
0.604	8.90E-01	0.848	9.85E-01	1.577	3.63E-01
0.606	8.91E-01	0.852	9.76E-01	1.578	4.71E-01
0.608	8.89E-01	0.856	9.68E-01	1.579	5.88E-01
0.610	9.01E-01	0.860	9.61E-01	1.580	7.19E-01
0.612	9.27E-01	0.864	9.50E-01	1.581	8.72E-01
0.614	9.58E-01	0.868	9.41E-01	1.582	9.17E-01

0.616	9.73E-01	0.872	9.38E-01	1.583	9.35E-01
0.618	9.77E-01	0.876	9.38E-01	1.584	9.53E-01
0.620	9.66E-01	0.880	9.40E-01	1.585	9.64E-01
0.622	9.53E-01	0.884	9.42E-01	1.586	9.73E-01
0.624	9.39E-01	0.888	9.41E-01	1.587	9.82E-01
0.626	9.33E-01	0.892	9.37E-01	1.588	9.80E-01
0.628	9.28E-01	0.896	9.34E-01	1.589	9.85E-01
0.630	9.32E-01	0.900	9.29E-01	1.590	9.80E-01
0.632	9.42E-01	0.904	9.06E-01	1.591	9.81E-01
0.634	9.51E-01	0.908	8.79E-01	1.592	9.84E-01
0.636	9.66E-01	0.912	8.59E-01	1.593	9.82E-01
0.638	9.78E-01	0.916	8.41E-01	1.594	9.85E-01
0.640	9.86E-01	0.920	8.25E-01	1.595	9.81E-01
0.642	9.91E-01	0.924	8.05E-01	1.596	9.83E-01
0.644	9.96E-01	0.928	7.84E-01	1.597	9.80E-01
0.646	1.00E+00	0.932	7.67E-01	1.598	9.81E-01
0.648	9.95E-01	0.936	7.54E-01	1.599	9.85E-01
0.650	9.83E-01	0.940	7.35E-01	1.600	9.85E-01
0.652	9.66E-01	0.944	7.22E-01	1.601	9.90E-01
0.654	9.49E-01	0.948	7.06E-01	1.602	9.87E-01
0.656	9.24E-01	0.952	6.88E-01	1.603	9.90E-01
0.658	8.95E-01	0.956	6.70E-01	1.604	9.89E-01
0.660	8.63E-01	0.960	6.55E-01	1.605	1.00E+00
0.662	8.43E-01	0.964	6.41E-01	1.606	9.91E-01
0.664	8.26E-01	0.968	6.29E-01	1.607	9.85E-01
0.666	8.12E-01	0.972	6.15E-01	1.608	9.88E-01
0.668	8.11E-01	0.976	5.92E-01	1.609	9.84E-01
0.670	8.25E-01	0.980	5.65E-01	1.610	9.87E-01
0.672	8.53E-01	0.984	5.42E-01	1.611	9.83E-01
0.674	8.78E-01	0.988	5.26E-01	1.612	9.83E-01
0.676	8.45E-01	0.992	5.03E-01	1.613	9.79E-01
0.678	6.97E-01	0.996	3.47E-01	1.614	9.80E-01
0.680	4.78E-01	1.000	1.42E-01	1.615	9.79E-01
0.682	2.81E-01	1.004	5.09E-02	1.616	9.77E-01
0.684	1.57E-01	1.008	2.02E-02	1.617	9.77E-01
0.686	8.80E-02	1.012	9.58E-03	1.618	9.75E-01
0.688	4.97E-02	1.016	5.58E-03	1.619	9.77E-01
0.690	2.85E-02	1.020	3.79E-03	1.620	9.76E-01
0.692	1.68E-02	1.024	2.86E-03	1.621	9.79E-01
0.694	1.03E-02	1.028	2.33E-03	1.622	9.77E-01
0.696	6.41E-03	1.032	1.93E-03	1.623	9.80E-01
0.698	4.08E-03	1.036	1.67E-03	1.624	9.78E-01
0.700	2.57E-03	1.040	1.40E-03	1.625	9.79E-01
0.702	1.74E-03	1.044	1.23E-03	1.626	9.76E-01
0.704	1.12E-03	1.048	1.01E-03	1.627	9.67E-01
0.706	7.57E-04	1.052	8.55E-04	1.628	9.63E-01
0.708	5.75E-04	1.056	7.03E-04	1.629	9.46E-01
0.710	4.10E-04	1.060	5.80E-04	1.630	9.34E-01
0.712	-4.56E-05	1.064	4.71E-04	1.631	9.14E-01
0.714	-3.96E-05	1.068	3.62E-04	1.632	7.99E-01
0.716	4.06E-05	1.072	3.21E-04	1.633	6.63E-01
0.718	-1.13E-04	-	-	1.634	5.43E-01

0.720	1.15E-04	-	-	1.635	4.34E-01
0.722	-4.49E-05	-	-	1.636	3.52E-01
0.724	2.96E-05	-	-	1.637	2.75E-01
0.726	1.01E-04	-	-	1.638	2.14E-01
0.728	-5.90E-05	-	-	1.639	1.66E-01
0.730	-6.32E-05	-	-	1.640	1.33E-01
0.732	-3.58E-05	-	-	1.641	1.04E-01
0.734	2.95E-05	-	-	1.642	8.12E-02
0.736	-2.94E-05	-	-	1.643	6.46E-02
0.738	6.19E-05	-	-	1.644	5.21E-02
0.740	-7.28E-05	-	-	1.645	4.17E-02
0.742	8.55E-05	-	-	1.646	3.34E-02
0.744	-2.93E-05	-	-	1.647	2.71E-02
0.746	3.10E-05	-	-	1.648	2.20E-02
0.748	1.04E-04	-	-	1.649	1.78E-02
0.750	-2.96E-05	-	-	1.650	1.51E-02
0.752	4.45E-05	-	-	1.651	1.24E-02
0.754	-7.58E-06	-	-	1.652	1.04E-02
0.756	1.19E-04	-	-	1.653	8.67E-03
0.758	-7.65E-05	-	-	1.654	7.28E-03
0.760	-1.95E-05	-	-	1.655	6.23E-03
0.762	2.34E-05	-	-	1.656	5.34E-03
0.764	-1.20E-05	-	-	1.657	4.39E-03
0.766	1.74E-04	-	-	1.658	3.84E-03
0.768	-3.65E-05	-	-	1.659	3.36E-03
0.770	7.57E-05	-	-	1.660	2.89E-03
0.772	-9.85E-05	-	-	1.661	2.45E-03
0.774	6.27E-06	-	-	1.662	2.26E-03
0.776	-4.73E-05	-	-	1.663	1.82E-03
0.778	1.30E-05	-	-	1.664	1.71E-03
0.780	-5.96E-05	-	-	1.665	1.46E-03
0.782	-4.24E-05	-	-	1.666	1.35E-03
0.784	6.51E-05	-	-	1.667	1.16E-03
0.786	1.36E-04	-	-	1.668	1.10E-03
0.788	-4.16E-05	-	-	1.669	9.63E-04
0.790	1.10E-04	-	-	1.670	9.27E-04
0.792	-6.88E-05	-	-	1.671	7.02E-04
0.794	-2.28E-04	-	-	1.672	7.04E-04
0.796	7.03E-05	-	-	1.673	7.66E-04
0.798	-3.94E-05	-	-	1.674	5.31E-04
0.800	-5.09E-06	-	-	1.675	5.10E-04
0.802	1.00E-04	-	-	1.676	4.50E-04

0.804	-6.89E-05	-	-	1.677	4.22E-04
0.806	-2.32E-05	-	-	1.678	3.63E-04
0.808	7.00E-05	-	-	1.679	3.85E-04
0.810	5.48E-05	-	-	1.680	2.46E-04
0.812	1.95E-04	-	-	1.681	2.65E-04
0.814	2.21E-04	-	-	1.682	1.81E-04
0.816	-1.61E-04	-	-	1.683	1.58E-04
0.818	8.35E-05	-	-	1.684	1.07E-04
0.820	2.03E-04	-	-	1.685	1.18E-04
0.822	1.88E-04	-	-	1.686	1.75E-04
0.824	-7.68E-05	-	-	1.687	9.55E-05
0.826	-1.93E-05	-	-	1.688	1.80E-04
0.828	1.91E-05	-	-	1.689	8.28E-05
0.830	5.20E-05	-	-	1.690	6.06E-05
-	-	-	-	1.691	6.96E-05
-	-	-	-	1.692	-1.64E-05
-	-	-	-	1.693	9.77E-05
-	-	-	-	1.694	5.82E-05
-	-	-	-	1.695	7.60E-05
-	-	-	-	1.696	-3.39E-06
-	-	-	-	1.697	4.37E-05
-	-	-	-	1.698	9.55E-07
-	-	-	-	1.699	-3.87E-05
-	-	-	-	1.700	3.70E-05
-	-	-	-	1.701	8.66E-06
-	-	-	-	1.702	5.30E-06
-	-	-	-	1.703	-2.85E-05
-	-	-	-	1.704	-4.11E-05
-	-	-	-	1.705	1.39E-05
-	-	-	-	1.706	2.55E-05
-	-	-	-	1.707	3.96E-05
-	-	-	-	1.708	-6.28E-05
-	-	-	-	1.709	-2.89E-05
-	-	-	-	1.710	5.15E-06
-	-	-	-	1.711	-4.90E-05
-	-	-	-	1.712	-2.54E-05
-	-	-	-	1.713	-3.09E-05
-	-	-	-	1.714	3.46E-05
-	-	-	-	1.715	-3.62E-05
-	-	-	-	1.716	-4.45E-05
-	-	-	-	1.717	-1.06E-04
-	-	-	-	1.718	-2.34E-05

-	-	-	-	1.719	3.52E-05
-	-	-	-	1.720	-9.66E-06
-	-	-	-	1.721	-5.04E-05
-	-	-	-	1.722	-1.07E-05
-	-	-	-	1.723	-1.29E-05
-	-	-	-	1.724	-2.22E-05
-	-	-	-	1.725	1.06E-04
-	-	-	-	1.726	5.84E-05
-	-	-	-	1.727	-8.95E-05
-	-	-	-	1.728	-7.39E-05
-	-	-	-	1.729	3.44E-05
-	-	-	-	1.730	-3.53E-05

Table D.5-9. MetOp-A AVHRR/3 Spectral Response Values for Channels 3B, 4 and 5.

Channel 3B		Channel 4		Channel 5	
Wavelength (μm)	Relative Response (percent)	Wavelength (μm)	Relative Response (percent)	Wavelength (μm)	Relative Response (percent)
2.980	-3.83E-05	8.80	9.88E-05	10.00	-1.15E-04
2.987	-1.13E-04	8.82	2.11E-04	10.02	1.41E-03
2.994	-3.83E-05	8.84	2.88E-04	10.04	-8.30E-05
3.001	8.23E-05	8.86	7.04E-05	10.06	1.47E-04
3.008	-3.82E-05	8.88	8.48E-05	10.08	-7.42E-04
3.015	-7.89E-05	8.90	2.49E-04	10.10	-4.53E-04
3.022	4.25E-05	8.92	-1.17E-04	10.12	1.75E-05
3.029	1.92E-05	8.94	2.03E-04	10.14	-7.32E-05
3.036	9.03E-05	8.96	1.43E-04	10.16	-9.16E-04
3.043	3.86E-05	8.98	1.25E-04	10.18	3.33E-04
3.050	6.40E-05	9.00	1.70E-04	10.20	1.27E-03
3.057	-3.76E-05	9.02	-9.02E-05	10.22	-4.70E-04
3.064	2.25E-05	9.04	-1.76E-04	10.24	-5.28E-04
3.071	-1.10E-05	9.06	6.88E-05	10.26	6.51E-04
3.078	1.34E-05	9.08	1.50E-04	10.28	8.53E-04
3.085	-1.95E-05	9.10	1.87E-04	10.30	-3.39E-04
3.092	1.19E-04	9.12	-7.09E-05	10.32	-5.46E-04
3.099	-3.90E-05	9.14	2.53E-04	10.34	4.06E-05
3.106	2.77E-05	9.16	-1.92E-04	10.36	-5.76E-04
3.113	-7.14E-05	9.18	1.36E-05	10.38	-3.44E-04
3.120	5.90E-06	9.20	-7.96E-05	10.40	-4.29E-04
3.127	-1.45E-05	9.22	-5.17E-05	10.42	-5.66E-04
3.134	-5.31E-05	9.24	-2.34E-04	10.44	-4.48E-04
3.141	4.40E-05	9.26	-1.98E-05	10.46	-3.60E-04
3.148	-1.73E-05	9.28	2.21E-05	10.48	3.09E-04
3.155	-1.11E-05	9.30	4.05E-05	10.50	-4.73E-04
3.162	-6.49E-06	9.32	5.86E-05	10.52	6.46E-04
3.169	1.64E-05	9.34	-4.59E-05	10.54	-3.06E-04
3.176	6.52E-05	9.36	2.74E-06	10.56	-8.99E-05
3.183	-2.19E-05	9.38	9.24E-05	10.58	1.81E-04
3.190	7.35E-05	9.40	7.24E-05	10.60	-1.24E-04
3.197	-1.06E-04	9.42	9.17E-06	10.62	3.46E-05
3.204	-9.18E-05	9.44	-5.54E-06	10.64	-5.25E-04
3.211	-6.80E-06	9.46	-1.41E-04	10.66	-5.12E-05
3.218	-6.19E-05	9.48	-3.26E-05	10.68	-2.61E-04
3.225	2.99E-05	9.50	-3.58E-05	10.70	-2.76E-04
3.232	1.53E-04	9.52	1.56E-04	10.72	6.72E-04
3.239	-1.94E-05	9.54	3.44E-05	10.74	3.96E-04
3.246	5.60E-05	9.56	-1.19E-04	10.76	-1.80E-05
3.253	6.47E-05	9.58	-8.01E-05	10.78	3.70E-04
3.260	1.21E-04	9.60	-2.13E-04	10.80	-1.02E-04
3.267	1.99E-04	9.62	-3.20E-05	10.82	-5.41E-04
3.274	8.73E-05	9.64	1.38E-05	10.84	1.46E-04
3.281	8.43E-05	9.66	-2.40E-04	10.86	3.93E-04
3.288	2.06E-04	9.68	-1.04E-04	10.88	-4.32E-04
3.295	1.73E-04	9.70	1.52E-04	10.90	-4.35E-04
3.302	1.46E-04	9.72	-2.79E-04	10.92	-4.17E-04

3.309	1.58E-04	9.74	1.05E-05	10.94	-6.33E-04
3.316	2.20E-04	9.76	-5.86E-05	10.96	-7.44E-04
3.323	3.09E-04	9.78	-1.07E-04	10.98	-6.57E-04
3.330	3.03E-04	9.80	-2.07E-05	11.00	8.85E-04
3.337	4.67E-04	9.82	-3.41E-05	11.02	-2.57E-04
3.344	6.63E-04	9.84	-1.58E-04	11.04	-3.86E-04
3.351	7.01E-04	9.86	-8.23E-05	11.06	-4.19E-04
3.358	1.08E-03	9.88	-2.12E-04	11.08	8.42E-04
3.365	1.38E-03	9.90	-1.38E-04	11.10	9.58E-04
3.372	1.57E-03	9.92	-2.25E-04	11.12	-4.32E-04
3.379	2.21E-03	9.94	-6.51E-05	11.14	3.21E-05
3.386	2.67E-03	9.96	8.85E-05	11.16	6.93E-04
3.393	3.59E-03	9.98	4.51E-04	11.18	-9.01E-04
3.400	4.91E-03	10.00	7.63E-04	11.20	-1.37E-03
3.407	6.33E-03	10.02	1.38E-03	11.22	9.81E-04
3.414	8.38E-03	10.04	2.10E-03	11.24	-5.00E-04
3.421	1.10E-02	10.06	3.10E-03	11.26	-9.99E-04
3.428	1.45E-02	10.08	4.86E-03	11.28	1.58E-03
3.435	1.97E-02	10.10	7.41E-03	11.30	-5.34E-04
3.442	2.61E-02	10.12	1.14E-02	11.32	5.28E-04
3.449	3.51E-02	10.14	1.72E-02	11.34	1.68E-03
3.456	4.74E-02	10.16	2.67E-02	11.36	4.77E-03
3.463	6.29E-02	10.18	4.08E-02	11.38	1.55E-02
3.470	8.53E-02	10.20	6.28E-02	11.40	4.16E-02
3.477	1.15E-01	10.22	9.31E-02	11.42	1.07E-01
3.484	1.55E-01	10.24	1.36E-01	11.44	2.41E-01
3.491	2.08E-01	10.26	1.91E-01	11.46	4.53E-01
3.498	2.73E-01	10.28	2.55E-01	11.48	6.65E-01
3.505	3.54E-01	10.30	3.32E-01	11.50	7.77E-01
3.512	4.48E-01	10.32	4.19E-01	11.52	7.86E-01
3.519	5.39E-01	10.34	5.16E-01	11.54	7.64E-01
3.526	6.27E-01	10.36	6.19E-01	11.56	7.59E-01
3.533	6.97E-01	10.38	7.24E-01	11.58	7.75E-01
3.540	7.47E-01	10.40	8.17E-01	11.60	8.12E-01
3.547	7.76E-01	10.42	8.92E-01	11.62	8.35E-01
3.554	7.96E-01	10.44	9.50E-01	11.64	8.64E-01
3.561	8.08E-01	10.46	9.81E-01	11.66	8.90E-01
3.568	8.15E-01	10.48	9.91E-01	11.68	9.07E-01
3.575	8.17E-01	10.50	9.92E-01	11.70	9.13E-01
3.582	8.27E-01	10.52	9.86E-01	11.72	9.23E-01
3.589	8.37E-01	10.54	9.84E-01	11.74	9.31E-01
3.596	8.51E-01	10.56	9.85E-01	11.76	9.34E-01
3.603	8.60E-01	10.58	9.88E-01	11.78	9.33E-01
3.610	8.72E-01	10.60	9.91E-01	11.80	9.30E-01
3.617	8.91E-01	10.62	9.91E-01	11.82	9.36E-01
3.624	9.01E-01	10.64	9.96E-01	11.84	9.43E-01
3.631	9.08E-01	10.66	9.94E-01	11.86	9.53E-01
3.638	9.17E-01	10.68	9.95E-01	11.88	9.61E-01
3.645	9.27E-01	10.70	1.00E+00	11.90	9.67E-01
3.652	9.34E-01	10.72	9.98E-01	11.92	9.79E-01
3.659	9.35E-01	10.74	9.95E-01	11.94	9.91E-01
3.666	9.48E-01	10.76	9.97E-01	11.96	9.90E-01
3.673	9.48E-01	10.78	9.92E-01	11.98	9.99E-01

3.680	9.61E-01	10.80	9.86E-01	12.00	9.94E-01
3.687	9.63E-01	10.82	9.79E-01	12.02	1.00E+00
3.694	9.69E-01	10.84	9.77E-01	12.04	9.93E-01
3.701	9.82E-01	10.86	9.70E-01	12.06	9.90E-01
3.708	9.82E-01	10.88	9.56E-01	12.08	9.85E-01
3.715	9.85E-01	10.90	9.56E-01	12.10	9.82E-01
3.722	9.93E-01	10.92	9.41E-01	12.12	9.88E-01
3.729	9.86E-01	10.94	9.58E-01	12.14	9.93E-01
3.736	9.86E-01	10.96	9.30E-01	12.16	9.90E-01
3.743	9.85E-01	10.98	9.49E-01	12.18	9.95E-01
3.750	9.70E-01	11.00	9.28E-01	12.20	9.94E-01
3.757	9.65E-01	11.02	9.28E-01	12.22	9.87E-01
3.764	9.62E-01	11.04	9.14E-01	12.24	9.91E-01
3.771	9.52E-01	11.06	9.21E-01	12.26	9.92E-01
3.778	9.52E-01	11.08	9.08E-01	12.28	9.92E-01
3.785	9.31E-01	11.10	8.88E-01	12.30	9.84E-01
3.792	9.40E-01	11.12	8.81E-01	12.32	9.97E-01
3.799	9.34E-01	11.14	8.71E-01	12.34	9.95E-01
3.806	9.38E-01	11.16	8.60E-01	12.36	9.73E-01
3.813	9.40E-01	11.18	8.38E-01	12.38	9.14E-01
3.820	9.46E-01	11.20	8.22E-01	12.40	8.16E-01
3.827	9.46E-01	11.22	7.94E-01	12.42	6.57E-01
3.834	9.49E-01	11.24	7.66E-01	12.44	4.77E-01
3.841	9.54E-01	11.26	7.25E-01	12.46	3.03E-01
3.848	9.49E-01	11.28	6.73E-01	12.48	1.74E-01
3.855	9.49E-01	11.30	6.15E-01	12.50	9.13E-02
3.862	9.51E-01	11.32	5.45E-01	12.52	4.56E-02
3.869	9.55E-01	11.34	4.71E-01	12.54	2.43E-02
3.876	9.62E-01	11.36	3.89E-01	12.56	1.22E-02
3.883	9.84E-01	11.38	3.08E-01	12.58	6.24E-03
3.890	9.88E-01	11.40	2.31E-01	12.60	5.29E-03
3.897	1.00E+00	11.42	1.67E-01	12.62	1.70E-03
3.904	9.85E-01	11.44	1.17E-01	12.64	-1.40E-03
3.911	9.42E-01	11.46	8.03E-02	12.66	2.88E-04
3.918	8.53E-01	11.48	5.48E-02	12.68	3.98E-04
3.925	7.21E-01	11.50	3.79E-02	12.70	-2.52E-03
3.932	5.73E-01	11.52	2.59E-02	12.72	4.66E-03
3.939	4.35E-01	11.54	1.82E-02	12.74	-2.28E-03
3.946	3.16E-01	11.56	1.30E-02	12.76	2.78E-03
3.953	2.28E-01	11.58	9.28E-03	12.78	1.31E-03
3.960	1.65E-01	11.60	6.65E-03	12.80	-2.41E-03
3.967	1.20E-01	11.62	4.81E-03	12.82	2.26E-03
3.974	8.78E-02	11.64	3.45E-03	12.84	6.61E-03
3.981	6.56E-02	11.66	2.57E-03	12.86	-2.91E-03
3.988	5.00E-02	11.68	2.22E-03	12.88	-1.88E-03
3.995	3.88E-02	11.70	2.00E-03	12.90	-2.43E-03
4.002	3.07E-02	11.72	6.49E-04	12.92	4.67E-03
4.009	2.49E-02	11.74	7.01E-04	12.94	1.14E-04
4.016	2.01E-02	11.76	-2.81E-05	12.96	2.02E-05
4.023	1.68E-02	11.78	-1.35E-05	12.98	-2.25E-03
4.030	1.41E-02	11.80	-3.20E-04	13.00	-1.10E-03
4.037	1.22E-02	11.82	-7.87E-04	13.02	-1.40E-03
4.044	1.06E-02	11.84	3.16E-04	13.04	2.11E-04

4.051	9.18E-03	11.86	1.59E-04	13.06	-2.71E-03
4.058	8.46E-03	11.88	3.38E-04	13.08	1.93E-03
4.065	7.44E-03	11.90	1.78E-04	13.10	-4.37E-05
4.072	7.05E-03	11.92	-4.31E-04	13.12	-2.73E-03
4.079	6.69E-03	11.94	1.11E-04	13.14	-2.52E-03
4.086	6.60E-03	11.96	7.20E-04	13.16	5.47E-04
4.093	6.61E-03	11.98	2.54E-04	13.18	-2.52E-03
4.100	6.67E-03	12.00	-3.65E-04	13.20	-2.41E-03
4.107	6.78E-03	12.02	4.97E-05	13.22	-3.38E-03
4.114	6.92E-03	12.04	4.64E-05	13.24	-1.24E-04
4.121	7.03E-03	12.06	-3.25E-04	13.26	4.15E-03
4.128	6.67E-03	12.08	3.32E-04	13.28	-7.03E-04
4.135	5.99E-03	12.10	-4.45E-04	13.30	-4.64E-03
4.142	5.09E-03	12.12	4.05E-04	13.32	1.18E-02
4.149	4.12E-03	12.14	-9.68E-04	13.34	2.86E-03
4.156	3.02E-03	12.16	-6.25E-04	13.36	4.40E-04
4.163	2.29E-03	12.18	1.66E-04	13.38	-1.30E-03
4.170	1.67E-03	12.20	1.61E-04	13.40	3.60E-03
4.177	1.03E-03	12.22	3.60E-04	13.42	-1.33E-03
4.184	6.64E-04	12.24	2.59E-04	13.44	-2.69E-03
4.191	5.32E-04	12.26	-6.01E-04	13.46	5.24E-03
4.198	2.34E-04	12.28	4.48E-04	13.48	9.86E-03
4.205	4.96E-05	12.30	-4.57E-04	13.50	-2.73E-03
4.212	1.77E-04	12.32	-1.16E-03	13.52	4.84E-03
4.219	3.27E-04	12.34	-2.82E-04	13.54	-7.65E-04
4.226	1.09E-03	12.36	-1.69E-04	13.56	-6.04E-03
4.233	3.74E-04	12.38	5.41E-04	13.58	-6.09E-03
4.240	-1.64E-05	12.40	-7.21E-04	13.60	-3.87E-03
4.247	-9.24E-04	12.42	1.83E-04	13.62	4.37E-03
4.254	-7.17E-05	12.44	-1.25E-03	13.64	7.61E-04
4.261	6.83E-04	12.46	2.27E-05	13.66	1.79E-03
4.268	3.84E-04	12.48	-8.60E-05	13.68	1.03E-02
4.275	-5.42E-04	12.50	5.14E-04	13.70	-4.58E-03
4.282	-8.68E-06	12.52	-8.90E-05	13.72	2.09E-03
4.289	-6.83E-04	12.54	1.38E-04	13.74	2.28E-03
4.296	3.57E-04	12.56	-8.18E-04	13.76	-1.74E-03
4.303	4.44E-04	12.58	-1.05E-03	13.78	-2.28E-03
4.310	6.76E-04	12.60	-1.13E-03	13.80	1.30E-02
4.317	1.45E-04	12.62	-1.23E-03	13.82	-2.95E-03
4.324	2.94E-04	12.64	-5.87E-04	13.84	-9.34E-04
4.331	-1.20E-06	12.66	3.84E-04	13.86	2.01E-03
4.338	-8.42E-06	12.68	-4.95E-04	13.88	8.68E-03
4.345	-7.49E-05	12.70	-2.31E-03	13.90	3.92E-03
4.352	-7.52E-05	12.72	-4.15E-04	13.92	-3.40E-03
4.359	1.23E-05	12.74	-4.38E-04	13.94	-1.24E-03
4.366	-7.68E-05	12.76	-1.68E-04	13.96	-1.74E-03
4.373	3.28E-05	12.78	6.80E-05	13.98	-3.06E-04
4.380	2.77E-05	12.80	-6.42E-05	14.00	2.88E-03
4.387	-4.89E-05	-	-	-	-
4.394	2.62E-05	-	-	-	-
4.401	-7.29E-05	-	-	-	-
4.408	-7.77E-05	-	-	-	-

4.415	2.90E-05	-	-	-	-
4.422	-9.15E-05	-	-	-	-
4.429	1.67E-06	-	-	-	-
4.436	2.41E-05	-	-	-	-
4.443	4.87E-05	-	-	-	-
4.450	3.30E-05	-	-	-	-
4.457	-5.20E-05	-	-	-	-
4.464	-3.21E-05	-	-	-	-
4.471	-2.33E-05	-	-	-	-
4.478	-3.01E-05	-	-	-	-
4.485	9.55E-05	-	-	-	-
4.492	-4.42E-05	-	-	-	-
4.499	4.79E-05	-	-	-	-

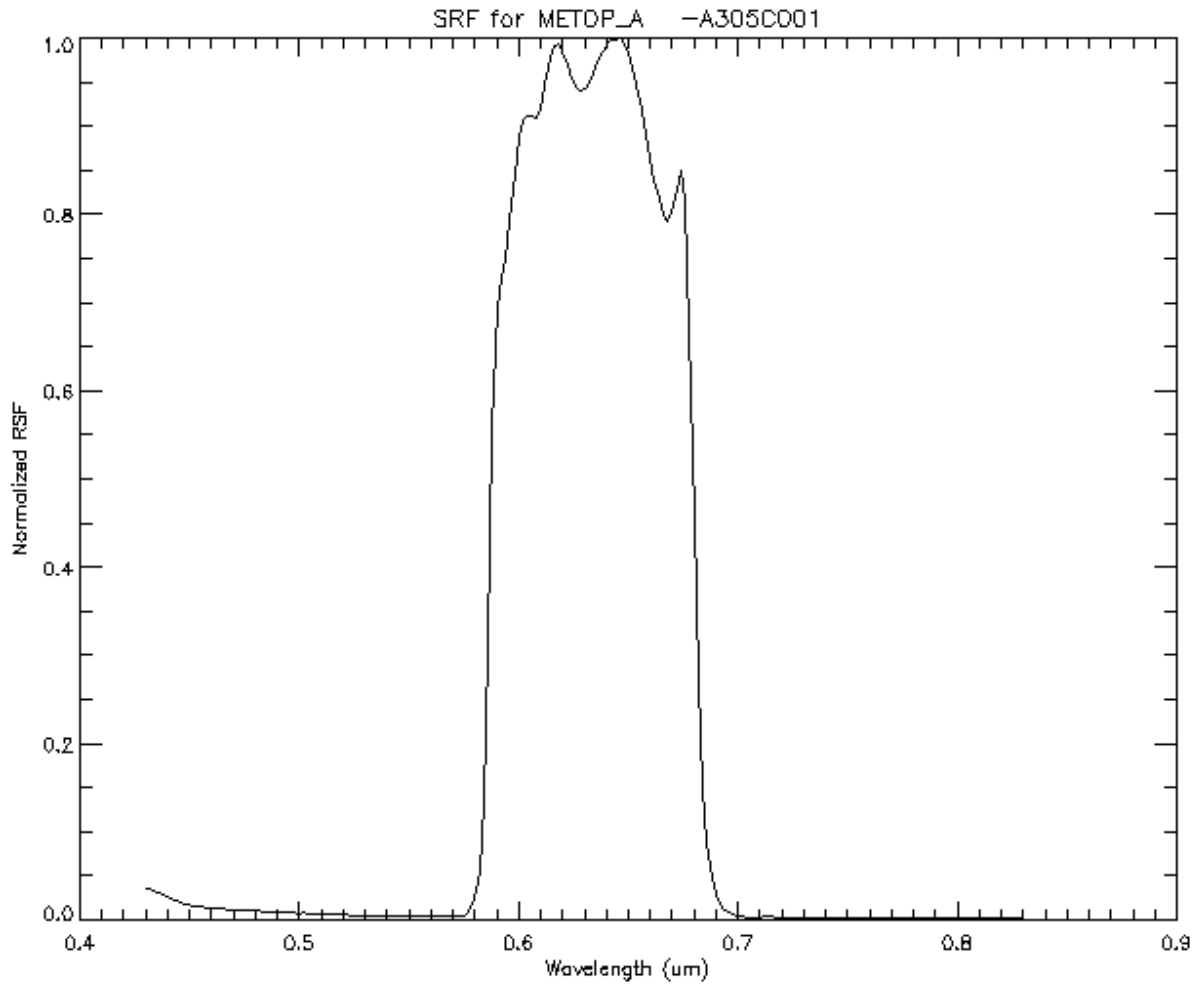

Figure D.5-1. Spectral Response Curve for MetOp-A Channel 1.

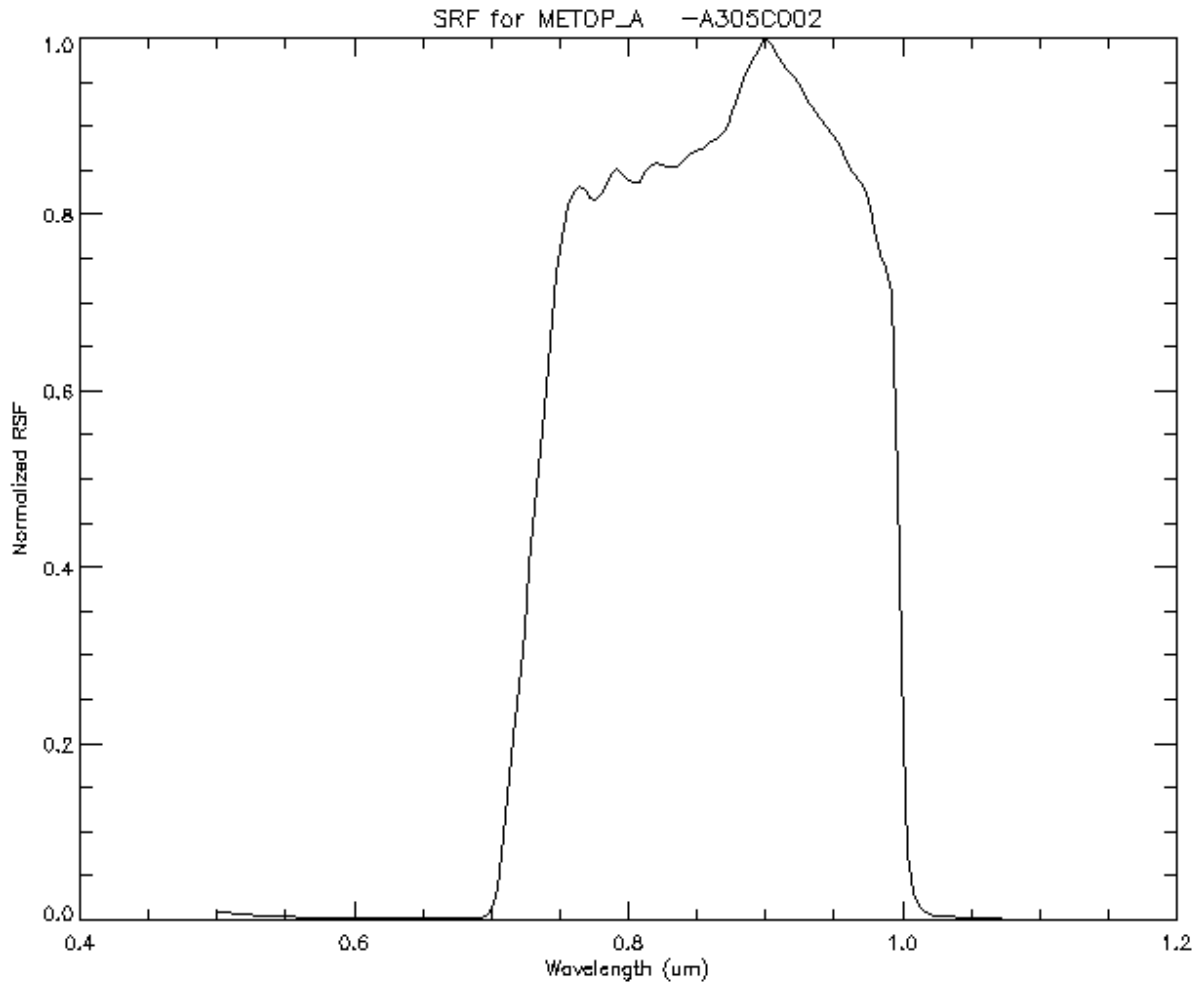

Figure D.5-2. Spectral Response Curve for MetOp-A Channel 2.

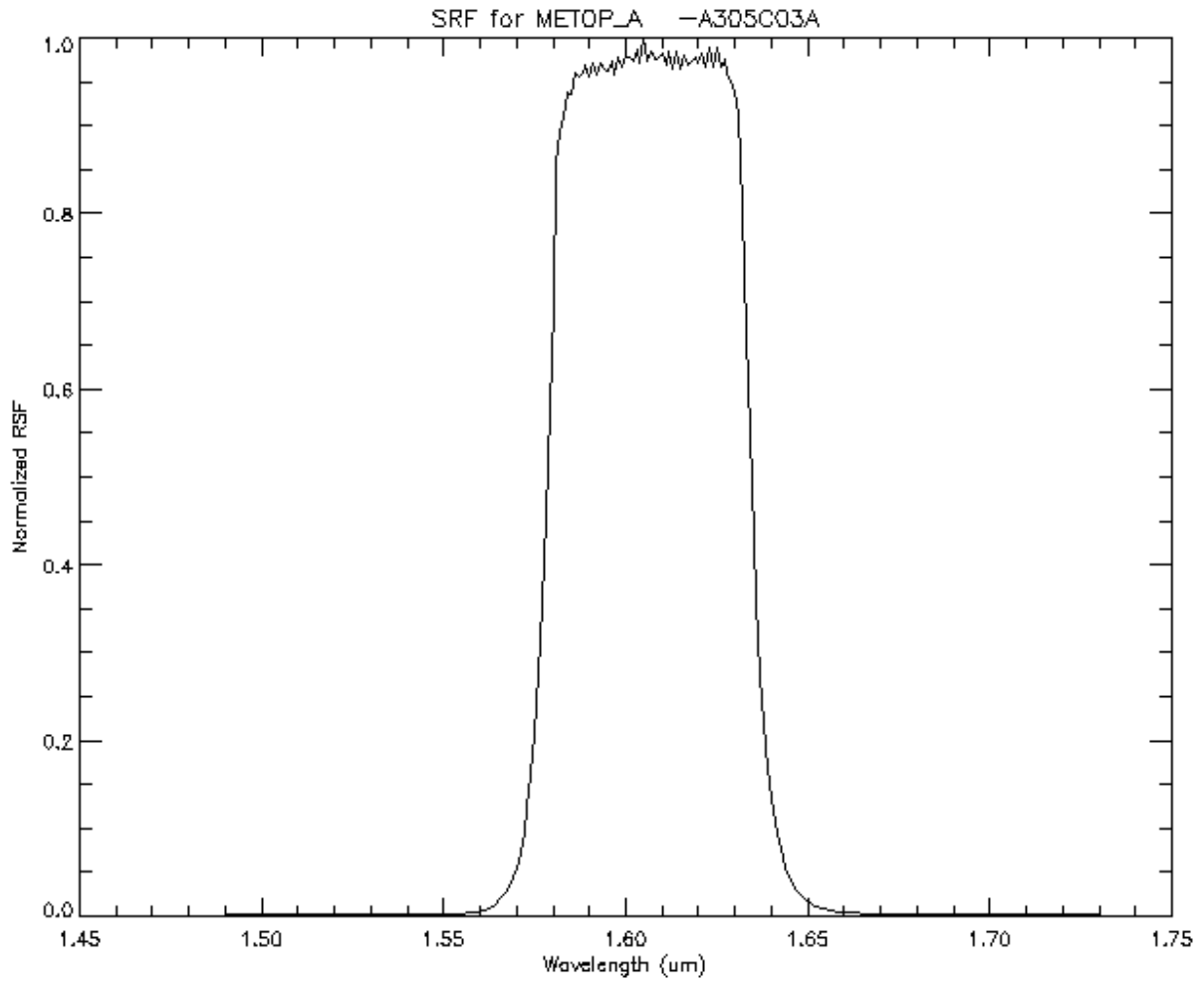

Figure D.5-3. Spectral Response Curve for MetOp-A Channel 3A.

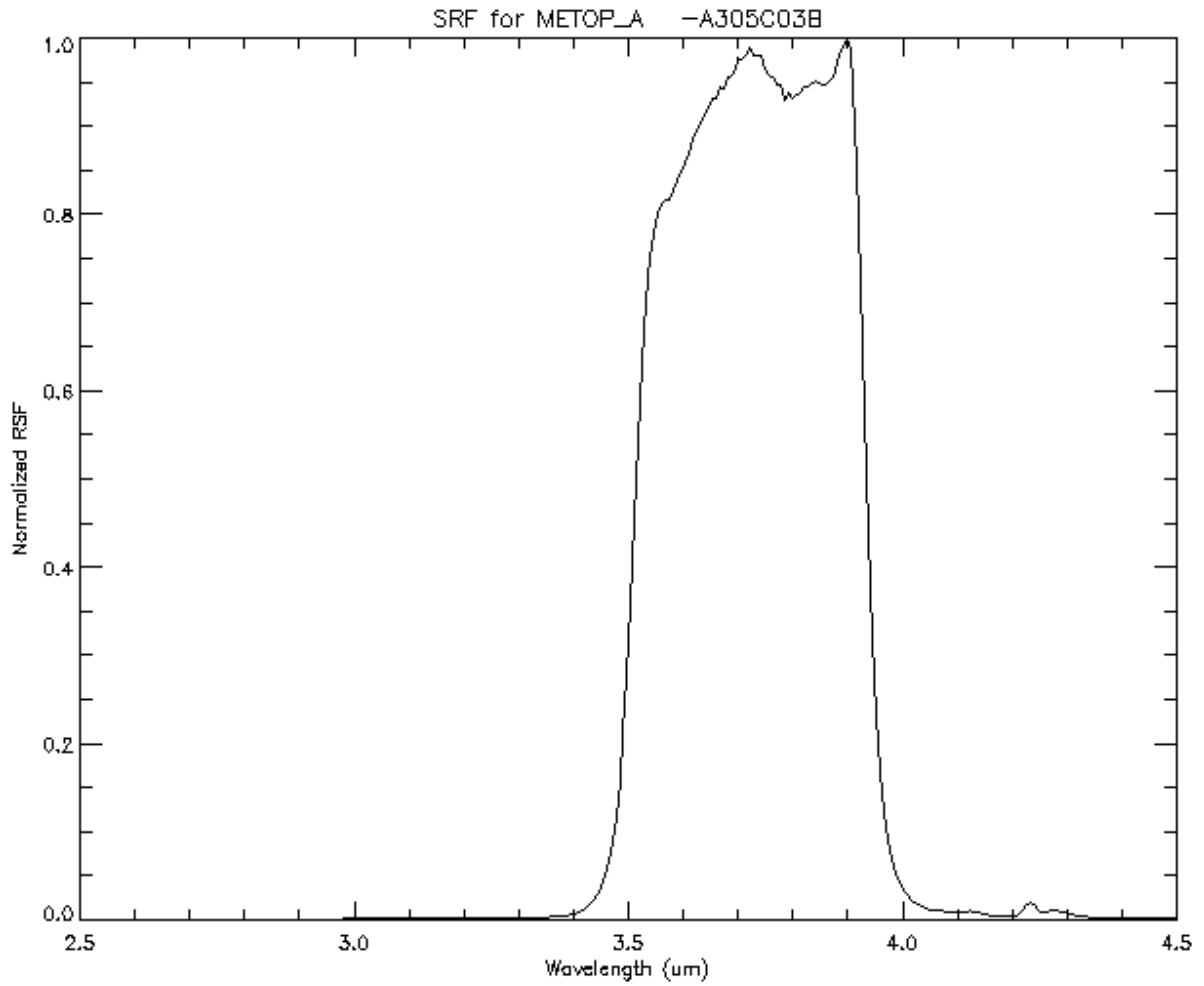

Figure D.5-4. Spectral Response Curve for MetOp-A Channel 3B.

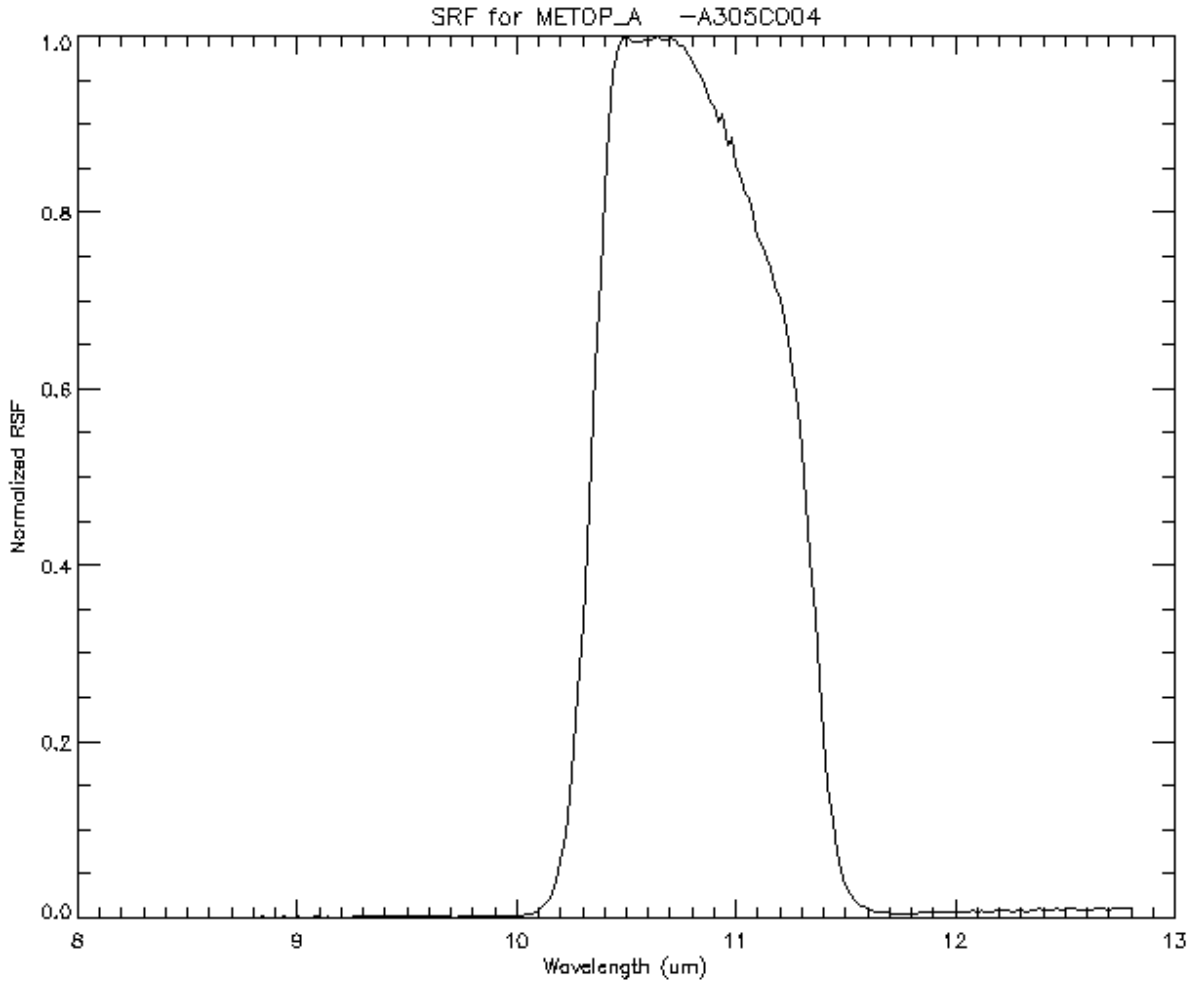

Figure D.5-5. Spectral Response Curve for MetOp-A Channel 4.

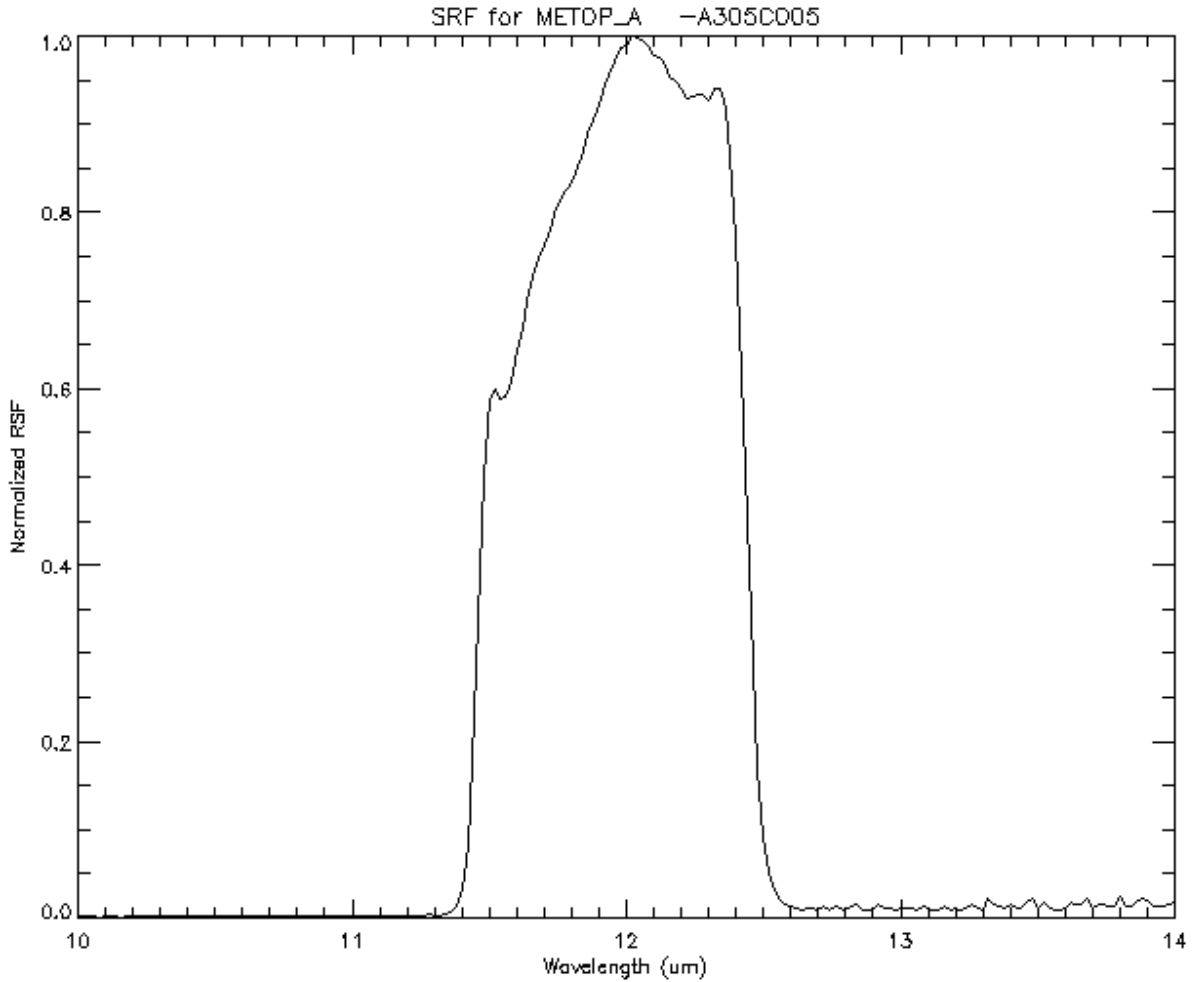

Figure D.5-6. Spectral Response Curve for MetOp-A Channel 5.

HIRS:

Table D.5-10 contains the MetOp-2 HIRS H306 central wave numbers, half power bandwidth and band correction coefficients for the thermal channels.

Table D.5-10. MetOp-2 HIRS (H306) Central Wave Numbers (ν_C), Half Power Bandwidth and Band Correction Coefficients (b and c).				
Channel #	ν_C (cm^{-1})	Half power bandwidth (cm^{-1})	b	c
1	668.66	3.23	.001249	.99999
2	679.18	10.15	.007424	.99997
3	689.70	14.58	.019006	.99991
4	701.99	15.66	.017762	.99992
5	716.47	16.86	.019533	.99991
6	731.71	16.93	.019816	.99991
7	748.82	17.37	.021136	.99991

8	898.59	34.64	.064148	.99977
9	1028.50	22.76	.039184	.99987
10	800.93	14.98	.015975	.99994
11	1361.90	39.12	.073425	.99982
12	1530.10	53.79	.113630	.99974
13	2189.70	20.61	.017029	.99997
14	2212.30	21.12	.018179	.99997
15	2237.60	21.83	.018575	.99997
16	2245.60	21.80	.017578	.99997
17	2418.90	27.79	.030204	.99995
18	2516.10	32.77	.049378	.99993
19	2663.37	102.58	.280270	.99962

Table D.5-11 contains the Internal Warm Temperature (IWT) PRT count to temperature coefficients for the MetOp-2 HIRS/306 instrument.

Table D.5-11. MetOp-2 IWT PRT Count to Temperature Coefficients for HIRS/306.						
PRT	A	B	C	D	E	F
1	28.204977	6.552487 E-03	8.844894 E-08	3.598945 E-11	9.799748 E-16	5.661177 E-19
2	28.20039	6.553611 E-03	8.788096 E-08	3.629800 E-11	1.016962 E-15	5.531661 E-19
3	28.22074	6.560474 E-03	8.747933 E-08	3.5917191 E-11	1.044505 E-15	5.770502 E-19
4	28.20408	6.563327 E-03	8.782467 E-08	3.637238 E-11	1.004441 E-15	5.594284 E-19
5	28.24092	6.555950 E-03	8.880498 E-08	3.601215 E-11	9.576640 E-16	5.685200 E-19
This information is based on the data in HIRS/4 H306 Alignment/Calibration Handbook, Revision E,						

Table D.5-12 contains the primary, secondary and tertiary telescope temperature coefficients for the MetOp-A HIRS/H305 instrument.

Table D.5-12. MetOp-2 HIRS/306 Primary, Secondary and Tertiary Telescope Temperature Coefficients.						
	A	B	C	D	E	F
Primary	-1.297965 E+01	1.766184 E-02	-3.8574729 E-06	1.412260 E-09	-2.77838 E-13	2.899835 E-17
Secondary	-1.296180 E+01	1.769990 E-02	-3.928084 E-06	1.457779 E-09	-2.903176 E-13	3.026201 E-017
Tertiary	-1.301502 E+01	1.722187 E-02	-3.903556 E-06	1.427024 E-09	-2.793666 E-13	2.901320 E-17
This information is based on the data in HIRS/4 H306 Alignment/Calibration Handbook,						

Table D.5-13 contains the actual filter functions for MetOp-A HIRS/H306. The same information can be downloaded as an ASCII file or viewed as a graphic file from the following website: <http://www.orbit.nesdis.noaa.gov/smcd/spb/calibration/hirs/srf/hirssrf.html>.

Table D.5-13. Normalized Response Functions for the MetOp-A HIRS H306 Thermal Channels.				
Channel 1				
Wavenumber	HIRS Filter Transmittance	Optical Element Transmittance	Product of the HIRS Filter and Optical Element Transmittances	Normalized Value of Column 4
6.6330000E+02	0.0000000E+00	2.2486000E-01	0.0000000E+00	0.0000000E+00
6.6340000E+02	1.1320000E-02	2.2486000E-01	2.5456000E-03	2.8961000E-02
6.6350000E+02	1.2687000E-02	2.2511000E-01	2.8558000E-03	3.2491000E-02
6.6360000E+02	1.4643000E-02	2.2535000E-01	3.2999000E-03	3.7544000E-02
6.6370000E+02	1.6778000E-02	2.2560000E-01	3.7851000E-03	4.3064000E-02
6.6380000E+02	1.9024000E-02	2.2585000E-01	4.2964000E-03	4.8882000E-02
6.6390000E+02	2.1621000E-02	2.2610000E-01	4.8885000E-03	5.5617000E-02
6.6400000E+02	2.4632000E-02	2.2634000E-01	5.5753000E-03	6.3431000E-02
6.6410000E+02	2.7677000E-02	2.2632000E-01	6.2638000E-03	7.1265000E-02
6.6420000E+02	3.0209000E-02	2.2629000E-01	6.8360000E-03	7.7775000E-02
6.6430000E+02	3.1952000E-02	2.2626000E-01	7.2295000E-03	8.2252000E-02
6.6440000E+02	3.3037000E-02	2.2623000E-01	7.4741000E-03	8.5035000E-02
6.6450000E+02	3.3807000E-02	2.2620000E-01	7.6472000E-03	8.7004000E-02
6.6460000E+02	3.4597000E-02	2.2617000E-01	7.8248000E-03	8.9025000E-02
6.6470000E+02	3.5685000E-02	2.2614000E-01	8.0697000E-03	9.1811000E-02
6.6480000E+02	3.7290000E-02	2.2610000E-01	8.4313000E-03	9.5925000E-02
6.6490000E+02	3.9502000E-02	2.2606000E-01	8.9300000E-03	1.0160000E-01
6.6500000E+02	4.2229000E-02	2.2602000E-01	9.5447000E-03	1.0859000E-01
6.6510000E+02	4.5284000E-02	2.2598000E-01	1.0233000E-02	1.1643000E-01
6.6520000E+02	4.8552000E-02	2.2594000E-01	1.0970000E-02	1.2481000E-01
6.6530000E+02	5.2025000E-02	2.2589000E-01	1.1752000E-02	1.3371000E-01
6.6540000E+02	5.5668000E-02	2.2585000E-01	1.2573000E-02	1.4304000E-01
6.6550000E+02	5.9305000E-02	2.2582000E-01	1.3392000E-02	1.5236000E-01
6.6560000E+02	6.2712000E-02	2.2582000E-01	1.4162000E-02	1.6112000E-01
6.6570000E+02	6.5863000E-02	2.2583000E-01	1.4874000E-02	1.6922000E-01
6.6580000E+02	6.9081000E-02	2.2584000E-01	1.5601000E-02	1.7750000E-01
6.6590000E+02	7.2932000E-02	2.2584000E-01	1.6471000E-02	1.8740000E-01
6.6600000E+02	7.7934000E-02	2.2585000E-01	1.7601000E-02	2.0025000E-01
6.6610000E+02	8.4268000E-02	2.2602000E-01	1.9046000E-02	2.1669000E-01
6.6620000E+02	9.1681000E-02	2.2619000E-01	2.0737000E-02	2.3593000E-01
6.6630000E+02	9.9615000E-02	2.2636000E-01	2.2549000E-02	2.5655000E-01

6.6640000E+02	1.0751000E-01	2.2653000E-01	2.4355000E-02	2.7709000E-01
6.6650000E+02	1.1511000E-01	2.2670000E-01	2.6096000E-02	2.9690000E-01
6.6660000E+02	1.2255000E-01	2.2687000E-01	2.7803000E-02	3.1633000E-01
6.6670000E+02	1.3024000E-01	2.2704000E-01	2.9569000E-02	3.3642000E-01
6.6680000E+02	1.3860000E-01	2.2722000E-01	3.1491000E-02	3.5828000E-01
6.6690000E+02	1.4789000E-01	2.2739000E-01	3.3628000E-02	3.8259000E-01
6.6700000E+02	1.5816000E-01	2.2756000E-01	3.5992000E-02	4.0948000E-01
6.6710000E+02	1.6933000E-01	2.2776000E-01	3.8567000E-02	4.3878000E-01
6.6720000E+02	1.8119000E-01	2.2796000E-01	4.1304000E-02	4.6992000E-01
6.6730000E+02	1.9348000E-01	2.2816000E-01	4.4145000E-02	5.0225000E-01
6.6740000E+02	2.0595000E-01	2.2836000E-01	4.7031000E-02	5.3508000E-01
6.6750000E+02	2.1837000E-01	2.2861000E-01	4.9922000E-02	5.6797000E-01
6.6760000E+02	2.3060000E-01	2.2886000E-01	5.2774000E-02	6.0042000E-01
6.6770000E+02	2.4261000E-01	2.2911000E-01	5.5583000E-02	6.3239000E-01
6.6780000E+02	2.5464000E-01	2.2936000E-01	5.8404000E-02	6.6448000E-01
6.6790000E+02	2.6726000E-01	2.2961000E-01	6.1367000E-02	6.9819000E-01
6.6800000E+02	2.8121000E-01	2.2987000E-01	6.4640000E-02	7.3543000E-01
6.6810000E+02	2.9691000E-01	2.3022000E-01	6.8355000E-02	7.7769000E-01
6.6820000E+02	3.1403000E-01	2.3057000E-01	7.2407000E-02	8.2379000E-01
6.6830000E+02	3.3131000E-01	2.3093000E-01	7.6509000E-02	8.7046000E-01
6.6840000E+02	3.4705000E-01	2.3128000E-01	8.0268000E-02	9.1322000E-01
6.6850000E+02	3.5979000E-01	2.3164000E-01	8.3341000E-02	9.4819000E-01
6.6860000E+02	3.6882000E-01	2.3199000E-01	8.5565000E-02	9.7349000E-01
6.6870000E+02	3.7430000E-01	2.3235000E-01	8.6968000E-02	9.8946000E-01
6.6880000E+02	3.7684000E-01	2.3271000E-01	8.7693000E-02	9.9771000E-01
6.6890000E+02	3.7712000E-01	2.3307000E-01	8.7895000E-02	1.0000000E+00
6.6900000E+02	3.7562000E-01	2.3342000E-01	8.7679000E-02	9.9755000E-01
6.6910000E+02	3.7266000E-01	2.3378000E-01	8.7119000E-02	9.9117000E-01
6.6920000E+02	3.6860000E-01	2.3413000E-01	8.6302000E-02	9.8188000E-01
6.6930000E+02	3.6397000E-01	2.3449000E-01	8.5348000E-02	9.7102000E-01
6.6940000E+02	3.5910000E-01	2.3488000E-01	8.4346000E-02	9.5962000E-01
6.6950000E+02	3.5363000E-01	2.3530000E-01	8.3211000E-02	9.4671000E-01
6.6960000E+02	3.4637000E-01	2.3572000E-01	8.1648000E-02	9.2893000E-01
6.6970000E+02	3.3573000E-01	2.3614000E-01	7.9281000E-02	9.0199000E-01
6.6980000E+02	3.2070000E-01	2.3656000E-01	7.5865000E-02	8.6314000E-01
6.6990000E+02	3.0153000E-01	2.3699000E-01	7.1459000E-02	8.1301000E-01
6.7000000E+02	2.7966000E-01	2.3741000E-01	6.6393000E-02	7.5537000E-01
6.7010000E+02	2.5686000E-01	2.3760000E-01	6.1032000E-02	6.9437000E-01
6.7020000E+02	2.3459000E-01	2.3780000E-01	5.5784000E-02	6.3467000E-01
6.7030000E+02	2.1374000E-01	2.3799000E-01	5.0868000E-02	5.7874000E-01
6.7040000E+02	1.9492000E-01	2.3818000E-01	4.6427000E-02	5.2821000E-01
6.7050000E+02	1.7853000E-01	2.3838000E-01	4.2558000E-02	4.8420000E-01
6.7060000E+02	1.6459000E-01	2.3857000E-01	3.9267000E-02	4.4675000E-01

6.7070000E+02	1.5247000E-01	2.3876000E-01	3.6404000E-02	4.1417000E-01
6.7080000E+02	1.4104000E-01	2.3895000E-01	3.3703000E-02	3.8344000E-01
6.7090000E+02	1.2924000E-01	2.3914000E-01	3.0907000E-02	3.5163000E-01
6.7100000E+02	1.1657000E-01	2.3934000E-01	2.7899000E-02	3.1741000E-01
6.7110000E+02	1.0330000E-01	2.3952000E-01	2.4744000E-02	2.8152000E-01
6.7120000E+02	9.0280000E-02	2.3971000E-01	2.1641000E-02	2.4622000E-01
6.7130000E+02	7.8456000E-02	2.3992000E-01	1.8823000E-02	2.1415000E-01
6.7140000E+02	6.8499000E-02	2.4015000E-01	1.6450000E-02	1.8716000E-01
6.7150000E+02	6.0516000E-02	2.4039000E-01	1.4547000E-02	1.6551000E-01
6.7160000E+02	5.4062000E-02	2.4063000E-01	1.3009000E-02	1.4800000E-01
6.7170000E+02	4.8466000E-02	2.4086000E-01	1.1674000E-02	1.3282000E-01
6.7180000E+02	4.3271000E-02	2.4110000E-01	1.0433000E-02	1.1870000E-01
6.7190000E+02	3.8426000E-02	2.4134000E-01	9.2736000E-03	1.0551000E-01
6.7200000E+02	3.4072000E-02	2.4157000E-01	8.2308000E-03	9.3644000E-02
6.7210000E+02	3.0171000E-02	2.4190000E-01	7.2983000E-03	8.3034000E-02
6.7220000E+02	2.6414000E-02	2.4222000E-01	6.3979000E-03	7.2791000E-02
6.7230000E+02	2.2517000E-02	2.4254000E-01	5.4612000E-03	6.2133000E-02
6.7240000E+02	1.8563000E-02	2.4286000E-01	4.5082000E-03	5.1290000E-02
6.7250000E+02	1.4965000E-02	2.4318000E-01	3.6393000E-03	4.1405000E-02
6.7260000E+02	1.2078000E-02	2.4350000E-01	2.9409000E-03	3.3459000E-02
6.7270000E+02	9.8908000E-03	2.4382000E-01	2.4115000E-03	2.7437000E-02
6.7280000E+02	8.1389000E-03	2.4413000E-01	1.9870000E-03	2.2606000E-02
6.7290000E+02	6.6381000E-03	2.4445000E-01	1.6227000E-03	1.8462000E-02
6.7300000E+02	5.4414000E-03	2.4477000E-01	1.3319000E-03	1.5153000E-02
6.7310000E+02	4.6697000E-03	2.4508000E-01	1.1444000E-03	1.3021000E-02
6.7320000E+02	4.2909000E-03	2.4539000E-01	1.0530000E-03	1.1980000E-02
6.7330000E+02	4.1440000E-03	2.4570000E-01	1.0182000E-03	1.1584000E-02
6.7340000E+02	4.1366000E-03	2.4601000E-01	1.0177000E-03	1.1578000E-02
6.7350000E+02	0.0000000E+00	2.4601000E-01	0.0000000E+00	0.0000000E+00
Channel 2				
Wavenumber	HIRS Filter Transmittance	Optical Element Transmittance	Product of the HIRS Filter and Optical Element Transmittances	Normalized Value of Column 4
6.6800000E+02	0.0000000E+00	2.2987000E-01	0.0000000E+00	0.0000000E+00
6.6810000E+02	7.6025000E-04	2.3022000E-01	1.7502000E-04	9.9012000E-04
6.6820000E+02	1.2685000E-03	2.3057000E-01	2.9249000E-04	1.6547000E-03
6.6830000E+02	1.8495000E-03	2.3093000E-01	4.2711000E-04	2.4162000E-03
6.6840000E+02	2.4677000E-03	2.3128000E-01	5.7074000E-04	3.2287000E-03
6.6850000E+02	3.0886000E-03	2.3164000E-01	7.1543000E-04	4.0472000E-03
6.6860000E+02	3.6845000E-03	2.3199000E-01	8.5478000E-04	4.8356000E-03
6.6870000E+02	4.2378000E-03	2.3235000E-01	9.8465000E-04	5.5702000E-03
6.6880000E+02	4.7409000E-03	2.3271000E-01	1.1032000E-03	6.2411000E-03

6.6890000E+02	5.1938000E-03	2.3307000E-01	1.2105000E-03	6.8479000E-03
6.6900000E+02	5.6008000E-03	2.3342000E-01	1.3074000E-03	7.3958000E-03
6.6910000E+02	5.9662000E-03	2.3378000E-01	1.3948000E-03	7.8902000E-03
6.6920000E+02	6.2928000E-03	2.3413000E-01	1.4733000E-03	8.3348000E-03
6.6930000E+02	6.5819000E-03	2.3449000E-01	1.5434000E-03	8.7311000E-03
6.6940000E+02	6.8350000E-03	2.3488000E-01	1.6054000E-03	9.0820000E-03
6.6950000E+02	7.0565000E-03	2.3530000E-01	1.6604000E-03	9.3930000E-03
6.6960000E+02	7.2561000E-03	2.3572000E-01	1.7104000E-03	9.6760000E-03
6.6970000E+02	7.4506000E-03	2.3614000E-01	1.7594000E-03	9.9531000E-03
6.6980000E+02	7.6630000E-03	2.3656000E-01	1.8128000E-03	1.0255000E-02
6.6990000E+02	7.9208000E-03	2.3699000E-01	1.8771000E-03	1.0619000E-02
6.7000000E+02	8.2535000E-03	2.3741000E-01	1.9595000E-03	1.1085000E-02
6.7010000E+02	8.6901000E-03	2.3760000E-01	2.0648000E-03	1.1681000E-02
6.7020000E+02	9.2573000E-03	2.3780000E-01	2.2014000E-03	1.2453000E-02
6.7030000E+02	9.9794000E-03	2.3799000E-01	2.3750000E-03	1.3436000E-02
6.7040000E+02	1.0879000E-02	2.3818000E-01	2.5912000E-03	1.4659000E-02
6.7050000E+02	1.1978000E-02	2.3838000E-01	2.8554000E-03	1.6153000E-02
6.7060000E+02	1.3301000E-02	2.3857000E-01	3.1732000E-03	1.7951000E-02
6.7070000E+02	1.4872000E-02	2.3876000E-01	3.5509000E-03	2.0088000E-02
6.7080000E+02	1.6718000E-02	2.3895000E-01	3.9949000E-03	2.2599000E-02
6.7090000E+02	1.8867000E-02	2.3914000E-01	4.5119000E-03	2.5524000E-02
6.7100000E+02	2.1345000E-02	2.3934000E-01	5.1085000E-03	2.8899000E-02
6.7110000E+02	2.4177000E-02	2.3952000E-01	5.7911000E-03	3.2761000E-02
6.7120000E+02	2.7390000E-02	2.3971000E-01	6.5656000E-03	3.7142000E-02
6.7130000E+02	3.1004000E-02	2.3992000E-01	7.4384000E-03	4.2080000E-02
6.7140000E+02	3.5046000E-02	2.4015000E-01	8.4165000E-03	4.7613000E-02
6.7150000E+02	3.9542000E-02	2.4039000E-01	9.5054000E-03	5.3773000E-02
6.7160000E+02	4.4519000E-02	2.4063000E-01	1.0712000E-02	6.0601000E-02
6.7170000E+02	5.0010000E-02	2.4086000E-01	1.2046000E-02	6.8143000E-02
6.7180000E+02	5.6050000E-02	2.4110000E-01	1.3514000E-02	7.6448000E-02
6.7190000E+02	6.2673000E-02	2.4134000E-01	1.5125000E-02	8.5566000E-02
6.7200000E+02	6.9913000E-02	2.4157000E-01	1.6889000E-02	9.5544000E-02
6.7210000E+02	7.7803000E-02	2.4190000E-01	1.8820000E-02	1.0647000E-01
6.7220000E+02	8.6369000E-02	2.4222000E-01	2.0920000E-02	1.1835000E-01
6.7230000E+02	9.5637000E-02	2.4254000E-01	2.3196000E-02	1.3122000E-01
6.7240000E+02	1.0562000E-01	2.4286000E-01	2.5652000E-02	1.4511000E-01
6.7250000E+02	1.1635000E-01	2.4318000E-01	2.8293000E-02	1.6006000E-01
6.7260000E+02	1.2781000E-01	2.4350000E-01	3.1121000E-02	1.7606000E-01
6.7270000E+02	1.4002000E-01	2.4382000E-01	3.4138000E-02	1.9312000E-01
6.7280000E+02	1.5295000E-01	2.4413000E-01	3.7341000E-02	2.1124000E-01
6.7290000E+02	1.6661000E-01	2.4445000E-01	4.0727000E-02	2.3040000E-01
6.7300000E+02	1.8094000E-01	2.4477000E-01	4.4288000E-02	2.5054000E-01
6.7310000E+02	1.9591000E-01	2.4508000E-01	4.8015000E-02	2.7162000E-01

6.7320000E+02	2.1146000E-01	2.4539000E-01	5.1892000E-02	2.9356000E-01
6.7330000E+02	2.2752000E-01	2.4570000E-01	5.5903000E-02	3.1625000E-01
6.7340000E+02	2.4401000E-01	2.4601000E-01	6.0029000E-02	3.3959000E-01
6.7350000E+02	2.6083000E-01	2.4632000E-01	6.4249000E-02	3.6346000E-01
6.7360000E+02	2.7790000E-01	2.4663000E-01	6.8538000E-02	3.8772000E-01
6.7370000E+02	2.9509000E-01	2.4694000E-01	7.2871000E-02	4.1223000E-01
6.7380000E+02	3.1232000E-01	2.4725000E-01	7.7220000E-02	4.3684000E-01
6.7390000E+02	3.2946000E-01	2.4756000E-01	8.1559000E-02	4.6139000E-01
6.7400000E+02	3.4639000E-01	2.4787000E-01	8.5859000E-02	4.8571000E-01
6.7410000E+02	3.6302000E-01	2.4800000E-01	9.0029000E-02	5.0930000E-01
6.7420000E+02	3.7923000E-01	2.4814000E-01	9.4100000E-02	5.3233000E-01
6.7430000E+02	3.9491000E-01	2.4827000E-01	9.8045000E-02	5.5465000E-01
6.7440000E+02	4.0998000E-01	2.4840000E-01	1.0184000E-01	5.7612000E-01
6.7450000E+02	4.2436000E-01	2.4854000E-01	1.0547000E-01	5.9665000E-01
6.7460000E+02	4.3797000E-01	2.4867000E-01	1.0891000E-01	6.1612000E-01
6.7470000E+02	4.5078000E-01	2.4881000E-01	1.1216000E-01	6.3448000E-01
6.7480000E+02	4.6274000E-01	2.4894000E-01	1.1519000E-01	6.5166000E-01
6.7490000E+02	4.7383000E-01	2.4907000E-01	1.1802000E-01	6.6763000E-01
6.7500000E+02	4.8405000E-01	2.4920000E-01	1.2063000E-01	6.8239000E-01
6.7510000E+02	4.9341000E-01	2.4933000E-01	1.2302000E-01	6.9594000E-01
6.7520000E+02	5.0193000E-01	2.4942000E-01	1.2519000E-01	7.0821000E-01
6.7530000E+02	5.0966000E-01	2.4949000E-01	1.2715000E-01	7.1931000E-01
6.7540000E+02	5.1664000E-01	2.4955000E-01	1.2893000E-01	7.2936000E-01
6.7550000E+02	5.2294000E-01	2.4962000E-01	1.3054000E-01	7.3846000E-01
6.7560000E+02	5.2863000E-01	2.4969000E-01	1.3199000E-01	7.4670000E-01
6.7570000E+02	5.3380000E-01	2.4976000E-01	1.3332000E-01	7.5421000E-01
6.7580000E+02	5.3853000E-01	2.4982000E-01	1.3454000E-01	7.6109000E-01
6.7590000E+02	5.4290000E-01	2.4989000E-01	1.3567000E-01	7.6748000E-01
6.7600000E+02	5.4701000E-01	2.4996000E-01	1.3673000E-01	7.7349000E-01
6.7610000E+02	5.5094000E-01	2.5012000E-01	1.3780000E-01	7.7955000E-01
6.7620000E+02	5.5476000E-01	2.5029000E-01	1.3885000E-01	7.8548000E-01
6.7630000E+02	5.5856000E-01	2.5045000E-01	1.3989000E-01	7.9137000E-01
6.7640000E+02	5.6239000E-01	2.5061000E-01	1.4094000E-01	7.9732000E-01
6.7650000E+02	5.6632000E-01	2.5078000E-01	1.4202000E-01	8.0342000E-01
6.7660000E+02	5.7040000E-01	2.5094000E-01	1.4314000E-01	8.0973000E-01
6.7670000E+02	5.7467000E-01	2.5110000E-01	1.4430000E-01	8.1631000E-01
6.7680000E+02	5.7915000E-01	2.5126000E-01	1.4552000E-01	8.2321000E-01
6.7690000E+02	5.8387000E-01	2.5142000E-01	1.4680000E-01	8.3045000E-01
6.7700000E+02	5.8883000E-01	2.5158000E-01	1.4814000E-01	8.3803000E-01
6.7710000E+02	5.9402000E-01	2.5173000E-01	1.4953000E-01	8.4591000E-01
6.7720000E+02	5.9944000E-01	2.5185000E-01	1.5097000E-01	8.5404000E-01
6.7730000E+02	6.0505000E-01	2.5197000E-01	1.5246000E-01	8.6245000E-01
6.7740000E+02	6.1084000E-01	2.5209000E-01	1.5399000E-01	8.7112000E-01

6.7750000E+02	6.1676000E-01	2.5221000E-01	1.5555000E-01	8.7998000E-01
6.7760000E+02	6.2277000E-01	2.5233000E-01	1.5714000E-01	8.8897000E-01
6.7770000E+02	6.2883000E-01	2.5245000E-01	1.5874000E-01	8.9803000E-01
6.7780000E+02	6.3487000E-01	2.5256000E-01	1.6034000E-01	9.0708000E-01
6.7790000E+02	6.4086000E-01	2.5268000E-01	1.6193000E-01	9.1605000E-01
6.7800000E+02	6.4673000E-01	2.5279000E-01	1.6349000E-01	9.2485000E-01
6.7810000E+02	6.5242000E-01	2.5305000E-01	1.6509000E-01	9.3394000E-01
6.7820000E+02	6.5789000E-01	2.5330000E-01	1.6664000E-01	9.4272000E-01
6.7830000E+02	6.6307000E-01	2.5356000E-01	1.6813000E-01	9.5110000E-01
6.7840000E+02	6.6792000E-01	2.5381000E-01	1.6953000E-01	9.5902000E-01
6.7850000E+02	6.7239000E-01	2.5406000E-01	1.7083000E-01	9.6639000E-01
6.7860000E+02	6.7642000E-01	2.5432000E-01	1.7203000E-01	9.7316000E-01
6.7870000E+02	6.7999000E-01	2.5457000E-01	1.7310000E-01	9.7926000E-01
6.7880000E+02	6.8305000E-01	2.5482000E-01	1.7406000E-01	9.8464000E-01
6.7890000E+02	6.8558000E-01	2.5507000E-01	1.7487000E-01	9.8926000E-01
6.7900000E+02	6.8754000E-01	2.5533000E-01	1.7555000E-01	9.9308000E-01
6.7910000E+02	6.8892000E-01	2.5559000E-01	1.7608000E-01	9.9611000E-01
6.7920000E+02	6.8970000E-01	2.5586000E-01	1.7647000E-01	9.9828000E-01
6.7930000E+02	6.8988000E-01	2.5612000E-01	1.7670000E-01	9.9958000E-01
6.7940000E+02	6.8946000E-01	2.5639000E-01	1.7677000E-01	1.0000000E+00
6.7950000E+02	6.8843000E-01	2.5666000E-01	1.7669000E-01	9.9955000E-01
6.7960000E+02	6.8682000E-01	2.5692000E-01	1.7646000E-01	9.9824000E-01
6.7970000E+02	6.8464000E-01	2.5719000E-01	1.7608000E-01	9.9609000E-01
6.7980000E+02	6.8190000E-01	2.5745000E-01	1.7556000E-01	9.9314000E-01
6.7990000E+02	6.7865000E-01	2.5772000E-01	1.7490000E-01	9.8942000E-01
6.8000000E+02	6.7491000E-01	2.5798000E-01	1.7411000E-01	9.8498000E-01
6.8010000E+02	6.7072000E-01	2.5804000E-01	1.7307000E-01	9.7908000E-01
6.8020000E+02	6.6611000E-01	2.5810000E-01	1.7192000E-01	9.7258000E-01
6.8030000E+02	6.6113000E-01	2.5816000E-01	1.7068000E-01	9.6552000E-01
6.8040000E+02	6.5582000E-01	2.5822000E-01	1.6934000E-01	9.5798000E-01
6.8050000E+02	6.5022000E-01	2.5827000E-01	1.6793000E-01	9.5001000E-01
6.8060000E+02	6.4437000E-01	2.5833000E-01	1.6646000E-01	9.4168000E-01
6.8070000E+02	6.3832000E-01	2.5839000E-01	1.6494000E-01	9.3305000E-01
6.8080000E+02	6.3212000E-01	2.5844000E-01	1.6337000E-01	9.2418000E-01
6.8090000E+02	6.2578000E-01	2.5850000E-01	1.6176000E-01	9.1511000E-01
6.8100000E+02	6.1935000E-01	2.5856000E-01	1.6014000E-01	9.0593000E-01
6.8110000E+02	6.1285000E-01	2.5864000E-01	1.5851000E-01	8.9668000E-01
6.8120000E+02	6.0630000E-01	2.5871000E-01	1.5686000E-01	8.8734000E-01
6.8130000E+02	5.9972000E-01	2.5878000E-01	1.5520000E-01	8.7795000E-01
6.8140000E+02	5.9312000E-01	2.5885000E-01	1.5353000E-01	8.6852000E-01
6.8150000E+02	5.8650000E-01	2.5892000E-01	1.5186000E-01	8.5906000E-01
6.8160000E+02	5.7985000E-01	2.5899000E-01	1.5017000E-01	8.4955000E-01
6.8170000E+02	5.7316000E-01	2.5906000E-01	1.4848000E-01	8.3998000E-01

6.8180000E+02	5.6643000E-01	2.5913000E-01	1.4678000E-01	8.3033000E-01
6.8190000E+02	5.5962000E-01	2.5920000E-01	1.4505000E-01	8.2057000E-01
6.8200000E+02	5.5272000E-01	2.5927000E-01	1.4330000E-01	8.1066000E-01
6.8210000E+02	5.4568000E-01	2.5951000E-01	1.4161000E-01	8.0110000E-01
6.8220000E+02	5.3847000E-01	2.5976000E-01	1.3988000E-01	7.9128000E-01
6.8230000E+02	5.3107000E-01	2.6001000E-01	1.3808000E-01	7.8115000E-01
6.8240000E+02	5.2342000E-01	2.6026000E-01	1.3622000E-01	7.7063000E-01
6.8250000E+02	5.1550000E-01	2.6051000E-01	1.3429000E-01	7.5969000E-01
6.8260000E+02	5.0726000E-01	2.6075000E-01	1.3227000E-01	7.4827000E-01
6.8270000E+02	4.9868000E-01	2.6100000E-01	1.3016000E-01	7.3631000E-01
6.8280000E+02	4.8973000E-01	2.6125000E-01	1.2794000E-01	7.2377000E-01
6.8290000E+02	4.8038000E-01	2.6150000E-01	1.2562000E-01	7.1063000E-01
6.8300000E+02	4.7061000E-01	2.6175000E-01	1.2318000E-01	6.9684000E-01
6.8310000E+02	4.6040000E-01	2.6200000E-01	1.2063000E-01	6.8239000E-01
6.8320000E+02	4.4976000E-01	2.6225000E-01	1.1795000E-01	6.6726000E-01
6.8330000E+02	4.3868000E-01	2.6251000E-01	1.1516000E-01	6.5145000E-01
6.8340000E+02	4.2716000E-01	2.6276000E-01	1.1224000E-01	6.3496000E-01
6.8350000E+02	4.1523000E-01	2.6301000E-01	1.0921000E-01	6.1781000E-01
6.8360000E+02	4.0290000E-01	2.6326000E-01	1.0607000E-01	6.0004000E-01
6.8370000E+02	3.9021000E-01	2.6352000E-01	1.0283000E-01	5.8170000E-01
6.8380000E+02	3.7719000E-01	2.6377000E-01	9.9490000E-02	5.6282000E-01
6.8390000E+02	3.6388000E-01	2.6402000E-01	9.6070000E-02	5.4348000E-01
6.8400000E+02	3.5032000E-01	2.6427000E-01	9.2580000E-02	5.2373000E-01
6.8410000E+02	3.3657000E-01	2.6434000E-01	8.8967000E-02	5.0329000E-01
6.8420000E+02	3.2267000E-01	2.6440000E-01	8.5315000E-02	4.8263000E-01
6.8430000E+02	3.0869000E-01	2.6446000E-01	8.1637000E-02	4.6182000E-01
6.8440000E+02	2.9467000E-01	2.6452000E-01	7.7948000E-02	4.4096000E-01
6.8450000E+02	2.8068000E-01	2.6459000E-01	7.4264000E-02	4.2012000E-01
6.8460000E+02	2.6676000E-01	2.6465000E-01	7.0599000E-02	3.9938000E-01
6.8470000E+02	2.5298000E-01	2.6471000E-01	6.6966000E-02	3.7883000E-01
6.8480000E+02	2.3938000E-01	2.6477000E-01	6.3381000E-02	3.5855000E-01
6.8490000E+02	2.2601000E-01	2.6484000E-01	5.9855000E-02	3.3860000E-01
6.8500000E+02	2.1291000E-01	2.6490000E-01	5.6399000E-02	3.1905000E-01
6.8510000E+02	2.0012000E-01	2.6496000E-01	5.3023000E-02	2.9996000E-01
6.8520000E+02	1.8767000E-01	2.6502000E-01	4.9737000E-02	2.8137000E-01
6.8530000E+02	1.7560000E-01	2.6508000E-01	4.6549000E-02	2.6333000E-01
6.8540000E+02	1.6393000E-01	2.6514000E-01	4.3465000E-02	2.4589000E-01
6.8550000E+02	1.5269000E-01	2.6520000E-01	4.0492000E-02	2.2907000E-01
6.8560000E+02	1.4188000E-01	2.6526000E-01	3.7635000E-02	2.1291000E-01
6.8570000E+02	1.3153000E-01	2.6531000E-01	3.4898000E-02	1.9742000E-01
6.8580000E+02	1.2165000E-01	2.6537000E-01	3.2283000E-02	1.8263000E-01
6.8590000E+02	1.1224000E-01	2.6543000E-01	2.9792000E-02	1.6854000E-01
6.8600000E+02	1.0331000E-01	2.6549000E-01	2.7426000E-02	1.5515000E-01

6.8610000E+02	9.4843000E-02	2.6586000E-01	2.5215000E-02	1.4265000E-01
6.8620000E+02	8.6851000E-02	2.6624000E-01	2.3123000E-02	1.3081000E-01
6.8630000E+02	7.9326000E-02	2.6662000E-01	2.1150000E-02	1.1965000E-01
6.8640000E+02	7.2264000E-02	2.6700000E-01	1.9294000E-02	1.0915000E-01
6.8650000E+02	6.5658000E-02	2.6737000E-01	1.7555000E-02	9.9311000E-02
6.8660000E+02	5.9505000E-02	2.6775000E-01	1.5932000E-02	9.0130000E-02
6.8670000E+02	5.3794000E-02	2.6813000E-01	1.4424000E-02	8.1595000E-02
6.8680000E+02	4.8517000E-02	2.6852000E-01	1.3027000E-02	7.3697000E-02
6.8690000E+02	4.3659000E-02	2.6891000E-01	1.1740000E-02	6.6416000E-02
6.8700000E+02	3.9208000E-02	2.6930000E-01	1.0559000E-02	5.9731000E-02
6.8710000E+02	3.5146000E-02	2.6969000E-01	9.4784000E-03	5.3620000E-02
6.8720000E+02	3.1456000E-02	2.7008000E-01	8.4956000E-03	4.8060000E-02
6.8730000E+02	2.8122000E-02	2.7047000E-01	7.6061000E-03	4.3028000E-02
6.8740000E+02	2.5127000E-02	2.7086000E-01	6.8057000E-03	3.8500000E-02
6.8750000E+02	2.2452000E-02	2.7125000E-01	6.0901000E-03	3.4452000E-02
6.8760000E+02	2.0080000E-02	2.7164000E-01	5.4544000E-03	3.0856000E-02
6.8770000E+02	1.7989000E-02	2.7203000E-01	4.8934000E-03	2.7682000E-02
6.8780000E+02	1.6155000E-02	2.7242000E-01	4.4009000E-03	2.4896000E-02
6.8790000E+02	1.4553000E-02	2.7281000E-01	3.9701000E-03	2.2459000E-02
6.8800000E+02	1.3156000E-02	2.7320000E-01	3.5941000E-03	2.0332000E-02
6.8810000E+02	1.1936000E-02	2.7349000E-01	3.2643000E-03	1.8466000E-02
6.8820000E+02	1.0869000E-02	2.7377000E-01	2.9757000E-03	1.6833000E-02
6.8830000E+02	9.9322000E-03	2.7406000E-01	2.7221000E-03	1.5399000E-02
6.8840000E+02	9.1063000E-03	2.7435000E-01	2.4983000E-03	1.4133000E-02
6.8850000E+02	8.3740000E-03	2.7464000E-01	2.2999000E-03	1.3010000E-02
6.8860000E+02	7.7194000E-03	2.7493000E-01	2.1223000E-03	1.2006000E-02
6.8870000E+02	7.1268000E-03	2.7523000E-01	1.9615000E-03	1.1096000E-02
6.8880000E+02	6.5804000E-03	2.7552000E-01	1.8130000E-03	1.0256000E-02
6.8890000E+02	6.0650000E-03	2.7581000E-01	1.6728000E-03	9.4632000E-03
6.8900000E+02	5.5671000E-03	2.7611000E-01	1.5371000E-03	8.6956000E-03
6.8910000E+02	5.0773000E-03	2.7640000E-01	1.4034000E-03	7.9390000E-03
6.8920000E+02	4.5915000E-03	2.7670000E-01	1.2704000E-03	7.1870000E-03
6.8930000E+02	4.1114000E-03	2.7699000E-01	1.1388000E-03	6.4424000E-03
6.8940000E+02	3.6438000E-03	2.7728000E-01	1.0104000E-03	5.7157000E-03
6.8950000E+02	3.1978000E-03	2.7758000E-01	8.8764000E-04	5.0214000E-03
6.8960000E+02	2.7823000E-03	2.7787000E-01	7.7312000E-04	4.3736000E-03
6.8970000E+02	2.4028000E-03	2.7816000E-01	6.6837000E-04	3.7810000E-03
6.8980000E+02	2.0599000E-03	2.7846000E-01	5.7360000E-04	3.2449000E-03
6.8990000E+02	1.7496000E-03	2.7875000E-01	4.8770000E-04	2.7590000E-03
6.9000000E+02	1.4648000E-03	2.7904000E-01	4.0875000E-04	2.3123000E-03
6.9010000E+02	1.1985000E-03	2.7926000E-01	3.3470000E-04	1.8934000E-03
6.9020000E+02	9.4686000E-04	2.7948000E-01	2.6463000E-04	1.4970000E-03
6.9030000E+02	7.1098000E-04	2.7970000E-01	1.9886000E-04	1.1250000E-03

6.9040000E+02	4.9731000E-04	2.7992000E-01	1.3920000E-04	7.8749000E-04
6.9050000E+02	3.1565000E-04	2.8013000E-01	8.8423000E-05	5.0021000E-04
6.9060000E+02	0.0000000E+00	2.8036000E-01	0.0000000E+00	0.0000000E+00
Channel 3				
Wavenumber	HIRS Filter Transmittance	Optical Element Transmittance	Product of the HIRS Filter and Optical Element Transmittances	Normalized Value of Column 4
6.7300000E+02	0.0000000E+00	2.4477000E-01	0.0000000E+00	0.0000000E+00
6.7305000E+02	4.5520000E-03	2.4492000E-01	1.1149000E-03	4.8995000E-03
6.7310000E+02	4.4826000E-03	2.4508000E-01	1.0986000E-03	4.8279000E-03
6.7315000E+02	4.4199000E-03	2.4524000E-01	1.0839000E-03	4.7634000E-03
6.7320000E+02	4.3692000E-03	2.4539000E-01	1.0722000E-03	4.7118000E-03
6.7325000E+02	4.3353000E-03	2.4555000E-01	1.0645000E-03	4.6781000E-03
6.7330000E+02	4.3227000E-03	2.4570000E-01	1.0621000E-03	4.6675000E-03
6.7335000E+02	4.3353000E-03	2.4586000E-01	1.0659000E-03	4.6840000E-03
6.7340000E+02	4.3764000E-03	2.4601000E-01	1.0766000E-03	4.7314000E-03
6.7345000E+02	4.4483000E-03	2.4617000E-01	1.0950000E-03	4.8122000E-03
6.7350000E+02	4.5527000E-03	2.4632000E-01	1.1214000E-03	4.9282000E-03
6.7355000E+02	4.6901000E-03	2.4648000E-01	1.1560000E-03	5.0801000E-03
6.7360000E+02	4.8602000E-03	2.4663000E-01	1.1987000E-03	5.2677000E-03
6.7365000E+02	5.0617000E-03	2.4679000E-01	1.2492000E-03	5.4895000E-03
6.7370000E+02	5.2925000E-03	2.4694000E-01	1.3069000E-03	5.7434000E-03
6.7375000E+02	5.5494000E-03	2.4710000E-01	1.3712000E-03	6.0260000E-03
6.7380000E+02	5.8288000E-03	2.4725000E-01	1.4412000E-03	6.3333000E-03
6.7385000E+02	6.1263000E-03	2.4740000E-01	1.5157000E-03	6.6607000E-03
6.7390000E+02	6.4371000E-03	2.4756000E-01	1.5936000E-03	7.0030000E-03
6.7395000E+02	6.7561000E-03	2.4771000E-01	1.6736000E-03	7.3545000E-03
6.7400000E+02	7.0779000E-03	2.4787000E-01	1.7544000E-03	7.7097000E-03
6.7405000E+02	7.3975000E-03	2.4793000E-01	1.8341000E-03	8.0600000E-03
6.7410000E+02	7.7097000E-03	2.4800000E-01	1.9120000E-03	8.4025000E-03
6.7415000E+02	8.0101000E-03	2.4807000E-01	1.9870000E-03	8.7322000E-03
6.7420000E+02	8.2944000E-03	2.4814000E-01	2.0582000E-03	9.0447000E-03
6.7425000E+02	8.5595000E-03	2.4820000E-01	2.1245000E-03	9.3362000E-03
6.7430000E+02	8.8025000E-03	2.4827000E-01	2.1854000E-03	9.6039000E-03
6.7435000E+02	9.0219000E-03	2.4834000E-01	2.2405000E-03	9.8460000E-03
6.7440000E+02	9.2168000E-03	2.4840000E-01	2.2895000E-03	1.0061000E-02
6.7445000E+02	9.3875000E-03	2.4847000E-01	2.3325000E-03	1.0250000E-02
6.7450000E+02	9.5350000E-03	2.4854000E-01	2.3698000E-03	1.0414000E-02
6.7455000E+02	9.6615000E-03	2.4861000E-01	2.4019000E-03	1.0555000E-02
6.7460000E+02	9.7697000E-03	2.4867000E-01	2.4294000E-03	1.0676000E-02
6.7465000E+02	9.8633000E-03	2.4874000E-01	2.4534000E-03	1.0782000E-02
6.7470000E+02	9.9465000E-03	2.4881000E-01	2.4748000E-03	1.0875000E-02

6.7475000E+02	1.0024000E-02	2.4887000E-01	2.4947000E-03	1.0963000E-02
6.7480000E+02	1.0101000E-02	2.4894000E-01	2.5146000E-03	1.1050000E-02
6.7485000E+02	1.0183000E-02	2.4900000E-01	2.5355000E-03	1.1143000E-02
6.7490000E+02	1.0274000E-02	2.4907000E-01	2.5589000E-03	1.1245000E-02
6.7495000E+02	1.0379000E-02	2.4914000E-01	2.5859000E-03	1.1364000E-02
6.7500000E+02	1.0504000E-02	2.4920000E-01	2.6177000E-03	1.1504000E-02
6.7505000E+02	1.0652000E-02	2.4927000E-01	2.6551000E-03	1.1668000E-02
6.7510000E+02	1.0826000E-02	2.4933000E-01	2.6991000E-03	1.1862000E-02
6.7515000E+02	1.1028000E-02	2.4938000E-01	2.7502000E-03	1.2086000E-02
6.7520000E+02	1.1261000E-02	2.4942000E-01	2.8087000E-03	1.2343000E-02
6.7525000E+02	1.1525000E-02	2.4945000E-01	2.8749000E-03	1.2634000E-02
6.7530000E+02	1.1819000E-02	2.4949000E-01	2.9488000E-03	1.2959000E-02
6.7535000E+02	1.2144000E-02	2.4952000E-01	3.0301000E-03	1.3316000E-02
6.7540000E+02	1.2495000E-02	2.4955000E-01	3.1182000E-03	1.3703000E-02
6.7545000E+02	1.2871000E-02	2.4959000E-01	3.2126000E-03	1.4118000E-02
6.7550000E+02	1.3269000E-02	2.4962000E-01	3.3122000E-03	1.4555000E-02
6.7555000E+02	1.3683000E-02	2.4966000E-01	3.4160000E-03	1.5012000E-02
6.7560000E+02	1.4109000E-02	2.4969000E-01	3.5230000E-03	1.5482000E-02
6.7565000E+02	1.4544000E-02	2.4972000E-01	3.6319000E-03	1.5961000E-02
6.7570000E+02	1.4981000E-02	2.4976000E-01	3.7416000E-03	1.6442000E-02
6.7575000E+02	1.5416000E-02	2.4979000E-01	3.8508000E-03	1.6923000E-02
6.7580000E+02	1.5845000E-02	2.4982000E-01	3.9586000E-03	1.7396000E-02
6.7585000E+02	1.6265000E-02	2.4986000E-01	4.0639000E-03	1.7859000E-02
6.7590000E+02	1.6671000E-02	2.4989000E-01	4.1661000E-03	1.8308000E-02
6.7595000E+02	1.7063000E-02	2.4992000E-01	4.2644000E-03	1.8740000E-02
6.7600000E+02	1.7437000E-02	2.4996000E-01	4.3585000E-03	1.9154000E-02
6.7605000E+02	1.7794000E-02	2.5004000E-01	4.4493000E-03	1.9553000E-02
6.7610000E+02	1.8135000E-02	2.5012000E-01	4.5360000E-03	1.9934000E-02
6.7615000E+02	1.8461000E-02	2.5020000E-01	4.6190000E-03	2.0299000E-02
6.7620000E+02	1.8775000E-02	2.5029000E-01	4.6991000E-03	2.0650000E-02
6.7625000E+02	1.9080000E-02	2.5037000E-01	4.7770000E-03	2.0993000E-02
6.7630000E+02	1.9382000E-02	2.5045000E-01	4.8541000E-03	2.1332000E-02
6.7635000E+02	1.9684000E-02	2.5053000E-01	4.9315000E-03	2.1672000E-02
6.7640000E+02	1.9995000E-02	2.5061000E-01	5.0109000E-03	2.2021000E-02
6.7645000E+02	2.0319000E-02	2.5069000E-01	5.0937000E-03	2.2385000E-02
6.7650000E+02	2.0663000E-02	2.5078000E-01	5.1818000E-03	2.2772000E-02
6.7655000E+02	2.1034000E-02	2.5086000E-01	5.2766000E-03	2.3188000E-02
6.7660000E+02	2.1439000E-02	2.5094000E-01	5.3800000E-03	2.3643000E-02
6.7665000E+02	2.1884000E-02	2.5102000E-01	5.4934000E-03	2.4141000E-02
6.7670000E+02	2.2374000E-02	2.5110000E-01	5.6182000E-03	2.4690000E-02
6.7675000E+02	2.2915000E-02	2.5118000E-01	5.7558000E-03	2.5294000E-02
6.7680000E+02	2.3510000E-02	2.5126000E-01	5.9071000E-03	2.5959000E-02
6.7685000E+02	2.4162000E-02	2.5134000E-01	6.0729000E-03	2.6688000E-02

6.7690000E+02	2.4873000E-02	2.5142000E-01	6.2537000E-03	2.7482000E-02
6.7695000E+02	2.5645000E-02	2.5150000E-01	6.4498000E-03	2.8344000E-02
6.7700000E+02	2.6476000E-02	2.5158000E-01	6.6610000E-03	2.9272000E-02
6.7705000E+02	2.7366000E-02	2.5166000E-01	6.8869000E-03	3.0265000E-02
6.7710000E+02	2.8311000E-02	2.5173000E-01	7.1266000E-03	3.1318000E-02
6.7715000E+02	2.9308000E-02	2.5179000E-01	7.3794000E-03	3.2429000E-02
6.7720000E+02	3.0352000E-02	2.5185000E-01	7.6443000E-03	3.3593000E-02
6.7725000E+02	3.1440000E-02	2.5191000E-01	7.9200000E-03	3.4805000E-02
6.7730000E+02	3.2563000E-02	2.5197000E-01	8.2050000E-03	3.6057000E-02
6.7735000E+02	3.3717000E-02	2.5203000E-01	8.4978000E-03	3.7344000E-02
6.7740000E+02	3.4896000E-02	2.5209000E-01	8.7969000E-03	3.8658000E-02
6.7745000E+02	3.6092000E-02	2.5215000E-01	9.1007000E-03	3.9994000E-02
6.7750000E+02	3.7302000E-02	2.5221000E-01	9.4079000E-03	4.1344000E-02
6.7755000E+02	3.8518000E-02	2.5227000E-01	9.7170000E-03	4.2702000E-02
6.7760000E+02	3.9738000E-02	2.5233000E-01	1.0027000E-02	4.4064000E-02
6.7765000E+02	4.0956000E-02	2.5239000E-01	1.0337000E-02	4.5426000E-02
6.7770000E+02	4.2171000E-02	2.5245000E-01	1.0646000E-02	4.6784000E-02
6.7775000E+02	4.3381000E-02	2.5250000E-01	1.0954000E-02	4.8138000E-02
6.7780000E+02	4.4586000E-02	2.5256000E-01	1.1261000E-02	4.9486000E-02
6.7785000E+02	4.5788000E-02	2.5262000E-01	1.1567000E-02	5.0831000E-02
6.7790000E+02	4.6987000E-02	2.5268000E-01	1.1873000E-02	5.2175000E-02
6.7795000E+02	4.8189000E-02	2.5273000E-01	1.2179000E-02	5.3521000E-02
6.7800000E+02	4.9398000E-02	2.5279000E-01	1.2487000E-02	5.4876000E-02
6.7805000E+02	5.0536000E-02	2.5292000E-01	1.2782000E-02	5.6169000E-02
6.7810000E+02	5.1736000E-02	2.5305000E-01	1.3091000E-02	5.7531000E-02
6.7815000E+02	5.2959000E-02	2.5317000E-01	1.3408000E-02	5.8921000E-02
6.7820000E+02	5.4215000E-02	2.5330000E-01	1.3733000E-02	6.0349000E-02
6.7825000E+02	5.5514000E-02	2.5343000E-01	1.4069000E-02	6.1827000E-02
6.7830000E+02	5.6866000E-02	2.5356000E-01	1.4419000E-02	6.3364000E-02
6.7835000E+02	5.8281000E-02	2.5368000E-01	1.4785000E-02	6.4973000E-02
6.7840000E+02	5.9768000E-02	2.5381000E-01	1.5170000E-02	6.6665000E-02
6.7845000E+02	6.1337000E-02	2.5394000E-01	1.5576000E-02	6.8448000E-02
6.7850000E+02	6.2995000E-02	2.5406000E-01	1.6005000E-02	7.0333000E-02
6.7855000E+02	6.4749000E-02	2.5419000E-01	1.6459000E-02	7.2328000E-02
6.7860000E+02	6.6607000E-02	2.5432000E-01	1.6939000E-02	7.4441000E-02
6.7865000E+02	6.8573000E-02	2.5444000E-01	1.7448000E-02	7.6675000E-02
6.7870000E+02	7.0650000E-02	2.5457000E-01	1.7985000E-02	7.9038000E-02
6.7875000E+02	7.2842000E-02	2.5469000E-01	1.8552000E-02	8.1530000E-02
6.7880000E+02	7.5149000E-02	2.5482000E-01	1.9150000E-02	8.4154000E-02
6.7885000E+02	7.7572000E-02	2.5495000E-01	1.9777000E-02	8.6910000E-02
6.7890000E+02	8.0109000E-02	2.5507000E-01	2.0434000E-02	8.9797000E-02
6.7895000E+02	8.2759000E-02	2.5520000E-01	2.1120000E-02	9.2813000E-02
6.7900000E+02	8.5518000E-02	2.5533000E-01	2.1835000E-02	9.5955000E-02

6.7905000E+02	8.8383000E-02	2.5546000E-01	2.2578000E-02	9.9221000E-02
6.7910000E+02	9.1350000E-02	2.5559000E-01	2.3348000E-02	1.0261000E-01
6.7915000E+02	9.4415000E-02	2.5573000E-01	2.4144000E-02	1.0610000E-01
6.7920000E+02	9.7573000E-02	2.5586000E-01	2.4965000E-02	1.0971000E-01
6.7925000E+02	1.0082000E-01	2.5599000E-01	2.5810000E-02	1.1342000E-01
6.7930000E+02	1.0416000E-01	2.5612000E-01	2.6677000E-02	1.1723000E-01
6.7935000E+02	1.0758000E-01	2.5626000E-01	2.7567000E-02	1.2115000E-01
6.7940000E+02	1.1108000E-01	2.5639000E-01	2.8479000E-02	1.2515000E-01
6.7945000E+02	1.1466000E-01	2.5652000E-01	2.9412000E-02	1.2925000E-01
6.7950000E+02	1.1832000E-01	2.5666000E-01	3.0367000E-02	1.3345000E-01
6.7955000E+02	1.2206000E-01	2.5679000E-01	3.1344000E-02	1.3774000E-01
6.7960000E+02	1.2589000E-01	2.5692000E-01	3.2344000E-02	1.4214000E-01
6.7965000E+02	1.2980000E-01	2.5705000E-01	3.3366000E-02	1.4663000E-01
6.7970000E+02	1.3381000E-01	2.5719000E-01	3.4413000E-02	1.5123000E-01
6.7975000E+02	1.3790000E-01	2.5732000E-01	3.5485000E-02	1.5594000E-01
6.7980000E+02	1.4210000E-01	2.5745000E-01	3.6585000E-02	1.6078000E-01
6.7985000E+02	1.4641000E-01	2.5758000E-01	3.7713000E-02	1.6573000E-01
6.7990000E+02	1.5084000E-01	2.5772000E-01	3.8873000E-02	1.7083000E-01
6.7995000E+02	1.5538000E-01	2.5785000E-01	4.0065000E-02	1.7607000E-01
6.8000000E+02	1.6005000E-01	2.5798000E-01	4.1291000E-02	1.8145000E-01
6.8005000E+02	1.6486000E-01	2.5801000E-01	4.2536000E-02	1.8693000E-01
6.8010000E+02	1.6981000E-01	2.5804000E-01	4.3819000E-02	1.9256000E-01
6.8015000E+02	1.7491000E-01	2.5807000E-01	4.5140000E-02	1.9837000E-01
6.8020000E+02	1.8017000E-01	2.5810000E-01	4.6501000E-02	2.0435000E-01
6.8025000E+02	1.8558000E-01	2.5813000E-01	4.7902000E-02	2.1051000E-01
6.8030000E+02	1.9115000E-01	2.5816000E-01	4.9346000E-02	2.1686000E-01
6.8035000E+02	1.9688000E-01	2.5819000E-01	5.0832000E-02	2.2339000E-01
6.8040000E+02	2.0278000E-01	2.5822000E-01	5.2361000E-02	2.3010000E-01
6.8045000E+02	2.0884000E-01	2.5824000E-01	5.3932000E-02	2.3701000E-01
6.8050000E+02	2.1506000E-01	2.5827000E-01	5.5545000E-02	2.4410000E-01
6.8055000E+02	2.2144000E-01	2.5830000E-01	5.7200000E-02	2.5137000E-01
6.8060000E+02	2.2798000E-01	2.5833000E-01	5.8894000E-02	2.5881000E-01
6.8065000E+02	2.3467000E-01	2.5836000E-01	6.0628000E-02	2.6643000E-01
6.8070000E+02	2.4149000E-01	2.5839000E-01	6.2398000E-02	2.7421000E-01
6.8075000E+02	2.4846000E-01	2.5842000E-01	6.4205000E-02	2.8215000E-01
6.8080000E+02	2.5555000E-01	2.5844000E-01	6.6045000E-02	2.9024000E-01
6.8085000E+02	2.6276000E-01	2.5847000E-01	6.7916000E-02	2.9846000E-01
6.8090000E+02	2.7009000E-01	2.5850000E-01	6.9817000E-02	3.0682000E-01
6.8095000E+02	2.7751000E-01	2.5853000E-01	7.1746000E-02	3.1529000E-01
6.8100000E+02	2.8504000E-01	2.5856000E-01	7.3701000E-02	3.2388000E-01
6.8105000E+02	2.9265000E-01	2.5860000E-01	7.5679000E-02	3.3258000E-01
6.8110000E+02	3.0034000E-01	2.5864000E-01	7.7679000E-02	3.4136000E-01
6.8115000E+02	3.0810000E-01	2.5867000E-01	7.9697000E-02	3.5023000E-01

6.8120000E+02	3.1593000E-01	2.5871000E-01	8.1733000E-02	3.5918000E-01
6.8125000E+02	3.2381000E-01	2.5874000E-01	8.3784000E-02	3.6820000E-01
6.8130000E+02	3.3175000E-01	2.5878000E-01	8.5850000E-02	3.7727000E-01
6.8135000E+02	3.3974000E-01	2.5881000E-01	8.7928000E-02	3.8641000E-01
6.8140000E+02	3.4776000E-01	2.5885000E-01	9.0018000E-02	3.9559000E-01
6.8145000E+02	3.5583000E-01	2.5888000E-01	9.2119000E-02	4.0482000E-01
6.8150000E+02	3.6393000E-01	2.5892000E-01	9.4229000E-02	4.1410000E-01
6.8155000E+02	3.7207000E-01	2.5896000E-01	9.6349000E-02	4.2341000E-01
6.8160000E+02	3.8023000E-01	2.5899000E-01	9.8477000E-02	4.3276000E-01
6.8165000E+02	3.8842000E-01	2.5902000E-01	1.0061000E-01	4.4214000E-01
6.8170000E+02	3.9664000E-01	2.5906000E-01	1.0275000E-01	4.5155000E-01
6.8175000E+02	4.0487000E-01	2.5909000E-01	1.0490000E-01	4.6099000E-01
6.8180000E+02	4.1313000E-01	2.5913000E-01	1.0705000E-01	4.7045000E-01
6.8185000E+02	4.2139000E-01	2.5916000E-01	1.0921000E-01	4.7993000E-01
6.8190000E+02	4.2967000E-01	2.5920000E-01	1.1137000E-01	4.8942000E-01
6.8195000E+02	4.3794000E-01	2.5923000E-01	1.1353000E-01	4.9891000E-01
6.8200000E+02	4.4622000E-01	2.5927000E-01	1.1569000E-01	5.0841000E-01
6.8205000E+02	4.5449000E-01	2.5939000E-01	1.1789000E-01	5.1808000E-01
6.8210000E+02	4.6275000E-01	2.5951000E-01	1.2009000E-01	5.2774000E-01
6.8215000E+02	4.7098000E-01	2.5964000E-01	1.2228000E-01	5.3738000E-01
6.8220000E+02	4.7918000E-01	2.5976000E-01	1.2447000E-01	5.4700000E-01
6.8225000E+02	4.8733000E-01	2.5989000E-01	1.2665000E-01	5.5658000E-01
6.8230000E+02	4.9544000E-01	2.6001000E-01	1.2882000E-01	5.6611000E-01
6.8235000E+02	5.0348000E-01	2.6014000E-01	1.3097000E-01	5.7557000E-01
6.8240000E+02	5.1145000E-01	2.6026000E-01	1.3311000E-01	5.8496000E-01
6.8245000E+02	5.1934000E-01	2.6038000E-01	1.3523000E-01	5.9427000E-01
6.8250000E+02	5.2714000E-01	2.6051000E-01	1.3732000E-01	6.0347000E-01
6.8255000E+02	5.3482000E-01	2.6063000E-01	1.3939000E-01	6.1256000E-01
6.8260000E+02	5.4239000E-01	2.6075000E-01	1.4143000E-01	6.2152000E-01
6.8265000E+02	5.4982000E-01	2.6088000E-01	1.4344000E-01	6.3034000E-01
6.8270000E+02	5.5712000E-01	2.6100000E-01	1.4541000E-01	6.3901000E-01
6.8275000E+02	5.6427000E-01	2.6113000E-01	1.4734000E-01	6.4752000E-01
6.8280000E+02	5.7126000E-01	2.6125000E-01	1.4924000E-01	6.5585000E-01
6.8285000E+02	5.7808000E-01	2.6137000E-01	1.5109000E-01	6.6399000E-01
6.8290000E+02	5.8472000E-01	2.6150000E-01	1.5290000E-01	6.7195000E-01
6.8295000E+02	5.9119000E-01	2.6162000E-01	1.5467000E-01	6.7970000E-01
6.8300000E+02	5.9746000E-01	2.6175000E-01	1.5638000E-01	6.8724000E-01
6.8305000E+02	6.0354000E-01	2.6187000E-01	1.5805000E-01	6.9457000E-01
6.8310000E+02	6.0943000E-01	2.6200000E-01	1.5967000E-01	7.0168000E-01
6.8315000E+02	6.1511000E-01	2.6213000E-01	1.6124000E-01	7.0857000E-01
6.8320000E+02	6.2059000E-01	2.6225000E-01	1.6275000E-01	7.1523000E-01
6.8325000E+02	6.2587000E-01	2.6238000E-01	1.6422000E-01	7.2166000E-01
6.8330000E+02	6.3095000E-01	2.6251000E-01	1.6563000E-01	7.2787000E-01

6.8335000E+02	6.3582000E-01	2.6263000E-01	1.6699000E-01	7.3384000E-01
6.8340000E+02	6.4049000E-01	2.6276000E-01	1.6829000E-01	7.3958000E-01
6.8345000E+02	6.4496000E-01	2.6289000E-01	1.6955000E-01	7.4510000E-01
6.8350000E+02	6.4922000E-01	2.6301000E-01	1.7075000E-01	7.5039000E-01
6.8355000E+02	6.5329000E-01	2.6314000E-01	1.7191000E-01	7.5545000E-01
6.8360000E+02	6.5716000E-01	2.6326000E-01	1.7301000E-01	7.6029000E-01
6.8365000E+02	6.6084000E-01	2.6339000E-01	1.7406000E-01	7.6492000E-01
6.8370000E+02	6.6433000E-01	2.6352000E-01	1.7506000E-01	7.6932000E-01
6.8375000E+02	6.6763000E-01	2.6364000E-01	1.7602000E-01	7.7351000E-01
6.8380000E+02	6.7075000E-01	2.6377000E-01	1.7692000E-01	7.7750000E-01
6.8385000E+02	6.7368000E-01	2.6389000E-01	1.7778000E-01	7.8127000E-01
6.8390000E+02	6.7643000E-01	2.6402000E-01	1.7859000E-01	7.8483000E-01
6.8395000E+02	6.7900000E-01	2.6415000E-01	1.7936000E-01	7.8819000E-01
6.8400000E+02	6.8140000E-01	2.6427000E-01	1.8008000E-01	7.9136000E-01
6.8405000E+02	6.8363000E-01	2.6430000E-01	1.8069000E-01	7.9404000E-01
6.8410000E+02	6.8569000E-01	2.6434000E-01	1.8125000E-01	7.9652000E-01
6.8415000E+02	6.8758000E-01	2.6437000E-01	1.8177000E-01	7.9881000E-01
6.8420000E+02	6.8930000E-01	2.6440000E-01	1.8225000E-01	8.0091000E-01
6.8425000E+02	6.9087000E-01	2.6443000E-01	1.8269000E-01	8.0282000E-01
6.8430000E+02	6.9228000E-01	2.6446000E-01	1.8308000E-01	8.0456000E-01
6.8435000E+02	6.9353000E-01	2.6449000E-01	1.8343000E-01	8.0611000E-01
6.8440000E+02	6.9464000E-01	2.6452000E-01	1.8375000E-01	8.0749000E-01
6.8445000E+02	6.9560000E-01	2.6455000E-01	1.8402000E-01	8.0871000E-01
6.8450000E+02	6.9642000E-01	2.6459000E-01	1.8426000E-01	8.0975000E-01
6.8455000E+02	6.9711000E-01	2.6462000E-01	1.8447000E-01	8.1065000E-01
6.8460000E+02	6.9766000E-01	2.6465000E-01	1.8463000E-01	8.1139000E-01
6.8465000E+02	6.9809000E-01	2.6468000E-01	1.8477000E-01	8.1198000E-01
6.8470000E+02	6.9840000E-01	2.6471000E-01	1.8487000E-01	8.1244000E-01
6.8475000E+02	6.9860000E-01	2.6474000E-01	1.8495000E-01	8.1277000E-01
6.8480000E+02	6.9869000E-01	2.6477000E-01	1.8499000E-01	8.1297000E-01
6.8485000E+02	6.9868000E-01	2.6481000E-01	1.8501000E-01	8.1306000E-01
6.8490000E+02	6.9858000E-01	2.6484000E-01	1.8501000E-01	8.1304000E-01
6.8495000E+02	6.9839000E-01	2.6487000E-01	1.8498000E-01	8.1292000E-01
6.8500000E+02	6.9812000E-01	2.6490000E-01	1.8493000E-01	8.1270000E-01
6.8505000E+02	6.9778000E-01	2.6493000E-01	1.8486000E-01	8.1240000E-01
6.8510000E+02	6.9737000E-01	2.6496000E-01	1.8478000E-01	8.1201000E-01
6.8515000E+02	6.9691000E-01	2.6499000E-01	1.8467000E-01	8.1156000E-01
6.8520000E+02	6.9639000E-01	2.6502000E-01	1.8456000E-01	8.1105000E-01
6.8525000E+02	6.9582000E-01	2.6505000E-01	1.8443000E-01	8.1048000E-01
6.8530000E+02	6.9521000E-01	2.6508000E-01	1.8429000E-01	8.0986000E-01
6.8535000E+02	6.9457000E-01	2.6511000E-01	1.8414000E-01	8.0920000E-01
6.8540000E+02	6.9390000E-01	2.6514000E-01	1.8398000E-01	8.0851000E-01
6.8545000E+02	6.9320000E-01	2.6517000E-01	1.8381000E-01	8.0778000E-01

6.8550000E+02	6.9248000E-01	2.6520000E-01	1.8364000E-01	8.0704000E-01
6.8555000E+02	6.9175000E-01	2.6523000E-01	1.8347000E-01	8.0627000E-01
6.8560000E+02	6.9101000E-01	2.6526000E-01	1.8329000E-01	8.0550000E-01
6.8565000E+02	6.9026000E-01	2.6528000E-01	1.8312000E-01	8.0471000E-01
6.8570000E+02	6.8951000E-01	2.6531000E-01	1.8294000E-01	8.0392000E-01
6.8575000E+02	6.8875000E-01	2.6534000E-01	1.8276000E-01	8.0313000E-01
6.8580000E+02	6.8800000E-01	2.6537000E-01	1.8258000E-01	8.0234000E-01
6.8585000E+02	6.8726000E-01	2.6540000E-01	1.8240000E-01	8.0156000E-01
6.8590000E+02	6.8652000E-01	2.6543000E-01	1.8222000E-01	8.0079000E-01
6.8595000E+02	6.8580000E-01	2.6546000E-01	1.8205000E-01	8.0003000E-01
6.8600000E+02	6.8508000E-01	2.6549000E-01	1.8188000E-01	7.9929000E-01
6.8605000E+02	6.8439000E-01	2.6568000E-01	1.8182000E-01	7.9904000E-01
6.8610000E+02	6.8370000E-01	2.6586000E-01	1.8177000E-01	7.9881000E-01
6.8615000E+02	6.8304000E-01	2.6605000E-01	1.8173000E-01	7.9861000E-01
6.8620000E+02	6.8240000E-01	2.6624000E-01	1.8168000E-01	7.9842000E-01
6.8625000E+02	6.8179000E-01	2.6643000E-01	1.8165000E-01	7.9827000E-01
6.8630000E+02	6.8120000E-01	2.6662000E-01	1.8162000E-01	7.9814000E-01
6.8635000E+02	6.8063000E-01	2.6681000E-01	1.8160000E-01	7.9804000E-01
6.8640000E+02	6.8009000E-01	2.6700000E-01	1.8158000E-01	7.9797000E-01
6.8645000E+02	6.7958000E-01	2.6718000E-01	1.8157000E-01	7.9793000E-01
6.8650000E+02	6.7910000E-01	2.6737000E-01	1.8157000E-01	7.9793000E-01
6.8655000E+02	6.7865000E-01	2.6756000E-01	1.8158000E-01	7.9797000E-01
6.8660000E+02	6.7823000E-01	2.6775000E-01	1.8160000E-01	7.9804000E-01
6.8665000E+02	6.7784000E-01	2.6794000E-01	1.8162000E-01	7.9814000E-01
6.8670000E+02	6.7749000E-01	2.6813000E-01	1.8165000E-01	7.9829000E-01
6.8675000E+02	6.7717000E-01	2.6832000E-01	1.8170000E-01	7.9849000E-01
6.8680000E+02	6.7689000E-01	2.6852000E-01	1.8176000E-01	7.9874000E-01
6.8685000E+02	6.7664000E-01	2.6871000E-01	1.8182000E-01	7.9902000E-01
6.8690000E+02	6.7643000E-01	2.6891000E-01	1.8190000E-01	7.9935000E-01
6.8695000E+02	6.7625000E-01	2.6910000E-01	1.8198000E-01	7.9972000E-01
6.8700000E+02	6.7611000E-01	2.6930000E-01	1.8207000E-01	8.0014000E-01
6.8705000E+02	6.7601000E-01	2.6949000E-01	1.8218000E-01	8.0060000E-01
6.8710000E+02	6.7595000E-01	2.6969000E-01	1.8229000E-01	8.0111000E-01
6.8715000E+02	6.7593000E-01	2.6988000E-01	1.8242000E-01	8.0166000E-01
6.8720000E+02	6.7595000E-01	2.7008000E-01	1.8256000E-01	8.0227000E-01
6.8725000E+02	6.7602000E-01	2.7027000E-01	1.8271000E-01	8.0292000E-01
6.8730000E+02	6.7612000E-01	2.7047000E-01	1.8287000E-01	8.0362000E-01
6.8735000E+02	6.7627000E-01	2.7066000E-01	1.8304000E-01	8.0438000E-01
6.8740000E+02	6.7647000E-01	2.7086000E-01	1.8323000E-01	8.0520000E-01
6.8745000E+02	6.7672000E-01	2.7105000E-01	1.8342000E-01	8.0607000E-01
6.8750000E+02	6.7701000E-01	2.7125000E-01	1.8364000E-01	8.0701000E-01
6.8755000E+02	6.7736000E-01	2.7144000E-01	1.8386000E-01	8.0800000E-01
6.8760000E+02	6.7776000E-01	2.7164000E-01	1.8410000E-01	8.0906000E-01

6.8765000E+02	6.7822000E-01	2.7183000E-01	1.8436000E-01	8.1018000E-01
6.8770000E+02	6.7873000E-01	2.7203000E-01	1.8463000E-01	8.1137000E-01
6.8775000E+02	6.7929000E-01	2.7222000E-01	1.8492000E-01	8.1263000E-01
6.8780000E+02	6.7992000E-01	2.7242000E-01	1.8522000E-01	8.1396000E-01
6.8785000E+02	6.8060000E-01	2.7261000E-01	1.8554000E-01	8.1536000E-01
6.8790000E+02	6.8134000E-01	2.7281000E-01	1.8587000E-01	8.1684000E-01
6.8795000E+02	6.8214000E-01	2.7300000E-01	1.8623000E-01	8.1838000E-01
6.8800000E+02	6.8300000E-01	2.7320000E-01	1.8659000E-01	8.1999000E-01
6.8805000E+02	6.8391000E-01	2.7334000E-01	1.8694000E-01	8.2153000E-01
6.8810000E+02	6.8488000E-01	2.7349000E-01	1.8731000E-01	8.2313000E-01
6.8815000E+02	6.8591000E-01	2.7363000E-01	1.8768000E-01	8.2479000E-01
6.8820000E+02	6.8698000E-01	2.7377000E-01	1.8808000E-01	8.2652000E-01
6.8825000E+02	6.8810000E-01	2.7392000E-01	1.8849000E-01	8.2831000E-01
6.8830000E+02	6.8927000E-01	2.7406000E-01	1.8891000E-01	8.3016000E-01
6.8835000E+02	6.9048000E-01	2.7421000E-01	1.8934000E-01	8.3205000E-01
6.8840000E+02	6.9173000E-01	2.7435000E-01	1.8978000E-01	8.3400000E-01
6.8845000E+02	6.9302000E-01	2.7450000E-01	1.9023000E-01	8.3599000E-01
6.8850000E+02	6.9433000E-01	2.7464000E-01	1.9069000E-01	8.3801000E-01
6.8855000E+02	6.9567000E-01	2.7479000E-01	1.9116000E-01	8.4007000E-01
6.8860000E+02	6.9703000E-01	2.7493000E-01	1.9164000E-01	8.4216000E-01
6.8865000E+02	6.9841000E-01	2.7508000E-01	1.9212000E-01	8.4427000E-01
6.8870000E+02	6.9980000E-01	2.7523000E-01	1.9260000E-01	8.4641000E-01
6.8875000E+02	7.0121000E-01	2.7537000E-01	1.9309000E-01	8.4856000E-01
6.8880000E+02	7.0262000E-01	2.7552000E-01	1.9359000E-01	8.5072000E-01
6.8885000E+02	7.0404000E-01	2.7567000E-01	1.9408000E-01	8.5290000E-01
6.8890000E+02	7.0546000E-01	2.7581000E-01	1.9458000E-01	8.5508000E-01
6.8895000E+02	7.0688000E-01	2.7596000E-01	1.9507000E-01	8.5726000E-01
6.8900000E+02	7.0831000E-01	2.7611000E-01	1.9557000E-01	8.5944000E-01
6.8905000E+02	7.0973000E-01	2.7626000E-01	1.9607000E-01	8.6163000E-01
6.8910000E+02	7.1116000E-01	2.7640000E-01	1.9657000E-01	8.6383000E-01
6.8915000E+02	7.1259000E-01	2.7655000E-01	1.9707000E-01	8.6602000E-01
6.8920000E+02	7.1403000E-01	2.7670000E-01	1.9757000E-01	8.6823000E-01
6.8925000E+02	7.1547000E-01	2.7684000E-01	1.9807000E-01	8.7044000E-01
6.8930000E+02	7.1692000E-01	2.7699000E-01	1.9858000E-01	8.7267000E-01
6.8935000E+02	7.1838000E-01	2.7714000E-01	1.9909000E-01	8.7491000E-01
6.8940000E+02	7.1985000E-01	2.7728000E-01	1.9960000E-01	8.7717000E-01
6.8945000E+02	7.2134000E-01	2.7743000E-01	2.0012000E-01	8.7945000E-01
6.8950000E+02	7.2285000E-01	2.7758000E-01	2.0065000E-01	8.8176000E-01
6.8955000E+02	7.2439000E-01	2.7772000E-01	2.0118000E-01	8.8410000E-01
6.8960000E+02	7.2595000E-01	2.7787000E-01	2.0172000E-01	8.8647000E-01
6.8965000E+02	7.2753000E-01	2.7802000E-01	2.0227000E-01	8.8887000E-01
6.8970000E+02	7.2915000E-01	2.7816000E-01	2.0282000E-01	8.9132000E-01
6.8975000E+02	7.3080000E-01	2.7831000E-01	2.0339000E-01	8.9380000E-01

6.8980000E+02	7.3247000E-01	2.7846000E-01	2.0396000E-01	8.9632000E-01
6.8985000E+02	7.3418000E-01	2.7860000E-01	2.0455000E-01	8.9889000E-01
6.8990000E+02	7.3593000E-01	2.7875000E-01	2.0514000E-01	9.0149000E-01
6.8995000E+02	7.3769000E-01	2.7890000E-01	2.0574000E-01	9.0414000E-01
6.9000000E+02	7.3949000E-01	2.7904000E-01	2.0635000E-01	9.0681000E-01
6.9005000E+02	7.4131000E-01	2.7915000E-01	2.0694000E-01	9.0940000E-01
6.9010000E+02	7.4316000E-01	2.7926000E-01	2.0753000E-01	9.1202000E-01
6.9015000E+02	7.4502000E-01	2.7937000E-01	2.0814000E-01	9.1466000E-01
6.9020000E+02	7.4689000E-01	2.7948000E-01	2.0874000E-01	9.1732000E-01
6.9025000E+02	7.4878000E-01	2.7959000E-01	2.0935000E-01	9.2000000E-01
6.9030000E+02	7.5066000E-01	2.7970000E-01	2.0996000E-01	9.2268000E-01
6.9035000E+02	7.5255000E-01	2.7981000E-01	2.1057000E-01	9.2536000E-01
6.9040000E+02	7.5443000E-01	2.7992000E-01	2.1118000E-01	9.2803000E-01
6.9045000E+02	7.5630000E-01	2.8003000E-01	2.1178000E-01	9.3069000E-01
6.9050000E+02	7.5815000E-01	2.8013000E-01	2.1238000E-01	9.3334000E-01
6.9055000E+02	7.5999000E-01	2.8024000E-01	2.1298000E-01	9.3596000E-01
6.9060000E+02	7.6180000E-01	2.8036000E-01	2.1358000E-01	9.3858000E-01
6.9065000E+02	7.6358000E-01	2.8048000E-01	2.1417000E-01	9.4117000E-01
6.9070000E+02	7.6533000E-01	2.8060000E-01	2.1475000E-01	9.4373000E-01
6.9075000E+02	7.6705000E-01	2.8071000E-01	2.1532000E-01	9.4625000E-01
6.9080000E+02	7.6873000E-01	2.8083000E-01	2.1589000E-01	9.4872000E-01
6.9085000E+02	7.7038000E-01	2.8095000E-01	2.1644000E-01	9.5116000E-01
6.9090000E+02	7.7199000E-01	2.8107000E-01	2.1698000E-01	9.5355000E-01
6.9095000E+02	7.7356000E-01	2.8119000E-01	2.1752000E-01	9.5589000E-01
6.9100000E+02	7.7510000E-01	2.8130000E-01	2.1804000E-01	9.5819000E-01
6.9105000E+02	7.7660000E-01	2.8142000E-01	2.1855000E-01	9.6043000E-01
6.9110000E+02	7.7806000E-01	2.8154000E-01	2.1905000E-01	9.6264000E-01
6.9115000E+02	7.7948000E-01	2.8165000E-01	2.1954000E-01	9.6480000E-01
6.9120000E+02	7.8087000E-01	2.8177000E-01	2.2003000E-01	9.6692000E-01
6.9125000E+02	7.8223000E-01	2.8189000E-01	2.2050000E-01	9.6900000E-01
6.9130000E+02	7.8355000E-01	2.8200000E-01	2.2096000E-01	9.7103000E-01
6.9135000E+02	7.8483000E-01	2.8212000E-01	2.2142000E-01	9.7303000E-01
6.9140000E+02	7.8609000E-01	2.8224000E-01	2.2186000E-01	9.7498000E-01
6.9145000E+02	7.8730000E-01	2.8235000E-01	2.2230000E-01	9.7690000E-01
6.9150000E+02	7.8849000E-01	2.8247000E-01	2.2272000E-01	9.7877000E-01
6.9155000E+02	7.8963000E-01	2.8258000E-01	2.2314000E-01	9.8060000E-01
6.9160000E+02	7.9074000E-01	2.8270000E-01	2.2354000E-01	9.8237000E-01
6.9165000E+02	7.9180000E-01	2.8282000E-01	2.2394000E-01	9.8410000E-01
6.9170000E+02	7.9282000E-01	2.8293000E-01	2.2432000E-01	9.8577000E-01
6.9175000E+02	7.9379000E-01	2.8305000E-01	2.2468000E-01	9.8738000E-01
6.9180000E+02	7.9470000E-01	2.8317000E-01	2.2503000E-01	9.8892000E-01
6.9185000E+02	7.9555000E-01	2.8328000E-01	2.2537000E-01	9.9039000E-01
6.9190000E+02	7.9634000E-01	2.8340000E-01	2.2568000E-01	9.9177000E-01

6.9195000E+02	7.9705000E-01	2.8352000E-01	2.2598000E-01	9.9307000E-01
6.9200000E+02	7.9769000E-01	2.8363000E-01	2.2625000E-01	9.9427000E-01
6.9205000E+02	7.9824000E-01	2.8377000E-01	2.2651000E-01	9.9543000E-01
6.9210000E+02	7.9870000E-01	2.8390000E-01	2.2675000E-01	9.9647000E-01
6.9215000E+02	7.9906000E-01	2.8404000E-01	2.2696000E-01	9.9740000E-01
6.9220000E+02	7.9932000E-01	2.8417000E-01	2.2714000E-01	9.9819000E-01
6.9225000E+02	7.9947000E-01	2.8430000E-01	2.2729000E-01	9.9885000E-01
6.9230000E+02	7.9950000E-01	2.8444000E-01	2.2741000E-01	9.9937000E-01
6.9235000E+02	7.9942000E-01	2.8457000E-01	2.2749000E-01	9.9973000E-01
6.9240000E+02	7.9921000E-01	2.8471000E-01	2.2754000E-01	9.9995000E-01
6.9245000E+02	7.9888000E-01	2.8484000E-01	2.2755000E-01	1.0000000E+00
6.9250000E+02	7.9842000E-01	2.8498000E-01	2.2753000E-01	9.9990000E-01
6.9255000E+02	7.9782000E-01	2.8513000E-01	2.2748000E-01	9.9968000E-01
6.9260000E+02	7.9709000E-01	2.8528000E-01	2.2739000E-01	9.9928000E-01
6.9265000E+02	7.9623000E-01	2.8543000E-01	2.2726000E-01	9.9872000E-01
6.9270000E+02	7.9523000E-01	2.8557000E-01	2.2710000E-01	9.9799000E-01
6.9275000E+02	7.9409000E-01	2.8572000E-01	2.2689000E-01	9.9708000E-01
6.9280000E+02	7.9282000E-01	2.8587000E-01	2.2664000E-01	9.9601000E-01
6.9285000E+02	7.9142000E-01	2.8602000E-01	2.2636000E-01	9.9476000E-01
6.9290000E+02	7.8988000E-01	2.8617000E-01	2.2604000E-01	9.9335000E-01
6.9295000E+02	7.8821000E-01	2.8632000E-01	2.2568000E-01	9.9176000E-01
6.9300000E+02	7.8641000E-01	2.8647000E-01	2.2528000E-01	9.9001000E-01
6.9305000E+02	7.8448000E-01	2.8661000E-01	2.2484000E-01	9.8809000E-01
6.9310000E+02	7.8242000E-01	2.8676000E-01	2.2437000E-01	9.8601000E-01
6.9315000E+02	7.8024000E-01	2.8691000E-01	2.2386000E-01	9.8376000E-01
6.9320000E+02	7.7792000E-01	2.8706000E-01	2.2331000E-01	9.8135000E-01
6.9325000E+02	7.7548000E-01	2.8721000E-01	2.2272000E-01	9.7877000E-01
6.9330000E+02	7.7291000E-01	2.8735000E-01	2.2210000E-01	9.7603000E-01
6.9335000E+02	7.7021000E-01	2.8750000E-01	2.2144000E-01	9.7312000E-01
6.9340000E+02	7.6738000E-01	2.8765000E-01	2.2074000E-01	9.7005000E-01
6.9345000E+02	7.6443000E-01	2.8780000E-01	2.2000000E-01	9.6681000E-01
6.9350000E+02	7.6134000E-01	2.8795000E-01	2.1923000E-01	9.6340000E-01
6.9355000E+02	7.5811000E-01	2.8810000E-01	2.1841000E-01	9.5981000E-01
6.9360000E+02	7.5476000E-01	2.8824000E-01	2.1755000E-01	9.5605000E-01
6.9365000E+02	7.5126000E-01	2.8839000E-01	2.1666000E-01	9.5212000E-01
6.9370000E+02	7.4763000E-01	2.8854000E-01	2.1572000E-01	9.4800000E-01
6.9375000E+02	7.4385000E-01	2.8869000E-01	2.1474000E-01	9.4370000E-01
6.9380000E+02	7.3994000E-01	2.8884000E-01	2.1372000E-01	9.3921000E-01
6.9385000E+02	7.3588000E-01	2.8898000E-01	2.1266000E-01	9.3454000E-01
6.9390000E+02	7.3167000E-01	2.8913000E-01	2.1155000E-01	9.2967000E-01
6.9395000E+02	7.2733000E-01	2.8928000E-01	2.1040000E-01	9.2462000E-01
6.9400000E+02	7.2283000E-01	2.8943000E-01	2.0921000E-01	9.1938000E-01
6.9405000E+02	7.1819000E-01	2.8955000E-01	2.0796000E-01	9.1387000E-01

6.9410000E+02	7.1341000E-01	2.8968000E-01	2.0666000E-01	9.0818000E-01
6.9415000E+02	7.0849000E-01	2.8981000E-01	2.0532000E-01	9.0231000E-01
6.9420000E+02	7.0343000E-01	2.8993000E-01	2.0395000E-01	8.9625000E-01
6.9425000E+02	6.9823000E-01	2.9006000E-01	2.0253000E-01	8.9002000E-01
6.9430000E+02	6.9291000E-01	2.9018000E-01	2.0107000E-01	8.8361000E-01
6.9435000E+02	6.8745000E-01	2.9031000E-01	1.9957000E-01	8.7703000E-01
6.9440000E+02	6.8187000E-01	2.9043000E-01	1.9804000E-01	8.7029000E-01
6.9445000E+02	6.7618000E-01	2.9056000E-01	1.9647000E-01	8.6340000E-01
6.9450000E+02	6.7037000E-01	2.9069000E-01	1.9487000E-01	8.5638000E-01
6.9455000E+02	6.6445000E-01	2.9083000E-01	1.9324000E-01	8.4921000E-01
6.9460000E+02	6.5844000E-01	2.9096000E-01	1.9158000E-01	8.4191000E-01
6.9465000E+02	6.5233000E-01	2.9109000E-01	1.8989000E-01	8.3447000E-01
6.9470000E+02	6.4613000E-01	2.9122000E-01	1.8817000E-01	8.2692000E-01
6.9475000E+02	6.3985000E-01	2.9136000E-01	1.8642000E-01	8.1926000E-01
6.9480000E+02	6.3350000E-01	2.9149000E-01	1.8466000E-01	8.1148000E-01
6.9485000E+02	6.2707000E-01	2.9162000E-01	1.8286000E-01	8.0361000E-01
6.9490000E+02	6.2057000E-01	2.9175000E-01	1.8105000E-01	7.9565000E-01
6.9495000E+02	6.1401000E-01	2.9188000E-01	1.7922000E-01	7.8759000E-01
6.9500000E+02	6.0739000E-01	2.9202000E-01	1.7737000E-01	7.7945000E-01
6.9505000E+02	6.0071000E-01	2.9215000E-01	1.7550000E-01	7.7124000E-01
6.9510000E+02	5.9399000E-01	2.9228000E-01	1.7361000E-01	7.6294000E-01
6.9515000E+02	5.8721000E-01	2.9241000E-01	1.7171000E-01	7.5458000E-01
6.9520000E+02	5.8039000E-01	2.9255000E-01	1.6979000E-01	7.4615000E-01
6.9525000E+02	5.7352000E-01	2.9268000E-01	1.6786000E-01	7.3766000E-01
6.9530000E+02	5.6661000E-01	2.9281000E-01	1.6591000E-01	7.2910000E-01
6.9535000E+02	5.5966000E-01	2.9294000E-01	1.6395000E-01	7.2048000E-01
6.9540000E+02	5.5267000E-01	2.9308000E-01	1.6197000E-01	7.1181000E-01
6.9545000E+02	5.4564000E-01	2.9321000E-01	1.5999000E-01	7.0308000E-01
6.9550000E+02	5.3858000E-01	2.9334000E-01	1.5799000E-01	6.9429000E-01
6.9555000E+02	5.3149000E-01	2.9347000E-01	1.5598000E-01	6.8546000E-01
6.9560000E+02	5.2437000E-01	2.9361000E-01	1.5396000E-01	6.7658000E-01
6.9565000E+02	5.1721000E-01	2.9374000E-01	1.5193000E-01	6.6765000E-01
6.9570000E+02	5.1004000E-01	2.9387000E-01	1.4989000E-01	6.5868000E-01
6.9575000E+02	5.0284000E-01	2.9401000E-01	1.4784000E-01	6.4968000E-01
6.9580000E+02	4.9562000E-01	2.9414000E-01	1.4578000E-01	6.4065000E-01
6.9585000E+02	4.8840000E-01	2.9427000E-01	1.4372000E-01	6.3159000E-01
6.9590000E+02	4.8116000E-01	2.9440000E-01	1.4166000E-01	6.2251000E-01
6.9595000E+02	4.7392000E-01	2.9454000E-01	1.3959000E-01	6.1343000E-01
6.9600000E+02	4.6669000E-01	2.9467000E-01	1.3752000E-01	6.0433000E-01
6.9605000E+02	4.5946000E-01	2.9472000E-01	1.3541000E-01	5.9508000E-01
6.9610000E+02	4.5225000E-01	2.9477000E-01	1.3331000E-01	5.8584000E-01
6.9615000E+02	4.4506000E-01	2.9482000E-01	1.3121000E-01	5.7663000E-01
6.9620000E+02	4.3790000E-01	2.9487000E-01	1.2912000E-01	5.6744000E-01

6.9625000E+02	4.3077000E-01	2.9492000E-01	1.2704000E-01	5.5830000E-01
6.9630000E+02	4.2369000E-01	2.9497000E-01	1.2498000E-01	5.4921000E-01
6.9635000E+02	4.1665000E-01	2.9502000E-01	1.2292000E-01	5.4018000E-01
6.9640000E+02	4.0966000E-01	2.9508000E-01	1.2088000E-01	5.3123000E-01
6.9645000E+02	4.0273000E-01	2.9514000E-01	1.1886000E-01	5.2234000E-01
6.9650000E+02	3.9586000E-01	2.9520000E-01	1.1686000E-01	5.1353000E-01
6.9655000E+02	3.8906000E-01	2.9525000E-01	1.1487000E-01	5.0481000E-01
6.9660000E+02	3.8234000E-01	2.9531000E-01	1.1291000E-01	4.9618000E-01
6.9665000E+02	3.7568000E-01	2.9537000E-01	1.1096000E-01	4.8763000E-01
6.9670000E+02	3.6910000E-01	2.9542000E-01	1.0904000E-01	4.7919000E-01
6.9675000E+02	3.6260000E-01	2.9548000E-01	1.0714000E-01	4.7084000E-01
6.9680000E+02	3.5618000E-01	2.9554000E-01	1.0526000E-01	4.6259000E-01
6.9685000E+02	3.4983000E-01	2.9559000E-01	1.0341000E-01	4.5444000E-01
6.9690000E+02	3.4357000E-01	2.9565000E-01	1.0158000E-01	4.4638000E-01
6.9695000E+02	3.3738000E-01	2.9571000E-01	9.9766000E-02	4.3843000E-01
6.9700000E+02	3.3127000E-01	2.9577000E-01	9.7978000E-02	4.3057000E-01
6.9705000E+02	3.2523000E-01	2.9582000E-01	9.6211000E-02	4.2281000E-01
6.9710000E+02	3.1927000E-01	2.9588000E-01	9.4466000E-02	4.1514000E-01
6.9715000E+02	3.1338000E-01	2.9594000E-01	9.2740000E-02	4.0755000E-01
6.9720000E+02	3.0755000E-01	2.9600000E-01	9.1034000E-02	4.0006000E-01
6.9725000E+02	3.0179000E-01	2.9605000E-01	8.9347000E-02	3.9264000E-01
6.9730000E+02	2.9610000E-01	2.9611000E-01	8.7679000E-02	3.8531000E-01
6.9735000E+02	2.9047000E-01	2.9617000E-01	8.6028000E-02	3.7806000E-01
6.9740000E+02	2.8490000E-01	2.9623000E-01	8.4395000E-02	3.7088000E-01
6.9745000E+02	2.7939000E-01	2.9628000E-01	8.2780000E-02	3.6378000E-01
6.9750000E+02	2.7394000E-01	2.9634000E-01	8.1181000E-02	3.5675000E-01
6.9755000E+02	2.6855000E-01	2.9640000E-01	7.9599000E-02	3.4980000E-01
6.9760000E+02	2.6322000E-01	2.9646000E-01	7.8035000E-02	3.4293000E-01
6.9765000E+02	2.5796000E-01	2.9652000E-01	7.6488000E-02	3.3613000E-01
6.9770000E+02	2.5275000E-01	2.9657000E-01	7.4959000E-02	3.2941000E-01
6.9775000E+02	2.4761000E-01	2.9663000E-01	7.3449000E-02	3.2277000E-01
6.9780000E+02	2.4254000E-01	2.9669000E-01	7.1958000E-02	3.1622000E-01
6.9785000E+02	2.3753000E-01	2.9675000E-01	7.0487000E-02	3.0976000E-01
6.9790000E+02	2.3260000E-01	2.9680000E-01	6.9038000E-02	3.0339000E-01
6.9795000E+02	2.2775000E-01	2.9686000E-01	6.7611000E-02	2.9712000E-01
6.9800000E+02	2.2298000E-01	2.9692000E-01	6.6207000E-02	2.9095000E-01
6.9805000E+02	2.1829000E-01	2.9704000E-01	6.4842000E-02	2.8495000E-01
6.9810000E+02	2.1369000E-01	2.9717000E-01	6.3502000E-02	2.7906000E-01
6.9815000E+02	2.0918000E-01	2.9729000E-01	6.2188000E-02	2.7329000E-01
6.9820000E+02	2.0477000E-01	2.9742000E-01	6.0901000E-02	2.6763000E-01
6.9825000E+02	2.0045000E-01	2.9754000E-01	5.9641000E-02	2.6210000E-01
6.9830000E+02	1.9623000E-01	2.9767000E-01	5.8410000E-02	2.5669000E-01
6.9835000E+02	1.9211000E-01	2.9780000E-01	5.7208000E-02	2.5141000E-01

6.9840000E+02	1.8809000E-01	2.9792000E-01	5.6036000E-02	2.4625000E-01
6.9845000E+02	1.8417000E-01	2.9805000E-01	5.4892000E-02	2.4123000E-01
6.9850000E+02	1.8035000E-01	2.9818000E-01	5.3778000E-02	2.3633000E-01
6.9855000E+02	1.7663000E-01	2.9831000E-01	5.2692000E-02	2.3156000E-01
6.9860000E+02	1.7302000E-01	2.9844000E-01	5.1635000E-02	2.2691000E-01
6.9865000E+02	1.6949000E-01	2.9857000E-01	5.0606000E-02	2.2239000E-01
6.9870000E+02	1.6606000E-01	2.9870000E-01	4.9603000E-02	2.1798000E-01
6.9875000E+02	1.6272000E-01	2.9883000E-01	4.8625000E-02	2.1369000E-01
6.9880000E+02	1.5946000E-01	2.9896000E-01	4.7672000E-02	2.0950000E-01
6.9885000E+02	1.5628000E-01	2.9909000E-01	4.6743000E-02	2.0541000E-01
6.9890000E+02	1.5318000E-01	2.9922000E-01	4.5834000E-02	2.0142000E-01
6.9895000E+02	1.5015000E-01	2.9935000E-01	4.4946000E-02	1.9752000E-01
6.9900000E+02	1.4718000E-01	2.9948000E-01	4.4077000E-02	1.9370000E-01
6.9905000E+02	1.4427000E-01	2.9961000E-01	4.3225000E-02	1.8995000E-01
6.9910000E+02	1.4141000E-01	2.9974000E-01	4.2388000E-02	1.8628000E-01
6.9915000E+02	1.3861000E-01	2.9987000E-01	4.1565000E-02	1.8266000E-01
6.9920000E+02	1.3585000E-01	3.0000000E-01	4.0755000E-02	1.7910000E-01
6.9925000E+02	1.3313000E-01	3.0013000E-01	3.9956000E-02	1.7559000E-01
6.9930000E+02	1.3045000E-01	3.0026000E-01	3.9168000E-02	1.7213000E-01
6.9935000E+02	1.2780000E-01	3.0039000E-01	3.8390000E-02	1.6871000E-01
6.9940000E+02	1.2518000E-01	3.0052000E-01	3.7620000E-02	1.6532000E-01
6.9945000E+02	1.2259000E-01	3.0066000E-01	3.6859000E-02	1.6198000E-01
6.9950000E+02	1.2004000E-01	3.0079000E-01	3.6105000E-02	1.5867000E-01
6.9955000E+02	1.1751000E-01	3.0092000E-01	3.5360000E-02	1.5539000E-01
6.9960000E+02	1.1501000E-01	3.0105000E-01	3.4623000E-02	1.5215000E-01
6.9965000E+02	1.1254000E-01	3.0118000E-01	3.3895000E-02	1.4895000E-01
6.9970000E+02	1.1010000E-01	3.0131000E-01	3.3175000E-02	1.4579000E-01
6.9975000E+02	1.0770000E-01	3.0144000E-01	3.2464000E-02	1.4267000E-01
6.9980000E+02	1.0533000E-01	3.0157000E-01	3.1764000E-02	1.3959000E-01
6.9985000E+02	1.0300000E-01	3.0170000E-01	3.1076000E-02	1.3656000E-01
6.9990000E+02	1.0071000E-01	3.0183000E-01	3.0399000E-02	1.3359000E-01
6.9995000E+02	9.8474000E-02	3.0196000E-01	2.9735000E-02	1.3067000E-01
7.0000000E+02	9.6281000E-02	3.0209000E-01	2.9086000E-02	1.2782000E-01
7.0005000E+02	9.4140000E-02	3.0225000E-01	2.8454000E-02	1.2504000E-01
7.0010000E+02	9.2054000E-02	3.0241000E-01	2.7838000E-02	1.2234000E-01
7.0015000E+02	9.0025000E-02	3.0257000E-01	2.7238000E-02	1.1970000E-01
7.0020000E+02	8.8056000E-02	3.0272000E-01	2.6657000E-02	1.1714000E-01
7.0025000E+02	8.6147000E-02	3.0289000E-01	2.6093000E-02	1.1467000E-01
7.0030000E+02	8.4302000E-02	3.0305000E-01	2.5548000E-02	1.1227000E-01
7.0035000E+02	8.2520000E-02	3.0321000E-01	2.5021000E-02	1.0996000E-01
7.0040000E+02	8.0801000E-02	3.0337000E-01	2.4513000E-02	1.0772000E-01
7.0045000E+02	7.9144000E-02	3.0353000E-01	2.4023000E-02	1.0557000E-01
7.0050000E+02	7.7549000E-02	3.0370000E-01	2.3551000E-02	1.0350000E-01

7.0055000E+02	7.6013000E-02	3.0386000E-01	2.3097000E-02	1.0150000E-01
7.0060000E+02	7.4535000E-02	3.0402000E-01	2.2660000E-02	9.9581000E-02
7.0065000E+02	7.3110000E-02	3.0418000E-01	2.2239000E-02	9.7730000E-02
7.0070000E+02	7.1735000E-02	3.0434000E-01	2.1832000E-02	9.5943000E-02
7.0075000E+02	7.0407000E-02	3.0451000E-01	2.1439000E-02	9.4216000E-02
7.0080000E+02	6.9120000E-02	3.0467000E-01	2.1059000E-02	9.2544000E-02
7.0085000E+02	6.7871000E-02	3.0483000E-01	2.0689000E-02	9.0919000E-02
7.0090000E+02	6.6654000E-02	3.0499000E-01	2.0329000E-02	8.9336000E-02
7.0095000E+02	6.5464000E-02	3.0515000E-01	1.9977000E-02	8.7788000E-02
7.0100000E+02	6.4298000E-02	3.0531000E-01	1.9631000E-02	8.6270000E-02
7.0105000E+02	6.3150000E-02	3.0547000E-01	1.9291000E-02	8.4774000E-02
7.0110000E+02	6.2016000E-02	3.0563000E-01	1.8954000E-02	8.3295000E-02
7.0115000E+02	6.0892000E-02	3.0579000E-01	1.8620000E-02	8.1829000E-02
7.0120000E+02	5.9776000E-02	3.0595000E-01	1.8288000E-02	8.0370000E-02
7.0125000E+02	5.8662000E-02	3.0611000E-01	1.7957000E-02	7.8914000E-02
7.0130000E+02	5.7551000E-02	3.0627000E-01	1.7626000E-02	7.7459000E-02
7.0135000E+02	5.6438000E-02	3.0643000E-01	1.7295000E-02	7.6002000E-02
7.0140000E+02	5.5325000E-02	3.0659000E-01	1.6962000E-02	7.4542000E-02
7.0145000E+02	5.4210000E-02	3.0675000E-01	1.6629000E-02	7.3077000E-02
7.0150000E+02	5.3094000E-02	3.0691000E-01	1.6295000E-02	7.1609000E-02
7.0155000E+02	5.1976000E-02	3.0707000E-01	1.5960000E-02	7.0139000E-02
7.0160000E+02	5.0860000E-02	3.0723000E-01	1.5626000E-02	6.8668000E-02
7.0165000E+02	4.9746000E-02	3.0739000E-01	1.5291000E-02	6.7199000E-02
7.0170000E+02	4.8638000E-02	3.0755000E-01	1.4959000E-02	6.5736000E-02
7.0175000E+02	4.7538000E-02	3.0771000E-01	1.4628000E-02	6.4283000E-02
7.0180000E+02	4.6450000E-02	3.0786000E-01	1.4300000E-02	6.2843000E-02
7.0185000E+02	4.5376000E-02	3.0802000E-01	1.3977000E-02	6.1422000E-02
7.0190000E+02	4.4320000E-02	3.0818000E-01	1.3659000E-02	6.0024000E-02
7.0195000E+02	4.3285000E-02	3.0834000E-01	1.3347000E-02	5.8653000E-02
7.0200000E+02	4.2276000E-02	3.0850000E-01	1.3042000E-02	5.7314000E-02
7.0205000E+02	4.1294000E-02	3.0858000E-01	1.2743000E-02	5.5998000E-02
7.0210000E+02	4.0343000E-02	3.0867000E-01	1.2453000E-02	5.4723000E-02
7.0215000E+02	3.9425000E-02	3.0875000E-01	1.2173000E-02	5.3493000E-02
7.0220000E+02	3.8542000E-02	3.0884000E-01	1.1903000E-02	5.2309000E-02
7.0225000E+02	3.7696000E-02	3.0892000E-01	1.1645000E-02	5.1175000E-02
7.0230000E+02	3.6887000E-02	3.0900000E-01	1.1398000E-02	5.0090000E-02
7.0235000E+02	3.6116000E-02	3.0909000E-01	1.1163000E-02	4.9056000E-02
7.0240000E+02	3.5382000E-02	3.0917000E-01	1.0939000E-02	4.8073000E-02
7.0245000E+02	3.4685000E-02	3.0926000E-01	1.0726000E-02	4.7138000E-02
7.0250000E+02	3.4022000E-02	3.0934000E-01	1.0525000E-02	4.6251000E-02
7.0255000E+02	3.3393000E-02	3.0942000E-01	1.0333000E-02	4.5408000E-02
7.0260000E+02	3.2795000E-02	3.0951000E-01	1.0150000E-02	4.4606000E-02
7.0265000E+02	3.2224000E-02	3.0959000E-01	9.9764000E-03	4.3842000E-02

7.0270000E+02	3.1678000E-02	3.0968000E-01	9.8100000E-03	4.3111000E-02
7.0275000E+02	3.1154000E-02	3.0976000E-01	9.6502000E-03	4.2408000E-02
7.0280000E+02	3.0647000E-02	3.0984000E-01	9.4957000E-03	4.1729000E-02
7.0285000E+02	3.0154000E-02	3.0993000E-01	9.3456000E-03	4.1070000E-02
7.0290000E+02	2.9672000E-02	3.1001000E-01	9.1986000E-03	4.0424000E-02
7.0295000E+02	2.9197000E-02	3.1009000E-01	9.0537000E-03	3.9787000E-02
7.0300000E+02	2.8726000E-02	3.1018000E-01	8.9100000E-03	3.9156000E-02
7.0305000E+02	2.8256000E-02	3.1026000E-01	8.7665000E-03	3.8525000E-02
7.0310000E+02	2.7784000E-02	3.1034000E-01	8.6225000E-03	3.7892000E-02
7.0315000E+02	2.7309000E-02	3.1042000E-01	8.4773000E-03	3.7254000E-02
7.0320000E+02	2.6829000E-02	3.1050000E-01	8.3305000E-03	3.6609000E-02
7.0325000E+02	2.6344000E-02	3.1058000E-01	8.1818000E-03	3.5955000E-02
7.0330000E+02	2.5851000E-02	3.1066000E-01	8.0310000E-03	3.5293000E-02
7.0335000E+02	2.5353000E-02	3.1074000E-01	7.8781000E-03	3.4621000E-02
7.0340000E+02	2.4848000E-02	3.1082000E-01	7.7234000E-03	3.3941000E-02
7.0345000E+02	2.4339000E-02	3.1091000E-01	7.5671000E-03	3.3254000E-02
7.0350000E+02	2.3827000E-02	3.1099000E-01	7.4098000E-03	3.2563000E-02
7.0355000E+02	2.3314000E-02	3.1107000E-01	7.2521000E-03	3.1870000E-02
7.0360000E+02	2.2822000E-02	3.1115000E-01	7.1010000E-03	3.1206000E-02
7.0365000E+02	2.2327000E-02	3.1123000E-01	6.9487000E-03	3.0537000E-02
7.0370000E+02	2.1838000E-02	3.1131000E-01	6.7985000E-03	2.9876000E-02
7.0375000E+02	2.1359000E-02	3.1139000E-01	6.6511000E-03	2.9229000E-02
7.0380000E+02	2.0892000E-02	3.1147000E-01	6.5073000E-03	2.8597000E-02
7.0385000E+02	2.0439000E-02	3.1155000E-01	6.3677000E-03	2.7983000E-02
7.0390000E+02	2.0001000E-02	3.1163000E-01	6.2330000E-03	2.7392000E-02
7.0395000E+02	1.9582000E-02	3.1171000E-01	6.1039000E-03	2.6824000E-02
7.0400000E+02	1.9182000E-02	3.1179000E-01	5.9807000E-03	2.6283000E-02
7.0405000E+02	1.8802000E-02	3.1191000E-01	5.8646000E-03	2.5772000E-02
7.0410000E+02	1.8445000E-02	3.1202000E-01	5.7552000E-03	2.5292000E-02
7.0415000E+02	1.8109000E-02	3.1214000E-01	5.6526000E-03	2.4841000E-02
7.0420000E+02	1.7796000E-02	3.1226000E-01	5.5569000E-03	2.4420000E-02
7.0425000E+02	1.7504000E-02	3.1238000E-01	5.4679000E-03	2.4029000E-02
7.0430000E+02	1.7233000E-02	3.1250000E-01	5.3854000E-03	2.3666000E-02
7.0435000E+02	1.6982000E-02	3.1262000E-01	5.3089000E-03	2.3330000E-02
7.0440000E+02	1.6749000E-02	3.1274000E-01	5.2381000E-03	2.3019000E-02
7.0445000E+02	1.6532000E-02	3.1286000E-01	5.1722000E-03	2.2730000E-02
7.0450000E+02	1.6329000E-02	3.1298000E-01	5.1108000E-03	2.2460000E-02
7.0455000E+02	1.6138000E-02	3.1310000E-01	5.0530000E-03	2.2206000E-02
7.0460000E+02	1.5957000E-02	3.1322000E-01	4.9980000E-03	2.1964000E-02
7.0465000E+02	1.5782000E-02	3.1334000E-01	4.9451000E-03	2.1732000E-02
7.0470000E+02	1.5611000E-02	3.1346000E-01	4.8935000E-03	2.1505000E-02
7.0475000E+02	1.5442000E-02	3.1358000E-01	4.8424000E-03	2.1280000E-02
7.0480000E+02	1.5273000E-02	3.1370000E-01	4.7911000E-03	2.1055000E-02

7.0485000E+02	1.5101000E-02	3.1382000E-01	4.7389000E-03	2.0826000E-02
7.0490000E+02	1.4924000E-02	3.1394000E-01	4.6853000E-03	2.0590000E-02
7.0495000E+02	1.4742000E-02	3.1406000E-01	4.6297000E-03	2.0346000E-02
7.0500000E+02	1.4552000E-02	3.1418000E-01	4.5719000E-03	2.0091000E-02
7.0505000E+02	1.4354000E-02	3.1430000E-01	4.5114000E-03	1.9826000E-02
7.0510000E+02	1.4148000E-02	3.1442000E-01	4.4483000E-03	1.9548000E-02
7.0515000E+02	1.3933000E-02	3.1454000E-01	4.3824000E-03	1.9259000E-02
7.0520000E+02	1.3710000E-02	3.1466000E-01	4.3139000E-03	1.8958000E-02
7.0525000E+02	1.3479000E-02	3.1478000E-01	4.2429000E-03	1.8646000E-02
7.0530000E+02	1.3241000E-02	3.1490000E-01	4.1697000E-03	1.8324000E-02
7.0535000E+02	1.2998000E-02	3.1502000E-01	4.0947000E-03	1.7995000E-02
7.0540000E+02	1.2751000E-02	3.1514000E-01	4.0184000E-03	1.7659000E-02
7.0545000E+02	1.2502000E-02	3.1526000E-01	3.9413000E-03	1.7320000E-02
7.0550000E+02	1.2251000E-02	3.1538000E-01	3.8638000E-03	1.6980000E-02
7.0555000E+02	1.2002000E-02	3.1550000E-01	3.7865000E-03	1.6640000E-02
7.0560000E+02	1.1755000E-02	3.1562000E-01	3.7100000E-03	1.6304000E-02
7.0565000E+02	1.1512000E-02	3.1574000E-01	3.6347000E-03	1.5973000E-02
7.0570000E+02	1.1274000E-02	3.1586000E-01	3.5611000E-03	1.5650000E-02
7.0575000E+02	1.1044000E-02	3.1598000E-01	3.4897000E-03	1.5336000E-02
7.0580000E+02	1.0821000E-02	3.1610000E-01	3.4207000E-03	1.5032000E-02
7.0585000E+02	1.0607000E-02	3.1622000E-01	3.3543000E-03	1.4741000E-02
7.0590000E+02	1.0403000E-02	3.1634000E-01	3.2908000E-03	1.4461000E-02
7.0595000E+02	1.0207000E-02	3.1646000E-01	3.2302000E-03	1.4195000E-02
7.0600000E+02	1.0021000E-02	3.1658000E-01	3.1724000E-03	1.3941000E-02
7.0605000E+02	9.8436000E-03	3.1669000E-01	3.1174000E-03	1.3699000E-02
7.0610000E+02	9.6744000E-03	3.1680000E-01	3.0648000E-03	1.3469000E-02
7.0615000E+02	9.5127000E-03	3.1690000E-01	3.0146000E-03	1.3248000E-02
7.0620000E+02	9.3572000E-03	3.1701000E-01	2.9663000E-03	1.3036000E-02
7.0625000E+02	9.2068000E-03	3.1712000E-01	2.9197000E-03	1.2831000E-02
7.0630000E+02	9.0603000E-03	3.1723000E-01	2.8742000E-03	1.2631000E-02
7.0635000E+02	8.9162000E-03	3.1733000E-01	2.8294000E-03	1.2434000E-02
7.0640000E+02	8.7733000E-03	3.1744000E-01	2.7850000E-03	1.2239000E-02
7.0645000E+02	8.6303000E-03	3.1755000E-01	2.7405000E-03	1.2043000E-02
7.0650000E+02	8.4861000E-03	3.1766000E-01	2.6957000E-03	1.1846000E-02
7.0655000E+02	8.3398000E-03	3.1776000E-01	2.6501000E-03	1.1646000E-02
7.0660000E+02	8.1906000E-03	3.1787000E-01	2.6035000E-03	1.1441000E-02
7.0665000E+02	8.0380000E-03	3.1798000E-01	2.5559000E-03	1.1232000E-02
7.0670000E+02	7.8819000E-03	3.1808000E-01	2.5071000E-03	1.1018000E-02
7.0675000E+02	7.7223000E-03	3.1819000E-01	2.4572000E-03	1.0798000E-02
7.0680000E+02	7.5595000E-03	3.1830000E-01	2.4062000E-03	1.0574000E-02
7.0685000E+02	7.3943000E-03	3.1841000E-01	2.3544000E-03	1.0346000E-02
7.0690000E+02	7.2275000E-03	3.1851000E-01	2.3020000E-03	1.0116000E-02
7.0695000E+02	7.0601000E-03	3.1862000E-01	2.2495000E-03	9.8856000E-03

7.070000E+02	6.893700E-03	3.187300E-01	2.197200E-03	9.655700E-03
7.070500E+02	6.729500E-03	3.188400E-01	2.145600E-03	9.429000E-03
7.071000E+02	6.569300E-03	3.189400E-01	2.095200E-03	9.207600E-03
7.071500E+02	6.414500E-03	3.190500E-01	2.046500E-03	8.993700E-03
7.072000E+02	6.266700E-03	3.191600E-01	2.000100E-03	8.789500E-03
7.072500E+02	6.127500E-03	3.192700E-01	1.956300E-03	8.597100E-03
7.073000E+02	5.998100E-03	3.193800E-01	1.915600E-03	8.418400E-03
7.073500E+02	5.879600E-03	3.194800E-01	1.878400E-03	8.255000E-03
7.074000E+02	5.773000E-03	3.195900E-01	1.845000E-03	8.108000E-03
7.074500E+02	5.678900E-03	3.197000E-01	1.815500E-03	7.978500E-03
7.075000E+02	5.597400E-03	3.198100E-01	1.790100E-03	7.866600E-03
7.075500E+02	5.528400E-03	3.199200E-01	1.768600E-03	7.772400E-03
7.076000E+02	5.471600E-03	3.200200E-01	1.751100E-03	7.695100E-03
7.076500E+02	5.426100E-03	3.201300E-01	1.737100E-03	7.633700E-03
7.077000E+02	5.390700E-03	3.202400E-01	1.726300E-03	7.586400E-03
7.077500E+02	5.363900E-03	3.203500E-01	1.718300E-03	7.551300E-03
7.078000E+02	5.344000E-03	3.204600E-01	1.712500E-03	7.525800E-03
7.078500E+02	5.328900E-03	3.205700E-01	1.708300E-03	7.507100E-03
7.079000E+02	5.316400E-03	3.206700E-01	1.704800E-03	7.492000E-03
7.079500E+02	5.304200E-03	3.207800E-01	1.701500E-03	7.477300E-03
7.080000E+02	5.289800E-03	3.208900E-01	1.697400E-03	7.459500E-03
7.080500E+02	5.271000E-03	3.209600E-01	1.691800E-03	7.434600E-03
7.081000E+02	5.245300E-03	3.210300E-01	1.683900E-03	7.400100E-03
7.081500E+02	5.210800E-03	3.211000E-01	1.673200E-03	7.352900E-03
7.082000E+02	5.165400E-03	3.211700E-01	1.659000E-03	7.290500E-03
7.082500E+02	5.107500E-03	3.212400E-01	1.640800E-03	7.210400E-03
7.083000E+02	5.036000E-03	3.213100E-01	1.618100E-03	7.111000E-03
7.083500E+02	4.949900E-03	3.213800E-01	1.590800E-03	6.991000E-03
7.084000E+02	4.848700E-03	3.214500E-01	1.558600E-03	6.849600E-03
7.084500E+02	4.732500E-03	3.215200E-01	1.521600E-03	6.686800E-03
7.085000E+02	4.601500E-03	3.216000E-01	1.479800E-03	6.503200E-03
7.085500E+02	4.456800E-03	3.216700E-01	1.433600E-03	6.300100E-03
7.086000E+02	4.299600E-03	3.217400E-01	1.383300E-03	6.079200E-03
7.086500E+02	4.131600E-03	3.218100E-01	1.329600E-03	5.842900E-03
7.087000E+02	3.954700E-03	3.218800E-01	1.272900E-03	5.593900E-03
7.087500E+02	3.771200E-03	3.219500E-01	1.214100E-03	5.335600E-03
7.088000E+02	3.583700E-03	3.220200E-01	1.154000E-03	5.071500E-03
7.088500E+02	3.394900E-03	3.220900E-01	1.093500E-03	4.805300E-03
7.089000E+02	3.207400E-03	3.221600E-01	1.033300E-03	4.540900E-03
7.089500E+02	3.024000E-03	3.222300E-01	9.744300E-04	4.282200E-03
7.090000E+02	2.847300E-03	3.223000E-01	9.177100E-04	4.032900E-03
7.090500E+02	2.679900E-03	3.223700E-01	8.639300E-04	3.796600E-03
7.091000E+02	2.524000E-03	3.224400E-01	8.138400E-04	3.576500E-03

7.0915000E+02	2.3815000E-03	3.2251000E-01	7.6807000E-04	3.3754000E-03
7.0920000E+02	2.2542000E-03	3.2258000E-01	7.2717000E-04	3.1956000E-03
7.0925000E+02	2.1433000E-03	3.2265000E-01	6.9153000E-04	3.0390000E-03
7.0930000E+02	2.0495000E-03	3.2272000E-01	6.6142000E-04	2.9067000E-03
7.0935000E+02	1.9734000E-03	3.2279000E-01	6.3699000E-04	2.7993000E-03
7.0940000E+02	1.9148000E-03	3.2286000E-01	6.1821000E-04	2.7168000E-03
7.0945000E+02	1.8734000E-03	3.2293000E-01	6.0495000E-04	2.6585000E-03
7.0950000E+02	0.0000000E+00	3.2299000E-01	0.0000000E+00	0.0000000E+00
Channel 4				
Wavenumber	HIRS Filter Transmittance	Optical Element Transmittance	Product of the HIRS Filter and Optical Element Transmittances	Normalized Value of Column 4
6.8320000E+02	0.0000000E+00	2.6225000E-01	0.0000000E+00	0.0000000E+00
6.8330000E+02	1.9694000E-03	2.6251000E-01	5.1698000E-04	2.1792000E-03
6.8340000E+02	2.0011000E-03	2.6276000E-01	5.2582000E-04	2.2164000E-03
6.8350000E+02	2.0531000E-03	2.6301000E-01	5.3999000E-04	2.2762000E-03
6.8360000E+02	2.1261000E-03	2.6326000E-01	5.5972000E-04	2.3594000E-03
6.8370000E+02	2.2201000E-03	2.6352000E-01	5.8503000E-04	2.4660000E-03
6.8380000E+02	2.3343000E-03	2.6377000E-01	6.1572000E-04	2.5954000E-03
6.8390000E+02	2.4673000E-03	2.6402000E-01	6.5142000E-04	2.7459000E-03
6.8400000E+02	2.6168000E-03	2.6427000E-01	6.9155000E-04	2.9150000E-03
6.8410000E+02	2.7800000E-03	2.6434000E-01	7.3485000E-04	3.0976000E-03
6.8420000E+02	2.9537000E-03	2.6440000E-01	7.8095000E-04	3.2919000E-03
6.8430000E+02	3.1344000E-03	2.6446000E-01	8.2891000E-04	3.4941000E-03
6.8440000E+02	3.3184000E-03	2.6452000E-01	8.7781000E-04	3.7002000E-03
6.8450000E+02	3.5025000E-03	2.6459000E-01	9.2672000E-04	3.9063000E-03
6.8460000E+02	3.6835000E-03	2.6465000E-01	9.7484000E-04	4.1092000E-03
6.8470000E+02	3.8588000E-03	2.6471000E-01	1.0215000E-03	4.3057000E-03
6.8480000E+02	4.0265000E-03	2.6477000E-01	1.0661000E-03	4.4938000E-03
6.8490000E+02	4.1854000E-03	2.6484000E-01	1.1084000E-03	4.6724000E-03
6.8500000E+02	4.3354000E-03	2.6490000E-01	1.1485000E-03	4.8410000E-03
6.8510000E+02	4.4775000E-03	2.6496000E-01	1.1864000E-03	5.0007000E-03
6.8520000E+02	4.6133000E-03	2.6502000E-01	1.2226000E-03	5.1536000E-03
6.8530000E+02	4.7457000E-03	2.6508000E-01	1.2580000E-03	5.3027000E-03
6.8540000E+02	4.8784000E-03	2.6514000E-01	1.2934000E-03	5.4522000E-03
6.8550000E+02	5.0157000E-03	2.6520000E-01	1.3301000E-03	5.6068000E-03
6.8560000E+02	5.1623000E-03	2.6526000E-01	1.3693000E-03	5.7720000E-03
6.8570000E+02	5.3233000E-03	2.6531000E-01	1.4123000E-03	5.9533000E-03
6.8580000E+02	5.5035000E-03	2.6537000E-01	1.4605000E-03	6.1562000E-03
6.8590000E+02	5.7074000E-03	2.6543000E-01	1.5149000E-03	6.3857000E-03
6.8600000E+02	5.9388000E-03	2.6549000E-01	1.5767000E-03	6.6460000E-03
6.8610000E+02	6.2005000E-03	2.6586000E-01	1.6485000E-03	6.9488000E-03

6.8620000E+02	6.4943000E-03	2.6624000E-01	1.7290000E-03	7.2883000E-03
6.8630000E+02	6.8205000E-03	2.6662000E-01	1.8185000E-03	7.6653000E-03
6.8640000E+02	7.1780000E-03	2.6700000E-01	1.9165000E-03	8.0785000E-03
6.8650000E+02	7.5644000E-03	2.6737000E-01	2.0225000E-03	8.5253000E-03
6.8660000E+02	7.9757000E-03	2.6775000E-01	2.1355000E-03	9.0016000E-03
6.8670000E+02	8.4068000E-03	2.6813000E-01	2.2541000E-03	9.5016000E-03
6.8680000E+02	8.8518000E-03	2.6852000E-01	2.3768000E-03	1.0019000E-02
6.8690000E+02	9.3038000E-03	2.6891000E-01	2.5018000E-03	1.0546000E-02
6.8700000E+02	9.7558000E-03	2.6930000E-01	2.6272000E-03	1.1074000E-02
6.8710000E+02	1.0201000E-02	2.6969000E-01	2.7510000E-03	1.1596000E-02
6.8720000E+02	1.0633000E-02	2.7008000E-01	2.8716000E-03	1.2105000E-02
6.8730000E+02	1.1046000E-02	2.7047000E-01	2.9875000E-03	1.2593000E-02
6.8740000E+02	1.1436000E-02	2.7086000E-01	3.0974000E-03	1.3056000E-02
6.8750000E+02	1.1800000E-02	2.7125000E-01	3.2006000E-03	1.3491000E-02
6.8760000E+02	1.2137000E-02	2.7164000E-01	3.2969000E-03	1.3897000E-02
6.8770000E+02	1.2450000E-02	2.7203000E-01	3.3866000E-03	1.4275000E-02
6.8780000E+02	1.2740000E-02	2.7242000E-01	3.4705000E-03	1.4629000E-02
6.8790000E+02	1.3013000E-02	2.7281000E-01	3.5500000E-03	1.4964000E-02
6.8800000E+02	1.3277000E-02	2.7320000E-01	3.6271000E-03	1.5289000E-02
6.8810000E+02	1.3539000E-02	2.7349000E-01	3.7028000E-03	1.5608000E-02
6.8820000E+02	1.3812000E-02	2.7377000E-01	3.7813000E-03	1.5939000E-02
6.8830000E+02	1.4105000E-02	2.7406000E-01	3.8656000E-03	1.6294000E-02
6.8840000E+02	1.4430000E-02	2.7435000E-01	3.9590000E-03	1.6688000E-02
6.8850000E+02	1.4801000E-02	2.7464000E-01	4.0651000E-03	1.7135000E-02
6.8860000E+02	1.5229000E-02	2.7493000E-01	4.1870000E-03	1.7649000E-02
6.8870000E+02	1.5726000E-02	2.7523000E-01	4.3283000E-03	1.8245000E-02
6.8880000E+02	1.3733000E-02	2.7552000E-01	3.7836000E-03	1.5949000E-02
6.8890000E+02	1.4039000E-02	2.7581000E-01	3.8721000E-03	1.6322000E-02
6.8900000E+02	1.4539000E-02	2.7611000E-01	4.0143000E-03	1.6921000E-02
6.8910000E+02	1.5252000E-02	2.7640000E-01	4.2156000E-03	1.7770000E-02
6.8920000E+02	1.6188000E-02	2.7670000E-01	4.4790000E-03	1.8880000E-02
6.8930000E+02	1.7348000E-02	2.7699000E-01	4.8053000E-03	2.0255000E-02
6.8940000E+02	1.8727000E-02	2.7728000E-01	5.1928000E-03	2.1889000E-02
6.8950000E+02	2.0310000E-02	2.7758000E-01	5.6375000E-03	2.3763000E-02
6.8960000E+02	2.2075000E-02	2.7787000E-01	6.1339000E-03	2.5856000E-02
6.8970000E+02	2.3997000E-02	2.7816000E-01	6.6751000E-03	2.8137000E-02
6.8980000E+02	2.6048000E-02	2.7846000E-01	7.2533000E-03	3.0574000E-02
6.8990000E+02	2.8201000E-02	2.7875000E-01	7.8611000E-03	3.3136000E-02
6.9000000E+02	3.0430000E-02	2.7904000E-01	8.4914000E-03	3.5793000E-02
6.9010000E+02	3.2716000E-02	2.7926000E-01	9.1362000E-03	3.8511000E-02
6.9020000E+02	3.5044000E-02	2.7948000E-01	9.7939000E-03	4.1284000E-02
6.9030000E+02	3.7408000E-02	2.7970000E-01	1.0463000E-02	4.4104000E-02
6.9040000E+02	3.9813000E-02	2.7992000E-01	1.1144000E-02	4.6976000E-02

6.9050000E+02	4.2271000E-02	2.8013000E-01	1.1842000E-02	4.9915000E-02
6.9060000E+02	4.4804000E-02	2.8036000E-01	1.2561000E-02	5.2949000E-02
6.9070000E+02	4.7441000E-02	2.8060000E-01	1.3312000E-02	5.6113000E-02
6.9080000E+02	5.0219000E-02	2.8083000E-01	1.4103000E-02	5.9448000E-02
6.9090000E+02	5.3177000E-02	2.8107000E-01	1.4946000E-02	6.3002000E-02
6.9100000E+02	5.6359000E-02	2.8130000E-01	1.5854000E-02	6.6829000E-02
6.9110000E+02	5.9809000E-02	2.8154000E-01	1.6838000E-02	7.0978000E-02
6.9120000E+02	6.3569000E-02	2.8177000E-01	1.7912000E-02	7.5503000E-02
6.9130000E+02	6.7680000E-02	2.8200000E-01	1.9086000E-02	8.0451000E-02
6.9140000E+02	7.2178000E-02	2.8224000E-01	2.0371000E-02	8.5869000E-02
6.9150000E+02	7.7095000E-02	2.8247000E-01	2.1777000E-02	9.1795000E-02
6.9160000E+02	8.2462000E-02	2.8270000E-01	2.3312000E-02	9.8266000E-02
6.9170000E+02	8.8302000E-02	2.8293000E-01	2.4984000E-02	1.0531000E-01
6.9180000E+02	9.4639000E-02	2.8317000E-01	2.6798000E-02	1.1296000E-01
6.9190000E+02	1.0149000E-01	2.8340000E-01	2.8763000E-02	1.2124000E-01
6.9200000E+02	1.0889000E-01	2.8363000E-01	3.0884000E-02	1.3018000E-01
6.9210000E+02	1.1685000E-01	2.8390000E-01	3.3173000E-02	1.3983000E-01
6.9220000E+02	1.2539000E-01	2.8417000E-01	3.5633000E-02	1.5020000E-01
6.9230000E+02	1.3456000E-01	2.8444000E-01	3.8274000E-02	1.6133000E-01
6.9240000E+02	1.4438000E-01	2.8471000E-01	4.1105000E-02	1.7327000E-01
6.9250000E+02	1.5488000E-01	2.8498000E-01	4.4138000E-02	1.8605000E-01
6.9260000E+02	1.6611000E-01	2.8528000E-01	4.7386000E-02	1.9974000E-01
6.9270000E+02	1.7809000E-01	2.8557000E-01	5.0858000E-02	2.1438000E-01
6.9280000E+02	1.9087000E-01	2.8587000E-01	5.4564000E-02	2.3000000E-01
6.9290000E+02	2.0448000E-01	2.8617000E-01	5.8515000E-02	2.4665000E-01
6.9300000E+02	2.1893000E-01	2.8647000E-01	6.2716000E-02	2.6436000E-01
6.9310000E+02	2.3424000E-01	2.8676000E-01	6.7172000E-02	2.8315000E-01
6.9320000E+02	2.5042000E-01	2.8706000E-01	7.1884000E-02	3.0301000E-01
6.9330000E+02	2.6743000E-01	2.8735000E-01	7.6848000E-02	3.2393000E-01
6.9340000E+02	2.8526000E-01	2.8765000E-01	8.2057000E-02	3.4589000E-01
6.9350000E+02	3.0386000E-01	2.8795000E-01	8.7496000E-02	3.6882000E-01
6.9360000E+02	3.2316000E-01	2.8824000E-01	9.3148000E-02	3.9264000E-01
6.9370000E+02	3.4307000E-01	2.8854000E-01	9.8990000E-02	4.1727000E-01
6.9380000E+02	3.6351000E-01	2.8884000E-01	1.0500000E-01	4.4258000E-01
6.9390000E+02	3.8437000E-01	2.8913000E-01	1.1113000E-01	4.6845000E-01
6.9400000E+02	4.0552000E-01	2.8943000E-01	1.1737000E-01	4.9474000E-01
6.9410000E+02	4.2685000E-01	2.8968000E-01	1.2365000E-01	5.2121000E-01
6.9420000E+02	4.4822000E-01	2.8993000E-01	1.2995000E-01	5.4778000E-01
6.9430000E+02	4.6951000E-01	2.9018000E-01	1.3624000E-01	5.7430000E-01
6.9440000E+02	4.9059000E-01	2.9043000E-01	1.4248000E-01	6.0060000E-01
6.9450000E+02	5.1134000E-01	2.9069000E-01	1.4864000E-01	6.2657000E-01
6.9460000E+02	5.3164000E-01	2.9096000E-01	1.5468000E-01	6.5203000E-01
6.9470000E+02	5.5138000E-01	2.9122000E-01	1.6058000E-01	6.7686000E-01

6.9480000E+02	5.7047000E-01	2.9149000E-01	1.6628000E-01	7.0093000E-01
6.9490000E+02	5.8880000E-01	2.9175000E-01	1.7178000E-01	7.2411000E-01
6.9500000E+02	6.0630000E-01	2.9202000E-01	1.7705000E-01	7.4631000E-01
6.9510000E+02	6.2289000E-01	2.9228000E-01	1.8206000E-01	7.6742000E-01
6.9520000E+02	6.3850000E-01	2.9255000E-01	1.8679000E-01	7.8737000E-01
6.9530000E+02	6.5308000E-01	2.9281000E-01	1.9123000E-01	8.0607000E-01
6.9540000E+02	6.6656000E-01	2.9308000E-01	1.9535000E-01	8.2346000E-01
6.9550000E+02	6.7890000E-01	2.9334000E-01	1.9915000E-01	8.3946000E-01
6.9560000E+02	6.9007000E-01	2.9361000E-01	2.0261000E-01	8.5405000E-01
6.9570000E+02	7.0004000E-01	2.9387000E-01	2.0572000E-01	8.6717000E-01
6.9580000E+02	7.0880000E-01	2.9414000E-01	2.0848000E-01	8.7881000E-01
6.9590000E+02	7.1632000E-01	2.9440000E-01	2.1089000E-01	8.8894000E-01
6.9600000E+02	7.2264000E-01	2.9467000E-01	2.1294000E-01	8.9759000E-01
6.9610000E+02	7.2776000E-01	2.9477000E-01	2.1452000E-01	9.0425000E-01
6.9620000E+02	7.3171000E-01	2.9487000E-01	2.1576000E-01	9.0948000E-01
6.9630000E+02	7.3456000E-01	2.9497000E-01	2.1668000E-01	9.1334000E-01
6.9640000E+02	7.3637000E-01	2.9508000E-01	2.1729000E-01	9.1592000E-01
6.9650000E+02	7.3721000E-01	2.9520000E-01	2.1762000E-01	9.1732000E-01
6.9660000E+02	7.3717000E-01	2.9531000E-01	2.1769000E-01	9.1763000E-01
6.9670000E+02	7.3637000E-01	2.9542000E-01	2.1754000E-01	9.1698000E-01
6.9680000E+02	7.3489000E-01	2.9554000E-01	2.1719000E-01	9.1549000E-01
6.9690000E+02	7.3286000E-01	2.9565000E-01	2.1667000E-01	9.1331000E-01
6.9700000E+02	7.3038000E-01	2.9577000E-01	2.1602000E-01	9.1058000E-01
6.9710000E+02	7.2756000E-01	2.9588000E-01	2.1527000E-01	9.0742000E-01
6.9720000E+02	7.2452000E-01	2.9600000E-01	2.1445000E-01	9.0397000E-01
6.9730000E+02	7.2133000E-01	2.9611000E-01	2.1359000E-01	9.0034000E-01
6.9740000E+02	7.1808000E-01	2.9623000E-01	2.1271000E-01	8.9664000E-01
6.9750000E+02	7.1485000E-01	2.9634000E-01	2.1184000E-01	8.9295000E-01
6.9760000E+02	7.1168000E-01	2.9646000E-01	2.1098000E-01	8.8934000E-01
6.9770000E+02	7.0863000E-01	2.9657000E-01	2.1016000E-01	8.8588000E-01
6.9780000E+02	7.0574000E-01	2.9669000E-01	2.0938000E-01	8.8260000E-01
6.9790000E+02	7.0302000E-01	2.9680000E-01	2.0866000E-01	8.7954000E-01
6.9800000E+02	7.0049000E-01	2.9692000E-01	2.0799000E-01	8.7672000E-01
6.9810000E+02	6.9817000E-01	2.9717000E-01	2.0747000E-01	8.7454000E-01
6.9820000E+02	6.9606000E-01	2.9742000E-01	2.0702000E-01	8.7263000E-01
6.9830000E+02	6.9417000E-01	2.9767000E-01	2.0663000E-01	8.7099000E-01
6.9840000E+02	6.9250000E-01	2.9792000E-01	2.0631000E-01	8.6966000E-01
6.9850000E+02	6.9108000E-01	2.9818000E-01	2.0607000E-01	8.6862000E-01
6.9860000E+02	6.8990000E-01	2.9844000E-01	2.0590000E-01	8.6790000E-01
6.9870000E+02	6.8899000E-01	2.9870000E-01	2.0580000E-01	8.6750000E-01
6.9880000E+02	6.8836000E-01	2.9896000E-01	2.0579000E-01	8.6746000E-01
6.9890000E+02	6.8802000E-01	2.9922000E-01	2.0587000E-01	8.6779000E-01
6.9900000E+02	6.8800000E-01	2.9948000E-01	2.0604000E-01	8.6851000E-01

6.9910000E+02	6.8830000E-01	2.9974000E-01	2.0631000E-01	8.6965000E-01
6.9920000E+02	6.8894000E-01	3.0000000E-01	2.0668000E-01	8.7121000E-01
6.9930000E+02	6.8990000E-01	3.0026000E-01	2.0715000E-01	8.7319000E-01
6.9940000E+02	6.9119000E-01	3.0052000E-01	2.0772000E-01	8.7558000E-01
6.9950000E+02	6.9278000E-01	3.0079000E-01	2.0838000E-01	8.7836000E-01
6.9960000E+02	6.9465000E-01	3.0105000E-01	2.0912000E-01	8.8150000E-01
6.9970000E+02	6.9677000E-01	3.0131000E-01	2.0994000E-01	8.8495000E-01
6.9980000E+02	6.9909000E-01	3.0157000E-01	2.1082000E-01	8.8867000E-01
6.9990000E+02	7.0157000E-01	3.0183000E-01	2.1175000E-01	8.9260000E-01
7.0000000E+02	7.0416000E-01	3.0209000E-01	2.1272000E-01	8.9666000E-01
7.0010000E+02	7.0681000E-01	3.0241000E-01	2.1374000E-01	9.0098000E-01
7.0020000E+02	7.0947000E-01	3.0272000E-01	2.1477000E-01	9.0532000E-01
7.0030000E+02	7.1209000E-01	3.0305000E-01	2.1580000E-01	9.0963000E-01
7.0040000E+02	7.1463000E-01	3.0337000E-01	2.1680000E-01	9.1386000E-01
7.0050000E+02	7.1707000E-01	3.0370000E-01	2.1777000E-01	9.1796000E-01
7.0060000E+02	7.1938000E-01	3.0402000E-01	2.1871000E-01	9.2189000E-01
7.0070000E+02	7.2154000E-01	3.0434000E-01	2.1960000E-01	9.2565000E-01
7.0080000E+02	7.2354000E-01	3.0467000E-01	2.2044000E-01	9.2921000E-01
7.0090000E+02	7.2539000E-01	3.0499000E-01	2.2124000E-01	9.3257000E-01
7.0100000E+02	7.2709000E-01	3.0531000E-01	2.2199000E-01	9.3574000E-01
7.0110000E+02	7.2865000E-01	3.0563000E-01	2.2270000E-01	9.3872000E-01
7.0120000E+02	7.3007000E-01	3.0595000E-01	2.2337000E-01	9.4154000E-01
7.0130000E+02	7.3136000E-01	3.0627000E-01	2.2399000E-01	9.4419000E-01
7.0140000E+02	7.3253000E-01	3.0659000E-01	2.2459000E-01	9.4669000E-01
7.0150000E+02	7.3359000E-01	3.0691000E-01	2.2515000E-01	9.4904000E-01
7.0160000E+02	7.3453000E-01	3.0723000E-01	2.2567000E-01	9.5124000E-01
7.0170000E+02	7.3534000E-01	3.0755000E-01	2.2615000E-01	9.5328000E-01
7.0180000E+02	7.3602000E-01	3.0786000E-01	2.2659000E-01	9.5514000E-01
7.0190000E+02	7.3655000E-01	3.0818000E-01	2.2699000E-01	9.5682000E-01
7.0200000E+02	7.3692000E-01	3.0850000E-01	2.2734000E-01	9.5829000E-01
7.0210000E+02	7.3711000E-01	3.0867000E-01	2.2752000E-01	9.5905000E-01
7.0220000E+02	7.3711000E-01	3.0884000E-01	2.2764000E-01	9.5957000E-01
7.0230000E+02	7.3690000E-01	3.0900000E-01	2.2771000E-01	9.5983000E-01
7.0240000E+02	7.3649000E-01	3.0917000E-01	2.2770000E-01	9.5982000E-01
7.0250000E+02	7.3586000E-01	3.0934000E-01	2.2763000E-01	9.5952000E-01
7.0260000E+02	7.3504000E-01	3.0951000E-01	2.2750000E-01	9.5897000E-01
7.0270000E+02	7.3402000E-01	3.0968000E-01	2.2731000E-01	9.5816000E-01
7.0280000E+02	7.3284000E-01	3.0984000E-01	2.2706000E-01	9.5713000E-01
7.0290000E+02	7.3151000E-01	3.1001000E-01	2.2677000E-01	9.5590000E-01
7.0300000E+02	7.3006000E-01	3.1018000E-01	2.2645000E-01	9.5453000E-01
7.0310000E+02	7.2853000E-01	3.1034000E-01	2.2609000E-01	9.5303000E-01
7.0320000E+02	7.2696000E-01	3.1050000E-01	2.2572000E-01	9.5146000E-01
7.0330000E+02	7.2537000E-01	3.1066000E-01	2.2535000E-01	9.4988000E-01

7.0340000E+02	7.2380000E-01	3.1082000E-01	2.2498000E-01	9.4832000E-01
7.0350000E+02	7.2228000E-01	3.1099000E-01	2.2462000E-01	9.4682000E-01
7.0360000E+02	7.2083000E-01	3.1115000E-01	2.2428000E-01	9.4541000E-01
7.0370000E+02	7.1947000E-01	3.1131000E-01	2.2398000E-01	9.4412000E-01
7.0380000E+02	7.1822000E-01	3.1147000E-01	2.2370000E-01	9.4296000E-01
7.0390000E+02	7.1708000E-01	3.1163000E-01	2.2347000E-01	9.4196000E-01
7.0400000E+02	7.1606000E-01	3.1179000E-01	2.2326000E-01	9.4111000E-01
7.0410000E+02	7.1518000E-01	3.1202000E-01	2.2315000E-01	9.4064000E-01
7.0420000E+02	7.1442000E-01	3.1226000E-01	2.2309000E-01	9.4036000E-01
7.0430000E+02	7.1378000E-01	3.1250000E-01	2.2306000E-01	9.4025000E-01
7.0440000E+02	7.1329000E-01	3.1274000E-01	2.2307000E-01	9.4031000E-01
7.0450000E+02	7.1292000E-01	3.1298000E-01	2.2313000E-01	9.4055000E-01
7.0460000E+02	7.1270000E-01	3.1322000E-01	2.2323000E-01	9.4098000E-01
7.0470000E+02	7.1263000E-01	3.1346000E-01	2.2338000E-01	9.4161000E-01
7.0480000E+02	7.1272000E-01	3.1370000E-01	2.2358000E-01	9.4245000E-01
7.0490000E+02	7.1299000E-01	3.1394000E-01	2.2384000E-01	9.4353000E-01
7.0500000E+02	7.1346000E-01	3.1418000E-01	2.2415000E-01	9.4486000E-01
7.0510000E+02	7.1412000E-01	3.1442000E-01	2.2453000E-01	9.4646000E-01
7.0520000E+02	7.1500000E-01	3.1466000E-01	2.2498000E-01	9.4835000E-01
7.0530000E+02	7.1611000E-01	3.1490000E-01	2.2550000E-01	9.5055000E-01
7.0540000E+02	7.1744000E-01	3.1514000E-01	2.2610000E-01	9.5305000E-01
7.0550000E+02	7.1901000E-01	3.1538000E-01	2.2676000E-01	9.5585000E-01
7.0560000E+02	7.2079000E-01	3.1562000E-01	2.2750000E-01	9.5896000E-01
7.0570000E+02	7.2278000E-01	3.1586000E-01	2.2830000E-01	9.6233000E-01
7.0580000E+02	7.2494000E-01	3.1610000E-01	2.2916000E-01	9.6594000E-01
7.0590000E+02	7.2725000E-01	3.1634000E-01	2.3006000E-01	9.6975000E-01
7.0600000E+02	7.2965000E-01	3.1658000E-01	2.3100000E-01	9.7370000E-01
7.0610000E+02	7.3210000E-01	3.1680000E-01	2.3193000E-01	9.7763000E-01
7.0620000E+02	7.3454000E-01	3.1701000E-01	2.3286000E-01	9.8155000E-01
7.0630000E+02	7.3689000E-01	3.1723000E-01	2.3376000E-01	9.8536000E-01
7.0640000E+02	7.3908000E-01	3.1744000E-01	2.3462000E-01	9.8896000E-01
7.0650000E+02	7.4104000E-01	3.1766000E-01	2.3540000E-01	9.9225000E-01
7.0660000E+02	7.4268000E-01	3.1787000E-01	2.3608000E-01	9.9512000E-01
7.0670000E+02	7.4392000E-01	3.1808000E-01	2.3663000E-01	9.9744000E-01
7.0680000E+02	7.4466000E-01	3.1830000E-01	2.3702000E-01	9.9911000E-01
7.0690000E+02	7.4482000E-01	3.1851000E-01	2.3723000E-01	1.0000000E+00
7.0700000E+02	7.4432000E-01	3.1873000E-01	2.3723000E-01	9.9999000E-01
7.0710000E+02	7.4306000E-01	3.1894000E-01	2.3699000E-01	9.9898000E-01
7.0720000E+02	7.4097000E-01	3.1916000E-01	2.3649000E-01	9.9684000E-01
7.0730000E+02	7.3797000E-01	3.1938000E-01	2.3569000E-01	9.9348000E-01
7.0740000E+02	7.3399000E-01	3.1959000E-01	2.3458000E-01	9.8880000E-01
7.0750000E+02	7.2898000E-01	3.1981000E-01	2.3313000E-01	9.8271000E-01
7.0760000E+02	7.2288000E-01	3.2002000E-01	2.3134000E-01	9.7515000E-01

7.0770000E+02	7.1566000E-01	3.2024000E-01	2.2918000E-01	9.6606000E-01
7.0780000E+02	7.0727000E-01	3.2046000E-01	2.2665000E-01	9.5539000E-01
7.0790000E+02	6.9772000E-01	3.2067000E-01	2.2374000E-01	9.4312000E-01
7.0800000E+02	6.8699000E-01	3.2089000E-01	2.2045000E-01	9.2925000E-01
7.0810000E+02	6.7511000E-01	3.2103000E-01	2.1673000E-01	9.1357000E-01
7.0820000E+02	6.6209000E-01	3.2117000E-01	2.1264000E-01	8.9634000E-01
7.0830000E+02	6.4797000E-01	3.2131000E-01	2.0820000E-01	8.7762000E-01
7.0840000E+02	6.3282000E-01	3.2145000E-01	2.0342000E-01	8.5747000E-01
7.0850000E+02	6.1668000E-01	3.2160000E-01	1.9832000E-01	8.3598000E-01
7.0860000E+02	5.9965000E-01	3.2174000E-01	1.9293000E-01	8.1324000E-01
7.0870000E+02	5.8179000E-01	3.2188000E-01	1.8727000E-01	7.8937000E-01
7.0880000E+02	5.6321000E-01	3.2202000E-01	1.8136000E-01	7.6449000E-01
7.0890000E+02	5.4399000E-01	3.2216000E-01	1.7525000E-01	7.3872000E-01
7.0900000E+02	5.2423000E-01	3.2230000E-01	1.6896000E-01	7.1221000E-01
7.0910000E+02	5.0404000E-01	3.2244000E-01	1.6252000E-01	6.8507000E-01
7.0920000E+02	4.8352000E-01	3.2258000E-01	1.5597000E-01	6.5746000E-01
7.0930000E+02	4.6277000E-01	3.2272000E-01	1.4934000E-01	6.2952000E-01
7.0940000E+02	4.4189000E-01	3.2286000E-01	1.4267000E-01	6.0137000E-01
7.0950000E+02	4.2099000E-01	3.2299000E-01	1.3598000E-01	5.7317000E-01
7.0960000E+02	4.0015000E-01	3.2313000E-01	1.2930000E-01	5.4504000E-01
7.0970000E+02	3.7949000E-01	3.2327000E-01	1.2268000E-01	5.1711000E-01
7.0980000E+02	3.5908000E-01	3.2341000E-01	1.1613000E-01	4.8952000E-01
7.0990000E+02	3.3903000E-01	3.2355000E-01	1.0969000E-01	4.6238000E-01
7.1000000E+02	3.1942000E-01	3.2368000E-01	1.0339000E-01	4.3582000E-01
7.1010000E+02	3.0034000E-01	3.2392000E-01	9.7288000E-02	4.1009000E-01
7.1020000E+02	2.8186000E-01	3.2416000E-01	9.1370000E-02	3.8514000E-01
7.1030000E+02	2.6406000E-01	3.2440000E-01	8.5662000E-02	3.6109000E-01
7.1040000E+02	2.4700000E-01	3.2465000E-01	8.0187000E-02	3.3801000E-01
7.1050000E+02	2.3073000E-01	3.2489000E-01	7.4962000E-02	3.1598000E-01
7.1060000E+02	2.1531000E-01	3.2513000E-01	7.0003000E-02	2.9508000E-01
7.1070000E+02	2.0076000E-01	3.2537000E-01	6.5320000E-02	2.7534000E-01
7.1080000E+02	1.8709000E-01	3.2561000E-01	6.0919000E-02	2.5679000E-01
7.1090000E+02	1.7432000E-01	3.2585000E-01	5.6803000E-02	2.3944000E-01
7.1100000E+02	1.6243000E-01	3.2609000E-01	5.2967000E-02	2.2327000E-01
7.1110000E+02	1.5139000E-01	3.2633000E-01	4.9404000E-02	2.0825000E-01
7.1120000E+02	1.4117000E-01	3.2656000E-01	4.6101000E-02	1.9433000E-01
7.1130000E+02	1.3171000E-01	3.2680000E-01	4.3042000E-02	1.8143000E-01
7.1140000E+02	1.2295000E-01	3.2704000E-01	4.0208000E-02	1.6949000E-01
7.1150000E+02	1.1482000E-01	3.2727000E-01	3.7577000E-02	1.5840000E-01
7.1160000E+02	1.0726000E-01	3.2751000E-01	3.5128000E-02	1.4807000E-01
7.1170000E+02	1.0019000E-01	3.2775000E-01	3.2837000E-02	1.3841000E-01
7.1180000E+02	9.3549000E-02	3.2799000E-01	3.0683000E-02	1.2934000E-01
7.1190000E+02	8.7283000E-02	3.2823000E-01	2.8648000E-02	1.2076000E-01

7.1200000E+02	8.1339000E-02	3.2847000E-01	2.6717000E-02	1.1262000E-01
7.1210000E+02	7.5682000E-02	3.2868000E-01	2.4875000E-02	1.0486000E-01
7.1220000E+02	7.0288000E-02	3.2890000E-01	2.3118000E-02	9.7447000E-02
7.1230000E+02	6.5146000E-02	3.2912000E-01	2.1441000E-02	9.0378000E-02
7.1240000E+02	6.0258000E-02	3.2933000E-01	1.9845000E-02	8.3652000E-02
7.1250000E+02	5.5634000E-02	3.2955000E-01	1.8334000E-02	7.7283000E-02
7.1260000E+02	5.1293000E-02	3.2977000E-01	1.6915000E-02	7.1300000E-02
7.1270000E+02	4.7258000E-02	3.2999000E-01	1.5594000E-02	6.5734000E-02
7.1280000E+02	4.3553000E-02	3.3020000E-01	1.4381000E-02	6.0620000E-02
7.1290000E+02	4.0199000E-02	3.3042000E-01	1.3283000E-02	5.5989000E-02
7.1300000E+02	3.7211000E-02	3.3064000E-01	1.2303000E-02	5.1862000E-02
7.1310000E+02	3.4596000E-02	3.3086000E-01	1.1447000E-02	4.8250000E-02
7.1320000E+02	3.2351000E-02	3.3108000E-01	1.0711000E-02	4.5149000E-02
7.1330000E+02	3.0459000E-02	3.3131000E-01	1.0091000E-02	4.2537000E-02
7.1340000E+02	2.8893000E-02	3.3153000E-01	9.5790000E-03	4.0378000E-02
7.1350000E+02	2.7615000E-02	3.3175000E-01	9.1612000E-03	3.8617000E-02
7.1360000E+02	2.6576000E-02	3.3198000E-01	8.8225000E-03	3.7189000E-02
7.1370000E+02	2.5723000E-02	3.3220000E-01	8.5451000E-03	3.6019000E-02
7.1380000E+02	2.4999000E-02	3.3243000E-01	8.3104000E-03	3.5030000E-02
7.1390000E+02	2.4347000E-02	3.3267000E-01	8.0994000E-03	3.4141000E-02
7.1400000E+02	2.3715000E-02	3.3290000E-01	7.8948000E-03	3.3278000E-02
7.1410000E+02	2.3058000E-02	3.3307000E-01	7.6800000E-03	3.2373000E-02
7.1420000E+02	2.2341000E-02	3.3324000E-01	7.4449000E-03	3.1382000E-02
7.1430000E+02	2.1541000E-02	3.3341000E-01	7.1819000E-03	3.0273000E-02
7.1440000E+02	2.0648000E-02	3.3358000E-01	6.8877000E-03	2.9033000E-02
7.1450000E+02	1.9665000E-02	3.3375000E-01	6.5633000E-03	2.7666000E-02
7.1460000E+02	1.8609000E-02	3.3392000E-01	6.2139000E-03	2.6193000E-02
7.1470000E+02	1.7504000E-02	3.3409000E-01	5.8478000E-03	2.4650000E-02
7.1480000E+02	1.6383000E-02	3.3426000E-01	5.4761000E-03	2.3083000E-02
7.1490000E+02	1.5283000E-02	3.3443000E-01	5.1110000E-03	2.1544000E-02
7.1500000E+02	1.4241000E-02	3.3460000E-01	4.7650000E-03	2.0085000E-02
7.1510000E+02	1.3291000E-02	3.3477000E-01	4.4496000E-03	1.8756000E-02
7.1520000E+02	1.2463000E-02	3.3494000E-01	4.1743000E-03	1.7596000E-02
7.1530000E+02	1.1775000E-02	3.3511000E-01	3.9459000E-03	1.6633000E-02
7.1540000E+02	1.1236000E-02	3.3528000E-01	3.7673000E-03	1.5880000E-02
7.1550000E+02	1.0846000E-02	3.3546000E-01	3.6382000E-03	1.5336000E-02
7.1560000E+02	1.0590000E-02	3.3563000E-01	3.5543000E-03	1.4982000E-02
7.1570000E+02	1.0448000E-02	3.3580000E-01	3.5082000E-03	1.4788000E-02
7.1580000E+02	1.0388000E-02	3.3597000E-01	3.4901000E-03	1.4712000E-02
7.1590000E+02	1.0377000E-02	3.3614000E-01	3.4881000E-03	1.4703000E-02
7.1600000E+02	1.0378000E-02	3.3630000E-01	3.4901000E-03	1.4712000E-02
7.1610000E+02	1.0355000E-02	3.3639000E-01	3.4835000E-03	1.4684000E-02
7.1620000E+02	1.0279000E-02	3.3648000E-01	3.4588000E-03	1.4580000E-02

7.1630000E+02	1.0127000E-02	3.3656000E-01	3.4084000E-03	1.4367000E-02
7.1640000E+02	9.8845000E-03	3.3665000E-01	3.3276000E-03	1.4027000E-02
7.1650000E+02	9.5482000E-03	3.3673000E-01	3.2152000E-03	1.3553000E-02
7.1660000E+02	9.1257000E-03	3.3682000E-01	3.0737000E-03	1.2956000E-02
7.1670000E+02	8.6337000E-03	3.3691000E-01	2.9088000E-03	1.2261000E-02
7.1680000E+02	8.0976000E-03	3.3699000E-01	2.7288000E-03	1.1503000E-02
7.1690000E+02	7.5480000E-03	3.3708000E-01	2.5443000E-03	1.0725000E-02
7.1700000E+02	7.0186000E-03	3.3716000E-01	2.3664000E-03	9.9749000E-03
7.1710000E+02	6.5423000E-03	3.3724000E-01	2.2063000E-03	9.3002000E-03
7.1720000E+02	6.1486000E-03	3.3733000E-01	2.0741000E-03	8.7427000E-03
7.1730000E+02	5.8605000E-03	3.3741000E-01	1.9774000E-03	8.3351000E-03
7.1740000E+02	5.6923000E-03	3.3749000E-01	1.9211000E-03	8.0978000E-03
7.1750000E+02	6.9518000E-03	3.3757000E-01	2.3468000E-03	9.8921000E-03
7.1760000E+02	6.8088000E-03	3.3766000E-01	2.2991000E-03	9.6912000E-03
7.1770000E+02	6.6627000E-03	3.3777000E-01	2.2504000E-03	9.4860000E-03
7.1780000E+02	6.5115000E-03	3.3787000E-01	2.2000000E-03	9.2736000E-03
7.1790000E+02	6.3536000E-03	3.3797000E-01	2.1473000E-03	9.0515000E-03
7.1800000E+02	6.1879000E-03	3.3807000E-01	2.0920000E-03	8.8182000E-03
7.1810000E+02	6.0137000E-03	3.3833000E-01	2.0346000E-03	8.5762000E-03
7.1820000E+02	5.8306000E-03	3.3858000E-01	1.9741000E-03	8.3214000E-03
7.1830000E+02	5.6392000E-03	3.3883000E-01	1.9107000E-03	8.0542000E-03
7.1840000E+02	5.4405000E-03	3.3909000E-01	1.8448000E-03	7.7762000E-03
7.1850000E+02	5.2361000E-03	3.3934000E-01	1.7768000E-03	7.4897000E-03
7.1860000E+02	5.0284000E-03	3.3959000E-01	1.7076000E-03	7.1979000E-03
7.1870000E+02	4.8201000E-03	3.3985000E-01	1.6381000E-03	6.9049000E-03
7.1880000E+02	4.6146000E-03	3.4010000E-01	1.5694000E-03	6.6155000E-03
7.1890000E+02	4.4155000E-03	3.4035000E-01	1.5028000E-03	6.3348000E-03
7.1900000E+02	4.2267000E-03	3.4061000E-01	1.4397000E-03	6.0685000E-03
7.1910000E+02	4.0521000E-03	3.4086000E-01	1.3812000E-03	5.8220000E-03
7.1920000E+02	3.8953000E-03	3.4111000E-01	1.3287000E-03	5.6009000E-03
7.1930000E+02	3.7599000E-03	3.4136000E-01	1.2835000E-03	5.4102000E-03
7.1940000E+02	3.6488000E-03	3.4161000E-01	1.2465000E-03	5.2541000E-03
7.1950000E+02	0.0000000E+00	3.4187000E-01	0.0000000E+00	0.0000000E+00
Channel 5				
Wavenumber	HIRS Filter Transmittance	Optical Element Transmittance	Product of the HIRS Filter and Optical Element Transmittances	Normalized Value of Column 4
6.9980000E+02	0.0000000E+00	3.0157000E-01	0.0000000E+00	0.0000000E+00
6.9990000E+02	2.8992000E-03	3.0183000E-01	8.7507000E-04	3.1361000E-03
7.0000000E+02	2.8682000E-03	3.0209000E-01	8.6647000E-04	3.1053000E-03
7.0010000E+02	2.8673000E-03	3.0241000E-01	8.6711000E-04	3.1075000E-03
7.0020000E+02	2.9035000E-03	3.0272000E-01	8.7897000E-04	3.1501000E-03

7.0030000E+02	2.9831000E-03	3.0305000E-01	9.0402000E-04	3.2398000E-03
7.0040000E+02	3.1106000E-03	3.0337000E-01	9.4366000E-04	3.3819000E-03
7.0050000E+02	3.2882000E-03	3.0370000E-01	9.9860000E-04	3.5788000E-03
7.0060000E+02	3.5154000E-03	3.0402000E-01	1.0687000E-03	3.8302000E-03
7.0070000E+02	3.7897000E-03	3.0434000E-01	1.1534000E-03	4.1334000E-03
7.0080000E+02	4.1079000E-03	3.0467000E-01	1.2515000E-03	4.4852000E-03
7.0090000E+02	4.4676000E-03	3.0499000E-01	1.3626000E-03	4.8832000E-03
7.0100000E+02	4.8679000E-03	3.0531000E-01	1.4862000E-03	5.3264000E-03
7.0110000E+02	5.3089000E-03	3.0563000E-01	1.6226000E-03	5.8150000E-03
7.0120000E+02	5.7913000E-03	3.0595000E-01	1.7719000E-03	6.3501000E-03
7.0130000E+02	6.3163000E-03	3.0627000E-01	1.9345000E-03	6.9329000E-03
7.0140000E+02	6.8850000E-03	3.0659000E-01	2.1109000E-03	7.5649000E-03
7.0150000E+02	7.4982000E-03	3.0691000E-01	2.3013000E-03	8.2473000E-03
7.0160000E+02	8.1566000E-03	3.0723000E-01	2.5060000E-03	8.9808000E-03
7.0170000E+02	8.8602000E-03	3.0755000E-01	2.7249000E-03	9.7656000E-03
7.0180000E+02	9.6080000E-03	3.0786000E-01	2.9580000E-03	1.0601000E-02
7.0190000E+02	1.0398000E-02	3.0818000E-01	3.2045000E-03	1.1484000E-02
7.0200000E+02	1.1226000E-02	3.0850000E-01	3.4634000E-03	1.2412000E-02
7.0210000E+02	1.2088000E-02	3.0867000E-01	3.7312000E-03	1.3372000E-02
7.0220000E+02	1.2976000E-02	3.0884000E-01	4.0075000E-03	1.4362000E-02
7.0230000E+02	1.3884000E-02	3.0900000E-01	4.2902000E-03	1.5375000E-02
7.0240000E+02	1.5116000E-02	3.0917000E-01	4.6736000E-03	1.6749000E-02
7.0250000E+02	1.6141000E-02	3.0934000E-01	4.9931000E-03	1.7894000E-02
7.0260000E+02	1.7133000E-02	3.0951000E-01	5.3027000E-03	1.9004000E-02
7.0270000E+02	1.8087000E-02	3.0968000E-01	5.6012000E-03	2.0073000E-02
7.0280000E+02	1.9003000E-02	3.0984000E-01	5.8878000E-03	2.1101000E-02
7.0290000E+02	1.9879000E-02	3.1001000E-01	6.1627000E-03	2.2086000E-02
7.0300000E+02	2.0720000E-02	3.1018000E-01	6.4267000E-03	2.3032000E-02
7.0310000E+02	2.1529000E-02	3.1034000E-01	6.6813000E-03	2.3945000E-02
7.0320000E+02	2.2316000E-02	3.1050000E-01	6.9291000E-03	2.4833000E-02
7.0330000E+02	2.3091000E-02	3.1066000E-01	7.1734000E-03	2.5708000E-02
7.0340000E+02	2.3867000E-02	3.1082000E-01	7.4184000E-03	2.6586000E-02
7.0350000E+02	2.4661000E-02	3.1099000E-01	7.6691000E-03	2.7485000E-02
7.0360000E+02	2.5491000E-02	3.1115000E-01	7.9315000E-03	2.8425000E-02
7.0370000E+02	2.6380000E-02	3.1131000E-01	8.2122000E-03	2.9431000E-02
7.0380000E+02	2.7350000E-02	3.1147000E-01	8.5187000E-03	3.0529000E-02
7.0390000E+02	2.8428000E-02	3.1163000E-01	8.8590000E-03	3.1749000E-02
7.0400000E+02	2.9641000E-02	3.1179000E-01	9.2420000E-03	3.3121000E-02
7.0410000E+02	3.1020000E-02	3.1202000E-01	9.6789000E-03	3.4687000E-02
7.0420000E+02	3.2594000E-02	3.1226000E-01	1.0178000E-02	3.6476000E-02
7.0430000E+02	3.4397000E-02	3.1250000E-01	1.0749000E-02	3.8523000E-02
7.0440000E+02	3.6461000E-02	3.1274000E-01	1.1403000E-02	4.0866000E-02
7.0450000E+02	3.8821000E-02	3.1298000E-01	1.2150000E-02	4.3544000E-02

7.0460000E+02	4.1513000E-02	3.1322000E-01	1.3003000E-02	4.6599000E-02
7.0470000E+02	4.4571000E-02	3.1346000E-01	1.3971000E-02	5.0070000E-02
7.0480000E+02	4.8032000E-02	3.1370000E-01	1.5068000E-02	5.4000000E-02
7.0490000E+02	5.1932000E-02	3.1394000E-01	1.6304000E-02	5.8429000E-02
7.0500000E+02	5.6307000E-02	3.1418000E-01	1.7691000E-02	6.3400000E-02
7.0510000E+02	6.1192000E-02	3.1442000E-01	1.9240000E-02	6.8953000E-02
7.0520000E+02	6.6621000E-02	3.1466000E-01	2.0963000E-02	7.5127000E-02
7.0530000E+02	7.2626000E-02	3.1490000E-01	2.2870000E-02	8.1961000E-02
7.0540000E+02	7.9236000E-02	3.1514000E-01	2.4971000E-02	8.9490000E-02
7.0550000E+02	8.6480000E-02	3.1538000E-01	2.7274000E-02	9.7745000E-02
7.0560000E+02	9.4381000E-02	3.1562000E-01	2.9789000E-02	1.0676000E-01
7.0570000E+02	1.0296000E-01	3.1586000E-01	3.2521000E-02	1.1655000E-01
7.0580000E+02	1.1224000E-01	3.1610000E-01	3.5478000E-02	1.2715000E-01
7.0590000E+02	1.2222000E-01	3.1634000E-01	3.8663000E-02	1.3856000E-01
7.0600000E+02	1.3292000E-01	3.1658000E-01	4.2079000E-02	1.5080000E-01
7.0610000E+02	1.4434000E-01	3.1680000E-01	4.5726000E-02	1.6387000E-01
7.0620000E+02	1.5647000E-01	3.1701000E-01	4.9604000E-02	1.7777000E-01
7.0630000E+02	1.6932000E-01	3.1723000E-01	5.3713000E-02	1.9250000E-01
7.0640000E+02	1.8287000E-01	3.1744000E-01	5.8050000E-02	2.0804000E-01
7.0650000E+02	1.9710000E-01	3.1766000E-01	6.2609000E-02	2.2438000E-01
7.0660000E+02	2.1199000E-01	3.1787000E-01	6.7384000E-02	2.4149000E-01
7.0670000E+02	2.2751000E-01	3.1808000E-01	7.2366000E-02	2.5935000E-01
7.0680000E+02	2.4363000E-01	3.1830000E-01	7.7546000E-02	2.7791000E-01
7.0690000E+02	2.6031000E-01	3.1851000E-01	8.2912000E-02	2.9714000E-01
7.0700000E+02	2.7751000E-01	3.1873000E-01	8.8452000E-02	3.1699000E-01
7.0710000E+02	2.9519000E-01	3.1894000E-01	9.4150000E-02	3.3741000E-01
7.0720000E+02	3.1329000E-01	3.1916000E-01	9.9990000E-02	3.5835000E-01
7.0730000E+02	3.3176000E-01	3.1938000E-01	1.0596000E-01	3.7973000E-01
7.0740000E+02	3.5054000E-01	3.1959000E-01	1.1203000E-01	4.0149000E-01
7.0750000E+02	3.6957000E-01	3.1981000E-01	1.1819000E-01	4.2357000E-01
7.0760000E+02	3.8878000E-01	3.2002000E-01	1.2442000E-01	4.4589000E-01
7.0770000E+02	4.0811000E-01	3.2024000E-01	1.3070000E-01	4.6839000E-01
7.0780000E+02	4.2750000E-01	3.2046000E-01	1.3700000E-01	4.9097000E-01
7.0790000E+02	4.4688000E-01	3.2067000E-01	1.4330000E-01	5.1356000E-01
7.0800000E+02	4.6617000E-01	3.2089000E-01	1.4959000E-01	5.3609000E-01
7.0810000E+02	4.8530000E-01	3.2103000E-01	1.5580000E-01	5.5835000E-01
7.0820000E+02	5.0422000E-01	3.2117000E-01	1.6194000E-01	5.8037000E-01
7.0830000E+02	5.2285000E-01	3.2131000E-01	1.6800000E-01	6.0207000E-01
7.0840000E+02	5.4112000E-01	3.2145000E-01	1.7395000E-01	6.2339000E-01
7.0850000E+02	5.5898000E-01	3.2160000E-01	1.7977000E-01	6.4425000E-01
7.0860000E+02	5.7637000E-01	3.2174000E-01	1.8544000E-01	6.6458000E-01
7.0870000E+02	5.9322000E-01	3.2188000E-01	1.9094000E-01	6.8431000E-01
7.0880000E+02	6.0948000E-01	3.2202000E-01	1.9626000E-01	7.0337000E-01

7.0890000E+02	6.2510000E-01	3.2216000E-01	2.0138000E-01	7.2172000E-01
7.0900000E+02	6.4004000E-01	3.2230000E-01	2.0629000E-01	7.3929000E-01
7.0910000E+02	6.5425000E-01	3.2244000E-01	2.1096000E-01	7.5603000E-01
7.0920000E+02	6.6770000E-01	3.2258000E-01	2.1539000E-01	7.7190000E-01
7.0930000E+02	6.8035000E-01	3.2272000E-01	2.1956000E-01	7.8687000E-01
7.0940000E+02	6.9219000E-01	3.2286000E-01	2.2348000E-01	8.0090000E-01
7.0950000E+02	7.0318000E-01	3.2299000E-01	2.2712000E-01	8.1397000E-01
7.0960000E+02	7.1332000E-01	3.2313000E-01	2.3050000E-01	8.2606000E-01
7.0970000E+02	7.2260000E-01	3.2327000E-01	2.3360000E-01	8.3716000E-01
7.0980000E+02	7.3101000E-01	3.2341000E-01	2.3642000E-01	8.4727000E-01
7.0990000E+02	7.3855000E-01	3.2355000E-01	2.3896000E-01	8.5637000E-01
7.1000000E+02	7.4523000E-01	3.2368000E-01	2.4122000E-01	8.6448000E-01
7.1010000E+02	7.5106000E-01	3.2392000E-01	2.4329000E-01	8.7189000E-01
7.1020000E+02	7.5606000E-01	3.2416000E-01	2.4509000E-01	8.7835000E-01
7.1030000E+02	7.6026000E-01	3.2440000E-01	2.4663000E-01	8.8388000E-01
7.1040000E+02	7.6367000E-01	3.2465000E-01	2.4792000E-01	8.8850000E-01
7.1050000E+02	7.6633000E-01	3.2489000E-01	2.4897000E-01	8.9226000E-01
7.1060000E+02	7.6827000E-01	3.2513000E-01	2.4979000E-01	8.9519000E-01
7.1070000E+02	7.6954000E-01	3.2537000E-01	2.5038000E-01	8.9732000E-01
7.1080000E+02	7.7016000E-01	3.2561000E-01	2.5077000E-01	8.9872000E-01
7.1090000E+02	7.7019000E-01	3.2585000E-01	2.5097000E-01	8.9942000E-01
7.1100000E+02	7.6967000E-01	3.2609000E-01	2.5098000E-01	8.9947000E-01
7.1110000E+02	7.6865000E-01	3.2633000E-01	2.5083000E-01	8.9893000E-01
7.1120000E+02	7.6717000E-01	3.2656000E-01	2.5053000E-01	8.9785000E-01
7.1130000E+02	7.6529000E-01	3.2680000E-01	2.5010000E-01	8.9629000E-01
7.1140000E+02	7.6305000E-01	3.2704000E-01	2.4954000E-01	8.9432000E-01
7.1150000E+02	7.6050000E-01	3.2727000E-01	2.4889000E-01	8.9198000E-01
7.1160000E+02	7.5770000E-01	3.2751000E-01	2.4815000E-01	8.8934000E-01
7.1170000E+02	7.5468000E-01	3.2775000E-01	2.4735000E-01	8.8644000E-01
7.1180000E+02	7.5151000E-01	3.2799000E-01	2.4648000E-01	8.8335000E-01
7.1190000E+02	7.4822000E-01	3.2823000E-01	2.4558000E-01	8.8012000E-01
7.1200000E+02	7.4485000E-01	3.2847000E-01	2.4466000E-01	8.7681000E-01
7.1210000E+02	7.4146000E-01	3.2868000E-01	2.4370000E-01	8.7339000E-01
7.1220000E+02	7.3807000E-01	3.2890000E-01	2.4275000E-01	8.6997000E-01
7.1230000E+02	7.3472000E-01	3.2912000E-01	2.4181000E-01	8.6660000E-01
7.1240000E+02	7.3146000E-01	3.2933000E-01	2.4089000E-01	8.6332000E-01
7.1250000E+02	7.2830000E-01	3.2955000E-01	2.4001000E-01	8.6016000E-01
7.1260000E+02	7.2529000E-01	3.2977000E-01	2.3918000E-01	8.5716000E-01
7.1270000E+02	7.2243000E-01	3.2999000E-01	2.3839000E-01	8.5435000E-01
7.1280000E+02	7.1976000E-01	3.3020000E-01	2.3767000E-01	8.5176000E-01
7.1290000E+02	7.1729000E-01	3.3042000E-01	2.3701000E-01	8.4940000E-01
7.1300000E+02	7.1504000E-01	3.3064000E-01	2.3642000E-01	8.4729000E-01
7.1310000E+02	7.1303000E-01	3.3086000E-01	2.3591000E-01	8.4547000E-01

7.1320000E+02	7.1125000E-01	3.3108000E-01	2.3548000E-01	8.4393000E-01
7.1330000E+02	7.0972000E-01	3.3131000E-01	2.3514000E-01	8.4268000E-01
7.1340000E+02	7.0844000E-01	3.3153000E-01	2.3487000E-01	8.4173000E-01
7.1350000E+02	7.0742000E-01	3.3175000E-01	2.3469000E-01	8.4107000E-01
7.1360000E+02	7.0665000E-01	3.3198000E-01	2.3459000E-01	8.4072000E-01
7.1370000E+02	7.0613000E-01	3.3220000E-01	2.3457000E-01	8.4067000E-01
7.1380000E+02	7.0585000E-01	3.3243000E-01	2.3465000E-01	8.4093000E-01
7.1390000E+02	7.0580000E-01	3.3267000E-01	2.3480000E-01	8.4147000E-01
7.1400000E+02	7.0599000E-01	3.3290000E-01	2.3503000E-01	8.4229000E-01
7.1410000E+02	7.0639000E-01	3.3307000E-01	2.3528000E-01	8.4320000E-01
7.1420000E+02	7.0700000E-01	3.3324000E-01	2.3560000E-01	8.4436000E-01
7.1430000E+02	7.0781000E-01	3.3341000E-01	2.3599000E-01	8.4575000E-01
7.1440000E+02	7.0879000E-01	3.3358000E-01	2.3644000E-01	8.4736000E-01
7.1450000E+02	7.0994000E-01	3.3375000E-01	2.3694000E-01	8.4916000E-01
7.1460000E+02	7.1125000E-01	3.3392000E-01	2.3750000E-01	8.5115000E-01
7.1470000E+02	7.1269000E-01	3.3409000E-01	2.3810000E-01	8.5331000E-01
7.1480000E+02	7.1425000E-01	3.3426000E-01	2.3875000E-01	8.5562000E-01
7.1490000E+02	7.1593000E-01	3.3443000E-01	2.3943000E-01	8.5806000E-01
7.1500000E+02	7.1770000E-01	3.3460000E-01	2.4014000E-01	8.6062000E-01
7.1510000E+02	7.1955000E-01	3.3477000E-01	2.4088000E-01	8.6328000E-01
7.1520000E+02	7.2147000E-01	3.3494000E-01	2.4165000E-01	8.6603000E-01
7.1530000E+02	7.2344000E-01	3.3511000E-01	2.4244000E-01	8.6884000E-01
7.1540000E+02	7.2546000E-01	3.3528000E-01	2.4324000E-01	8.7171000E-01
7.1550000E+02	7.2752000E-01	3.3546000E-01	2.4405000E-01	8.7463000E-01
7.1560000E+02	7.2959000E-01	3.3563000E-01	2.4487000E-01	8.7757000E-01
7.1570000E+02	7.3168000E-01	3.3580000E-01	2.4570000E-01	8.8053000E-01
7.1580000E+02	7.3378000E-01	3.3597000E-01	2.4653000E-01	8.8350000E-01
7.1590000E+02	7.3588000E-01	3.3614000E-01	2.4735000E-01	8.8647000E-01
7.1600000E+02	7.3796000E-01	3.3630000E-01	2.4818000E-01	8.8943000E-01
7.1610000E+02	7.4004000E-01	3.3639000E-01	2.4894000E-01	8.9216000E-01
7.1620000E+02	7.4209000E-01	3.3648000E-01	2.4970000E-01	8.9487000E-01
7.1630000E+02	7.4413000E-01	3.3656000E-01	2.5045000E-01	8.9755000E-01
7.1640000E+02	7.4614000E-01	3.3665000E-01	2.5119000E-01	9.0021000E-01
7.1650000E+02	7.4813000E-01	3.3673000E-01	2.5192000E-01	9.0283000E-01
7.1660000E+02	7.5009000E-01	3.3682000E-01	2.5264000E-01	9.0543000E-01
7.1670000E+02	7.5202000E-01	3.3691000E-01	2.5336000E-01	9.0799000E-01
7.1680000E+02	7.5392000E-01	3.3699000E-01	2.5406000E-01	9.1052000E-01
7.1690000E+02	7.5580000E-01	3.3708000E-01	2.5476000E-01	9.1302000E-01
7.1700000E+02	7.5765000E-01	3.3716000E-01	2.5545000E-01	9.1549000E-01
7.1710000E+02	7.5948000E-01	3.3724000E-01	2.5613000E-01	9.1792000E-01
7.1720000E+02	7.6129000E-01	3.3733000E-01	2.5680000E-01	9.2033000E-01
7.1730000E+02	7.6307000E-01	3.3741000E-01	2.5747000E-01	9.2271000E-01
7.1740000E+02	7.6484000E-01	3.3749000E-01	2.5813000E-01	9.2508000E-01

7.1750000E+02	7.6660000E-01	3.3757000E-01	2.5878000E-01	9.2743000E-01
7.1760000E+02	7.6834000E-01	3.3766000E-01	2.5944000E-01	9.2979000E-01
7.1770000E+02	7.7008000E-01	3.3777000E-01	2.6011000E-01	9.3217000E-01
7.1780000E+02	7.7181000E-01	3.3787000E-01	2.6077000E-01	9.3455000E-01
7.1790000E+02	7.7353000E-01	3.3797000E-01	2.6143000E-01	9.3692000E-01
7.1800000E+02	7.7526000E-01	3.3807000E-01	2.6209000E-01	9.3929000E-01
7.1810000E+02	7.7698000E-01	3.3833000E-01	2.6287000E-01	9.4209000E-01
7.1820000E+02	7.7871000E-01	3.3858000E-01	2.6365000E-01	9.4489000E-01
7.1830000E+02	7.8044000E-01	3.3883000E-01	2.6444000E-01	9.4770000E-01
7.1840000E+02	7.8218000E-01	3.3909000E-01	2.6522000E-01	9.5051000E-01
7.1850000E+02	7.8391000E-01	3.3934000E-01	2.6601000E-01	9.5334000E-01
7.1860000E+02	7.8566000E-01	3.3959000E-01	2.6680000E-01	9.5617000E-01
7.1870000E+02	7.8740000E-01	3.3985000E-01	2.6759000E-01	9.5900000E-01
7.1880000E+02	7.8914000E-01	3.4010000E-01	2.6839000E-01	9.6184000E-01
7.1890000E+02	7.9087000E-01	3.4035000E-01	2.6918000E-01	9.6467000E-01
7.1900000E+02	7.9260000E-01	3.4061000E-01	2.6996000E-01	9.6750000E-01
7.1910000E+02	7.9431000E-01	3.4086000E-01	2.7075000E-01	9.7030000E-01
7.1920000E+02	7.9600000E-01	3.4111000E-01	2.7152000E-01	9.7308000E-01
7.1930000E+02	7.9766000E-01	3.4136000E-01	2.7229000E-01	9.7583000E-01
7.1940000E+02	7.9928000E-01	3.4161000E-01	2.7304000E-01	9.7854000E-01
7.1950000E+02	8.0086000E-01	3.4187000E-01	2.7379000E-01	9.8120000E-01
7.1960000E+02	8.0237000E-01	3.4216000E-01	2.7454000E-01	9.8389000E-01
7.1970000E+02	8.0381000E-01	3.4245000E-01	2.7527000E-01	9.8650000E-01
7.1980000E+02	8.0517000E-01	3.4274000E-01	2.7596000E-01	9.8900000E-01
7.1990000E+02	8.0642000E-01	3.4303000E-01	2.7663000E-01	9.9139000E-01
7.2000000E+02	8.0756000E-01	3.4332000E-01	2.7726000E-01	9.9363000E-01
7.2010000E+02	8.0856000E-01	3.4345000E-01	2.7770000E-01	9.9523000E-01
7.2020000E+02	8.0941000E-01	3.4358000E-01	2.7810000E-01	9.9665000E-01
7.2030000E+02	8.1009000E-01	3.4371000E-01	2.7843000E-01	9.9785000E-01
7.2040000E+02	8.1057000E-01	3.4384000E-01	2.7870000E-01	9.9882000E-01
7.2050000E+02	8.1084000E-01	3.4396000E-01	2.7890000E-01	9.9951000E-01
7.2060000E+02	8.1086000E-01	3.4409000E-01	2.7901000E-01	9.9992000E-01
7.2070000E+02	8.1063000E-01	3.4422000E-01	2.7903000E-01	1.0000000E+00
7.2080000E+02	8.1011000E-01	3.4435000E-01	2.7896000E-01	9.9973000E-01
7.2090000E+02	8.0928000E-01	3.4447000E-01	2.7877000E-01	9.9907000E-01
7.2100000E+02	8.0811000E-01	3.4460000E-01	2.7848000E-01	9.9801000E-01
7.2110000E+02	8.0659000E-01	3.4473000E-01	2.7805000E-01	9.9649000E-01
7.2120000E+02	8.0468000E-01	3.4485000E-01	2.7750000E-01	9.9449000E-01
7.2130000E+02	8.0236000E-01	3.4498000E-01	2.7680000E-01	9.9199000E-01
7.2140000E+02	7.9961000E-01	3.4511000E-01	2.7595000E-01	9.8895000E-01
7.2150000E+02	7.9639000E-01	3.4525000E-01	2.7496000E-01	9.8539000E-01
7.2160000E+02	7.9270000E-01	3.4540000E-01	2.7380000E-01	9.8124000E-01
7.2170000E+02	7.8851000E-01	3.4555000E-01	2.7247000E-01	9.7647000E-01

7.2180000E+02	7.8379000E-01	3.4570000E-01	2.7095000E-01	9.7105000E-01
7.2190000E+02	7.7853000E-01	3.4584000E-01	2.6925000E-01	9.6494000E-01
7.2200000E+02	7.7271000E-01	3.4599000E-01	2.6735000E-01	9.5814000E-01
7.2210000E+02	7.6632000E-01	3.4610000E-01	2.6523000E-01	9.5052000E-01
7.2220000E+02	7.5933000E-01	3.4622000E-01	2.6289000E-01	9.4216000E-01
7.2230000E+02	7.5175000E-01	3.4633000E-01	2.6035000E-01	9.3305000E-01
7.2240000E+02	7.4356000E-01	3.4644000E-01	2.5760000E-01	9.2318000E-01
7.2250000E+02	7.3475000E-01	3.4655000E-01	2.5463000E-01	9.1254000E-01
7.2260000E+02	7.2533000E-01	3.4666000E-01	2.5144000E-01	9.0112000E-01
7.2270000E+02	7.1529000E-01	3.4677000E-01	2.4804000E-01	8.8893000E-01
7.2280000E+02	7.0464000E-01	3.4688000E-01	2.4443000E-01	8.7597000E-01
7.2290000E+02	6.9337000E-01	3.4699000E-01	2.4060000E-01	8.6225000E-01
7.2300000E+02	6.8151000E-01	3.4710000E-01	2.3656000E-01	8.4777000E-01
7.2310000E+02	6.6907000E-01	3.4721000E-01	2.3231000E-01	8.3255000E-01
7.2320000E+02	6.5605000E-01	3.4733000E-01	2.2786000E-01	8.1662000E-01
7.2330000E+02	6.4249000E-01	3.4744000E-01	2.2322000E-01	7.9999000E-01
7.2340000E+02	6.2840000E-01	3.4756000E-01	2.1840000E-01	7.8271000E-01
7.2350000E+02	6.1380000E-01	3.4768000E-01	2.1341000E-01	7.6482000E-01
7.2360000E+02	5.9874000E-01	3.4781000E-01	2.0825000E-01	7.4632000E-01
7.2370000E+02	5.8323000E-01	3.4794000E-01	2.0293000E-01	7.2725000E-01
7.2380000E+02	5.6732000E-01	3.4806000E-01	1.9746000E-01	7.0767000E-01
7.2390000E+02	5.5104000E-01	3.4819000E-01	1.9187000E-01	6.8762000E-01
7.2400000E+02	5.3443000E-01	3.4832000E-01	1.8615000E-01	6.6714000E-01
7.2410000E+02	5.1754000E-01	3.4854000E-01	1.8038000E-01	6.4646000E-01
7.2420000E+02	5.0040000E-01	3.4876000E-01	1.7452000E-01	6.2544000E-01
7.2430000E+02	4.8307000E-01	3.4898000E-01	1.6858000E-01	6.0416000E-01
7.2440000E+02	4.6558000E-01	3.4920000E-01	1.6258000E-01	5.8266000E-01
7.2450000E+02	4.4799000E-01	3.4942000E-01	1.5654000E-01	5.6100000E-01
7.2460000E+02	4.3034000E-01	3.4964000E-01	1.5047000E-01	5.3925000E-01
7.2470000E+02	4.1269000E-01	3.4986000E-01	1.4439000E-01	5.1746000E-01
7.2480000E+02	3.9509000E-01	3.5009000E-01	1.3831000E-01	4.9569000E-01
7.2490000E+02	3.7757000E-01	3.5031000E-01	1.3226000E-01	4.7401000E-01
7.2500000E+02	3.6019000E-01	3.5053000E-01	1.2626000E-01	4.5247000E-01
7.2510000E+02	3.4299000E-01	3.5075000E-01	1.2030000E-01	4.3114000E-01
7.2520000E+02	3.2603000E-01	3.5097000E-01	1.1443000E-01	4.1008000E-01
7.2530000E+02	3.0934000E-01	3.5119000E-01	1.0864000E-01	3.8933000E-01
7.2540000E+02	2.9296000E-01	3.5142000E-01	1.0295000E-01	3.6896000E-01
7.2550000E+02	2.7694000E-01	3.5165000E-01	9.7387000E-02	3.4901000E-01
7.2560000E+02	2.6132000E-01	3.5187000E-01	9.1952000E-02	3.2954000E-01
7.2570000E+02	2.4612000E-01	3.5210000E-01	8.6660000E-02	3.1057000E-01
7.2580000E+02	2.3138000E-01	3.5233000E-01	8.1524000E-02	2.9217000E-01
7.2590000E+02	2.1713000E-01	3.5256000E-01	7.6553000E-02	2.7435000E-01
7.2600000E+02	2.0340000E-01	3.5279000E-01	7.1756000E-02	2.5716000E-01

7.2610000E+02	1.9020000E-01	3.5303000E-01	6.7146000E-02	2.4064000E-01
7.2620000E+02	1.7755000E-01	3.5328000E-01	6.2724000E-02	2.2479000E-01
7.2630000E+02	1.6547000E-01	3.5352000E-01	5.8498000E-02	2.0964000E-01
7.2640000E+02	1.5397000E-01	3.5377000E-01	5.4470000E-02	1.9521000E-01
7.2650000E+02	1.4306000E-01	3.5401000E-01	5.0644000E-02	1.8150000E-01
7.2660000E+02	1.3274000E-01	3.5426000E-01	4.7023000E-02	1.6852000E-01
7.2670000E+02	1.2301000E-01	3.5450000E-01	4.3606000E-02	1.5627000E-01
7.2680000E+02	1.1386000E-01	3.5475000E-01	4.0393000E-02	1.4476000E-01
7.2690000E+02	1.0530000E-01	3.5500000E-01	3.7381000E-02	1.3397000E-01
7.2700000E+02	9.7311000E-02	3.5524000E-01	3.4569000E-02	1.2389000E-01
7.2710000E+02	8.9880000E-02	3.5549000E-01	3.1951000E-02	1.1451000E-01
7.2720000E+02	8.2993000E-02	3.5573000E-01	2.9523000E-02	1.0581000E-01
7.2730000E+02	7.6632000E-02	3.5598000E-01	2.7279000E-02	9.7763000E-02
7.2740000E+02	7.0776000E-02	3.5623000E-01	2.5212000E-02	9.0355000E-02
7.2750000E+02	6.5403000E-02	3.5647000E-01	2.3315000E-02	8.3555000E-02
7.2760000E+02	6.0491000E-02	3.5672000E-01	2.1579000E-02	7.7333000E-02
7.2770000E+02	5.6015000E-02	3.5697000E-01	1.9995000E-02	7.1660000E-02
7.2780000E+02	5.1947000E-02	3.5722000E-01	1.8556000E-02	6.6502000E-02
7.2790000E+02	4.8263000E-02	3.5746000E-01	1.7252000E-02	6.1829000E-02
7.2800000E+02	4.4936000E-02	3.5771000E-01	1.6074000E-02	5.7606000E-02
7.2810000E+02	4.1939000E-02	3.5791000E-01	1.5010000E-02	5.3795000E-02
7.2820000E+02	3.9245000E-02	3.5812000E-01	1.4055000E-02	5.0369000E-02
7.2830000E+02	3.6830000E-02	3.5832000E-01	1.3197000E-02	4.7295000E-02
7.2840000E+02	3.4666000E-02	3.5853000E-01	1.2429000E-02	4.4543000E-02
7.2850000E+02	3.2731000E-02	3.5873000E-01	1.1742000E-02	4.2079000E-02
7.2860000E+02	3.0998000E-02	3.5894000E-01	1.1126000E-02	3.9875000E-02
7.2870000E+02	2.9445000E-02	3.5914000E-01	1.0575000E-02	3.7899000E-02
7.2880000E+02	2.8050000E-02	3.5935000E-01	1.0080000E-02	3.6123000E-02
7.2890000E+02	2.6790000E-02	3.5955000E-01	9.6322000E-03	3.4520000E-02
7.2900000E+02	2.5644000E-02	3.5975000E-01	9.2256000E-03	3.3063000E-02
7.2910000E+02	2.4594000E-02	3.5995000E-01	8.8527000E-03	3.1726000E-02
7.2920000E+02	2.3620000E-02	3.6015000E-01	8.5069000E-03	3.0487000E-02
7.2930000E+02	2.2707000E-02	3.6034000E-01	8.1822000E-03	2.9323000E-02
7.2940000E+02	2.1838000E-02	3.6053000E-01	7.8733000E-03	2.8216000E-02
7.2950000E+02	2.1001000E-02	3.6072000E-01	7.5754000E-03	2.7149000E-02
7.2960000E+02	2.0183000E-02	3.6091000E-01	7.2843000E-03	2.6105000E-02
7.2970000E+02	1.9375000E-02	3.6111000E-01	6.9964000E-03	2.5074000E-02
7.2980000E+02	1.8570000E-02	3.6130000E-01	6.7091000E-03	2.4044000E-02
7.2990000E+02	1.7761000E-02	3.6149000E-01	6.4203000E-03	2.3009000E-02
7.3000000E+02	1.6957000E-02	3.6168000E-01	6.1331000E-03	2.1980000E-02
7.3010000E+02	1.6123000E-02	3.6178000E-01	5.8330000E-03	2.0904000E-02
7.3020000E+02	1.5308000E-02	3.6189000E-01	5.5399000E-03	1.9854000E-02
7.3030000E+02	1.4514000E-02	3.6199000E-01	5.2537000E-03	1.8828000E-02

7.3040000E+02	1.3738000E-02	3.6209000E-01	4.9746000E-03	1.7828000E-02
7.3050000E+02	1.2985000E-02	3.6219000E-01	4.7029000E-03	1.6854000E-02
7.3060000E+02	1.2253000E-02	3.6230000E-01	4.4393000E-03	1.5910000E-02
7.3070000E+02	1.1547000E-02	3.6240000E-01	4.1846000E-03	1.4997000E-02
7.3080000E+02	1.0867000E-02	3.6250000E-01	3.9394000E-03	1.4118000E-02
7.3090000E+02	1.0216000E-02	3.6261000E-01	3.7045000E-03	1.3276000E-02
7.3100000E+02	9.5955000E-03	3.6271000E-01	3.4804000E-03	1.2473000E-02
7.3110000E+02	9.0058000E-03	3.6281000E-01	3.2674000E-03	1.1710000E-02
7.3120000E+02	8.4479000E-03	3.6292000E-01	3.0659000E-03	1.0988000E-02
7.3130000E+02	7.9220000E-03	3.6303000E-01	2.8759000E-03	1.0307000E-02
7.3140000E+02	7.4278000E-03	3.6314000E-01	2.6973000E-03	9.6667000E-03
7.3150000E+02	6.9651000E-03	3.6324000E-01	2.5300000E-03	9.0671000E-03
7.3160000E+02	6.5332000E-03	3.6335000E-01	2.3738000E-03	8.5073000E-03
7.3170000E+02	6.1314000E-03	3.6346000E-01	2.2285000E-03	7.9865000E-03
7.3180000E+02	5.7592000E-03	3.6356000E-01	2.0938000E-03	7.5039000E-03
7.3190000E+02	5.4163000E-03	3.6367000E-01	1.9697000E-03	7.0592000E-03
7.3200000E+02	5.1026000E-03	3.6378000E-01	1.8562000E-03	6.6523000E-03
7.3210000E+02	4.8185000E-03	3.6404000E-01	1.7541000E-03	6.2864000E-03
7.3220000E+02	4.5648000E-03	3.6430000E-01	1.6630000E-03	5.9597000E-03
7.3230000E+02	4.3423000E-03	3.6456000E-01	1.5830000E-03	5.6732000E-03
7.3240000E+02	4.1515000E-03	3.6482000E-01	1.5145000E-03	5.4278000E-03
7.3250000E+02	3.9922000E-03	3.6508000E-01	1.4575000E-03	5.2233000E-03
7.3260000E+02	3.8636000E-03	3.6534000E-01	1.4115000E-03	5.0586000E-03
7.3270000E+02	3.7639000E-03	3.6560000E-01	1.3761000E-03	4.9316000E-03
7.3280000E+02	3.6909000E-03	3.6586000E-01	1.3503000E-03	4.8394000E-03
7.3290000E+02	3.6422000E-03	3.6612000E-01	1.3335000E-03	4.7789000E-03
7.3300000E+02	3.6152000E-03	3.6638000E-01	1.3245000E-03	4.7469000E-03
7.3310000E+02	3.6076000E-03	3.6665000E-01	1.3227000E-03	4.7404000E-03
7.3320000E+02	0.0000000E+00	3.6693000E-01	0.0000000E+00	0.0000000E+00
Channel 6				
Wavenumber	HIRS Filter Transmittance	Optical Element Transmittance	Product of the HIRS Filter and Optical Element Transmittances	Normalized Value of Column 4
7.1120000E+02	0.0000000E+00	3.2656000E-01	0.0000000E+00	0.0000000E+00
7.1130000E+02	3.3994000E-03	3.2680000E-01	1.1109000E-03	3.7949000E-03
7.1140000E+02	3.4382000E-03	3.2704000E-01	1.1244000E-03	3.8410000E-03
7.1150000E+02	3.5492000E-03	3.2727000E-01	1.1616000E-03	3.9678000E-03
7.1160000E+02	3.7288000E-03	3.2751000E-01	1.2212000E-03	4.1716000E-03
7.1170000E+02	3.9695000E-03	3.2775000E-01	1.3010000E-03	4.4442000E-03
7.1180000E+02	4.2606000E-03	3.2799000E-01	1.3974000E-03	4.7736000E-03
7.1190000E+02	4.5888000E-03	3.2823000E-01	1.5061000E-03	5.1450000E-03
7.1200000E+02	4.9386000E-03	3.2847000E-01	1.6222000E-03	5.5413000E-03

7.1210000E+02	5.2941000E-03	3.2868000E-01	1.7401000E-03	5.9441000E-03
7.1220000E+02	5.6394000E-03	3.2890000E-01	1.8548000E-03	6.3360000E-03
7.1230000E+02	5.9601000E-03	3.2912000E-01	1.9616000E-03	6.7006000E-03
7.1240000E+02	6.2438000E-03	3.2933000E-01	2.0563000E-03	7.0243000E-03
7.1250000E+02	6.4813000E-03	3.2955000E-01	2.1359000E-03	7.2963000E-03
7.1260000E+02	6.6665000E-03	3.2977000E-01	2.1984000E-03	7.5097000E-03
7.1270000E+02	6.7968000E-03	3.2999000E-01	2.2429000E-03	7.6616000E-03
7.1280000E+02	6.8734000E-03	3.3020000E-01	2.2696000E-03	7.7530000E-03
7.1290000E+02	6.9004000E-03	3.3042000E-01	2.2801000E-03	7.7886000E-03
7.1300000E+02	6.8853000E-03	3.3064000E-01	2.2766000E-03	7.7766000E-03
7.1310000E+02	6.8374000E-03	3.3086000E-01	2.2622000E-03	7.7278000E-03
7.1320000E+02	6.7679000E-03	3.3108000E-01	2.2408000E-03	7.6543000E-03
7.1330000E+02	6.6885000E-03	3.3131000E-01	2.2159000E-03	7.5696000E-03
7.1340000E+02	6.6107000E-03	3.3153000E-01	2.1916000E-03	7.4866000E-03
7.1350000E+02	6.5449000E-03	3.3175000E-01	2.1713000E-03	7.4170000E-03
7.1360000E+02	6.4997000E-03	3.3198000E-01	2.1577000E-03	7.3708000E-03
7.1370000E+02	6.4815000E-03	3.3220000E-01	2.1532000E-03	7.3551000E-03
7.1380000E+02	6.4938000E-03	3.3243000E-01	2.1588000E-03	7.3743000E-03
7.1390000E+02	6.5374000E-03	3.3267000E-01	2.1748000E-03	7.4290000E-03
7.1400000E+02	6.6103000E-03	3.3290000E-01	2.2006000E-03	7.5172000E-03
7.1410000E+02	6.7080000E-03	3.3307000E-01	2.2343000E-03	7.6322000E-03
7.1420000E+02	6.8241000E-03	3.3324000E-01	2.2741000E-03	7.7682000E-03
7.1430000E+02	6.9508000E-03	3.3341000E-01	2.3175000E-03	7.9164000E-03
7.1440000E+02	7.0797000E-03	3.3358000E-01	2.3617000E-03	8.0674000E-03
7.1450000E+02	7.2028000E-03	3.3375000E-01	2.4039000E-03	8.2118000E-03
7.1460000E+02	7.3129000E-03	3.3392000E-01	2.4419000E-03	8.3416000E-03
7.1470000E+02	7.4048000E-03	3.3409000E-01	2.4739000E-03	8.4506000E-03
7.1480000E+02	7.4753000E-03	3.3426000E-01	2.4987000E-03	8.5355000E-03
7.1490000E+02	7.5242000E-03	3.3443000E-01	2.5163000E-03	8.5957000E-03
7.1500000E+02	7.5540000E-03	3.3460000E-01	2.5276000E-03	8.6341000E-03
7.1510000E+02	7.5702000E-03	3.3477000E-01	2.5343000E-03	8.6571000E-03
7.1520000E+02	7.5810000E-03	3.3494000E-01	2.5392000E-03	8.6738000E-03
7.1530000E+02	7.5966000E-03	3.3511000E-01	2.5457000E-03	8.6961000E-03
7.1540000E+02	7.6290000E-03	3.3528000E-01	2.5579000E-03	8.7377000E-03
7.1550000E+02	7.6913000E-03	3.3546000E-01	2.5801000E-03	8.8135000E-03
7.1560000E+02	7.7965000E-03	3.3563000E-01	2.6167000E-03	8.9386000E-03
7.1570000E+02	7.9567000E-03	3.3580000E-01	2.6719000E-03	9.1270000E-03
7.1580000E+02	8.1830000E-03	3.3597000E-01	2.7492000E-03	9.3912000E-03
7.1590000E+02	8.4839000E-03	3.3614000E-01	2.8517000E-03	9.7414000E-03
7.1600000E+02	8.8653000E-03	3.3630000E-01	2.9814000E-03	1.0184000E-02
7.1610000E+02	9.3301000E-03	3.3639000E-01	3.1385000E-03	1.0721000E-02
7.1620000E+02	9.8780000E-03	3.3648000E-01	3.3237000E-03	1.1354000E-02
7.1630000E+02	1.0506000E-02	3.3656000E-01	3.5358000E-03	1.2078000E-02

7.1640000E+02	1.1206000E-02	3.3665000E-01	3.7726000E-03	1.2887000E-02
7.1650000E+02	1.1682000E-02	3.3673000E-01	3.9338000E-03	1.3438000E-02
7.1660000E+02	1.2577000E-02	3.3682000E-01	4.2363000E-03	1.4471000E-02
7.1670000E+02	1.3515000E-02	3.3691000E-01	4.5532000E-03	1.5554000E-02
7.1680000E+02	1.4479000E-02	3.3699000E-01	4.8792000E-03	1.6667000E-02
7.1690000E+02	1.5454000E-02	3.3708000E-01	5.2091000E-03	1.7794000E-02
7.1700000E+02	1.6426000E-02	3.3716000E-01	5.5384000E-03	1.8919000E-02
7.1710000E+02	1.7387000E-02	3.3724000E-01	5.8637000E-03	2.0030000E-02
7.1720000E+02	1.8329000E-02	3.3733000E-01	6.1828000E-03	2.1120000E-02
7.1730000E+02	1.9250000E-02	3.3741000E-01	6.4951000E-03	2.2187000E-02
7.1740000E+02	2.0153000E-02	3.3749000E-01	6.8016000E-03	2.3234000E-02
7.1750000E+02	2.1045000E-02	3.3757000E-01	7.1044000E-03	2.4268000E-02
7.1760000E+02	2.1938000E-02	3.3766000E-01	7.4076000E-03	2.5304000E-02
7.1770000E+02	2.2845000E-02	3.3777000E-01	7.7164000E-03	2.6359000E-02
7.1780000E+02	2.3785000E-02	3.3787000E-01	8.0362000E-03	2.7452000E-02
7.1790000E+02	2.4777000E-02	3.3797000E-01	8.3738000E-03	2.8605000E-02
7.1800000E+02	2.5840000E-02	3.3807000E-01	8.7358000E-03	2.9841000E-02
7.1810000E+02	2.6994000E-02	3.3833000E-01	9.1328000E-03	3.1197000E-02
7.1820000E+02	2.8258000E-02	3.3858000E-01	9.5674000E-03	3.2682000E-02
7.1830000E+02	2.9647000E-02	3.3883000E-01	1.0045000E-02	3.4314000E-02
7.1840000E+02	3.1174000E-02	3.3909000E-01	1.0571000E-02	3.6109000E-02
7.1850000E+02	3.2851000E-02	3.3934000E-01	1.1148000E-02	3.8080000E-02
7.1860000E+02	3.4686000E-02	3.3959000E-01	1.1779000E-02	4.0237000E-02
7.1870000E+02	3.6682000E-02	3.3985000E-01	1.2466000E-02	4.2585000E-02
7.1880000E+02	3.8845000E-02	3.4010000E-01	1.3211000E-02	4.5129000E-02
7.1890000E+02	4.1176000E-02	3.4035000E-01	1.4014000E-02	4.7873000E-02
7.1900000E+02	4.3677000E-02	3.4061000E-01	1.4877000E-02	5.0818000E-02
7.1910000E+02	4.6350000E-02	3.4086000E-01	1.5799000E-02	5.3968000E-02
7.1920000E+02	4.9200000E-02	3.4111000E-01	1.6782000E-02	5.7328000E-02
7.1930000E+02	5.2231000E-02	3.4136000E-01	1.7830000E-02	6.0905000E-02
7.1940000E+02	5.5452000E-02	3.4161000E-01	1.8943000E-02	6.4709000E-02
7.1950000E+02	5.8875000E-02	3.4187000E-01	2.0127000E-02	6.8754000E-02
7.1960000E+02	6.2514000E-02	3.4216000E-01	2.1390000E-02	7.3066000E-02
7.1970000E+02	6.6387000E-02	3.4245000E-01	2.2734000E-02	7.7659000E-02
7.1980000E+02	7.0515000E-02	3.4274000E-01	2.4168000E-02	8.2558000E-02
7.1990000E+02	7.4921000E-02	3.4303000E-01	2.5700000E-02	8.7792000E-02
7.2000000E+02	7.9631000E-02	3.4332000E-01	2.7339000E-02	9.3390000E-02
7.2010000E+02	8.4670000E-02	3.4345000E-01	2.9080000E-02	9.9337000E-02
7.2020000E+02	9.0063000E-02	3.4358000E-01	3.0944000E-02	1.0570000E-01
7.2030000E+02	9.5834000E-02	3.4371000E-01	3.2939000E-02	1.1252000E-01
7.2040000E+02	1.0200000E-01	3.4384000E-01	3.5072000E-02	1.1981000E-01
7.2050000E+02	1.0859000E-01	3.4396000E-01	3.7351000E-02	1.2759000E-01
7.2060000E+02	1.1561000E-01	3.4409000E-01	3.9779000E-02	1.3588000E-01

7.2070000E+02	1.2306000E-01	3.4422000E-01	4.2361000E-02	1.4470000E-01
7.2080000E+02	1.3097000E-01	3.4435000E-01	4.5098000E-02	1.5405000E-01
7.2090000E+02	1.3931000E-01	3.4447000E-01	4.7989000E-02	1.6393000E-01
7.2100000E+02	1.4810000E-01	3.4460000E-01	5.1034000E-02	1.7433000E-01
7.2110000E+02	1.5731000E-01	3.4473000E-01	5.4230000E-02	1.8525000E-01
7.2120000E+02	1.6695000E-01	3.4485000E-01	5.7573000E-02	1.9667000E-01
7.2130000E+02	1.7699000E-01	3.4498000E-01	6.1057000E-02	2.0857000E-01
7.2140000E+02	1.8742000E-01	3.4511000E-01	6.4678000E-02	2.2094000E-01
7.2150000E+02	1.9821000E-01	3.4525000E-01	6.8433000E-02	2.3377000E-01
7.2160000E+02	2.0937000E-01	3.4540000E-01	7.2315000E-02	2.4703000E-01
7.2170000E+02	2.2086000E-01	3.4555000E-01	7.6316000E-02	2.6069000E-01
7.2180000E+02	2.3267000E-01	3.4570000E-01	8.0432000E-02	2.7475000E-01
7.2190000E+02	2.4479000E-01	3.4584000E-01	8.4658000E-02	2.8919000E-01
7.2200000E+02	2.5720000E-01	3.4599000E-01	8.8988000E-02	3.0398000E-01
7.2210000E+02	2.6989000E-01	3.4610000E-01	9.3410000E-02	3.1909000E-01
7.2220000E+02	2.8285000E-01	3.4622000E-01	9.7927000E-02	3.3452000E-01
7.2230000E+02	2.9607000E-01	3.4633000E-01	1.0254000E-01	3.5026000E-01
7.2240000E+02	3.0952000E-01	3.4644000E-01	1.0723000E-01	3.6629000E-01
7.2250000E+02	3.2320000E-01	3.4655000E-01	1.1201000E-01	3.8261000E-01
7.2260000E+02	3.3709000E-01	3.4666000E-01	1.1685000E-01	3.9917000E-01
7.2270000E+02	3.5116000E-01	3.4677000E-01	1.2177000E-01	4.1597000E-01
7.2280000E+02	3.6538000E-01	3.4688000E-01	1.2674000E-01	4.3296000E-01
7.2290000E+02	3.7974000E-01	3.4699000E-01	1.3177000E-01	4.5011000E-01
7.2300000E+02	3.9418000E-01	3.4710000E-01	1.3682000E-01	4.6737000E-01
7.2310000E+02	4.0867000E-01	3.4721000E-01	1.4189000E-01	4.8471000E-01
7.2320000E+02	4.2316000E-01	3.4733000E-01	1.4697000E-01	5.0206000E-01
7.2330000E+02	4.3761000E-01	3.4744000E-01	1.5204000E-01	5.1937000E-01
7.2340000E+02	4.5196000E-01	3.4756000E-01	1.5708000E-01	5.3659000E-01
7.2350000E+02	4.6617000E-01	3.4768000E-01	1.6208000E-01	5.5366000E-01
7.2360000E+02	4.8018000E-01	3.4781000E-01	1.6701000E-01	5.7050000E-01
7.2370000E+02	4.9393000E-01	3.4794000E-01	1.7186000E-01	5.8705000E-01
7.2380000E+02	5.0738000E-01	3.4806000E-01	1.7660000E-01	6.0326000E-01
7.2390000E+02	5.2048000E-01	3.4819000E-01	1.8123000E-01	6.1907000E-01
7.2400000E+02	5.3320000E-01	3.4832000E-01	1.8572000E-01	6.3442000E-01
7.2410000E+02	5.4549000E-01	3.4854000E-01	1.9012000E-01	6.4945000E-01
7.2420000E+02	5.5732000E-01	3.4876000E-01	1.9437000E-01	6.6397000E-01
7.2430000E+02	5.6868000E-01	3.4898000E-01	1.9846000E-01	6.7793000E-01
7.2440000E+02	5.7955000E-01	3.4920000E-01	2.0238000E-01	6.9133000E-01
7.2450000E+02	5.8993000E-01	3.4942000E-01	2.0613000E-01	7.0415000E-01
7.2460000E+02	5.9980000E-01	3.4964000E-01	2.0972000E-01	7.1639000E-01
7.2470000E+02	6.0918000E-01	3.4986000E-01	2.1313000E-01	7.2805000E-01
7.2480000E+02	6.1808000E-01	3.5009000E-01	2.1638000E-01	7.3915000E-01
7.2490000E+02	6.2650000E-01	3.5031000E-01	2.1947000E-01	7.4970000E-01

7.2500000E+02	6.3447000E-01	3.5053000E-01	2.2240000E-01	7.5971000E-01
7.2510000E+02	6.4201000E-01	3.5075000E-01	2.2519000E-01	7.6923000E-01
7.2520000E+02	6.4914000E-01	3.5097000E-01	2.2783000E-01	7.7826000E-01
7.2530000E+02	6.5589000E-01	3.5119000E-01	2.3034000E-01	7.8684000E-01
7.2540000E+02	6.6227000E-01	3.5142000E-01	2.3273000E-01	7.9501000E-01
7.2550000E+02	6.6830000E-01	3.5165000E-01	2.3501000E-01	8.0278000E-01
7.2560000E+02	6.7402000E-01	3.5187000E-01	2.3717000E-01	8.1017000E-01
7.2570000E+02	6.7944000E-01	3.5210000E-01	2.3923000E-01	8.1721000E-01
7.2580000E+02	6.8458000E-01	3.5233000E-01	2.4120000E-01	8.2392000E-01
7.2590000E+02	6.8945000E-01	3.5256000E-01	2.4307000E-01	8.3033000E-01
7.2600000E+02	6.9407000E-01	3.5279000E-01	2.4486000E-01	8.3644000E-01
7.2610000E+02	6.9846000E-01	3.5303000E-01	2.4658000E-01	8.4231000E-01
7.2620000E+02	7.0264000E-01	3.5328000E-01	2.4823000E-01	8.4793000E-01
7.2630000E+02	7.0661000E-01	3.5352000E-01	2.4980000E-01	8.5331000E-01
7.2640000E+02	7.1038000E-01	3.5377000E-01	2.5131000E-01	8.5847000E-01
7.2650000E+02	7.1398000E-01	3.5401000E-01	2.5276000E-01	8.6341000E-01
7.2660000E+02	7.1741000E-01	3.5426000E-01	2.5415000E-01	8.6816000E-01
7.2670000E+02	7.2068000E-01	3.5450000E-01	2.5549000E-01	8.7273000E-01
7.2680000E+02	7.2381000E-01	3.5475000E-01	2.5677000E-01	8.7713000E-01
7.2690000E+02	7.2681000E-01	3.5500000E-01	2.5802000E-01	8.8137000E-01
7.2700000E+02	7.2969000E-01	3.5524000E-01	2.5922000E-01	8.8548000E-01
7.2710000E+02	7.3245000E-01	3.5549000E-01	2.6038000E-01	8.8944000E-01
7.2720000E+02	7.3512000E-01	3.5573000E-01	2.6150000E-01	8.9329000E-01
7.2730000E+02	7.3769000E-01	3.5598000E-01	2.6260000E-01	8.9704000E-01
7.2740000E+02	7.4018000E-01	3.5623000E-01	2.6367000E-01	9.0069000E-01
7.2750000E+02	7.4259000E-01	3.5647000E-01	2.6471000E-01	9.0425000E-01
7.2760000E+02	7.4493000E-01	3.5672000E-01	2.6573000E-01	9.0773000E-01
7.2770000E+02	7.4720000E-01	3.5697000E-01	2.6673000E-01	9.1113000E-01
7.2780000E+02	7.4942000E-01	3.5722000E-01	2.6770000E-01	9.1447000E-01
7.2790000E+02	7.5159000E-01	3.5746000E-01	2.6866000E-01	9.1775000E-01
7.2800000E+02	7.5370000E-01	3.5771000E-01	2.6961000E-01	9.2097000E-01
7.2810000E+02	7.5577000E-01	3.5791000E-01	2.7050000E-01	9.2403000E-01
7.2820000E+02	7.5780000E-01	3.5812000E-01	2.7138000E-01	9.2704000E-01
7.2830000E+02	7.5979000E-01	3.5832000E-01	2.7225000E-01	9.3001000E-01
7.2840000E+02	7.6175000E-01	3.5853000E-01	2.7311000E-01	9.3294000E-01
7.2850000E+02	7.6368000E-01	3.5873000E-01	2.7396000E-01	9.3584000E-01
7.2860000E+02	7.6559000E-01	3.5894000E-01	2.7480000E-01	9.3870000E-01
7.2870000E+02	7.6747000E-01	3.5914000E-01	2.7563000E-01	9.4155000E-01
7.2880000E+02	7.6933000E-01	3.5935000E-01	2.7646000E-01	9.4437000E-01
7.2890000E+02	7.7118000E-01	3.5955000E-01	2.7728000E-01	9.4717000E-01
7.2900000E+02	7.7300000E-01	3.5975000E-01	2.7809000E-01	9.4995000E-01
7.2910000E+02	7.7481000E-01	3.5995000E-01	2.7889000E-01	9.5269000E-01
7.2920000E+02	7.7659000E-01	3.6015000E-01	2.7969000E-01	9.5540000E-01

7.2930000E+02	7.7833000E-01	3.6034000E-01	2.8047000E-01	9.5806000E-01
7.2940000E+02	7.8005000E-01	3.6053000E-01	2.8123000E-01	9.6068000E-01
7.2950000E+02	7.8171000E-01	3.6072000E-01	2.8198000E-01	9.6324000E-01
7.2960000E+02	7.8332000E-01	3.6091000E-01	2.8271000E-01	9.6574000E-01
7.2970000E+02	7.8487000E-01	3.6111000E-01	2.8342000E-01	9.6815000E-01
7.2980000E+02	7.8633000E-01	3.6130000E-01	2.8410000E-01	9.7047000E-01
7.2990000E+02	7.8771000E-01	3.6149000E-01	2.8475000E-01	9.7268000E-01
7.3000000E+02	7.8898000E-01	3.6168000E-01	2.8536000E-01	9.7477000E-01
7.3010000E+02	7.9014000E-01	3.6178000E-01	2.8586000E-01	9.7648000E-01
7.3020000E+02	7.9119000E-01	3.6189000E-01	2.8632000E-01	9.7806000E-01
7.3030000E+02	7.9211000E-01	3.6199000E-01	2.8673000E-01	9.7948000E-01
7.3040000E+02	7.9291000E-01	3.6209000E-01	2.8710000E-01	9.8074000E-01
7.3050000E+02	7.9358000E-01	3.6219000E-01	2.8743000E-01	9.8185000E-01
7.3060000E+02	7.9414000E-01	3.6230000E-01	2.8771000E-01	9.8282000E-01
7.3070000E+02	7.9458000E-01	3.6240000E-01	2.8796000E-01	9.8365000E-01
7.3080000E+02	7.9493000E-01	3.6250000E-01	2.8817000E-01	9.8436000E-01
7.3090000E+02	7.9519000E-01	3.6261000E-01	2.8834000E-01	9.8497000E-01
7.3100000E+02	7.9539000E-01	3.6271000E-01	2.8849000E-01	9.8549000E-01
7.3110000E+02	7.9553000E-01	3.6281000E-01	2.8863000E-01	9.8595000E-01
7.3120000E+02	7.9563000E-01	3.6292000E-01	2.8875000E-01	9.8637000E-01
7.3130000E+02	7.9572000E-01	3.6303000E-01	2.8887000E-01	9.8677000E-01
7.3140000E+02	7.9581000E-01	3.6314000E-01	2.8899000E-01	9.8717000E-01
7.3150000E+02	7.9590000E-01	3.6324000E-01	2.8911000E-01	9.8758000E-01
7.3160000E+02	7.9602000E-01	3.6335000E-01	2.8923000E-01	9.8801000E-01
7.3170000E+02	7.9616000E-01	3.6346000E-01	2.8937000E-01	9.8847000E-01
7.3180000E+02	7.9632000E-01	3.6356000E-01	2.8951000E-01	9.8897000E-01
7.3190000E+02	7.9652000E-01	3.6367000E-01	2.8967000E-01	9.8951000E-01
7.3200000E+02	7.9673000E-01	3.6378000E-01	2.8983000E-01	9.9006000E-01
7.3210000E+02	7.9697000E-01	3.6404000E-01	2.9012000E-01	9.9106000E-01
7.3220000E+02	7.9720000E-01	3.6430000E-01	2.9042000E-01	9.9205000E-01
7.3230000E+02	7.9742000E-01	3.6456000E-01	2.9070000E-01	9.9304000E-01
7.3240000E+02	7.9762000E-01	3.6482000E-01	2.9098000E-01	9.9399000E-01
7.3250000E+02	7.9778000E-01	3.6508000E-01	2.9125000E-01	9.9490000E-01
7.3260000E+02	7.9789000E-01	3.6534000E-01	2.9150000E-01	9.9575000E-01
7.3270000E+02	7.9794000E-01	3.6560000E-01	2.9172000E-01	9.9652000E-01
7.3280000E+02	7.9791000E-01	3.6586000E-01	2.9192000E-01	9.9720000E-01
7.3290000E+02	7.9781000E-01	3.6612000E-01	2.9209000E-01	9.9779000E-01
7.3300000E+02	7.9763000E-01	3.6638000E-01	2.9224000E-01	9.9827000E-01
7.3310000E+02	7.9738000E-01	3.6665000E-01	2.9236000E-01	9.9870000E-01
7.3320000E+02	7.9705000E-01	3.6693000E-01	2.9246000E-01	9.9903000E-01
7.3330000E+02	7.9665000E-01	3.6720000E-01	2.9253000E-01	9.9928000E-01
7.3340000E+02	7.9621000E-01	3.6748000E-01	2.9259000E-01	9.9947000E-01
7.3350000E+02	7.9572000E-01	3.6775000E-01	2.9262000E-01	9.9959000E-01

7.3360000E+02	7.9520000E-01	3.6802000E-01	2.9265000E-01	9.9969000E-01
7.3370000E+02	7.9466000E-01	3.6830000E-01	2.9267000E-01	9.9976000E-01
7.3380000E+02	7.9412000E-01	3.6857000E-01	2.9269000E-01	9.9982000E-01
7.3390000E+02	7.9359000E-01	3.6885000E-01	2.9271000E-01	9.9990000E-01
7.3400000E+02	7.9308000E-01	3.6912000E-01	2.9274000E-01	1.0000000E+00
7.3410000E+02	7.9259000E-01	3.6927000E-01	2.9268000E-01	9.9980000E-01
7.3420000E+02	7.9213000E-01	3.6943000E-01	2.9263000E-01	9.9963000E-01
7.3430000E+02	7.9169000E-01	3.6958000E-01	2.9259000E-01	9.9949000E-01
7.3440000E+02	7.9127000E-01	3.6973000E-01	2.9256000E-01	9.9938000E-01
7.3450000E+02	7.9087000E-01	3.6989000E-01	2.9253000E-01	9.9928000E-01
7.3460000E+02	7.9048000E-01	3.7004000E-01	2.9251000E-01	9.9919000E-01
7.3470000E+02	7.9007000E-01	3.7019000E-01	2.9248000E-01	9.9910000E-01
7.3480000E+02	7.8965000E-01	3.7034000E-01	2.9244000E-01	9.9897000E-01
7.3490000E+02	7.8919000E-01	3.7050000E-01	2.9239000E-01	9.9881000E-01
7.3500000E+02	7.8868000E-01	3.7065000E-01	2.9233000E-01	9.9859000E-01
7.3510000E+02	7.8811000E-01	3.7081000E-01	2.9224000E-01	9.9827000E-01
7.3520000E+02	7.8746000E-01	3.7096000E-01	2.9212000E-01	9.9786000E-01
7.3530000E+02	7.8672000E-01	3.7111000E-01	2.9196000E-01	9.9733000E-01
7.3540000E+02	7.8588000E-01	3.7126000E-01	2.9177000E-01	9.9668000E-01
7.3550000E+02	7.8493000E-01	3.7142000E-01	2.9153000E-01	9.9587000E-01
7.3560000E+02	7.8385000E-01	3.7157000E-01	2.9125000E-01	9.9491000E-01
7.3570000E+02	7.8264000E-01	3.7172000E-01	2.9092000E-01	9.9379000E-01
7.3580000E+02	7.8129000E-01	3.7187000E-01	2.9054000E-01	9.9248000E-01
7.3590000E+02	7.7978000E-01	3.7203000E-01	2.9010000E-01	9.9097000E-01
7.3600000E+02	7.7812000E-01	3.7218000E-01	2.8960000E-01	9.8926000E-01
7.3610000E+02	7.7628000E-01	3.7229000E-01	2.8900000E-01	9.8721000E-01
7.3620000E+02	7.7425000E-01	3.7240000E-01	2.8833000E-01	9.8492000E-01
7.3630000E+02	7.7201000E-01	3.7251000E-01	2.8758000E-01	9.8236000E-01
7.3640000E+02	7.6954000E-01	3.7261000E-01	2.8674000E-01	9.7950000E-01
7.3650000E+02	7.6682000E-01	3.7272000E-01	2.8581000E-01	9.7633000E-01
7.3660000E+02	7.6382000E-01	3.7283000E-01	2.8478000E-01	9.7279000E-01
7.3670000E+02	7.6051000E-01	3.7294000E-01	2.8363000E-01	9.6886000E-01
7.3680000E+02	7.5687000E-01	3.7305000E-01	2.8235000E-01	9.6450000E-01
7.3690000E+02	7.5286000E-01	3.7316000E-01	2.8094000E-01	9.5968000E-01
7.3700000E+02	7.4844000E-01	3.7328000E-01	2.7938000E-01	9.5434000E-01
7.3710000E+02	7.4359000E-01	3.7339000E-01	2.7765000E-01	9.4845000E-01
7.3720000E+02	7.3828000E-01	3.7351000E-01	2.7575000E-01	9.4197000E-01
7.3730000E+02	7.3247000E-01	3.7362000E-01	2.7367000E-01	9.3485000E-01
7.3740000E+02	7.2615000E-01	3.7374000E-01	2.7139000E-01	9.2706000E-01
7.3750000E+02	7.1929000E-01	3.7385000E-01	2.6891000E-01	9.1858000E-01
7.3760000E+02	7.1187000E-01	3.7397000E-01	2.6622000E-01	9.0939000E-01
7.3770000E+02	7.0388000E-01	3.7409000E-01	2.6331000E-01	8.9946000E-01
7.3780000E+02	6.9531000E-01	3.7420000E-01	2.6019000E-01	8.8879000E-01

7.3790000E+02	6.8617000E-01	3.7432000E-01	2.5685000E-01	8.7738000E-01
7.3800000E+02	6.7645000E-01	3.7443000E-01	2.5329000E-01	8.6522000E-01
7.3810000E+02	6.6616000E-01	3.7467000E-01	2.4959000E-01	8.5259000E-01
7.3820000E+02	6.5532000E-01	3.7490000E-01	2.4568000E-01	8.3923000E-01
7.3830000E+02	6.4393000E-01	3.7513000E-01	2.4156000E-01	8.2516000E-01
7.3840000E+02	6.3202000E-01	3.7537000E-01	2.3724000E-01	8.1041000E-01
7.3850000E+02	6.1962000E-01	3.7560000E-01	2.3273000E-01	7.9500000E-01
7.3860000E+02	6.0674000E-01	3.7584000E-01	2.2803000E-01	7.7896000E-01
7.3870000E+02	5.9341000E-01	3.7607000E-01	2.2316000E-01	7.6232000E-01
7.3880000E+02	5.7967000E-01	3.7630000E-01	2.1813000E-01	7.4513000E-01
7.3890000E+02	5.6554000E-01	3.7654000E-01	2.1295000E-01	7.2742000E-01
7.3900000E+02	5.5106000E-01	3.7677000E-01	2.0763000E-01	7.0924000E-01
7.3910000E+02	5.3627000E-01	3.7701000E-01	2.0218000E-01	6.9063000E-01
7.3920000E+02	5.2119000E-01	3.7725000E-01	1.9662000E-01	6.7163000E-01
7.3930000E+02	5.0586000E-01	3.7748000E-01	1.9095000E-01	6.5230000E-01
7.3940000E+02	4.9033000E-01	3.7772000E-01	1.8521000E-01	6.3267000E-01
7.3950000E+02	4.7464000E-01	3.7796000E-01	1.7939000E-01	6.1280000E-01
7.3960000E+02	4.5882000E-01	3.7820000E-01	1.7352000E-01	5.9275000E-01
7.3970000E+02	4.4291000E-01	3.7843000E-01	1.6761000E-01	5.7257000E-01
7.3980000E+02	4.2697000E-01	3.7867000E-01	1.6168000E-01	5.5231000E-01
7.3990000E+02	4.1104000E-01	3.7891000E-01	1.5575000E-01	5.3203000E-01
7.4000000E+02	3.9515000E-01	3.7915000E-01	1.4982000E-01	5.1179000E-01
7.4010000E+02	3.7936000E-01	3.7939000E-01	1.4393000E-01	4.9165000E-01
7.4020000E+02	3.6371000E-01	3.7964000E-01	1.3808000E-01	4.7167000E-01
7.4030000E+02	3.4823000E-01	3.7989000E-01	1.3229000E-01	4.5189000E-01
7.4040000E+02	3.3297000E-01	3.8013000E-01	1.2657000E-01	4.3237000E-01
7.4050000E+02	3.1797000E-01	3.8038000E-01	1.2095000E-01	4.1315000E-01
7.4060000E+02	3.0325000E-01	3.8063000E-01	1.1543000E-01	3.9429000E-01
7.4070000E+02	2.8887000E-01	3.8087000E-01	1.1002000E-01	3.7583000E-01
7.4080000E+02	2.7483000E-01	3.8112000E-01	1.0474000E-01	3.5780000E-01
7.4090000E+02	2.6117000E-01	3.8137000E-01	9.9602000E-02	3.4024000E-01
7.4100000E+02	2.4791000E-01	3.8161000E-01	9.4605000E-02	3.2317000E-01
7.4110000E+02	2.3506000E-01	3.8186000E-01	8.9761000E-02	3.0662000E-01
7.4120000E+02	2.2264000E-01	3.8210000E-01	8.5074000E-02	2.9061000E-01
7.4130000E+02	2.1067000E-01	3.8235000E-01	8.0550000E-02	2.7516000E-01
7.4140000E+02	1.9915000E-01	3.8260000E-01	7.6192000E-02	2.6027000E-01
7.4150000E+02	1.8808000E-01	3.8284000E-01	7.2003000E-02	2.4596000E-01
7.4160000E+02	1.7747000E-01	3.8309000E-01	6.7986000E-02	2.3224000E-01
7.4170000E+02	1.6732000E-01	3.8333000E-01	6.4140000E-02	2.1910000E-01
7.4180000E+02	1.5764000E-01	3.8358000E-01	6.0468000E-02	2.0656000E-01
7.4190000E+02	1.4843000E-01	3.8382000E-01	5.6970000E-02	1.9461000E-01
7.4200000E+02	1.3968000E-01	3.8407000E-01	5.3645000E-02	1.8325000E-01
7.4210000E+02	1.3139000E-01	3.8433000E-01	5.0496000E-02	1.7249000E-01

7.4220000E+02	1.2355000E-01	3.8460000E-01	4.7518000E-02	1.6232000E-01
7.4230000E+02	1.1617000E-01	3.8486000E-01	4.4710000E-02	1.5273000E-01
7.4240000E+02	1.0924000E-01	3.8512000E-01	4.2070000E-02	1.4371000E-01
7.4250000E+02	1.0274000E-01	3.8539000E-01	3.9594000E-02	1.3525000E-01
7.4260000E+02	9.6665000E-02	3.8565000E-01	3.7279000E-02	1.2734000E-01
7.4270000E+02	9.1002000E-02	3.8591000E-01	3.5118000E-02	1.1996000E-01
7.4280000E+02	8.5733000E-02	3.8616000E-01	3.3107000E-02	1.1309000E-01
7.4290000E+02	8.0840000E-02	3.8642000E-01	3.1238000E-02	1.0671000E-01
7.4300000E+02	7.6300000E-02	3.8667000E-01	2.9503000E-02	1.0078000E-01
7.4310000E+02	7.2088000E-02	3.8693000E-01	2.7893000E-02	9.5281000E-02
7.4320000E+02	6.8180000E-02	3.8718000E-01	2.6398000E-02	9.0175000E-02
7.4330000E+02	6.4546000E-02	3.8744000E-01	2.5007000E-02	8.5425000E-02
7.4340000E+02	6.1159000E-02	3.8769000E-01	2.3711000E-02	8.0995000E-02
7.4350000E+02	5.7989000E-02	3.8795000E-01	2.2497000E-02	7.6848000E-02
7.4360000E+02	5.5009000E-02	3.8820000E-01	2.1355000E-02	7.2947000E-02
7.4370000E+02	5.2192000E-02	3.8846000E-01	2.0275000E-02	6.9257000E-02
7.4380000E+02	4.9516000E-02	3.8872000E-01	1.9248000E-02	6.5750000E-02
7.4390000E+02	4.6960000E-02	3.8897000E-01	1.8266000E-02	6.2396000E-02
7.4400000E+02	4.4506000E-02	3.8923000E-01	1.7323000E-02	5.9174000E-02
7.4410000E+02	4.2141000E-02	3.8952000E-01	1.6415000E-02	5.6072000E-02
7.4420000E+02	3.9858000E-02	3.8980000E-01	1.5537000E-02	5.3073000E-02
7.4430000E+02	3.7651000E-02	3.9009000E-01	1.4687000E-02	5.0171000E-02
7.4440000E+02	3.5519000E-02	3.9038000E-01	1.3866000E-02	4.7366000E-02
7.4450000E+02	3.3465000E-02	3.9067000E-01	1.3074000E-02	4.4659000E-02
7.4460000E+02	3.1494000E-02	3.9096000E-01	1.2313000E-02	4.2060000E-02
7.4470000E+02	2.9613000E-02	3.9125000E-01	1.1586000E-02	3.9578000E-02
7.4480000E+02	2.7831000E-02	3.9155000E-01	1.0897000E-02	3.7224000E-02
7.4490000E+02	2.6157000E-02	3.9184000E-01	1.0249000E-02	3.5011000E-02
7.4500000E+02	2.4600000E-02	3.9213000E-01	9.6463000E-03	3.2952000E-02
7.4510000E+02	2.3166000E-02	3.9243000E-01	9.0909000E-03	3.1054000E-02
7.4520000E+02	2.1861000E-02	3.9272000E-01	8.5854000E-03	2.9327000E-02
7.4530000E+02	2.0688000E-02	3.9302000E-01	8.1307000E-03	2.7774000E-02
7.4540000E+02	1.9646000E-02	3.9331000E-01	7.7268000E-03	2.6395000E-02
7.4550000E+02	1.8730000E-02	3.9360000E-01	7.3723000E-03	2.5184000E-02
7.4560000E+02	1.7935000E-02	3.9390000E-01	7.0645000E-03	2.4132000E-02
7.4570000E+02	1.7249000E-02	3.9419000E-01	6.7996000E-03	2.3227000E-02
7.4580000E+02	1.6662000E-02	3.9449000E-01	6.5728000E-03	2.2452000E-02
7.4590000E+02	1.6157000E-02	3.9478000E-01	6.3785000E-03	2.1789000E-02
7.4600000E+02	1.5721000E-02	3.9508000E-01	6.2110000E-03	2.1217000E-02
7.4610000E+02	1.5338000E-02	3.9528000E-01	6.0628000E-03	2.0710000E-02
7.4620000E+02	1.4993000E-02	3.9549000E-01	5.9294000E-03	2.0255000E-02
7.4630000E+02	1.4671000E-02	3.9570000E-01	5.8053000E-03	1.9831000E-02
7.4640000E+02	1.4360000E-02	3.9590000E-01	5.6852000E-03	1.9421000E-02

7.4650000E+02	1.4049000E-02	3.9611000E-01	5.5650000E-03	1.9010000E-02
7.4660000E+02	1.3729000E-02	3.9633000E-01	5.4412000E-03	1.8587000E-02
7.4670000E+02	1.3393000E-02	3.9654000E-01	5.3110000E-03	1.8142000E-02
7.4680000E+02	1.3037000E-02	3.9676000E-01	5.1726000E-03	1.7670000E-02
7.4690000E+02	1.2659000E-02	3.9698000E-01	5.0253000E-03	1.7166000E-02
7.4700000E+02	1.2259000E-02	3.9719000E-01	4.8692000E-03	1.6633000E-02
7.4710000E+02	1.1839000E-02	3.9741000E-01	4.7050000E-03	1.6072000E-02
7.4720000E+02	1.1403000E-02	3.9763000E-01	4.5342000E-03	1.5489000E-02
7.4730000E+02	1.0955000E-02	3.9785000E-01	4.3584000E-03	1.4888000E-02
7.4740000E+02	1.0500000E-02	3.9807000E-01	4.1796000E-03	1.4277000E-02
7.4750000E+02	1.0042000E-02	3.9829000E-01	3.9997000E-03	1.3663000E-02
7.4760000E+02	9.5865000E-03	3.9851000E-01	3.8203000E-03	1.3050000E-02
7.4770000E+02	9.1354000E-03	3.9873000E-01	3.6425000E-03	1.2443000E-02
7.4780000E+02	8.6911000E-03	3.9895000E-01	3.4673000E-03	1.1844000E-02
7.4790000E+02	8.2544000E-03	3.9917000E-01	3.2949000E-03	1.1255000E-02
7.4800000E+02	7.8257000E-03	3.9938000E-01	3.1255000E-03	1.0676000E-02
7.4810000E+02	7.4044000E-03	3.9975000E-01	2.9599000E-03	1.0111000E-02
7.4820000E+02	6.9902000E-03	4.0012000E-01	2.7969000E-03	9.5543000E-03
7.4830000E+02	6.5828000E-03	4.0049000E-01	2.6364000E-03	9.0058000E-03
7.4840000E+02	6.1825000E-03	4.0086000E-01	2.4783000E-03	8.4660000E-03
7.4850000E+02	5.7900000E-03	4.0123000E-01	2.3232000E-03	7.9359000E-03
7.4860000E+02	5.4067000E-03	4.0161000E-01	2.1714000E-03	7.4173000E-03
7.4870000E+02	5.0342000E-03	4.0198000E-01	2.0237000E-03	6.9128000E-03
7.4880000E+02	4.6744000E-03	4.0236000E-01	1.8808000E-03	6.4247000E-03
7.4890000E+02	4.3292000E-03	4.0273000E-01	1.7435000E-03	5.9558000E-03
7.4900000E+02	4.0006000E-03	4.0311000E-01	1.6127000E-03	5.5088000E-03
7.4910000E+02	3.6901000E-03	4.0348000E-01	1.4889000E-03	5.0860000E-03
7.4920000E+02	3.3997000E-03	4.0386000E-01	1.3730000E-03	4.6902000E-03
7.4930000E+02	3.1312000E-03	4.0423000E-01	1.2657000E-03	4.3237000E-03
7.4940000E+02	2.8868000E-03	4.0461000E-01	1.1680000E-03	3.9900000E-03
7.4950000E+02	2.6688000E-03	4.0498000E-01	1.0808000E-03	3.6920000E-03
7.4960000E+02	2.4791000E-03	4.0536000E-01	1.0049000E-03	3.4328000E-03
7.4970000E+02	2.3190000E-03	4.0574000E-01	9.4090000E-04	3.2141000E-03
7.4980000E+02	2.1880000E-03	4.0611000E-01	8.8859000E-04	3.0354000E-03
7.4990000E+02	2.0835000E-03	4.0649000E-01	8.4690000E-04	2.8930000E-03
7.5000000E+02	2.0002000E-03	4.0687000E-01	8.1383000E-04	2.7800000E-03
7.5010000E+02	1.9697000E-03	4.0712000E-01	8.0191000E-04	2.7393000E-03
7.5020000E+02	1.8802000E-03	4.0737000E-01	7.6592000E-04	2.6164000E-03
7.5030000E+02	1.7971000E-03	4.0762000E-01	7.3252000E-04	2.5023000E-03
7.5040000E+02	1.7182000E-03	4.0787000E-01	7.0080000E-04	2.3939000E-03
7.5050000E+02	1.6421000E-03	4.0812000E-01	6.7019000E-04	2.2893000E-03
7.5060000E+02	1.5684000E-03	4.0836000E-01	6.4049000E-04	2.1879000E-03
7.5070000E+02	1.4974000E-03	4.0861000E-01	6.1185000E-04	2.0901000E-03

7.5080000E+02	0.0000000E+00	4.0885000E-01	0.0000000E+00	0.0000000E+00
Channel 7				
Wavenumber	HIRS Filter Transmittance	Optical Element Transmittance	Product of the HIRS Filter and Optical Element Transmittances	Normalized Value of Column 4
7.2840000E+02	0.0000000E+00	3.5873000E-01	0.0000000E+00	0.0000000E+00
7.2850000E+02	3.1336000E-03	3.5873000E-01	1.1241000E-03	3.3078000E-03
7.2860000E+02	3.2189000E-03	3.5894000E-01	1.1554000E-03	3.3997000E-03
7.2870000E+02	3.3090000E-03	3.5914000E-01	1.1884000E-03	3.4969000E-03
7.2880000E+02	3.4027000E-03	3.5935000E-01	1.2227000E-03	3.5980000E-03
7.2890000E+02	3.4988000E-03	3.5955000E-01	1.2580000E-03	3.7016000E-03
7.2900000E+02	3.5959000E-03	3.5975000E-01	1.2936000E-03	3.8066000E-03
7.2910000E+02	3.6931000E-03	3.5995000E-01	1.3293000E-03	3.9116000E-03
7.2920000E+02	3.7893000E-03	3.6015000E-01	1.3647000E-03	4.0157000E-03
7.2930000E+02	3.8838000E-03	3.6034000E-01	1.3995000E-03	4.1181000E-03
7.2940000E+02	3.9763000E-03	3.6053000E-01	1.4336000E-03	4.2183000E-03
7.2950000E+02	4.0663000E-03	3.6072000E-01	1.4668000E-03	4.3161000E-03
7.2960000E+02	4.1541000E-03	3.6091000E-01	1.4993000E-03	4.4116000E-03
7.2970000E+02	4.2399000E-03	3.6111000E-01	1.5310000E-03	4.5051000E-03
7.2980000E+02	4.3242000E-03	3.6130000E-01	1.5623000E-03	4.5972000E-03
7.2990000E+02	4.4080000E-03	3.6149000E-01	1.5934000E-03	4.6888000E-03
7.3000000E+02	4.4921000E-03	3.6168000E-01	1.6247000E-03	4.7807000E-03
7.3010000E+02	4.5775000E-03	3.6178000E-01	1.6561000E-03	4.8730000E-03
7.3020000E+02	4.6654000E-03	3.6189000E-01	1.6883000E-03	4.9680000E-03
7.3030000E+02	4.7568000E-03	3.6199000E-01	1.7219000E-03	5.0667000E-03
7.3040000E+02	4.8526000E-03	3.6209000E-01	1.7571000E-03	5.1703000E-03
7.3050000E+02	4.9538000E-03	3.6219000E-01	1.7942000E-03	5.2796000E-03
7.3060000E+02	5.0609000E-03	3.6230000E-01	1.8336000E-03	5.3953000E-03
7.3070000E+02	5.1744000E-03	3.6240000E-01	1.8752000E-03	5.5179000E-03
7.3080000E+02	5.2945000E-03	3.6250000E-01	1.9193000E-03	5.6476000E-03
7.3090000E+02	5.4211000E-03	3.6261000E-01	1.9657000E-03	5.7843000E-03
7.3100000E+02	5.5540000E-03	3.6271000E-01	2.0145000E-03	5.9277000E-03
7.3110000E+02	5.6927000E-03	3.6281000E-01	2.0654000E-03	6.0775000E-03
7.3120000E+02	5.8366000E-03	3.6292000E-01	2.1182000E-03	6.2330000E-03
7.3130000E+02	5.9850000E-03	3.6303000E-01	2.1727000E-03	6.3933000E-03
7.3140000E+02	6.1372000E-03	3.6314000E-01	2.2286000E-03	6.5579000E-03
7.3150000E+02	6.2926000E-03	3.6324000E-01	2.2857000E-03	6.7259000E-03
7.3160000E+02	6.4507000E-03	3.6335000E-01	2.3438000E-03	6.8969000E-03
7.3170000E+02	6.6111000E-03	3.6346000E-01	2.4028000E-03	7.0705000E-03
7.3180000E+02	6.7738000E-03	3.6356000E-01	2.4627000E-03	7.2466000E-03
7.3190000E+02	6.9391000E-03	3.6367000E-01	2.5235000E-03	7.4256000E-03
7.3200000E+02	7.1075000E-03	3.6378000E-01	2.5855000E-03	7.6081000E-03

7.3210000E+02	7.4757000E-03	3.6404000E-01	2.7214000E-03	8.0079000E-03
7.3220000E+02	7.5969000E-03	3.6430000E-01	2.7675000E-03	8.1435000E-03
7.3230000E+02	7.7023000E-03	3.6456000E-01	2.8079000E-03	8.2624000E-03
7.3240000E+02	7.7976000E-03	3.6482000E-01	2.8447000E-03	8.3706000E-03
7.3250000E+02	7.8899000E-03	3.6508000E-01	2.8804000E-03	8.4758000E-03
7.3260000E+02	7.9877000E-03	3.6534000E-01	2.9182000E-03	8.5869000E-03
7.3270000E+02	8.0997000E-03	3.6560000E-01	2.9612000E-03	8.7136000E-03
7.3280000E+02	8.2351000E-03	3.6586000E-01	3.0129000E-03	8.8655000E-03
7.3290000E+02	8.4024000E-03	3.6612000E-01	3.0763000E-03	9.0521000E-03
7.3300000E+02	8.6092000E-03	3.6638000E-01	3.1542000E-03	9.2815000E-03
7.3310000E+02	8.8618000E-03	3.6665000E-01	3.2492000E-03	9.5609000E-03
7.3320000E+02	9.1644000E-03	3.6693000E-01	3.3627000E-03	9.8949000E-03
7.3330000E+02	9.5196000E-03	3.6720000E-01	3.4956000E-03	1.0286000E-02
7.3340000E+02	9.9275000E-03	3.6748000E-01	3.6481000E-03	1.0735000E-02
7.3350000E+02	1.0386000E-02	3.6775000E-01	3.8194000E-03	1.1239000E-02
7.3360000E+02	1.0891000E-02	3.6802000E-01	4.0083000E-03	1.1795000E-02
7.3370000E+02	1.1438000E-02	3.6830000E-01	4.2127000E-03	1.2396000E-02
7.3380000E+02	1.2020000E-02	3.6857000E-01	4.4302000E-03	1.3036000E-02
7.3390000E+02	1.2629000E-02	3.6885000E-01	4.6583000E-03	1.3707000E-02
7.3400000E+02	1.3259000E-02	3.6912000E-01	4.8943000E-03	1.4402000E-02
7.3410000E+02	1.3904000E-02	3.6927000E-01	5.1342000E-03	1.5108000E-02
7.3420000E+02	1.4557000E-02	3.6943000E-01	5.3777000E-03	1.5824000E-02
7.3430000E+02	1.5216000E-02	3.6958000E-01	5.6236000E-03	1.6548000E-02
7.3440000E+02	1.5880000E-02	3.6973000E-01	5.8715000E-03	1.7277000E-02
7.3450000E+02	1.6551000E-02	3.6989000E-01	6.1221000E-03	1.8014000E-02
7.3460000E+02	1.7233000E-02	3.7004000E-01	6.3770000E-03	1.8765000E-02
7.3470000E+02	1.7934000E-02	3.7019000E-01	6.6391000E-03	1.9536000E-02
7.3480000E+02	1.8664000E-02	3.7034000E-01	6.9120000E-03	2.0339000E-02
7.3490000E+02	1.9435000E-02	3.7050000E-01	7.2005000E-03	2.1188000E-02
7.3500000E+02	2.0261000E-02	3.7065000E-01	7.5098000E-03	2.2098000E-02
7.3510000E+02	2.1158000E-02	3.7081000E-01	7.8457000E-03	2.3086000E-02
7.3520000E+02	2.2144000E-02	3.7096000E-01	8.2145000E-03	2.4171000E-02
7.3530000E+02	2.3234000E-02	3.7111000E-01	8.6223000E-03	2.5371000E-02
7.3540000E+02	2.4444000E-02	3.7126000E-01	9.0751000E-03	2.6704000E-02
7.3550000E+02	2.5789000E-02	3.7142000E-01	9.5786000E-03	2.8185000E-02
7.3560000E+02	2.7284000E-02	3.7157000E-01	1.0138000E-02	2.9831000E-02
7.3570000E+02	2.8939000E-02	3.7172000E-01	1.0757000E-02	3.1654000E-02
7.3580000E+02	3.0765000E-02	3.7187000E-01	1.1441000E-02	3.3665000E-02
7.3590000E+02	3.2770000E-02	3.7203000E-01	1.2191000E-02	3.5873000E-02
7.3600000E+02	3.4960000E-02	3.7218000E-01	1.3011000E-02	3.8287000E-02
7.3610000E+02	3.7342000E-02	3.7229000E-01	1.3902000E-02	4.0907000E-02
7.3620000E+02	3.9921000E-02	3.7240000E-01	1.4866000E-02	4.3745000E-02
7.3630000E+02	4.2704000E-02	3.7251000E-01	1.5907000E-02	4.6808000E-02

7.3640000E+02	4.5698000E-02	3.7261000E-01	1.7028000E-02	5.0104000E-02
7.3650000E+02	4.8913000E-02	3.7272000E-01	1.8231000E-02	5.3646000E-02
7.3660000E+02	5.2364000E-02	3.7283000E-01	1.9523000E-02	5.7448000E-02
7.3670000E+02	5.6069000E-02	3.7294000E-01	2.0910000E-02	6.1530000E-02
7.3680000E+02	6.0051000E-02	3.7305000E-01	2.2402000E-02	6.5919000E-02
7.3690000E+02	6.4338000E-02	3.7316000E-01	2.4009000E-02	7.0647000E-02
7.3700000E+02	6.8967000E-02	3.7328000E-01	2.5744000E-02	7.5752000E-02
7.3710000E+02	7.3978000E-02	3.7339000E-01	2.7623000E-02	8.1281000E-02
7.3720000E+02	7.9417000E-02	3.7351000E-01	2.9663000E-02	8.7284000E-02
7.3730000E+02	8.5338000E-02	3.7362000E-01	3.1884000E-02	9.3821000E-02
7.3740000E+02	9.1797000E-02	3.7374000E-01	3.4308000E-02	1.0095000E-01
7.3750000E+02	9.8854000E-02	3.7385000E-01	3.6957000E-02	1.0875000E-01
7.3760000E+02	1.0657000E-01	3.7397000E-01	3.9855000E-02	1.1727000E-01
7.3770000E+02	1.1501000E-01	3.7409000E-01	4.3025000E-02	1.2660000E-01
7.3780000E+02	1.2424000E-01	3.7420000E-01	4.6491000E-02	1.3680000E-01
7.3790000E+02	1.3431000E-01	3.7432000E-01	5.0275000E-02	1.4794000E-01
7.3800000E+02	1.4528000E-01	3.7443000E-01	5.4397000E-02	1.6006000E-01
7.3810000E+02	1.5719000E-01	3.7467000E-01	5.8893000E-02	1.7329000E-01
7.3820000E+02	1.7008000E-01	3.7490000E-01	6.3763000E-02	1.8762000E-01
7.3830000E+02	1.8398000E-01	3.7513000E-01	6.9017000E-02	2.0309000E-01
7.3840000E+02	1.9891000E-01	3.7537000E-01	7.4662000E-02	2.1970000E-01
7.3850000E+02	2.1486000E-01	3.7560000E-01	8.0701000E-02	2.3746000E-01
7.3860000E+02	2.3182000E-01	3.7584000E-01	8.7127000E-02	2.5638000E-01
7.3870000E+02	2.4978000E-01	3.7607000E-01	9.3934000E-02	2.7641000E-01
7.3880000E+02	2.6868000E-01	3.7630000E-01	1.0111000E-01	2.9751000E-01
7.3890000E+02	2.8848000E-01	3.7654000E-01	1.0862000E-01	3.1963000E-01
7.3900000E+02	3.0909000E-01	3.7677000E-01	1.1646000E-01	3.4268000E-01
7.3910000E+02	3.3043000E-01	3.7701000E-01	1.2458000E-01	3.6657000E-01
7.3920000E+02	3.5241000E-01	3.7725000E-01	1.3295000E-01	3.9120000E-01
7.3930000E+02	3.7491000E-01	3.7748000E-01	1.4152000E-01	4.1643000E-01
7.3940000E+02	3.9780000E-01	3.7772000E-01	1.5026000E-01	4.4214000E-01
7.3950000E+02	4.2096000E-01	3.7796000E-01	1.5911000E-01	4.6817000E-01
7.3960000E+02	4.4424000E-01	3.7820000E-01	1.6801000E-01	4.9438000E-01
7.3970000E+02	4.6749000E-01	3.7843000E-01	1.7692000E-01	5.2058000E-01
7.3980000E+02	4.9057000E-01	3.7867000E-01	1.8577000E-01	5.4663000E-01
7.3990000E+02	5.1332000E-01	3.7891000E-01	1.9450000E-01	5.7233000E-01
7.4000000E+02	5.3559000E-01	3.7915000E-01	2.0307000E-01	5.9754000E-01
7.4010000E+02	5.5723000E-01	3.7939000E-01	2.1141000E-01	6.2208000E-01
7.4020000E+02	5.7810000E-01	3.7964000E-01	2.1947000E-01	6.4579000E-01
7.4030000E+02	5.9805000E-01	3.7989000E-01	2.2719000E-01	6.6852000E-01
7.4040000E+02	6.1696000E-01	3.8013000E-01	2.3453000E-01	6.9011000E-01
7.4050000E+02	6.3472000E-01	3.8038000E-01	2.4143000E-01	7.1043000E-01
7.4060000E+02	6.5122000E-01	3.8063000E-01	2.4787000E-01	7.2937000E-01

7.4070000E+02	6.6637000E-01	3.8087000E-01	2.5380000E-01	7.4682000E-01
7.4080000E+02	6.8010000E-01	3.8112000E-01	2.5920000E-01	7.6270000E-01
7.4090000E+02	6.9236000E-01	3.8137000E-01	2.6404000E-01	7.7696000E-01
7.4100000E+02	7.0311000E-01	3.8161000E-01	2.6832000E-01	7.8953000E-01
7.4110000E+02	7.1233000E-01	3.8186000E-01	2.7201000E-01	8.0041000E-01
7.4120000E+02	7.2004000E-01	3.8210000E-01	2.7513000E-01	8.0958000E-01
7.4130000E+02	7.2624000E-01	3.8235000E-01	2.7768000E-01	8.1708000E-01
7.4140000E+02	7.3098000E-01	3.8260000E-01	2.7967000E-01	8.2294000E-01
7.4150000E+02	7.3431000E-01	3.8284000E-01	2.8112000E-01	8.2722000E-01
7.4160000E+02	7.3631000E-01	3.8309000E-01	2.8207000E-01	8.3000000E-01
7.4170000E+02	7.3706000E-01	3.8333000E-01	2.8254000E-01	8.3138000E-01
7.4180000E+02	7.3666000E-01	3.8358000E-01	2.8257000E-01	8.3147000E-01
7.4190000E+02	7.3522000E-01	3.8382000E-01	2.8220000E-01	8.3037000E-01
7.4200000E+02	7.3286000E-01	3.8407000E-01	2.8147000E-01	8.2824000E-01
7.4210000E+02	7.2970000E-01	3.8433000E-01	2.8045000E-01	8.2522000E-01
7.4220000E+02	7.2585000E-01	3.8460000E-01	2.7916000E-01	8.2144000E-01
7.4230000E+02	7.2145000E-01	3.8486000E-01	2.7766000E-01	8.1702000E-01
7.4240000E+02	7.1662000E-01	3.8512000E-01	2.7599000E-01	8.1210000E-01
7.4250000E+02	7.1148000E-01	3.8539000E-01	2.7419000E-01	8.0683000E-01
7.4260000E+02	7.0614000E-01	3.8565000E-01	2.7232000E-01	8.0132000E-01
7.4270000E+02	7.0071000E-01	3.8591000E-01	2.7041000E-01	7.9569000E-01
7.4280000E+02	6.9528000E-01	3.8616000E-01	2.6849000E-01	7.9004000E-01
7.4290000E+02	6.8994000E-01	3.8642000E-01	2.6661000E-01	7.8450000E-01
7.4300000E+02	6.8478000E-01	3.8667000E-01	2.6478000E-01	7.7913000E-01
7.4310000E+02	6.7985000E-01	3.8693000E-01	2.6305000E-01	7.7404000E-01
7.4320000E+02	6.7522000E-01	3.8718000E-01	2.6143000E-01	7.6927000E-01
7.4330000E+02	6.7093000E-01	3.8744000E-01	2.5994000E-01	7.6489000E-01
7.4340000E+02	6.6703000E-01	3.8769000E-01	2.5860000E-01	7.6094000E-01
7.4350000E+02	6.6354000E-01	3.8795000E-01	2.5742000E-01	7.5746000E-01
7.4360000E+02	6.6049000E-01	3.8820000E-01	2.5641000E-01	7.5448000E-01
7.4370000E+02	6.5790000E-01	3.8846000E-01	2.5557000E-01	7.5202000E-01
7.4380000E+02	6.5579000E-01	3.8872000E-01	2.5491000E-01	7.5010000E-01
7.4390000E+02	6.5415000E-01	3.8897000E-01	2.5445000E-01	7.4872000E-01
7.4400000E+02	6.5299000E-01	3.8923000E-01	2.5416000E-01	7.4789000E-01
7.4410000E+02	6.5232000E-01	3.8952000E-01	2.5409000E-01	7.4767000E-01
7.4420000E+02	6.5214000E-01	3.8980000E-01	2.5421000E-01	7.4801000E-01
7.4430000E+02	6.5243000E-01	3.9009000E-01	2.5451000E-01	7.4890000E-01
7.4440000E+02	6.5319000E-01	3.9038000E-01	2.5499000E-01	7.5033000E-01
7.4450000E+02	6.5442000E-01	3.9067000E-01	2.5566000E-01	7.5229000E-01
7.4460000E+02	6.5610000E-01	3.9096000E-01	2.5651000E-01	7.5478000E-01
7.4470000E+02	6.5822000E-01	3.9125000E-01	2.5753000E-01	7.5779000E-01
7.4480000E+02	6.6076000E-01	3.9155000E-01	2.5872000E-01	7.6130000E-01
7.4490000E+02	6.6372000E-01	3.9184000E-01	2.6007000E-01	7.6527000E-01

7.4500000E+02	6.6706000E-01	3.9213000E-01	2.6158000E-01	7.6970000E-01
7.4510000E+02	6.7077000E-01	3.9243000E-01	2.6323000E-01	7.7456000E-01
7.4520000E+02	6.7481000E-01	3.9272000E-01	2.6501000E-01	7.7981000E-01
7.4530000E+02	6.7916000E-01	3.9302000E-01	2.6692000E-01	7.8543000E-01
7.4540000E+02	6.8379000E-01	3.9331000E-01	2.6894000E-01	7.9138000E-01
7.4550000E+02	6.8867000E-01	3.9360000E-01	2.7107000E-01	7.9762000E-01
7.4560000E+02	6.9376000E-01	3.9390000E-01	2.7327000E-01	8.0411000E-01
7.4570000E+02	6.9903000E-01	3.9419000E-01	2.7555000E-01	8.1083000E-01
7.4580000E+02	7.0444000E-01	3.9449000E-01	2.7789000E-01	8.1771000E-01
7.4590000E+02	7.0996000E-01	3.9478000E-01	2.8028000E-01	8.2474000E-01
7.4600000E+02	7.1556000E-01	3.9508000E-01	2.8270000E-01	8.3186000E-01
7.4610000E+02	7.2121000E-01	3.9528000E-01	2.8508000E-01	8.3887000E-01
7.4620000E+02	7.2687000E-01	3.9549000E-01	2.8747000E-01	8.4590000E-01
7.4630000E+02	7.3254000E-01	3.9570000E-01	2.8986000E-01	8.5293000E-01
7.4640000E+02	7.3817000E-01	3.9590000E-01	2.9224000E-01	8.5994000E-01
7.4650000E+02	7.4376000E-01	3.9611000E-01	2.9461000E-01	8.6690000E-01
7.4660000E+02	7.4929000E-01	3.9633000E-01	2.9696000E-01	8.7383000E-01
7.4670000E+02	7.5475000E-01	3.9654000E-01	2.9929000E-01	8.8067000E-01
7.4680000E+02	7.6012000E-01	3.9676000E-01	3.0159000E-01	8.8743000E-01
7.4690000E+02	7.6540000E-01	3.9698000E-01	3.0385000E-01	8.9408000E-01
7.4700000E+02	7.7058000E-01	3.9719000E-01	3.0607000E-01	9.0062000E-01
7.4710000E+02	7.7565000E-01	3.9741000E-01	3.0825000E-01	9.0705000E-01
7.4720000E+02	7.8061000E-01	3.9763000E-01	3.1039000E-01	9.1335000E-01
7.4730000E+02	7.8544000E-01	3.9785000E-01	3.1249000E-01	9.1951000E-01
7.4740000E+02	7.9015000E-01	3.9807000E-01	3.1453000E-01	9.2553000E-01
7.4750000E+02	7.9471000E-01	3.9829000E-01	3.1653000E-01	9.3139000E-01
7.4760000E+02	7.9912000E-01	3.9851000E-01	3.1846000E-01	9.3707000E-01
7.4770000E+02	8.0337000E-01	3.9873000E-01	3.2033000E-01	9.4257000E-01
7.4780000E+02	8.0743000E-01	3.9895000E-01	3.2212000E-01	9.4786000E-01
7.4790000E+02	8.1130000E-01	3.9917000E-01	3.2384000E-01	9.5292000E-01
7.4800000E+02	8.1495000E-01	3.9938000E-01	3.2548000E-01	9.5773000E-01
7.4810000E+02	8.1837000E-01	3.9975000E-01	3.2715000E-01	9.6264000E-01
7.4820000E+02	8.2154000E-01	4.0012000E-01	3.2872000E-01	9.6726000E-01
7.4830000E+02	8.2445000E-01	4.0049000E-01	3.3019000E-01	9.7158000E-01
7.4840000E+02	8.2709000E-01	4.0086000E-01	3.3155000E-01	9.7559000E-01
7.4850000E+02	8.2944000E-01	4.0123000E-01	3.3280000E-01	9.7927000E-01
7.4860000E+02	8.3149000E-01	4.0161000E-01	3.3394000E-01	9.8262000E-01
7.4870000E+02	8.3326000E-01	4.0198000E-01	3.3496000E-01	9.8562000E-01
7.4880000E+02	8.3473000E-01	4.0236000E-01	3.3586000E-01	9.8829000E-01
7.4890000E+02	8.3592000E-01	4.0273000E-01	3.3665000E-01	9.9061000E-01
7.4900000E+02	8.3684000E-01	4.0311000E-01	3.3733000E-01	9.9262000E-01
7.4910000E+02	8.3749000E-01	4.0348000E-01	3.3791000E-01	9.9432000E-01
7.4920000E+02	8.3790000E-01	4.0386000E-01	3.3839000E-01	9.9574000E-01

7.4930000E+02	8.3809000E-01	4.0423000E-01	3.3878000E-01	9.9689000E-01
7.4940000E+02	8.3808000E-01	4.0461000E-01	3.3910000E-01	9.9781000E-01
7.4950000E+02	8.3790000E-01	4.0498000E-01	3.3934000E-01	9.9852000E-01
7.4960000E+02	8.3758000E-01	4.0536000E-01	3.3952000E-01	9.9905000E-01
7.4970000E+02	8.3713000E-01	4.0574000E-01	3.3965000E-01	9.9944000E-01
7.4980000E+02	8.3658000E-01	4.0611000E-01	3.3974000E-01	9.9971000E-01
7.4990000E+02	8.3595000E-01	4.0649000E-01	3.3981000E-01	9.9989000E-01
7.5000000E+02	8.3527000E-01	4.0687000E-01	3.3984000E-01	1.0000000E+00
7.5010000E+02	8.3454000E-01	4.0712000E-01	3.3976000E-01	9.9975000E-01
7.5020000E+02	8.3379000E-01	4.0737000E-01	3.3966000E-01	9.9947000E-01
7.5030000E+02	8.3302000E-01	4.0762000E-01	3.3956000E-01	9.9916000E-01
7.5040000E+02	8.3223000E-01	4.0787000E-01	3.3944000E-01	9.9882000E-01
7.5050000E+02	8.3144000E-01	4.0812000E-01	3.3932000E-01	9.9847000E-01
7.5060000E+02	8.3063000E-01	4.0836000E-01	3.3920000E-01	9.9810000E-01
7.5070000E+02	8.2981000E-01	4.0861000E-01	3.3907000E-01	9.9771000E-01
7.5080000E+02	8.2897000E-01	4.0885000E-01	3.3893000E-01	9.9730000E-01
7.5090000E+02	8.2811000E-01	4.0910000E-01	3.3878000E-01	9.9687000E-01
7.5100000E+02	8.2722000E-01	4.0934000E-01	3.3862000E-01	9.9640000E-01
7.5110000E+02	8.2630000E-01	4.0959000E-01	3.3844000E-01	9.9588000E-01
7.5120000E+02	8.2533000E-01	4.0983000E-01	3.3825000E-01	9.9530000E-01
7.5130000E+02	8.2431000E-01	4.1008000E-01	3.3803000E-01	9.9467000E-01
7.5140000E+02	8.2323000E-01	4.1033000E-01	3.3779000E-01	9.9397000E-01
7.5150000E+02	8.2209000E-01	4.1057000E-01	3.3753000E-01	9.9319000E-01
7.5160000E+02	8.2089000E-01	4.1082000E-01	3.3723000E-01	9.9233000E-01
7.5170000E+02	8.1961000E-01	4.1106000E-01	3.3691000E-01	9.9137000E-01
7.5180000E+02	8.1825000E-01	4.1131000E-01	3.3656000E-01	9.9033000E-01
7.5190000E+02	8.1681000E-01	4.1156000E-01	3.3617000E-01	9.8918000E-01
7.5200000E+02	8.1529000E-01	4.1180000E-01	3.3574000E-01	9.8793000E-01
7.5210000E+02	8.1367000E-01	4.1210000E-01	3.3532000E-01	9.8668000E-01
7.5220000E+02	8.1195000E-01	4.1240000E-01	3.3485000E-01	9.8531000E-01
7.5230000E+02	8.1012000E-01	4.1270000E-01	3.3434000E-01	9.8380000E-01
7.5240000E+02	8.0816000E-01	4.1300000E-01	3.3377000E-01	9.8213000E-01
7.5250000E+02	8.0607000E-01	4.1330000E-01	3.3314000E-01	9.8029000E-01
7.5260000E+02	8.0382000E-01	4.1359000E-01	3.3245000E-01	9.7826000E-01
7.5270000E+02	8.0140000E-01	4.1389000E-01	3.3169000E-01	9.7601000E-01
7.5280000E+02	7.9878000E-01	4.1419000E-01	3.3084000E-01	9.7352000E-01
7.5290000E+02	7.9596000E-01	4.1448000E-01	3.2991000E-01	9.7077000E-01
7.5300000E+02	7.9290000E-01	4.1478000E-01	3.2888000E-01	9.6773000E-01
7.5310000E+02	7.8958000E-01	4.1507000E-01	3.2773000E-01	9.6437000E-01
7.5320000E+02	7.8598000E-01	4.1537000E-01	3.2647000E-01	9.6066000E-01
7.5330000E+02	7.8208000E-01	4.1566000E-01	3.2508000E-01	9.5657000E-01
7.5340000E+02	7.7786000E-01	4.1596000E-01	3.2356000E-01	9.5208000E-01
7.5350000E+02	7.7330000E-01	4.1625000E-01	3.2189000E-01	9.4717000E-01

7.5360000E+02	7.6838000E-01	4.1655000E-01	3.2007000E-01	9.4181000E-01
7.5370000E+02	7.6310000E-01	4.1684000E-01	3.1809000E-01	9.3599000E-01
7.5380000E+02	7.5743000E-01	4.1713000E-01	3.1595000E-01	9.2969000E-01
7.5390000E+02	7.5136000E-01	4.1743000E-01	3.1364000E-01	9.2290000E-01
7.5400000E+02	7.4491000E-01	4.1772000E-01	3.1116000E-01	9.1561000E-01
7.5410000E+02	7.3805000E-01	4.1794000E-01	3.0846000E-01	9.0766000E-01
7.5420000E+02	7.3079000E-01	4.1816000E-01	3.0559000E-01	8.9920000E-01
7.5430000E+02	7.2313000E-01	4.1836000E-01	3.0253000E-01	8.9020000E-01
7.5440000E+02	7.1508000E-01	4.1855000E-01	2.9930000E-01	8.8069000E-01
7.5450000E+02	7.0664000E-01	4.1874000E-01	2.9590000E-01	8.7069000E-01
7.5460000E+02	6.9781000E-01	4.1893000E-01	2.9234000E-01	8.6021000E-01
7.5470000E+02	6.8861000E-01	4.1913000E-01	2.8861000E-01	8.4926000E-01
7.5480000E+02	6.7903000E-01	4.1932000E-01	2.8473000E-01	8.3783000E-01
7.5490000E+02	6.6910000E-01	4.1951000E-01	2.8070000E-01	8.2596000E-01
7.5500000E+02	6.5882000E-01	4.1970000E-01	2.7651000E-01	8.1364000E-01
7.5510000E+02	6.4819000E-01	4.1989000E-01	2.7217000E-01	8.0087000E-01
7.5520000E+02	6.3723000E-01	4.2008000E-01	2.6769000E-01	7.8768000E-01
7.5530000E+02	6.2596000E-01	4.2026000E-01	2.6307000E-01	7.7409000E-01
7.5540000E+02	6.1438000E-01	4.2045000E-01	2.5832000E-01	7.6010000E-01
7.5550000E+02	6.0250000E-01	4.2064000E-01	2.5344000E-01	7.4574000E-01
7.5560000E+02	5.9035000E-01	4.2082000E-01	2.4844000E-01	7.3103000E-01
7.5570000E+02	5.7795000E-01	4.2101000E-01	2.4332000E-01	7.1599000E-01
7.5580000E+02	5.6530000E-01	4.2120000E-01	2.3811000E-01	7.0063000E-01
7.5590000E+02	5.5245000E-01	4.2138000E-01	2.3279000E-01	6.8500000E-01
7.5600000E+02	5.3940000E-01	4.2157000E-01	2.2740000E-01	6.6912000E-01
7.5610000E+02	5.2619000E-01	4.2198000E-01	2.2204000E-01	6.5337000E-01
7.5620000E+02	5.1285000E-01	4.2238000E-01	2.1662000E-01	6.3741000E-01
7.5630000E+02	4.9942000E-01	4.2277000E-01	2.1114000E-01	6.2129000E-01
7.5640000E+02	4.8591000E-01	4.2317000E-01	2.0562000E-01	6.0505000E-01
7.5650000E+02	4.7238000E-01	4.2356000E-01	2.0008000E-01	5.8874000E-01
7.5660000E+02	4.5885000E-01	4.2395000E-01	1.9453000E-01	5.7241000E-01
7.5670000E+02	4.4535000E-01	4.2435000E-01	1.8898000E-01	5.5609000E-01
7.5680000E+02	4.3193000E-01	4.2474000E-01	1.8346000E-01	5.3983000E-01
7.5690000E+02	4.1861000E-01	4.2513000E-01	1.7797000E-01	5.2367000E-01
7.5700000E+02	4.0543000E-01	4.2553000E-01	1.7252000E-01	5.0765000E-01
7.5710000E+02	3.9240000E-01	4.2592000E-01	1.6713000E-01	4.9179000E-01
7.5720000E+02	3.7956000E-01	4.2631000E-01	1.6181000E-01	4.7614000E-01
7.5730000E+02	3.6693000E-01	4.2671000E-01	1.5657000E-01	4.6072000E-01
7.5740000E+02	3.5451000E-01	4.2711000E-01	1.5141000E-01	4.4554000E-01
7.5750000E+02	3.4232000E-01	4.2750000E-01	1.4634000E-01	4.3062000E-01
7.5760000E+02	3.3038000E-01	4.2790000E-01	1.4137000E-01	4.1598000E-01
7.5770000E+02	3.1868000E-01	4.2829000E-01	1.3649000E-01	4.0163000E-01
7.5780000E+02	3.0724000E-01	4.2869000E-01	1.3171000E-01	3.8756000E-01

7.5790000E+02	2.9604000E-01	4.2908000E-01	1.2703000E-01	3.7378000E-01
7.5800000E+02	2.8509000E-01	4.2948000E-01	1.2244000E-01	3.6029000E-01
7.5810000E+02	2.7439000E-01	4.2996000E-01	1.1798000E-01	3.4715000E-01
7.5820000E+02	2.6392000E-01	4.3043000E-01	1.1360000E-01	3.3427000E-01
7.5830000E+02	2.5370000E-01	4.3090000E-01	1.0932000E-01	3.2167000E-01
7.5840000E+02	2.4370000E-01	4.3137000E-01	1.0513000E-01	3.0933000E-01
7.5850000E+02	2.3394000E-01	4.3184000E-01	1.0102000E-01	2.9727000E-01
7.5860000E+02	2.2441000E-01	4.3231000E-01	9.7013000E-02	2.8546000E-01
7.5870000E+02	2.1511000E-01	4.3278000E-01	9.3093000E-02	2.7393000E-01
7.5880000E+02	2.0604000E-01	4.3325000E-01	8.9265000E-02	2.6267000E-01
7.5890000E+02	1.9720000E-01	4.3372000E-01	8.5531000E-02	2.5168000E-01
7.5900000E+02	1.8861000E-01	4.3419000E-01	8.1893000E-02	2.4097000E-01
7.5910000E+02	1.8027000E-01	4.3466000E-01	7.8355000E-02	2.3056000E-01
7.5920000E+02	1.7218000E-01	4.3513000E-01	7.4920000E-02	2.2046000E-01
7.5930000E+02	1.6435000E-01	4.3560000E-01	7.1592000E-02	2.1066000E-01
7.5940000E+02	1.5679000E-01	4.3607000E-01	6.8374000E-02	2.0119000E-01
7.5950000E+02	1.4951000E-01	4.3655000E-01	6.5268000E-02	1.9205000E-01
7.5960000E+02	1.4251000E-01	4.3702000E-01	6.2279000E-02	1.8326000E-01
7.5970000E+02	1.3579000E-01	4.3749000E-01	5.9406000E-02	1.7481000E-01
7.5980000E+02	1.2935000E-01	4.3796000E-01	5.6653000E-02	1.6670000E-01
7.5990000E+02	1.2321000E-01	4.3844000E-01	5.4018000E-02	1.5895000E-01
7.6000000E+02	1.1734000E-01	4.3891000E-01	5.1501000E-02	1.5154000E-01
7.6010000E+02	1.1175000E-01	4.3924000E-01	4.9084000E-02	1.4443000E-01
7.6020000E+02	1.0643000E-01	4.3957000E-01	4.6782000E-02	1.3766000E-01
7.6030000E+02	1.0136000E-01	4.3990000E-01	4.4590000E-02	1.3121000E-01
7.6040000E+02	9.6548000E-02	4.4024000E-01	4.2504000E-02	1.2507000E-01
7.6050000E+02	9.1968000E-02	4.4057000E-01	4.0518000E-02	1.1923000E-01
7.6060000E+02	8.7611000E-02	4.4090000E-01	3.8627000E-02	1.1366000E-01
7.6070000E+02	8.3461000E-02	4.4123000E-01	3.6825000E-02	1.0836000E-01
7.6080000E+02	7.9506000E-02	4.4156000E-01	3.5106000E-02	1.0330000E-01
7.6090000E+02	7.5732000E-02	4.4189000E-01	3.3465000E-02	9.8473000E-02
7.6100000E+02	7.2127000E-02	4.4222000E-01	3.1896000E-02	9.3856000E-02
7.6110000E+02	6.8681000E-02	4.4255000E-01	3.0395000E-02	8.9438000E-02
7.6120000E+02	6.5384000E-02	4.4288000E-01	2.8957000E-02	8.5207000E-02
7.6130000E+02	6.2228000E-02	4.4320000E-01	2.7580000E-02	8.1154000E-02
7.6140000E+02	5.9208000E-02	4.4353000E-01	2.6260000E-02	7.7272000E-02
7.6150000E+02	5.6318000E-02	4.4386000E-01	2.4997000E-02	7.3556000E-02
7.6160000E+02	5.3557000E-02	4.4419000E-01	2.3789000E-02	7.0001000E-02
7.6170000E+02	5.0922000E-02	4.4451000E-01	2.2636000E-02	6.6606000E-02
7.6180000E+02	4.8412000E-02	4.4484000E-01	2.1536000E-02	6.3369000E-02
7.6190000E+02	4.6026000E-02	4.4517000E-01	2.0489000E-02	6.0291000E-02
7.6200000E+02	4.3764000E-02	4.4548000E-01	1.9496000E-02	5.7368000E-02
7.6210000E+02	4.1625000E-02	4.4574000E-01	1.8554000E-02	5.4595000E-02

7.6220000E+02	3.9607000E-02	4.4599000E-01	1.7664000E-02	5.1977000E-02
7.6230000E+02	3.7707000E-02	4.4624000E-01	1.6827000E-02	4.9513000E-02
7.6240000E+02	3.5923000E-02	4.4650000E-01	1.6040000E-02	4.7197000E-02
7.6250000E+02	3.4250000E-02	4.4675000E-01	1.5301000E-02	4.5024000E-02
7.6260000E+02	3.2681000E-02	4.4701000E-01	1.4608000E-02	4.2986000E-02
7.6270000E+02	3.1209000E-02	4.4726000E-01	1.3958000E-02	4.1073000E-02
7.6280000E+02	2.9826000E-02	4.4751000E-01	1.3348000E-02	3.9276000E-02
7.6290000E+02	2.8524000E-02	4.4777000E-01	1.2772000E-02	3.7583000E-02
7.6300000E+02	2.7293000E-02	4.4802000E-01	1.2228000E-02	3.5981000E-02
7.6310000E+02	2.6124000E-02	4.4827000E-01	1.1711000E-02	3.4459000E-02
7.6320000E+02	2.5008000E-02	4.4852000E-01	1.1217000E-02	3.3005000E-02
7.6330000E+02	2.3937000E-02	4.4877000E-01	1.0742000E-02	3.1609000E-02
7.6340000E+02	2.2903000E-02	4.4902000E-01	1.0284000E-02	3.0260000E-02
7.6350000E+02	2.1901000E-02	4.4927000E-01	9.8392000E-03	2.8952000E-02
7.6360000E+02	2.0926000E-02	4.4951000E-01	9.4065000E-03	2.7679000E-02
7.6370000E+02	1.9976000E-02	4.4976000E-01	8.9846000E-03	2.6438000E-02
7.6380000E+02	1.9051000E-02	4.5001000E-01	8.5731000E-03	2.5227000E-02
7.6390000E+02	1.8150000E-02	4.5026000E-01	8.1724000E-03	2.4047000E-02
7.6400000E+02	1.7277000E-02	4.5050000E-01	7.7835000E-03	2.2903000E-02
7.6410000E+02	1.6436000E-02	4.5075000E-01	7.4084000E-03	2.1800000E-02
7.6420000E+02	1.5630000E-02	4.5100000E-01	7.0491000E-03	2.0742000E-02
7.6430000E+02	1.4865000E-02	4.5125000E-01	6.7080000E-03	1.9739000E-02
7.6440000E+02	1.4147000E-02	4.5150000E-01	6.3873000E-03	1.8795000E-02
7.6450000E+02	1.3480000E-02	4.5175000E-01	6.0894000E-03	1.7918000E-02
7.6460000E+02	1.2868000E-02	4.5200000E-01	5.8162000E-03	1.7115000E-02
7.6470000E+02	1.2314000E-02	4.5225000E-01	5.5691000E-03	1.6387000E-02
7.6480000E+02	1.1820000E-02	4.5250000E-01	5.3488000E-03	1.5739000E-02
7.6490000E+02	1.1386000E-02	4.5275000E-01	5.1552000E-03	1.5169000E-02
7.6500000E+02	1.1010000E-02	4.5300000E-01	4.9875000E-03	1.4676000E-02
7.6510000E+02	1.0686000E-02	4.5325000E-01	4.8436000E-03	1.4253000E-02
7.6520000E+02	1.0410000E-02	4.5350000E-01	4.7212000E-03	1.3892000E-02
7.6530000E+02	1.0174000E-02	4.5376000E-01	4.6167000E-03	1.3585000E-02
7.6540000E+02	9.9691000E-03	4.5401000E-01	4.5260000E-03	1.3318000E-02
7.6550000E+02	9.7847000E-03	4.5426000E-01	4.4448000E-03	1.3079000E-02
7.6560000E+02	9.6107000E-03	4.5451000E-01	4.3681000E-03	1.2853000E-02
7.6570000E+02	9.4366000E-03	4.5476000E-01	4.2914000E-03	1.2627000E-02
7.6580000E+02	9.2524000E-03	4.5501000E-01	4.2099000E-03	1.2388000E-02
7.6590000E+02	9.0491000E-03	4.5526000E-01	4.1197000E-03	1.2122000E-02
7.6600000E+02	8.4198000E-03	4.5552000E-01	3.8354000E-03	1.1286000E-02
7.6610000E+02	8.1116000E-03	4.5595000E-01	3.6985000E-03	1.0883000E-02
7.6620000E+02	7.8011000E-03	4.5638000E-01	3.5603000E-03	1.0476000E-02
7.6630000E+02	7.4883000E-03	4.5681000E-01	3.4208000E-03	1.0066000E-02
7.6640000E+02	7.1738000E-03	4.5725000E-01	3.2802000E-03	9.6520000E-03

7.6650000E+02	6.8589000E-03	4.5768000E-01	3.1392000E-03	9.2371000E-03
7.6660000E+02	6.5458000E-03	4.5811000E-01	2.9987000E-03	8.8237000E-03
7.6670000E+02	6.2369000E-03	4.5854000E-01	2.8598000E-03	8.4152000E-03
7.6680000E+02	5.9352000E-03	4.5897000E-01	2.7241000E-03	8.0157000E-03
7.6690000E+02	5.6439000E-03	4.5940000E-01	2.5928000E-03	7.6295000E-03
7.6700000E+02	5.3664000E-03	4.5983000E-01	2.4676000E-03	7.2611000E-03
7.6710000E+02	5.1059000E-03	4.6026000E-01	2.3501000E-03	6.9152000E-03
7.6720000E+02	4.8655000E-03	4.6070000E-01	2.2416000E-03	6.5959000E-03
7.6730000E+02	4.6479000E-03	4.6113000E-01	2.1433000E-03	6.3067000E-03
7.6740000E+02	4.4552000E-03	4.6157000E-01	2.0564000E-03	6.0509000E-03
7.6750000E+02	4.2888000E-03	4.6200000E-01	1.9814000E-03	5.8304000E-03
7.6760000E+02	4.1497000E-03	4.6243000E-01	1.9190000E-03	5.6466000E-03
7.6770000E+02	4.0379000E-03	4.6287000E-01	1.8690000E-03	5.4997000E-03
7.6780000E+02	3.9526000E-03	4.6329000E-01	1.8312000E-03	5.3885000E-03
7.6790000E+02	3.8925000E-03	4.6372000E-01	1.8050000E-03	5.3113000E-03
7.6800000E+02	3.8552000E-03	4.6414000E-01	1.7894000E-03	5.2652000E-03
7.6810000E+02	3.8382000E-03	4.6442000E-01	1.7825000E-03	5.2451000E-03
7.6820000E+02	3.8380000E-03	4.6470000E-01	1.7835000E-03	5.2481000E-03
7.6830000E+02	3.8513000E-03	4.6498000E-01	1.7908000E-03	5.2695000E-03
7.6840000E+02	3.8742000E-03	4.6526000E-01	1.8025000E-03	5.3040000E-03
7.6850000E+02	3.9030000E-03	4.6554000E-01	1.8170000E-03	5.3466000E-03
7.6860000E+02	3.9340000E-03	4.6583000E-01	1.8326000E-03	5.3924000E-03
7.6870000E+02	3.9639000E-03	4.6611000E-01	1.8476000E-03	5.4367000E-03
7.6880000E+02	3.9898000E-03	4.6639000E-01	1.8608000E-03	5.4755000E-03
7.6890000E+02	4.0093000E-03	4.6667000E-01	1.8710000E-03	5.5055000E-03
7.6900000E+02	4.0206000E-03	4.6695000E-01	1.8774000E-03	5.5243000E-03
7.6910000E+02	4.0225000E-03	4.6723000E-01	1.8794000E-03	5.5302000E-03
7.6920000E+02	4.0145000E-03	4.6750000E-01	1.8768000E-03	5.5225000E-03
7.6930000E+02	3.9967000E-03	4.6778000E-01	1.8696000E-03	5.5013000E-03
7.6940000E+02	3.9698000E-03	4.6806000E-01	1.8581000E-03	5.4675000E-03
7.6950000E+02	0.0000000E+00	4.6806000E-01	0.0000000E+00	0.0000000E+00
Channel 8				
Wavenumber	HIRS Filter Transmittance	Optical Element Transmittance	Product of the HIRS Filter and Optical Element Transmittances	Normalized Value of Column 4
8.6918000E+02	0.0000000E+00	4.8103000E-01	0.0000000E+00	0.0000000E+00
8.6928000E+02	3.9206000E-03	4.8121000E-01	1.8866000E-03	4.0997000E-03
8.6938000E+02	3.9380000E-03	4.8140000E-01	1.8958000E-03	4.1196000E-03
8.6948000E+02	3.9830000E-03	4.8159000E-01	1.9182000E-03	4.1683000E-03
8.6958000E+02	4.0573000E-03	4.8179000E-01	1.9548000E-03	4.2478000E-03
8.6968000E+02	4.1626000E-03	4.8198000E-01	2.0063000E-03	4.3597000E-03
8.6978000E+02	4.2995000E-03	4.8217000E-01	2.0731000E-03	4.5050000E-03

8.6988000E+02	4.4685000E-03	4.8237000E-01	2.1555000E-03	4.6839000E-03
8.6998000E+02	4.6693000E-03	4.8256000E-01	2.2532000E-03	4.8963000E-03
8.7008000E+02	4.9012000E-03	4.8263000E-01	2.3655000E-03	5.1403000E-03
8.7018000E+02	5.1633000E-03	4.8267000E-01	2.4922000E-03	5.4156000E-03
8.7028000E+02	5.4541000E-03	4.8272000E-01	2.6328000E-03	5.7212000E-03
8.7038000E+02	5.7724000E-03	4.8276000E-01	2.7867000E-03	6.0556000E-03
8.7048000E+02	6.1166000E-03	4.8281000E-01	2.9532000E-03	6.4173000E-03
8.7058000E+02	6.4855000E-03	4.8285000E-01	3.1315000E-03	6.8049000E-03
8.7068000E+02	6.8776000E-03	4.8290000E-01	3.3212000E-03	7.2171000E-03
8.7078000E+02	7.2919000E-03	4.8295000E-01	3.5216000E-03	7.6526000E-03
8.7088000E+02	7.7274000E-03	4.8300000E-01	3.7323000E-03	8.1104000E-03
8.7098000E+02	8.1833000E-03	4.8304000E-01	3.9529000E-03	8.5898000E-03
8.7108000E+02	8.6589000E-03	4.8310000E-01	4.1831000E-03	9.0900000E-03
8.7118000E+02	9.1537000E-03	4.8315000E-01	4.4226000E-03	9.6105000E-03
8.7128000E+02	9.6673000E-03	4.8320000E-01	4.6712000E-03	1.0151000E-02
8.7138000E+02	1.0199000E-02	4.8326000E-01	4.9288000E-03	1.0711000E-02
8.7148000E+02	1.0749000E-02	4.8331000E-01	5.1953000E-03	1.1290000E-02
8.7158000E+02	1.1317000E-02	4.8336000E-01	5.4704000E-03	1.1887000E-02
8.7168000E+02	1.1903000E-02	4.8342000E-01	5.7542000E-03	1.2504000E-02
8.7178000E+02	1.2507000E-02	4.8348000E-01	6.0466000E-03	1.3140000E-02
8.7188000E+02	1.3128000E-02	4.8353000E-01	6.3476000E-03	1.3794000E-02
8.7198000E+02	1.3766000E-02	4.8359000E-01	6.6569000E-03	1.4466000E-02
8.7208000E+02	1.4421000E-02	4.8373000E-01	6.9758000E-03	1.5159000E-02
8.7218000E+02	1.5093000E-02	4.8389000E-01	7.3035000E-03	1.5871000E-02
8.7228000E+02	1.5782000E-02	4.8406000E-01	7.6395000E-03	1.6601000E-02
8.7238000E+02	1.6488000E-02	4.8422000E-01	7.9839000E-03	1.7349000E-02
8.7248000E+02	1.7211000E-02	4.8439000E-01	8.3366000E-03	1.8116000E-02
8.7258000E+02	1.7949000E-02	4.8455000E-01	8.6975000E-03	1.8900000E-02
8.7268000E+02	1.8705000E-02	4.8472000E-01	9.0665000E-03	1.9702000E-02
8.7278000E+02	1.9476000E-02	4.8489000E-01	9.4437000E-03	2.0522000E-02
8.7288000E+02	2.0264000E-02	4.8506000E-01	9.8292000E-03	2.1359000E-02
8.7298000E+02	2.1068000E-02	4.8523000E-01	1.0223000E-02	2.2215000E-02
8.7308000E+02	2.1889000E-02	4.8539000E-01	1.0625000E-02	2.3088000E-02
8.7318000E+02	2.2727000E-02	4.8555000E-01	1.1035000E-02	2.3979000E-02
8.7328000E+02	2.3582000E-02	4.8571000E-01	1.1454000E-02	2.4890000E-02
8.7338000E+02	2.4454000E-02	4.8588000E-01	1.1882000E-02	2.5820000E-02
8.7348000E+02	2.5345000E-02	4.8604000E-01	1.2319000E-02	2.6770000E-02
8.7358000E+02	2.6256000E-02	4.8621000E-01	1.2766000E-02	2.7741000E-02
8.7368000E+02	2.7187000E-02	4.8637000E-01	1.3223000E-02	2.8734000E-02
8.7378000E+02	2.8139000E-02	4.8654000E-01	1.3691000E-02	2.9751000E-02
8.7388000E+02	2.9115000E-02	4.8671000E-01	1.4171000E-02	3.0794000E-02
8.7398000E+02	3.0117000E-02	4.8689000E-01	1.4664000E-02	3.1864000E-02
8.7408000E+02	3.1145000E-02	4.8703000E-01	1.5168000E-02	3.2962000E-02

8.7418000E+02	3.2203000E-02	4.8715000E-01	1.5688000E-02	3.4090000E-02
8.7428000E+02	3.3293000E-02	4.8728000E-01	1.6223000E-02	3.5253000E-02
8.7438000E+02	3.4418000E-02	4.8740000E-01	1.6776000E-02	3.6454000E-02
8.7448000E+02	3.5582000E-02	4.8753000E-01	1.7347000E-02	3.7696000E-02
8.7458000E+02	3.6787000E-02	4.8766000E-01	1.7940000E-02	3.8984000E-02
8.7468000E+02	3.8039000E-02	4.8779000E-01	1.8555000E-02	4.0321000E-02
8.7478000E+02	3.9341000E-02	4.8792000E-01	1.9195000E-02	4.1712000E-02
8.7488000E+02	4.0697000E-02	4.8805000E-01	1.9862000E-02	4.3161000E-02
8.7498000E+02	4.2113000E-02	4.8818000E-01	2.0559000E-02	4.4675000E-02
8.7508000E+02	4.3594000E-02	4.8831000E-01	2.1288000E-02	4.6259000E-02
8.7518000E+02	4.5145000E-02	4.8845000E-01	2.2051000E-02	4.7917000E-02
8.7528000E+02	4.6772000E-02	4.8858000E-01	2.2852000E-02	4.9658000E-02
8.7538000E+02	4.8481000E-02	4.8872000E-01	2.3693000E-02	5.1487000E-02
8.7548000E+02	5.0278000E-02	4.8885000E-01	2.4579000E-02	5.3410000E-02
8.7558000E+02	5.1666000E-02	4.8899000E-01	2.5264000E-02	5.4900000E-02
8.7568000E+02	5.3625000E-02	4.8913000E-01	2.6230000E-02	5.6998000E-02
8.7578000E+02	5.5691000E-02	4.8926000E-01	2.7248000E-02	5.9210000E-02
8.7588000E+02	5.7872000E-02	4.8939000E-01	2.8322000E-02	6.1545000E-02
8.7598000E+02	6.0175000E-02	4.8952000E-01	2.9457000E-02	6.4011000E-02
8.7608000E+02	6.2607000E-02	4.8975000E-01	3.0662000E-02	6.6629000E-02
8.7618000E+02	6.5176000E-02	4.9000000E-01	3.1936000E-02	6.9399000E-02
8.7628000E+02	6.7889000E-02	4.9025000E-01	3.3283000E-02	7.2325000E-02
8.7638000E+02	7.0754000E-02	4.9051000E-01	3.4705000E-02	7.5416000E-02
8.7648000E+02	7.3778000E-02	4.9076000E-01	3.6207000E-02	7.8680000E-02
8.7658000E+02	7.6968000E-02	4.9101000E-01	3.7793000E-02	8.2125000E-02
8.7668000E+02	8.0332000E-02	4.9127000E-01	3.9465000E-02	8.5758000E-02
8.7678000E+02	8.3877000E-02	4.9152000E-01	4.1228000E-02	8.9589000E-02
8.7688000E+02	8.7610000E-02	4.9178000E-01	4.3085000E-02	9.3625000E-02
8.7698000E+02	9.1538000E-02	4.9203000E-01	4.5040000E-02	9.7873000E-02
8.7708000E+02	9.5667000E-02	4.9229000E-01	4.7096000E-02	1.0234000E-01
8.7718000E+02	1.0000000E-01	4.9255000E-01	4.9257000E-02	1.0704000E-01
8.7728000E+02	1.0455000E-01	4.9281000E-01	5.1525000E-02	1.1197000E-01
8.7738000E+02	1.0932000E-01	4.9307000E-01	5.3905000E-02	1.1714000E-01
8.7748000E+02	1.1432000E-01	4.9333000E-01	5.6397000E-02	1.2255000E-01
8.7758000E+02	1.1954000E-01	4.9359000E-01	5.9006000E-02	1.2822000E-01
8.7768000E+02	1.2501000E-01	4.9385000E-01	6.1734000E-02	1.3415000E-01
8.7778000E+02	1.3070000E-01	4.9410000E-01	6.4581000E-02	1.4034000E-01
8.7788000E+02	1.3665000E-01	4.9435000E-01	6.7552000E-02	1.4679000E-01
8.7798000E+02	1.4284000E-01	4.9461000E-01	7.0648000E-02	1.5352000E-01
8.7808000E+02	1.4928000E-01	4.9480000E-01	7.3862000E-02	1.6050000E-01
8.7818000E+02	1.5596000E-01	4.9499000E-01	7.7201000E-02	1.6776000E-01
8.7828000E+02	1.6291000E-01	4.9517000E-01	8.0667000E-02	1.7529000E-01
8.7838000E+02	1.7010000E-01	4.9536000E-01	8.4262000E-02	1.8310000E-01

8.7848000E+02	1.7755000E-01	4.9554000E-01	8.7986000E-02	1.9120000E-01
8.7858000E+02	1.8526000E-01	4.9573000E-01	9.1840000E-02	1.9957000E-01
8.7868000E+02	1.9322000E-01	4.9592000E-01	9.5822000E-02	2.0822000E-01
8.7878000E+02	2.0143000E-01	4.9610000E-01	9.9932000E-02	2.1716000E-01
8.7888000E+02	2.0990000E-01	4.9629000E-01	1.0417000E-01	2.2637000E-01
8.7898000E+02	2.1861000E-01	4.9648000E-01	1.0853000E-01	2.3585000E-01
8.7908000E+02	2.2756000E-01	4.9666000E-01	1.1302000E-01	2.4560000E-01
8.7918000E+02	2.3676000E-01	4.9685000E-01	1.1763000E-01	2.5562000E-01
8.7928000E+02	2.4619000E-01	4.9703000E-01	1.2236000E-01	2.6590000E-01
8.7938000E+02	2.5585000E-01	4.9722000E-01	1.2721000E-01	2.7644000E-01
8.7948000E+02	2.6573000E-01	4.9740000E-01	1.3218000E-01	2.8723000E-01
8.7958000E+02	2.7584000E-01	4.9759000E-01	1.3725000E-01	2.9825000E-01
8.7968000E+02	2.8614000E-01	4.9777000E-01	1.4243000E-01	3.0952000E-01
8.7978000E+02	2.9665000E-01	4.9795000E-01	1.4772000E-01	3.2100000E-01
8.7988000E+02	3.0736000E-01	4.9814000E-01	1.5311000E-01	3.3270000E-01
8.7998000E+02	3.1824000E-01	4.9832000E-01	1.5859000E-01	3.4461000E-01
8.8008000E+02	3.2930000E-01	4.9845000E-01	1.6414000E-01	3.5668000E-01
8.8018000E+02	3.4052000E-01	4.9858000E-01	1.6977000E-01	3.6893000E-01
8.8028000E+02	3.5189000E-01	4.9870000E-01	1.7549000E-01	3.8134000E-01
8.8038000E+02	3.6340000E-01	4.9882000E-01	1.8127000E-01	3.9391000E-01
8.8048000E+02	3.7503000E-01	4.9895000E-01	1.8712000E-01	4.0662000E-01
8.8058000E+02	3.8678000E-01	4.9907000E-01	1.9303000E-01	4.1946000E-01
8.8068000E+02	3.9862000E-01	4.9919000E-01	1.9899000E-01	4.3241000E-01
8.8078000E+02	4.1056000E-01	4.9931000E-01	2.0500000E-01	4.4547000E-01
8.8088000E+02	4.2257000E-01	4.9944000E-01	2.1104000E-01	4.5861000E-01
8.8098000E+02	4.3463000E-01	4.9956000E-01	2.1712000E-01	4.7182000E-01
8.8108000E+02	4.4674000E-01	4.9968000E-01	2.2323000E-01	4.8509000E-01
8.8118000E+02	4.5889000E-01	4.9981000E-01	2.2935000E-01	4.9840000E-01
8.8128000E+02	4.7104000E-01	4.9993000E-01	2.3549000E-01	5.1173000E-01
8.8138000E+02	4.8320000E-01	5.0006000E-01	2.4163000E-01	5.2506000E-01
8.8148000E+02	4.9534000E-01	5.0018000E-01	2.4776000E-01	5.3839000E-01
8.8158000E+02	5.0745000E-01	5.0031000E-01	2.5388000E-01	5.5170000E-01
8.8168000E+02	5.1952000E-01	5.0043000E-01	2.5998000E-01	5.6496000E-01
8.8178000E+02	5.3153000E-01	5.0055000E-01	2.6606000E-01	5.7816000E-01
8.8188000E+02	5.4347000E-01	5.0068000E-01	2.7210000E-01	5.9129000E-01
8.8198000E+02	5.5532000E-01	5.0080000E-01	2.7810000E-01	6.0433000E-01
8.8208000E+02	5.6706000E-01	5.0084000E-01	2.8401000E-01	6.1716000E-01
8.8218000E+02	5.7869000E-01	5.0085000E-01	2.8984000E-01	6.2983000E-01
8.8228000E+02	5.9019000E-01	5.0087000E-01	2.9561000E-01	6.4237000E-01
8.8238000E+02	6.0155000E-01	5.0088000E-01	3.0131000E-01	6.5475000E-01
8.8248000E+02	6.1275000E-01	5.0090000E-01	3.0693000E-01	6.6696000E-01
8.8258000E+02	6.2378000E-01	5.0091000E-01	3.1246000E-01	6.7899000E-01
8.8268000E+02	6.3464000E-01	5.0093000E-01	3.1791000E-01	6.9082000E-01

8.8278000E+02	6.4530000E-01	5.0094000E-01	3.2326000E-01	7.0245000E-01
8.8288000E+02	6.5576000E-01	5.0096000E-01	3.2851000E-01	7.1386000E-01
8.8298000E+02	6.6601000E-01	5.0097000E-01	3.3365000E-01	7.2504000E-01
8.8308000E+02	6.7603000E-01	5.0099000E-01	3.3869000E-01	7.3598000E-01
8.8318000E+02	6.8583000E-01	5.0101000E-01	3.4361000E-01	7.4667000E-01
8.8328000E+02	6.9539000E-01	5.0103000E-01	3.4841000E-01	7.5710000E-01
8.8338000E+02	7.0470000E-01	5.0105000E-01	3.5309000E-01	7.6727000E-01
8.8348000E+02	7.1375000E-01	5.0106000E-01	3.5763000E-01	7.7715000E-01
8.8358000E+02	7.2255000E-01	5.0106000E-01	3.6204000E-01	7.8674000E-01
8.8368000E+02	7.3109000E-01	5.0107000E-01	3.6632000E-01	7.9603000E-01
8.8378000E+02	7.3935000E-01	5.0107000E-01	3.7047000E-01	8.0504000E-01
8.8388000E+02	7.4734000E-01	5.0107000E-01	3.7447000E-01	8.1374000E-01
8.8398000E+02	7.5506000E-01	5.0108000E-01	3.7834000E-01	8.2215000E-01
8.8408000E+02	7.6249000E-01	5.0122000E-01	3.8218000E-01	8.3049000E-01
8.8418000E+02	7.6965000E-01	5.0141000E-01	3.8591000E-01	8.3859000E-01
8.8428000E+02	7.7653000E-01	5.0159000E-01	3.8950000E-01	8.4639000E-01
8.8438000E+02	7.8312000E-01	5.0177000E-01	3.9295000E-01	8.5389000E-01
8.8448000E+02	7.8944000E-01	5.0195000E-01	3.9626000E-01	8.6109000E-01
8.8458000E+02	7.9547000E-01	5.0213000E-01	3.9943000E-01	8.6798000E-01
8.8468000E+02	8.0123000E-01	5.0231000E-01	4.0247000E-01	8.7459000E-01
8.8478000E+02	8.0672000E-01	5.0250000E-01	4.0537000E-01	8.8089000E-01
8.8488000E+02	8.1193000E-01	5.0268000E-01	4.0814000E-01	8.8690000E-01
8.8498000E+02	8.1688000E-01	5.0286000E-01	4.1077000E-01	8.9263000E-01
8.8508000E+02	8.2156000E-01	5.0304000E-01	4.1328000E-01	8.9807000E-01
8.8518000E+02	8.2599000E-01	5.0323000E-01	4.1566000E-01	9.0324000E-01
8.8528000E+02	8.3016000E-01	5.0341000E-01	4.1791000E-01	9.0814000E-01
8.8538000E+02	8.3409000E-01	5.0359000E-01	4.2004000E-01	9.1277000E-01
8.8548000E+02	8.3778000E-01	5.0379000E-01	4.2206000E-01	9.1716000E-01
8.8558000E+02	8.4123000E-01	5.0398000E-01	4.2396000E-01	9.2129000E-01
8.8568000E+02	8.4446000E-01	5.0417000E-01	4.2575000E-01	9.2518000E-01
8.8578000E+02	8.4747000E-01	5.0436000E-01	4.2743000E-01	9.2883000E-01
8.8588000E+02	8.5027000E-01	5.0456000E-01	4.2901000E-01	9.3226000E-01
8.8598000E+02	8.5287000E-01	5.0475000E-01	4.3049000E-01	9.3546000E-01
8.8608000E+02	8.5528000E-01	5.0489000E-01	4.3182000E-01	9.3837000E-01
8.8618000E+02	8.5750000E-01	5.0503000E-01	4.3306000E-01	9.4106000E-01
8.8628000E+02	8.5954000E-01	5.0516000E-01	4.3421000E-01	9.4355000E-01
8.8638000E+02	8.6142000E-01	5.0530000E-01	4.3527000E-01	9.4587000E-01
8.8648000E+02	8.6314000E-01	5.0543000E-01	4.3626000E-01	9.4801000E-01
8.8658000E+02	8.6471000E-01	5.0556000E-01	4.3717000E-01	9.4998000E-01
8.8668000E+02	8.6614000E-01	5.0570000E-01	4.3800000E-01	9.5180000E-01
8.8678000E+02	8.6743000E-01	5.0583000E-01	4.3877000E-01	9.5347000E-01
8.8688000E+02	8.6860000E-01	5.0596000E-01	4.3948000E-01	9.5501000E-01
8.8698000E+02	8.6966000E-01	5.0610000E-01	4.4013000E-01	9.5642000E-01

8.8708000E+02	8.7061000E-01	5.0623000E-01	4.4073000E-01	9.5771000E-01
8.8718000E+02	8.7146000E-01	5.0636000E-01	4.4127000E-01	9.5889000E-01
8.8728000E+02	8.7222000E-01	5.0649000E-01	4.4177000E-01	9.5998000E-01
8.8738000E+02	8.7289000E-01	5.0662000E-01	4.4223000E-01	9.6098000E-01
8.8748000E+02	8.7350000E-01	5.0676000E-01	4.4265000E-01	9.6190000E-01
8.8758000E+02	8.7403000E-01	5.0689000E-01	4.4304000E-01	9.6274000E-01
8.8768000E+02	8.7450000E-01	5.0703000E-01	4.4340000E-01	9.6352000E-01
8.8778000E+02	8.7492000E-01	5.0716000E-01	4.4373000E-01	9.6423000E-01
8.8788000E+02	8.7529000E-01	5.0730000E-01	4.4403000E-01	9.6490000E-01
8.8798000E+02	8.7561000E-01	5.0743000E-01	4.4431000E-01	9.6551000E-01
8.8808000E+02	8.7590000E-01	5.0757000E-01	4.4458000E-01	9.6608000E-01
8.8818000E+02	8.7616000E-01	5.0770000E-01	4.4482000E-01	9.6662000E-01
8.8828000E+02	8.7639000E-01	5.0783000E-01	4.4506000E-01	9.6713000E-01
8.8838000E+02	8.7660000E-01	5.0796000E-01	4.4528000E-01	9.6761000E-01
8.8848000E+02	8.7678000E-01	5.0810000E-01	4.4549000E-01	9.6807000E-01
8.8858000E+02	8.7695000E-01	5.0823000E-01	4.4569000E-01	9.6851000E-01
8.8868000E+02	8.7711000E-01	5.0836000E-01	4.4589000E-01	9.6894000E-01
8.8878000E+02	8.7726000E-01	5.0849000E-01	4.4608000E-01	9.6936000E-01
8.8888000E+02	8.7741000E-01	5.0863000E-01	4.4627000E-01	9.6977000E-01
8.8898000E+02	8.7755000E-01	5.0876000E-01	4.4646000E-01	9.7018000E-01
8.8908000E+02	8.7769000E-01	5.0889000E-01	4.4665000E-01	9.7058000E-01
8.8918000E+02	8.7782000E-01	5.0903000E-01	4.4683000E-01	9.7099000E-01
8.8928000E+02	8.7796000E-01	5.0916000E-01	4.4702000E-01	9.7139000E-01
8.8938000E+02	8.7810000E-01	5.0929000E-01	4.4720000E-01	9.7179000E-01
8.8948000E+02	8.7823000E-01	5.0942000E-01	4.4739000E-01	9.7219000E-01
8.8958000E+02	8.7838000E-01	5.0955000E-01	4.4758000E-01	9.7260000E-01
8.8968000E+02	8.7852000E-01	5.0968000E-01	4.4776000E-01	9.7301000E-01
8.8978000E+02	8.7867000E-01	5.0981000E-01	4.4795000E-01	9.7342000E-01
8.8988000E+02	8.7881000E-01	5.0994000E-01	4.4814000E-01	9.7383000E-01
8.8998000E+02	8.7896000E-01	5.1007000E-01	4.4833000E-01	9.7424000E-01
8.9008000E+02	8.7911000E-01	5.1015000E-01	4.4848000E-01	9.7456000E-01
8.9018000E+02	8.7926000E-01	5.1021000E-01	4.4861000E-01	9.7484000E-01
8.9028000E+02	8.7941000E-01	5.1027000E-01	4.4874000E-01	9.7513000E-01
8.9038000E+02	8.7956000E-01	5.1034000E-01	4.4887000E-01	9.7541000E-01
8.9048000E+02	8.7971000E-01	5.1040000E-01	4.4900000E-01	9.7570000E-01
8.9058000E+02	8.7985000E-01	5.1046000E-01	4.4913000E-01	9.7597000E-01
8.9068000E+02	8.7998000E-01	5.1053000E-01	4.4925000E-01	9.7625000E-01
8.9078000E+02	8.8011000E-01	5.1059000E-01	4.4938000E-01	9.7651000E-01
8.9088000E+02	8.8024000E-01	5.1065000E-01	4.4949000E-01	9.7677000E-01
8.9098000E+02	8.8035000E-01	5.1071000E-01	4.4961000E-01	9.7702000E-01
8.9108000E+02	8.8046000E-01	5.1078000E-01	4.4972000E-01	9.7726000E-01
8.9118000E+02	8.8055000E-01	5.1084000E-01	4.4982000E-01	9.7748000E-01
8.9128000E+02	8.8063000E-01	5.1091000E-01	4.4993000E-01	9.7771000E-01

8.9138000E+02	8.8070000E-01	5.1098000E-01	4.5002000E-01	9.7792000E-01
8.9148000E+02	8.8076000E-01	5.1105000E-01	4.5011000E-01	9.7811000E-01
8.9158000E+02	8.8080000E-01	5.1112000E-01	4.5019000E-01	9.7829000E-01
8.9168000E+02	8.8082000E-01	5.1119000E-01	4.5027000E-01	9.7845000E-01
8.9178000E+02	8.8083000E-01	5.1126000E-01	4.5033000E-01	9.7859000E-01
8.9188000E+02	8.8083000E-01	5.1133000E-01	4.5039000E-01	9.7872000E-01
8.9198000E+02	8.8081000E-01	5.1140000E-01	4.5044000E-01	9.7882000E-01
8.9208000E+02	8.8077000E-01	5.1157000E-01	4.5057000E-01	9.7911000E-01
8.9218000E+02	8.8071000E-01	5.1176000E-01	4.5072000E-01	9.7942000E-01
8.9228000E+02	8.8064000E-01	5.1196000E-01	4.5085000E-01	9.7972000E-01
8.9238000E+02	8.8055000E-01	5.1216000E-01	4.5098000E-01	9.7999000E-01
8.9248000E+02	8.8044000E-01	5.1235000E-01	4.5110000E-01	9.8025000E-01
8.9258000E+02	8.8031000E-01	5.1255000E-01	4.5121000E-01	9.8049000E-01
8.9268000E+02	8.8017000E-01	5.1275000E-01	4.5131000E-01	9.8071000E-01
8.9278000E+02	8.8001000E-01	5.1295000E-01	4.5140000E-01	9.8091000E-01
8.9288000E+02	8.7984000E-01	5.1314000E-01	4.5148000E-01	9.8109000E-01
8.9298000E+02	8.7965000E-01	5.1334000E-01	4.5156000E-01	9.8126000E-01
8.9308000E+02	8.7945000E-01	5.1354000E-01	4.5163000E-01	9.8141000E-01
8.9318000E+02	8.7923000E-01	5.1375000E-01	4.5171000E-01	9.8158000E-01
8.9328000E+02	8.7901000E-01	5.1398000E-01	4.5179000E-01	9.8175000E-01
8.9338000E+02	8.7877000E-01	5.1420000E-01	4.5186000E-01	9.8191000E-01
8.9348000E+02	8.7852000E-01	5.1442000E-01	4.5193000E-01	9.8205000E-01
8.9358000E+02	8.7826000E-01	5.1464000E-01	4.5199000E-01	9.8219000E-01
8.9368000E+02	8.7799000E-01	5.1487000E-01	4.5205000E-01	9.8231000E-01
8.9378000E+02	8.7771000E-01	5.1509000E-01	4.5210000E-01	9.8243000E-01
8.9388000E+02	8.7743000E-01	5.1531000E-01	4.5215000E-01	9.8254000E-01
8.9398000E+02	8.7714000E-01	5.1554000E-01	4.5220000E-01	9.8264000E-01
8.9408000E+02	8.7684000E-01	5.1565000E-01	4.5214000E-01	9.8253000E-01
8.9418000E+02	8.7655000E-01	5.1574000E-01	4.5207000E-01	9.8236000E-01
8.9428000E+02	8.7624000E-01	5.1582000E-01	4.5198000E-01	9.8218000E-01
8.9438000E+02	8.7594000E-01	5.1591000E-01	4.5190000E-01	9.8200000E-01
8.9448000E+02	8.7564000E-01	5.1599000E-01	4.5182000E-01	9.8182000E-01
8.9458000E+02	8.7533000E-01	5.1608000E-01	4.5174000E-01	9.8165000E-01
8.9468000E+02	8.7503000E-01	5.1616000E-01	4.5166000E-01	9.8147000E-01
8.9478000E+02	8.7473000E-01	5.1625000E-01	4.5158000E-01	9.8129000E-01
8.9488000E+02	8.7442000E-01	5.1633000E-01	4.5149000E-01	9.8112000E-01
8.9498000E+02	8.7413000E-01	5.1642000E-01	4.5142000E-01	9.8094000E-01
8.9508000E+02	8.7383000E-01	5.1652000E-01	4.5135000E-01	9.8079000E-01
8.9518000E+02	8.7353000E-01	5.1662000E-01	4.5129000E-01	9.8067000E-01
8.9528000E+02	8.7324000E-01	5.1673000E-01	4.5123000E-01	9.8055000E-01
8.9538000E+02	8.7296000E-01	5.1684000E-01	4.5118000E-01	9.8043000E-01
8.9548000E+02	8.7267000E-01	5.1695000E-01	4.5112000E-01	9.8031000E-01
8.9558000E+02	8.7239000E-01	5.1705000E-01	4.5107000E-01	9.8020000E-01

8.9568000E+02	8.7211000E-01	5.1716000E-01	4.5102000E-01	9.8009000E-01
8.9578000E+02	8.7184000E-01	5.1727000E-01	4.5098000E-01	9.7999000E-01
8.9588000E+02	8.7157000E-01	5.1738000E-01	4.5093000E-01	9.7989000E-01
8.9598000E+02	8.7131000E-01	5.1749000E-01	4.5089000E-01	9.7980000E-01
8.9608000E+02	8.7104000E-01	5.1760000E-01	4.5085000E-01	9.7971000E-01
8.9618000E+02	8.7078000E-01	5.1771000E-01	4.5081000E-01	9.7963000E-01
8.9628000E+02	8.7053000E-01	5.1782000E-01	4.5078000E-01	9.7956000E-01
8.9638000E+02	8.7027000E-01	5.1793000E-01	4.5074000E-01	9.7948000E-01
8.9648000E+02	8.7002000E-01	5.1805000E-01	4.5071000E-01	9.7941000E-01
8.9658000E+02	8.6977000E-01	5.1816000E-01	4.5068000E-01	9.7934000E-01
8.9668000E+02	8.6952000E-01	5.1827000E-01	4.5065000E-01	9.7927000E-01
8.9678000E+02	8.6927000E-01	5.1838000E-01	4.5061000E-01	9.7920000E-01
8.9688000E+02	8.6902000E-01	5.1849000E-01	4.5058000E-01	9.7914000E-01
8.9698000E+02	8.6878000E-01	5.1861000E-01	4.5056000E-01	9.7908000E-01
8.9708000E+02	8.6853000E-01	5.1874000E-01	4.5055000E-01	9.7905000E-01
8.9718000E+02	8.6829000E-01	5.1888000E-01	4.5054000E-01	9.7903000E-01
8.9728000E+02	8.6804000E-01	5.1901000E-01	4.5052000E-01	9.7901000E-01
8.9738000E+02	8.6780000E-01	5.1915000E-01	4.5051000E-01	9.7898000E-01
8.9748000E+02	8.6755000E-01	5.1928000E-01	4.5050000E-01	9.7896000E-01
8.9758000E+02	8.6731000E-01	5.1942000E-01	4.5049000E-01	9.7894000E-01
8.9768000E+02	8.6706000E-01	5.1955000E-01	4.5048000E-01	9.7892000E-01
8.9778000E+02	8.6682000E-01	5.1969000E-01	4.5047000E-01	9.7890000E-01
8.9788000E+02	8.6658000E-01	5.1982000E-01	4.5046000E-01	9.7887000E-01
8.9798000E+02	8.6633000E-01	5.1995000E-01	4.5045000E-01	9.7885000E-01
8.9808000E+02	8.6609000E-01	5.2010000E-01	4.5046000E-01	9.7887000E-01
8.9818000E+02	8.6586000E-01	5.2026000E-01	4.5047000E-01	9.7889000E-01
8.9828000E+02	8.6562000E-01	5.2041000E-01	4.5048000E-01	9.7891000E-01
8.9838000E+02	8.6539000E-01	5.2057000E-01	4.5049000E-01	9.7893000E-01
8.9848000E+02	8.6516000E-01	5.2072000E-01	4.5050000E-01	9.7896000E-01
8.9858000E+02	8.6493000E-01	5.2087000E-01	4.5052000E-01	9.7900000E-01
8.9868000E+02	8.6472000E-01	5.2103000E-01	4.5054000E-01	9.7905000E-01
8.9878000E+02	8.6450000E-01	5.2118000E-01	4.5057000E-01	9.7910000E-01
8.9888000E+02	8.6430000E-01	5.2134000E-01	4.5059000E-01	9.7916000E-01
8.9898000E+02	8.6410000E-01	5.2151000E-01	4.5063000E-01	9.7925000E-01
8.9908000E+02	8.6391000E-01	5.2168000E-01	4.5068000E-01	9.7935000E-01
8.9918000E+02	8.6373000E-01	5.2184000E-01	4.5073000E-01	9.7946000E-01
8.9928000E+02	8.6357000E-01	5.2201000E-01	4.5079000E-01	9.7959000E-01
8.9938000E+02	8.6341000E-01	5.2218000E-01	4.5086000E-01	9.7973000E-01
8.9948000E+02	8.6327000E-01	5.2235000E-01	4.5093000E-01	9.7988000E-01
8.9958000E+02	8.6314000E-01	5.2252000E-01	4.5100000E-01	9.8005000E-01
8.9968000E+02	8.6303000E-01	5.2268000E-01	4.5109000E-01	9.8024000E-01
8.9978000E+02	8.6293000E-01	5.2285000E-01	4.5118000E-01	9.8044000E-01
8.9988000E+02	8.6285000E-01	5.2302000E-01	4.5129000E-01	9.8067000E-01

8.9998000E+02	8.6278000E-01	5.2319000E-01	4.5140000E-01	9.8091000E-01
9.0008000E+02	8.6274000E-01	5.2337000E-01	4.5153000E-01	9.8120000E-01
9.0018000E+02	8.6271000E-01	5.2355000E-01	4.5168000E-01	9.8151000E-01
9.0028000E+02	8.6270000E-01	5.2374000E-01	4.5183000E-01	9.8184000E-01
9.0038000E+02	8.6271000E-01	5.2392000E-01	4.5199000E-01	9.8220000E-01
9.0048000E+02	8.6274000E-01	5.2411000E-01	4.5217000E-01	9.8258000E-01
9.0058000E+02	8.6280000E-01	5.2429000E-01	4.5235000E-01	9.8298000E-01
9.0068000E+02	8.6287000E-01	5.2447000E-01	4.5255000E-01	9.8341000E-01
9.0078000E+02	8.6296000E-01	5.2465000E-01	4.5275000E-01	9.8385000E-01
9.0088000E+02	8.6307000E-01	5.2484000E-01	4.5297000E-01	9.8432000E-01
9.0098000E+02	8.6320000E-01	5.2502000E-01	4.5320000E-01	9.8482000E-01
9.0108000E+02	8.6335000E-01	5.2521000E-01	4.5344000E-01	9.8533000E-01
9.0118000E+02	8.6351000E-01	5.2539000E-01	4.5368000E-01	9.8586000E-01
9.0128000E+02	8.6369000E-01	5.2557000E-01	4.5393000E-01	9.8641000E-01
9.0138000E+02	8.6389000E-01	5.2575000E-01	4.5419000E-01	9.8698000E-01
9.0148000E+02	8.6410000E-01	5.2593000E-01	4.5446000E-01	9.8756000E-01
9.0158000E+02	8.6433000E-01	5.2611000E-01	4.5474000E-01	9.8816000E-01
9.0168000E+02	8.6457000E-01	5.2629000E-01	4.5502000E-01	9.8877000E-01
9.0178000E+02	8.6482000E-01	5.2647000E-01	4.5530000E-01	9.8939000E-01
9.0188000E+02	8.6507000E-01	5.2665000E-01	4.5559000E-01	9.9002000E-01
9.0198000E+02	8.6533000E-01	5.2683000E-01	4.5589000E-01	9.9066000E-01
9.0208000E+02	8.6560000E-01	5.2702000E-01	4.5618000E-01	9.9130000E-01
9.0218000E+02	8.6587000E-01	5.2720000E-01	4.5648000E-01	9.9195000E-01
9.0228000E+02	8.6613000E-01	5.2738000E-01	4.5678000E-01	9.9260000E-01
9.0238000E+02	8.6640000E-01	5.2756000E-01	4.5708000E-01	9.9325000E-01
9.0248000E+02	8.6665000E-01	5.2775000E-01	4.5737000E-01	9.9389000E-01
9.0258000E+02	8.6690000E-01	5.2793000E-01	4.5766000E-01	9.9452000E-01
9.0268000E+02	8.6715000E-01	5.2811000E-01	4.5795000E-01	9.9514000E-01
9.0278000E+02	8.6737000E-01	5.2828000E-01	4.5821000E-01	9.9571000E-01
9.0288000E+02	8.6758000E-01	5.2842000E-01	4.5845000E-01	9.9623000E-01
9.0298000E+02	8.6778000E-01	5.2856000E-01	4.5867000E-01	9.9672000E-01
9.0308000E+02	8.6795000E-01	5.2871000E-01	4.5889000E-01	9.9719000E-01
9.0318000E+02	8.6810000E-01	5.2885000E-01	4.5909000E-01	9.9763000E-01
9.0328000E+02	8.6822000E-01	5.2899000E-01	4.5928000E-01	9.9804000E-01
9.0338000E+02	8.6831000E-01	5.2914000E-01	4.5946000E-01	9.9842000E-01
9.0348000E+02	8.6838000E-01	5.2928000E-01	4.5962000E-01	9.9876000E-01
9.0358000E+02	8.6841000E-01	5.2942000E-01	4.5976000E-01	9.9907000E-01
9.0368000E+02	8.6841000E-01	5.2957000E-01	4.5988000E-01	9.9934000E-01
9.0378000E+02	8.6837000E-01	5.2971000E-01	4.5999000E-01	9.9957000E-01
9.0388000E+02	8.6830000E-01	5.2985000E-01	4.6007000E-01	9.9975000E-01
9.0398000E+02	8.6818000E-01	5.3000000E-01	4.6013000E-01	9.9989000E-01
9.0408000E+02	8.6803000E-01	5.3013000E-01	4.6017000E-01	9.9997000E-01
9.0418000E+02	8.6783000E-01	5.3027000E-01	4.6019000E-01	1.0000000E+00

9.0428000E+02	8.6760000E-01	5.3040000E-01	4.6018000E-01	9.9998000E-01
9.0438000E+02	8.6732000E-01	5.3054000E-01	4.6015000E-01	9.9992000E-01
9.0448000E+02	8.6700000E-01	5.3067000E-01	4.6010000E-01	9.9981000E-01
9.0458000E+02	8.6664000E-01	5.3081000E-01	4.6002000E-01	9.9964000E-01
9.0468000E+02	8.6624000E-01	5.3094000E-01	4.5992000E-01	9.9943000E-01
9.0478000E+02	8.6581000E-01	5.3105000E-01	4.5979000E-01	9.9913000E-01
9.0488000E+02	8.6533000E-01	5.3116000E-01	4.5963000E-01	9.9879000E-01
9.0498000E+02	8.6481000E-01	5.3127000E-01	4.5945000E-01	9.9841000E-01
9.0508000E+02	8.6426000E-01	5.3138000E-01	4.5925000E-01	9.9798000E-01
9.0518000E+02	8.6368000E-01	5.3149000E-01	4.5904000E-01	9.9750000E-01
9.0528000E+02	8.6306000E-01	5.3160000E-01	4.5880000E-01	9.9700000E-01
9.0538000E+02	8.6242000E-01	5.3170000E-01	4.5855000E-01	9.9645000E-01
9.0548000E+02	8.6175000E-01	5.3181000E-01	4.5829000E-01	9.9588000E-01
9.0558000E+02	8.6106000E-01	5.3192000E-01	4.5802000E-01	9.9528000E-01
9.0568000E+02	8.6036000E-01	5.3203000E-01	4.5773000E-01	9.9467000E-01
9.0578000E+02	8.5963000E-01	5.3213000E-01	4.5744000E-01	9.9403000E-01
9.0588000E+02	8.5890000E-01	5.3224000E-01	4.5714000E-01	9.9338000E-01
9.0598000E+02	8.5815000E-01	5.3234000E-01	4.5683000E-01	9.9271000E-01
9.0608000E+02	8.5741000E-01	5.3232000E-01	4.5641000E-01	9.9180000E-01
9.0618000E+02	8.5667000E-01	5.3226000E-01	4.5596000E-01	9.9083000E-01
9.0628000E+02	8.5593000E-01	5.3219000E-01	4.5552000E-01	9.8986000E-01
9.0638000E+02	8.5520000E-01	5.3213000E-01	4.5508000E-01	9.8891000E-01
9.0648000E+02	8.5448000E-01	5.3207000E-01	4.5465000E-01	9.8796000E-01
9.0658000E+02	8.5379000E-01	5.3201000E-01	4.5422000E-01	9.8705000E-01
9.0668000E+02	8.5312000E-01	5.3194000E-01	4.5381000E-01	9.8614000E-01
9.0678000E+02	8.5247000E-01	5.3187000E-01	4.5341000E-01	9.8527000E-01
9.0688000E+02	8.5186000E-01	5.3180000E-01	4.5302000E-01	9.8443000E-01
9.0698000E+02	8.5128000E-01	5.3173000E-01	4.5265000E-01	9.8364000E-01
9.0708000E+02	8.5074000E-01	5.3166000E-01	4.5231000E-01	9.8288000E-01
9.0718000E+02	8.5025000E-01	5.3159000E-01	4.5198000E-01	9.8218000E-01
9.0728000E+02	8.4980000E-01	5.3152000E-01	4.5168000E-01	9.8152000E-01
9.0738000E+02	8.4940000E-01	5.3144000E-01	4.5141000E-01	9.8093000E-01
9.0748000E+02	8.4905000E-01	5.3137000E-01	4.5116000E-01	9.8039000E-01
9.0758000E+02	8.4876000E-01	5.3130000E-01	4.5095000E-01	9.7992000E-01
9.0768000E+02	8.4853000E-01	5.3122000E-01	4.5076000E-01	9.7951000E-01
9.0778000E+02	8.4835000E-01	5.3115000E-01	4.5060000E-01	9.7917000E-01
9.0788000E+02	8.4823000E-01	5.3108000E-01	4.5048000E-01	9.7890000E-01
9.0798000E+02	8.4818000E-01	5.3100000E-01	4.5038000E-01	9.7870000E-01
9.0808000E+02	8.4818000E-01	5.3096000E-01	4.5035000E-01	9.7862000E-01
9.0818000E+02	8.4824000E-01	5.3093000E-01	4.5035000E-01	9.7863000E-01
9.0828000E+02	8.4836000E-01	5.3089000E-01	4.5039000E-01	9.7871000E-01
9.0838000E+02	8.4854000E-01	5.3086000E-01	4.5045000E-01	9.7885000E-01
9.0848000E+02	8.4877000E-01	5.3083000E-01	4.5055000E-01	9.7905000E-01

9.0858000E+02	8.4905000E-01	5.3078000E-01	4.5066000E-01	9.7929000E-01
9.0868000E+02	8.4937000E-01	5.3072000E-01	4.5078000E-01	9.7957000E-01
9.0878000E+02	8.4974000E-01	5.3067000E-01	4.5093000E-01	9.7989000E-01
9.0888000E+02	8.5015000E-01	5.3061000E-01	4.5110000E-01	9.8025000E-01
9.0898000E+02	8.5060000E-01	5.3055000E-01	4.5128000E-01	9.8066000E-01
9.0908000E+02	8.5106000E-01	5.3049000E-01	4.5148000E-01	9.8109000E-01
9.0918000E+02	8.5155000E-01	5.3044000E-01	4.5169000E-01	9.8154000E-01
9.0928000E+02	8.5205000E-01	5.3038000E-01	4.5191000E-01	9.8201000E-01
9.0938000E+02	8.5255000E-01	5.3032000E-01	4.5212000E-01	9.8248000E-01
9.0948000E+02	8.5304000E-01	5.3026000E-01	4.5234000E-01	9.8295000E-01
9.0958000E+02	8.5352000E-01	5.3020000E-01	4.5254000E-01	9.8339000E-01
9.0968000E+02	8.5398000E-01	5.3015000E-01	4.5273000E-01	9.8381000E-01
9.0978000E+02	8.5440000E-01	5.3009000E-01	4.5291000E-01	9.8418000E-01
9.0988000E+02	8.5477000E-01	5.3003000E-01	4.5305000E-01	9.8450000E-01
9.0998000E+02	8.5508000E-01	5.2997000E-01	4.5317000E-01	9.8475000E-01
9.1008000E+02	8.5533000E-01	5.3001000E-01	4.5334000E-01	9.8512000E-01
9.1018000E+02	8.5549000E-01	5.3008000E-01	4.5348000E-01	9.8543000E-01
9.1028000E+02	8.5555000E-01	5.3016000E-01	4.5358000E-01	9.8564000E-01
9.1038000E+02	8.5551000E-01	5.3023000E-01	4.5361000E-01	9.8572000E-01
9.1048000E+02	8.5534000E-01	5.3029000E-01	4.5358000E-01	9.8565000E-01
9.1058000E+02	8.5504000E-01	5.3034000E-01	4.5346000E-01	9.8539000E-01
9.1068000E+02	8.5459000E-01	5.3039000E-01	4.5326000E-01	9.8496000E-01
9.1078000E+02	8.5398000E-01	5.3043000E-01	4.5298000E-01	9.8434000E-01
9.1088000E+02	8.5319000E-01	5.3048000E-01	4.5260000E-01	9.8352000E-01
9.1098000E+02	8.5221000E-01	5.3053000E-01	4.5212000E-01	9.8247000E-01
9.1108000E+02	8.5102000E-01	5.3058000E-01	4.5153000E-01	9.8120000E-01
9.1118000E+02	8.4962000E-01	5.3062000E-01	4.5083000E-01	9.7967000E-01
9.1128000E+02	8.4799000E-01	5.3067000E-01	4.5000000E-01	9.7787000E-01
9.1138000E+02	8.4611000E-01	5.3072000E-01	4.4905000E-01	9.7580000E-01
9.1148000E+02	8.4398000E-01	5.3076000E-01	4.4796000E-01	9.7343000E-01
9.1158000E+02	8.4158000E-01	5.3081000E-01	4.4672000E-01	9.7074000E-01
9.1168000E+02	8.3891000E-01	5.3086000E-01	4.4534000E-01	9.6774000E-01
9.1178000E+02	8.3594000E-01	5.3090000E-01	4.4380000E-01	9.6440000E-01
9.1188000E+02	8.3266000E-01	5.3095000E-01	4.4210000E-01	9.6071000E-01
9.1198000E+02	8.2908000E-01	5.3100000E-01	4.4024000E-01	9.5666000E-01
9.1208000E+02	8.2518000E-01	5.3099000E-01	4.3816000E-01	9.5213000E-01
9.1218000E+02	8.2095000E-01	5.3096000E-01	4.3589000E-01	9.4721000E-01
9.1228000E+02	8.1638000E-01	5.3094000E-01	4.3345000E-01	9.4189000E-01
9.1238000E+02	8.1146000E-01	5.3092000E-01	4.3082000E-01	9.3619000E-01
9.1248000E+02	8.0620000E-01	5.3087000E-01	4.2799000E-01	9.3004000E-01
9.1258000E+02	8.0058000E-01	5.3082000E-01	4.2497000E-01	9.2348000E-01
9.1268000E+02	7.9461000E-01	5.3078000E-01	4.2176000E-01	9.1650000E-01
9.1278000E+02	7.8828000E-01	5.3073000E-01	4.1836000E-01	9.0911000E-01

9.1288000E+02	7.8158000E-01	5.3068000E-01	4.1477000E-01	9.0131000E-01
9.1298000E+02	7.7451000E-01	5.3063000E-01	4.1098000E-01	8.9308000E-01
9.1308000E+02	7.6709000E-01	5.3059000E-01	4.0701000E-01	8.8444000E-01
9.1318000E+02	7.5930000E-01	5.3054000E-01	4.0284000E-01	8.7538000E-01
9.1328000E+02	7.5115000E-01	5.3049000E-01	3.9848000E-01	8.6591000E-01
9.1338000E+02	7.4264000E-01	5.3045000E-01	3.9393000E-01	8.5602000E-01
9.1348000E+02	7.3378000E-01	5.3040000E-01	3.8919000E-01	8.4573000E-01
9.1358000E+02	7.2457000E-01	5.3035000E-01	3.8428000E-01	8.3505000E-01
9.1368000E+02	7.1503000E-01	5.3030000E-01	3.7918000E-01	8.2397000E-01
9.1378000E+02	7.0515000E-01	5.3025000E-01	3.7391000E-01	8.1251000E-01
9.1388000E+02	6.9495000E-01	5.3020000E-01	3.6846000E-01	8.0068000E-01
9.1398000E+02	6.8443000E-01	5.3015000E-01	3.6285000E-01	7.8849000E-01
9.1408000E+02	6.7361000E-01	5.3011000E-01	3.5709000E-01	7.7597000E-01
9.1418000E+02	6.6250000E-01	5.3007000E-01	3.5117000E-01	7.6311000E-01
9.1428000E+02	6.5112000E-01	5.3003000E-01	3.4511000E-01	7.4994000E-01
9.1438000E+02	6.3947000E-01	5.2998000E-01	3.3890000E-01	7.3645000E-01
9.1448000E+02	6.2757000E-01	5.2992000E-01	3.3256000E-01	7.2266000E-01
9.1458000E+02	6.1543000E-01	5.2986000E-01	3.2609000E-01	7.0860000E-01
9.1468000E+02	6.0308000E-01	5.2980000E-01	3.1951000E-01	6.9430000E-01
9.1478000E+02	5.9052000E-01	5.2973000E-01	3.1282000E-01	6.7977000E-01
9.1488000E+02	5.7778000E-01	5.2967000E-01	3.0604000E-01	6.6503000E-01
9.1498000E+02	5.6488000E-01	5.2961000E-01	2.9916000E-01	6.5010000E-01
9.1508000E+02	5.5182000E-01	5.2955000E-01	2.9222000E-01	6.3500000E-01
9.1518000E+02	5.3864000E-01	5.2949000E-01	2.8520000E-01	6.1975000E-01
9.1528000E+02	5.2535000E-01	5.2942000E-01	2.7813000E-01	6.0439000E-01
9.1538000E+02	5.1196000E-01	5.2936000E-01	2.7101000E-01	5.8892000E-01
9.1548000E+02	4.9851000E-01	5.2930000E-01	2.6386000E-01	5.7338000E-01
9.1558000E+02	4.8501000E-01	5.2923000E-01	2.5668000E-01	5.5778000E-01
9.1568000E+02	4.7147000E-01	5.2917000E-01	2.4949000E-01	5.4215000E-01
9.1578000E+02	4.5793000E-01	5.2910000E-01	2.4229000E-01	5.2651000E-01
9.1588000E+02	4.4440000E-01	5.2904000E-01	2.3510000E-01	5.1089000E-01
9.1598000E+02	4.3089000E-01	5.2897000E-01	2.2793000E-01	4.9530000E-01
9.1608000E+02	4.1744000E-01	5.2889000E-01	2.2078000E-01	4.7976000E-01
9.1618000E+02	4.0405000E-01	5.2880000E-01	2.1366000E-01	4.6430000E-01
9.1628000E+02	3.9075000E-01	5.2870000E-01	2.0659000E-01	4.4893000E-01
9.1638000E+02	3.7756000E-01	5.2858000E-01	1.9957000E-01	4.3368000E-01
9.1648000E+02	3.6450000E-01	5.2846000E-01	1.9262000E-01	4.1858000E-01
9.1658000E+02	3.5157000E-01	5.2834000E-01	1.8575000E-01	4.0364000E-01
9.1668000E+02	3.3881000E-01	5.2822000E-01	1.7897000E-01	3.8890000E-01
9.1678000E+02	3.2622000E-01	5.2810000E-01	1.7228000E-01	3.7436000E-01
9.1688000E+02	3.1382000E-01	5.2798000E-01	1.6569000E-01	3.6005000E-01
9.1698000E+02	3.0163000E-01	5.2786000E-01	1.5922000E-01	3.4599000E-01
9.1708000E+02	2.8966000E-01	5.2774000E-01	1.5287000E-01	3.3218000E-01

9.1718000E+02	2.7793000E-01	5.2762000E-01	1.4664000E-01	3.1865000E-01
9.1728000E+02	2.6644000E-01	5.2749000E-01	1.4055000E-01	3.0541000E-01
9.1738000E+02	2.5521000E-01	5.2737000E-01	1.3459000E-01	2.9248000E-01
9.1748000E+02	2.4426000E-01	5.2725000E-01	1.2878000E-01	2.7985000E-01
9.1758000E+02	2.3358000E-01	5.2713000E-01	1.2312000E-01	2.6755000E-01
9.1768000E+02	2.2318000E-01	5.2700000E-01	1.1762000E-01	2.5559000E-01
9.1778000E+02	2.1309000E-01	5.2688000E-01	1.1227000E-01	2.4397000E-01
9.1788000E+02	2.0329000E-01	5.2676000E-01	1.0709000E-01	2.3270000E-01
9.1798000E+02	1.9381000E-01	5.2663000E-01	1.0207000E-01	2.2179000E-01
9.1808000E+02	1.8463000E-01	5.2642000E-01	9.7196000E-02	2.1121000E-01
9.1818000E+02	1.7578000E-01	5.2619000E-01	9.2494000E-02	2.0099000E-01
9.1828000E+02	1.6724000E-01	5.2596000E-01	8.7964000E-02	1.9115000E-01
9.1838000E+02	1.5903000E-01	5.2573000E-01	8.3606000E-02	1.8168000E-01
9.1848000E+02	1.5114000E-01	5.2549000E-01	7.9421000E-02	1.7258000E-01
9.1858000E+02	1.4356000E-01	5.2526000E-01	7.5409000E-02	1.6387000E-01
9.1868000E+02	1.3632000E-01	5.2502000E-01	7.1569000E-02	1.5552000E-01
9.1878000E+02	1.2938000E-01	5.2479000E-01	6.7899000E-02	1.4755000E-01
9.1888000E+02	1.2277000E-01	5.2455000E-01	6.4399000E-02	1.3994000E-01
9.1898000E+02	1.1647000E-01	5.2432000E-01	6.1066000E-02	1.3270000E-01
9.1908000E+02	1.1047000E-01	5.2408000E-01	5.7897000E-02	1.2581000E-01
9.1918000E+02	1.0478000E-01	5.2384000E-01	5.4889000E-02	1.1928000E-01
9.1928000E+02	9.9388000E-02	5.2361000E-01	5.2040000E-02	1.1309000E-01
9.1938000E+02	9.4284000E-02	5.2337000E-01	4.9345000E-02	1.0723000E-01
9.1948000E+02	8.9463000E-02	5.2313000E-01	4.6801000E-02	1.0170000E-01
9.1958000E+02	8.4918000E-02	5.2289000E-01	4.4403000E-02	9.6490000E-02
9.1968000E+02	8.0641000E-02	5.2266000E-01	4.2148000E-02	9.1588000E-02
9.1978000E+02	7.6622000E-02	5.2242000E-01	4.0029000E-02	8.6984000E-02
9.1988000E+02	7.2853000E-02	5.2218000E-01	3.8042000E-02	8.2668000E-02
9.1998000E+02	6.9324000E-02	5.2194000E-01	3.6183000E-02	7.8627000E-02
9.2008000E+02	6.6026000E-02	5.2175000E-01	3.4449000E-02	7.4859000E-02
9.2018000E+02	6.2948000E-02	5.2160000E-01	3.2833000E-02	7.1348000E-02
9.2028000E+02	6.0080000E-02	5.2144000E-01	3.1328000E-02	6.8077000E-02
9.2038000E+02	5.7412000E-02	5.2129000E-01	2.9928000E-02	6.5035000E-02
9.2048000E+02	5.4933000E-02	5.2114000E-01	2.8627000E-02	6.2208000E-02
9.2058000E+02	5.2632000E-02	5.2098000E-01	2.7420000E-02	5.9586000E-02
9.2068000E+02	5.0500000E-02	5.2083000E-01	2.6302000E-02	5.7154000E-02
9.2078000E+02	4.9257000E-02	5.2067000E-01	2.5647000E-02	5.5731000E-02
9.2088000E+02	4.7375000E-02	5.2052000E-01	2.4660000E-02	5.3587000E-02
9.2098000E+02	4.5630000E-02	5.2036000E-01	2.3744000E-02	5.1597000E-02
9.2108000E+02	4.4011000E-02	5.2021000E-01	2.2895000E-02	4.9752000E-02
9.2118000E+02	4.2509000E-02	5.2005000E-01	2.2107000E-02	4.8039000E-02
9.2128000E+02	4.1113000E-02	5.1989000E-01	2.1374000E-02	4.6447000E-02
9.2138000E+02	3.9813000E-02	5.1973000E-01	2.0692000E-02	4.4965000E-02

9.2148000E+02	3.8601000E-02	5.1957000E-01	2.0056000E-02	4.3583000E-02
9.2158000E+02	3.7468000E-02	5.1942000E-01	1.9462000E-02	4.2291000E-02
9.2168000E+02	3.6405000E-02	5.1926000E-01	1.8903000E-02	4.1078000E-02
9.2178000E+02	3.5403000E-02	5.1910000E-01	1.8377000E-02	3.9935000E-02
9.2188000E+02	3.4454000E-02	5.1894000E-01	1.7880000E-02	3.8854000E-02
9.2198000E+02	3.3553000E-02	5.1878000E-01	1.7407000E-02	3.7825000E-02
9.2208000E+02	3.2690000E-02	5.1862000E-01	1.6954000E-02	3.6842000E-02
9.2218000E+02	3.1861000E-02	5.1847000E-01	1.6519000E-02	3.5897000E-02
9.2228000E+02	3.1060000E-02	5.1831000E-01	1.6098000E-02	3.4982000E-02
9.2238000E+02	3.0280000E-02	5.1815000E-01	1.5689000E-02	3.4093000E-02
9.2248000E+02	2.9516000E-02	5.1799000E-01	1.5289000E-02	3.3224000E-02
9.2258000E+02	2.8766000E-02	5.1783000E-01	1.4896000E-02	3.2369000E-02
9.2268000E+02	2.8024000E-02	5.1767000E-01	1.4507000E-02	3.1524000E-02
9.2278000E+02	2.7287000E-02	5.1751000E-01	1.4121000E-02	3.0686000E-02
9.2288000E+02	2.6553000E-02	5.1735000E-01	1.3737000E-02	2.9851000E-02
9.2298000E+02	2.5819000E-02	5.1720000E-01	1.3353000E-02	2.9017000E-02
9.2308000E+02	2.5083000E-02	5.1704000E-01	1.2969000E-02	2.8182000E-02
9.2318000E+02	2.4344000E-02	5.1688000E-01	1.2583000E-02	2.7343000E-02
9.2328000E+02	2.3601000E-02	5.1673000E-01	1.2195000E-02	2.6501000E-02
9.2338000E+02	2.2853000E-02	5.1657000E-01	1.1805000E-02	2.5653000E-02
9.2348000E+02	2.2100000E-02	5.1641000E-01	1.1413000E-02	2.4801000E-02
9.2358000E+02	2.1343000E-02	5.1626000E-01	1.1018000E-02	2.3943000E-02
9.2368000E+02	2.0581000E-02	5.1610000E-01	1.0622000E-02	2.3082000E-02
9.2378000E+02	1.9816000E-02	5.1594000E-01	1.0224000E-02	2.2217000E-02
9.2388000E+02	1.9048000E-02	5.1579000E-01	9.8249000E-03	2.1350000E-02
9.2398000E+02	1.8280000E-02	5.1563000E-01	9.4256000E-03	2.0482000E-02
9.2408000E+02	1.7512000E-02	5.1551000E-01	9.0275000E-03	1.9617000E-02
9.2418000E+02	1.6746000E-02	5.1540000E-01	8.6309000E-03	1.8755000E-02
9.2428000E+02	1.5984000E-02	5.1529000E-01	8.2366000E-03	1.7898000E-02
9.2438000E+02	1.5229000E-02	5.1518000E-01	7.8455000E-03	1.7049000E-02
9.2448000E+02	1.4481000E-02	5.1507000E-01	7.4588000E-03	1.6208000E-02
9.2458000E+02	1.3744000E-02	5.1496000E-01	7.0774000E-03	1.5380000E-02
9.2468000E+02	1.3019000E-02	5.1485000E-01	6.7026000E-03	1.4565000E-02
9.2478000E+02	1.2308000E-02	5.1474000E-01	6.3352000E-03	1.3767000E-02
9.2488000E+02	1.1613000E-02	5.1463000E-01	5.9764000E-03	1.2987000E-02
9.2498000E+02	1.0937000E-02	5.1452000E-01	5.6271000E-03	1.2228000E-02
9.2508000E+02	1.0280000E-02	5.1441000E-01	5.2882000E-03	1.1491000E-02
9.2518000E+02	9.6449000E-03	5.1430000E-01	4.9604000E-03	1.0779000E-02
9.2528000E+02	9.0327000E-03	5.1420000E-01	4.6446000E-03	1.0093000E-02
9.2538000E+02	8.4446000E-03	5.1409000E-01	4.3413000E-03	9.4337000E-03
9.2548000E+02	7.8813000E-03	5.1398000E-01	4.0509000E-03	8.8027000E-03
9.2558000E+02	7.3438000E-03	5.1388000E-01	3.7738000E-03	8.2006000E-03
9.2568000E+02	6.8322000E-03	5.1377000E-01	3.5102000E-03	7.6278000E-03

9.2578000E+02	6.3469000E-03	5.1367000E-01	3.2602000E-03	7.0845000E-03
9.2588000E+02	5.8876000E-03	5.1356000E-01	3.0236000E-03	6.5705000E-03
9.2598000E+02	5.4541000E-03	5.1345000E-01	2.8004000E-03	6.0853000E-03
9.2608000E+02	5.0458000E-03	5.1325000E-01	2.5898000E-03	5.6277000E-03
9.2618000E+02	4.6622000E-03	5.1304000E-01	2.3919000E-03	5.1977000E-03
9.2628000E+02	4.3029000E-03	5.1282000E-01	2.2066000E-03	4.7950000E-03
9.2638000E+02	3.9673000E-03	5.1260000E-01	2.0336000E-03	4.4191000E-03
9.2648000E+02	3.6553000E-03	5.1239000E-01	1.8729000E-03	4.0700000E-03
9.2658000E+02	3.3675000E-03	5.1217000E-01	1.7247000E-03	3.7479000E-03
9.2668000E+02	3.1048000E-03	5.1196000E-01	1.5895000E-03	3.4540000E-03
9.2678000E+02	2.8688000E-03	5.1174000E-01	1.4681000E-03	3.1902000E-03
9.2688000E+02	2.6622000E-03	5.1153000E-01	1.3618000E-03	2.9592000E-03
9.2698000E+02	2.4875000E-03	5.1131000E-01	1.2719000E-03	2.7638000E-03
9.2708000E+02	2.3476000E-03	5.1110000E-01	1.1999000E-03	2.6074000E-03
9.2718000E+02	2.2451000E-03	5.1088000E-01	1.1470000E-03	2.4924000E-03
9.2728000E+02	2.1816000E-03	5.1067000E-01	1.1141000E-03	2.4209000E-03
9.2738000E+02	2.1582000E-03	5.1045000E-01	1.1017000E-03	2.3940000E-03
9.2748000E+02	0.0000000E+00	5.1024000E-01	0.0000000E+00	0.0000000E+00
Channel 9				
Wavenumber	HIRS Filter Transmittance	Optical Element Transmittance	Product of the HIRS Filter and Optical Element Transmittances	Normalized Value of Column 4
9.9633000E+02	0.0000000E+00	4.2163000E-01	0.0000000E+00	0.0000000E+00
9.9643000E+02	2.9548000E-03	4.2165000E-01	1.2459000E-03	3.6133000E-03
9.9653000E+02	3.0467000E-03	4.2167000E-01	1.2847000E-03	3.7259000E-03
9.9663000E+02	3.1448000E-03	4.2168000E-01	1.3261000E-03	3.8460000E-03
9.9673000E+02	3.2493000E-03	4.2170000E-01	1.3702000E-03	3.9739000E-03
9.9683000E+02	3.3604000E-03	4.2171000E-01	1.4171000E-03	4.1100000E-03
9.9693000E+02	3.4784000E-03	4.2173000E-01	1.4669000E-03	4.2545000E-03
9.9703000E+02	3.6032000E-03	4.2174000E-01	1.5196000E-03	4.4072000E-03
9.9713000E+02	3.7346000E-03	4.2176000E-01	1.5751000E-03	4.5681000E-03
9.9723000E+02	3.8723000E-03	4.2177000E-01	1.6332000E-03	4.7367000E-03
9.9733000E+02	4.0160000E-03	4.2176000E-01	1.6938000E-03	4.9124000E-03
9.9743000E+02	4.1652000E-03	4.2175000E-01	1.7566000E-03	5.0946000E-03
9.9753000E+02	4.3192000E-03	4.2173000E-01	1.8215000E-03	5.2828000E-03
9.9763000E+02	4.4774000E-03	4.2171000E-01	1.8882000E-03	5.4761000E-03
9.9773000E+02	4.6391000E-03	4.2170000E-01	1.9563000E-03	5.6737000E-03
9.9783000E+02	4.8035000E-03	4.2168000E-01	2.0255000E-03	5.8745000E-03
9.9793000E+02	4.9697000E-03	4.2166000E-01	2.0955000E-03	6.0775000E-03
9.9803000E+02	5.1369000E-03	4.2163000E-01	2.1659000E-03	6.2815000E-03
9.9813000E+02	5.3043000E-03	4.2154000E-01	2.2360000E-03	6.4849000E-03
9.9823000E+02	5.4710000E-03	4.2146000E-01	2.3058000E-03	6.6874000E-03

9.9833000E+02	5.6361000E-03	4.2138000E-01	2.3750000E-03	6.8879000E-03
9.9843000E+02	5.7988000E-03	4.2130000E-01	2.4431000E-03	7.0854000E-03
9.9853000E+02	5.9582000E-03	4.2122000E-01	2.5098000E-03	7.2788000E-03
9.9863000E+02	6.1137000E-03	4.2114000E-01	2.5747000E-03	7.4673000E-03
9.9873000E+02	6.2643000E-03	4.2106000E-01	2.6377000E-03	7.6498000E-03
9.9883000E+02	6.4095000E-03	4.2098000E-01	2.6983000E-03	7.8256000E-03
9.9893000E+02	6.5485000E-03	4.2090000E-01	2.7563000E-03	7.9937000E-03
9.9903000E+02	6.6807000E-03	4.2082000E-01	2.8114000E-03	8.1535000E-03
9.9913000E+02	6.8055000E-03	4.2073000E-01	2.8633000E-03	8.3043000E-03
9.9923000E+02	6.9225000E-03	4.2065000E-01	2.9120000E-03	8.4453000E-03
9.9933000E+02	7.0312000E-03	4.2057000E-01	2.9571000E-03	8.5763000E-03
9.9943000E+02	7.1311000E-03	4.2049000E-01	2.9986000E-03	8.6965000E-03
9.9953000E+02	7.2221000E-03	4.2041000E-01	3.0362000E-03	8.8057000E-03
9.9963000E+02	7.3038000E-03	4.2033000E-01	3.0700000E-03	8.9036000E-03
9.9973000E+02	7.3760000E-03	4.2025000E-01	3.0998000E-03	8.9899000E-03
9.9983000E+02	7.4387000E-03	4.2017000E-01	3.1255000E-03	9.0646000E-03
9.9993000E+02	7.4918000E-03	4.2009000E-01	3.1472000E-03	9.1275000E-03
1.0000000E+03	7.5353000E-03	4.1999000E-01	3.1647000E-03	9.1783000E-03
1.0001000E+03	7.5694000E-03	4.1984000E-01	3.1779000E-03	9.2167000E-03
1.0002000E+03	7.5943000E-03	4.1969000E-01	3.1873000E-03	9.2438000E-03
1.0003000E+03	7.6103000E-03	4.1954000E-01	3.1928000E-03	9.2599000E-03
1.0004000E+03	7.6176000E-03	4.1940000E-01	3.1948000E-03	9.2657000E-03
1.0005000E+03	7.6168000E-03	4.1925000E-01	3.1934000E-03	9.2614000E-03
1.0006000E+03	7.6083000E-03	4.1910000E-01	3.1887000E-03	9.2479000E-03
1.0007000E+03	7.5928000E-03	4.1896000E-01	3.1811000E-03	9.2257000E-03
1.0008000E+03	7.5708000E-03	4.1881000E-01	3.1707000E-03	9.1958000E-03
1.0009000E+03	7.5430000E-03	4.1866000E-01	3.1580000E-03	9.1588000E-03
1.0010000E+03	7.5103000E-03	4.1852000E-01	3.1432000E-03	9.1159000E-03
1.0011000E+03	7.4735000E-03	4.1837000E-01	3.1267000E-03	9.0681000E-03
1.0012000E+03	7.4334000E-03	4.1824000E-01	3.1090000E-03	9.0167000E-03
1.0013000E+03	7.3910000E-03	4.1812000E-01	3.0903000E-03	8.9625000E-03
1.0014000E+03	7.3472000E-03	4.1799000E-01	3.0710000E-03	8.9067000E-03
1.0015000E+03	7.3031000E-03	4.1786000E-01	3.0517000E-03	8.8505000E-03
1.0016000E+03	7.2597000E-03	4.1773000E-01	3.0326000E-03	8.7952000E-03
1.0017000E+03	7.2180000E-03	4.1760000E-01	3.0142000E-03	8.7420000E-03
1.0018000E+03	7.1791000E-03	4.1747000E-01	2.9971000E-03	8.6921000E-03
1.0019000E+03	7.1439000E-03	4.1734000E-01	2.9815000E-03	8.6468000E-03
1.0020000E+03	7.1135000E-03	4.1723000E-01	2.9680000E-03	8.6078000E-03
1.0021000E+03	7.0890000E-03	4.1716000E-01	2.9572000E-03	8.5766000E-03
1.0022000E+03	7.0712000E-03	4.1709000E-01	2.9493000E-03	8.5535000E-03
1.0023000E+03	7.0610000E-03	4.1701000E-01	2.9445000E-03	8.5398000E-03
1.0024000E+03	7.0593000E-03	4.1694000E-01	2.9433000E-03	8.5363000E-03
1.0025000E+03	7.0670000E-03	4.1687000E-01	2.9460000E-03	8.5441000E-03

1.0026000E+03	7.0848000E-03	4.1680000E-01	2.9529000E-03	8.5641000E-03
1.0027000E+03	7.1133000E-03	4.1672000E-01	2.9643000E-03	8.5970000E-03
1.0028000E+03	7.1531000E-03	4.1665000E-01	2.9804000E-03	8.6437000E-03
1.0029000E+03	7.2049000E-03	4.1658000E-01	3.0014000E-03	8.7048000E-03
1.0030000E+03	7.2692000E-03	4.1651000E-01	3.0276000E-03	8.7808000E-03
1.0031000E+03	7.3463000E-03	4.1644000E-01	3.0593000E-03	8.8725000E-03
1.0032000E+03	7.4367000E-03	4.1637000E-01	3.0964000E-03	8.9803000E-03
1.0033000E+03	7.5408000E-03	4.1630000E-01	3.1393000E-03	9.1046000E-03
1.0034000E+03	7.6590000E-03	4.1624000E-01	3.1880000E-03	9.2458000E-03
1.0035000E+03	7.7915000E-03	4.1617000E-01	3.2426000E-03	9.4042000E-03
1.0036000E+03	7.9387000E-03	4.1610000E-01	3.3033000E-03	9.5803000E-03
1.0037000E+03	8.1009000E-03	4.1603000E-01	3.3703000E-03	9.7745000E-03
1.0038000E+03	8.2784000E-03	4.1597000E-01	3.4436000E-03	9.9871000E-03
1.0039000E+03	8.4716000E-03	4.1590000E-01	3.5233000E-03	1.0218000E-02
1.0040000E+03	8.6806000E-03	4.1583000E-01	3.6097000E-03	1.0469000E-02
1.0041000E+03	8.9059000E-03	4.1576000E-01	3.7027000E-03	1.0739000E-02
1.0042000E+03	9.1477000E-03	4.1570000E-01	3.8027000E-03	1.1029000E-02
1.0043000E+03	9.4063000E-03	4.1563000E-01	3.9095000E-03	1.1338000E-02
1.0044000E+03	9.5947000E-03	4.1556000E-01	3.9872000E-03	1.1564000E-02
1.0045000E+03	9.8864000E-03	4.1550000E-01	4.1078000E-03	1.1913000E-02
1.0046000E+03	1.0196000E-02	4.1543000E-01	4.2357000E-03	1.2284000E-02
1.0047000E+03	1.0523000E-02	4.1536000E-01	4.3710000E-03	1.2677000E-02
1.0048000E+03	1.0869000E-02	4.1529000E-01	4.5140000E-03	1.3092000E-02
1.0049000E+03	1.1234000E-02	4.1522000E-01	4.6645000E-03	1.3528000E-02
1.0050000E+03	1.1617000E-02	4.1516000E-01	4.8227000E-03	1.3987000E-02
1.0051000E+03	1.2018000E-02	4.1510000E-01	4.9887000E-03	1.4468000E-02
1.0052000E+03	1.2438000E-02	4.1504000E-01	5.1623000E-03	1.4972000E-02
1.0053000E+03	1.2877000E-02	4.1498000E-01	5.3435000E-03	1.5497000E-02
1.0054000E+03	1.3334000E-02	4.1492000E-01	5.5323000E-03	1.6045000E-02
1.0055000E+03	1.3809000E-02	4.1486000E-01	5.7286000E-03	1.6614000E-02
1.0056000E+03	1.4301000E-02	4.1480000E-01	5.9322000E-03	1.7205000E-02
1.0057000E+03	1.4812000E-02	4.1474000E-01	6.1430000E-03	1.7816000E-02
1.0058000E+03	1.5339000E-02	4.1468000E-01	6.3608000E-03	1.8448000E-02
1.0059000E+03	1.5883000E-02	4.1462000E-01	6.5854000E-03	1.9099000E-02
1.0060000E+03	1.6443000E-02	4.1458000E-01	6.8169000E-03	1.9771000E-02
1.0061000E+03	1.7019000E-02	4.1458000E-01	7.0556000E-03	2.0463000E-02
1.0062000E+03	1.7609000E-02	4.1459000E-01	7.3004000E-03	2.1173000E-02
1.0063000E+03	1.8213000E-02	4.1460000E-01	7.5512000E-03	2.1900000E-02
1.0064000E+03	1.8831000E-02	4.1461000E-01	7.8075000E-03	2.2643000E-02
1.0065000E+03	1.9461000E-02	4.1462000E-01	8.0690000E-03	2.3402000E-02
1.0066000E+03	2.0104000E-02	4.1463000E-01	8.3356000E-03	2.4175000E-02
1.0067000E+03	2.0758000E-02	4.1463000E-01	8.6068000E-03	2.4962000E-02
1.0068000E+03	2.1422000E-02	4.1464000E-01	8.8825000E-03	2.5761000E-02

1.0069000E+03	2.2096000E-02	4.1465000E-01	9.1623000E-03	2.6573000E-02
1.0070000E+03	2.2780000E-02	4.1466000E-01	9.4460000E-03	2.7395000E-02
1.0071000E+03	2.3472000E-02	4.1467000E-01	9.7333000E-03	2.8229000E-02
1.0072000E+03	2.4172000E-02	4.1468000E-01	1.0024000E-02	2.9071000E-02
1.0073000E+03	2.4880000E-02	4.1469000E-01	1.0318000E-02	2.9923000E-02
1.0074000E+03	2.5595000E-02	4.1470000E-01	1.0614000E-02	3.0784000E-02
1.0075000E+03	2.6316000E-02	4.1471000E-01	1.0914000E-02	3.1652000E-02
1.0076000E+03	2.7044000E-02	4.1473000E-01	1.1216000E-02	3.2528000E-02
1.0077000E+03	2.7778000E-02	4.1474000E-01	1.1520000E-02	3.3411000E-02
1.0078000E+03	2.8517000E-02	4.1475000E-01	1.1827000E-02	3.4302000E-02
1.0079000E+03	2.9263000E-02	4.1476000E-01	1.2137000E-02	3.5200000E-02
1.0080000E+03	3.0014000E-02	4.1475000E-01	1.2449000E-02	3.6103000E-02
1.0081000E+03	3.0772000E-02	4.1472000E-01	1.2762000E-02	3.7012000E-02
1.0082000E+03	3.1537000E-02	4.1469000E-01	1.3078000E-02	3.7928000E-02
1.0083000E+03	3.2308000E-02	4.1465000E-01	1.3396000E-02	3.8853000E-02
1.0084000E+03	3.3087000E-02	4.1462000E-01	1.3718000E-02	3.9786000E-02
1.0085000E+03	3.3874000E-02	4.1458000E-01	1.4044000E-02	4.0729000E-02
1.0086000E+03	3.4670000E-02	4.1455000E-01	1.4372000E-02	4.1683000E-02
1.0087000E+03	3.5476000E-02	4.1451000E-01	1.4706000E-02	4.2649000E-02
1.0088000E+03	3.6294000E-02	4.1448000E-01	1.5043000E-02	4.3629000E-02
1.0089000E+03	3.7125000E-02	4.1445000E-01	1.5386000E-02	4.4623000E-02
1.0090000E+03	3.7969000E-02	4.1442000E-01	1.5735000E-02	4.5635000E-02
1.0091000E+03	3.8829000E-02	4.1439000E-01	1.6090000E-02	4.6666000E-02
1.0092000E+03	3.9707000E-02	4.1436000E-01	1.6453000E-02	4.7717000E-02
1.0093000E+03	4.0604000E-02	4.1433000E-01	1.6824000E-02	4.8792000E-02
1.0094000E+03	4.1523000E-02	4.1430000E-01	1.7203000E-02	4.9892000E-02
1.0095000E+03	4.2466000E-02	4.1427000E-01	1.7592000E-02	5.1021000E-02
1.0096000E+03	4.3435000E-02	4.1423000E-01	1.7992000E-02	5.2182000E-02
1.0097000E+03	4.4433000E-02	4.1420000E-01	1.8404000E-02	5.3376000E-02
1.0098000E+03	4.5462000E-02	4.1417000E-01	1.8829000E-02	5.4609000E-02
1.0099000E+03	4.6526000E-02	4.1414000E-01	1.9268000E-02	5.5882000E-02
1.0100000E+03	4.7627000E-02	4.1411000E-01	1.9723000E-02	5.7200000E-02
1.0101000E+03	4.8769000E-02	4.1407000E-01	2.0194000E-02	5.8567000E-02
1.0102000E+03	4.9955000E-02	4.1404000E-01	2.0683000E-02	5.9986000E-02
1.0103000E+03	5.1187000E-02	4.1401000E-01	2.1192000E-02	6.1461000E-02
1.0104000E+03	5.2471000E-02	4.1397000E-01	2.1721000E-02	6.2997000E-02
1.0105000E+03	5.3808000E-02	4.1394000E-01	2.2273000E-02	6.4597000E-02
1.0106000E+03	5.5204000E-02	4.1390000E-01	2.2849000E-02	6.6267000E-02
1.0107000E+03	5.6661000E-02	4.1387000E-01	2.3450000E-02	6.8011000E-02
1.0108000E+03	5.8184000E-02	4.1382000E-01	2.4078000E-02	6.9832000E-02
1.0109000E+03	5.9777000E-02	4.1378000E-01	2.4734000E-02	7.1735000E-02
1.0110000E+03	6.1443000E-02	4.1373000E-01	2.5421000E-02	7.3727000E-02
1.0111000E+03	6.3187000E-02	4.1369000E-01	2.6140000E-02	7.5812000E-02

1.0112000E+03	6.5013000E-02	4.1365000E-01	2.6893000E-02	7.7995000E-02
1.0113000E+03	6.6925000E-02	4.1361000E-01	2.7681000E-02	8.0280000E-02
1.0114000E+03	6.8927000E-02	4.1356000E-01	2.8506000E-02	8.2673000E-02
1.0115000E+03	7.1024000E-02	4.1352000E-01	2.9370000E-02	8.5179000E-02
1.0116000E+03	7.3220000E-02	4.1348000E-01	3.0275000E-02	8.7803000E-02
1.0117000E+03	7.5518000E-02	4.1343000E-01	3.1222000E-02	9.0550000E-02
1.0118000E+03	7.7923000E-02	4.1339000E-01	3.2213000E-02	9.3424000E-02
1.0119000E+03	8.0440000E-02	4.1335000E-01	3.3250000E-02	9.6431000E-02
1.0120000E+03	8.3073000E-02	4.1329000E-01	3.4333000E-02	9.9574000E-02
1.0121000E+03	8.5825000E-02	4.1321000E-01	3.5464000E-02	1.0285000E-01
1.0122000E+03	8.8700000E-02	4.1313000E-01	3.6645000E-02	1.0628000E-01
1.0123000E+03	9.1703000E-02	4.1305000E-01	3.7878000E-02	1.0986000E-01
1.0124000E+03	9.4837000E-02	4.1297000E-01	3.9165000E-02	1.1359000E-01
1.0125000E+03	9.8107000E-02	4.1289000E-01	4.0508000E-02	1.1748000E-01
1.0126000E+03	1.0152000E-01	4.1282000E-01	4.1907000E-02	1.2154000E-01
1.0127000E+03	1.0507000E-01	4.1274000E-01	4.3364000E-02	1.2577000E-01
1.0128000E+03	1.0876000E-01	4.1266000E-01	4.4882000E-02	1.3017000E-01
1.0129000E+03	1.1261000E-01	4.1259000E-01	4.6460000E-02	1.3474000E-01
1.0130000E+03	1.1660000E-01	4.1252000E-01	4.8101000E-02	1.3950000E-01
1.0131000E+03	1.2075000E-01	4.1244000E-01	4.9804000E-02	1.4444000E-01
1.0132000E+03	1.2506000E-01	4.1236000E-01	5.1571000E-02	1.4957000E-01
1.0133000E+03	1.2953000E-01	4.1228000E-01	5.3403000E-02	1.5488000E-01
1.0134000E+03	1.3416000E-01	4.1221000E-01	5.5301000E-02	1.6039000E-01
1.0135000E+03	1.3895000E-01	4.1213000E-01	5.7266000E-02	1.6608000E-01
1.0136000E+03	1.4391000E-01	4.1205000E-01	5.9299000E-02	1.7198000E-01
1.0137000E+03	1.4904000E-01	4.1197000E-01	6.1399000E-02	1.7807000E-01
1.0138000E+03	1.5433000E-01	4.1189000E-01	6.3568000E-02	1.8436000E-01
1.0139000E+03	1.5980000E-01	4.1181000E-01	6.5806000E-02	1.9085000E-01
1.0140000E+03	1.6543000E-01	4.1172000E-01	6.8109000E-02	1.9753000E-01
1.0141000E+03	1.7123000E-01	4.1157000E-01	7.0474000E-02	2.0439000E-01
1.0142000E+03	1.7720000E-01	4.1143000E-01	7.2907000E-02	2.1145000E-01
1.0143000E+03	1.8335000E-01	4.1128000E-01	7.5408000E-02	2.1870000E-01
1.0144000E+03	1.8966000E-01	4.1114000E-01	7.7977000E-02	2.2615000E-01
1.0145000E+03	1.9614000E-01	4.1099000E-01	8.0613000E-02	2.3379000E-01
1.0146000E+03	2.0279000E-01	4.1085000E-01	8.3317000E-02	2.4164000E-01
1.0147000E+03	2.0961000E-01	4.1073000E-01	8.6091000E-02	2.4968000E-01
1.0148000E+03	2.1658000E-01	4.1061000E-01	8.8931000E-02	2.5792000E-01
1.0149000E+03	2.2373000E-01	4.1049000E-01	9.1836000E-02	2.6635000E-01
1.0150000E+03	2.3103000E-01	4.1036000E-01	9.4805000E-02	2.7495000E-01
1.0151000E+03	2.3848000E-01	4.1024000E-01	9.7836000E-02	2.8375000E-01
1.0152000E+03	2.4610000E-01	4.1012000E-01	1.0093000E-01	2.9271000E-01
1.0153000E+03	2.5386000E-01	4.1000000E-01	1.0408000E-01	3.0186000E-01
1.0154000E+03	2.6177000E-01	4.0987000E-01	1.0729000E-01	3.1117000E-01

1.0155000E+03	2.6982000E-01	4.0975000E-01	1.1056000E-01	3.2064000E-01
1.0156000E+03	2.7801000E-01	4.0963000E-01	1.1388000E-01	3.3028000E-01
1.0157000E+03	2.8634000E-01	4.0950000E-01	1.1726000E-01	3.4007000E-01
1.0158000E+03	2.9479000E-01	4.0938000E-01	1.2068000E-01	3.5000000E-01
1.0159000E+03	3.0337000E-01	4.0926000E-01	1.2416000E-01	3.6008000E-01
1.0160000E+03	3.1207000E-01	4.0915000E-01	1.2768000E-01	3.7031000E-01
1.0161000E+03	3.2088000E-01	4.0908000E-01	1.3126000E-01	3.8069000E-01
1.0162000E+03	3.2980000E-01	4.0901000E-01	1.3489000E-01	3.9121000E-01
1.0163000E+03	3.3882000E-01	4.0894000E-01	1.3855000E-01	4.0184000E-01
1.0164000E+03	3.4793000E-01	4.0886000E-01	1.4226000E-01	4.1258000E-01
1.0165000E+03	3.5714000E-01	4.0879000E-01	1.4599000E-01	4.2342000E-01
1.0166000E+03	3.6642000E-01	4.0873000E-01	1.4977000E-01	4.3436000E-01
1.0167000E+03	3.7578000E-01	4.0868000E-01	1.5357000E-01	4.4540000E-01
1.0168000E+03	3.8521000E-01	4.0862000E-01	1.5741000E-01	4.5652000E-01
1.0169000E+03	3.9470000E-01	4.0857000E-01	1.6126000E-01	4.6770000E-01
1.0170000E+03	4.0425000E-01	4.0851000E-01	1.6514000E-01	4.7894000E-01
1.0171000E+03	4.1384000E-01	4.0846000E-01	1.6904000E-01	4.9024000E-01
1.0172000E+03	4.2347000E-01	4.0840000E-01	1.7295000E-01	5.0158000E-01
1.0173000E+03	4.3313000E-01	4.0835000E-01	1.7687000E-01	5.1295000E-01
1.0174000E+03	4.4281000E-01	4.0829000E-01	1.8080000E-01	5.2435000E-01
1.0175000E+03	4.5251000E-01	4.0824000E-01	1.8473000E-01	5.3576000E-01
1.0176000E+03	4.6222000E-01	4.0818000E-01	1.8867000E-01	5.4718000E-01
1.0177000E+03	4.7192000E-01	4.0813000E-01	1.9260000E-01	5.5859000E-01
1.0178000E+03	4.8162000E-01	4.0807000E-01	1.9654000E-01	5.7000000E-01
1.0179000E+03	4.9130000E-01	4.0802000E-01	2.0046000E-01	5.8138000E-01
1.0180000E+03	5.0096000E-01	4.0795000E-01	2.0437000E-01	5.9270000E-01
1.0181000E+03	5.1059000E-01	4.0784000E-01	2.0824000E-01	6.0394000E-01
1.0182000E+03	5.2018000E-01	4.0773000E-01	2.1210000E-01	6.1512000E-01
1.0183000E+03	5.2973000E-01	4.0763000E-01	2.1593000E-01	6.2624000E-01
1.0184000E+03	5.3922000E-01	4.0752000E-01	2.1974000E-01	6.3730000E-01
1.0185000E+03	5.4864000E-01	4.0742000E-01	2.2353000E-01	6.4828000E-01
1.0186000E+03	5.5800000E-01	4.0733000E-01	2.2729000E-01	6.5919000E-01
1.0187000E+03	5.6729000E-01	4.0723000E-01	2.3102000E-01	6.7000000E-01
1.0188000E+03	5.7649000E-01	4.0714000E-01	2.3471000E-01	6.8072000E-01
1.0189000E+03	5.8560000E-01	4.0705000E-01	2.3837000E-01	6.9132000E-01
1.0190000E+03	5.9462000E-01	4.0695000E-01	2.4198000E-01	7.0180000E-01
1.0191000E+03	6.0353000E-01	4.0686000E-01	2.4555000E-01	7.1216000E-01
1.0192000E+03	6.1234000E-01	4.0677000E-01	2.4908000E-01	7.2238000E-01
1.0193000E+03	6.2103000E-01	4.0667000E-01	2.5255000E-01	7.3246000E-01
1.0194000E+03	6.2960000E-01	4.0658000E-01	2.5598000E-01	7.4240000E-01
1.0195000E+03	6.3804000E-01	4.0648000E-01	2.5935000E-01	7.5218000E-01
1.0196000E+03	6.4635000E-01	4.0639000E-01	2.6267000E-01	7.6180000E-01
1.0197000E+03	6.5453000E-01	4.0629000E-01	2.6593000E-01	7.7126000E-01

1.0198000E+03	6.6257000E-01	4.0620000E-01	2.6913000E-01	7.8055000E-01
1.0199000E+03	6.7046000E-01	4.0611000E-01	2.7228000E-01	7.8966000E-01
1.0200000E+03	6.7820000E-01	4.0599000E-01	2.7534000E-01	7.9855000E-01
1.0201000E+03	6.8578000E-01	4.0583000E-01	2.7831000E-01	8.0717000E-01
1.0202000E+03	6.9321000E-01	4.0567000E-01	2.8122000E-01	8.1559000E-01
1.0203000E+03	7.0048000E-01	4.0551000E-01	2.8406000E-01	8.2382000E-01
1.0204000E+03	7.0758000E-01	4.0536000E-01	2.8683000E-01	8.3186000E-01
1.0205000E+03	7.1452000E-01	4.0521000E-01	2.8953000E-01	8.3971000E-01
1.0206000E+03	7.2129000E-01	4.0507000E-01	2.9217000E-01	8.4736000E-01
1.0207000E+03	7.2789000E-01	4.0492000E-01	2.9474000E-01	8.5480000E-01
1.0208000E+03	7.3431000E-01	4.0478000E-01	2.9723000E-01	8.6204000E-01
1.0209000E+03	7.4056000E-01	4.0463000E-01	2.9965000E-01	8.6906000E-01
1.0210000E+03	7.4663000E-01	4.0449000E-01	3.0200000E-01	8.7588000E-01
1.0211000E+03	7.5253000E-01	4.0435000E-01	3.0428000E-01	8.8249000E-01
1.0212000E+03	7.5825000E-01	4.0421000E-01	3.0649000E-01	8.8880000E-01
1.0213000E+03	7.6379000E-01	4.0406000E-01	3.0862000E-01	8.9506000E-01
1.0214000E+03	7.6915000E-01	4.0392000E-01	3.1068000E-01	9.0103000E-01
1.0215000E+03	7.7433000E-01	4.0378000E-01	3.1266000E-01	9.0678000E-01
1.0216000E+03	7.7934000E-01	4.0364000E-01	3.1457000E-01	9.1232000E-01
1.0217000E+03	7.8416000E-01	4.0350000E-01	3.1641000E-01	9.1765000E-01
1.0218000E+03	7.8881000E-01	4.0336000E-01	3.1817000E-01	9.2277000E-01
1.0219000E+03	7.9329000E-01	4.0322000E-01	3.1987000E-01	9.2769000E-01
1.0220000E+03	7.9759000E-01	4.0310000E-01	3.2151000E-01	9.3244000E-01
1.0221000E+03	8.0172000E-01	4.0304000E-01	3.2312000E-01	9.3713000E-01
1.0222000E+03	8.0568000E-01	4.0297000E-01	3.2467000E-01	9.4161000E-01
1.0223000E+03	8.0947000E-01	4.0291000E-01	3.2615000E-01	9.4589000E-01
1.0224000E+03	8.1310000E-01	4.0285000E-01	3.2756000E-01	9.4999000E-01
1.0225000E+03	8.1656000E-01	4.0280000E-01	3.2891000E-01	9.5390000E-01
1.0226000E+03	8.1986000E-01	4.0274000E-01	3.3019000E-01	9.5763000E-01
1.0227000E+03	8.2301000E-01	4.0269000E-01	3.3141000E-01	9.6117000E-01
1.0228000E+03	8.2599000E-01	4.0263000E-01	3.3257000E-01	9.6452000E-01
1.0229000E+03	8.2883000E-01	4.0257000E-01	3.3366000E-01	9.6770000E-01
1.0230000E+03	8.3152000E-01	4.0252000E-01	3.3470000E-01	9.7070000E-01
1.0231000E+03	8.3406000E-01	4.0246000E-01	3.3567000E-01	9.7353000E-01
1.0232000E+03	8.3645000E-01	4.0240000E-01	3.3659000E-01	9.7619000E-01
1.0233000E+03	8.3872000E-01	4.0235000E-01	3.3745000E-01	9.7869000E-01
1.0234000E+03	8.4084000E-01	4.0229000E-01	3.3826000E-01	9.8103000E-01
1.0235000E+03	8.4284000E-01	4.0223000E-01	3.3902000E-01	9.8322000E-01
1.0236000E+03	8.4471000E-01	4.0217000E-01	3.3972000E-01	9.8526000E-01
1.0237000E+03	8.4645000E-01	4.0212000E-01	3.4037000E-01	9.8715000E-01
1.0238000E+03	8.4808000E-01	4.0206000E-01	3.4098000E-01	9.8891000E-01
1.0239000E+03	8.4959000E-01	4.0200000E-01	3.4154000E-01	9.9053000E-01
1.0240000E+03	8.5098000E-01	4.0193000E-01	3.4204000E-01	9.9199000E-01

1.0241000E+03	8.5228000E-01	4.0183000E-01	3.4247000E-01	9.9324000E-01
1.0242000E+03	8.5346000E-01	4.0173000E-01	3.4286000E-01	9.9437000E-01
1.0243000E+03	8.5455000E-01	4.0162000E-01	3.4321000E-01	9.9537000E-01
1.0244000E+03	8.5554000E-01	4.0151000E-01	3.4351000E-01	9.9626000E-01
1.0245000E+03	8.5645000E-01	4.0140000E-01	3.4378000E-01	9.9704000E-01
1.0246000E+03	8.5726000E-01	4.0130000E-01	3.4402000E-01	9.9772000E-01
1.0247000E+03	8.5799000E-01	4.0119000E-01	3.4422000E-01	9.9830000E-01
1.0248000E+03	8.5864000E-01	4.0108000E-01	3.4438000E-01	9.9879000E-01
1.0249000E+03	8.5922000E-01	4.0097000E-01	3.4452000E-01	9.9918000E-01
1.0250000E+03	8.5972000E-01	4.0086000E-01	3.4463000E-01	9.9950000E-01
1.0251000E+03	8.6015000E-01	4.0075000E-01	3.4471000E-01	9.9973000E-01
1.0252000E+03	8.6052000E-01	4.0065000E-01	3.4477000E-01	9.9989000E-01
1.0253000E+03	8.6083000E-01	4.0054000E-01	3.4480000E-01	9.9998000E-01
1.0254000E+03	8.6108000E-01	4.0043000E-01	3.4480000E-01	1.0000000E+00
1.0255000E+03	8.6127000E-01	4.0032000E-01	3.4479000E-01	9.9996000E-01
1.0256000E+03	8.6141000E-01	4.0022000E-01	3.4475000E-01	9.9986000E-01
1.0257000E+03	8.6151000E-01	4.0011000E-01	3.4470000E-01	9.9970000E-01
1.0258000E+03	8.6156000E-01	4.0000000E-01	3.4463000E-01	9.9949000E-01
1.0259000E+03	8.6156000E-01	3.9990000E-01	3.4454000E-01	9.9923000E-01
1.0260000E+03	8.6153000E-01	3.9977000E-01	3.4442000E-01	9.9888000E-01
1.0261000E+03	8.6146000E-01	3.9962000E-01	3.4425000E-01	9.9841000E-01
1.0262000E+03	8.6136000E-01	3.9946000E-01	3.4408000E-01	9.9790000E-01
1.0263000E+03	8.6122000E-01	3.9931000E-01	3.4390000E-01	9.9737000E-01
1.0264000E+03	8.6106000E-01	3.9916000E-01	3.4370000E-01	9.9681000E-01
1.0265000E+03	8.6086000E-01	3.9901000E-01	3.4350000E-01	9.9621000E-01
1.0266000E+03	8.6065000E-01	3.9886000E-01	3.4328000E-01	9.9559000E-01
1.0267000E+03	8.6041000E-01	3.9872000E-01	3.4306000E-01	9.9494000E-01
1.0268000E+03	8.6014000E-01	3.9857000E-01	3.4282000E-01	9.9426000E-01
1.0269000E+03	8.5987000E-01	3.9842000E-01	3.4259000E-01	9.9357000E-01
1.0270000E+03	8.5957000E-01	3.9827000E-01	3.4234000E-01	9.9286000E-01
1.0271000E+03	8.5925000E-01	3.9812000E-01	3.4209000E-01	9.9213000E-01
1.0272000E+03	8.5893000E-01	3.9798000E-01	3.4183000E-01	9.9139000E-01
1.0273000E+03	8.5859000E-01	3.9783000E-01	3.4157000E-01	9.9064000E-01
1.0274000E+03	8.5823000E-01	3.9769000E-01	3.4131000E-01	9.8987000E-01
1.0275000E+03	8.5787000E-01	3.9754000E-01	3.4104000E-01	9.8909000E-01
1.0276000E+03	8.5750000E-01	3.9740000E-01	3.4077000E-01	9.8830000E-01
1.0277000E+03	8.5712000E-01	3.9725000E-01	3.4049000E-01	9.8750000E-01
1.0278000E+03	8.5673000E-01	3.9711000E-01	3.4022000E-01	9.8670000E-01
1.0279000E+03	8.5634000E-01	3.9696000E-01	3.3993000E-01	9.8588000E-01
1.0280000E+03	8.5593000E-01	3.9683000E-01	3.3966000E-01	9.8508000E-01
1.0281000E+03	8.5553000E-01	3.9671000E-01	3.3940000E-01	9.8433000E-01
1.0282000E+03	8.5512000E-01	3.9661000E-01	3.3915000E-01	9.8359000E-01
1.0283000E+03	8.5470000E-01	3.9650000E-01	3.3889000E-01	9.8285000E-01

1.0284000E+03	8.5428000E-01	3.9639000E-01	3.3863000E-01	9.8210000E-01
1.0285000E+03	8.5385000E-01	3.9629000E-01	3.3837000E-01	9.8134000E-01
1.0286000E+03	8.5342000E-01	3.9618000E-01	3.3811000E-01	9.8059000E-01
1.0287000E+03	8.5299000E-01	3.9607000E-01	3.3784000E-01	9.7982000E-01
1.0288000E+03	8.5255000E-01	3.9596000E-01	3.3758000E-01	9.7905000E-01
1.0289000E+03	8.5211000E-01	3.9586000E-01	3.3731000E-01	9.7828000E-01
1.0290000E+03	8.5166000E-01	3.9575000E-01	3.3705000E-01	9.7750000E-01
1.0291000E+03	8.5121000E-01	3.9564000E-01	3.3678000E-01	9.7672000E-01
1.0292000E+03	8.5075000E-01	3.9554000E-01	3.3650000E-01	9.7593000E-01
1.0293000E+03	8.5029000E-01	3.9543000E-01	3.3623000E-01	9.7513000E-01
1.0294000E+03	8.4982000E-01	3.9532000E-01	3.3595000E-01	9.7433000E-01
1.0295000E+03	8.4934000E-01	3.9522000E-01	3.3567000E-01	9.7352000E-01
1.0296000E+03	8.4885000E-01	3.9511000E-01	3.3539000E-01	9.7270000E-01
1.0297000E+03	8.4836000E-01	3.9500000E-01	3.3510000E-01	9.7187000E-01
1.0298000E+03	8.4786000E-01	3.9489000E-01	3.3481000E-01	9.7103000E-01
1.0299000E+03	8.4734000E-01	3.9479000E-01	3.3452000E-01	9.7018000E-01
1.0300000E+03	8.4682000E-01	3.9470000E-01	3.3424000E-01	9.6936000E-01
1.0301000E+03	8.4628000E-01	3.9465000E-01	3.3399000E-01	9.6863000E-01
1.0302000E+03	8.4573000E-01	3.9460000E-01	3.3373000E-01	9.6789000E-01
1.0303000E+03	8.4517000E-01	3.9456000E-01	3.3347000E-01	9.6713000E-01
1.0304000E+03	8.4459000E-01	3.9451000E-01	3.3320000E-01	9.6635000E-01
1.0305000E+03	8.4399000E-01	3.9446000E-01	3.3292000E-01	9.6555000E-01
1.0306000E+03	8.4338000E-01	3.9442000E-01	3.3264000E-01	9.6473000E-01
1.0307000E+03	8.4274000E-01	3.9437000E-01	3.3235000E-01	9.6389000E-01
1.0308000E+03	8.4208000E-01	3.9433000E-01	3.3205000E-01	9.6303000E-01
1.0309000E+03	8.4140000E-01	3.9428000E-01	3.3175000E-01	9.6214000E-01
1.0310000E+03	8.4069000E-01	3.9423000E-01	3.3143000E-01	9.6122000E-01
1.0311000E+03	8.3996000E-01	3.9419000E-01	3.3110000E-01	9.6027000E-01
1.0312000E+03	8.3920000E-01	3.9415000E-01	3.3077000E-01	9.5929000E-01
1.0313000E+03	8.3841000E-01	3.9410000E-01	3.3042000E-01	9.5828000E-01
1.0314000E+03	8.3758000E-01	3.9406000E-01	3.3006000E-01	9.5723000E-01
1.0315000E+03	8.3672000E-01	3.9401000E-01	3.2968000E-01	9.5614000E-01
1.0316000E+03	8.3583000E-01	3.9397000E-01	3.2929000E-01	9.5501000E-01
1.0317000E+03	8.3489000E-01	3.9392000E-01	3.2888000E-01	9.5383000E-01
1.0318000E+03	8.3392000E-01	3.9388000E-01	3.2846000E-01	9.5261000E-01
1.0319000E+03	8.3290000E-01	3.9383000E-01	3.2803000E-01	9.5134000E-01
1.0320000E+03	8.3184000E-01	3.9377000E-01	3.2755000E-01	9.4998000E-01
1.0321000E+03	8.3073000E-01	3.9367000E-01	3.2703000E-01	9.4846000E-01
1.0322000E+03	8.2957000E-01	3.9356000E-01	3.2649000E-01	9.4688000E-01
1.0323000E+03	8.2835000E-01	3.9346000E-01	3.2592000E-01	9.4525000E-01
1.0324000E+03	8.2708000E-01	3.9336000E-01	3.2534000E-01	9.4355000E-01
1.0325000E+03	8.2576000E-01	3.9325000E-01	3.2473000E-01	9.4179000E-01
1.0326000E+03	8.2437000E-01	3.9315000E-01	3.2410000E-01	9.3996000E-01

1.0327000E+03	8.2292000E-01	3.9304000E-01	3.2344000E-01	9.3805000E-01
1.0328000E+03	8.2140000E-01	3.9294000E-01	3.2276000E-01	9.3608000E-01
1.0329000E+03	8.1982000E-01	3.9284000E-01	3.2205000E-01	9.3402000E-01
1.0330000E+03	8.1816000E-01	3.9273000E-01	3.2132000E-01	9.3189000E-01
1.0331000E+03	8.1643000E-01	3.9263000E-01	3.2055000E-01	9.2967000E-01
1.0332000E+03	8.1462000E-01	3.9252000E-01	3.1976000E-01	9.2736000E-01
1.0333000E+03	8.1274000E-01	3.9242000E-01	3.1893000E-01	9.2497000E-01
1.0334000E+03	8.1077000E-01	3.9231000E-01	3.1807000E-01	9.2248000E-01
1.0335000E+03	8.0871000E-01	3.9221000E-01	3.1718000E-01	9.1989000E-01
1.0336000E+03	8.0657000E-01	3.9210000E-01	3.1626000E-01	9.1721000E-01
1.0337000E+03	8.0434000E-01	3.9200000E-01	3.1530000E-01	9.1443000E-01
1.0338000E+03	8.0201000E-01	3.9189000E-01	3.1430000E-01	9.1154000E-01
1.0339000E+03	7.9959000E-01	3.9179000E-01	3.1327000E-01	9.0855000E-01
1.0340000E+03	7.9706000E-01	3.9167000E-01	3.1219000E-01	9.0540000E-01
1.0341000E+03	7.9444000E-01	3.9148000E-01	3.1100000E-01	9.0198000E-01
1.0342000E+03	7.9171000E-01	3.9128000E-01	3.0978000E-01	8.9844000E-01
1.0343000E+03	7.8887000E-01	3.9109000E-01	3.0852000E-01	8.9478000E-01
1.0344000E+03	7.8593000E-01	3.9090000E-01	3.0722000E-01	8.9100000E-01
1.0345000E+03	7.8287000E-01	3.9070000E-01	3.0587000E-01	8.8709000E-01
1.0346000E+03	7.7970000E-01	3.9051000E-01	3.0448000E-01	8.8306000E-01
1.0347000E+03	7.7641000E-01	3.9032000E-01	3.0305000E-01	8.7890000E-01
1.0348000E+03	7.7301000E-01	3.9013000E-01	3.0157000E-01	8.7461000E-01
1.0349000E+03	7.6948000E-01	3.8993000E-01	3.0004000E-01	8.7019000E-01
1.0350000E+03	7.6583000E-01	3.8974000E-01	2.9847000E-01	8.6563000E-01
1.0351000E+03	7.6205000E-01	3.8954000E-01	2.9685000E-01	8.6093000E-01
1.0352000E+03	7.5815000E-01	3.8935000E-01	2.9518000E-01	8.5610000E-01
1.0353000E+03	7.5412000E-01	3.8915000E-01	2.9347000E-01	8.5112000E-01
1.0354000E+03	7.4996000E-01	3.8896000E-01	2.9170000E-01	8.4600000E-01
1.0355000E+03	7.4567000E-01	3.8876000E-01	2.8989000E-01	8.4074000E-01
1.0356000E+03	7.4125000E-01	3.8857000E-01	2.8802000E-01	8.3533000E-01
1.0357000E+03	7.3669000E-01	3.8837000E-01	2.8611000E-01	8.2978000E-01
1.0358000E+03	7.3201000E-01	3.8818000E-01	2.8415000E-01	8.2409000E-01
1.0359000E+03	7.2718000E-01	3.8798000E-01	2.8213000E-01	8.1824000E-01
1.0360000E+03	7.2222000E-01	3.8781000E-01	2.8009000E-01	8.1232000E-01
1.0361000E+03	7.1713000E-01	3.8774000E-01	2.7806000E-01	8.0643000E-01
1.0362000E+03	7.1190000E-01	3.8766000E-01	2.7598000E-01	8.0039000E-01
1.0363000E+03	7.0654000E-01	3.8759000E-01	2.7384000E-01	7.9421000E-01
1.0364000E+03	7.0104000E-01	3.8751000E-01	2.7166000E-01	7.8787000E-01
1.0365000E+03	6.9541000E-01	3.8743000E-01	2.6942000E-01	7.8139000E-01
1.0366000E+03	6.8964000E-01	3.8736000E-01	2.6714000E-01	7.7475000E-01
1.0367000E+03	6.8374000E-01	3.8728000E-01	2.6480000E-01	7.6798000E-01
1.0368000E+03	6.7771000E-01	3.8721000E-01	2.6241000E-01	7.6105000E-01
1.0369000E+03	6.7154000E-01	3.8713000E-01	2.5997000E-01	7.5398000E-01

1.0370000E+03	6.6525000E-01	3.8705000E-01	2.5749000E-01	7.4677000E-01
1.0371000E+03	6.5884000E-01	3.8698000E-01	2.5495000E-01	7.3942000E-01
1.0372000E+03	6.5229000E-01	3.8690000E-01	2.5237000E-01	7.3193000E-01
1.0373000E+03	6.4563000E-01	3.8682000E-01	2.4974000E-01	7.2430000E-01
1.0374000E+03	6.3884000E-01	3.8674000E-01	2.4707000E-01	7.1655000E-01
1.0375000E+03	6.3194000E-01	3.8666000E-01	2.4435000E-01	7.0866000E-01
1.0376000E+03	6.2492000E-01	3.8659000E-01	2.4159000E-01	7.0065000E-01
1.0377000E+03	6.1779000E-01	3.8651000E-01	2.3878000E-01	6.9251000E-01
1.0378000E+03	6.1055000E-01	3.8643000E-01	2.3594000E-01	6.8426000E-01
1.0379000E+03	6.0321000E-01	3.8635000E-01	2.3305000E-01	6.7590000E-01
1.0380000E+03	5.9576000E-01	3.8628000E-01	2.3013000E-01	6.6743000E-01
1.0381000E+03	5.8822000E-01	3.8623000E-01	2.2719000E-01	6.5889000E-01
1.0382000E+03	5.8058000E-01	3.8618000E-01	2.2421000E-01	6.5025000E-01
1.0383000E+03	5.7285000E-01	3.8613000E-01	2.2120000E-01	6.4152000E-01
1.0384000E+03	5.6504000E-01	3.8608000E-01	2.1815000E-01	6.3269000E-01
1.0385000E+03	5.5715000E-01	3.8603000E-01	2.1508000E-01	6.2377000E-01
1.0386000E+03	5.4919000E-01	3.8598000E-01	2.1197000E-01	6.1477000E-01
1.0387000E+03	5.4115000E-01	3.8593000E-01	2.0884000E-01	6.0569000E-01
1.0388000E+03	5.3305000E-01	3.8588000E-01	2.0569000E-01	5.9654000E-01
1.0389000E+03	5.2488000E-01	3.8583000E-01	2.0251000E-01	5.8733000E-01
1.0390000E+03	5.1666000E-01	3.8577000E-01	1.9932000E-01	5.7806000E-01
1.0391000E+03	5.0840000E-01	3.8572000E-01	1.9610000E-01	5.6873000E-01
1.0392000E+03	5.0008000E-01	3.8567000E-01	1.9286000E-01	5.5935000E-01
1.0393000E+03	4.9173000E-01	3.8561000E-01	1.8962000E-01	5.4993000E-01
1.0394000E+03	4.8335000E-01	3.8556000E-01	1.8636000E-01	5.4048000E-01
1.0395000E+03	4.7494000E-01	3.8550000E-01	1.8309000E-01	5.3100000E-01
1.0396000E+03	4.6651000E-01	3.8545000E-01	1.7981000E-01	5.2150000E-01
1.0397000E+03	4.5806000E-01	3.8540000E-01	1.7653000E-01	5.1199000E-01
1.0398000E+03	4.4960000E-01	3.8535000E-01	1.7325000E-01	5.0247000E-01
1.0399000E+03	4.4114000E-01	3.8529000E-01	1.6997000E-01	4.9295000E-01
1.0400000E+03	4.3268000E-01	3.8522000E-01	1.6668000E-01	4.8340000E-01
1.0401000E+03	4.2423000E-01	3.8510000E-01	1.6337000E-01	4.7381000E-01
1.0402000E+03	4.1579000E-01	3.8497000E-01	1.6007000E-01	4.6424000E-01
1.0403000E+03	4.0738000E-01	3.8485000E-01	1.5678000E-01	4.5469000E-01
1.0404000E+03	3.9899000E-01	3.8473000E-01	1.5350000E-01	4.4518000E-01
1.0405000E+03	3.9063000E-01	3.8460000E-01	1.5024000E-01	4.3572000E-01
1.0406000E+03	3.8230000E-01	3.8448000E-01	1.4699000E-01	4.2630000E-01
1.0407000E+03	3.7402000E-01	3.8436000E-01	1.4376000E-01	4.1693000E-01
1.0408000E+03	3.6579000E-01	3.8423000E-01	1.4055000E-01	4.0762000E-01
1.0409000E+03	3.5762000E-01	3.8411000E-01	1.3736000E-01	3.9838000E-01
1.0410000E+03	3.4950000E-01	3.8399000E-01	1.3420000E-01	3.8922000E-01
1.0411000E+03	3.4145000E-01	3.8386000E-01	1.3107000E-01	3.8013000E-01
1.0412000E+03	3.3347000E-01	3.8374000E-01	1.2797000E-01	3.7113000E-01

1.0413000E+03	3.2556000E-01	3.8362000E-01	1.2489000E-01	3.6221000E-01
1.0414000E+03	3.1773000E-01	3.8350000E-01	1.2185000E-01	3.5339000E-01
1.0415000E+03	3.0998000E-01	3.8338000E-01	1.1884000E-01	3.4467000E-01
1.0416000E+03	3.0233000E-01	3.8326000E-01	1.1587000E-01	3.3605000E-01
1.0417000E+03	2.9476000E-01	3.8315000E-01	1.1294000E-01	3.2755000E-01
1.0418000E+03	2.8730000E-01	3.8303000E-01	1.1005000E-01	3.1916000E-01
1.0419000E+03	2.7993000E-01	3.8292000E-01	1.0719000E-01	3.1088000E-01
1.0420000E+03	2.7267000E-01	3.8279000E-01	1.0438000E-01	3.0272000E-01
1.0421000E+03	2.6552000E-01	3.8264000E-01	1.0160000E-01	2.9466000E-01
1.0422000E+03	2.5848000E-01	3.8248000E-01	9.8865000E-02	2.8673000E-01
1.0423000E+03	2.5156000E-01	3.8233000E-01	9.6177000E-02	2.7893000E-01
1.0424000E+03	2.4475000E-01	3.8217000E-01	9.3536000E-02	2.7127000E-01
1.0425000E+03	2.3806000E-01	3.8202000E-01	9.0943000E-02	2.6375000E-01
1.0426000E+03	2.3149000E-01	3.8186000E-01	8.8399000E-02	2.5638000E-01
1.0427000E+03	2.2505000E-01	3.8171000E-01	8.5904000E-02	2.4914000E-01
1.0428000E+03	2.1874000E-01	3.8155000E-01	8.3460000E-02	2.4205000E-01
1.0429000E+03	2.1255000E-01	3.8140000E-01	8.1067000E-02	2.3511000E-01
1.0430000E+03	2.0650000E-01	3.8124000E-01	7.8726000E-02	2.2832000E-01
1.0431000E+03	2.0057000E-01	3.8109000E-01	7.6437000E-02	2.2168000E-01
1.0432000E+03	1.9478000E-01	3.8094000E-01	7.4199000E-02	2.1519000E-01
1.0433000E+03	1.8912000E-01	3.8078000E-01	7.2014000E-02	2.0886000E-01
1.0434000E+03	1.8360000E-01	3.8063000E-01	6.9882000E-02	2.0267000E-01
1.0435000E+03	1.7820000E-01	3.8048000E-01	6.7803000E-02	1.9664000E-01
1.0436000E+03	1.7295000E-01	3.8032000E-01	6.5775000E-02	1.9076000E-01
1.0437000E+03	1.6782000E-01	3.8016000E-01	6.3799000E-02	1.8503000E-01
1.0438000E+03	1.6283000E-01	3.8000000E-01	6.1876000E-02	1.7945000E-01
1.0439000E+03	1.5798000E-01	3.7984000E-01	6.0005000E-02	1.7403000E-01
1.0440000E+03	1.5325000E-01	3.7969000E-01	5.8188000E-02	1.6876000E-01
1.0441000E+03	1.4866000E-01	3.7956000E-01	5.6424000E-02	1.6364000E-01
1.0442000E+03	1.4420000E-01	3.7943000E-01	5.4711000E-02	1.5867000E-01
1.0443000E+03	1.3986000E-01	3.7930000E-01	5.3049000E-02	1.5385000E-01
1.0444000E+03	1.3566000E-01	3.7916000E-01	5.1436000E-02	1.4917000E-01
1.0445000E+03	1.3158000E-01	3.7903000E-01	4.9871000E-02	1.4464000E-01
1.0446000E+03	1.2762000E-01	3.7890000E-01	4.8356000E-02	1.4024000E-01
1.0447000E+03	1.2379000E-01	3.7877000E-01	4.6887000E-02	1.3598000E-01
1.0448000E+03	1.2007000E-01	3.7864000E-01	4.5465000E-02	1.3186000E-01
1.0449000E+03	1.1648000E-01	3.7851000E-01	4.4089000E-02	1.2787000E-01
1.0450000E+03	1.1300000E-01	3.7838000E-01	4.2758000E-02	1.2401000E-01
1.0451000E+03	1.0964000E-01	3.7826000E-01	4.1470000E-02	1.2027000E-01
1.0452000E+03	1.0638000E-01	3.7813000E-01	4.0226000E-02	1.1666000E-01
1.0453000E+03	1.0324000E-01	3.7800000E-01	3.9023000E-02	1.1318000E-01
1.0454000E+03	1.0020000E-01	3.7787000E-01	3.7861000E-02	1.0981000E-01
1.0455000E+03	9.7259000E-02	3.7775000E-01	3.6739000E-02	1.0655000E-01

1.0456000E+03	9.4422000E-02	3.7763000E-01	3.5657000E-02	1.0341000E-01
1.0457000E+03	9.1683000E-02	3.7751000E-01	3.4611000E-02	1.0038000E-01
1.0458000E+03	8.9038000E-02	3.7739000E-01	3.3602000E-02	9.7454000E-02
1.0459000E+03	8.6485000E-02	3.7728000E-01	3.2629000E-02	9.4630000E-02
1.0460000E+03	8.4020000E-02	3.7719000E-01	3.1691000E-02	9.1912000E-02
1.0461000E+03	8.1640000E-02	3.7718000E-01	3.0793000E-02	8.9306000E-02
1.0462000E+03	7.9343000E-02	3.7717000E-01	2.9926000E-02	8.6791000E-02
1.0463000E+03	7.7126000E-02	3.7716000E-01	2.9089000E-02	8.4363000E-02
1.0464000E+03	7.4985000E-02	3.7715000E-01	2.8280000E-02	8.2019000E-02
1.0465000E+03	7.2918000E-02	3.7714000E-01	2.7500000E-02	7.9755000E-02
1.0466000E+03	7.0921000E-02	3.7712000E-01	2.6746000E-02	7.7569000E-02
1.0467000E+03	6.8992000E-02	3.7711000E-01	2.6018000E-02	7.5457000E-02
1.0468000E+03	6.7127000E-02	3.7710000E-01	2.5314000E-02	7.3416000E-02
1.0469000E+03	6.5325000E-02	3.7709000E-01	2.4634000E-02	7.1443000E-02
1.0470000E+03	6.3582000E-02	3.7708000E-01	2.3976000E-02	6.9535000E-02
1.0471000E+03	6.1895000E-02	3.7708000E-01	2.3339000E-02	6.7689000E-02
1.0472000E+03	6.0261000E-02	3.7707000E-01	2.2723000E-02	6.5901000E-02
1.0473000E+03	5.8679000E-02	3.7707000E-01	2.2126000E-02	6.4170000E-02
1.0474000E+03	5.7145000E-02	3.7707000E-01	2.1548000E-02	6.2492000E-02
1.0475000E+03	5.5657000E-02	3.7707000E-01	2.0987000E-02	6.0867000E-02
1.0476000E+03	5.4213000E-02	3.7708000E-01	2.0443000E-02	5.9288000E-02
1.0477000E+03	5.2811000E-02	3.7709000E-01	1.9914000E-02	5.7755000E-02
1.0478000E+03	5.1447000E-02	3.7710000E-01	1.9400000E-02	5.6265000E-02
1.0479000E+03	5.0120000E-02	3.7710000E-01	1.8900000E-02	5.4815000E-02
1.0480000E+03	4.8828000E-02	3.7710000E-01	1.8413000E-02	5.3401000E-02
1.0481000E+03	4.7569000E-02	3.7705000E-01	1.7936000E-02	5.2018000E-02
1.0482000E+03	4.6342000E-02	3.7700000E-01	1.7471000E-02	5.0669000E-02
1.0483000E+03	4.5284000E-02	3.7695000E-01	1.7070000E-02	4.9506000E-02
1.0484000E+03	4.4106000E-02	3.7690000E-01	1.6623000E-02	4.8212000E-02
1.0485000E+03	4.2955000E-02	3.7685000E-01	1.6188000E-02	4.6947000E-02
1.0486000E+03	4.1829000E-02	3.7680000E-01	1.5761000E-02	4.5711000E-02
1.0487000E+03	4.0728000E-02	3.7675000E-01	1.5344000E-02	4.4502000E-02
1.0488000E+03	3.9650000E-02	3.7671000E-01	1.4936000E-02	4.3318000E-02
1.0489000E+03	3.8593000E-02	3.7666000E-01	1.4536000E-02	4.2159000E-02
1.0490000E+03	3.7558000E-02	3.7661000E-01	1.4145000E-02	4.1022000E-02
1.0491000E+03	3.6542000E-02	3.7656000E-01	1.3760000E-02	3.9908000E-02
1.0492000E+03	3.5546000E-02	3.7651000E-01	1.3384000E-02	3.8815000E-02
1.0493000E+03	3.4568000E-02	3.7647000E-01	1.3014000E-02	3.7743000E-02
1.0494000E+03	3.3608000E-02	3.7642000E-01	1.2651000E-02	3.6690000E-02
1.0495000E+03	3.2666000E-02	3.7637000E-01	1.2294000E-02	3.5656000E-02
1.0496000E+03	3.1740000E-02	3.7632000E-01	1.1945000E-02	3.4642000E-02
1.0497000E+03	3.0831000E-02	3.7627000E-01	1.1601000E-02	3.3646000E-02
1.0498000E+03	2.9939000E-02	3.7623000E-01	1.1264000E-02	3.2667000E-02

1.0499000E+03	2.9062000E-02	3.7618000E-01	1.0933000E-02	3.1707000E-02
1.0500000E+03	2.8202000E-02	3.7612000E-01	1.0607000E-02	3.0763000E-02
1.0501000E+03	2.7357000E-02	3.7602000E-01	1.0287000E-02	2.9834000E-02
1.0502000E+03	2.6529000E-02	3.7592000E-01	9.9727000E-03	2.8923000E-02
1.0503000E+03	2.5716000E-02	3.7582000E-01	9.6646000E-03	2.8030000E-02
1.0504000E+03	2.4919000E-02	3.7573000E-01	9.3627000E-03	2.7154000E-02
1.0505000E+03	2.4138000E-02	3.7563000E-01	9.0670000E-03	2.6296000E-02
1.0506000E+03	2.3373000E-02	3.7553000E-01	8.7775000E-03	2.5457000E-02
1.0507000E+03	2.2625000E-02	3.7543000E-01	8.4942000E-03	2.4635000E-02
1.0508000E+03	2.1893000E-02	3.7534000E-01	8.2173000E-03	2.3832000E-02
1.0509000E+03	2.1178000E-02	3.7524000E-01	7.9468000E-03	2.3047000E-02
1.0510000E+03	2.0480000E-02	3.7514000E-01	7.6827000E-03	2.2282000E-02
1.0511000E+03	1.9798000E-02	3.7504000E-01	7.4251000E-03	2.1534000E-02
1.0512000E+03	1.9134000E-02	3.7494000E-01	7.1741000E-03	2.0806000E-02
1.0513000E+03	1.8487000E-02	3.7484000E-01	6.9296000E-03	2.0097000E-02
1.0514000E+03	1.7857000E-02	3.7474000E-01	6.6918000E-03	1.9408000E-02
1.0515000E+03	1.7245000E-02	3.7464000E-01	6.4607000E-03	1.8737000E-02
1.0516000E+03	1.6651000E-02	3.7453000E-01	6.2364000E-03	1.8087000E-02
1.0517000E+03	1.6074000E-02	3.7443000E-01	6.0188000E-03	1.7456000E-02
1.0518000E+03	1.5516000E-02	3.7433000E-01	5.8080000E-03	1.6844000E-02
1.0519000E+03	1.4975000E-02	3.7423000E-01	5.6039000E-03	1.6252000E-02
1.0520000E+03	1.4451000E-02	3.7414000E-01	5.4067000E-03	1.5681000E-02
1.0521000E+03	1.3945000E-02	3.7408000E-01	5.2167000E-03	1.5129000E-02
1.0522000E+03	1.3457000E-02	3.7402000E-01	5.0332000E-03	1.4597000E-02
1.0523000E+03	1.2986000E-02	3.7396000E-01	4.8562000E-03	1.4084000E-02
1.0524000E+03	1.2532000E-02	3.7391000E-01	4.6858000E-03	1.3590000E-02
1.0525000E+03	1.2095000E-02	3.7385000E-01	4.5216000E-03	1.3114000E-02
1.0526000E+03	1.1674000E-02	3.7379000E-01	4.3638000E-03	1.2656000E-02
1.0527000E+03	1.1270000E-02	3.7374000E-01	4.2121000E-03	1.2216000E-02
1.0528000E+03	1.0882000E-02	3.7368000E-01	4.0664000E-03	1.1794000E-02
1.0529000E+03	1.0510000E-02	3.7362000E-01	3.9267000E-03	1.1388000E-02
1.0530000E+03	1.0153000E-02	3.7356000E-01	3.7928000E-03	1.1000000E-02
1.0531000E+03	9.8111000E-03	3.7350000E-01	3.6644000E-03	1.0628000E-02
1.0532000E+03	9.4839000E-03	3.7344000E-01	3.5416000E-03	1.0271000E-02
1.0533000E+03	9.1711000E-03	3.7337000E-01	3.4242000E-03	9.9310000E-03
1.0534000E+03	8.8723000E-03	3.7331000E-01	3.3121000E-03	9.6058000E-03
1.0535000E+03	8.5873000E-03	3.7324000E-01	3.2051000E-03	9.2956000E-03
1.0536000E+03	8.3157000E-03	3.7318000E-01	3.1032000E-03	9.0000000E-03
1.0537000E+03	8.0572000E-03	3.7311000E-01	3.0063000E-03	8.7188000E-03
1.0538000E+03	7.8117000E-03	3.7305000E-01	2.9141000E-03	8.4516000E-03
1.0539000E+03	7.5788000E-03	3.7298000E-01	2.8268000E-03	8.1983000E-03
1.0540000E+03	7.3584000E-03	3.7290000E-01	2.7439000E-03	7.9580000E-03
1.0541000E+03	7.1502000E-03	3.7277000E-01	2.6654000E-03	7.7301000E-03

1.0542000E+03	6.9540000E-03	3.7264000E-01	2.5913000E-03	7.5154000E-03
1.0543000E+03	6.7697000E-03	3.7250000E-01	2.5217000E-03	7.3136000E-03
1.0544000E+03	6.5970000E-03	3.7237000E-01	2.4566000E-03	7.1245000E-03
1.0545000E+03	6.4359000E-03	3.7224000E-01	2.3957000E-03	6.9480000E-03
1.0546000E+03	6.2859000E-03	3.7211000E-01	2.3391000E-03	6.7837000E-03
1.0547000E+03	6.1470000E-03	3.7198000E-01	2.2865000E-03	6.6315000E-03
1.0548000E+03	6.0188000E-03	3.7185000E-01	2.2381000E-03	6.4908000E-03
1.0549000E+03	5.9009000E-03	3.7172000E-01	2.1935000E-03	6.3615000E-03
1.0550000E+03	5.7931000E-03	3.7158000E-01	2.1526000E-03	6.2431000E-03
1.0551000E+03	5.6949000E-03	3.7145000E-01	2.1154000E-03	6.1351000E-03
1.0552000E+03	5.6059000E-03	3.7132000E-01	2.0816000E-03	6.0370000E-03
1.0553000E+03	5.5254000E-03	3.7119000E-01	2.0509000E-03	5.9482000E-03
1.0554000E+03	5.4528000E-03	3.7105000E-01	2.0233000E-03	5.8679000E-03
1.0555000E+03	5.3876000E-03	3.7092000E-01	1.9983000E-03	5.7956000E-03
1.0556000E+03	5.3289000E-03	3.7079000E-01	1.9759000E-03	5.7304000E-03
1.0557000E+03	5.2760000E-03	3.7065000E-01	1.9556000E-03	5.6715000E-03
1.0558000E+03	5.2281000E-03	3.7052000E-01	1.9371000E-03	5.6181000E-03
1.0559000E+03	5.1844000E-03	3.7039000E-01	1.9202000E-03	5.5691000E-03
1.0560000E+03	5.1440000E-03	3.7026000E-01	1.9046000E-03	5.5239000E-03
1.0561000E+03	5.1061000E-03	3.7017000E-01	1.8901000E-03	5.4817000E-03
1.0562000E+03	5.0697000E-03	3.7008000E-01	1.8762000E-03	5.4413000E-03
1.0563000E+03	5.0341000E-03	3.6998000E-01	1.8625000E-03	5.4018000E-03
1.0564000E+03	4.9984000E-03	3.6989000E-01	1.8489000E-03	5.3621000E-03
1.0565000E+03	4.9619000E-03	3.6980000E-01	1.8349000E-03	5.3216000E-03
1.0566000E+03	4.9237000E-03	3.6970000E-01	1.8203000E-03	5.2793000E-03
1.0567000E+03	4.8833000E-03	3.6961000E-01	1.8049000E-03	5.2346000E-03
1.0568000E+03	4.8399000E-03	3.6951000E-01	1.7884000E-03	5.1867000E-03
1.0569000E+03	4.7929000E-03	3.6942000E-01	1.7706000E-03	5.1352000E-03
1.0570000E+03	4.7420000E-03	3.6933000E-01	1.7514000E-03	5.0793000E-03
1.0571000E+03	4.6866000E-03	3.6924000E-01	1.7305000E-03	5.0187000E-03
1.0572000E+03	4.6263000E-03	3.6914000E-01	1.7078000E-03	4.9529000E-03
1.0573000E+03	4.5610000E-03	3.6905000E-01	1.6832000E-03	4.8817000E-03
1.0574000E+03	4.4903000E-03	3.6896000E-01	1.6567000E-03	4.8048000E-03
1.0575000E+03	4.4141000E-03	3.6886000E-01	1.6282000E-03	4.7222000E-03
1.0576000E+03	4.3325000E-03	3.6877000E-01	1.5977000E-03	4.6336000E-03
1.0577000E+03	4.2453000E-03	3.6868000E-01	1.5652000E-03	4.5393000E-03
1.0578000E+03	4.1528000E-03	3.6859000E-01	1.5307000E-03	4.4392000E-03
1.0579000E+03	4.0551000E-03	3.6849000E-01	1.4943000E-03	4.3337000E-03
1.0580000E+03	3.9524000E-03	3.6840000E-01	1.4561000E-03	4.2230000E-03
1.0581000E+03	3.8452000E-03	3.6833000E-01	1.4163000E-03	4.1076000E-03
1.0582000E+03	3.7338000E-03	3.6825000E-01	1.3750000E-03	3.9877000E-03
1.0583000E+03	3.6188000E-03	3.6817000E-01	1.3323000E-03	3.8641000E-03
1.0584000E+03	3.5007000E-03	3.6810000E-01	1.2886000E-03	3.7372000E-03

1.0585000E+03	3.3802000E-03	3.6802000E-01	1.2440000E-03	3.6078000E-03
1.0586000E+03	3.2580000E-03	3.6794000E-01	1.1988000E-03	3.4767000E-03
1.0587000E+03	3.1350000E-03	3.6787000E-01	1.1533000E-03	3.3447000E-03
1.0588000E+03	3.0121000E-03	3.6779000E-01	1.1078000E-03	3.2129000E-03
1.0589000E+03	2.8902000E-03	3.6771000E-01	1.0628000E-03	3.0822000E-03
1.0590000E+03	2.7704000E-03	3.6764000E-01	1.0185000E-03	2.9538000E-03
1.0591000E+03	2.6537000E-03	3.6756000E-01	9.7538000E-04	2.8288000E-03
1.0592000E+03	2.5413000E-03	3.6748000E-01	9.3387000E-04	2.7084000E-03
1.0593000E+03	2.4343000E-03	3.6740000E-01	8.9437000E-04	2.5939000E-03
1.0594000E+03	2.3338000E-03	3.6733000E-01	8.5728000E-04	2.4863000E-03
1.0595000E+03	2.2409000E-03	3.6725000E-01	8.2298000E-04	2.3868000E-03
1.0596000E+03	2.1565000E-03	3.6717000E-01	7.9182000E-04	2.2965000E-03
1.0597000E+03	2.0814000E-03	3.6710000E-01	7.6408000E-04	2.2160000E-03
1.0598000E+03	2.0162000E-03	3.6702000E-01	7.3999000E-04	2.1461000E-03
1.0599000E+03	1.9612000E-03	3.6694000E-01	7.1965000E-04	2.0872000E-03
1.0600000E+03	1.9165000E-03	3.6685000E-01	7.0310000E-04	2.0391000E-03
1.0601000E+03	1.8820000E-03	3.6674000E-01	6.9021000E-04	2.0018000E-03
1.0602000E+03	1.8572000E-03	3.6662000E-01	6.8089000E-04	1.9747000E-03
1.0603000E+03	1.8414000E-03	3.6650000E-01	6.7487000E-04	1.9573000E-03
1.0604000E+03	1.8336000E-03	3.6638000E-01	6.7181000E-04	1.9484000E-03
1.0605000E+03	1.8328000E-03	3.6626000E-01	6.7128000E-04	1.9469000E-03
1.0606000E+03	0.0000000E+00	3.6614000E-01	0.0000000E+00	0.0000000E+00
Channel 10				
Wavenumber	HIRS Filter Transmittance	Optical Element Transmittance	Product of the HIRS Filter and Optical Element Transmittances	Normalized Value of Column 4
7.8212000E+02	0.0000000E+00	4.9409000E-01	0.0000000E+00	0.0000000E+00
7.8222000E+02	1.6347000E-03	4.9424000E-01	8.0794000E-04	2.0697000E-03
7.8232000E+02	1.9652000E-03	4.9438000E-01	9.7158000E-04	2.4889000E-03
7.8242000E+02	2.3616000E-03	4.9452000E-01	1.1679000E-03	2.9917000E-03
7.8252000E+02	2.8029000E-03	4.9466000E-01	1.3865000E-03	3.5518000E-03
7.8262000E+02	3.2645000E-03	4.9481000E-01	1.6153000E-03	4.1380000E-03
7.8272000E+02	3.7204000E-03	4.9495000E-01	1.8414000E-03	4.7172000E-03
7.8282000E+02	4.1453000E-03	4.9509000E-01	2.0523000E-03	5.2574000E-03
7.8292000E+02	4.5180000E-03	4.9524000E-01	2.2375000E-03	5.7319000E-03
7.8302000E+02	4.8230000E-03	4.9538000E-01	2.3892000E-03	6.1206000E-03
7.8312000E+02	5.0517000E-03	4.9552000E-01	2.5032000E-03	6.4125000E-03
7.8322000E+02	5.2031000E-03	4.9563000E-01	2.5788000E-03	6.6063000E-03
7.8332000E+02	5.2837000E-03	4.9575000E-01	2.6194000E-03	6.7101000E-03
7.8342000E+02	5.3067000E-03	4.9586000E-01	2.6313000E-03	6.7408000E-03
7.8352000E+02	5.2902000E-03	4.9597000E-01	2.6238000E-03	6.7214000E-03
7.8362000E+02	5.2555000E-03	4.9608000E-01	2.6071000E-03	6.6788000E-03

7.8372000E+02	5.2245000E-03	4.9619000E-01	2.5923000E-03	6.6409000E-03
7.8382000E+02	5.2178000E-03	4.9630000E-01	2.5896000E-03	6.6338000E-03
7.8392000E+02	5.2524000E-03	4.9641000E-01	2.6073000E-03	6.6793000E-03
7.8402000E+02	5.3404000E-03	4.9653000E-01	2.6517000E-03	6.7929000E-03
7.8412000E+02	5.4880000E-03	4.9668000E-01	2.7258000E-03	6.9828000E-03
7.8422000E+02	5.6950000E-03	4.9684000E-01	2.8295000E-03	7.2484000E-03
7.8432000E+02	5.9557000E-03	4.9699000E-01	2.9599000E-03	7.5825000E-03
7.8442000E+02	6.2594000E-03	4.9715000E-01	3.1118000E-03	7.9717000E-03
7.8452000E+02	6.5924000E-03	4.9730000E-01	3.2784000E-03	8.3985000E-03
7.8462000E+02	6.9398000E-03	4.9746000E-01	3.4522000E-03	8.8437000E-03
7.8472000E+02	7.2866000E-03	4.9761000E-01	3.6259000E-03	9.2886000E-03
7.8482000E+02	7.6201000E-03	4.9776000E-01	3.7930000E-03	9.7167000E-03
7.8492000E+02	7.9305000E-03	4.9792000E-01	3.9487000E-03	1.0116000E-02
7.8502000E+02	8.2120000E-03	4.9807000E-01	4.0902000E-03	1.0478000E-02
7.8512000E+02	8.4629000E-03	4.9821000E-01	4.2164000E-03	1.0801000E-02
7.8522000E+02	8.6858000E-03	4.9834000E-01	4.3284000E-03	1.1088000E-02
7.8532000E+02	8.8862000E-03	4.9846000E-01	4.4294000E-03	1.1347000E-02
7.8542000E+02	9.0727000E-03	4.9858000E-01	4.5234000E-03	1.1588000E-02
7.8552000E+02	9.2547000E-03	4.9870000E-01	4.6153000E-03	1.1823000E-02
7.8562000E+02	9.4421000E-03	4.9882000E-01	4.7100000E-03	1.2066000E-02
7.8572000E+02	9.6443000E-03	4.9895000E-01	4.8120000E-03	1.2327000E-02
7.8582000E+02	9.8687000E-03	4.9907000E-01	4.9252000E-03	1.2617000E-02
7.8592000E+02	1.0122000E-02	4.9919000E-01	5.0525000E-03	1.2943000E-02
7.8602000E+02	1.0406000E-02	4.9925000E-01	5.1953000E-03	1.3309000E-02
7.8612000E+02	1.0726000E-02	4.9905000E-01	5.3526000E-03	1.3712000E-02
7.8622000E+02	1.1080000E-02	4.9885000E-01	5.5273000E-03	1.4160000E-02
7.8632000E+02	1.1470000E-02	4.9866000E-01	5.7195000E-03	1.4652000E-02
7.8642000E+02	1.1895000E-02	4.9846000E-01	5.9292000E-03	1.5189000E-02
7.8652000E+02	1.2356000E-02	4.9826000E-01	6.1564000E-03	1.5771000E-02
7.8662000E+02	1.2853000E-02	4.9807000E-01	6.4015000E-03	1.6399000E-02
7.8672000E+02	1.3388000E-02	4.9787000E-01	6.6653000E-03	1.7075000E-02
7.8682000E+02	1.3963000E-02	4.9767000E-01	6.9489000E-03	1.7801000E-02
7.8692000E+02	1.4581000E-02	4.9748000E-01	7.2537000E-03	1.8582000E-02
7.8702000E+02	1.5245000E-02	4.9728000E-01	7.5811000E-03	1.9421000E-02
7.8712000E+02	1.5959000E-02	4.9705000E-01	7.9322000E-03	2.0320000E-02
7.8722000E+02	1.6724000E-02	4.9682000E-01	8.3085000E-03	2.1284000E-02
7.8732000E+02	1.7541000E-02	4.9658000E-01	8.7108000E-03	2.2315000E-02
7.8742000E+02	1.8413000E-02	4.9635000E-01	9.1393000E-03	2.3413000E-02
7.8752000E+02	1.9337000E-02	4.9612000E-01	9.5937000E-03	2.4577000E-02
7.8762000E+02	2.0313000E-02	4.9589000E-01	1.0073000E-02	2.5805000E-02
7.8772000E+02	2.1340000E-02	4.9566000E-01	1.0577000E-02	2.7096000E-02
7.8782000E+02	2.2414000E-02	4.9543000E-01	1.1105000E-02	2.8447000E-02
7.8792000E+02	2.3536000E-02	4.9520000E-01	1.1655000E-02	2.9857000E-02

7.8802000E+02	2.4703000E-02	4.9502000E-01	1.2228000E-02	3.1326000E-02
7.8812000E+02	2.5917000E-02	4.9502000E-01	1.2829000E-02	3.2866000E-02
7.8822000E+02	2.7178000E-02	4.9503000E-01	1.3454000E-02	3.4466000E-02
7.8832000E+02	2.8491000E-02	4.9504000E-01	1.4104000E-02	3.6131000E-02
7.8842000E+02	2.9858000E-02	4.9505000E-01	1.4781000E-02	3.7865000E-02
7.8852000E+02	3.1284000E-02	4.9505000E-01	1.5487000E-02	3.9675000E-02
7.8862000E+02	3.2777000E-02	4.9506000E-01	1.6227000E-02	4.1568000E-02
7.8872000E+02	3.4341000E-02	4.9507000E-01	1.7001000E-02	4.3553000E-02
7.8882000E+02	3.5985000E-02	4.9508000E-01	1.7815000E-02	4.5639000E-02
7.8892000E+02	3.7716000E-02	4.9508000E-01	1.8673000E-02	4.7834000E-02
7.8902000E+02	3.9541000E-02	4.9505000E-01	1.9575000E-02	5.0145000E-02
7.8912000E+02	4.1469000E-02	4.9500000E-01	2.0527000E-02	5.2585000E-02
7.8922000E+02	4.3507000E-02	4.9495000E-01	2.1534000E-02	5.5164000E-02
7.8932000E+02	4.5665000E-02	4.9490000E-01	2.2600000E-02	5.7895000E-02
7.8942000E+02	4.7953000E-02	4.9485000E-01	2.3730000E-02	6.0789000E-02
7.8952000E+02	5.0380000E-02	4.9481000E-01	2.4928000E-02	6.3860000E-02
7.8962000E+02	5.2164000E-02	4.9476000E-01	2.5808000E-02	6.6114000E-02
7.8972000E+02	5.4835000E-02	4.9471000E-01	2.7127000E-02	6.9494000E-02
7.8982000E+02	5.7679000E-02	4.9466000E-01	2.8531000E-02	7.3090000E-02
7.8992000E+02	6.0709000E-02	4.9461000E-01	3.0028000E-02	7.6923000E-02
7.9002000E+02	6.3943000E-02	4.9455000E-01	3.1623000E-02	8.1010000E-02
7.9012000E+02	6.7393000E-02	4.9443000E-01	3.3322000E-02	8.5361000E-02
7.9022000E+02	7.1074000E-02	4.9432000E-01	3.5133000E-02	9.0002000E-02
7.9032000E+02	7.4994000E-02	4.9420000E-01	3.7062000E-02	9.4944000E-02
7.9042000E+02	7.9163000E-02	4.9409000E-01	3.9114000E-02	1.0020000E-01
7.9052000E+02	8.3588000E-02	4.9397000E-01	4.1290000E-02	1.0577000E-01
7.9062000E+02	8.8275000E-02	4.9386000E-01	4.3595000E-02	1.1168000E-01
7.9072000E+02	9.3229000E-02	4.9374000E-01	4.6031000E-02	1.1792000E-01
7.9082000E+02	9.8459000E-02	4.9363000E-01	4.8602000E-02	1.2451000E-01
7.9092000E+02	1.0397000E-01	4.9350000E-01	5.1311000E-02	1.3145000E-01
7.9102000E+02	1.0979000E-01	4.9336000E-01	5.4165000E-02	1.3876000E-01
7.9112000E+02	1.1591000E-01	4.9322000E-01	5.7171000E-02	1.4646000E-01
7.9122000E+02	1.2237000E-01	4.9308000E-01	6.0341000E-02	1.5458000E-01
7.9132000E+02	1.2919000E-01	4.9294000E-01	6.3685000E-02	1.6314000E-01
7.9142000E+02	1.3640000E-01	4.9280000E-01	6.7216000E-02	1.7219000E-01
7.9152000E+02	1.4401000E-01	4.9266000E-01	7.0946000E-02	1.8174000E-01
7.9162000E+02	1.5205000E-01	4.9252000E-01	7.4886000E-02	1.9184000E-01
7.9172000E+02	1.6054000E-01	4.9238000E-01	7.9046000E-02	2.0249000E-01
7.9182000E+02	1.6950000E-01	4.9223000E-01	8.3432000E-02	2.1373000E-01
7.9192000E+02	1.7893000E-01	4.9209000E-01	8.8050000E-02	2.2556000E-01
7.9202000E+02	1.8884000E-01	4.9194000E-01	9.2897000E-02	2.3798000E-01
7.9212000E+02	1.9922000E-01	4.9175000E-01	9.7966000E-02	2.5096000E-01
7.9222000E+02	2.1006000E-01	4.9157000E-01	1.0326000E-01	2.6452000E-01

7.9232000E+02	2.2134000E-01	4.9138000E-01	1.0876000E-01	2.7862000E-01
7.9242000E+02	2.3305000E-01	4.9119000E-01	1.1447000E-01	2.9325000E-01
7.9252000E+02	2.4516000E-01	4.9101000E-01	1.2037000E-01	3.0837000E-01
7.9262000E+02	2.5766000E-01	4.9082000E-01	1.2646000E-01	3.2397000E-01
7.9272000E+02	2.7053000E-01	4.9063000E-01	1.3273000E-01	3.4002000E-01
7.9282000E+02	2.8375000E-01	4.9045000E-01	1.3917000E-01	3.5651000E-01
7.9292000E+02	2.9732000E-01	4.9028000E-01	1.4577000E-01	3.7342000E-01
7.9302000E+02	3.1122000E-01	4.9011000E-01	1.5253000E-01	3.9074000E-01
7.9312000E+02	3.2544000E-01	4.8994000E-01	1.5944000E-01	4.0846000E-01
7.9322000E+02	3.3997000E-01	4.8977000E-01	1.6651000E-01	4.2655000E-01
7.9332000E+02	3.5480000E-01	4.8959000E-01	1.7371000E-01	4.4499000E-01
7.9342000E+02	3.6989000E-01	4.8942000E-01	1.8103000E-01	4.6376000E-01
7.9352000E+02	3.8523000E-01	4.8925000E-01	1.8847000E-01	4.8282000E-01
7.9362000E+02	4.0076000E-01	4.8907000E-01	1.9600000E-01	5.0211000E-01
7.9372000E+02	4.1644000E-01	4.8890000E-01	2.0360000E-01	5.2157000E-01
7.9382000E+02	4.3222000E-01	4.8873000E-01	2.1123000E-01	5.4113000E-01
7.9392000E+02	4.4801000E-01	4.8855000E-01	2.1887000E-01	5.6070000E-01
7.9402000E+02	4.6375000E-01	4.8839000E-01	2.2649000E-01	5.8021000E-01
7.9412000E+02	4.7938000E-01	4.8827000E-01	2.3407000E-01	5.9962000E-01
7.9422000E+02	4.9482000E-01	4.8815000E-01	2.4155000E-01	6.1878000E-01
7.9432000E+02	5.1001000E-01	4.8804000E-01	2.4890000E-01	6.3763000E-01
7.9442000E+02	5.2491000E-01	4.8792000E-01	2.5611000E-01	6.5610000E-01
7.9452000E+02	5.3947000E-01	4.8780000E-01	2.6315000E-01	6.7413000E-01
7.9462000E+02	5.5366000E-01	4.8768000E-01	2.7001000E-01	6.9170000E-01
7.9472000E+02	5.6748000E-01	4.8757000E-01	2.7668000E-01	7.0879000E-01
7.9482000E+02	5.8091000E-01	4.8747000E-01	2.8317000E-01	7.2542000E-01
7.9492000E+02	5.9395000E-01	4.8737000E-01	2.8947000E-01	7.4156000E-01
7.9502000E+02	6.0662000E-01	4.8727000E-01	2.9559000E-01	7.5723000E-01
7.9512000E+02	6.1892000E-01	4.8718000E-01	3.0152000E-01	7.7242000E-01
7.9522000E+02	6.3085000E-01	4.8708000E-01	3.0727000E-01	7.8715000E-01
7.9532000E+02	6.4241000E-01	4.8698000E-01	3.1284000E-01	8.0142000E-01
7.9542000E+02	6.5360000E-01	4.8688000E-01	3.1822000E-01	8.1521000E-01
7.9552000E+02	6.6439000E-01	4.8678000E-01	3.2341000E-01	8.2850000E-01
7.9562000E+02	6.7476000E-01	4.8668000E-01	3.2840000E-01	8.4127000E-01
7.9572000E+02	6.8469000E-01	4.8658000E-01	3.3316000E-01	8.5347000E-01
7.9582000E+02	6.9413000E-01	4.8649000E-01	3.3769000E-01	8.6507000E-01
7.9592000E+02	7.0306000E-01	4.8639000E-01	3.4196000E-01	8.7602000E-01
7.9602000E+02	7.1145000E-01	4.8628000E-01	3.4596000E-01	8.8627000E-01
7.9612000E+02	7.1926000E-01	4.8616000E-01	3.4968000E-01	8.9578000E-01
7.9622000E+02	7.2650000E-01	4.8603000E-01	3.5310000E-01	9.0456000E-01
7.9632000E+02	7.3316000E-01	4.8590000E-01	3.5625000E-01	9.1261000E-01
7.9642000E+02	7.3925000E-01	4.8578000E-01	3.5911000E-01	9.1995000E-01
7.9652000E+02	7.4480000E-01	4.8565000E-01	3.6171000E-01	9.2661000E-01

7.9662000E+02	7.4984000E-01	4.8552000E-01	3.6406000E-01	9.3264000E-01
7.9672000E+02	7.5441000E-01	4.8541000E-01	3.6620000E-01	9.3811000E-01
7.9682000E+02	7.5856000E-01	4.8530000E-01	3.6813000E-01	9.4306000E-01
7.9692000E+02	7.6234000E-01	4.8520000E-01	3.6989000E-01	9.4755000E-01
7.9702000E+02	7.6580000E-01	4.8509000E-01	3.7148000E-01	9.5164000E-01
7.9712000E+02	7.6898000E-01	4.8497000E-01	3.7293000E-01	9.5536000E-01
7.9722000E+02	7.7191000E-01	4.8486000E-01	3.7427000E-01	9.5878000E-01
7.9732000E+02	7.7464000E-01	4.8474000E-01	3.7550000E-01	9.6194000E-01
7.9742000E+02	7.7718000E-01	4.8463000E-01	3.7664000E-01	9.6486000E-01
7.9752000E+02	7.7956000E-01	4.8451000E-01	3.7771000E-01	9.6758000E-01
7.9762000E+02	7.8179000E-01	4.8439000E-01	3.7870000E-01	9.7012000E-01
7.9772000E+02	7.8390000E-01	4.8428000E-01	3.7962000E-01	9.7250000E-01
7.9782000E+02	7.8588000E-01	4.8416000E-01	3.8049000E-01	9.7472000E-01
7.9792000E+02	7.8775000E-01	4.8404000E-01	3.8130000E-01	9.7680000E-01
7.9802000E+02	7.8953000E-01	4.8395000E-01	3.8209000E-01	9.7881000E-01
7.9812000E+02	7.9123000E-01	4.8393000E-01	3.8290000E-01	9.8088000E-01
7.9822000E+02	7.9286000E-01	4.8391000E-01	3.8367000E-01	9.8286000E-01
7.9832000E+02	7.9443000E-01	4.8389000E-01	3.8442000E-01	9.8477000E-01
7.9842000E+02	7.9595000E-01	4.8387000E-01	3.8514000E-01	9.8662000E-01
7.9852000E+02	7.9742000E-01	4.8385000E-01	3.8583000E-01	9.8840000E-01
7.9862000E+02	7.9884000E-01	4.8383000E-01	3.8651000E-01	9.9013000E-01
7.9872000E+02	8.0020000E-01	4.8383000E-01	3.8716000E-01	9.9181000E-01
7.9882000E+02	8.0149000E-01	4.8382000E-01	3.8778000E-01	9.9339000E-01
7.9892000E+02	8.0267000E-01	4.8382000E-01	3.8835000E-01	9.9485000E-01
7.9902000E+02	8.0374000E-01	4.8381000E-01	3.8886000E-01	9.9616000E-01
7.9912000E+02	8.0467000E-01	4.8380000E-01	3.8930000E-01	9.9729000E-01
7.9922000E+02	8.0545000E-01	4.8379000E-01	3.8967000E-01	9.9823000E-01
7.9932000E+02	8.0606000E-01	4.8378000E-01	3.8996000E-01	9.9897000E-01
7.9942000E+02	8.0650000E-01	4.8377000E-01	3.9016000E-01	9.9950000E-01
7.9952000E+02	8.0679000E-01	4.8376000E-01	3.9029000E-01	9.9983000E-01
7.9962000E+02	8.0693000E-01	4.8375000E-01	3.9035000E-01	9.9999000E-01
7.9972000E+02	8.0696000E-01	4.8374000E-01	3.9036000E-01	1.0000000E+00
7.9982000E+02	8.0690000E-01	4.8373000E-01	3.9032000E-01	9.9990000E-01
7.9992000E+02	8.0677000E-01	4.8372000E-01	3.9025000E-01	9.9973000E-01
8.0002000E+02	8.0662000E-01	4.8366000E-01	3.9013000E-01	9.9942000E-01
8.0012000E+02	8.0646000E-01	4.8342000E-01	3.8986000E-01	9.9872000E-01
8.0022000E+02	8.0630000E-01	4.8317000E-01	3.8958000E-01	9.9801000E-01
8.0032000E+02	8.0614000E-01	4.8293000E-01	3.8931000E-01	9.9731000E-01
8.0042000E+02	8.0597000E-01	4.8268000E-01	3.8903000E-01	9.9659000E-01
8.0052000E+02	8.0577000E-01	4.8244000E-01	3.8873000E-01	9.9584000E-01
8.0062000E+02	8.0550000E-01	4.8220000E-01	3.8841000E-01	9.9500000E-01
8.0072000E+02	8.0513000E-01	4.8195000E-01	3.8804000E-01	9.9405000E-01
8.0082000E+02	8.0462000E-01	4.8171000E-01	3.8760000E-01	9.9292000E-01

8.0092000E+02	8.0395000E-01	4.8147000E-01	3.8708000E-01	9.9159000E-01
8.0102000E+02	8.0309000E-01	4.8123000E-01	3.8647000E-01	9.9003000E-01
8.0112000E+02	8.0203000E-01	4.8098000E-01	3.8577000E-01	9.8823000E-01
8.0122000E+02	8.0080000E-01	4.8074000E-01	3.8497000E-01	9.8621000E-01
8.0132000E+02	7.9940000E-01	4.8049000E-01	3.8411000E-01	9.8399000E-01
8.0142000E+02	7.9789000E-01	4.8025000E-01	3.8319000E-01	9.8162000E-01
8.0152000E+02	7.9630000E-01	4.8001000E-01	3.8223000E-01	9.7917000E-01
8.0162000E+02	7.9469000E-01	4.7976000E-01	3.8126000E-01	9.7670000E-01
8.0172000E+02	7.9312000E-01	4.7952000E-01	3.8032000E-01	9.7427000E-01
8.0182000E+02	7.9161000E-01	4.7928000E-01	3.7940000E-01	9.7193000E-01
8.0192000E+02	7.9022000E-01	4.7904000E-01	3.7854000E-01	9.6973000E-01
8.0202000E+02	7.8894000E-01	4.7882000E-01	3.7776000E-01	9.6772000E-01
8.0212000E+02	7.8777000E-01	4.7871000E-01	3.7712000E-01	9.6607000E-01
8.0222000E+02	7.8670000E-01	4.7860000E-01	3.7652000E-01	9.6454000E-01
8.0232000E+02	7.8570000E-01	4.7850000E-01	3.7595000E-01	9.6310000E-01
8.0242000E+02	7.8471000E-01	4.7839000E-01	3.7540000E-01	9.6167000E-01
8.0252000E+02	7.8371000E-01	4.7826000E-01	3.7482000E-01	9.6019000E-01
8.0262000E+02	7.8266000E-01	4.7813000E-01	3.7421000E-01	9.5863000E-01
8.0272000E+02	7.8153000E-01	4.7799000E-01	3.7356000E-01	9.5697000E-01
8.0282000E+02	7.8030000E-01	4.7786000E-01	3.7288000E-01	9.5521000E-01
8.0292000E+02	7.7901000E-01	4.7773000E-01	3.7215000E-01	9.5336000E-01
8.0302000E+02	7.7767000E-01	4.7759000E-01	3.7141000E-01	9.5145000E-01
8.0312000E+02	7.7634000E-01	4.7745000E-01	3.7067000E-01	9.4955000E-01
8.0322000E+02	7.7507000E-01	4.7732000E-01	3.6996000E-01	9.4773000E-01
8.0332000E+02	7.7394000E-01	4.7718000E-01	3.6931000E-01	9.4607000E-01
8.0342000E+02	7.7300000E-01	4.7704000E-01	3.6875000E-01	9.4465000E-01
8.0352000E+02	7.7231000E-01	4.7691000E-01	3.6832000E-01	9.4354000E-01
8.0362000E+02	7.7191000E-01	4.7677000E-01	3.6802000E-01	9.4278000E-01
8.0372000E+02	7.7181000E-01	4.7663000E-01	3.6787000E-01	9.4239000E-01
8.0382000E+02	7.7200000E-01	4.7650000E-01	3.6786000E-01	9.4236000E-01
8.0392000E+02	7.7245000E-01	4.7636000E-01	3.6797000E-01	9.4263000E-01
8.0402000E+02	7.7310000E-01	4.7622000E-01	3.6817000E-01	9.4315000E-01
8.0412000E+02	7.7388000E-01	4.7608000E-01	3.6843000E-01	9.4382000E-01
8.0422000E+02	7.7471000E-01	4.7593000E-01	3.6871000E-01	9.4454000E-01
8.0432000E+02	7.7551000E-01	4.7579000E-01	3.6898000E-01	9.4523000E-01
8.0442000E+02	7.7620000E-01	4.7564000E-01	3.6919000E-01	9.4577000E-01
8.0452000E+02	7.7672000E-01	4.7548000E-01	3.6932000E-01	9.4610000E-01
8.0462000E+02	7.7702000E-01	4.7533000E-01	3.6934000E-01	9.4616000E-01
8.0472000E+02	7.7709000E-01	4.7518000E-01	3.6925000E-01	9.4593000E-01
8.0482000E+02	7.7690000E-01	4.7502000E-01	3.6904000E-01	9.4539000E-01
8.0492000E+02	7.7646000E-01	4.7487000E-01	3.6872000E-01	9.4456000E-01
8.0502000E+02	7.7579000E-01	4.7471000E-01	3.6828000E-01	9.4343000E-01
8.0512000E+02	7.7488000E-01	4.7456000E-01	3.6773000E-01	9.4203000E-01

8.0522000E+02	7.7376000E-01	4.7441000E-01	3.6708000E-01	9.4036000E-01
8.0532000E+02	7.7241000E-01	4.7425000E-01	3.6632000E-01	9.3841000E-01
8.0542000E+02	7.7079000E-01	4.7410000E-01	3.6543000E-01	9.3614000E-01
8.0552000E+02	7.6887000E-01	4.7395000E-01	3.6440000E-01	9.3351000E-01
8.0562000E+02	7.6658000E-01	4.7379000E-01	3.6320000E-01	9.3042000E-01
8.0572000E+02	7.6383000E-01	4.7364000E-01	3.6178000E-01	9.2679000E-01
8.0582000E+02	7.6053000E-01	4.7349000E-01	3.6010000E-01	9.2249000E-01
8.0592000E+02	7.5659000E-01	4.7334000E-01	3.5812000E-01	9.1741000E-01
8.0602000E+02	7.5190000E-01	4.7318000E-01	3.5578000E-01	9.1141000E-01
8.0612000E+02	7.4639000E-01	4.7299000E-01	3.5303000E-01	9.0437000E-01
8.0622000E+02	7.3999000E-01	4.7280000E-01	3.4986000E-01	8.9626000E-01
8.0632000E+02	7.3266000E-01	4.7261000E-01	3.4626000E-01	8.8704000E-01
8.0642000E+02	7.2438000E-01	4.7243000E-01	3.4222000E-01	8.7668000E-01
8.0652000E+02	7.1515000E-01	4.7226000E-01	3.3773000E-01	8.6519000E-01
8.0662000E+02	7.0500000E-01	4.7208000E-01	3.3281000E-01	8.5258000E-01
8.0672000E+02	6.9396000E-01	4.7190000E-01	3.2748000E-01	8.3892000E-01
8.0682000E+02	6.8209000E-01	4.7172000E-01	3.2176000E-01	8.2426000E-01
8.0692000E+02	6.6944000E-01	4.7154000E-01	3.1567000E-01	8.0866000E-01
8.0702000E+02	6.5605000E-01	4.7137000E-01	3.0924000E-01	7.9220000E-01
8.0712000E+02	6.4198000E-01	4.7120000E-01	3.0250000E-01	7.7492000E-01
8.0722000E+02	6.2726000E-01	4.7103000E-01	2.9546000E-01	7.5688000E-01
8.0732000E+02	6.1193000E-01	4.7086000E-01	2.8813000E-01	7.3812000E-01
8.0742000E+02	5.9603000E-01	4.7068000E-01	2.8054000E-01	7.1867000E-01
8.0752000E+02	5.7959000E-01	4.7051000E-01	2.7270000E-01	6.9859000E-01
8.0762000E+02	5.6264000E-01	4.7034000E-01	2.6463000E-01	6.7792000E-01
8.0772000E+02	5.4524000E-01	4.7017000E-01	2.5636000E-01	6.5672000E-01
8.0782000E+02	5.2745000E-01	4.7000000E-01	2.4790000E-01	6.3506000E-01
8.0792000E+02	5.0935000E-01	4.6983000E-01	2.3931000E-01	6.1304000E-01
8.0802000E+02	4.9101000E-01	4.6966000E-01	2.3061000E-01	5.9077000E-01
8.0812000E+02	4.7255000E-01	4.6952000E-01	2.2188000E-01	5.6839000E-01
8.0822000E+02	4.5407000E-01	4.6938000E-01	2.1313000E-01	5.4600000E-01
8.0832000E+02	4.3568000E-01	4.6925000E-01	2.0444000E-01	5.2373000E-01
8.0842000E+02	4.1747000E-01	4.6912000E-01	1.9584000E-01	5.0170000E-01
8.0852000E+02	3.9954000E-01	4.6898000E-01	1.8738000E-01	4.8001000E-01
8.0862000E+02	3.8196000E-01	4.6885000E-01	1.7908000E-01	4.5876000E-01
8.0872000E+02	3.6478000E-01	4.6872000E-01	1.7098000E-01	4.3800000E-01
8.0882000E+02	3.4803000E-01	4.6858000E-01	1.6308000E-01	4.1777000E-01
8.0892000E+02	3.3173000E-01	4.6845000E-01	1.5540000E-01	3.9809000E-01
8.0902000E+02	3.1586000E-01	4.6832000E-01	1.4792000E-01	3.7894000E-01
8.0912000E+02	3.0042000E-01	4.6819000E-01	1.4065000E-01	3.6032000E-01
8.0922000E+02	2.8539000E-01	4.6806000E-01	1.3358000E-01	3.4220000E-01
8.0932000E+02	2.7074000E-01	4.6793000E-01	1.2669000E-01	3.2454000E-01
8.0942000E+02	2.5648000E-01	4.6780000E-01	1.1998000E-01	3.0736000E-01

8.0952000E+02	2.4259000E-01	4.6768000E-01	1.1345000E-01	2.9064000E-01
8.0962000E+02	2.2910000E-01	4.6755000E-01	1.0712000E-01	2.7440000E-01
8.0972000E+02	2.1604000E-01	4.6742000E-01	1.0098000E-01	2.5869000E-01
8.0982000E+02	2.0346000E-01	4.6729000E-01	9.5073000E-02	2.4355000E-01
8.0992000E+02	1.9139000E-01	4.6717000E-01	8.9409000E-02	2.2904000E-01
8.1002000E+02	1.7988000E-01	4.6703000E-01	8.4010000E-02	2.1521000E-01
8.1012000E+02	1.6899000E-01	4.6683000E-01	7.8889000E-02	2.0209000E-01
8.1022000E+02	1.5874000E-01	4.6665000E-01	7.4074000E-02	1.8976000E-01
8.1032000E+02	1.4914000E-01	4.6647000E-01	6.9568000E-02	1.7822000E-01
8.1042000E+02	1.4020000E-01	4.6628000E-01	6.5373000E-02	1.6747000E-01
8.1052000E+02	1.3189000E-01	4.6610000E-01	6.1476000E-02	1.5749000E-01
8.1062000E+02	1.2419000E-01	4.6592000E-01	5.7861000E-02	1.4823000E-01
8.1072000E+02	1.1703000E-01	4.6574000E-01	5.4505000E-02	1.3963000E-01
8.1082000E+02	1.1036000E-01	4.6556000E-01	5.1380000E-02	1.3162000E-01
8.1092000E+02	1.0413000E-01	4.6538000E-01	4.8458000E-02	1.2414000E-01
8.1102000E+02	9.8267000E-02	4.6520000E-01	4.5714000E-02	1.1711000E-01
8.1112000E+02	9.2735000E-02	4.6502000E-01	4.3124000E-02	1.1047000E-01
8.1122000E+02	8.7494000E-02	4.6484000E-01	4.0671000E-02	1.0419000E-01
8.1132000E+02	8.2518000E-02	4.6466000E-01	3.8343000E-02	9.8225000E-02
8.1142000E+02	7.7794000E-02	4.6449000E-01	3.6134000E-02	9.2567000E-02
8.1152000E+02	7.3320000E-02	4.6431000E-01	3.4043000E-02	8.7209000E-02
8.1162000E+02	6.9096000E-02	4.6413000E-01	3.2069000E-02	8.2154000E-02
8.1172000E+02	6.5127000E-02	4.6395000E-01	3.0216000E-02	7.7405000E-02
8.1182000E+02	6.1416000E-02	4.6377000E-01	2.8483000E-02	7.2967000E-02
8.1192000E+02	5.7960000E-02	4.6359000E-01	2.6870000E-02	6.8834000E-02
8.1202000E+02	5.4750000E-02	4.6345000E-01	2.5374000E-02	6.5001000E-02
8.1212000E+02	5.1769000E-02	4.6343000E-01	2.3991000E-02	6.1460000E-02
8.1222000E+02	4.8996000E-02	4.6342000E-01	2.2706000E-02	5.8166000E-02
8.1232000E+02	4.6404000E-02	4.6341000E-01	2.1504000E-02	5.5088000E-02
8.1242000E+02	4.3968000E-02	4.6340000E-01	2.0374000E-02	5.2194000E-02
8.1252000E+02	4.1663000E-02	4.6339000E-01	1.9306000E-02	4.9458000E-02
8.1262000E+02	3.9474000E-02	4.6338000E-01	1.8292000E-02	4.6858000E-02
8.1272000E+02	3.7391000E-02	4.6336000E-01	1.7326000E-02	4.4384000E-02
8.1282000E+02	3.5413000E-02	4.6335000E-01	1.6409000E-02	4.2035000E-02
8.1292000E+02	3.3545000E-02	4.6334000E-01	1.5543000E-02	3.9817000E-02
8.1302000E+02	3.1799000E-02	4.6333000E-01	1.4734000E-02	3.7744000E-02
8.1312000E+02	3.0188000E-02	4.6333000E-01	1.3987000E-02	3.5831000E-02
8.1322000E+02	2.8720000E-02	4.6332000E-01	1.3307000E-02	3.4089000E-02
8.1332000E+02	2.7401000E-02	4.6332000E-01	1.2696000E-02	3.2523000E-02
8.1342000E+02	2.6225000E-02	4.6332000E-01	1.2150000E-02	3.1126000E-02
8.1352000E+02	2.5175000E-02	4.6331000E-01	1.1664000E-02	2.9880000E-02
8.1362000E+02	2.4224000E-02	4.6331000E-01	1.1223000E-02	2.8751000E-02
8.1372000E+02	2.3337000E-02	4.6330000E-01	1.0812000E-02	2.7698000E-02

8.1382000E+02	2.2474000E-02	4.6330000E-01	1.0412000E-02	2.6674000E-02
8.1392000E+02	2.1594000E-02	4.6330000E-01	1.0004000E-02	2.5629000E-02
8.1402000E+02	2.0662000E-02	4.6328000E-01	9.5725000E-03	2.4522000E-02
8.1412000E+02	1.9655000E-02	4.6321000E-01	9.1043000E-03	2.3323000E-02
8.1422000E+02	1.8562000E-02	4.6314000E-01	8.5967000E-03	2.2023000E-02
8.1432000E+02	1.7390000E-02	4.6307000E-01	8.0530000E-03	2.0630000E-02
8.1442000E+02	1.6164000E-02	4.6301000E-01	7.4841000E-03	1.9172000E-02
8.1452000E+02	1.4922000E-02	4.6294000E-01	6.9082000E-03	1.7697000E-02
8.1462000E+02	1.3714000E-02	4.6287000E-01	6.3478000E-03	1.6261000E-02
8.1472000E+02	1.2591000E-02	4.6280000E-01	5.8274000E-03	1.4928000E-02
8.1482000E+02	1.1606000E-02	4.6274000E-01	5.3704000E-03	1.3758000E-02
8.1492000E+02	1.0797000E-02	4.6267000E-01	4.9954000E-03	1.2797000E-02
8.1502000E+02	1.0190000E-02	4.6260000E-01	4.7140000E-03	1.2076000E-02
8.1512000E+02	1.0612000E-02	4.6254000E-01	4.9084000E-03	1.2574000E-02
8.1522000E+02	1.0244000E-02	4.6247000E-01	4.7376000E-03	1.2136000E-02
8.1532000E+02	9.9618000E-03	4.6241000E-01	4.6064000E-03	1.1800000E-02
8.1542000E+02	9.7375000E-03	4.6235000E-01	4.5021000E-03	1.1533000E-02
8.1552000E+02	9.5392000E-03	4.6228000E-01	4.4098000E-03	1.1297000E-02
8.1562000E+02	9.3340000E-03	4.6222000E-01	4.3143000E-03	1.1052000E-02
8.1572000E+02	9.0921000E-03	4.6215000E-01	4.2020000E-03	1.0764000E-02
8.1582000E+02	8.7906000E-03	4.6209000E-01	4.0621000E-03	1.0406000E-02
8.1592000E+02	8.4157000E-03	4.6202000E-01	3.8883000E-03	9.9607000E-03
8.1602000E+02	7.9648000E-03	4.6198000E-01	3.6796000E-03	9.4262000E-03
8.1612000E+02	7.4467000E-03	4.6202000E-01	3.4406000E-03	8.8139000E-03
8.1622000E+02	6.8808000E-03	4.6206000E-01	3.1794000E-03	8.1447000E-03
8.1632000E+02	6.2944000E-03	4.6210000E-01	2.9087000E-03	7.4512000E-03
8.1642000E+02	5.7198000E-03	4.6214000E-01	2.6433000E-03	6.7716000E-03
8.1652000E+02	5.1902000E-03	4.6218000E-01	2.3988000E-03	6.1451000E-03
8.1662000E+02	4.7359000E-03	4.6222000E-01	2.1890000E-03	5.6077000E-03
8.1672000E+02	4.3808000E-03	4.6225000E-01	2.0250000E-03	5.1876000E-03
8.1682000E+02	4.1392000E-03	4.6229000E-01	1.9135000E-03	4.9020000E-03
8.1692000E+02	4.0148000E-03	4.6233000E-01	1.8562000E-03	4.7550000E-03
8.1702000E+02	3.9997000E-03	4.6236000E-01	1.8493000E-03	4.7375000E-03
8.1712000E+02	4.0757000E-03	4.6240000E-01	1.8846000E-03	4.8278000E-03
8.1722000E+02	0.0000000E+00	4.6244000E-01	0.0000000E+00	0.0000000E+00
Channel 11				
Wavenumber	HIRS Filter Transmittance	Optical Element Transmittance	Product of the HIRS Filter and Optical Element Transmittances	Normalized Value of Column 4
1.3268000E+03	0.0000000E+00	3.0024000E-01	0.0000000E+00	0.0000000E+00
1.3269000E+03	1.9651000E-03	3.0037000E-01	5.9025000E-04	2.5187000E-03
1.3270000E+03	1.9665000E-03	3.0051000E-01	5.9094000E-04	2.5216000E-03

1.3271000E+03	1.9815000E-03	3.0064000E-01	5.9572000E-04	2.5421000E-03
1.3272000E+03	2.0101000E-03	3.0077000E-01	6.0456000E-04	2.5798000E-03
1.3273000E+03	2.0520000E-03	3.0089000E-01	6.1742000E-04	2.6347000E-03
1.3274000E+03	2.1069000E-03	3.0101000E-01	6.3419000E-04	2.7062000E-03
1.3275000E+03	2.1741000E-03	3.0114000E-01	6.5469000E-04	2.7937000E-03
1.3276000E+03	2.2529000E-03	3.0126000E-01	6.7870000E-04	2.8961000E-03
1.3277000E+03	2.3424000E-03	3.0138000E-01	7.0596000E-04	3.0125000E-03
1.3278000E+03	2.4416000E-03	3.0150000E-01	7.3616000E-04	3.1413000E-03
1.3279000E+03	2.5494000E-03	3.0163000E-01	7.6897000E-04	3.2813000E-03
1.3280000E+03	2.6645000E-03	3.0175000E-01	8.0401000E-04	3.4309000E-03
1.3281000E+03	2.7856000E-03	3.0183000E-01	8.4077000E-04	3.5877000E-03
1.3282000E+03	2.9114000E-03	3.0190000E-01	8.7896000E-04	3.7507000E-03
1.3283000E+03	3.0406000E-03	3.0198000E-01	9.1819000E-04	3.9181000E-03
1.3284000E+03	3.1718000E-03	3.0205000E-01	9.5805000E-04	4.0882000E-03
1.3285000E+03	3.3038000E-03	3.0213000E-01	9.9817000E-04	4.2594000E-03
1.3286000E+03	3.4354000E-03	3.0220000E-01	1.0382000E-03	4.4301000E-03
1.3287000E+03	3.5655000E-03	3.0228000E-01	1.0778000E-03	4.5991000E-03
1.3288000E+03	3.6932000E-03	3.0235000E-01	1.1166000E-03	4.7650000E-03
1.3289000E+03	3.8176000E-03	3.0243000E-01	1.1546000E-03	4.9267000E-03
1.3290000E+03	3.9381000E-03	3.0250000E-01	1.1913000E-03	5.0835000E-03
1.3291000E+03	4.0541000E-03	3.0258000E-01	1.2267000E-03	5.2345000E-03
1.3292000E+03	4.1652000E-03	3.0265000E-01	1.2606000E-03	5.3792000E-03
1.3293000E+03	4.2712000E-03	3.0272000E-01	1.2930000E-03	5.5175000E-03
1.3294000E+03	4.3721000E-03	3.0279000E-01	1.3238000E-03	5.6491000E-03
1.3295000E+03	4.4678000E-03	3.0287000E-01	1.3532000E-03	5.7742000E-03
1.3296000E+03	4.5587000E-03	3.0294000E-01	1.3810000E-03	5.8930000E-03
1.3297000E+03	4.6451000E-03	3.0301000E-01	1.4075000E-03	6.0060000E-03
1.3298000E+03	4.7274000E-03	3.0308000E-01	1.4328000E-03	6.1139000E-03
1.3299000E+03	4.8062000E-03	3.0315000E-01	1.4570000E-03	6.2174000E-03
1.3300000E+03	4.8824000E-03	3.0322000E-01	1.4805000E-03	6.3174000E-03
1.3301000E+03	4.9568000E-03	3.0333000E-01	1.5036000E-03	6.4160000E-03
1.3302000E+03	5.0303000E-03	3.0344000E-01	1.5264000E-03	6.5134000E-03
1.3303000E+03	5.1041000E-03	3.0354000E-01	1.5493000E-03	6.6112000E-03
1.3304000E+03	5.1791000E-03	3.0365000E-01	1.5726000E-03	6.7107000E-03
1.3305000E+03	5.2566000E-03	3.0376000E-01	1.5967000E-03	6.8136000E-03
1.3306000E+03	5.3379000E-03	3.0386000E-01	1.6220000E-03	6.9213000E-03
1.3307000E+03	5.4241000E-03	3.0397000E-01	1.6488000E-03	7.0356000E-03
1.3308000E+03	5.5166000E-03	3.0408000E-01	1.6775000E-03	7.1582000E-03
1.3309000E+03	5.6166000E-03	3.0418000E-01	1.7085000E-03	7.2905000E-03
1.3310000E+03	5.7254000E-03	3.0428000E-01	1.7421000E-03	7.4340000E-03
1.3311000E+03	5.8439000E-03	3.0437000E-01	1.7787000E-03	7.5902000E-03
1.3312000E+03	5.9734000E-03	3.0446000E-01	1.8187000E-03	7.7606000E-03
1.3313000E+03	6.1149000E-03	3.0455000E-01	1.8623000E-03	7.9467000E-03

1.3314000E+03	6.2692000E-03	3.0463000E-01	1.9098000E-03	8.1495000E-03
1.3315000E+03	6.4370000E-03	3.0472000E-01	1.9615000E-03	8.3701000E-03
1.3316000E+03	6.6190000E-03	3.0481000E-01	2.0175000E-03	8.6092000E-03
1.3317000E+03	6.8156000E-03	3.0489000E-01	2.0780000E-03	8.8674000E-03
1.3318000E+03	7.0270000E-03	3.0498000E-01	2.1431000E-03	9.1451000E-03
1.3319000E+03	7.2534000E-03	3.0507000E-01	2.2128000E-03	9.4424000E-03
1.3320000E+03	7.4945000E-03	3.0516000E-01	2.2870000E-03	9.7590000E-03
1.3321000E+03	7.7499000E-03	3.0520000E-01	2.3652000E-03	1.0093000E-02
1.3322000E+03	8.0193000E-03	3.0523000E-01	2.4477000E-03	1.0445000E-02
1.3323000E+03	8.3016000E-03	3.0527000E-01	2.5343000E-03	1.0814000E-02
1.3324000E+03	8.5961000E-03	3.0531000E-01	2.6245000E-03	1.1199000E-02
1.3325000E+03	8.9015000E-03	3.0535000E-01	2.7181000E-03	1.1599000E-02
1.3326000E+03	9.2165000E-03	3.0539000E-01	2.8146000E-03	1.2010000E-02
1.3327000E+03	9.5396000E-03	3.0543000E-01	2.9137000E-03	1.2433000E-02
1.3328000E+03	9.8694000E-03	3.0547000E-01	3.0148000E-03	1.2865000E-02
1.3329000E+03	1.0204000E-02	3.0551000E-01	3.1174000E-03	1.3303000E-02
1.3330000E+03	1.0542000E-02	3.0552000E-01	3.2210000E-03	1.3744000E-02
1.3331000E+03	1.0883000E-02	3.0553000E-01	3.3250000E-03	1.4189000E-02
1.3332000E+03	1.1223000E-02	3.0555000E-01	3.4293000E-03	1.4633000E-02
1.3333000E+03	1.1563000E-02	3.0556000E-01	3.5333000E-03	1.5077000E-02
1.3334000E+03	1.1901000E-02	3.0557000E-01	3.6367000E-03	1.5518000E-02
1.3335000E+03	1.2237000E-02	3.0559000E-01	3.7393000E-03	1.5956000E-02
1.3336000E+03	1.2569000E-02	3.0560000E-01	3.8410000E-03	1.6390000E-02
1.3337000E+03	1.2898000E-02	3.0561000E-01	3.9417000E-03	1.6820000E-02
1.3338000E+03	1.3224000E-02	3.0562000E-01	4.0415000E-03	1.7246000E-02
1.3339000E+03	1.3547000E-02	3.0564000E-01	4.1406000E-03	1.7669000E-02
1.3340000E+03	1.3870000E-02	3.0565000E-01	4.2393000E-03	1.8090000E-02
1.3341000E+03	1.4193000E-02	3.0564000E-01	4.3380000E-03	1.8511000E-02
1.3342000E+03	1.4518000E-02	3.0564000E-01	4.4374000E-03	1.8935000E-02
1.3343000E+03	1.4849000E-02	3.0563000E-01	4.5383000E-03	1.9366000E-02
1.3344000E+03	1.5187000E-02	3.0562000E-01	4.6416000E-03	1.9807000E-02
1.3345000E+03	1.5537000E-02	3.0562000E-01	4.7483000E-03	2.0262000E-02
1.3346000E+03	1.5901000E-02	3.0561000E-01	4.8596000E-03	2.0737000E-02
1.3347000E+03	1.6284000E-02	3.0561000E-01	4.9766000E-03	2.1236000E-02
1.3348000E+03	1.6690000E-02	3.0560000E-01	5.1006000E-03	2.1765000E-02
1.3349000E+03	1.7124000E-02	3.0560000E-01	5.2329000E-03	2.2330000E-02
1.3350000E+03	1.7588000E-02	3.0559000E-01	5.3749000E-03	2.2936000E-02
1.3351000E+03	1.8089000E-02	3.0559000E-01	5.5279000E-03	2.3589000E-02
1.3352000E+03	1.8630000E-02	3.0559000E-01	5.6932000E-03	2.4294000E-02
1.3353000E+03	1.9216000E-02	3.0558000E-01	5.8720000E-03	2.5057000E-02
1.3354000E+03	1.9849000E-02	3.0558000E-01	6.0655000E-03	2.5883000E-02
1.3355000E+03	2.0534000E-02	3.0558000E-01	6.2748000E-03	2.6776000E-02
1.3356000E+03	2.1274000E-02	3.0558000E-01	6.5009000E-03	2.7740000E-02

1.3357000E+03	2.2072000E-02	3.0557000E-01	6.7445000E-03	2.8780000E-02
1.3358000E+03	2.2929000E-02	3.0557000E-01	7.0064000E-03	2.9898000E-02
1.3359000E+03	2.3848000E-02	3.0557000E-01	7.2871000E-03	3.1095000E-02
1.3360000E+03	2.4829000E-02	3.0556000E-01	7.5870000E-03	3.2375000E-02
1.3361000E+03	2.5875000E-02	3.0552000E-01	7.9053000E-03	3.3733000E-02
1.3362000E+03	2.6984000E-02	3.0548000E-01	8.2430000E-03	3.5175000E-02
1.3363000E+03	2.8157000E-02	3.0543000E-01	8.6002000E-03	3.6699000E-02
1.3364000E+03	2.9394000E-02	3.0539000E-01	8.9767000E-03	3.8305000E-02
1.3365000E+03	3.0694000E-02	3.0535000E-01	9.3723000E-03	3.9993000E-02
1.3366000E+03	3.2055000E-02	3.0530000E-01	9.7866000E-03	4.1761000E-02
1.3367000E+03	3.3478000E-02	3.0526000E-01	1.0219000E-02	4.3608000E-02
1.3368000E+03	3.4960000E-02	3.0523000E-01	1.0671000E-02	4.5535000E-02
1.3369000E+03	3.6502000E-02	3.0521000E-01	1.1141000E-02	4.7539000E-02
1.3370000E+03	3.8101000E-02	3.0519000E-01	1.1628000E-02	4.9619000E-02
1.3371000E+03	3.9759000E-02	3.0517000E-01	1.2133000E-02	5.1775000E-02
1.3372000E+03	4.1474000E-02	3.0515000E-01	1.2656000E-02	5.4006000E-02
1.3373000E+03	4.3248000E-02	3.0514000E-01	1.3197000E-02	5.6313000E-02
1.3374000E+03	4.5082000E-02	3.0512000E-01	1.3756000E-02	5.8698000E-02
1.3375000E+03	4.6977000E-02	3.0511000E-01	1.4333000E-02	6.1162000E-02
1.3376000E+03	4.8937000E-02	3.0509000E-01	1.4930000E-02	6.3709000E-02
1.3377000E+03	5.0621000E-02	3.0507000E-01	1.5443000E-02	6.5899000E-02
1.3378000E+03	5.2694000E-02	3.0506000E-01	1.6075000E-02	6.8594000E-02
1.3379000E+03	5.4839000E-02	3.0504000E-01	1.6728000E-02	7.1383000E-02
1.3380000E+03	5.7063000E-02	3.0502000E-01	1.7406000E-02	7.4273000E-02
1.3381000E+03	5.9371000E-02	3.0496000E-01	1.8106000E-02	7.7263000E-02
1.3382000E+03	6.1773000E-02	3.0490000E-01	1.8835000E-02	8.0372000E-02
1.3383000E+03	6.4275000E-02	3.0485000E-01	1.9594000E-02	8.3612000E-02
1.3384000E+03	6.6889000E-02	3.0479000E-01	2.0387000E-02	8.6994000E-02
1.3385000E+03	6.9623000E-02	3.0473000E-01	2.1216000E-02	9.0533000E-02
1.3386000E+03	7.2488000E-02	3.0467000E-01	2.2085000E-02	9.4240000E-02
1.3387000E+03	7.5495000E-02	3.0461000E-01	2.2997000E-02	9.8132000E-02
1.3388000E+03	7.8656000E-02	3.0457000E-01	2.3956000E-02	1.0222000E-01
1.3389000E+03	8.1980000E-02	3.0452000E-01	2.4965000E-02	1.0653000E-01
1.3390000E+03	8.5480000E-02	3.0448000E-01	2.6027000E-02	1.1106000E-01
1.3391000E+03	8.9168000E-02	3.0443000E-01	2.7146000E-02	1.1584000E-01
1.3392000E+03	9.3053000E-02	3.0439000E-01	2.8324000E-02	1.2086000E-01
1.3393000E+03	9.7146000E-02	3.0434000E-01	2.9566000E-02	1.2616000E-01
1.3394000E+03	1.0146000E-01	3.0429000E-01	3.0873000E-02	1.3174000E-01
1.3395000E+03	1.0600000E-01	3.0425000E-01	3.2251000E-02	1.3762000E-01
1.3396000E+03	1.1078000E-01	3.0420000E-01	3.3700000E-02	1.4380000E-01
1.3397000E+03	1.1581000E-01	3.0415000E-01	3.5223000E-02	1.5030000E-01
1.3398000E+03	1.2109000E-01	3.0411000E-01	3.6824000E-02	1.5713000E-01
1.3399000E+03	1.2663000E-01	3.0406000E-01	3.8504000E-02	1.6430000E-01

1.3400000E+03	1.3244000E-01	3.0401000E-01	4.0265000E-02	1.7182000E-01
1.3401000E+03	1.3853000E-01	3.0403000E-01	4.2117000E-02	1.7972000E-01
1.3402000E+03	1.4489000E-01	3.0404000E-01	4.4053000E-02	1.8798000E-01
1.3403000E+03	1.5154000E-01	3.0405000E-01	4.6077000E-02	1.9662000E-01
1.3404000E+03	1.5847000E-01	3.0407000E-01	4.8187000E-02	2.0562000E-01
1.3405000E+03	1.6570000E-01	3.0408000E-01	5.0385000E-02	2.1500000E-01
1.3406000E+03	1.7321000E-01	3.0409000E-01	5.2671000E-02	2.2476000E-01
1.3407000E+03	1.8101000E-01	3.0412000E-01	5.5050000E-02	2.3491000E-01
1.3408000E+03	1.8910000E-01	3.0416000E-01	5.7517000E-02	2.4544000E-01
1.3409000E+03	1.9748000E-01	3.0419000E-01	6.0073000E-02	2.5634000E-01
1.3410000E+03	2.0615000E-01	3.0422000E-01	6.2717000E-02	2.6762000E-01
1.3411000E+03	2.1511000E-01	3.0425000E-01	6.5448000E-02	2.7928000E-01
1.3412000E+03	2.2434000E-01	3.0429000E-01	6.8265000E-02	2.9130000E-01
1.3413000E+03	2.3386000E-01	3.0432000E-01	7.1167000E-02	3.0368000E-01
1.3414000E+03	2.4364000E-01	3.0435000E-01	7.4152000E-02	3.1642000E-01
1.3415000E+03	2.5369000E-01	3.0438000E-01	7.7218000E-02	3.2950000E-01
1.3416000E+03	2.6399000E-01	3.0441000E-01	8.0363000E-02	3.4293000E-01
1.3417000E+03	2.7455000E-01	3.0445000E-01	8.3585000E-02	3.5667000E-01
1.3418000E+03	2.8534000E-01	3.0448000E-01	8.6880000E-02	3.7073000E-01
1.3419000E+03	2.9636000E-01	3.0451000E-01	9.0245000E-02	3.8509000E-01
1.3420000E+03	3.0760000E-01	3.0454000E-01	9.3676000E-02	3.9974000E-01
1.3421000E+03	3.1904000E-01	3.0449000E-01	9.7144000E-02	4.1453000E-01
1.3422000E+03	3.3067000E-01	3.0444000E-01	1.0067000E-01	4.2957000E-01
1.3423000E+03	3.4247000E-01	3.0438000E-01	1.0424000E-01	4.4483000E-01
1.3424000E+03	3.5444000E-01	3.0433000E-01	1.0787000E-01	4.6029000E-01
1.3425000E+03	3.6654000E-01	3.0428000E-01	1.1153000E-01	4.7593000E-01
1.3426000E+03	3.7877000E-01	3.0424000E-01	1.1524000E-01	4.9173000E-01
1.3427000E+03	3.9110000E-01	3.0421000E-01	1.1897000E-01	5.0769000E-01
1.3428000E+03	4.0352000E-01	3.0417000E-01	1.2274000E-01	5.2375000E-01
1.3429000E+03	4.1600000E-01	3.0414000E-01	1.2652000E-01	5.3989000E-01
1.3430000E+03	4.2852000E-01	3.0411000E-01	1.3031000E-01	5.5608000E-01
1.3431000E+03	4.4106000E-01	3.0407000E-01	1.3412000E-01	5.7230000E-01
1.3432000E+03	4.5361000E-01	3.0404000E-01	1.3792000E-01	5.8851000E-01
1.3433000E+03	4.6613000E-01	3.0401000E-01	1.4171000E-01	6.0470000E-01
1.3434000E+03	4.7861000E-01	3.0398000E-01	1.4549000E-01	6.2082000E-01
1.3435000E+03	4.9102000E-01	3.0395000E-01	1.4924000E-01	6.3686000E-01
1.3436000E+03	5.0334000E-01	3.0392000E-01	1.5298000E-01	6.5277000E-01
1.3437000E+03	5.1556000E-01	3.0389000E-01	1.5667000E-01	6.6855000E-01
1.3438000E+03	5.2764000E-01	3.0386000E-01	1.6033000E-01	6.8415000E-01
1.3439000E+03	5.3957000E-01	3.0383000E-01	1.6394000E-01	6.9955000E-01
1.3440000E+03	5.5134000E-01	3.0379000E-01	1.6749000E-01	7.1473000E-01
1.3441000E+03	5.6291000E-01	3.0377000E-01	1.7099000E-01	7.2967000E-01
1.3442000E+03	5.7428000E-01	3.0374000E-01	1.7443000E-01	7.4434000E-01

1.3443000E+03	5.8543000E-01	3.0371000E-01	1.7780000E-01	7.5872000E-01
1.3444000E+03	5.9633000E-01	3.0369000E-01	1.8110000E-01	7.7278000E-01
1.3445000E+03	6.0698000E-01	3.0366000E-01	1.8432000E-01	7.8651000E-01
1.3446000E+03	6.1736000E-01	3.0363000E-01	1.8745000E-01	7.9989000E-01
1.3447000E+03	6.2747000E-01	3.0361000E-01	1.9050000E-01	8.1291000E-01
1.3448000E+03	6.3727000E-01	3.0358000E-01	1.9346000E-01	8.2554000E-01
1.3449000E+03	6.4678000E-01	3.0355000E-01	1.9633000E-01	8.3778000E-01
1.3450000E+03	6.5597000E-01	3.0352000E-01	1.9910000E-01	8.4961000E-01
1.3451000E+03	6.6484000E-01	3.0350000E-01	2.0178000E-01	8.6102000E-01
1.3452000E+03	6.7337000E-01	3.0347000E-01	2.0435000E-01	8.7199000E-01
1.3453000E+03	6.8158000E-01	3.0344000E-01	2.0682000E-01	8.8253000E-01
1.3454000E+03	6.8944000E-01	3.0341000E-01	2.0918000E-01	8.9263000E-01
1.3455000E+03	6.9695000E-01	3.0338000E-01	2.1144000E-01	9.0227000E-01
1.3456000E+03	7.0411000E-01	3.0336000E-01	2.1360000E-01	9.1146000E-01
1.3457000E+03	7.1092000E-01	3.0333000E-01	2.1564000E-01	9.2019000E-01
1.3458000E+03	7.1737000E-01	3.0330000E-01	2.1758000E-01	9.2845000E-01
1.3459000E+03	7.2347000E-01	3.0327000E-01	2.1941000E-01	9.3626000E-01
1.3460000E+03	7.2921000E-01	3.0324000E-01	2.2113000E-01	9.4360000E-01
1.3461000E+03	7.3459000E-01	3.0317000E-01	2.2270000E-01	9.5032000E-01
1.3462000E+03	7.3962000E-01	3.0309000E-01	2.2417000E-01	9.5659000E-01
1.3463000E+03	7.4430000E-01	3.0302000E-01	2.2553000E-01	9.6240000E-01
1.3464000E+03	7.4863000E-01	3.0294000E-01	2.2679000E-01	9.6775000E-01
1.3465000E+03	7.5261000E-01	3.0284000E-01	2.2792000E-01	9.7259000E-01
1.3466000E+03	7.5626000E-01	3.0274000E-01	2.2895000E-01	9.7699000E-01
1.3467000E+03	7.5958000E-01	3.0265000E-01	2.2988000E-01	9.8096000E-01
1.3468000E+03	7.6257000E-01	3.0255000E-01	2.3071000E-01	9.8451000E-01
1.3469000E+03	7.6525000E-01	3.0245000E-01	2.3145000E-01	9.8764000E-01
1.3470000E+03	7.6762000E-01	3.0235000E-01	2.3209000E-01	9.9039000E-01
1.3471000E+03	7.6970000E-01	3.0225000E-01	2.3265000E-01	9.9275000E-01
1.3472000E+03	7.7150000E-01	3.0216000E-01	2.3311000E-01	9.9475000E-01
1.3473000E+03	7.7303000E-01	3.0206000E-01	2.3350000E-01	9.9639000E-01
1.3474000E+03	7.7430000E-01	3.0196000E-01	2.3381000E-01	9.9770000E-01
1.3475000E+03	7.7532000E-01	3.0186000E-01	2.3404000E-01	9.9870000E-01
1.3476000E+03	7.7612000E-01	3.0177000E-01	2.3421000E-01	9.9941000E-01
1.3477000E+03	7.7670000E-01	3.0167000E-01	2.3431000E-01	9.9983000E-01
1.3478000E+03	7.7709000E-01	3.0157000E-01	2.3435000E-01	1.0000000E+00
1.3479000E+03	7.7728000E-01	3.0147000E-01	2.3433000E-01	9.9993000E-01
1.3480000E+03	7.7731000E-01	3.0138000E-01	2.3426000E-01	9.9965000E-01
1.3481000E+03	7.7719000E-01	3.0126000E-01	2.3414000E-01	9.9912000E-01
1.3482000E+03	7.7693000E-01	3.0115000E-01	2.3397000E-01	9.9841000E-01
1.3483000E+03	7.7654000E-01	3.0104000E-01	2.3377000E-01	9.9755000E-01
1.3484000E+03	7.7605000E-01	3.0091000E-01	2.3352000E-01	9.9648000E-01
1.3485000E+03	7.7546000E-01	3.0077000E-01	2.3324000E-01	9.9528000E-01

1.3486000E+03	7.7479000E-01	3.0064000E-01	2.3293000E-01	9.9397000E-01
1.3487000E+03	7.7405000E-01	3.0050000E-01	2.3260000E-01	9.9257000E-01
1.3488000E+03	7.7326000E-01	3.0036000E-01	2.3226000E-01	9.9109000E-01
1.3489000E+03	7.7241000E-01	3.0023000E-01	2.3190000E-01	9.8956000E-01
1.3490000E+03	7.7153000E-01	3.0009000E-01	2.3153000E-01	9.8799000E-01
1.3491000E+03	7.7062000E-01	2.9996000E-01	2.3115000E-01	9.8637000E-01
1.3492000E+03	7.6969000E-01	2.9982000E-01	2.3077000E-01	9.8474000E-01
1.3493000E+03	7.6875000E-01	2.9968000E-01	2.3038000E-01	9.8308000E-01
1.3494000E+03	7.6780000E-01	2.9955000E-01	2.2999000E-01	9.8142000E-01
1.3495000E+03	7.6686000E-01	2.9941000E-01	2.2960000E-01	9.7976000E-01
1.3496000E+03	7.6591000E-01	2.9927000E-01	2.2921000E-01	9.7810000E-01
1.3497000E+03	7.6497000E-01	2.9914000E-01	2.2883000E-01	9.7646000E-01
1.3498000E+03	7.6404000E-01	2.9900000E-01	2.2845000E-01	9.7483000E-01
1.3499000E+03	7.6312000E-01	2.9886000E-01	2.2807000E-01	9.7321000E-01
1.3500000E+03	7.6222000E-01	2.9872000E-01	2.2769000E-01	9.7161000E-01
1.3501000E+03	7.6133000E-01	2.9861000E-01	2.2734000E-01	9.7012000E-01
1.3502000E+03	7.6046000E-01	2.9850000E-01	2.2700000E-01	9.6865000E-01
1.3503000E+03	7.5960000E-01	2.9838000E-01	2.2665000E-01	9.6718000E-01
1.3504000E+03	7.5876000E-01	2.9826000E-01	2.2631000E-01	9.6570000E-01
1.3505000E+03	7.5794000E-01	2.9813000E-01	2.2597000E-01	9.6424000E-01
1.3506000E+03	7.5714000E-01	2.9800000E-01	2.2563000E-01	9.6281000E-01
1.3507000E+03	7.5635000E-01	2.9788000E-01	2.2530000E-01	9.6140000E-01
1.3508000E+03	7.5558000E-01	2.9775000E-01	2.2497000E-01	9.6000000E-01
1.3509000E+03	7.5482000E-01	2.9762000E-01	2.2465000E-01	9.5863000E-01
1.3510000E+03	7.5407000E-01	2.9750000E-01	2.2433000E-01	9.5727000E-01
1.3511000E+03	7.5333000E-01	2.9737000E-01	2.2402000E-01	9.5593000E-01
1.3512000E+03	7.5260000E-01	2.9725000E-01	2.2371000E-01	9.5461000E-01
1.3513000E+03	7.5188000E-01	2.9712000E-01	2.2340000E-01	9.5329000E-01
1.3514000E+03	7.5116000E-01	2.9700000E-01	2.2309000E-01	9.5198000E-01
1.3515000E+03	7.5045000E-01	2.9687000E-01	2.2278000E-01	9.5067000E-01
1.3516000E+03	7.4973000E-01	2.9674000E-01	2.2248000E-01	9.4935000E-01
1.3517000E+03	7.4900000E-01	2.9662000E-01	2.2217000E-01	9.4804000E-01
1.3518000E+03	7.4827000E-01	2.9649000E-01	2.2186000E-01	9.4671000E-01
1.3519000E+03	7.4752000E-01	2.9637000E-01	2.2154000E-01	9.4537000E-01
1.3520000E+03	7.4676000E-01	2.9624000E-01	2.2122000E-01	9.4400000E-01
1.3521000E+03	7.4598000E-01	2.9610000E-01	2.2089000E-01	9.4257000E-01
1.3522000E+03	7.4518000E-01	2.9596000E-01	2.2054000E-01	9.4109000E-01
1.3523000E+03	7.4435000E-01	2.9579000E-01	2.2017000E-01	9.3950000E-01
1.3524000E+03	7.4349000E-01	2.9561000E-01	2.1978000E-01	9.3786000E-01
1.3525000E+03	7.4259000E-01	2.9544000E-01	2.1939000E-01	9.3619000E-01
1.3526000E+03	7.4166000E-01	2.9527000E-01	2.1899000E-01	9.3447000E-01
1.3527000E+03	7.4069000E-01	2.9510000E-01	2.1858000E-01	9.3271000E-01
1.3528000E+03	7.3969000E-01	2.9492000E-01	2.1815000E-01	9.3089000E-01

1.3529000E+03	7.3864000E-01	2.9475000E-01	2.1772000E-01	9.2903000E-01
1.3530000E+03	7.3755000E-01	2.9458000E-01	2.1727000E-01	9.2712000E-01
1.3531000E+03	7.3643000E-01	2.9441000E-01	2.1681000E-01	9.2517000E-01
1.3532000E+03	7.3527000E-01	2.9424000E-01	2.1634000E-01	9.2317000E-01
1.3533000E+03	7.3407000E-01	2.9406000E-01	2.1586000E-01	9.2113000E-01
1.3534000E+03	7.3284000E-01	2.9389000E-01	2.1538000E-01	9.1906000E-01
1.3535000E+03	7.3159000E-01	2.9372000E-01	2.1488000E-01	9.1695000E-01
1.3536000E+03	7.3032000E-01	2.9355000E-01	2.1439000E-01	9.1483000E-01
1.3537000E+03	7.2903000E-01	2.9338000E-01	2.1388000E-01	9.1268000E-01
1.3538000E+03	7.2773000E-01	2.9321000E-01	2.1338000E-01	9.1052000E-01
1.3539000E+03	7.2644000E-01	2.9304000E-01	2.1287000E-01	9.0837000E-01
1.3540000E+03	7.2515000E-01	2.9286000E-01	2.1237000E-01	9.0622000E-01
1.3541000E+03	7.2387000E-01	2.9273000E-01	2.1190000E-01	9.0420000E-01
1.3542000E+03	7.2262000E-01	2.9256000E-01	2.1141000E-01	9.0213000E-01
1.3543000E+03	7.2139000E-01	2.9240000E-01	2.1093000E-01	9.0008000E-01
1.3544000E+03	7.2019000E-01	2.9223000E-01	2.1046000E-01	8.9808000E-01
1.3545000E+03	7.1904000E-01	2.9206000E-01	2.1000000E-01	8.9613000E-01
1.3546000E+03	7.1792000E-01	2.9190000E-01	2.0956000E-01	8.9423000E-01
1.3547000E+03	7.1686000E-01	2.9173000E-01	2.0913000E-01	8.9240000E-01
1.3548000E+03	7.1584000E-01	2.9156000E-01	2.0871000E-01	8.9063000E-01
1.3549000E+03	7.1488000E-01	2.9140000E-01	2.0832000E-01	8.8892000E-01
1.3550000E+03	7.1397000E-01	2.9123000E-01	2.0793000E-01	8.8728000E-01
1.3551000E+03	7.1311000E-01	2.9106000E-01	2.0756000E-01	8.8570000E-01
1.3552000E+03	7.1230000E-01	2.9090000E-01	2.0721000E-01	8.8419000E-01
1.3553000E+03	7.1153000E-01	2.9073000E-01	2.0686000E-01	8.8272000E-01
1.3554000E+03	7.1080000E-01	2.9056000E-01	2.0653000E-01	8.8130000E-01
1.3555000E+03	7.1010000E-01	2.9039000E-01	2.0621000E-01	8.7993000E-01
1.3556000E+03	7.0942000E-01	2.9023000E-01	2.0589000E-01	8.7859000E-01
1.3557000E+03	7.0877000E-01	2.9006000E-01	2.0558000E-01	8.7727000E-01
1.3558000E+03	7.0812000E-01	2.8989000E-01	2.0528000E-01	8.7596000E-01
1.3559000E+03	7.0748000E-01	2.8972000E-01	2.0497000E-01	8.7466000E-01
1.3560000E+03	7.0683000E-01	2.8956000E-01	2.0467000E-01	8.7335000E-01
1.3561000E+03	7.0616000E-01	2.8934000E-01	2.0432000E-01	8.7188000E-01
1.3562000E+03	7.0547000E-01	2.8912000E-01	2.0397000E-01	8.7038000E-01
1.3563000E+03	7.0476000E-01	2.8891000E-01	2.0361000E-01	8.6884000E-01
1.3564000E+03	7.0401000E-01	2.8869000E-01	2.0324000E-01	8.6726000E-01
1.3565000E+03	7.0323000E-01	2.8847000E-01	2.0286000E-01	8.6564000E-01
1.3566000E+03	7.0240000E-01	2.8825000E-01	2.0247000E-01	8.6398000E-01
1.3567000E+03	7.0154000E-01	2.8804000E-01	2.0207000E-01	8.6226000E-01
1.3568000E+03	7.0063000E-01	2.8782000E-01	2.0165000E-01	8.6050000E-01
1.3569000E+03	6.9969000E-01	2.8760000E-01	2.0123000E-01	8.5869000E-01
1.3570000E+03	6.9871000E-01	2.8738000E-01	2.0080000E-01	8.5685000E-01
1.3571000E+03	6.9771000E-01	2.8717000E-01	2.0036000E-01	8.5497000E-01

1.3572000E+03	6.9668000E-01	2.8695000E-01	1.9991000E-01	8.5306000E-01
1.3573000E+03	6.9564000E-01	2.8673000E-01	1.9946000E-01	8.5114000E-01
1.3574000E+03	6.9459000E-01	2.8652000E-01	1.9901000E-01	8.4921000E-01
1.3575000E+03	6.9354000E-01	2.8630000E-01	1.9856000E-01	8.4729000E-01
1.3576000E+03	6.9250000E-01	2.8608000E-01	1.9811000E-01	8.4538000E-01
1.3577000E+03	6.9149000E-01	2.8587000E-01	1.9767000E-01	8.4350000E-01
1.3578000E+03	6.9050000E-01	2.8565000E-01	1.9724000E-01	8.4166000E-01
1.3579000E+03	6.8955000E-01	2.8543000E-01	1.9682000E-01	8.3987000E-01
1.3580000E+03	6.8865000E-01	2.8522000E-01	1.9641000E-01	8.3814000E-01
1.3581000E+03	6.8779000E-01	2.8503000E-01	1.9604000E-01	8.3655000E-01
1.3582000E+03	6.8699000E-01	2.8484000E-01	1.9569000E-01	8.3503000E-01
1.3583000E+03	6.8625000E-01	2.8466000E-01	1.9534000E-01	8.3357000E-01
1.3584000E+03	6.8556000E-01	2.8447000E-01	1.9502000E-01	8.3220000E-01
1.3585000E+03	6.8494000E-01	2.8428000E-01	1.9472000E-01	8.3089000E-01
1.3586000E+03	6.8436000E-01	2.8410000E-01	1.9442000E-01	8.2965000E-01
1.3587000E+03	6.8384000E-01	2.8391000E-01	1.9415000E-01	8.2846000E-01
1.3588000E+03	6.8335000E-01	2.8372000E-01	1.9388000E-01	8.2733000E-01
1.3589000E+03	6.8290000E-01	2.8354000E-01	1.9363000E-01	8.2625000E-01
1.3590000E+03	6.8247000E-01	2.8335000E-01	1.9338000E-01	8.2519000E-01
1.3591000E+03	6.8206000E-01	2.8317000E-01	1.9314000E-01	8.2415000E-01
1.3592000E+03	6.8164000E-01	2.8298000E-01	1.9289000E-01	8.2311000E-01
1.3593000E+03	6.8121000E-01	2.8280000E-01	1.9264000E-01	8.2205000E-01
1.3594000E+03	6.8076000E-01	2.8261000E-01	1.9239000E-01	8.2097000E-01
1.3595000E+03	6.8027000E-01	2.8243000E-01	1.9213000E-01	8.1984000E-01
1.3596000E+03	6.7973000E-01	2.8224000E-01	1.9185000E-01	8.1865000E-01
1.3597000E+03	6.7913000E-01	2.8206000E-01	1.9155000E-01	8.1740000E-01
1.3598000E+03	6.7846000E-01	2.8187000E-01	1.9124000E-01	8.1606000E-01
1.3599000E+03	6.7771000E-01	2.8169000E-01	1.9090000E-01	8.1463000E-01
1.3600000E+03	6.7688000E-01	2.8154000E-01	1.9057000E-01	8.1320000E-01
1.3601000E+03	6.7597000E-01	2.8137000E-01	1.9020000E-01	8.1162000E-01
1.3602000E+03	6.7497000E-01	2.8120000E-01	1.8980000E-01	8.0993000E-01
1.3603000E+03	6.7389000E-01	2.8103000E-01	1.8939000E-01	8.0814000E-01
1.3604000E+03	6.7273000E-01	2.8086000E-01	1.8895000E-01	8.0627000E-01
1.3605000E+03	6.7150000E-01	2.8069000E-01	1.8849000E-01	8.0431000E-01
1.3606000E+03	6.7021000E-01	2.8052000E-01	1.8801000E-01	8.0227000E-01
1.3607000E+03	6.6886000E-01	2.8035000E-01	1.8752000E-01	8.0018000E-01
1.3608000E+03	6.6748000E-01	2.8018000E-01	1.8702000E-01	7.9804000E-01
1.3609000E+03	6.6607000E-01	2.8002000E-01	1.8651000E-01	7.9587000E-01
1.3610000E+03	6.6465000E-01	2.7985000E-01	1.8600000E-01	7.9370000E-01
1.3611000E+03	6.6324000E-01	2.7968000E-01	1.8549000E-01	7.9154000E-01
1.3612000E+03	6.6185000E-01	2.7951000E-01	1.8500000E-01	7.8942000E-01
1.3613000E+03	6.6051000E-01	2.7935000E-01	1.8451000E-01	7.8734000E-01
1.3614000E+03	6.5922000E-01	2.7918000E-01	1.8404000E-01	7.8534000E-01

1.3615000E+03	6.5800000E-01	2.7901000E-01	1.8359000E-01	7.8341000E-01
1.3616000E+03	6.5687000E-01	2.7884000E-01	1.8316000E-01	7.8159000E-01
1.3617000E+03	6.5583000E-01	2.7868000E-01	1.8276000E-01	7.7989000E-01
1.3618000E+03	6.5489000E-01	2.7851000E-01	1.8239000E-01	7.7831000E-01
1.3619000E+03	6.5406000E-01	2.7837000E-01	1.8207000E-01	7.7694000E-01
1.3620000E+03	6.5336000E-01	2.7824000E-01	1.8179000E-01	7.7574000E-01
1.3621000E+03	6.5276000E-01	2.7818000E-01	1.8159000E-01	7.7487000E-01
1.3622000E+03	6.5229000E-01	2.7812000E-01	1.8141000E-01	7.7413000E-01
1.3623000E+03	6.5193000E-01	2.7806000E-01	1.8127000E-01	7.7353000E-01
1.3624000E+03	6.5167000E-01	2.7799000E-01	1.8116000E-01	7.7305000E-01
1.3625000E+03	6.5152000E-01	2.7793000E-01	1.8108000E-01	7.7269000E-01
1.3626000E+03	6.5145000E-01	2.7787000E-01	1.8102000E-01	7.7244000E-01
1.3627000E+03	6.5146000E-01	2.7781000E-01	1.8098000E-01	7.7228000E-01
1.3628000E+03	6.5154000E-01	2.7775000E-01	1.8096000E-01	7.7220000E-01
1.3629000E+03	6.5167000E-01	2.7768000E-01	1.8096000E-01	7.7218000E-01
1.3630000E+03	6.5184000E-01	2.7762000E-01	1.8096000E-01	7.7221000E-01
1.3631000E+03	6.5203000E-01	2.7756000E-01	1.8098000E-01	7.7227000E-01
1.3632000E+03	6.5223000E-01	2.7750000E-01	1.8099000E-01	7.7234000E-01
1.3633000E+03	6.5243000E-01	2.7744000E-01	1.8101000E-01	7.7240000E-01
1.3634000E+03	6.5262000E-01	2.7738000E-01	1.8102000E-01	7.7245000E-01
1.3635000E+03	6.5277000E-01	2.7732000E-01	1.8103000E-01	7.7247000E-01
1.3636000E+03	6.5290000E-01	2.7726000E-01	1.8102000E-01	7.7245000E-01
1.3637000E+03	6.5299000E-01	2.7720000E-01	1.8100000E-01	7.7238000E-01
1.3638000E+03	6.5302000E-01	2.7715000E-01	1.8098000E-01	7.7229000E-01
1.3639000E+03	6.5301000E-01	2.7711000E-01	1.8096000E-01	7.7218000E-01
1.3640000E+03	6.5295000E-01	2.7708000E-01	1.8092000E-01	7.7201000E-01
1.3641000E+03	6.5284000E-01	2.7702000E-01	1.8085000E-01	7.7173000E-01
1.3642000E+03	6.5268000E-01	2.7697000E-01	1.8077000E-01	7.7139000E-01
1.3643000E+03	6.5248000E-01	2.7692000E-01	1.8068000E-01	7.7100000E-01
1.3644000E+03	6.5223000E-01	2.7686000E-01	1.8058000E-01	7.7057000E-01
1.3645000E+03	6.5196000E-01	2.7681000E-01	1.8047000E-01	7.7009000E-01
1.3646000E+03	6.5165000E-01	2.7675000E-01	1.8035000E-01	7.6958000E-01
1.3647000E+03	6.5133000E-01	2.7670000E-01	1.8022000E-01	7.6905000E-01
1.3648000E+03	6.5099000E-01	2.7665000E-01	1.8009000E-01	7.6850000E-01
1.3649000E+03	6.5065000E-01	2.7659000E-01	1.7996000E-01	7.6794000E-01
1.3650000E+03	6.5030000E-01	2.7654000E-01	1.7983000E-01	7.6739000E-01
1.3651000E+03	6.4997000E-01	2.7648000E-01	1.7970000E-01	7.6684000E-01
1.3652000E+03	6.4964000E-01	2.7643000E-01	1.7958000E-01	7.6630000E-01
1.3653000E+03	6.4932000E-01	2.7637000E-01	1.7946000E-01	7.6577000E-01
1.3654000E+03	6.4903000E-01	2.7632000E-01	1.7934000E-01	7.6527000E-01
1.3655000E+03	6.4874000E-01	2.7626000E-01	1.7922000E-01	7.6478000E-01
1.3656000E+03	6.4848000E-01	2.7621000E-01	1.7911000E-01	7.6431000E-01
1.3657000E+03	6.4823000E-01	2.7615000E-01	1.7901000E-01	7.6386000E-01

1.3658000E+03	6.4799000E-01	2.7608000E-01	1.7890000E-01	7.6340000E-01
1.3659000E+03	6.4776000E-01	2.7602000E-01	1.7879000E-01	7.6294000E-01
1.3660000E+03	6.4753000E-01	2.7595000E-01	1.7869000E-01	7.6249000E-01
1.3661000E+03	6.4731000E-01	2.7591000E-01	1.7860000E-01	7.6211000E-01
1.3662000E+03	6.4709000E-01	2.7587000E-01	1.7851000E-01	7.6173000E-01
1.3663000E+03	6.4685000E-01	2.7582000E-01	1.7842000E-01	7.6134000E-01
1.3664000E+03	6.4661000E-01	2.7578000E-01	1.7832000E-01	7.6094000E-01
1.3665000E+03	6.4635000E-01	2.7574000E-01	1.7822000E-01	7.6052000E-01
1.3666000E+03	6.4607000E-01	2.7570000E-01	1.7812000E-01	7.6008000E-01
1.3667000E+03	6.4578000E-01	2.7566000E-01	1.7801000E-01	7.5962000E-01
1.3668000E+03	6.4547000E-01	2.7562000E-01	1.7790000E-01	7.5914000E-01
1.3669000E+03	6.4514000E-01	2.7557000E-01	1.7778000E-01	7.5864000E-01
1.3670000E+03	6.4480000E-01	2.7553000E-01	1.7766000E-01	7.5812000E-01
1.3671000E+03	6.4445000E-01	2.7549000E-01	1.7754000E-01	7.5760000E-01
1.3672000E+03	6.4410000E-01	2.7545000E-01	1.7742000E-01	7.5707000E-01
1.3673000E+03	6.4375000E-01	2.7541000E-01	1.7729000E-01	7.5655000E-01
1.3674000E+03	6.4342000E-01	2.7537000E-01	1.7718000E-01	7.5605000E-01
1.3675000E+03	6.4311000E-01	2.7533000E-01	1.7706000E-01	7.5557000E-01
1.3676000E+03	6.4283000E-01	2.7528000E-01	1.7696000E-01	7.5512000E-01
1.3677000E+03	6.4259000E-01	2.7523000E-01	1.7686000E-01	7.5470000E-01
1.3678000E+03	6.4240000E-01	2.7518000E-01	1.7677000E-01	7.5433000E-01
1.3679000E+03	6.4228000E-01	2.7512000E-01	1.7670000E-01	7.5403000E-01
1.3680000E+03	6.4223000E-01	2.7506000E-01	1.7666000E-01	7.5383000E-01
1.3681000E+03	6.4227000E-01	2.7502000E-01	1.7664000E-01	7.5374000E-01
1.3682000E+03	6.4240000E-01	2.7498000E-01	1.7664000E-01	7.5377000E-01
1.3683000E+03	6.4262000E-01	2.7493000E-01	1.7668000E-01	7.5392000E-01
1.3684000E+03	6.4295000E-01	2.7489000E-01	1.7674000E-01	7.5418000E-01
1.3685000E+03	6.4339000E-01	2.7484000E-01	1.7683000E-01	7.5458000E-01
1.3686000E+03	6.4395000E-01	2.7480000E-01	1.7696000E-01	7.5511000E-01
1.3687000E+03	6.4461000E-01	2.7476000E-01	1.7711000E-01	7.5577000E-01
1.3688000E+03	6.4539000E-01	2.7471000E-01	1.7730000E-01	7.5656000E-01
1.3689000E+03	6.4628000E-01	2.7467000E-01	1.7751000E-01	7.5749000E-01
1.3690000E+03	6.4728000E-01	2.7463000E-01	1.7776000E-01	7.5854000E-01
1.3691000E+03	6.4838000E-01	2.7458000E-01	1.7803000E-01	7.5971000E-01
1.3692000E+03	6.4959000E-01	2.7454000E-01	1.7834000E-01	7.6099000E-01
1.3693000E+03	6.5088000E-01	2.7449000E-01	1.7866000E-01	7.6239000E-01
1.3694000E+03	6.5225000E-01	2.7445000E-01	1.7901000E-01	7.6388000E-01
1.3695000E+03	6.5370000E-01	2.7441000E-01	1.7938000E-01	7.6546000E-01
1.3696000E+03	6.5522000E-01	2.7436000E-01	1.7977000E-01	7.6710000E-01
1.3697000E+03	6.5681000E-01	2.7430000E-01	1.8016000E-01	7.6878000E-01
1.3698000E+03	6.5844000E-01	2.7424000E-01	1.8057000E-01	7.7054000E-01
1.3699000E+03	6.6013000E-01	2.7418000E-01	1.8100000E-01	7.7234000E-01
1.3700000E+03	6.6185000E-01	2.7412000E-01	1.8143000E-01	7.7420000E-01

1.3701000E+03	6.6362000E-01	2.7409000E-01	1.8189000E-01	7.7617000E-01
1.3702000E+03	6.6541000E-01	2.7406000E-01	1.8237000E-01	7.7819000E-01
1.3703000E+03	6.6724000E-01	2.7403000E-01	1.8285000E-01	7.8024000E-01
1.3704000E+03	6.6910000E-01	2.7400000E-01	1.8333000E-01	7.8232000E-01
1.3705000E+03	6.7098000E-01	2.7397000E-01	1.8383000E-01	7.8443000E-01
1.3706000E+03	6.7290000E-01	2.7394000E-01	1.8433000E-01	7.8658000E-01
1.3707000E+03	6.7484000E-01	2.7391000E-01	1.8484000E-01	7.8876000E-01
1.3708000E+03	6.7681000E-01	2.7388000E-01	1.8536000E-01	7.9097000E-01
1.3709000E+03	6.7881000E-01	2.7385000E-01	1.8589000E-01	7.9322000E-01
1.3710000E+03	6.8084000E-01	2.7382000E-01	1.8643000E-01	7.9551000E-01
1.3711000E+03	6.8291000E-01	2.7378000E-01	1.8697000E-01	7.9784000E-01
1.3712000E+03	6.8502000E-01	2.7375000E-01	1.8753000E-01	8.0021000E-01
1.3713000E+03	6.8717000E-01	2.7372000E-01	1.8809000E-01	8.0263000E-01
1.3714000E+03	6.8935000E-01	2.7369000E-01	1.8867000E-01	8.0508000E-01
1.3715000E+03	6.9157000E-01	2.7366000E-01	1.8925000E-01	8.0758000E-01
1.3716000E+03	6.9384000E-01	2.7362000E-01	1.8985000E-01	8.1011000E-01
1.3717000E+03	6.9613000E-01	2.7358000E-01	1.9045000E-01	8.1269000E-01
1.3718000E+03	6.9846000E-01	2.7354000E-01	1.9106000E-01	8.1529000E-01
1.3719000E+03	7.0082000E-01	2.7351000E-01	1.9168000E-01	8.1794000E-01
1.3720000E+03	7.0321000E-01	2.7347000E-01	1.9231000E-01	8.2061000E-01
1.3721000E+03	7.0562000E-01	2.7344000E-01	1.9295000E-01	8.2334000E-01
1.3722000E+03	7.0804000E-01	2.7341000E-01	1.9359000E-01	8.2608000E-01
1.3723000E+03	7.1047000E-01	2.7338000E-01	1.9423000E-01	8.2883000E-01
1.3724000E+03	7.1291000E-01	2.7336000E-01	1.9488000E-01	8.3158000E-01
1.3725000E+03	7.1534000E-01	2.7333000E-01	1.9552000E-01	8.3433000E-01
1.3726000E+03	7.1776000E-01	2.7330000E-01	1.9616000E-01	8.3707000E-01
1.3727000E+03	7.2017000E-01	2.7327000E-01	1.9680000E-01	8.3979000E-01
1.3728000E+03	7.2256000E-01	2.7324000E-01	1.9744000E-01	8.4249000E-01
1.3729000E+03	7.2493000E-01	2.7321000E-01	1.9806000E-01	8.4517000E-01
1.3730000E+03	7.2728000E-01	2.7319000E-01	1.9868000E-01	8.4781000E-01
1.3731000E+03	7.2959000E-01	2.7316000E-01	1.9929000E-01	8.5043000E-01
1.3732000E+03	7.3188000E-01	2.7313000E-01	1.9990000E-01	8.5301000E-01
1.3733000E+03	7.3414000E-01	2.7310000E-01	2.0050000E-01	8.5555000E-01
1.3734000E+03	7.3638000E-01	2.7307000E-01	2.0109000E-01	8.5807000E-01
1.3735000E+03	7.3859000E-01	2.7306000E-01	2.0168000E-01	8.6060000E-01
1.3736000E+03	7.4078000E-01	2.7305000E-01	2.0227000E-01	8.6312000E-01
1.3737000E+03	7.4296000E-01	2.7303000E-01	2.0285000E-01	8.6561000E-01
1.3738000E+03	7.4512000E-01	2.7302000E-01	2.0343000E-01	8.6809000E-01
1.3739000E+03	7.4727000E-01	2.7301000E-01	2.0401000E-01	8.7056000E-01
1.3740000E+03	7.4943000E-01	2.7300000E-01	2.0459000E-01	8.7303000E-01
1.3741000E+03	7.5158000E-01	2.7300000E-01	2.0518000E-01	8.7555000E-01
1.3742000E+03	7.5374000E-01	2.7300000E-01	2.0577000E-01	8.7808000E-01
1.3743000E+03	7.5591000E-01	2.7301000E-01	2.0637000E-01	8.8061000E-01

1.3744000E+03	7.5809000E-01	2.7301000E-01	2.0696000E-01	8.8316000E-01
1.3745000E+03	7.6027000E-01	2.7301000E-01	2.0756000E-01	8.8571000E-01
1.3746000E+03	7.6246000E-01	2.7302000E-01	2.0816000E-01	8.8827000E-01
1.3747000E+03	7.6464000E-01	2.7302000E-01	2.0876000E-01	8.9083000E-01
1.3748000E+03	7.6683000E-01	2.7302000E-01	2.0936000E-01	8.9339000E-01
1.3749000E+03	7.6900000E-01	2.7303000E-01	2.0996000E-01	8.9593000E-01
1.3750000E+03	7.7114000E-01	2.7303000E-01	2.1055000E-01	8.9844000E-01
1.3751000E+03	7.7325000E-01	2.7304000E-01	2.1113000E-01	9.0092000E-01
1.3752000E+03	7.7531000E-01	2.7305000E-01	2.1170000E-01	9.0335000E-01
1.3753000E+03	7.7730000E-01	2.7305000E-01	2.1224000E-01	9.0569000E-01
1.3754000E+03	7.7921000E-01	2.7307000E-01	2.1278000E-01	9.0797000E-01
1.3755000E+03	7.8102000E-01	2.7309000E-01	2.1329000E-01	9.1015000E-01
1.3756000E+03	7.8270000E-01	2.7312000E-01	2.1377000E-01	9.1219000E-01
1.3757000E+03	7.8425000E-01	2.7314000E-01	2.1421000E-01	9.1407000E-01
1.3758000E+03	7.8563000E-01	2.7316000E-01	2.1460000E-01	9.1576000E-01
1.3759000E+03	7.8684000E-01	2.7318000E-01	2.1495000E-01	9.1724000E-01
1.3760000E+03	7.8785000E-01	2.7321000E-01	2.1524000E-01	9.1849000E-01
1.3761000E+03	7.8864000E-01	2.7325000E-01	2.1550000E-01	9.1957000E-01
1.3762000E+03	7.8920000E-01	2.7330000E-01	2.1569000E-01	9.2039000E-01
1.3763000E+03	7.8952000E-01	2.7335000E-01	2.1581000E-01	9.2091000E-01
1.3764000E+03	7.8958000E-01	2.7339000E-01	2.1587000E-01	9.2114000E-01
1.3765000E+03	7.8937000E-01	2.7344000E-01	2.1585000E-01	9.2106000E-01
1.3766000E+03	7.8888000E-01	2.7349000E-01	2.1575000E-01	9.2064000E-01
1.3767000E+03	7.8811000E-01	2.7353000E-01	2.1558000E-01	9.1990000E-01
1.3768000E+03	7.8705000E-01	2.7358000E-01	2.1532000E-01	9.1882000E-01
1.3769000E+03	7.8570000E-01	2.7363000E-01	2.1499000E-01	9.1740000E-01
1.3770000E+03	7.8405000E-01	2.7368000E-01	2.1458000E-01	9.1564000E-01
1.3771000E+03	7.8211000E-01	2.7372000E-01	2.1408000E-01	9.1354000E-01
1.3772000E+03	7.7989000E-01	2.7377000E-01	2.1351000E-01	9.1109000E-01
1.3773000E+03	7.7737000E-01	2.7382000E-01	2.1286000E-01	9.0832000E-01
1.3774000E+03	7.7458000E-01	2.7387000E-01	2.1214000E-01	9.0522000E-01
1.3775000E+03	7.7150000E-01	2.7392000E-01	2.1133000E-01	9.0180000E-01
1.3776000E+03	7.6816000E-01	2.7397000E-01	2.1046000E-01	8.9806000E-01
1.3777000E+03	7.6455000E-01	2.7403000E-01	2.0950000E-01	8.9400000E-01
1.3778000E+03	7.6067000E-01	2.7408000E-01	2.0848000E-01	8.8963000E-01
1.3779000E+03	7.5653000E-01	2.7413000E-01	2.0739000E-01	8.8496000E-01
1.3780000E+03	7.5214000E-01	2.7418000E-01	2.0622000E-01	8.7998000E-01
1.3781000E+03	7.4749000E-01	2.7423000E-01	2.0499000E-01	8.7473000E-01
1.3782000E+03	7.4259000E-01	2.7429000E-01	2.0369000E-01	8.6917000E-01
1.3783000E+03	7.3744000E-01	2.7435000E-01	2.0232000E-01	8.6332000E-01
1.3784000E+03	7.3205000E-01	2.7440000E-01	2.0088000E-01	8.5718000E-01
1.3785000E+03	7.2640000E-01	2.7446000E-01	1.9937000E-01	8.5074000E-01
1.3786000E+03	7.2049000E-01	2.7452000E-01	1.9779000E-01	8.4399000E-01

1.3787000E+03	7.1433000E-01	2.7457000E-01	1.9614000E-01	8.3695000E-01
1.3788000E+03	7.0792000E-01	2.7463000E-01	1.9441000E-01	8.2960000E-01
1.3789000E+03	7.0124000E-01	2.7468000E-01	1.9262000E-01	8.2194000E-01
1.3790000E+03	6.9430000E-01	2.7474000E-01	1.9075000E-01	8.1398000E-01
1.3791000E+03	6.8710000E-01	2.7480000E-01	1.8881000E-01	8.0570000E-01
1.3792000E+03	6.7964000E-01	2.7485000E-01	1.8680000E-01	7.9709000E-01
1.3793000E+03	6.7191000E-01	2.7486000E-01	1.8468000E-01	7.8806000E-01
1.3794000E+03	6.6391000E-01	2.7487000E-01	1.8249000E-01	7.7871000E-01
1.3795000E+03	6.5566000E-01	2.7488000E-01	1.8023000E-01	7.6906000E-01
1.3796000E+03	6.4715000E-01	2.7489000E-01	1.7789000E-01	7.5911000E-01
1.3797000E+03	6.3839000E-01	2.7490000E-01	1.7549000E-01	7.4886000E-01
1.3798000E+03	6.2938000E-01	2.7491000E-01	1.7302000E-01	7.3832000E-01
1.3799000E+03	6.2014000E-01	2.7492000E-01	1.7049000E-01	7.2750000E-01
1.3800000E+03	6.1067000E-01	2.7493000E-01	1.6789000E-01	7.1642000E-01
1.3801000E+03	6.0099000E-01	2.7497000E-01	1.6525000E-01	7.0516000E-01
1.3802000E+03	5.9111000E-01	2.7501000E-01	1.6256000E-01	6.9367000E-01
1.3803000E+03	5.8104000E-01	2.7505000E-01	1.5981000E-01	6.8195000E-01
1.3804000E+03	5.7080000E-01	2.7509000E-01	1.5702000E-01	6.7003000E-01
1.3805000E+03	5.6041000E-01	2.7512000E-01	1.5418000E-01	6.5792000E-01
1.3806000E+03	5.4987000E-01	2.7516000E-01	1.5130000E-01	6.4565000E-01
1.3807000E+03	5.3922000E-01	2.7520000E-01	1.4839000E-01	6.3323000E-01
1.3808000E+03	5.2846000E-01	2.7524000E-01	1.4545000E-01	6.2068000E-01
1.3809000E+03	5.1762000E-01	2.7528000E-01	1.4249000E-01	6.0803000E-01
1.3810000E+03	5.0670000E-01	2.7532000E-01	1.3950000E-01	5.9529000E-01
1.3811000E+03	4.9573000E-01	2.7536000E-01	1.3650000E-01	5.8248000E-01
1.3812000E+03	4.8472000E-01	2.7537000E-01	1.3347000E-01	5.6956000E-01
1.3813000E+03	4.7368000E-01	2.7537000E-01	1.3044000E-01	5.5660000E-01
1.3814000E+03	4.6263000E-01	2.7537000E-01	1.2739000E-01	5.4362000E-01
1.3815000E+03	4.5158000E-01	2.7537000E-01	1.2435000E-01	5.3064000E-01
1.3816000E+03	4.4055000E-01	2.7537000E-01	1.2132000E-01	5.1768000E-01
1.3817000E+03	4.2954000E-01	2.7538000E-01	1.1828000E-01	5.0474000E-01
1.3818000E+03	4.1856000E-01	2.7538000E-01	1.1526000E-01	4.9185000E-01
1.3819000E+03	4.0764000E-01	2.7538000E-01	1.1225000E-01	4.7901000E-01
1.3820000E+03	3.9676000E-01	2.7538000E-01	1.0926000E-01	4.6624000E-01
1.3821000E+03	3.8596000E-01	2.7536000E-01	1.0628000E-01	4.5350000E-01
1.3822000E+03	3.7522000E-01	2.7534000E-01	1.0331000E-01	4.4086000E-01
1.3823000E+03	3.6457000E-01	2.7532000E-01	1.0037000E-01	4.2831000E-01
1.3824000E+03	3.5402000E-01	2.7530000E-01	9.7461000E-02	4.1588000E-01
1.3825000E+03	3.4357000E-01	2.7528000E-01	9.4576000E-02	4.0358000E-01
1.3826000E+03	3.3323000E-01	2.7525000E-01	9.1724000E-02	3.9140000E-01
1.3827000E+03	3.2302000E-01	2.7523000E-01	8.8906000E-02	3.7938000E-01
1.3828000E+03	3.1295000E-01	2.7521000E-01	8.6126000E-02	3.6752000E-01
1.3829000E+03	3.0302000E-01	2.7519000E-01	8.3387000E-02	3.5583000E-01

1.3830000E+03	2.9325000E-01	2.7517000E-01	8.0692000E-02	3.4433000E-01
1.3831000E+03	2.8365000E-01	2.7514000E-01	7.8043000E-02	3.3303000E-01
1.3832000E+03	2.7423000E-01	2.7511000E-01	7.5443000E-02	3.2193000E-01
1.3833000E+03	2.6500000E-01	2.7508000E-01	7.2897000E-02	3.1106000E-01
1.3834000E+03	2.5598000E-01	2.7505000E-01	7.0407000E-02	3.0044000E-01
1.3835000E+03	2.4718000E-01	2.7501000E-01	6.7977000E-02	2.9007000E-01
1.3836000E+03	2.3859000E-01	2.7498000E-01	6.5608000E-02	2.7996000E-01
1.3837000E+03	2.3024000E-01	2.7495000E-01	6.3304000E-02	2.7013000E-01
1.3838000E+03	2.2213000E-01	2.7492000E-01	6.1066000E-02	2.6058000E-01
1.3839000E+03	2.1426000E-01	2.7488000E-01	5.8896000E-02	2.5132000E-01
1.3840000E+03	2.0663000E-01	2.7485000E-01	5.6793000E-02	2.4235000E-01
1.3841000E+03	1.9926000E-01	2.7478000E-01	5.4752000E-02	2.3364000E-01
1.3842000E+03	1.9213000E-01	2.7472000E-01	5.2781000E-02	2.2523000E-01
1.3843000E+03	1.8525000E-01	2.7465000E-01	5.0878000E-02	2.1711000E-01
1.3844000E+03	1.7861000E-01	2.7458000E-01	4.9043000E-02	2.0928000E-01
1.3845000E+03	1.7221000E-01	2.7452000E-01	4.7273000E-02	2.0172000E-01
1.3846000E+03	1.6603000E-01	2.7445000E-01	4.5567000E-02	1.9444000E-01
1.3847000E+03	1.6007000E-01	2.7438000E-01	4.3921000E-02	1.8742000E-01
1.3848000E+03	1.5433000E-01	2.7431000E-01	4.2334000E-02	1.8065000E-01
1.3849000E+03	1.4878000E-01	2.7425000E-01	4.0802000E-02	1.7411000E-01
1.3850000E+03	1.4342000E-01	2.7418000E-01	3.9321000E-02	1.6779000E-01
1.3851000E+03	1.3823000E-01	2.7411000E-01	3.7889000E-02	1.6168000E-01
1.3852000E+03	1.3320000E-01	2.7404000E-01	3.6501000E-02	1.5576000E-01
1.3853000E+03	1.2832000E-01	2.7397000E-01	3.5155000E-02	1.5001000E-01
1.3854000E+03	1.2358000E-01	2.7390000E-01	3.3847000E-02	1.4443000E-01
1.3855000E+03	1.1896000E-01	2.7383000E-01	3.2575000E-02	1.3901000E-01
1.3856000E+03	1.1447000E-01	2.7376000E-01	3.1337000E-02	1.3372000E-01
1.3857000E+03	1.1009000E-01	2.7369000E-01	3.0129000E-02	1.2857000E-01
1.3858000E+03	1.0581000E-01	2.7362000E-01	2.8951000E-02	1.2354000E-01
1.3859000E+03	1.0163000E-01	2.7355000E-01	2.7802000E-02	1.1864000E-01
1.3860000E+03	9.7556000E-02	2.7348000E-01	2.6680000E-02	1.1385000E-01
1.3861000E+03	9.3578000E-02	2.7341000E-01	2.5586000E-02	1.0918000E-01
1.3862000E+03	8.9700000E-02	2.7335000E-01	2.4519000E-02	1.0463000E-01
1.3863000E+03	8.5923000E-02	2.7328000E-01	2.3481000E-02	1.0020000E-01
1.3864000E+03	8.2253000E-02	2.7321000E-01	2.2473000E-02	9.5895000E-02
1.3865000E+03	7.8694000E-02	2.7315000E-01	2.1495000E-02	9.1723000E-02
1.3866000E+03	7.5251000E-02	2.7308000E-01	2.0550000E-02	8.7689000E-02
1.3867000E+03	7.1931000E-02	2.7301000E-01	1.9638000E-02	8.3800000E-02
1.3868000E+03	6.8740000E-02	2.7295000E-01	1.8763000E-02	8.0064000E-02
1.3869000E+03	6.5685000E-02	2.7288000E-01	1.7924000E-02	7.6486000E-02
1.3870000E+03	6.2770000E-02	2.7281000E-01	1.7125000E-02	7.3074000E-02
1.3871000E+03	6.0001000E-02	2.7274000E-01	1.6365000E-02	6.9831000E-02
1.3872000E+03	5.7380000E-02	2.7267000E-01	1.5646000E-02	6.6763000E-02

1.3873000E+03	5.4910000E-02	2.7259000E-01	1.4968000E-02	6.3872000E-02
1.3874000E+03	5.2590000E-02	2.7252000E-01	1.4332000E-02	6.1158000E-02
1.3875000E+03	5.0420000E-02	2.7245000E-01	1.3737000E-02	5.8618000E-02
1.3876000E+03	4.9088000E-02	2.7238000E-01	1.3370000E-02	5.7054000E-02
1.3877000E+03	4.7170000E-02	2.7231000E-01	1.2845000E-02	5.4811000E-02
1.3878000E+03	4.5379000E-02	2.7223000E-01	1.2354000E-02	5.2715000E-02
1.3879000E+03	4.3705000E-02	2.7216000E-01	1.1895000E-02	5.0758000E-02
1.3880000E+03	4.2141000E-02	2.7209000E-01	1.1466000E-02	4.8928000E-02
1.3881000E+03	4.0675000E-02	2.7203000E-01	1.1065000E-02	4.7216000E-02
1.3882000E+03	3.9298000E-02	2.7197000E-01	1.0688000E-02	4.5607000E-02
1.3883000E+03	3.7998000E-02	2.7191000E-01	1.0332000E-02	4.4089000E-02
1.3884000E+03	3.6763000E-02	2.7185000E-01	9.9940000E-03	4.2646000E-02
1.3885000E+03	3.5582000E-02	2.7179000E-01	9.6708000E-03	4.1267000E-02
1.3886000E+03	3.4444000E-02	2.7173000E-01	9.3595000E-03	3.9939000E-02
1.3887000E+03	3.3338000E-02	2.7167000E-01	9.0571000E-03	3.8648000E-02
1.3888000E+03	3.2256000E-02	2.7161000E-01	8.7611000E-03	3.7385000E-02
1.3889000E+03	3.1188000E-02	2.7155000E-01	8.4692000E-03	3.6140000E-02
1.3890000E+03	3.0129000E-02	2.7149000E-01	8.1795000E-03	3.4904000E-02
1.3891000E+03	2.9072000E-02	2.7142000E-01	7.8907000E-03	3.3671000E-02
1.3892000E+03	2.8013000E-02	2.7136000E-01	7.6017000E-03	3.2438000E-02
1.3893000E+03	2.6952000E-02	2.7130000E-01	7.3120000E-03	3.1202000E-02
1.3894000E+03	2.5887000E-02	2.7124000E-01	7.0214000E-03	2.9962000E-02
1.3895000E+03	2.4819000E-02	2.7117000E-01	6.7303000E-03	2.8720000E-02
1.3896000E+03	2.3752000E-02	2.7111000E-01	6.4395000E-03	2.7479000E-02
1.3897000E+03	2.2689000E-02	2.7105000E-01	6.1500000E-03	2.6243000E-02
1.3898000E+03	2.1636000E-02	2.7099000E-01	5.8632000E-03	2.5019000E-02
1.3899000E+03	2.0599000E-02	2.7092000E-01	5.5807000E-03	2.3814000E-02
1.3900000E+03	1.9584000E-02	2.7086000E-01	5.3045000E-03	2.2635000E-02
1.3901000E+03	1.8598000E-02	2.7078000E-01	5.0360000E-03	2.1490000E-02
1.3902000E+03	1.7648000E-02	2.7071000E-01	4.7776000E-03	2.0387000E-02
1.3903000E+03	1.6742000E-02	2.7063000E-01	4.5310000E-03	1.9335000E-02
1.3904000E+03	1.5886000E-02	2.7055000E-01	4.2980000E-03	1.8340000E-02
1.3905000E+03	1.5084000E-02	2.7048000E-01	4.0799000E-03	1.7410000E-02
1.3906000E+03	1.4342000E-02	2.7040000E-01	3.8782000E-03	1.6549000E-02
1.3907000E+03	1.3664000E-02	2.7032000E-01	3.6936000E-03	1.5761000E-02
1.3908000E+03	1.3050000E-02	2.7025000E-01	3.5268000E-03	1.5050000E-02
1.3909000E+03	1.2503000E-02	2.7018000E-01	3.3781000E-03	1.4415000E-02
1.3910000E+03	1.2021000E-02	2.7011000E-01	3.2471000E-03	1.3856000E-02
1.3911000E+03	1.1603000E-02	2.7005000E-01	3.1333000E-03	1.3371000E-02
1.3912000E+03	1.1245000E-02	2.6998000E-01	3.0359000E-03	1.2955000E-02
1.3913000E+03	1.0942000E-02	2.6992000E-01	2.9534000E-03	1.2603000E-02
1.3914000E+03	1.0690000E-02	2.6985000E-01	2.8846000E-03	1.2309000E-02
1.3915000E+03	1.0481000E-02	2.6978000E-01	2.8276000E-03	1.2066000E-02

1.3916000E+03	1.0309000E-02	2.6972000E-01	2.7806000E-03	1.1865000E-02
1.3917000E+03	1.0166000E-02	2.6965000E-01	2.7414000E-03	1.1698000E-02
1.3918000E+03	1.0045000E-02	2.6959000E-01	2.7081000E-03	1.1556000E-02
1.3919000E+03	9.9384000E-03	2.6952000E-01	2.6786000E-03	1.1430000E-02
1.3920000E+03	9.8383000E-03	2.6946000E-01	2.6510000E-03	1.1312000E-02
1.3921000E+03	9.7382000E-03	2.6938000E-01	2.6233000E-03	1.1194000E-02
1.3922000E+03	9.6324000E-03	2.6931000E-01	2.5941000E-03	1.1069000E-02
1.3923000E+03	9.5155000E-03	2.6923000E-01	2.5619000E-03	1.0932000E-02
1.3924000E+03	9.3836000E-03	2.6916000E-01	2.5257000E-03	1.0778000E-02
1.3925000E+03	9.2337000E-03	2.6908000E-01	2.4846000E-03	1.0602000E-02
1.3926000E+03	9.0639000E-03	2.6901000E-01	2.4383000E-03	1.0405000E-02
1.3927000E+03	8.8735000E-03	2.6894000E-01	2.3864000E-03	1.0183000E-02
1.3928000E+03	8.6630000E-03	2.6887000E-01	2.3292000E-03	9.9394000E-03
1.3929000E+03	8.4337000E-03	2.6881000E-01	2.2671000E-03	9.6741000E-03
1.3930000E+03	8.1880000E-03	2.6875000E-01	2.2005000E-03	9.3901000E-03
1.3931000E+03	7.9292000E-03	2.6869000E-01	2.1305000E-03	9.0911000E-03
1.3932000E+03	7.6608000E-03	2.6863000E-01	2.0579000E-03	8.7814000E-03
1.3933000E+03	7.3871000E-03	2.6856000E-01	1.9839000E-03	8.4657000E-03
1.3934000E+03	7.1125000E-03	2.6850000E-01	1.9097000E-03	8.1491000E-03
1.3935000E+03	6.8413000E-03	2.6844000E-01	1.8365000E-03	7.8366000E-03
1.3936000E+03	6.5778000E-03	2.6837000E-01	1.7653000E-03	7.5330000E-03
1.3937000E+03	6.3259000E-03	2.6831000E-01	1.6973000E-03	7.2428000E-03
1.3938000E+03	6.0890000E-03	2.6825000E-01	1.6334000E-03	6.9699000E-03
1.3939000E+03	5.8699000E-03	2.6819000E-01	1.5742000E-03	6.7175000E-03
1.3940000E+03	5.6705000E-03	2.6813000E-01	1.5204000E-03	6.4879000E-03
1.3941000E+03	5.4923000E-03	2.6806000E-01	1.4723000E-03	6.2826000E-03
1.3942000E+03	5.3357000E-03	2.6800000E-01	1.4300000E-03	6.1019000E-03
1.3943000E+03	5.2003000E-03	2.6794000E-01	1.3933000E-03	5.9457000E-03
1.3944000E+03	5.0850000E-03	2.6787000E-01	1.3621000E-03	5.8125000E-03
1.3945000E+03	4.9880000E-03	2.6781000E-01	1.3358000E-03	5.7003000E-03
1.3946000E+03	4.9070000E-03	2.6775000E-01	1.3138000E-03	5.6064000E-03
1.3947000E+03	4.8389000E-03	2.6770000E-01	1.2954000E-03	5.5277000E-03
1.3948000E+03	4.7807000E-03	2.6766000E-01	1.2796000E-03	5.4604000E-03
1.3949000E+03	4.7289000E-03	2.6762000E-01	1.2656000E-03	5.4004000E-03
1.3950000E+03	4.6800000E-03	2.6758000E-01	1.2523000E-03	5.3437000E-03
1.3951000E+03	4.6307000E-03	2.6754000E-01	1.2389000E-03	5.2867000E-03
1.3952000E+03	4.5780000E-03	2.6750000E-01	1.2246000E-03	5.2257000E-03
1.3953000E+03	4.5190000E-03	2.6746000E-01	1.2087000E-03	5.1577000E-03
1.3954000E+03	4.4516000E-03	2.6743000E-01	1.1905000E-03	5.0800000E-03
1.3955000E+03	4.3742000E-03	2.6739000E-01	1.1696000E-03	4.9909000E-03
1.3956000E+03	4.2857000E-03	2.6735000E-01	1.1458000E-03	4.8893000E-03
1.3957000E+03	4.1858000E-03	2.6731000E-01	1.1189000E-03	4.7746000E-03
1.3958000E+03	4.0749000E-03	2.6727000E-01	1.0891000E-03	4.6474000E-03

1.3959000E+03	3.9539000E-03	2.6723000E-01	1.0566000E-03	4.5088000E-03
1.3960000E+03	3.8245000E-03	2.6720000E-01	1.0219000E-03	4.3606000E-03
1.3961000E+03	3.6888000E-03	2.6713000E-01	9.8539000E-04	4.2048000E-03
1.3962000E+03	3.5492000E-03	2.6707000E-01	9.4787000E-04	4.0448000E-03
1.3963000E+03	3.4085000E-03	2.6701000E-01	9.1010000E-04	3.8836000E-03
1.3964000E+03	3.2698000E-03	2.6694000E-01	8.7285000E-04	3.7246000E-03
1.3965000E+03	3.1360000E-03	2.6688000E-01	8.3692000E-04	3.5713000E-03
1.3966000E+03	3.0098000E-03	2.6684000E-01	8.0312000E-04	3.4271000E-03
1.3967000E+03	2.8939000E-03	2.6681000E-01	7.7212000E-04	3.2948000E-03
1.3968000E+03	2.7905000E-03	2.6678000E-01	7.4445000E-04	3.1767000E-03
1.3969000E+03	2.7012000E-03	2.6676000E-01	7.2057000E-04	3.0748000E-03
1.3970000E+03	2.6272000E-03	2.6673000E-01	7.0076000E-04	2.9903000E-03
1.3971000E+03	2.5691000E-03	2.6671000E-01	6.8519000E-04	2.9239000E-03
1.3972000E+03	2.5267000E-03	2.6669000E-01	6.7383000E-04	2.8753000E-03
1.3973000E+03	2.4993000E-03	2.6666000E-01	6.6647000E-04	2.8439000E-03
1.3974000E+03	2.4856000E-03	2.6664000E-01	6.6276000E-04	2.8281000E-03
1.3975000E+03	0.0000000E+00	2.6662000E-01	0.0000000E+00	0.0000000E+00
Channel 12				
Wavenumber	HIRS Filter Transmittance	Optical Element Transmittance	Product of the HIRS Filter and Optical Element Transmittances	Normalized Value of Column 4
1.4869000E+03	0.0000000E+00	2.9666000E-01	0.0000000E+00	0.0000000E+00
1.4870000E+03	2.4006000E-03	2.9648000E-01	7.1173000E-04	3.6027000E-03
1.4871000E+03	2.4492000E-03	2.9631000E-01	7.2573000E-04	3.6736000E-03
1.4872000E+03	2.5052000E-03	2.9614000E-01	7.4188000E-04	3.7553000E-03
1.4873000E+03	2.5681000E-03	2.9598000E-01	7.6012000E-04	3.8476000E-03
1.4874000E+03	2.6375000E-03	2.9583000E-01	7.8024000E-04	3.9495000E-03
1.4875000E+03	2.7126000E-03	2.9568000E-01	8.0206000E-04	4.0600000E-03
1.4876000E+03	2.7928000E-03	2.9552000E-01	8.2535000E-04	4.1778000E-03
1.4877000E+03	2.8773000E-03	2.9537000E-01	8.4986000E-04	4.3019000E-03
1.4878000E+03	2.9649000E-03	2.9522000E-01	8.7530000E-04	4.4307000E-03
1.4879000E+03	3.0548000E-03	2.9507000E-01	9.0137000E-04	4.5626000E-03
1.4880000E+03	3.1458000E-03	2.9491000E-01	9.2775000E-04	4.6961000E-03
1.4881000E+03	3.2369000E-03	2.9470000E-01	9.5390000E-04	4.8285000E-03
1.4882000E+03	3.3269000E-03	2.9448000E-01	9.7970000E-04	4.9591000E-03
1.4883000E+03	3.4148000E-03	2.9426000E-01	1.0048000E-03	5.0864000E-03
1.4884000E+03	3.4995000E-03	2.9405000E-01	1.0290000E-03	5.2088000E-03
1.4885000E+03	3.5802000E-03	2.9383000E-01	1.0520000E-03	5.3250000E-03
1.4886000E+03	3.6561000E-03	2.9361000E-01	1.0735000E-03	5.4339000E-03
1.4887000E+03	3.7267000E-03	2.9339000E-01	1.0934000E-03	5.5346000E-03
1.4888000E+03	3.7913000E-03	2.9318000E-01	1.1115000E-03	5.6265000E-03
1.4889000E+03	3.8499000E-03	2.9296000E-01	1.1279000E-03	5.7092000E-03

1.4890000E+03	3.9024000E-03	2.9274000E-01	1.1424000E-03	5.7826000E-03
1.4891000E+03	3.9488000E-03	2.9252000E-01	1.1551000E-03	5.8471000E-03
1.4892000E+03	3.9895000E-03	2.9231000E-01	1.1662000E-03	5.9030000E-03
1.4893000E+03	4.0250000E-03	2.9209000E-01	1.1757000E-03	5.9510000E-03
1.4894000E+03	4.0560000E-03	2.9186000E-01	1.1838000E-03	5.9923000E-03
1.4895000E+03	4.0833000E-03	2.9164000E-01	1.1909000E-03	6.0280000E-03
1.4896000E+03	4.1077000E-03	2.9142000E-01	1.1971000E-03	6.0594000E-03
1.4897000E+03	4.1303000E-03	2.9120000E-01	1.2027000E-03	6.0882000E-03
1.4898000E+03	4.1522000E-03	2.9098000E-01	1.2082000E-03	6.1158000E-03
1.4899000E+03	4.1744000E-03	2.9076000E-01	1.2138000E-03	6.1439000E-03
1.4900000E+03	4.1982000E-03	2.9054000E-01	1.2197000E-03	6.1742000E-03
1.4901000E+03	4.2247000E-03	2.9031000E-01	1.2264000E-03	6.2081000E-03
1.4902000E+03	4.2550000E-03	2.9007000E-01	1.2342000E-03	6.2476000E-03
1.4903000E+03	4.2901000E-03	2.8984000E-01	1.2434000E-03	6.2942000E-03
1.4904000E+03	4.3312000E-03	2.8961000E-01	1.2543000E-03	6.3493000E-03
1.4905000E+03	4.3790000E-03	2.8937000E-01	1.2672000E-03	6.4143000E-03
1.4906000E+03	4.4346000E-03	2.8914000E-01	1.2822000E-03	6.4905000E-03
1.4907000E+03	4.4986000E-03	2.8891000E-01	1.2997000E-03	6.5788000E-03
1.4908000E+03	4.5715000E-03	2.8867000E-01	1.3197000E-03	6.6801000E-03
1.4909000E+03	4.6540000E-03	2.8844000E-01	1.3424000E-03	6.7950000E-03
1.4910000E+03	4.7462000E-03	2.8821000E-01	1.3679000E-03	6.9240000E-03
1.4911000E+03	4.8483000E-03	2.8798000E-01	1.3962000E-03	7.0674000E-03
1.4912000E+03	4.9603000E-03	2.8777000E-01	1.4274000E-03	7.2253000E-03
1.4913000E+03	5.0820000E-03	2.8755000E-01	1.4613000E-03	7.3971000E-03
1.4914000E+03	5.2132000E-03	2.8734000E-01	1.4979000E-03	7.5824000E-03
1.4915000E+03	5.3532000E-03	2.8712000E-01	1.5370000E-03	7.7803000E-03
1.4916000E+03	5.5016000E-03	2.8691000E-01	1.5784000E-03	7.9899000E-03
1.4917000E+03	5.6575000E-03	2.8669000E-01	1.6220000E-03	8.2103000E-03
1.4918000E+03	5.8203000E-03	2.8648000E-01	1.6674000E-03	8.4401000E-03
1.4919000E+03	5.9890000E-03	2.8627000E-01	1.7144000E-03	8.6783000E-03
1.4920000E+03	6.1628000E-03	2.8605000E-01	1.7629000E-03	8.9236000E-03
1.4921000E+03	6.3409000E-03	2.8591000E-01	1.8129000E-03	9.1769000E-03
1.4922000E+03	6.5225000E-03	2.8577000E-01	1.8640000E-03	9.4351000E-03
1.4923000E+03	6.7069000E-03	2.8563000E-01	1.9157000E-03	9.6970000E-03
1.4924000E+03	6.8934000E-03	2.8549000E-01	1.9680000E-03	9.9618000E-03
1.4925000E+03	7.0816000E-03	2.8535000E-01	2.0207000E-03	1.0229000E-02
1.4926000E+03	7.2712000E-03	2.8521000E-01	2.0738000E-03	1.0497000E-02
1.4927000E+03	7.4619000E-03	2.8507000E-01	2.1272000E-03	1.0767000E-02
1.4928000E+03	7.6539000E-03	2.8493000E-01	2.1808000E-03	1.1039000E-02
1.4929000E+03	7.8473000E-03	2.8479000E-01	2.2348000E-03	1.1312000E-02
1.4930000E+03	8.0425000E-03	2.8465000E-01	2.2893000E-03	1.1588000E-02
1.4931000E+03	8.2402000E-03	2.8457000E-01	2.3449000E-03	1.1869000E-02
1.4932000E+03	8.4410000E-03	2.8449000E-01	2.4014000E-03	1.2155000E-02

1.4933000E+03	8.6460000E-03	2.8441000E-01	2.4590000E-03	1.2447000E-02
1.4934000E+03	8.8563000E-03	2.8433000E-01	2.5181000E-03	1.2746000E-02
1.4935000E+03	9.0732000E-03	2.8425000E-01	2.5790000E-03	1.3055000E-02
1.4936000E+03	9.2982000E-03	2.8416000E-01	2.6422000E-03	1.3375000E-02
1.4937000E+03	9.5327000E-03	2.8408000E-01	2.7081000E-03	1.3708000E-02
1.4938000E+03	9.7784000E-03	2.8400000E-01	2.7771000E-03	1.4057000E-02
1.4939000E+03	1.0037000E-02	2.8392000E-01	2.8498000E-03	1.4425000E-02
1.4940000E+03	1.0311000E-02	2.8384000E-01	2.9267000E-03	1.4814000E-02
1.4941000E+03	1.0601000E-02	2.8358000E-01	3.0062000E-03	1.5217000E-02
1.4942000E+03	1.0910000E-02	2.8331000E-01	3.0909000E-03	1.5646000E-02
1.4943000E+03	1.1239000E-02	2.8304000E-01	3.1811000E-03	1.6102000E-02
1.4944000E+03	1.1590000E-02	2.8278000E-01	3.2775000E-03	1.6590000E-02
1.4945000E+03	1.1965000E-02	2.8251000E-01	3.3804000E-03	1.7111000E-02
1.4946000E+03	1.2366000E-02	2.8225000E-01	3.4903000E-03	1.7668000E-02
1.4947000E+03	1.2794000E-02	2.8198000E-01	3.6077000E-03	1.8262000E-02
1.4948000E+03	1.3250000E-02	2.8171000E-01	3.7328000E-03	1.8895000E-02
1.4949000E+03	1.3736000E-02	2.8145000E-01	3.8661000E-03	1.9570000E-02
1.4950000E+03	1.4253000E-02	2.8122000E-01	4.0084000E-03	2.0290000E-02
1.4951000E+03	1.4802000E-02	2.8101000E-01	4.1596000E-03	2.1056000E-02
1.4952000E+03	1.5384000E-02	2.8080000E-01	4.3199000E-03	2.1867000E-02
1.4953000E+03	1.6000000E-02	2.8059000E-01	4.4893000E-03	2.2725000E-02
1.4954000E+03	1.6649000E-02	2.8038000E-01	4.6681000E-03	2.3629000E-02
1.4955000E+03	1.7334000E-02	2.8017000E-01	4.8564000E-03	2.4582000E-02
1.4956000E+03	1.8053000E-02	2.7996000E-01	5.0542000E-03	2.5584000E-02
1.4957000E+03	1.8809000E-02	2.7975000E-01	5.2617000E-03	2.6634000E-02
1.4958000E+03	1.9600000E-02	2.7954000E-01	5.4790000E-03	2.7734000E-02
1.4959000E+03	2.0428000E-02	2.7933000E-01	5.7062000E-03	2.8884000E-02
1.4960000E+03	2.1294000E-02	2.7911000E-01	5.9433000E-03	3.0084000E-02
1.4961000E+03	2.2196000E-02	2.7894000E-01	6.1914000E-03	3.1340000E-02
1.4962000E+03	2.3137000E-02	2.7876000E-01	6.4498000E-03	3.2648000E-02
1.4963000E+03	2.4117000E-02	2.7859000E-01	6.7187000E-03	3.4009000E-02
1.4964000E+03	2.5137000E-02	2.7841000E-01	6.9983000E-03	3.5425000E-02
1.4965000E+03	2.6197000E-02	2.7823000E-01	7.2890000E-03	3.6896000E-02
1.4966000E+03	2.7300000E-02	2.7806000E-01	7.5909000E-03	3.8424000E-02
1.4967000E+03	2.8446000E-02	2.7788000E-01	7.9046000E-03	4.0012000E-02
1.4968000E+03	2.9638000E-02	2.7770000E-01	8.2304000E-03	4.1661000E-02
1.4969000E+03	3.0876000E-02	2.7750000E-01	8.5681000E-03	4.3371000E-02
1.4970000E+03	3.2163000E-02	2.7727000E-01	8.9179000E-03	4.5141000E-02
1.4971000E+03	3.3502000E-02	2.7704000E-01	9.2814000E-03	4.6981000E-02
1.4972000E+03	3.4894000E-02	2.7681000E-01	9.6590000E-03	4.8893000E-02
1.4973000E+03	3.6343000E-02	2.7658000E-01	1.0052000E-02	5.0880000E-02
1.4974000E+03	3.7850000E-02	2.7635000E-01	1.0460000E-02	5.2947000E-02
1.4975000E+03	3.9421000E-02	2.7612000E-01	1.0885000E-02	5.5098000E-02

1.4976000E+03	4.1056000E-02	2.7589000E-01	1.1327000E-02	5.7336000E-02
1.4977000E+03	4.2760000E-02	2.7566000E-01	1.1787000E-02	5.9666000E-02
1.4978000E+03	4.4536000E-02	2.7543000E-01	1.2267000E-02	6.2093000E-02
1.4979000E+03	4.6388000E-02	2.7520000E-01	1.2766000E-02	6.4620000E-02
1.4980000E+03	4.8319000E-02	2.7497000E-01	1.3286000E-02	6.7254000E-02
1.4981000E+03	5.0333000E-02	2.7483000E-01	1.3833000E-02	7.0019000E-02
1.4982000E+03	5.1983000E-02	2.7468000E-01	1.4279000E-02	7.2277000E-02
1.4983000E+03	5.4154000E-02	2.7454000E-01	1.4867000E-02	7.5257000E-02
1.4984000E+03	5.6420000E-02	2.7439000E-01	1.5481000E-02	7.8364000E-02
1.4985000E+03	5.8782000E-02	2.7425000E-01	1.6121000E-02	8.1602000E-02
1.4986000E+03	6.1245000E-02	2.7410000E-01	1.6787000E-02	8.4976000E-02
1.4987000E+03	6.3812000E-02	2.7396000E-01	1.7482000E-02	8.8491000E-02
1.4988000E+03	6.6487000E-02	2.7379000E-01	1.8203000E-02	9.2142000E-02
1.4989000E+03	6.9271000E-02	2.7351000E-01	1.8946000E-02	9.5904000E-02
1.4990000E+03	7.2170000E-02	2.7323000E-01	1.9719000E-02	9.9816000E-02
1.4991000E+03	7.5184000E-02	2.7295000E-01	2.0522000E-02	1.0388000E-01
1.4992000E+03	7.8319000E-02	2.7268000E-01	2.1356000E-02	1.0810000E-01
1.4993000E+03	8.1576000E-02	2.7240000E-01	2.2221000E-02	1.1248000E-01
1.4994000E+03	8.4958000E-02	2.7212000E-01	2.3118000E-02	1.1702000E-01
1.4995000E+03	8.8468000E-02	2.7184000E-01	2.4049000E-02	1.2173000E-01
1.4996000E+03	9.2109000E-02	2.7156000E-01	2.5013000E-02	1.2661000E-01
1.4997000E+03	9.5884000E-02	2.7128000E-01	2.6011000E-02	1.3167000E-01
1.4998000E+03	9.9796000E-02	2.7100000E-01	2.7045000E-02	1.3690000E-01
1.4999000E+03	1.0385000E-01	2.7072000E-01	2.8114000E-02	1.4231000E-01
1.5000000E+03	1.0804000E-01	2.7044000E-01	2.9219000E-02	1.4790000E-01
1.5001000E+03	1.1238000E-01	2.7015000E-01	3.0360000E-02	1.5368000E-01
1.5002000E+03	1.1687000E-01	2.6985000E-01	3.1538000E-02	1.5964000E-01
1.5003000E+03	1.2151000E-01	2.6956000E-01	3.2754000E-02	1.6580000E-01
1.5004000E+03	1.2631000E-01	2.6926000E-01	3.4010000E-02	1.7216000E-01
1.5005000E+03	1.3127000E-01	2.6896000E-01	3.5306000E-02	1.7872000E-01
1.5006000E+03	1.3639000E-01	2.6867000E-01	3.6643000E-02	1.8548000E-01
1.5007000E+03	1.4167000E-01	2.6837000E-01	3.8020000E-02	1.9245000E-01
1.5008000E+03	1.4712000E-01	2.6801000E-01	3.9431000E-02	1.9960000E-01
1.5009000E+03	1.5275000E-01	2.6765000E-01	4.0883000E-02	2.0695000E-01
1.5010000E+03	1.5855000E-01	2.6729000E-01	4.2378000E-02	2.1451000E-01
1.5011000E+03	1.6453000E-01	2.6692000E-01	4.3916000E-02	2.2230000E-01
1.5012000E+03	1.7068000E-01	2.6656000E-01	4.5497000E-02	2.3030000E-01
1.5013000E+03	1.7702000E-01	2.6619000E-01	4.7122000E-02	2.3853000E-01
1.5014000E+03	1.8355000E-01	2.6583000E-01	4.8791000E-02	2.4698000E-01
1.5015000E+03	1.9026000E-01	2.6546000E-01	5.0505000E-02	2.5565000E-01
1.5016000E+03	1.9715000E-01	2.6510000E-01	5.2263000E-02	2.6455000E-01
1.5017000E+03	2.0423000E-01	2.6473000E-01	5.4065000E-02	2.7367000E-01
1.5018000E+03	2.1149000E-01	2.6437000E-01	5.5910000E-02	2.8301000E-01

1.5019000E+03	2.1893000E-01	2.6400000E-01	5.7798000E-02	2.9257000E-01
1.5020000E+03	2.2655000E-01	2.6364000E-01	5.9728000E-02	3.0234000E-01
1.5021000E+03	2.3435000E-01	2.6326000E-01	6.1696000E-02	3.1230000E-01
1.5022000E+03	2.4232000E-01	2.6288000E-01	6.3703000E-02	3.2245000E-01
1.5023000E+03	2.5046000E-01	2.6251000E-01	6.5747000E-02	3.3280000E-01
1.5024000E+03	2.5875000E-01	2.6213000E-01	6.7828000E-02	3.4334000E-01
1.5025000E+03	2.6721000E-01	2.6175000E-01	6.9942000E-02	3.5404000E-01
1.5026000E+03	2.7580000E-01	2.6138000E-01	7.2089000E-02	3.6491000E-01
1.5027000E+03	2.8454000E-01	2.6101000E-01	7.4269000E-02	3.7594000E-01
1.5028000E+03	2.9340000E-01	2.6066000E-01	7.6477000E-02	3.8712000E-01
1.5029000E+03	3.0238000E-01	2.6030000E-01	7.8710000E-02	3.9842000E-01
1.5030000E+03	3.1146000E-01	2.5995000E-01	8.0965000E-02	4.0983000E-01
1.5031000E+03	3.2065000E-01	2.5960000E-01	8.3238000E-02	4.2134000E-01
1.5032000E+03	3.2991000E-01	2.5924000E-01	8.5526000E-02	4.3293000E-01
1.5033000E+03	3.3925000E-01	2.5889000E-01	8.7827000E-02	4.4457000E-01
1.5034000E+03	3.4864000E-01	2.5853000E-01	9.0136000E-02	4.5626000E-01
1.5035000E+03	3.5808000E-01	2.5818000E-01	9.2451000E-02	4.6797000E-01
1.5036000E+03	3.6756000E-01	2.5783000E-01	9.4767000E-02	4.7970000E-01
1.5037000E+03	3.7706000E-01	2.5748000E-01	9.7084000E-02	4.9143000E-01
1.5038000E+03	3.8656000E-01	2.5713000E-01	9.9395000E-02	5.0313000E-01
1.5039000E+03	3.9607000E-01	2.5678000E-01	1.0170000E-01	5.1479000E-01
1.5040000E+03	4.0556000E-01	2.5642000E-01	1.0399000E-01	5.2641000E-01
1.5041000E+03	4.1502000E-01	2.5602000E-01	1.0625000E-01	5.3785000E-01
1.5042000E+03	4.2445000E-01	2.5562000E-01	1.0850000E-01	5.4920000E-01
1.5043000E+03	4.3383000E-01	2.5522000E-01	1.1072000E-01	5.6046000E-01
1.5044000E+03	4.4315000E-01	2.5482000E-01	1.1292000E-01	5.7161000E-01
1.5045000E+03	4.5242000E-01	2.5442000E-01	1.1510000E-01	5.8264000E-01
1.5046000E+03	4.6161000E-01	2.5404000E-01	1.1727000E-01	5.9359000E-01
1.5047000E+03	4.7072000E-01	2.5371000E-01	1.1943000E-01	6.0452000E-01
1.5048000E+03	4.7974000E-01	2.5338000E-01	1.2156000E-01	6.1531000E-01
1.5049000E+03	4.8867000E-01	2.5305000E-01	1.2366000E-01	6.2595000E-01
1.5050000E+03	4.9750000E-01	2.5272000E-01	1.2573000E-01	6.3643000E-01
1.5051000E+03	5.0623000E-01	2.5240000E-01	1.2777000E-01	6.4676000E-01
1.5052000E+03	5.1485000E-01	2.5207000E-01	1.2978000E-01	6.5692000E-01
1.5053000E+03	5.2336000E-01	2.5174000E-01	1.3175000E-01	6.6690000E-01
1.5054000E+03	5.3175000E-01	2.5141000E-01	1.3369000E-01	6.7672000E-01
1.5055000E+03	5.4002000E-01	2.5109000E-01	1.3559000E-01	6.8635000E-01
1.5056000E+03	5.4817000E-01	2.5076000E-01	1.3746000E-01	6.9580000E-01
1.5057000E+03	5.5620000E-01	2.5043000E-01	1.3929000E-01	7.0507000E-01
1.5058000E+03	5.6409000E-01	2.5011000E-01	1.4108000E-01	7.1415000E-01
1.5059000E+03	5.7186000E-01	2.4978000E-01	1.4284000E-01	7.2303000E-01
1.5060000E+03	5.7948000E-01	2.4945000E-01	1.4455000E-01	7.3172000E-01
1.5061000E+03	5.8697000E-01	2.4919000E-01	1.4627000E-01	7.4038000E-01

1.5062000E+03	5.9432000E-01	2.4892000E-01	1.4794000E-01	7.4885000E-01
1.5063000E+03	6.0152000E-01	2.4865000E-01	1.4957000E-01	7.5711000E-01
1.5064000E+03	6.0858000E-01	2.4839000E-01	1.5116000E-01	7.6516000E-01
1.5065000E+03	6.1547000E-01	2.4812000E-01	1.5271000E-01	7.7301000E-01
1.5066000E+03	6.2221000E-01	2.4795000E-01	1.5428000E-01	7.8095000E-01
1.5067000E+03	6.2879000E-01	2.4779000E-01	1.5581000E-01	7.8868000E-01
1.5068000E+03	6.3521000E-01	2.4762000E-01	1.5729000E-01	7.9618000E-01
1.5069000E+03	6.4145000E-01	2.4745000E-01	1.5873000E-01	8.0347000E-01
1.5070000E+03	6.4752000E-01	2.4729000E-01	1.6012000E-01	8.1053000E-01
1.5071000E+03	6.5341000E-01	2.4712000E-01	1.6147000E-01	8.1734000E-01
1.5072000E+03	6.5912000E-01	2.4695000E-01	1.6277000E-01	8.2392000E-01
1.5073000E+03	6.6465000E-01	2.4678000E-01	1.6402000E-01	8.3026000E-01
1.5074000E+03	6.6998000E-01	2.4661000E-01	1.6523000E-01	8.3636000E-01
1.5075000E+03	6.7513000E-01	2.4645000E-01	1.6638000E-01	8.4220000E-01
1.5076000E+03	6.8008000E-01	2.4628000E-01	1.6749000E-01	8.4780000E-01
1.5077000E+03	6.8484000E-01	2.4611000E-01	1.6854000E-01	8.5316000E-01
1.5078000E+03	6.8940000E-01	2.4594000E-01	1.6955000E-01	8.5825000E-01
1.5079000E+03	6.9377000E-01	2.4577000E-01	1.7051000E-01	8.6310000E-01
1.5080000E+03	6.9794000E-01	2.4561000E-01	1.7142000E-01	8.6770000E-01
1.5081000E+03	7.0192000E-01	2.4547000E-01	1.7230000E-01	8.7216000E-01
1.5082000E+03	7.0571000E-01	2.4533000E-01	1.7313000E-01	8.7638000E-01
1.5083000E+03	7.0932000E-01	2.4519000E-01	1.7392000E-01	8.8037000E-01
1.5084000E+03	7.1274000E-01	2.4506000E-01	1.7466000E-01	8.8412000E-01
1.5085000E+03	7.1599000E-01	2.4503000E-01	1.7543000E-01	8.8803000E-01
1.5086000E+03	7.1906000E-01	2.4504000E-01	1.7620000E-01	8.9189000E-01
1.5087000E+03	7.2196000E-01	2.4505000E-01	1.7692000E-01	8.9554000E-01
1.5088000E+03	7.2471000E-01	2.4507000E-01	1.7760000E-01	8.9900000E-01
1.5089000E+03	7.2730000E-01	2.4508000E-01	1.7825000E-01	9.0226000E-01
1.5090000E+03	7.2975000E-01	2.4509000E-01	1.7886000E-01	9.0535000E-01
1.5091000E+03	7.3206000E-01	2.4511000E-01	1.7943000E-01	9.0827000E-01
1.5092000E+03	7.3424000E-01	2.4512000E-01	1.7998000E-01	9.1102000E-01
1.5093000E+03	7.3629000E-01	2.4513000E-01	1.8049000E-01	9.1363000E-01
1.5094000E+03	7.3824000E-01	2.4515000E-01	1.8098000E-01	9.1609000E-01
1.5095000E+03	7.4007000E-01	2.4516000E-01	1.8144000E-01	9.1842000E-01
1.5096000E+03	7.4181000E-01	2.4518000E-01	1.8187000E-01	9.2063000E-01
1.5097000E+03	7.4346000E-01	2.4519000E-01	1.8229000E-01	9.2272000E-01
1.5098000E+03	7.4501000E-01	2.4520000E-01	1.8268000E-01	9.2470000E-01
1.5099000E+03	7.4649000E-01	2.4522000E-01	1.8305000E-01	9.2658000E-01
1.5100000E+03	7.4790000E-01	2.4523000E-01	1.8340000E-01	9.2837000E-01
1.5101000E+03	7.4923000E-01	2.4521000E-01	1.8372000E-01	9.2997000E-01
1.5102000E+03	7.5050000E-01	2.4519000E-01	1.8402000E-01	9.3147000E-01
1.5103000E+03	7.5170000E-01	2.4518000E-01	1.8430000E-01	9.3290000E-01
1.5104000E+03	7.5285000E-01	2.4519000E-01	1.8459000E-01	9.3439000E-01

1.5105000E+03	7.5394000E-01	2.4526000E-01	1.8491000E-01	9.3601000E-01
1.5106000E+03	7.5498000E-01	2.4533000E-01	1.8522000E-01	9.3756000E-01
1.5107000E+03	7.5597000E-01	2.4540000E-01	1.8551000E-01	9.3905000E-01
1.5108000E+03	7.5691000E-01	2.4547000E-01	1.8580000E-01	9.4048000E-01
1.5109000E+03	7.5779000E-01	2.4554000E-01	1.8606000E-01	9.4184000E-01
1.5110000E+03	7.5863000E-01	2.4560000E-01	1.8632000E-01	9.4314000E-01
1.5111000E+03	7.5942000E-01	2.4567000E-01	1.8657000E-01	9.4439000E-01
1.5112000E+03	7.6017000E-01	2.4574000E-01	1.8680000E-01	9.4558000E-01
1.5113000E+03	7.6087000E-01	2.4581000E-01	1.8703000E-01	9.4671000E-01
1.5114000E+03	7.6152000E-01	2.4588000E-01	1.8724000E-01	9.4779000E-01
1.5115000E+03	7.6213000E-01	2.4594000E-01	1.8744000E-01	9.4881000E-01
1.5116000E+03	7.6271000E-01	2.4601000E-01	1.8763000E-01	9.4978000E-01
1.5117000E+03	7.6324000E-01	2.4608000E-01	1.8781000E-01	9.5070000E-01
1.5118000E+03	7.6373000E-01	2.4614000E-01	1.8799000E-01	9.5157000E-01
1.5119000E+03	7.6419000E-01	2.4621000E-01	1.8815000E-01	9.5240000E-01
1.5120000E+03	7.6461000E-01	2.4628000E-01	1.8831000E-01	9.5318000E-01
1.5121000E+03	7.6501000E-01	2.4637000E-01	1.8847000E-01	9.5403000E-01
1.5122000E+03	7.6538000E-01	2.4646000E-01	1.8863000E-01	9.5484000E-01
1.5123000E+03	7.6573000E-01	2.4654000E-01	1.8878000E-01	9.5559000E-01
1.5124000E+03	7.6607000E-01	2.4653000E-01	1.8886000E-01	9.5597000E-01
1.5125000E+03	7.6639000E-01	2.4652000E-01	1.8893000E-01	9.5633000E-01
1.5126000E+03	7.6669000E-01	2.4651000E-01	1.8900000E-01	9.5668000E-01
1.5127000E+03	7.6700000E-01	2.4650000E-01	1.8906000E-01	9.5702000E-01
1.5128000E+03	7.6730000E-01	2.4649000E-01	1.8913000E-01	9.5735000E-01
1.5129000E+03	7.6760000E-01	2.4648000E-01	1.8919000E-01	9.5768000E-01
1.5130000E+03	7.6790000E-01	2.4647000E-01	1.8926000E-01	9.5802000E-01
1.5131000E+03	7.6821000E-01	2.4645000E-01	1.8933000E-01	9.5836000E-01
1.5132000E+03	7.6853000E-01	2.4644000E-01	1.8940000E-01	9.5870000E-01
1.5133000E+03	7.6886000E-01	2.4642000E-01	1.8947000E-01	9.5906000E-01
1.5134000E+03	7.6920000E-01	2.4641000E-01	1.8954000E-01	9.5943000E-01
1.5135000E+03	7.6955000E-01	2.4640000E-01	1.8961000E-01	9.5981000E-01
1.5136000E+03	7.6991000E-01	2.4638000E-01	1.8969000E-01	9.6020000E-01
1.5137000E+03	7.7028000E-01	2.4637000E-01	1.8977000E-01	9.6060000E-01
1.5138000E+03	7.7066000E-01	2.4635000E-01	1.8985000E-01	9.6102000E-01
1.5139000E+03	7.7104000E-01	2.4634000E-01	1.8994000E-01	9.6143000E-01
1.5140000E+03	7.7142000E-01	2.4632000E-01	1.9002000E-01	9.6185000E-01
1.5141000E+03	7.7180000E-01	2.4635000E-01	1.9014000E-01	9.6245000E-01
1.5142000E+03	7.7218000E-01	2.4639000E-01	1.9025000E-01	9.6304000E-01
1.5143000E+03	7.7254000E-01	2.4627000E-01	1.9025000E-01	9.6303000E-01
1.5144000E+03	7.7289000E-01	2.4611000E-01	1.9022000E-01	9.6285000E-01
1.5145000E+03	7.7321000E-01	2.4596000E-01	1.9018000E-01	9.6265000E-01
1.5146000E+03	7.7351000E-01	2.4580000E-01	1.9013000E-01	9.6241000E-01
1.5147000E+03	7.7379000E-01	2.4564000E-01	1.9008000E-01	9.6214000E-01

1.5148000E+03	7.7403000E-01	2.4549000E-01	1.9001000E-01	9.6183000E-01
1.5149000E+03	7.7423000E-01	2.4533000E-01	1.8994000E-01	9.6147000E-01
1.5150000E+03	7.7439000E-01	2.4518000E-01	1.8986000E-01	9.6107000E-01
1.5151000E+03	7.7452000E-01	2.4502000E-01	1.8977000E-01	9.6061000E-01
1.5152000E+03	7.7460000E-01	2.4486000E-01	1.8967000E-01	9.6009000E-01
1.5153000E+03	7.7464000E-01	2.4470000E-01	1.8956000E-01	9.5952000E-01
1.5154000E+03	7.7464000E-01	2.4455000E-01	1.8944000E-01	9.5890000E-01
1.5155000E+03	7.7460000E-01	2.4439000E-01	1.8930000E-01	9.5823000E-01
1.5156000E+03	7.7452000E-01	2.4423000E-01	1.8916000E-01	9.5752000E-01
1.5157000E+03	7.7441000E-01	2.4407000E-01	1.8901000E-01	9.5676000E-01
1.5158000E+03	7.7427000E-01	2.4392000E-01	1.8886000E-01	9.5597000E-01
1.5159000E+03	7.7410000E-01	2.4376000E-01	1.8869000E-01	9.5515000E-01
1.5160000E+03	7.7392000E-01	2.4360000E-01	1.8853000E-01	9.5430000E-01
1.5161000E+03	7.7372000E-01	2.4342000E-01	1.8834000E-01	9.5335000E-01
1.5162000E+03	7.7352000E-01	2.4319000E-01	1.8811000E-01	9.5221000E-01
1.5163000E+03	7.7332000E-01	2.4292000E-01	1.8785000E-01	9.5090000E-01
1.5164000E+03	7.7313000E-01	2.4265000E-01	1.8760000E-01	9.4959000E-01
1.5165000E+03	7.7295000E-01	2.4237000E-01	1.8734000E-01	9.4830000E-01
1.5166000E+03	7.7279000E-01	2.4210000E-01	1.8709000E-01	9.4704000E-01
1.5167000E+03	7.7266000E-01	2.4183000E-01	1.8685000E-01	9.4582000E-01
1.5168000E+03	7.7257000E-01	2.4155000E-01	1.8662000E-01	9.4463000E-01
1.5169000E+03	7.7251000E-01	2.4128000E-01	1.8639000E-01	9.4349000E-01
1.5170000E+03	7.7249000E-01	2.4101000E-01	1.8618000E-01	9.4240000E-01
1.5171000E+03	7.7251000E-01	2.4074000E-01	1.8597000E-01	9.4137000E-01
1.5172000E+03	7.7258000E-01	2.4047000E-01	1.8578000E-01	9.4039000E-01
1.5173000E+03	7.7269000E-01	2.4020000E-01	1.8560000E-01	9.3947000E-01
1.5174000E+03	7.7284000E-01	2.3993000E-01	1.8542000E-01	9.3860000E-01
1.5175000E+03	7.7303000E-01	2.3966000E-01	1.8526000E-01	9.3777000E-01
1.5176000E+03	7.7325000E-01	2.3939000E-01	1.8511000E-01	9.3699000E-01
1.5177000E+03	7.7350000E-01	2.3912000E-01	1.8496000E-01	9.3624000E-01
1.5178000E+03	7.7378000E-01	2.3885000E-01	1.8482000E-01	9.3551000E-01
1.5179000E+03	7.7407000E-01	2.3858000E-01	1.8468000E-01	9.3481000E-01
1.5180000E+03	7.7437000E-01	2.3831000E-01	1.8454000E-01	9.3411000E-01
1.5181000E+03	7.7466000E-01	2.3811000E-01	1.8445000E-01	9.3368000E-01
1.5182000E+03	7.7495000E-01	2.3793000E-01	1.8438000E-01	9.3334000E-01
1.5183000E+03	7.7521000E-01	2.3776000E-01	1.8431000E-01	9.3296000E-01
1.5184000E+03	7.7544000E-01	2.3758000E-01	1.8423000E-01	9.3255000E-01
1.5185000E+03	7.7563000E-01	2.3741000E-01	1.8414000E-01	9.3209000E-01
1.5186000E+03	7.7577000E-01	2.3723000E-01	1.8404000E-01	9.3157000E-01
1.5187000E+03	7.7585000E-01	2.3705000E-01	1.8392000E-01	9.3098000E-01
1.5188000E+03	7.7587000E-01	2.3688000E-01	1.8379000E-01	9.3031000E-01
1.5189000E+03	7.7581000E-01	2.3670000E-01	1.8364000E-01	9.2955000E-01
1.5190000E+03	7.7568000E-01	2.3653000E-01	1.8347000E-01	9.2871000E-01

1.5191000E+03	7.7547000E-01	2.3635000E-01	1.8328000E-01	9.2777000E-01
1.5192000E+03	7.7517000E-01	2.3618000E-01	1.8308000E-01	9.2673000E-01
1.5193000E+03	7.7480000E-01	2.3600000E-01	1.8285000E-01	9.2559000E-01
1.5194000E+03	7.7434000E-01	2.3583000E-01	1.8261000E-01	9.2435000E-01
1.5195000E+03	7.7381000E-01	2.3565000E-01	1.8235000E-01	9.2303000E-01
1.5196000E+03	7.7320000E-01	2.3548000E-01	1.8207000E-01	9.2162000E-01
1.5197000E+03	7.7252000E-01	2.3530000E-01	1.8178000E-01	9.2013000E-01
1.5198000E+03	7.7179000E-01	2.3513000E-01	1.8147000E-01	9.1858000E-01
1.5199000E+03	7.7101000E-01	2.3495000E-01	1.8115000E-01	9.1696000E-01
1.5200000E+03	7.7018000E-01	2.3478000E-01	1.8082000E-01	9.1531000E-01
1.5201000E+03	7.6933000E-01	2.3473000E-01	1.8058000E-01	9.1409000E-01
1.5202000E+03	7.6847000E-01	2.3467000E-01	1.8034000E-01	9.1286000E-01
1.5203000E+03	7.6760000E-01	2.3462000E-01	1.8010000E-01	9.1162000E-01
1.5204000E+03	7.6674000E-01	2.3457000E-01	1.7985000E-01	9.1040000E-01
1.5205000E+03	7.6591000E-01	2.3452000E-01	1.7962000E-01	9.0920000E-01
1.5206000E+03	7.6510000E-01	2.3446000E-01	1.7939000E-01	9.0805000E-01
1.5207000E+03	7.6435000E-01	2.3441000E-01	1.7917000E-01	9.0695000E-01
1.5208000E+03	7.6365000E-01	2.3436000E-01	1.7897000E-01	9.0592000E-01
1.5209000E+03	7.6302000E-01	2.3431000E-01	1.7878000E-01	9.0497000E-01
1.5210000E+03	7.6247000E-01	2.3426000E-01	1.7861000E-01	9.0412000E-01
1.5211000E+03	7.6200000E-01	2.3420000E-01	1.7846000E-01	9.0335000E-01
1.5212000E+03	7.6162000E-01	2.3415000E-01	1.7833000E-01	9.0269000E-01
1.5213000E+03	7.6134000E-01	2.3409000E-01	1.7822000E-01	9.0214000E-01
1.5214000E+03	7.6114000E-01	2.3404000E-01	1.7813000E-01	9.0170000E-01
1.5215000E+03	7.6105000E-01	2.3398000E-01	1.7807000E-01	9.0138000E-01
1.5216000E+03	7.6105000E-01	2.3393000E-01	1.7803000E-01	9.0117000E-01
1.5217000E+03	7.6114000E-01	2.3387000E-01	1.7801000E-01	9.0107000E-01
1.5218000E+03	7.6131000E-01	2.3382000E-01	1.7801000E-01	9.0107000E-01
1.5219000E+03	7.6157000E-01	2.3377000E-01	1.7803000E-01	9.0117000E-01
1.5220000E+03	7.6190000E-01	2.3379000E-01	1.7813000E-01	9.0166000E-01
1.5221000E+03	7.6229000E-01	2.3393000E-01	1.7832000E-01	9.0266000E-01
1.5222000E+03	7.6274000E-01	2.3407000E-01	1.7853000E-01	9.0372000E-01
1.5223000E+03	7.6322000E-01	2.3421000E-01	1.7875000E-01	9.0483000E-01
1.5224000E+03	7.6374000E-01	2.3435000E-01	1.7898000E-01	9.0598000E-01
1.5225000E+03	7.6428000E-01	2.3449000E-01	1.7921000E-01	9.0715000E-01
1.5226000E+03	7.6482000E-01	2.3463000E-01	1.7945000E-01	9.0834000E-01
1.5227000E+03	7.6536000E-01	2.3476000E-01	1.7968000E-01	9.0952000E-01
1.5228000E+03	7.6589000E-01	2.3490000E-01	1.7991000E-01	9.1069000E-01
1.5229000E+03	7.6640000E-01	2.3504000E-01	1.8014000E-01	9.1183000E-01
1.5230000E+03	7.6687000E-01	2.3518000E-01	1.8035000E-01	9.1293000E-01
1.5231000E+03	7.6730000E-01	2.3532000E-01	1.8056000E-01	9.1398000E-01
1.5232000E+03	7.6769000E-01	2.3546000E-01	1.8076000E-01	9.1499000E-01
1.5233000E+03	7.6802000E-01	2.3560000E-01	1.8095000E-01	9.1593000E-01

1.5234000E+03	7.6830000E-01	2.3574000E-01	1.8112000E-01	9.1680000E-01
1.5235000E+03	7.6853000E-01	2.3588000E-01	1.8128000E-01	9.1761000E-01
1.5236000E+03	7.6869000E-01	2.3602000E-01	1.8142000E-01	9.1835000E-01
1.5237000E+03	7.6880000E-01	2.3616000E-01	1.8156000E-01	9.1902000E-01
1.5238000E+03	7.6885000E-01	2.3630000E-01	1.8168000E-01	9.1963000E-01
1.5239000E+03	7.6885000E-01	2.3647000E-01	1.8181000E-01	9.2029000E-01
1.5240000E+03	7.6881000E-01	2.3668000E-01	1.8196000E-01	9.2106000E-01
1.5241000E+03	7.6873000E-01	2.3686000E-01	1.8208000E-01	9.2168000E-01
1.5242000E+03	7.6862000E-01	2.3704000E-01	1.8220000E-01	9.2226000E-01
1.5243000E+03	7.6848000E-01	2.3723000E-01	1.8231000E-01	9.2281000E-01
1.5244000E+03	7.6833000E-01	2.3741000E-01	1.8241000E-01	9.2334000E-01
1.5245000E+03	7.6817000E-01	2.3760000E-01	1.8251000E-01	9.2387000E-01
1.5246000E+03	7.6801000E-01	2.3778000E-01	1.8262000E-01	9.2439000E-01
1.5247000E+03	7.6786000E-01	2.3796000E-01	1.8272000E-01	9.2492000E-01
1.5248000E+03	7.6772000E-01	2.3815000E-01	1.8283000E-01	9.2548000E-01
1.5249000E+03	7.6762000E-01	2.3833000E-01	1.8295000E-01	9.2606000E-01
1.5250000E+03	7.6754000E-01	2.3852000E-01	1.8307000E-01	9.2668000E-01
1.5251000E+03	7.6751000E-01	2.3870000E-01	1.8320000E-01	9.2735000E-01
1.5252000E+03	7.6752000E-01	2.3888000E-01	1.8334000E-01	9.2807000E-01
1.5253000E+03	7.6758000E-01	2.3906000E-01	1.8350000E-01	9.2885000E-01
1.5254000E+03	7.6769000E-01	2.3924000E-01	1.8366000E-01	9.2969000E-01
1.5255000E+03	7.6785000E-01	2.3942000E-01	1.8384000E-01	9.3059000E-01
1.5256000E+03	7.6807000E-01	2.3961000E-01	1.8403000E-01	9.3156000E-01
1.5257000E+03	7.6835000E-01	2.3979000E-01	1.8424000E-01	9.3260000E-01
1.5258000E+03	7.6867000E-01	2.3997000E-01	1.8446000E-01	9.3370000E-01
1.5259000E+03	7.6905000E-01	2.4014000E-01	1.8468000E-01	9.3483000E-01
1.5260000E+03	7.6947000E-01	2.4032000E-01	1.8492000E-01	9.3603000E-01
1.5261000E+03	7.6994000E-01	2.4051000E-01	1.8518000E-01	9.3737000E-01
1.5262000E+03	7.7045000E-01	2.4071000E-01	1.8546000E-01	9.3876000E-01
1.5263000E+03	7.7099000E-01	2.4091000E-01	1.8574000E-01	9.4019000E-01
1.5264000E+03	7.7155000E-01	2.4111000E-01	1.8603000E-01	9.4165000E-01
1.5265000E+03	7.7214000E-01	2.4131000E-01	1.8632000E-01	9.4314000E-01
1.5266000E+03	7.7274000E-01	2.4150000E-01	1.8662000E-01	9.4465000E-01
1.5267000E+03	7.7335000E-01	2.4170000E-01	1.8692000E-01	9.4617000E-01
1.5268000E+03	7.7397000E-01	2.4190000E-01	1.8722000E-01	9.4769000E-01
1.5269000E+03	7.7459000E-01	2.4209000E-01	1.8752000E-01	9.4922000E-01
1.5270000E+03	7.7520000E-01	2.4229000E-01	1.8782000E-01	9.5074000E-01
1.5271000E+03	7.7579000E-01	2.4248000E-01	1.8812000E-01	9.5223000E-01
1.5272000E+03	7.7638000E-01	2.4268000E-01	1.8841000E-01	9.5371000E-01
1.5273000E+03	7.7695000E-01	2.4287000E-01	1.8870000E-01	9.5516000E-01
1.5274000E+03	7.7750000E-01	2.4306000E-01	1.8898000E-01	9.5659000E-01
1.5275000E+03	7.7803000E-01	2.4325000E-01	1.8926000E-01	9.5800000E-01
1.5276000E+03	7.7855000E-01	2.4344000E-01	1.8953000E-01	9.5938000E-01

1.5277000E+03	7.7904000E-01	2.4363000E-01	1.8980000E-01	9.6074000E-01
1.5278000E+03	7.7951000E-01	2.4377000E-01	1.9003000E-01	9.6189000E-01
1.5279000E+03	7.7997000E-01	2.4390000E-01	1.9024000E-01	9.6296000E-01
1.5280000E+03	7.8041000E-01	2.4403000E-01	1.9045000E-01	9.6402000E-01
1.5281000E+03	7.8084000E-01	2.4419000E-01	1.9067000E-01	9.6516000E-01
1.5282000E+03	7.8127000E-01	2.4434000E-01	1.9090000E-01	9.6630000E-01
1.5283000E+03	7.8168000E-01	2.4450000E-01	1.9112000E-01	9.6742000E-01
1.5284000E+03	7.8210000E-01	2.4465000E-01	1.9134000E-01	9.6854000E-01
1.5285000E+03	7.8251000E-01	2.4480000E-01	1.9156000E-01	9.6967000E-01
1.5286000E+03	7.8293000E-01	2.4496000E-01	1.9178000E-01	9.7079000E-01
1.5287000E+03	7.8336000E-01	2.4511000E-01	1.9201000E-01	9.7193000E-01
1.5288000E+03	7.8380000E-01	2.4526000E-01	1.9224000E-01	9.7307000E-01
1.5289000E+03	7.8425000E-01	2.4541000E-01	1.9246000E-01	9.7424000E-01
1.5290000E+03	7.8472000E-01	2.4556000E-01	1.9270000E-01	9.7542000E-01
1.5291000E+03	7.8521000E-01	2.4571000E-01	1.9293000E-01	9.7661000E-01
1.5292000E+03	7.8571000E-01	2.4586000E-01	1.9318000E-01	9.7783000E-01
1.5293000E+03	7.8624000E-01	2.4601000E-01	1.9342000E-01	9.7907000E-01
1.5294000E+03	7.8678000E-01	2.4616000E-01	1.9367000E-01	9.8033000E-01
1.5295000E+03	7.8734000E-01	2.4630000E-01	1.9392000E-01	9.8162000E-01
1.5296000E+03	7.8791000E-01	2.4645000E-01	1.9418000E-01	9.8292000E-01
1.5297000E+03	7.8851000E-01	2.4654000E-01	1.9440000E-01	9.8404000E-01
1.5298000E+03	7.8911000E-01	2.4659000E-01	1.9458000E-01	9.8497000E-01
1.5299000E+03	7.8973000E-01	2.4663000E-01	1.9477000E-01	9.8590000E-01
1.5300000E+03	7.9035000E-01	2.4667000E-01	1.9496000E-01	9.8685000E-01
1.5301000E+03	7.9098000E-01	2.4672000E-01	1.9515000E-01	9.8785000E-01
1.5302000E+03	7.9161000E-01	2.4678000E-01	1.9535000E-01	9.8884000E-01
1.5303000E+03	7.9223000E-01	2.4683000E-01	1.9555000E-01	9.8983000E-01
1.5304000E+03	7.9285000E-01	2.4688000E-01	1.9574000E-01	9.9081000E-01
1.5305000E+03	7.9345000E-01	2.4693000E-01	1.9593000E-01	9.9177000E-01
1.5306000E+03	7.9404000E-01	2.4698000E-01	1.9611000E-01	9.9271000E-01
1.5307000E+03	7.9461000E-01	2.4703000E-01	1.9630000E-01	9.9362000E-01
1.5308000E+03	7.9516000E-01	2.4708000E-01	1.9647000E-01	9.9451000E-01
1.5309000E+03	7.9568000E-01	2.4713000E-01	1.9664000E-01	9.9536000E-01
1.5310000E+03	7.9618000E-01	2.4718000E-01	1.9680000E-01	9.9617000E-01
1.5311000E+03	7.9664000E-01	2.4723000E-01	1.9695000E-01	9.9694000E-01
1.5312000E+03	7.9707000E-01	2.4727000E-01	1.9709000E-01	9.9767000E-01
1.5313000E+03	7.9747000E-01	2.4732000E-01	1.9723000E-01	9.9836000E-01
1.5314000E+03	7.9783000E-01	2.4737000E-01	1.9736000E-01	9.9899000E-01
1.5315000E+03	7.9816000E-01	2.4741000E-01	1.9747000E-01	9.9959000E-01
1.5316000E+03	7.9844000E-01	2.4742000E-01	1.9755000E-01	1.0000000E+00
1.5317000E+03	7.9870000E-01	2.4731000E-01	1.9752000E-01	9.9984000E-01
1.5318000E+03	7.9892000E-01	2.4719000E-01	1.9748000E-01	9.9964000E-01
1.5319000E+03	7.9911000E-01	2.4707000E-01	1.9744000E-01	9.9939000E-01

1.5320000E+03	7.9926000E-01	2.4695000E-01	1.9738000E-01	9.9911000E-01
1.5321000E+03	7.9938000E-01	2.4690000E-01	1.9737000E-01	9.9905000E-01
1.5322000E+03	7.9948000E-01	2.4685000E-01	1.9735000E-01	9.9896000E-01
1.5323000E+03	7.9955000E-01	2.4679000E-01	1.9732000E-01	9.9883000E-01
1.5324000E+03	7.9960000E-01	2.4674000E-01	1.9729000E-01	9.9868000E-01
1.5325000E+03	7.9963000E-01	2.4669000E-01	1.9726000E-01	9.9850000E-01
1.5326000E+03	7.9965000E-01	2.4663000E-01	1.9722000E-01	9.9829000E-01
1.5327000E+03	7.9965000E-01	2.4657000E-01	1.9717000E-01	9.9807000E-01
1.5328000E+03	7.9965000E-01	2.4652000E-01	1.9713000E-01	9.9784000E-01
1.5329000E+03	7.9963000E-01	2.4646000E-01	1.9708000E-01	9.9759000E-01
1.5330000E+03	7.9962000E-01	2.4641000E-01	1.9703000E-01	9.9735000E-01
1.5331000E+03	7.9961000E-01	2.4635000E-01	1.9698000E-01	9.9710000E-01
1.5332000E+03	7.9960000E-01	2.4629000E-01	1.9693000E-01	9.9686000E-01
1.5333000E+03	7.9960000E-01	2.4623000E-01	1.9689000E-01	9.9662000E-01
1.5334000E+03	7.9962000E-01	2.4617000E-01	1.9684000E-01	9.9640000E-01
1.5335000E+03	7.9964000E-01	2.4611000E-01	1.9680000E-01	9.9619000E-01
1.5336000E+03	7.9969000E-01	2.4592000E-01	1.9666000E-01	9.9547000E-01
1.5337000E+03	7.9975000E-01	2.4572000E-01	1.9651000E-01	9.9472000E-01
1.5338000E+03	7.9983000E-01	2.4551000E-01	1.9637000E-01	9.9398000E-01
1.5339000E+03	7.9993000E-01	2.4530000E-01	1.9623000E-01	9.9327000E-01
1.5340000E+03	8.0006000E-01	2.4509000E-01	1.9609000E-01	9.9259000E-01
1.5341000E+03	8.0021000E-01	2.4478000E-01	1.9588000E-01	9.9151000E-01
1.5342000E+03	8.0038000E-01	2.4447000E-01	1.9567000E-01	9.9046000E-01
1.5343000E+03	8.0058000E-01	2.4416000E-01	1.9547000E-01	9.8944000E-01
1.5344000E+03	8.0080000E-01	2.4385000E-01	1.9527000E-01	9.8845000E-01
1.5345000E+03	8.0103000E-01	2.4354000E-01	1.9508000E-01	9.8748000E-01
1.5346000E+03	8.0129000E-01	2.4323000E-01	1.9489000E-01	9.8653000E-01
1.5347000E+03	8.0156000E-01	2.4291000E-01	1.9471000E-01	9.8560000E-01
1.5348000E+03	8.0184000E-01	2.4260000E-01	1.9453000E-01	9.8468000E-01
1.5349000E+03	8.0213000E-01	2.4229000E-01	1.9435000E-01	9.8377000E-01
1.5350000E+03	8.0243000E-01	2.4198000E-01	1.9417000E-01	9.8287000E-01
1.5351000E+03	8.0272000E-01	2.4167000E-01	1.9399000E-01	9.8197000E-01
1.5352000E+03	8.0301000E-01	2.4136000E-01	1.9381000E-01	9.8105000E-01
1.5353000E+03	8.0329000E-01	2.4104000E-01	1.9363000E-01	9.8013000E-01
1.5354000E+03	8.0355000E-01	2.4073000E-01	1.9344000E-01	9.7918000E-01
1.5355000E+03	8.0379000E-01	2.4041000E-01	1.9324000E-01	9.7815000E-01
1.5356000E+03	8.0400000E-01	2.4008000E-01	1.9302000E-01	9.7705000E-01
1.5357000E+03	8.0417000E-01	2.3975000E-01	1.9280000E-01	9.7591000E-01
1.5358000E+03	8.0430000E-01	2.3941000E-01	1.9256000E-01	9.7471000E-01
1.5359000E+03	8.0438000E-01	2.3908000E-01	1.9231000E-01	9.7347000E-01
1.5360000E+03	8.0441000E-01	2.3875000E-01	1.9205000E-01	9.7215000E-01
1.5361000E+03	8.0437000E-01	2.3850000E-01	1.9184000E-01	9.7107000E-01
1.5362000E+03	8.0427000E-01	2.3824000E-01	1.9161000E-01	9.6991000E-01

1.5363000E+03	8.0411000E-01	2.3798000E-01	1.9136000E-01	9.6866000E-01
1.5364000E+03	8.0386000E-01	2.3773000E-01	1.9110000E-01	9.6733000E-01
1.5365000E+03	8.0354000E-01	2.3747000E-01	1.9082000E-01	9.6590000E-01
1.5366000E+03	8.0314000E-01	2.3721000E-01	1.9052000E-01	9.6438000E-01
1.5367000E+03	8.0266000E-01	2.3696000E-01	1.9020000E-01	9.6276000E-01
1.5368000E+03	8.0210000E-01	2.3670000E-01	1.8986000E-01	9.6104000E-01
1.5369000E+03	8.0145000E-01	2.3645000E-01	1.8950000E-01	9.5923000E-01
1.5370000E+03	8.0072000E-01	2.3619000E-01	1.8912000E-01	9.5732000E-01
1.5371000E+03	7.9992000E-01	2.3594000E-01	1.8873000E-01	9.5533000E-01
1.5372000E+03	7.9903000E-01	2.3568000E-01	1.8832000E-01	9.5325000E-01
1.5373000E+03	7.9807000E-01	2.3543000E-01	1.8789000E-01	9.5107000E-01
1.5374000E+03	7.9705000E-01	2.3522000E-01	1.8748000E-01	9.4902000E-01
1.5375000E+03	7.9596000E-01	2.3509000E-01	1.8712000E-01	9.4718000E-01
1.5376000E+03	7.9481000E-01	2.3495000E-01	1.8674000E-01	9.4528000E-01
1.5377000E+03	7.9362000E-01	2.3482000E-01	1.8636000E-01	9.4332000E-01
1.5378000E+03	7.9238000E-01	2.3469000E-01	1.8596000E-01	9.4131000E-01
1.5379000E+03	7.9111000E-01	2.3455000E-01	1.8556000E-01	9.3926000E-01
1.5380000E+03	7.8980000E-01	2.3442000E-01	1.8514000E-01	9.3718000E-01
1.5381000E+03	7.8848000E-01	2.3426000E-01	1.8471000E-01	9.3497000E-01
1.5382000E+03	7.8715000E-01	2.3410000E-01	1.8427000E-01	9.3275000E-01
1.5383000E+03	7.8582000E-01	2.3393000E-01	1.8383000E-01	9.3053000E-01
1.5384000E+03	7.8449000E-01	2.3377000E-01	1.8339000E-01	9.2832000E-01
1.5385000E+03	7.8317000E-01	2.3361000E-01	1.8296000E-01	9.2612000E-01
1.5386000E+03	7.8188000E-01	2.3345000E-01	1.8253000E-01	9.2395000E-01
1.5387000E+03	7.8060000E-01	2.3329000E-01	1.8211000E-01	9.2182000E-01
1.5388000E+03	7.7936000E-01	2.3313000E-01	1.8169000E-01	9.1972000E-01
1.5389000E+03	7.7815000E-01	2.3297000E-01	1.8129000E-01	9.1766000E-01
1.5390000E+03	7.7698000E-01	2.3281000E-01	1.8089000E-01	9.1565000E-01
1.5391000E+03	7.7585000E-01	2.3266000E-01	1.8050000E-01	9.1370000E-01
1.5392000E+03	7.7476000E-01	2.3250000E-01	1.8013000E-01	9.1179000E-01
1.5393000E+03	7.7372000E-01	2.3235000E-01	1.7978000E-01	9.1001000E-01
1.5394000E+03	7.7272000E-01	2.3237000E-01	1.7955000E-01	9.0887000E-01
1.5395000E+03	7.7176000E-01	2.3238000E-01	1.7934000E-01	9.0779000E-01
1.5396000E+03	7.7084000E-01	2.3239000E-01	1.7914000E-01	9.0676000E-01
1.5397000E+03	7.6997000E-01	2.3240000E-01	1.7894000E-01	9.0578000E-01
1.5398000E+03	7.6913000E-01	2.3241000E-01	1.7875000E-01	9.0483000E-01
1.5399000E+03	7.6832000E-01	2.3242000E-01	1.7857000E-01	9.0392000E-01
1.5400000E+03	7.6753000E-01	2.3243000E-01	1.7840000E-01	9.0305000E-01
1.5401000E+03	7.6678000E-01	2.3246000E-01	1.7824000E-01	9.0224000E-01
1.5402000E+03	7.6603000E-01	2.3248000E-01	1.7809000E-01	9.0145000E-01
1.5403000E+03	7.6530000E-01	2.3250000E-01	1.7793000E-01	9.0068000E-01
1.5404000E+03	7.6458000E-01	2.3252000E-01	1.7778000E-01	8.9991000E-01
1.5405000E+03	7.6385000E-01	2.3255000E-01	1.7763000E-01	8.9915000E-01

1.5406000E+03	7.6312000E-01	2.3257000E-01	1.7748000E-01	8.9838000E-01
1.5407000E+03	7.6238000E-01	2.3259000E-01	1.7732000E-01	8.9760000E-01
1.5408000E+03	7.6162000E-01	2.3262000E-01	1.7717000E-01	8.9680000E-01
1.5409000E+03	7.6085000E-01	2.3264000E-01	1.7700000E-01	8.9597000E-01
1.5410000E+03	7.6005000E-01	2.3266000E-01	1.7684000E-01	8.9512000E-01
1.5411000E+03	7.5922000E-01	2.3269000E-01	1.7666000E-01	8.9424000E-01
1.5412000E+03	7.5836000E-01	2.3271000E-01	1.7648000E-01	8.9331000E-01
1.5413000E+03	7.5747000E-01	2.3288000E-01	1.7639000E-01	8.9289000E-01
1.5414000E+03	7.5653000E-01	2.3308000E-01	1.7633000E-01	8.9256000E-01
1.5415000E+03	7.5556000E-01	2.3328000E-01	1.7625000E-01	8.9217000E-01
1.5416000E+03	7.5454000E-01	2.3348000E-01	1.7617000E-01	8.9174000E-01
1.5417000E+03	7.5348000E-01	2.3368000E-01	1.7607000E-01	8.9125000E-01
1.5418000E+03	7.5237000E-01	2.3388000E-01	1.7596000E-01	8.9071000E-01
1.5419000E+03	7.5122000E-01	2.3408000E-01	1.7584000E-01	8.9011000E-01
1.5420000E+03	7.5002000E-01	2.3428000E-01	1.7572000E-01	8.8945000E-01
1.5421000E+03	7.4877000E-01	2.3448000E-01	1.7557000E-01	8.8873000E-01
1.5422000E+03	7.4747000E-01	2.3468000E-01	1.7542000E-01	8.8794000E-01
1.5423000E+03	7.4612000E-01	2.3488000E-01	1.7525000E-01	8.8709000E-01
1.5424000E+03	7.4472000E-01	2.3508000E-01	1.7507000E-01	8.8617000E-01
1.5425000E+03	7.4328000E-01	2.3528000E-01	1.7488000E-01	8.8520000E-01
1.5426000E+03	7.4177000E-01	2.3548000E-01	1.7467000E-01	8.8416000E-01
1.5427000E+03	7.4022000E-01	2.3567000E-01	1.7445000E-01	8.8305000E-01
1.5428000E+03	7.3862000E-01	2.3587000E-01	1.7422000E-01	8.8188000E-01
1.5429000E+03	7.3696000E-01	2.3607000E-01	1.7398000E-01	8.8065000E-01
1.5430000E+03	7.3525000E-01	2.3627000E-01	1.7372000E-01	8.7934000E-01
1.5431000E+03	7.3348000E-01	2.3647000E-01	1.7345000E-01	8.7797000E-01
1.5432000E+03	7.3166000E-01	2.3675000E-01	1.7322000E-01	8.7682000E-01
1.5433000E+03	7.2978000E-01	2.3710000E-01	1.7303000E-01	8.7588000E-01
1.5434000E+03	7.2785000E-01	2.3746000E-01	1.7283000E-01	8.7487000E-01
1.5435000E+03	7.2587000E-01	2.3781000E-01	1.7262000E-01	8.7378000E-01
1.5436000E+03	7.2383000E-01	2.3817000E-01	1.7239000E-01	8.7263000E-01
1.5437000E+03	7.2174000E-01	2.3852000E-01	1.7215000E-01	8.7140000E-01
1.5438000E+03	7.1959000E-01	2.3888000E-01	1.7189000E-01	8.7010000E-01
1.5439000E+03	7.1739000E-01	2.3923000E-01	1.7162000E-01	8.6873000E-01
1.5440000E+03	7.1515000E-01	2.3958000E-01	1.7134000E-01	8.6730000E-01
1.5441000E+03	7.1286000E-01	2.3990000E-01	1.7101000E-01	8.6565000E-01
1.5442000E+03	7.1053000E-01	2.4021000E-01	1.7068000E-01	8.6395000E-01
1.5443000E+03	7.0816000E-01	2.4053000E-01	1.7033000E-01	8.6220000E-01
1.5444000E+03	7.0575000E-01	2.4084000E-01	1.6997000E-01	8.6039000E-01
1.5445000E+03	7.0332000E-01	2.4115000E-01	1.6961000E-01	8.5853000E-01
1.5446000E+03	7.0086000E-01	2.4147000E-01	1.6923000E-01	8.5664000E-01
1.5447000E+03	6.9838000E-01	2.4178000E-01	1.6885000E-01	8.5471000E-01
1.5448000E+03	6.9589000E-01	2.4209000E-01	1.6847000E-01	8.5277000E-01

1.5449000E+03	6.9339000E-01	2.4240000E-01	1.6808000E-01	8.5080000E-01
1.5450000E+03	6.9089000E-01	2.4272000E-01	1.6769000E-01	8.4883000E-01
1.5451000E+03	6.8840000E-01	2.4303000E-01	1.6730000E-01	8.4687000E-01
1.5452000E+03	6.8591000E-01	2.4337000E-01	1.6693000E-01	8.4500000E-01
1.5453000E+03	6.8345000E-01	2.4371000E-01	1.6657000E-01	8.4314000E-01
1.5454000E+03	6.8101000E-01	2.4405000E-01	1.6620000E-01	8.4130000E-01
1.5455000E+03	6.7859000E-01	2.4440000E-01	1.6584000E-01	8.3949000E-01
1.5456000E+03	6.7621000E-01	2.4473000E-01	1.6549000E-01	8.3770000E-01
1.5457000E+03	6.7387000E-01	2.4507000E-01	1.6515000E-01	8.3596000E-01
1.5458000E+03	6.7156000E-01	2.4541000E-01	1.6481000E-01	8.3425000E-01
1.5459000E+03	6.6930000E-01	2.4575000E-01	1.6448000E-01	8.3259000E-01
1.5460000E+03	6.6708000E-01	2.4609000E-01	1.6416000E-01	8.3098000E-01
1.5461000E+03	6.6491000E-01	2.4640000E-01	1.6384000E-01	8.2932000E-01
1.5462000E+03	6.6278000E-01	2.4671000E-01	1.6352000E-01	8.2771000E-01
1.5463000E+03	6.6070000E-01	2.4703000E-01	1.6321000E-01	8.2615000E-01
1.5464000E+03	6.5867000E-01	2.4734000E-01	1.6291000E-01	8.2464000E-01
1.5465000E+03	6.5667000E-01	2.4764000E-01	1.6262000E-01	8.2317000E-01
1.5466000E+03	6.5472000E-01	2.4795000E-01	1.6234000E-01	8.2174000E-01
1.5467000E+03	6.5280000E-01	2.4826000E-01	1.6207000E-01	8.2036000E-01
1.5468000E+03	6.5092000E-01	2.4857000E-01	1.6180000E-01	8.1901000E-01
1.5469000E+03	6.4906000E-01	2.4888000E-01	1.6154000E-01	8.1769000E-01
1.5470000E+03	6.4723000E-01	2.4919000E-01	1.6128000E-01	8.1639000E-01
1.5471000E+03	6.4542000E-01	2.4938000E-01	1.6095000E-01	8.1473000E-01
1.5472000E+03	6.4363000E-01	2.4955000E-01	1.6062000E-01	8.1305000E-01
1.5473000E+03	6.4186000E-01	2.4973000E-01	1.6029000E-01	8.1139000E-01
1.5474000E+03	6.4010000E-01	2.4991000E-01	1.5997000E-01	8.0973000E-01
1.5475000E+03	6.3836000E-01	2.5008000E-01	1.5964000E-01	8.0808000E-01
1.5476000E+03	6.3662000E-01	2.5026000E-01	1.5932000E-01	8.0645000E-01
1.5477000E+03	6.3489000E-01	2.5043000E-01	1.5900000E-01	8.0482000E-01
1.5478000E+03	6.3317000E-01	2.5060000E-01	1.5868000E-01	8.0320000E-01
1.5479000E+03	6.3147000E-01	2.5078000E-01	1.5836000E-01	8.0159000E-01
1.5480000E+03	6.2977000E-01	2.5095000E-01	1.5804000E-01	7.9999000E-01
1.5481000E+03	6.2810000E-01	2.5112000E-01	1.5773000E-01	7.9839000E-01
1.5482000E+03	6.2645000E-01	2.5128000E-01	1.5742000E-01	7.9682000E-01
1.5483000E+03	6.2483000E-01	2.5145000E-01	1.5711000E-01	7.9528000E-01
1.5484000E+03	6.2325000E-01	2.5161000E-01	1.5681000E-01	7.9378000E-01
1.5485000E+03	6.2170000E-01	2.5177000E-01	1.5653000E-01	7.9233000E-01
1.5486000E+03	6.2021000E-01	2.5194000E-01	1.5625000E-01	7.9094000E-01
1.5487000E+03	6.1878000E-01	2.5210000E-01	1.5599000E-01	7.8963000E-01
1.5488000E+03	6.1742000E-01	2.5226000E-01	1.5575000E-01	7.8840000E-01
1.5489000E+03	6.1614000E-01	2.5242000E-01	1.5553000E-01	7.8727000E-01
1.5490000E+03	6.1495000E-01	2.5245000E-01	1.5524000E-01	7.8581000E-01
1.5491000E+03	6.1385000E-01	2.5237000E-01	1.5492000E-01	7.8418000E-01

1.5492000E+03	6.1286000E-01	2.5230000E-01	1.5462000E-01	7.8269000E-01
1.5493000E+03	6.1199000E-01	2.5223000E-01	1.5436000E-01	7.8135000E-01
1.5494000E+03	6.1124000E-01	2.5215000E-01	1.5413000E-01	7.8017000E-01
1.5495000E+03	6.1063000E-01	2.5208000E-01	1.5393000E-01	7.7916000E-01
1.5496000E+03	6.1015000E-01	2.5200000E-01	1.5376000E-01	7.7832000E-01
1.5497000E+03	6.0982000E-01	2.5193000E-01	1.5363000E-01	7.7766000E-01
1.5498000E+03	6.0963000E-01	2.5185000E-01	1.5354000E-01	7.7719000E-01
1.5499000E+03	6.0960000E-01	2.5178000E-01	1.5348000E-01	7.7692000E-01
1.5500000E+03	6.0972000E-01	2.5170000E-01	1.5347000E-01	7.7683000E-01
1.5501000E+03	6.0999000E-01	2.5158000E-01	1.5346000E-01	7.7682000E-01
1.5502000E+03	6.1042000E-01	2.5147000E-01	1.5350000E-01	7.7700000E-01
1.5503000E+03	6.1100000E-01	2.5135000E-01	1.5357000E-01	7.7737000E-01
1.5504000E+03	6.1172000E-01	2.5123000E-01	1.5368000E-01	7.7793000E-01
1.5505000E+03	6.1259000E-01	2.5111000E-01	1.5383000E-01	7.7867000E-01
1.5506000E+03	6.1360000E-01	2.5100000E-01	1.5401000E-01	7.7958000E-01
1.5507000E+03	6.1474000E-01	2.5088000E-01	1.5422000E-01	7.8066000E-01
1.5508000E+03	6.1600000E-01	2.5076000E-01	1.5447000E-01	7.8190000E-01
1.5509000E+03	6.1739000E-01	2.5057000E-01	1.5470000E-01	7.8307000E-01
1.5510000E+03	6.1888000E-01	2.5022000E-01	1.5486000E-01	7.8386000E-01
1.5511000E+03	6.2047000E-01	2.4987000E-01	1.5504000E-01	7.8478000E-01
1.5512000E+03	6.2216000E-01	2.4952000E-01	1.5524000E-01	7.8580000E-01
1.5513000E+03	6.2394000E-01	2.4916000E-01	1.5546000E-01	7.8693000E-01
1.5514000E+03	6.2579000E-01	2.4881000E-01	1.5570000E-01	7.8815000E-01
1.5515000E+03	6.2771000E-01	2.4846000E-01	1.5596000E-01	7.8945000E-01
1.5516000E+03	6.2968000E-01	2.4811000E-01	1.5623000E-01	7.9082000E-01
1.5517000E+03	6.3171000E-01	2.4776000E-01	1.5651000E-01	7.9224000E-01
1.5518000E+03	6.3379000E-01	2.4740000E-01	1.5680000E-01	7.9371000E-01
1.5519000E+03	6.3590000E-01	2.4705000E-01	1.5710000E-01	7.9522000E-01
1.5520000E+03	6.3803000E-01	2.4670000E-01	1.5740000E-01	7.9675000E-01
1.5521000E+03	6.4020000E-01	2.4637000E-01	1.5773000E-01	7.9839000E-01
1.5522000E+03	6.4237000E-01	2.4605000E-01	1.5805000E-01	8.0004000E-01
1.5523000E+03	6.4455000E-01	2.4572000E-01	1.5838000E-01	8.0170000E-01
1.5524000E+03	6.4673000E-01	2.4539000E-01	1.5870000E-01	8.0334000E-01
1.5525000E+03	6.4890000E-01	2.4507000E-01	1.5902000E-01	8.0497000E-01
1.5526000E+03	6.5106000E-01	2.4474000E-01	1.5934000E-01	8.0657000E-01
1.5527000E+03	6.5320000E-01	2.4441000E-01	1.5965000E-01	8.0813000E-01
1.5528000E+03	6.5530000E-01	2.4407000E-01	1.5994000E-01	8.0960000E-01
1.5529000E+03	6.5735000E-01	2.4363000E-01	1.6015000E-01	8.1067000E-01
1.5530000E+03	6.5935000E-01	2.4319000E-01	1.6035000E-01	8.1166000E-01
1.5531000E+03	6.6128000E-01	2.4275000E-01	1.6052000E-01	8.1255000E-01
1.5532000E+03	6.6314000E-01	2.4230000E-01	1.6068000E-01	8.1334000E-01
1.5533000E+03	6.6489000E-01	2.4186000E-01	1.6081000E-01	8.1400000E-01
1.5534000E+03	6.6654000E-01	2.4141000E-01	1.6091000E-01	8.1452000E-01

1.5535000E+03	6.6805000E-01	2.4097000E-01	1.6098000E-01	8.1487000E-01
1.5536000E+03	6.6942000E-01	2.4053000E-01	1.6101000E-01	8.1503000E-01
1.5537000E+03	6.7062000E-01	2.4009000E-01	1.6101000E-01	8.1499000E-01
1.5538000E+03	6.7163000E-01	2.3964000E-01	1.6095000E-01	8.1472000E-01
1.5539000E+03	6.7242000E-01	2.3920000E-01	1.6085000E-01	8.1418000E-01
1.5540000E+03	6.7299000E-01	2.3876000E-01	1.6068000E-01	8.1336000E-01
1.5541000E+03	6.7330000E-01	2.3830000E-01	1.6044000E-01	8.1215000E-01
1.5542000E+03	6.7332000E-01	2.3784000E-01	1.6014000E-01	8.1061000E-01
1.5543000E+03	6.7304000E-01	2.3737000E-01	1.5976000E-01	8.0869000E-01
1.5544000E+03	6.7243000E-01	2.3691000E-01	1.5931000E-01	8.0639000E-01
1.5545000E+03	6.7147000E-01	2.3645000E-01	1.5877000E-01	8.0366000E-01
1.5546000E+03	6.7013000E-01	2.3599000E-01	1.5814000E-01	8.0050000E-01
1.5547000E+03	6.6840000E-01	2.3553000E-01	1.5742000E-01	7.9687000E-01
1.5548000E+03	6.6625000E-01	2.3511000E-01	1.5664000E-01	7.9292000E-01
1.5549000E+03	6.6366000E-01	2.3472000E-01	1.5577000E-01	7.8850000E-01
1.5550000E+03	6.6063000E-01	2.3432000E-01	1.5480000E-01	7.8356000E-01
1.5551000E+03	6.5713000E-01	2.3392000E-01	1.5372000E-01	7.7809000E-01
1.5552000E+03	6.5316000E-01	2.3352000E-01	1.5253000E-01	7.7208000E-01
1.5553000E+03	6.4870000E-01	2.3313000E-01	1.5123000E-01	7.6551000E-01
1.5554000E+03	6.4375000E-01	2.3273000E-01	1.4982000E-01	7.5838000E-01
1.5555000E+03	6.3832000E-01	2.3233000E-01	1.4830000E-01	7.5069000E-01
1.5556000E+03	6.3239000E-01	2.3194000E-01	1.4667000E-01	7.4245000E-01
1.5557000E+03	6.2597000E-01	2.3154000E-01	1.4494000E-01	7.3366000E-01
1.5558000E+03	6.1908000E-01	2.3115000E-01	1.4310000E-01	7.2434000E-01
1.5559000E+03	6.1171000E-01	2.3075000E-01	1.4115000E-01	7.1450000E-01
1.5560000E+03	6.0389000E-01	2.3036000E-01	1.3911000E-01	7.0416000E-01
1.5561000E+03	5.9563000E-01	2.2993000E-01	1.3695000E-01	6.9323000E-01
1.5562000E+03	5.8695000E-01	2.2950000E-01	1.3470000E-01	6.8185000E-01
1.5563000E+03	5.7788000E-01	2.2907000E-01	1.3237000E-01	6.7005000E-01
1.5564000E+03	5.6842000E-01	2.2864000E-01	1.2996000E-01	6.5786000E-01
1.5565000E+03	5.5862000E-01	2.2821000E-01	1.2748000E-01	6.4530000E-01
1.5566000E+03	5.4850000E-01	2.2778000E-01	1.2494000E-01	6.3241000E-01
1.5567000E+03	5.3809000E-01	2.2746000E-01	1.2239000E-01	6.1953000E-01
1.5568000E+03	5.2742000E-01	2.2724000E-01	1.1985000E-01	6.0668000E-01
1.5569000E+03	5.1651000E-01	2.2703000E-01	1.1726000E-01	5.9358000E-01
1.5570000E+03	5.0540000E-01	2.2682000E-01	1.1464000E-01	5.8027000E-01
1.5571000E+03	4.9413000E-01	2.2661000E-01	1.1197000E-01	5.6680000E-01
1.5572000E+03	4.8272000E-01	2.2640000E-01	1.0928000E-01	5.5319000E-01
1.5573000E+03	4.7120000E-01	2.2618000E-01	1.0658000E-01	5.3948000E-01
1.5574000E+03	4.5959000E-01	2.2597000E-01	1.0386000E-01	5.2570000E-01
1.5575000E+03	4.4794000E-01	2.2576000E-01	1.0113000E-01	5.1190000E-01
1.5576000E+03	4.3627000E-01	2.2555000E-01	9.8400000E-02	4.9809000E-01
1.5577000E+03	4.2460000E-01	2.2534000E-01	9.5678000E-02	4.8431000E-01

1.5578000E+03	4.1295000E-01	2.2512000E-01	9.2966000E-02	4.7058000E-01
1.5579000E+03	4.0136000E-01	2.2491000E-01	9.0271000E-02	4.5694000E-01
1.5580000E+03	3.8983000E-01	2.2470000E-01	8.7596000E-02	4.4340000E-01
1.5581000E+03	3.7839000E-01	2.2451000E-01	8.4953000E-02	4.3002000E-01
1.5582000E+03	3.6706000E-01	2.2432000E-01	8.2338000E-02	4.1679000E-01
1.5583000E+03	3.5585000E-01	2.2413000E-01	7.9755000E-02	4.0371000E-01
1.5584000E+03	3.4477000E-01	2.2394000E-01	7.7207000E-02	3.9081000E-01
1.5585000E+03	3.3384000E-01	2.2374000E-01	7.4696000E-02	3.7810000E-01
1.5586000E+03	3.2308000E-01	2.2360000E-01	7.2239000E-02	3.6567000E-01
1.5587000E+03	3.1247000E-01	2.2364000E-01	6.9881000E-02	3.5373000E-01
1.5588000E+03	3.0205000E-01	2.2367000E-01	6.7561000E-02	3.4199000E-01
1.5589000E+03	2.9181000E-01	2.2371000E-01	6.5282000E-02	3.3045000E-01
1.5590000E+03	2.8176000E-01	2.2375000E-01	6.3044000E-02	3.1912000E-01
1.5591000E+03	2.7191000E-01	2.2379000E-01	6.0849000E-02	3.0801000E-01
1.5592000E+03	2.6225000E-01	2.2382000E-01	5.8698000E-02	2.9712000E-01
1.5593000E+03	2.5280000E-01	2.2386000E-01	5.6592000E-02	2.8646000E-01
1.5594000E+03	2.4356000E-01	2.2389000E-01	5.4532000E-02	2.7604000E-01
1.5595000E+03	2.3453000E-01	2.2393000E-01	5.2519000E-02	2.6585000E-01
1.5596000E+03	2.2572000E-01	2.2397000E-01	5.0553000E-02	2.5589000E-01
1.5597000E+03	2.1712000E-01	2.2400000E-01	4.8636000E-02	2.4619000E-01
1.5598000E+03	2.0875000E-01	2.2404000E-01	4.6767000E-02	2.3673000E-01
1.5599000E+03	2.0059000E-01	2.2407000E-01	4.4947000E-02	2.2752000E-01
1.5600000E+03	1.9266000E-01	2.2411000E-01	4.3177000E-02	2.1856000E-01
1.5601000E+03	1.8496000E-01	2.2410000E-01	4.1450000E-02	2.0982000E-01
1.5602000E+03	1.7748000E-01	2.2410000E-01	3.9774000E-02	2.0133000E-01
1.5603000E+03	1.7023000E-01	2.2410000E-01	3.8149000E-02	1.9311000E-01
1.5604000E+03	1.6321000E-01	2.2410000E-01	3.6575000E-02	1.8514000E-01
1.5605000E+03	1.5642000E-01	2.2409000E-01	3.5053000E-02	1.7744000E-01
1.5606000E+03	1.4986000E-01	2.2422000E-01	3.3601000E-02	1.7009000E-01
1.5607000E+03	1.4353000E-01	2.2435000E-01	3.2201000E-02	1.6300000E-01
1.5608000E+03	1.3742000E-01	2.2449000E-01	3.0849000E-02	1.5616000E-01
1.5609000E+03	1.3154000E-01	2.2463000E-01	2.9547000E-02	1.4956000E-01
1.5610000E+03	1.2588000E-01	2.2477000E-01	2.8293000E-02	1.4321000E-01
1.5611000E+03	1.2043000E-01	2.2490000E-01	2.7086000E-02	1.3711000E-01
1.5612000E+03	1.1521000E-01	2.2504000E-01	2.5926000E-02	1.3123000E-01
1.5613000E+03	1.1019000E-01	2.2517000E-01	2.4813000E-02	1.2560000E-01
1.5614000E+03	1.0538000E-01	2.2531000E-01	2.3744000E-02	1.2019000E-01
1.5615000E+03	1.0077000E-01	2.2544000E-01	2.2718000E-02	1.1500000E-01
1.5616000E+03	9.6355000E-02	2.2558000E-01	2.1736000E-02	1.1002000E-01
1.5617000E+03	9.2125000E-02	2.2571000E-01	2.0794000E-02	1.0526000E-01
1.5618000E+03	8.8075000E-02	2.2585000E-01	1.9891000E-02	1.0069000E-01
1.5619000E+03	8.4198000E-02	2.2598000E-01	1.9027000E-02	9.6313000E-02
1.5620000E+03	8.0486000E-02	2.2611000E-01	1.8199000E-02	9.2121000E-02

1.5621000E+03	7.6932000E-02	2.2625000E-01	1.7406000E-02	8.8109000E-02
1.5622000E+03	7.3528000E-02	2.2640000E-01	1.6647000E-02	8.4263000E-02
1.5623000E+03	7.0268000E-02	2.2654000E-01	1.5918000E-02	8.0577000E-02
1.5624000E+03	6.7143000E-02	2.2668000E-01	1.5220000E-02	7.7042000E-02
1.5625000E+03	6.4148000E-02	2.2686000E-01	1.4552000E-02	7.3663000E-02
1.5626000E+03	6.1275000E-02	2.2706000E-01	1.3913000E-02	7.0426000E-02
1.5627000E+03	5.8519000E-02	2.2726000E-01	1.3299000E-02	6.7319000E-02
1.5628000E+03	5.5875000E-02	2.2746000E-01	1.2710000E-02	6.4334000E-02
1.5629000E+03	5.3339000E-02	2.2766000E-01	1.2143000E-02	6.1467000E-02
1.5630000E+03	5.0905000E-02	2.2786000E-01	1.1599000E-02	5.8714000E-02
1.5631000E+03	4.9056000E-02	2.2806000E-01	1.1188000E-02	5.6631000E-02
1.5632000E+03	4.6806000E-02	2.2826000E-01	1.0684000E-02	5.4080000E-02
1.5633000E+03	4.4652000E-02	2.2846000E-01	1.0201000E-02	5.1636000E-02
1.5634000E+03	4.2593000E-02	2.2865000E-01	9.7389000E-03	4.9297000E-02
1.5635000E+03	4.0626000E-02	2.2885000E-01	9.2972000E-03	4.7061000E-02
1.5636000E+03	3.8751000E-02	2.2905000E-01	8.8757000E-03	4.4928000E-02
1.5637000E+03	3.6966000E-02	2.2924000E-01	8.4741000E-03	4.2895000E-02
1.5638000E+03	3.5270000E-02	2.2944000E-01	8.0923000E-03	4.0962000E-02
1.5639000E+03	3.3662000E-02	2.2964000E-01	7.7301000E-03	3.9129000E-02
1.5640000E+03	3.2143000E-02	2.2983000E-01	7.3874000E-03	3.7394000E-02
1.5641000E+03	3.0709000E-02	2.3005000E-01	7.0647000E-03	3.5761000E-02
1.5642000E+03	2.9361000E-02	2.3027000E-01	6.7610000E-03	3.4223000E-02
1.5643000E+03	2.8097000E-02	2.3049000E-01	6.4761000E-03	3.2781000E-02
1.5644000E+03	2.6916000E-02	2.3070000E-01	6.2094000E-03	3.1431000E-02
1.5645000E+03	2.5815000E-02	2.3087000E-01	5.9599000E-03	3.0168000E-02
1.5646000E+03	2.4791000E-02	2.3105000E-01	5.7281000E-03	2.8995000E-02
1.5647000E+03	2.3843000E-02	2.3123000E-01	5.5132000E-03	2.7907000E-02
1.5648000E+03	2.2966000E-02	2.3141000E-01	5.3145000E-03	2.6901000E-02
1.5649000E+03	2.2156000E-02	2.3158000E-01	5.1311000E-03	2.5973000E-02
1.5650000E+03	2.1410000E-02	2.3176000E-01	4.9621000E-03	2.5117000E-02
1.5651000E+03	2.0723000E-02	2.3194000E-01	4.8063000E-03	2.4329000E-02
1.5652000E+03	2.0089000E-02	2.3211000E-01	4.6628000E-03	2.3602000E-02
1.5653000E+03	1.9502000E-02	2.3228000E-01	4.5301000E-03	2.2931000E-02
1.5654000E+03	1.8958000E-02	2.3246000E-01	4.4070000E-03	2.2308000E-02
1.5655000E+03	1.8451000E-02	2.3263000E-01	4.2922000E-03	2.1727000E-02
1.5656000E+03	1.7973000E-02	2.3281000E-01	4.1843000E-03	2.1180000E-02
1.5657000E+03	1.7521000E-02	2.3298000E-01	4.0820000E-03	2.0662000E-02
1.5658000E+03	1.7087000E-02	2.3315000E-01	3.9838000E-03	2.0166000E-02
1.5659000E+03	1.6666000E-02	2.3333000E-01	3.8886000E-03	1.9684000E-02
1.5660000E+03	1.6253000E-02	2.3350000E-01	3.7952000E-03	1.9211000E-02
1.5661000E+03	1.5844000E-02	2.3365000E-01	3.7019000E-03	1.8739000E-02
1.5662000E+03	1.5434000E-02	2.3379000E-01	3.6083000E-03	1.8265000E-02
1.5663000E+03	1.5019000E-02	2.3394000E-01	3.5134000E-03	1.7785000E-02

1.5664000E+03	1.4596000E-02	2.3392000E-01	3.4143000E-03	1.7283000E-02
1.5665000E+03	1.4164000E-02	2.3390000E-01	3.3129000E-03	1.6769000E-02
1.5666000E+03	1.3719000E-02	2.3388000E-01	3.2087000E-03	1.6242000E-02
1.5667000E+03	1.3263000E-02	2.3386000E-01	3.1017000E-03	1.5700000E-02
1.5668000E+03	1.2794000E-02	2.3385000E-01	2.9917000E-03	1.5144000E-02
1.5669000E+03	1.2313000E-02	2.3383000E-01	2.8790000E-03	1.4573000E-02
1.5670000E+03	1.1821000E-02	2.3381000E-01	2.7639000E-03	1.3991000E-02
1.5671000E+03	1.1321000E-02	2.3379000E-01	2.6468000E-03	1.3398000E-02
1.5672000E+03	1.0816000E-02	2.3377000E-01	2.5284000E-03	1.2799000E-02
1.5673000E+03	1.0308000E-02	2.3374000E-01	2.4094000E-03	1.2196000E-02
1.5674000E+03	9.8005000E-03	2.3372000E-01	2.2906000E-03	1.1595000E-02
1.5675000E+03	9.2978000E-03	2.3370000E-01	2.1729000E-03	1.0999000E-02
1.5676000E+03	8.8039000E-03	2.3368000E-01	2.0573000E-03	1.0414000E-02
1.5677000E+03	8.3227000E-03	2.3366000E-01	1.9447000E-03	9.8436000E-03
1.5678000E+03	7.8583000E-03	2.3363000E-01	1.8360000E-03	9.2935000E-03
1.5679000E+03	7.4147000E-03	2.3361000E-01	1.7322000E-03	8.7680000E-03
1.5680000E+03	6.9953000E-03	2.3359000E-01	1.6340000E-03	8.2713000E-03
1.5681000E+03	6.6035000E-03	2.3361000E-01	1.5427000E-03	7.8087000E-03
1.5682000E+03	6.2421000E-03	2.3363000E-01	1.4584000E-03	7.3820000E-03
1.5683000E+03	5.9134000E-03	2.3354000E-01	1.3810000E-03	6.9904000E-03
1.5684000E+03	5.6190000E-03	2.3339000E-01	1.3114000E-03	6.6383000E-03
1.5685000E+03	5.3602000E-03	2.3324000E-01	1.2502000E-03	6.3285000E-03
1.5686000E+03	5.1372000E-03	2.3310000E-01	1.1975000E-03	6.0615000E-03
1.5687000E+03	4.9500000E-03	2.3295000E-01	1.1531000E-03	5.8370000E-03
1.5688000E+03	4.7977000E-03	2.3281000E-01	1.1169000E-03	5.6538000E-03
1.5689000E+03	4.6787000E-03	2.3266000E-01	1.0886000E-03	5.5102000E-03
1.5690000E+03	4.5911000E-03	2.3252000E-01	1.0675000E-03	5.4036000E-03
1.5691000E+03	4.5320000E-03	2.3237000E-01	1.0531000E-03	5.3307000E-03
1.5692000E+03	4.4985000E-03	2.3222000E-01	1.0446000E-03	5.2878000E-03
1.5693000E+03	4.4869000E-03	2.3207000E-01	1.0413000E-03	5.2709000E-03
1.5694000E+03	4.4934000E-03	2.3192000E-01	1.0421000E-03	5.2751000E-03
1.5695000E+03	4.5138000E-03	2.3177000E-01	1.0462000E-03	5.2957000E-03
1.5696000E+03	4.5440000E-03	2.3163000E-01	1.0525000E-03	5.3277000E-03
1.5697000E+03	4.5796000E-03	2.3148000E-01	1.0601000E-03	5.3659000E-03
1.5698000E+03	4.6163000E-03	2.3133000E-01	1.0679000E-03	5.4054000E-03
1.5699000E+03	4.6501000E-03	2.3118000E-01	1.0750000E-03	5.4415000E-03
1.5700000E+03	4.6772000E-03	2.3103000E-01	1.0806000E-03	5.4697000E-03
1.5701000E+03	4.6942000E-03	2.3084000E-01	1.0836000E-03	5.4850000E-03
1.5702000E+03	4.6980000E-03	2.3063000E-01	1.0835000E-03	5.4845000E-03
1.5703000E+03	4.6861000E-03	2.3039000E-01	1.0796000E-03	5.4649000E-03
1.5704000E+03	4.6566000E-03	2.3015000E-01	1.0717000E-03	5.4248000E-03
1.5705000E+03	4.6081000E-03	2.2991000E-01	1.0594000E-03	5.3628000E-03
1.5706000E+03	4.5399000E-03	2.2967000E-01	1.0427000E-03	5.2778000E-03

1.5707000E+03	4.4517000E-03	2.2943000E-01	1.0213000E-03	5.1699000E-03
1.5708000E+03	4.3441000E-03	2.2919000E-01	9.9561000E-04	5.0397000E-03
1.5709000E+03	4.2181000E-03	2.2895000E-01	9.6571000E-04	4.8883000E-03
1.5710000E+03	4.0751000E-03	2.2871000E-01	9.3199000E-04	4.7176000E-03
1.5711000E+03	3.9171000E-03	2.2846000E-01	8.9492000E-04	4.5300000E-03
1.5712000E+03	3.7466000E-03	2.2822000E-01	8.5507000E-04	4.3283000E-03
1.5713000E+03	3.5663000E-03	2.2798000E-01	8.1305000E-04	4.1156000E-03
1.5714000E+03	3.3790000E-03	2.2774000E-01	7.6954000E-04	3.8953000E-03
1.5715000E+03	3.1879000E-03	2.2750000E-01	7.2525000E-04	3.6711000E-03
1.5716000E+03	2.9960000E-03	2.2726000E-01	6.8087000E-04	3.4465000E-03
1.5717000E+03	2.8065000E-03	2.2702000E-01	6.3713000E-04	3.2251000E-03
1.5718000E+03	2.6224000E-03	2.2678000E-01	5.9470000E-04	3.0103000E-03
1.5719000E+03	2.4466000E-03	2.2653000E-01	5.5423000E-04	2.8054000E-03
1.5720000E+03	2.2816000E-03	2.2629000E-01	5.1630000E-04	2.6135000E-03
1.5721000E+03	2.1298000E-03	2.2610000E-01	4.8155000E-04	2.4375000E-03
1.5722000E+03	1.9933000E-03	2.2596000E-01	4.5041000E-04	2.2799000E-03
1.5723000E+03	1.8737000E-03	2.2583000E-01	4.2314000E-04	2.1419000E-03
1.5724000E+03	1.7723000E-03	2.2569000E-01	3.9999000E-04	2.0247000E-03
1.5725000E+03	1.6899000E-03	2.2556000E-01	3.8117000E-04	1.9294000E-03
1.5726000E+03	1.6269000E-03	2.2542000E-01	3.6674000E-04	1.8564000E-03
1.5727000E+03	1.5833000E-03	2.2528000E-01	3.5668000E-04	1.8055000E-03
1.5728000E+03	1.5584000E-03	2.2515000E-01	3.5087000E-04	1.7761000E-03
1.5729000E+03	1.5514000E-03	2.2501000E-01	3.4907000E-04	1.7670000E-03
1.5730000E+03	0.0000000E+00	2.2487000E-01	0.0000000E+00	0.0000000E+00

Channel 13

Wavenumber	HIRS Filter Transmittance	Optical Element Transmittance	Product of the HIRS Filter and Optical Element Transmittances	Normalized Value of Column 4
2.1653000E+03	0.0000000E+00	8.3246000E-01	0.0000000E+00	0.0000000E+00
2.1654000E+03	2.6727000E-03	8.3245000E-01	2.2249000E-03	4.0061000E-03
2.1655000E+03	2.7596000E-03	8.3245000E-01	2.2972000E-03	4.1362000E-03
2.1656000E+03	2.8483000E-03	8.3244000E-01	2.3710000E-03	4.2692000E-03
2.1657000E+03	2.9389000E-03	8.3243000E-01	2.4464000E-03	4.4049000E-03
2.1658000E+03	3.0314000E-03	8.3243000E-01	2.5234000E-03	4.5435000E-03
2.1659000E+03	3.1259000E-03	8.3242000E-01	2.6020000E-03	4.6851000E-03
2.1660000E+03	3.2224000E-03	8.3242000E-01	2.6824000E-03	4.8297000E-03
2.1661000E+03	3.3211000E-03	8.3245000E-01	2.7646000E-03	4.9779000E-03
2.1662000E+03	3.4221000E-03	8.3249000E-01	2.8489000E-03	5.1296000E-03
2.1663000E+03	3.5257000E-03	8.3253000E-01	2.9353000E-03	5.2851000E-03
2.1664000E+03	3.6320000E-03	8.3257000E-01	3.0239000E-03	5.4447000E-03
2.1665000E+03	3.7414000E-03	8.3261000E-01	3.1151000E-03	5.6089000E-03
2.1666000E+03	3.8540000E-03	8.3265000E-01	3.2091000E-03	5.7781000E-03

2.1667000E+03	3.9703000E-03	8.3269000E-01	3.3060000E-03	5.9527000E-03
2.1668000E+03	4.0906000E-03	8.3273000E-01	3.4063000E-03	6.1333000E-03
2.1669000E+03	4.2152000E-03	8.3277000E-01	3.5103000E-03	6.3204000E-03
2.1670000E+03	4.3445000E-03	8.3281000E-01	3.6182000E-03	6.5147000E-03
2.1671000E+03	4.4791000E-03	8.3285000E-01	3.7304000E-03	6.7167000E-03
2.1672000E+03	4.6192000E-03	8.3289000E-01	3.8473000E-03	6.9273000E-03
2.1673000E+03	4.7655000E-03	8.3293000E-01	3.9693000E-03	7.1470000E-03
2.1674000E+03	4.9183000E-03	8.3297000E-01	4.0968000E-03	7.3765000E-03
2.1675000E+03	5.0782000E-03	8.3301000E-01	4.2302000E-03	7.6167000E-03
2.1676000E+03	5.2457000E-03	8.3306000E-01	4.3700000E-03	7.8684000E-03
2.1677000E+03	5.4214000E-03	8.3310000E-01	4.5165000E-03	8.1322000E-03
2.1678000E+03	5.6056000E-03	8.3314000E-01	4.6703000E-03	8.4091000E-03
2.1679000E+03	5.7991000E-03	8.3318000E-01	4.8317000E-03	8.6997000E-03
2.1680000E+03	6.0023000E-03	8.3322000E-01	5.0012000E-03	9.0050000E-03
2.1681000E+03	6.2157000E-03	8.3324000E-01	5.1792000E-03	9.3254000E-03
2.1682000E+03	6.4400000E-03	8.3326000E-01	5.3662000E-03	9.6620000E-03
2.1683000E+03	6.6755000E-03	8.3328000E-01	5.5626000E-03	1.0016000E-02
2.1684000E+03	6.9229000E-03	8.3330000E-01	5.7688000E-03	1.0387000E-02
2.1685000E+03	7.1826000E-03	8.3331000E-01	5.9853000E-03	1.0777000E-02
2.1686000E+03	7.4550000E-03	8.3333000E-01	6.2125000E-03	1.1186000E-02
2.1687000E+03	7.7407000E-03	8.3335000E-01	6.4507000E-03	1.1615000E-02
2.1688000E+03	8.0401000E-03	8.3337000E-01	6.7004000E-03	1.2064000E-02
2.1689000E+03	8.3536000E-03	8.3339000E-01	6.9618000E-03	1.2535000E-02
2.1690000E+03	8.6815000E-03	8.3340000E-01	7.2352000E-03	1.3027000E-02
2.1691000E+03	9.0243000E-03	8.3343000E-01	7.5210000E-03	1.3542000E-02
2.1692000E+03	9.3821000E-03	8.3345000E-01	7.8195000E-03	1.4079000E-02
2.1693000E+03	9.7555000E-03	8.3347000E-01	8.1309000E-03	1.4640000E-02
2.1694000E+03	1.0145000E-02	8.3349000E-01	8.4554000E-03	1.5224000E-02
2.1695000E+03	1.0550000E-02	8.3351000E-01	8.7932000E-03	1.5833000E-02
2.1696000E+03	1.0971000E-02	8.3353000E-01	9.1445000E-03	1.6465000E-02
2.1697000E+03	1.1409000E-02	8.3356000E-01	9.5096000E-03	1.7123000E-02
2.1698000E+03	1.1863000E-02	8.3358000E-01	9.8887000E-03	1.7805000E-02
2.1699000E+03	1.2334000E-02	8.3360000E-01	1.0282000E-02	1.8513000E-02
2.1700000E+03	1.2823000E-02	8.3362000E-01	1.0689000E-02	1.9246000E-02
2.1701000E+03	1.3328000E-02	8.3360000E-01	1.1111000E-02	2.0005000E-02
2.1702000E+03	1.3852000E-02	8.3358000E-01	1.1547000E-02	2.0790000E-02
2.1703000E+03	1.4393000E-02	8.3356000E-01	1.1997000E-02	2.1602000E-02
2.1704000E+03	1.4952000E-02	8.3354000E-01	1.2463000E-02	2.2441000E-02
2.1705000E+03	1.5530000E-02	8.3352000E-01	1.2945000E-02	2.3308000E-02
2.1706000E+03	1.6127000E-02	8.3350000E-01	1.3442000E-02	2.4203000E-02
2.1707000E+03	1.6744000E-02	8.3348000E-01	1.3956000E-02	2.5128000E-02
2.1708000E+03	1.7380000E-02	8.3346000E-01	1.4486000E-02	2.6082000E-02
2.1709000E+03	1.8037000E-02	8.3344000E-01	1.5033000E-02	2.7067000E-02

2.1710000E+03	1.8715000E-02	8.3342000E-01	1.5597000E-02	2.8084000E-02
2.1711000E+03	1.9415000E-02	8.3338000E-01	1.6180000E-02	2.9133000E-02
2.1712000E+03	2.0138000E-02	8.3334000E-01	1.6782000E-02	3.0217000E-02
2.1713000E+03	2.0885000E-02	8.3330000E-01	1.7404000E-02	3.1336000E-02
2.1714000E+03	2.1658000E-02	8.3327000E-01	1.8046000E-02	3.2494000E-02
2.1715000E+03	2.2456000E-02	8.3323000E-01	1.8711000E-02	3.3690000E-02
2.1716000E+03	2.3282000E-02	8.3319000E-01	1.9399000E-02	3.4928000E-02
2.1717000E+03	2.4138000E-02	8.3315000E-01	2.0110000E-02	3.6210000E-02
2.1718000E+03	2.5024000E-02	8.3311000E-01	2.0848000E-02	3.7538000E-02
2.1719000E+03	2.5943000E-02	8.3307000E-01	2.1613000E-02	3.8915000E-02
2.1720000E+03	2.6897000E-02	8.3303000E-01	2.2406000E-02	4.0343000E-02
2.1721000E+03	2.7887000E-02	8.3301000E-01	2.3230000E-02	4.1827000E-02
2.1722000E+03	2.8917000E-02	8.3298000E-01	2.4087000E-02	4.3370000E-02
2.1723000E+03	2.9988000E-02	8.3295000E-01	2.4978000E-02	4.4974000E-02
2.1724000E+03	3.1102000E-02	8.3292000E-01	2.5906000E-02	4.6645000E-02
2.1725000E+03	3.2263000E-02	8.3289000E-01	2.6872000E-02	4.8384000E-02
2.1726000E+03	3.3474000E-02	8.3286000E-01	2.7879000E-02	5.0198000E-02
2.1727000E+03	3.4737000E-02	8.3283000E-01	2.8930000E-02	5.2090000E-02
2.1728000E+03	3.6056000E-02	8.3280000E-01	3.0027000E-02	5.4066000E-02
2.1729000E+03	3.7433000E-02	8.3278000E-01	3.1173000E-02	5.6129000E-02
2.1730000E+03	3.8872000E-02	8.3275000E-01	3.2370000E-02	5.8284000E-02
2.1731000E+03	4.0376000E-02	8.3272000E-01	3.3622000E-02	6.0537000E-02
2.1732000E+03	4.1949000E-02	8.3269000E-01	3.4930000E-02	6.2894000E-02
2.1733000E+03	4.3594000E-02	8.3266000E-01	3.6299000E-02	6.5358000E-02
2.1734000E+03	4.5316000E-02	8.3263000E-01	3.7731000E-02	6.7937000E-02
2.1735000E+03	4.7117000E-02	8.3260000E-01	3.9229000E-02	7.0634000E-02
2.1736000E+03	4.9001000E-02	8.3257000E-01	4.0797000E-02	7.3457000E-02
2.1737000E+03	5.0518000E-02	8.3254000E-01	4.2059000E-02	7.5729000E-02
2.1738000E+03	5.2562000E-02	8.3252000E-01	4.3758000E-02	7.8789000E-02
2.1739000E+03	5.4700000E-02	8.3249000E-01	4.5537000E-02	8.1991000E-02
2.1740000E+03	5.6936000E-02	8.3246000E-01	4.7397000E-02	8.5341000E-02
2.1741000E+03	5.9275000E-02	8.3245000E-01	4.9343000E-02	8.8845000E-02
2.1742000E+03	6.1719000E-02	8.3245000E-01	5.1378000E-02	9.2509000E-02
2.1743000E+03	6.4273000E-02	8.3245000E-01	5.3503000E-02	9.6336000E-02
2.1744000E+03	6.6939000E-02	8.3244000E-01	5.5723000E-02	1.0033000E-01
2.1745000E+03	6.9721000E-02	8.3244000E-01	5.8038000E-02	1.0450000E-01
2.1746000E+03	7.2622000E-02	8.3243000E-01	6.0453000E-02	1.0885000E-01
2.1747000E+03	7.5645000E-02	8.3243000E-01	6.2969000E-02	1.1338000E-01
2.1748000E+03	7.8793000E-02	8.3243000E-01	6.5590000E-02	1.1810000E-01
2.1749000E+03	8.2069000E-02	8.3242000E-01	6.8316000E-02	1.2301000E-01
2.1750000E+03	8.5473000E-02	8.3242000E-01	7.1150000E-02	1.2811000E-01
2.1751000E+03	8.9010000E-02	8.3241000E-01	7.4093000E-02	1.3341000E-01
2.1752000E+03	9.2680000E-02	8.3241000E-01	7.7148000E-02	1.3891000E-01

2.1753000E+03	9.6485000E-02	8.3241000E-01	8.0315000E-02	1.4461000E-01
2.1754000E+03	1.0043000E-01	8.3241000E-01	8.3596000E-02	1.5052000E-01
2.1755000E+03	1.0451000E-01	8.3240000E-01	8.6991000E-02	1.5663000E-01
2.1756000E+03	1.0872000E-01	8.3240000E-01	9.0500000E-02	1.6295000E-01
2.1757000E+03	1.1308000E-01	8.3240000E-01	9.4125000E-02	1.6948000E-01
2.1758000E+03	1.1757000E-01	8.3239000E-01	9.7864000E-02	1.7621000E-01
2.1759000E+03	1.2220000E-01	8.3239000E-01	1.0172000E-01	1.8315000E-01
2.1760000E+03	1.2697000E-01	8.3239000E-01	1.0569000E-01	1.9030000E-01
2.1761000E+03	1.3187000E-01	8.3237000E-01	1.0977000E-01	1.9764000E-01
2.1762000E+03	1.3691000E-01	8.3236000E-01	1.1396000E-01	2.0519000E-01
2.1763000E+03	1.4209000E-01	8.3235000E-01	1.1826000E-01	2.1294000E-01
2.1764000E+03	1.4739000E-01	8.3233000E-01	1.2268000E-01	2.2088000E-01
2.1765000E+03	1.5282000E-01	8.3232000E-01	1.2719000E-01	2.2902000E-01
2.1766000E+03	1.5838000E-01	8.3230000E-01	1.3182000E-01	2.3734000E-01
2.1767000E+03	1.6406000E-01	8.3229000E-01	1.3654000E-01	2.4585000E-01
2.1768000E+03	1.6986000E-01	8.3227000E-01	1.4137000E-01	2.5454000E-01
2.1769000E+03	1.7577000E-01	8.3226000E-01	1.4629000E-01	2.6340000E-01
2.1770000E+03	1.8180000E-01	8.3224000E-01	1.5130000E-01	2.7243000E-01
2.1771000E+03	1.8793000E-01	8.3223000E-01	1.5640000E-01	2.8161000E-01
2.1772000E+03	1.9417000E-01	8.3222000E-01	1.6159000E-01	2.9096000E-01
2.1773000E+03	2.0050000E-01	8.3221000E-01	1.6686000E-01	3.0044000E-01
2.1774000E+03	2.0693000E-01	8.3220000E-01	1.7221000E-01	3.1007000E-01
2.1775000E+03	2.1344000E-01	8.3219000E-01	1.7763000E-01	3.1983000E-01
2.1776000E+03	2.2004000E-01	8.3218000E-01	1.8311000E-01	3.2970000E-01
2.1777000E+03	2.2671000E-01	8.3217000E-01	1.8866000E-01	3.3969000E-01
2.1778000E+03	2.3345000E-01	8.3216000E-01	1.9427000E-01	3.4979000E-01
2.1779000E+03	2.4025000E-01	8.3215000E-01	1.9993000E-01	3.5998000E-01
2.1780000E+03	2.4711000E-01	8.3214000E-01	2.0563000E-01	3.7025000E-01
2.1781000E+03	2.5402000E-01	8.3213000E-01	2.1138000E-01	3.8060000E-01
2.1782000E+03	2.6098000E-01	8.3212000E-01	2.1716000E-01	3.9102000E-01
2.1783000E+03	2.6797000E-01	8.3212000E-01	2.2298000E-01	4.0149000E-01
2.1784000E+03	2.7499000E-01	8.3211000E-01	2.2882000E-01	4.1200000E-01
2.1785000E+03	2.8203000E-01	8.3210000E-01	2.3468000E-01	4.2255000E-01
2.1786000E+03	2.8909000E-01	8.3209000E-01	2.4055000E-01	4.3312000E-01
2.1787000E+03	2.9616000E-01	8.3208000E-01	2.4643000E-01	4.4371000E-01
2.1788000E+03	3.0323000E-01	8.3207000E-01	2.5231000E-01	4.5430000E-01
2.1789000E+03	3.1030000E-01	8.3206000E-01	2.5819000E-01	4.6489000E-01
2.1790000E+03	3.1736000E-01	8.3205000E-01	2.6406000E-01	4.7545000E-01
2.1791000E+03	3.2440000E-01	8.3204000E-01	2.6991000E-01	4.8599000E-01
2.1792000E+03	3.3141000E-01	8.3203000E-01	2.7575000E-01	4.9649000E-01
2.1793000E+03	3.3839000E-01	8.3202000E-01	2.8155000E-01	5.0695000E-01
2.1794000E+03	3.4534000E-01	8.3201000E-01	2.8733000E-01	5.1735000E-01
2.1795000E+03	3.5224000E-01	8.3200000E-01	2.9306000E-01	5.2768000E-01

2.1796000E+03	3.5909000E-01	8.3199000E-01	2.9876000E-01	5.3793000E-01
2.1797000E+03	3.6588000E-01	8.3198000E-01	3.0441000E-01	5.4810000E-01
2.1798000E+03	3.7261000E-01	8.3197000E-01	3.1000000E-01	5.5818000E-01
2.1799000E+03	3.7928000E-01	8.3196000E-01	3.1554000E-01	5.6815000E-01
2.1800000E+03	3.8587000E-01	8.3195000E-01	3.2102000E-01	5.7801000E-01
2.1801000E+03	3.9238000E-01	8.3192000E-01	3.2643000E-01	5.8775000E-01
2.1802000E+03	3.9880000E-01	8.3190000E-01	3.3176000E-01	5.9736000E-01
2.1803000E+03	4.0514000E-01	8.3188000E-01	3.3703000E-01	6.0683000E-01
2.1804000E+03	4.1138000E-01	8.3185000E-01	3.4221000E-01	6.1617000E-01
2.1805000E+03	4.1753000E-01	8.3183000E-01	3.4732000E-01	6.2536000E-01
2.1806000E+03	4.2358000E-01	8.3180000E-01	3.5233000E-01	6.3440000E-01
2.1807000E+03	4.2952000E-01	8.3178000E-01	3.5727000E-01	6.4328000E-01
2.1808000E+03	4.3535000E-01	8.3176000E-01	3.6211000E-01	6.5199000E-01
2.1809000E+03	4.4107000E-01	8.3173000E-01	3.6686000E-01	6.6054000E-01
2.1810000E+03	4.4668000E-01	8.3171000E-01	3.7151000E-01	6.6892000E-01
2.1811000E+03	4.5217000E-01	8.3168000E-01	3.7606000E-01	6.7712000E-01
2.1812000E+03	4.5754000E-01	8.3166000E-01	3.8052000E-01	6.8515000E-01
2.1813000E+03	4.6279000E-01	8.3164000E-01	3.8488000E-01	6.9299000E-01
2.1814000E+03	4.6792000E-01	8.3161000E-01	3.8913000E-01	7.0065000E-01
2.1815000E+03	4.7293000E-01	8.3159000E-01	3.9328000E-01	7.0812000E-01
2.1816000E+03	4.7780000E-01	8.3157000E-01	3.9733000E-01	7.1541000E-01
2.1817000E+03	4.8256000E-01	8.3154000E-01	4.0127000E-01	7.2250000E-01
2.1818000E+03	4.8719000E-01	8.3152000E-01	4.0511000E-01	7.2941000E-01
2.1819000E+03	4.9169000E-01	8.3149000E-01	4.0884000E-01	7.3614000E-01
2.1820000E+03	4.9607000E-01	8.3147000E-01	4.1247000E-01	7.4267000E-01
2.1821000E+03	5.0032000E-01	8.3148000E-01	4.1601000E-01	7.4905000E-01
2.1822000E+03	5.0445000E-01	8.3150000E-01	4.1945000E-01	7.5524000E-01
2.1823000E+03	5.0846000E-01	8.3151000E-01	4.2279000E-01	7.6125000E-01
2.1824000E+03	5.1235000E-01	8.3152000E-01	4.2603000E-01	7.6708000E-01
2.1825000E+03	5.1611000E-01	8.3153000E-01	4.2916000E-01	7.7273000E-01
2.1826000E+03	5.1976000E-01	8.3154000E-01	4.3220000E-01	7.7820000E-01
2.1827000E+03	5.2329000E-01	8.3155000E-01	4.3515000E-01	7.8350000E-01
2.1828000E+03	5.2672000E-01	8.3156000E-01	4.3800000E-01	7.8864000E-01
2.1829000E+03	5.3003000E-01	8.3157000E-01	4.4076000E-01	7.9361000E-01
2.1830000E+03	5.3323000E-01	8.3159000E-01	4.4343000E-01	7.9841000E-01
2.1831000E+03	5.3633000E-01	8.3159000E-01	4.4601000E-01	8.0307000E-01
2.1832000E+03	5.3933000E-01	8.3160000E-01	4.4851000E-01	8.0757000E-01
2.1833000E+03	5.4224000E-01	8.3161000E-01	4.5093000E-01	8.1192000E-01
2.1834000E+03	5.4505000E-01	8.3162000E-01	4.5327000E-01	8.1614000E-01
2.1835000E+03	5.4777000E-01	8.3163000E-01	4.5554000E-01	8.2022000E-01
2.1836000E+03	5.5040000E-01	8.3164000E-01	4.5773000E-01	8.2417000E-01
2.1837000E+03	5.5295000E-01	8.3165000E-01	4.5986000E-01	8.2800000E-01
2.1838000E+03	5.5543000E-01	8.3166000E-01	4.6192000E-01	8.3172000E-01

2.1839000E+03	5.5783000E-01	8.3167000E-01	4.6393000E-01	8.3532000E-01
2.1840000E+03	5.6016000E-01	8.3167000E-01	4.6587000E-01	8.3883000E-01
2.1841000E+03	5.6243000E-01	8.3165000E-01	4.6774000E-01	8.4220000E-01
2.1842000E+03	5.6464000E-01	8.3162000E-01	4.6957000E-01	8.4548000E-01
2.1843000E+03	5.6679000E-01	8.3159000E-01	4.7134000E-01	8.4867000E-01
2.1844000E+03	5.6889000E-01	8.3157000E-01	4.7307000E-01	8.5179000E-01
2.1845000E+03	5.7094000E-01	8.3154000E-01	4.7476000E-01	8.5484000E-01
2.1846000E+03	5.7296000E-01	8.3151000E-01	4.7642000E-01	8.5782000E-01
2.1847000E+03	5.7493000E-01	8.3149000E-01	4.7804000E-01	8.6074000E-01
2.1848000E+03	5.7686000E-01	8.3146000E-01	4.7964000E-01	8.6361000E-01
2.1849000E+03	5.7877000E-01	8.3143000E-01	4.8121000E-01	8.6644000E-01
2.1850000E+03	5.8065000E-01	8.3141000E-01	4.8275000E-01	8.6922000E-01
2.1851000E+03	5.8250000E-01	8.3138000E-01	4.8428000E-01	8.7197000E-01
2.1852000E+03	5.8434000E-01	8.3135000E-01	4.8579000E-01	8.7468000E-01
2.1853000E+03	5.8615000E-01	8.3132000E-01	4.8728000E-01	8.7737000E-01
2.1854000E+03	5.8796000E-01	8.3129000E-01	4.8876000E-01	8.8004000E-01
2.1855000E+03	5.8975000E-01	8.3126000E-01	4.9024000E-01	8.8270000E-01
2.1856000E+03	5.9154000E-01	8.3122000E-01	4.9171000E-01	8.8534000E-01
2.1857000E+03	5.9333000E-01	8.3119000E-01	4.9317000E-01	8.8798000E-01
2.1858000E+03	5.9511000E-01	8.3116000E-01	4.9463000E-01	8.9061000E-01
2.1859000E+03	5.9689000E-01	8.3113000E-01	4.9609000E-01	8.9324000E-01
2.1860000E+03	5.9867000E-01	8.3110000E-01	4.9756000E-01	8.9587000E-01
2.1861000E+03	6.0045000E-01	8.3107000E-01	4.9902000E-01	8.9850000E-01
2.1862000E+03	6.0224000E-01	8.3103000E-01	5.0048000E-01	9.0114000E-01
2.1863000E+03	6.0404000E-01	8.3099000E-01	5.0195000E-01	9.0378000E-01
2.1864000E+03	6.0584000E-01	8.3095000E-01	5.0342000E-01	9.0643000E-01
2.1865000E+03	6.0764000E-01	8.3091000E-01	5.0490000E-01	9.0909000E-01
2.1866000E+03	6.0946000E-01	8.3087000E-01	5.0638000E-01	9.1177000E-01
2.1867000E+03	6.1128000E-01	8.3084000E-01	5.0787000E-01	9.1445000E-01
2.1868000E+03	6.1311000E-01	8.3080000E-01	5.0937000E-01	9.1714000E-01
2.1869000E+03	6.1494000E-01	8.3076000E-01	5.1087000E-01	9.1985000E-01
2.1870000E+03	6.1678000E-01	8.3072000E-01	5.1238000E-01	9.2256000E-01
2.1871000E+03	6.1863000E-01	8.3069000E-01	5.1389000E-01	9.2528000E-01
2.1872000E+03	6.2048000E-01	8.3066000E-01	5.1540000E-01	9.2801000E-01
2.1873000E+03	6.2233000E-01	8.3062000E-01	5.1692000E-01	9.3074000E-01
2.1874000E+03	6.2418000E-01	8.3059000E-01	5.1844000E-01	9.3347000E-01
2.1875000E+03	6.2603000E-01	8.3056000E-01	5.1996000E-01	9.3620000E-01
2.1876000E+03	6.2788000E-01	8.3053000E-01	5.2147000E-01	9.3893000E-01
2.1877000E+03	6.2972000E-01	8.3049000E-01	5.2298000E-01	9.4165000E-01
2.1878000E+03	6.3155000E-01	8.3046000E-01	5.2448000E-01	9.4435000E-01
2.1879000E+03	6.3337000E-01	8.3043000E-01	5.2597000E-01	9.4704000E-01
2.1880000E+03	6.3518000E-01	8.3040000E-01	5.2745000E-01	9.4970000E-01
2.1881000E+03	6.3697000E-01	8.3042000E-01	5.2895000E-01	9.5241000E-01

2.1882000E+03	6.3875000E-01	8.3044000E-01	5.3044000E-01	9.5508000E-01
2.1883000E+03	6.4050000E-01	8.3046000E-01	5.3191000E-01	9.5773000E-01
2.1884000E+03	6.4223000E-01	8.3048000E-01	5.3336000E-01	9.6033000E-01
2.1885000E+03	6.4392000E-01	8.3050000E-01	5.3478000E-01	9.6290000E-01
2.1886000E+03	6.4559000E-01	8.3052000E-01	5.3618000E-01	9.6541000E-01
2.1887000E+03	6.4722000E-01	8.3054000E-01	5.3755000E-01	9.6788000E-01
2.1888000E+03	6.4881000E-01	8.3057000E-01	5.3888000E-01	9.7029000E-01
2.1889000E+03	6.5037000E-01	8.3059000E-01	5.4019000E-01	9.7263000E-01
2.1890000E+03	6.5188000E-01	8.3061000E-01	5.4145000E-01	9.7492000E-01
2.1891000E+03	6.5334000E-01	8.3063000E-01	5.4269000E-01	9.7713000E-01
2.1892000E+03	6.5475000E-01	8.3066000E-01	5.4387000E-01	9.7927000E-01
2.1893000E+03	6.5611000E-01	8.3068000E-01	5.4502000E-01	9.8133000E-01
2.1894000E+03	6.5741000E-01	8.3071000E-01	5.4611000E-01	9.8330000E-01
2.1895000E+03	6.5865000E-01	8.3073000E-01	5.4716000E-01	9.8519000E-01
2.1896000E+03	6.5983000E-01	8.3076000E-01	5.4815000E-01	9.8698000E-01
2.1897000E+03	6.6094000E-01	8.3078000E-01	5.4910000E-01	9.8867000E-01
2.1898000E+03	6.6199000E-01	8.3080000E-01	5.4998000E-01	9.9027000E-01
2.1899000E+03	6.6296000E-01	8.3083000E-01	5.5081000E-01	9.9176000E-01
2.1900000E+03	6.6386000E-01	8.3085000E-01	5.5157000E-01	9.9314000E-01
2.1901000E+03	6.6469000E-01	8.3085000E-01	5.5226000E-01	9.9437000E-01
2.1902000E+03	6.6544000E-01	8.3085000E-01	5.5288000E-01	9.9549000E-01
2.1903000E+03	6.6612000E-01	8.3085000E-01	5.5344000E-01	9.9650000E-01
2.1904000E+03	6.6671000E-01	8.3084000E-01	5.5393000E-01	9.9738000E-01
2.1905000E+03	6.6722000E-01	8.3084000E-01	5.5435000E-01	9.9814000E-01
2.1906000E+03	6.6764000E-01	8.3084000E-01	5.5470000E-01	9.9877000E-01
2.1907000E+03	6.6798000E-01	8.3084000E-01	5.5498000E-01	9.9927000E-01
2.1908000E+03	6.6823000E-01	8.3083000E-01	5.5519000E-01	9.9965000E-01
2.1909000E+03	6.6840000E-01	8.3083000E-01	5.5533000E-01	9.9989000E-01
2.1910000E+03	6.6847000E-01	8.3083000E-01	5.5539000E-01	1.0000000E+00
2.1911000E+03	6.6846000E-01	8.3083000E-01	5.5537000E-01	9.9997000E-01
2.1912000E+03	6.6835000E-01	8.3082000E-01	5.5528000E-01	9.9981000E-01
2.1913000E+03	6.6815000E-01	8.3082000E-01	5.5511000E-01	9.9951000E-01
2.1914000E+03	6.6786000E-01	8.3082000E-01	5.5487000E-01	9.9907000E-01
2.1915000E+03	6.6748000E-01	8.3081000E-01	5.5455000E-01	9.9849000E-01
2.1916000E+03	6.6700000E-01	8.3081000E-01	5.5415000E-01	9.9778000E-01
2.1917000E+03	6.6643000E-01	8.3081000E-01	5.5368000E-01	9.9692000E-01
2.1918000E+03	6.6577000E-01	8.3080000E-01	5.5312000E-01	9.9593000E-01
2.1919000E+03	6.6501000E-01	8.3080000E-01	5.5249000E-01	9.9479000E-01
2.1920000E+03	6.6416000E-01	8.3080000E-01	5.5178000E-01	9.9352000E-01
2.1921000E+03	6.6322000E-01	8.3077000E-01	5.5098000E-01	9.9207000E-01
2.1922000E+03	6.6218000E-01	8.3074000E-01	5.5010000E-01	9.9049000E-01
2.1923000E+03	6.6105000E-01	8.3072000E-01	5.4915000E-01	9.8877000E-01
2.1924000E+03	6.5983000E-01	8.3069000E-01	5.4811000E-01	9.8691000E-01

2.1925000E+03	6.5851000E-01	8.3066000E-01	5.4700000E-01	9.8490000E-01
2.1926000E+03	6.5710000E-01	8.3064000E-01	5.4581000E-01	9.8277000E-01
2.1927000E+03	6.5560000E-01	8.3061000E-01	5.4455000E-01	9.8049000E-01
2.1928000E+03	6.5400000E-01	8.3059000E-01	5.4321000E-01	9.7807000E-01
2.1929000E+03	6.5232000E-01	8.3056000E-01	5.4179000E-01	9.7552000E-01
2.1930000E+03	6.5054000E-01	8.3053000E-01	5.4029000E-01	9.7283000E-01
2.1931000E+03	6.4867000E-01	8.3051000E-01	5.3872000E-01	9.7000000E-01
2.1932000E+03	6.4671000E-01	8.3048000E-01	5.3708000E-01	9.6703000E-01
2.1933000E+03	6.4466000E-01	8.3045000E-01	5.3536000E-01	9.6393000E-01
2.1934000E+03	6.4251000E-01	8.3042000E-01	5.3356000E-01	9.6070000E-01
2.1935000E+03	6.4028000E-01	8.3040000E-01	5.3169000E-01	9.5733000E-01
2.1936000E+03	6.3796000E-01	8.3037000E-01	5.2974000E-01	9.5383000E-01
2.1937000E+03	6.3555000E-01	8.3034000E-01	5.2772000E-01	9.5019000E-01
2.1938000E+03	6.3305000E-01	8.3031000E-01	5.2563000E-01	9.4642000E-01
2.1939000E+03	6.3046000E-01	8.3028000E-01	5.2346000E-01	9.4251000E-01
2.1940000E+03	6.2778000E-01	8.3026000E-01	5.2122000E-01	9.3848000E-01
2.1941000E+03	6.2501000E-01	8.3024000E-01	5.1891000E-01	9.3432000E-01
2.1942000E+03	6.2215000E-01	8.3022000E-01	5.1652000E-01	9.3003000E-01
2.1943000E+03	6.1921000E-01	8.3020000E-01	5.1407000E-01	9.2560000E-01
2.1944000E+03	6.1618000E-01	8.3018000E-01	5.1154000E-01	9.2105000E-01
2.1945000E+03	6.1306000E-01	8.3016000E-01	5.0894000E-01	9.1637000E-01
2.1946000E+03	6.0985000E-01	8.3014000E-01	5.0626000E-01	9.1155000E-01
2.1947000E+03	6.0655000E-01	8.3012000E-01	5.0351000E-01	9.0660000E-01
2.1948000E+03	6.0317000E-01	8.3011000E-01	5.0069000E-01	9.0153000E-01
2.1949000E+03	5.9970000E-01	8.3009000E-01	4.9780000E-01	8.9632000E-01
2.1950000E+03	5.9614000E-01	8.3007000E-01	4.9484000E-01	8.9098000E-01
2.1951000E+03	5.9250000E-01	8.3005000E-01	4.9180000E-01	8.8551000E-01
2.1952000E+03	5.8876000E-01	8.3003000E-01	4.8869000E-01	8.7992000E-01
2.1953000E+03	5.8495000E-01	8.3001000E-01	4.8551000E-01	8.7419000E-01
2.1954000E+03	5.8104000E-01	8.3000000E-01	4.8226000E-01	8.6833000E-01
2.1955000E+03	5.7705000E-01	8.2998000E-01	4.7894000E-01	8.6235000E-01
2.1956000E+03	5.7297000E-01	8.2996000E-01	4.7554000E-01	8.5624000E-01
2.1957000E+03	5.6881000E-01	8.2994000E-01	4.7208000E-01	8.5000000E-01
2.1958000E+03	5.6456000E-01	8.2992000E-01	4.6854000E-01	8.4363000E-01
2.1959000E+03	5.6022000E-01	8.2991000E-01	4.6493000E-01	8.3713000E-01
2.1960000E+03	5.5580000E-01	8.2989000E-01	4.6125000E-01	8.3051000E-01
2.1961000E+03	5.5130000E-01	8.2986000E-01	4.5750000E-01	8.2375000E-01
2.1962000E+03	5.4671000E-01	8.2983000E-01	4.5368000E-01	8.1687000E-01
2.1963000E+03	5.4204000E-01	8.2980000E-01	4.4979000E-01	8.0986000E-01
2.1964000E+03	5.3729000E-01	8.2978000E-01	4.4583000E-01	8.0273000E-01
2.1965000E+03	5.3245000E-01	8.2975000E-01	4.4180000E-01	7.9548000E-01
2.1966000E+03	5.2753000E-01	8.2972000E-01	4.3770000E-01	7.8811000E-01
2.1967000E+03	5.2253000E-01	8.2969000E-01	4.3354000E-01	7.8061000E-01

2.1968000E+03	5.1746000E-01	8.2966000E-01	4.2931000E-01	7.7300000E-01
2.1969000E+03	5.1230000E-01	8.2964000E-01	4.2502000E-01	7.6527000E-01
2.1970000E+03	5.0706000E-01	8.2961000E-01	4.2067000E-01	7.5743000E-01
2.1971000E+03	5.0175000E-01	8.2959000E-01	4.1625000E-01	7.4947000E-01
2.1972000E+03	4.9637000E-01	8.2956000E-01	4.1177000E-01	7.4141000E-01
2.1973000E+03	4.9091000E-01	8.2954000E-01	4.0723000E-01	7.3323000E-01
2.1974000E+03	4.8537000E-01	8.2952000E-01	4.0262000E-01	7.2495000E-01
2.1975000E+03	4.7977000E-01	8.2950000E-01	3.9796000E-01	7.1656000E-01
2.1976000E+03	4.7409000E-01	8.2947000E-01	3.9325000E-01	7.0806000E-01
2.1977000E+03	4.6835000E-01	8.2945000E-01	3.8847000E-01	6.9947000E-01
2.1978000E+03	4.6254000E-01	8.2943000E-01	3.8365000E-01	6.9077000E-01
2.1979000E+03	4.5667000E-01	8.2941000E-01	3.7876000E-01	6.8198000E-01
2.1980000E+03	4.5074000E-01	8.2938000E-01	3.7383000E-01	6.7310000E-01
2.1981000E+03	4.4474000E-01	8.2940000E-01	3.6887000E-01	6.6416000E-01
2.1982000E+03	4.3869000E-01	8.2941000E-01	3.6385000E-01	6.5514000E-01
2.1983000E+03	4.3258000E-01	8.2943000E-01	3.5880000E-01	6.4603000E-01
2.1984000E+03	4.2642000E-01	8.2945000E-01	3.5369000E-01	6.3685000E-01
2.1985000E+03	4.2021000E-01	8.2946000E-01	3.4855000E-01	6.2758000E-01
2.1986000E+03	4.1396000E-01	8.2948000E-01	3.4337000E-01	6.1825000E-01
2.1987000E+03	4.0766000E-01	8.2949000E-01	3.3815000E-01	6.0885000E-01
2.1988000E+03	4.0131000E-01	8.2951000E-01	3.3289000E-01	5.9939000E-01
2.1989000E+03	3.9493000E-01	8.2953000E-01	3.2761000E-01	5.8987000E-01
2.1990000E+03	3.8852000E-01	8.2954000E-01	3.2229000E-01	5.8030000E-01
2.1991000E+03	3.8207000E-01	8.2956000E-01	3.1695000E-01	5.7068000E-01
2.1992000E+03	3.7559000E-01	8.2958000E-01	3.1158000E-01	5.6102000E-01
2.1993000E+03	3.6909000E-01	8.2959000E-01	3.0620000E-01	5.5132000E-01
2.1994000E+03	3.6257000E-01	8.2961000E-01	3.0079000E-01	5.4159000E-01
2.1995000E+03	3.5603000E-01	8.2963000E-01	2.9538000E-01	5.3184000E-01
2.1996000E+03	3.4948000E-01	8.2964000E-01	2.8995000E-01	5.2206000E-01
2.1997000E+03	3.4292000E-01	8.2966000E-01	2.8451000E-01	5.1227000E-01
2.1998000E+03	3.3635000E-01	8.2968000E-01	2.7906000E-01	5.0247000E-01
2.1999000E+03	3.2978000E-01	8.2969000E-01	2.7362000E-01	4.9267000E-01
2.2000000E+03	3.2322000E-01	8.2971000E-01	2.6818000E-01	4.8287000E-01
2.2001000E+03	3.1666000E-01	8.2969000E-01	2.6273000E-01	4.7305000E-01
2.2002000E+03	3.1011000E-01	8.2966000E-01	2.5728000E-01	4.6325000E-01
2.2003000E+03	3.0357000E-01	8.2964000E-01	2.5186000E-01	4.5348000E-01
2.2004000E+03	2.9706000E-01	8.2961000E-01	2.4644000E-01	4.4373000E-01
2.2005000E+03	2.9057000E-01	8.2959000E-01	2.4105000E-01	4.3402000E-01
2.2006000E+03	2.8410000E-01	8.2957000E-01	2.3568000E-01	4.2435000E-01
2.2007000E+03	2.7767000E-01	8.2954000E-01	2.3034000E-01	4.1473000E-01
2.2008000E+03	2.7127000E-01	8.2952000E-01	2.2502000E-01	4.0517000E-01
2.2009000E+03	2.6491000E-01	8.2949000E-01	2.1975000E-01	3.9566000E-01
2.2010000E+03	2.5860000E-01	8.2947000E-01	2.1450000E-01	3.8622000E-01

2.2011000E+03	2.5234000E-01	8.2944000E-01	2.0930000E-01	3.7686000E-01
2.2012000E+03	2.4613000E-01	8.2942000E-01	2.0414000E-01	3.6757000E-01
2.2013000E+03	2.3997000E-01	8.2940000E-01	1.9903000E-01	3.5837000E-01
2.2014000E+03	2.3388000E-01	8.2937000E-01	1.9397000E-01	3.4925000E-01
2.2015000E+03	2.2785000E-01	8.2935000E-01	1.8896000E-01	3.4024000E-01
2.2016000E+03	2.2188000E-01	8.2932000E-01	1.8401000E-01	3.3132000E-01
2.2017000E+03	2.1599000E-01	8.2930000E-01	1.7912000E-01	3.2251000E-01
2.2018000E+03	2.1017000E-01	8.2927000E-01	1.7429000E-01	3.1381000E-01
2.2019000E+03	2.0443000E-01	8.2925000E-01	1.6952000E-01	3.0523000E-01
2.2020000E+03	1.9877000E-01	8.2922000E-01	1.6482000E-01	2.9677000E-01
2.2021000E+03	1.9319000E-01	8.2920000E-01	1.6019000E-01	2.8844000E-01
2.2022000E+03	1.8770000E-01	8.2918000E-01	1.5564000E-01	2.8023000E-01
2.2023000E+03	1.8230000E-01	8.2916000E-01	1.5115000E-01	2.7216000E-01
2.2024000E+03	1.7699000E-01	8.2913000E-01	1.4675000E-01	2.6422000E-01
2.2025000E+03	1.7177000E-01	8.2911000E-01	1.4242000E-01	2.5643000E-01
2.2026000E+03	1.6665000E-01	8.2909000E-01	1.3816000E-01	2.4877000E-01
2.2027000E+03	1.6162000E-01	8.2906000E-01	1.3399000E-01	2.4126000E-01
2.2028000E+03	1.5670000E-01	8.2904000E-01	1.2991000E-01	2.3390000E-01
2.2029000E+03	1.5187000E-01	8.2902000E-01	1.2590000E-01	2.2669000E-01
2.2030000E+03	1.4715000E-01	8.2900000E-01	1.2198000E-01	2.1964000E-01
2.2031000E+03	1.4252000E-01	8.2897000E-01	1.1815000E-01	2.1273000E-01
2.2032000E+03	1.3800000E-01	8.2894000E-01	1.1440000E-01	2.0598000E-01
2.2033000E+03	1.3359000E-01	8.2892000E-01	1.1073000E-01	1.9938000E-01
2.2034000E+03	1.2928000E-01	8.2889000E-01	1.0716000E-01	1.9294000E-01
2.2035000E+03	1.2507000E-01	8.2886000E-01	1.0367000E-01	1.8666000E-01
2.2036000E+03	1.2097000E-01	8.2884000E-01	1.0026000E-01	1.8053000E-01
2.2037000E+03	1.1697000E-01	8.2881000E-01	9.6946000E-02	1.7456000E-01
2.2038000E+03	1.1308000E-01	8.2879000E-01	9.3716000E-02	1.6874000E-01
2.2039000E+03	1.0929000E-01	8.2876000E-01	9.0572000E-02	1.6308000E-01
2.2040000E+03	1.0560000E-01	8.2873000E-01	8.7513000E-02	1.5757000E-01
2.2041000E+03	1.0201000E-01	8.2872000E-01	8.4539000E-02	1.5222000E-01
2.2042000E+03	9.8527000E-02	8.2870000E-01	8.1649000E-02	1.4701000E-01
2.2043000E+03	9.5142000E-02	8.2868000E-01	7.8842000E-02	1.4196000E-01
2.2044000E+03	9.1855000E-02	8.2866000E-01	7.6116000E-02	1.3705000E-01
2.2045000E+03	8.8665000E-02	8.2864000E-01	7.3471000E-02	1.3229000E-01
2.2046000E+03	8.5571000E-02	8.2862000E-01	7.0906000E-02	1.2767000E-01
2.2047000E+03	8.2571000E-02	8.2860000E-01	6.8418000E-02	1.2319000E-01
2.2048000E+03	7.9664000E-02	8.2858000E-01	6.6008000E-02	1.1885000E-01
2.2049000E+03	7.6847000E-02	8.2856000E-01	6.3672000E-02	1.1464000E-01
2.2050000E+03	7.4118000E-02	8.2854000E-01	6.1410000E-02	1.1057000E-01
2.2051000E+03	7.1477000E-02	8.2852000E-01	5.9220000E-02	1.0663000E-01
2.2052000E+03	6.8920000E-02	8.2850000E-01	5.7100000E-02	1.0281000E-01
2.2053000E+03	6.6447000E-02	8.2848000E-01	5.5050000E-02	9.9120000E-02

2.2054000E+03	6.4054000E-02	8.2845000E-01	5.3066000E-02	9.5548000E-02
2.2055000E+03	6.1740000E-02	8.2843000E-01	5.1148000E-02	9.2094000E-02
2.2056000E+03	5.9504000E-02	8.2841000E-01	4.9293000E-02	8.8755000E-02
2.2057000E+03	5.7342000E-02	8.2839000E-01	4.7501000E-02	8.5528000E-02
2.2058000E+03	5.5253000E-02	8.2836000E-01	4.5769000E-02	8.2410000E-02
2.2059000E+03	5.3234000E-02	8.2834000E-01	4.4096000E-02	7.9397000E-02
2.2060000E+03	5.1285000E-02	8.2832000E-01	4.2480000E-02	7.6488000E-02
2.2061000E+03	4.9726000E-02	8.2833000E-01	4.1190000E-02	7.4164000E-02
2.2062000E+03	4.7899000E-02	8.2833000E-01	3.9676000E-02	7.1439000E-02
2.2063000E+03	4.6135000E-02	8.2834000E-01	3.8215000E-02	6.8809000E-02
2.2064000E+03	4.4432000E-02	8.2835000E-01	3.6805000E-02	6.6269000E-02
2.2065000E+03	4.2788000E-02	8.2836000E-01	3.5444000E-02	6.3818000E-02
2.2066000E+03	4.1202000E-02	8.2837000E-01	3.4130000E-02	6.1454000E-02
2.2067000E+03	3.9672000E-02	8.2837000E-01	3.2863000E-02	5.9172000E-02
2.2068000E+03	3.8197000E-02	8.2838000E-01	3.1641000E-02	5.6972000E-02
2.2069000E+03	3.6774000E-02	8.2839000E-01	3.0463000E-02	5.4850000E-02
2.2070000E+03	3.5402000E-02	8.2840000E-01	2.9327000E-02	5.2804000E-02
2.2071000E+03	3.4079000E-02	8.2841000E-01	2.8232000E-02	5.0833000E-02
2.2072000E+03	3.2805000E-02	8.2843000E-01	2.7177000E-02	4.8933000E-02
2.2073000E+03	3.1577000E-02	8.2844000E-01	2.6160000E-02	4.7102000E-02
2.2074000E+03	3.0395000E-02	8.2846000E-01	2.5181000E-02	4.5339000E-02
2.2075000E+03	2.9256000E-02	8.2848000E-01	2.4238000E-02	4.3642000E-02
2.2076000E+03	2.8160000E-02	8.2849000E-01	2.3330000E-02	4.2007000E-02
2.2077000E+03	2.7105000E-02	8.2851000E-01	2.2457000E-02	4.0435000E-02
2.2078000E+03	2.6090000E-02	8.2852000E-01	2.1616000E-02	3.8921000E-02
2.2079000E+03	2.5114000E-02	8.2854000E-01	2.0808000E-02	3.7466000E-02
2.2080000E+03	2.4176000E-02	8.2856000E-01	2.0031000E-02	3.6067000E-02
2.2081000E+03	2.3274000E-02	8.2854000E-01	1.9284000E-02	3.4722000E-02
2.2082000E+03	2.2408000E-02	8.2853000E-01	1.8566000E-02	3.3429000E-02
2.2083000E+03	2.1576000E-02	8.2852000E-01	1.7876000E-02	3.2187000E-02
2.2084000E+03	2.0778000E-02	8.2851000E-01	1.7215000E-02	3.0996000E-02
2.2085000E+03	2.0012000E-02	8.2849000E-01	1.6579000E-02	2.9852000E-02
2.2086000E+03	1.9277000E-02	8.2848000E-01	1.5970000E-02	2.8755000E-02
2.2087000E+03	1.8572000E-02	8.2847000E-01	1.5386000E-02	2.7704000E-02
2.2088000E+03	1.7896000E-02	8.2846000E-01	1.4826000E-02	2.6696000E-02
2.2089000E+03	1.7249000E-02	8.2844000E-01	1.4290000E-02	2.5730000E-02
2.2090000E+03	1.6630000E-02	8.2843000E-01	1.3776000E-02	2.4805000E-02
2.2091000E+03	1.6036000E-02	8.2843000E-01	1.3285000E-02	2.3919000E-02
2.2092000E+03	1.5468000E-02	8.2842000E-01	1.2814000E-02	2.3072000E-02
2.2093000E+03	1.4924000E-02	8.2841000E-01	1.2363000E-02	2.2261000E-02
2.2094000E+03	1.4404000E-02	8.2840000E-01	1.1932000E-02	2.1484000E-02
2.2095000E+03	1.3906000E-02	8.2840000E-01	1.1520000E-02	2.0742000E-02
2.2096000E+03	1.3430000E-02	8.2839000E-01	1.1125000E-02	2.0031000E-02

2.2097000E+03	1.2974000E-02	8.2838000E-01	1.0747000E-02	1.9351000E-02
2.2098000E+03	1.2538000E-02	8.2837000E-01	1.0386000E-02	1.8701000E-02
2.2099000E+03	1.2121000E-02	8.2837000E-01	1.0041000E-02	1.8079000E-02
2.2100000E+03	1.1722000E-02	8.2836000E-01	9.7099000E-03	1.7483000E-02
2.2101000E+03	1.1339000E-02	8.2836000E-01	9.3932000E-03	1.6913000E-02
2.2102000E+03	1.0973000E-02	8.2836000E-01	9.0900000E-03	1.6367000E-02
2.2103000E+03	1.0623000E-02	8.2837000E-01	8.7993000E-03	1.5844000E-02
2.2104000E+03	1.0286000E-02	8.2837000E-01	8.5207000E-03	1.5342000E-02
2.2105000E+03	9.9632000E-03	8.2837000E-01	8.2532000E-03	1.4860000E-02
2.2106000E+03	9.6532000E-03	8.2837000E-01	7.9964000E-03	1.4398000E-02
2.2107000E+03	9.3553000E-03	8.2837000E-01	7.7496000E-03	1.3954000E-02
2.2108000E+03	9.0686000E-03	8.2837000E-01	7.5122000E-03	1.3526000E-02
2.2109000E+03	8.7926000E-03	8.2838000E-01	7.2836000E-03	1.3114000E-02
2.2110000E+03	8.5266000E-03	8.2838000E-01	7.0633000E-03	1.2718000E-02
2.2111000E+03	8.2699000E-03	8.2842000E-01	6.8510000E-03	1.2335000E-02
2.2112000E+03	8.0220000E-03	8.2845000E-01	6.6459000E-03	1.1966000E-02
2.2113000E+03	7.7822000E-03	8.2849000E-01	6.4475000E-03	1.1609000E-02
2.2114000E+03	7.5501000E-03	8.2853000E-01	6.2555000E-03	1.1263000E-02
2.2115000E+03	7.3252000E-03	8.2857000E-01	6.0695000E-03	1.0928000E-02
2.2116000E+03	7.1070000E-03	8.2861000E-01	5.8889000E-03	1.0603000E-02
2.2117000E+03	6.8951000E-03	8.2865000E-01	5.7136000E-03	1.0288000E-02
2.2118000E+03	6.6892000E-03	8.2869000E-01	5.5432000E-03	9.9809000E-03
2.2119000E+03	6.4889000E-03	8.2873000E-01	5.3775000E-03	9.6824000E-03
2.2120000E+03	6.2938000E-03	8.2876000E-01	5.2161000E-03	9.3919000E-03
2.2121000E+03	6.1038000E-03	8.2880000E-01	5.0588000E-03	9.1087000E-03
2.2122000E+03	5.9186000E-03	8.2883000E-01	4.9056000E-03	8.8327000E-03
2.2123000E+03	5.7380000E-03	8.2887000E-01	4.7561000E-03	8.5635000E-03
2.2124000E+03	5.5618000E-03	8.2890000E-01	4.6102000E-03	8.3009000E-03
2.2125000E+03	5.3899000E-03	8.2894000E-01	4.4679000E-03	8.0447000E-03
2.2126000E+03	5.2222000E-03	8.2897000E-01	4.3290000E-03	7.7947000E-03
2.2127000E+03	5.0585000E-03	8.2900000E-01	4.1935000E-03	7.5507000E-03
2.2128000E+03	4.8988000E-03	8.2904000E-01	4.0613000E-03	7.3126000E-03
2.2129000E+03	4.7431000E-03	8.2907000E-01	3.9324000E-03	7.0805000E-03
2.2130000E+03	4.5914000E-03	8.2911000E-01	3.8067000E-03	6.8542000E-03
2.2131000E+03	4.4435000E-03	8.2914000E-01	3.6843000E-03	6.6338000E-03
2.2132000E+03	4.2996000E-03	8.2917000E-01	3.5651000E-03	6.4192000E-03
2.2133000E+03	4.1597000E-03	8.2920000E-01	3.4493000E-03	6.2106000E-03
2.2134000E+03	4.0238000E-03	8.2924000E-01	3.3367000E-03	6.0079000E-03
2.2135000E+03	3.8919000E-03	8.2927000E-01	3.2275000E-03	5.8112000E-03
2.2136000E+03	3.7642000E-03	8.2930000E-01	3.1216000E-03	5.6207000E-03
2.2137000E+03	3.6406000E-03	8.2933000E-01	3.0193000E-03	5.4363000E-03
2.2138000E+03	3.5212000E-03	8.2937000E-01	2.9204000E-03	5.2583000E-03
2.2139000E+03	3.4061000E-03	8.2940000E-01	2.8250000E-03	5.0866000E-03

2.2140000E+03	3.2953000E-03	8.2943000E-01	2.7332000E-03	4.9213000E-03
2.2141000E+03	3.1889000E-03	8.2946000E-01	2.6451000E-03	4.7626000E-03
2.2142000E+03	3.0868000E-03	8.2950000E-01	2.5605000E-03	4.6103000E-03
2.2143000E+03	2.9891000E-03	8.2953000E-01	2.4796000E-03	4.4646000E-03
2.2144000E+03	2.8958000E-03	8.2956000E-01	2.4023000E-03	4.3254000E-03
2.2145000E+03	2.8069000E-03	8.2960000E-01	2.3286000E-03	4.1928000E-03
2.2146000E+03	2.7223000E-03	8.2963000E-01	2.2585000E-03	4.0665000E-03
2.2147000E+03	2.6419000E-03	8.2966000E-01	2.1919000E-03	3.9466000E-03
2.2148000E+03	2.5657000E-03	8.2969000E-01	2.1287000E-03	3.8329000E-03
2.2149000E+03	2.4935000E-03	8.2973000E-01	2.0689000E-03	3.7252000E-03
2.2150000E+03	2.4252000E-03	8.2976000E-01	2.0123000E-03	3.6233000E-03
2.2151000E+03	2.3606000E-03	8.2979000E-01	1.9588000E-03	3.5269000E-03
2.2152000E+03	0.0000000E+00	8.2982000E-01	0.0000000E+00	0.0000000E+00
Channel 14				
Wavenumber	HIRS Filter Transmittance	Optical Element Transmittance	Product of the HIRS Filter and Optical Element Transmittances	Normalized Value of Column 4
2.1799000E+03	0.0000000E+00	8.3196000E-01	0.0000000E+00	0.0000000E+00
2.1800000E+03	1.7930000E-03	8.3195000E-01	1.4917000E-03	2.4369000E-03
2.1801000E+03	1.7946000E-03	8.3192000E-01	1.4930000E-03	2.4390000E-03
2.1802000E+03	1.8174000E-03	8.3190000E-01	1.5119000E-03	2.4699000E-03
2.1803000E+03	1.8613000E-03	8.3188000E-01	1.5483000E-03	2.5294000E-03
2.1804000E+03	1.9256000E-03	8.3185000E-01	1.6018000E-03	2.6168000E-03
2.1805000E+03	2.0091000E-03	8.3183000E-01	1.6712000E-03	2.7302000E-03
2.1806000E+03	2.1097000E-03	8.3180000E-01	1.7548000E-03	2.8668000E-03
2.1807000E+03	2.2249000E-03	8.3178000E-01	1.8506000E-03	3.0233000E-03
2.1808000E+03	2.3518000E-03	8.3176000E-01	1.9561000E-03	3.1956000E-03
2.1809000E+03	2.4870000E-03	8.3173000E-01	2.0685000E-03	3.3792000E-03
2.1810000E+03	2.6269000E-03	8.3171000E-01	2.1848000E-03	3.5692000E-03
2.1811000E+03	2.7679000E-03	8.3168000E-01	2.3020000E-03	3.7607000E-03
2.1812000E+03	2.9062000E-03	8.3166000E-01	2.4170000E-03	3.9485000E-03
2.1813000E+03	3.0382000E-03	8.3164000E-01	2.5267000E-03	4.1277000E-03
2.1814000E+03	3.1605000E-03	8.3161000E-01	2.6283000E-03	4.2938000E-03
2.1815000E+03	3.2701000E-03	8.3159000E-01	2.7194000E-03	4.4425000E-03
2.1816000E+03	3.3641000E-03	8.3157000E-01	2.7975000E-03	4.5701000E-03
2.1817000E+03	3.4403000E-03	8.3154000E-01	2.8608000E-03	4.6735000E-03
2.1818000E+03	3.4970000E-03	8.3152000E-01	2.9078000E-03	4.7504000E-03
2.1819000E+03	3.5330000E-03	8.3149000E-01	2.9377000E-03	4.7992000E-03
2.1820000E+03	3.5479000E-03	8.3147000E-01	2.9500000E-03	4.8192000E-03
2.1821000E+03	3.5416000E-03	8.3148000E-01	2.9448000E-03	4.8108000E-03
2.1822000E+03	3.5149000E-03	8.3150000E-01	2.9226000E-03	4.7745000E-03
2.1823000E+03	3.4689000E-03	8.3151000E-01	2.8844000E-03	4.7122000E-03

2.1824000E+03	3.4056000E-03	8.3152000E-01	2.8318000E-03	4.6262000E-03
2.1825000E+03	3.3270000E-03	8.3153000E-01	2.7665000E-03	4.5195000E-03
2.1826000E+03	3.2359000E-03	8.3154000E-01	2.6908000E-03	4.3958000E-03
2.1827000E+03	3.1351000E-03	8.3155000E-01	2.6070000E-03	4.2589000E-03
2.1828000E+03	3.0277000E-03	8.3156000E-01	2.5177000E-03	4.1131000E-03
2.1829000E+03	2.9169000E-03	8.3157000E-01	2.4256000E-03	3.9626000E-03
2.1830000E+03	2.8058000E-03	8.3159000E-01	2.3333000E-03	3.8117000E-03
2.1831000E+03	2.6975000E-03	8.3159000E-01	2.2432000E-03	3.6646000E-03
2.1832000E+03	2.5947000E-03	8.3160000E-01	2.1578000E-03	3.5250000E-03
2.1833000E+03	2.5001000E-03	8.3161000E-01	2.0791000E-03	3.3966000E-03
2.1834000E+03	2.4160000E-03	8.3162000E-01	2.0092000E-03	3.2823000E-03
2.1835000E+03	2.3442000E-03	8.3163000E-01	1.9495000E-03	3.1848000E-03
2.1836000E+03	2.2863000E-03	8.3164000E-01	1.9013000E-03	3.1061000E-03
2.1837000E+03	2.2434000E-03	8.3165000E-01	1.8657000E-03	3.0479000E-03
2.1838000E+03	2.2163000E-03	8.3166000E-01	1.8432000E-03	3.0111000E-03
2.1839000E+03	2.2054000E-03	8.3167000E-01	1.8342000E-03	2.9964000E-03
2.1840000E+03	2.2108000E-03	8.3167000E-01	1.8387000E-03	3.0038000E-03
2.1841000E+03	2.2323000E-03	8.3165000E-01	1.8565000E-03	3.0328000E-03
2.1842000E+03	2.2691000E-03	8.3162000E-01	1.8871000E-03	3.0828000E-03
2.1843000E+03	2.3206000E-03	8.3159000E-01	1.9298000E-03	3.1527000E-03
2.1844000E+03	2.3857000E-03	8.3157000E-01	1.9839000E-03	3.2410000E-03
2.1845000E+03	2.4633000E-03	8.3154000E-01	2.0483000E-03	3.3463000E-03
2.1846000E+03	2.5519000E-03	8.3151000E-01	2.1220000E-03	3.4665000E-03
2.1847000E+03	2.6502000E-03	8.3149000E-01	2.2036000E-03	3.5999000E-03
2.1848000E+03	2.7567000E-03	8.3146000E-01	2.2921000E-03	3.7444000E-03
2.1849000E+03	2.8697000E-03	8.3143000E-01	2.3860000E-03	3.8979000E-03
2.1850000E+03	2.9880000E-03	8.3141000E-01	2.4842000E-03	4.0584000E-03
2.1851000E+03	3.1099000E-03	8.3138000E-01	2.5855000E-03	4.2238000E-03
2.1852000E+03	3.2340000E-03	8.3135000E-01	2.6886000E-03	4.3922000E-03
2.1853000E+03	3.3591000E-03	8.3132000E-01	2.7925000E-03	4.5619000E-03
2.1854000E+03	3.4839000E-03	8.3129000E-01	2.8961000E-03	4.7313000E-03
2.1855000E+03	3.6073000E-03	8.3126000E-01	2.9986000E-03	4.8986000E-03
2.1856000E+03	3.7282000E-03	8.3122000E-01	3.0989000E-03	5.0626000E-03
2.1857000E+03	3.8455000E-03	8.3119000E-01	3.1964000E-03	5.2218000E-03
2.1858000E+03	3.9585000E-03	8.3116000E-01	3.2902000E-03	5.3750000E-03
2.1859000E+03	4.0662000E-03	8.3113000E-01	3.3796000E-03	5.5211000E-03
2.1860000E+03	4.1679000E-03	8.3110000E-01	3.4639000E-03	5.6588000E-03
2.1861000E+03	4.2625000E-03	8.3107000E-01	3.5425000E-03	5.7871000E-03
2.1862000E+03	4.3496000E-03	8.3103000E-01	3.6146000E-03	5.9050000E-03
2.1863000E+03	4.4283000E-03	8.3099000E-01	3.6799000E-03	6.0116000E-03
2.1864000E+03	4.4980000E-03	8.3095000E-01	3.7376000E-03	6.1059000E-03
2.1865000E+03	4.5582000E-03	8.3091000E-01	3.7874000E-03	6.1874000E-03
2.1866000E+03	4.6084000E-03	8.3087000E-01	3.8290000E-03	6.2553000E-03

2.1867000E+03	4.6484000E-03	8.3084000E-01	3.8621000E-03	6.3093000E-03
2.1868000E+03	4.6780000E-03	8.3080000E-01	3.8865000E-03	6.3492000E-03
2.1869000E+03	4.6974000E-03	8.3076000E-01	3.9024000E-03	6.3751000E-03
2.1870000E+03	4.7068000E-03	8.3072000E-01	3.9100000E-03	6.3876000E-03
2.1871000E+03	4.7067000E-03	8.3069000E-01	3.9098000E-03	6.3872000E-03
2.1872000E+03	4.6978000E-03	8.3066000E-01	3.9023000E-03	6.3750000E-03
2.1873000E+03	4.6814000E-03	8.3062000E-01	3.8885000E-03	6.3524000E-03
2.1874000E+03	4.6585000E-03	8.3059000E-01	3.8693000E-03	6.3211000E-03
2.1875000E+03	4.6308000E-03	8.3056000E-01	3.8461000E-03	6.2832000E-03
2.1876000E+03	4.5998000E-03	8.3053000E-01	3.8203000E-03	6.2409000E-03
2.1877000E+03	4.5676000E-03	8.3049000E-01	3.7933000E-03	6.1970000E-03
2.1878000E+03	4.5361000E-03	8.3046000E-01	3.7670000E-03	6.1540000E-03
2.1879000E+03	4.5075000E-03	8.3043000E-01	3.7432000E-03	6.1150000E-03
2.1880000E+03	4.4841000E-03	8.3040000E-01	3.7236000E-03	6.0831000E-03
2.1881000E+03	4.4682000E-03	8.3042000E-01	3.7104000E-03	6.0616000E-03
2.1882000E+03	4.4619000E-03	8.3044000E-01	3.7053000E-03	6.0531000E-03
2.1883000E+03	4.4673000E-03	8.3046000E-01	3.7099000E-03	6.0607000E-03
2.1884000E+03	4.4865000E-03	8.3048000E-01	3.7260000E-03	6.0869000E-03
2.1885000E+03	4.5213000E-03	8.3050000E-01	3.7549000E-03	6.1342000E-03
2.1886000E+03	4.5731000E-03	8.3052000E-01	3.7981000E-03	6.2047000E-03
2.1887000E+03	4.6432000E-03	8.3054000E-01	3.8564000E-03	6.3000000E-03
2.1888000E+03	4.7325000E-03	8.3057000E-01	3.9307000E-03	6.4213000E-03
2.1889000E+03	4.8414000E-03	8.3059000E-01	4.0212000E-03	6.5693000E-03
2.1890000E+03	4.9701000E-03	8.3061000E-01	4.1282000E-03	6.7440000E-03
2.1891000E+03	5.1182000E-03	8.3063000E-01	4.2513000E-03	6.9452000E-03
2.1892000E+03	5.2850000E-03	8.3066000E-01	4.3901000E-03	7.1718000E-03
2.1893000E+03	5.4696000E-03	8.3068000E-01	4.5435000E-03	7.4224000E-03
2.1894000E+03	5.6704000E-03	8.3071000E-01	4.7104000E-03	7.6952000E-03
2.1895000E+03	5.8859000E-03	8.3073000E-01	4.8896000E-03	7.9878000E-03
2.1896000E+03	6.1141000E-03	8.3076000E-01	5.0793000E-03	8.2978000E-03
2.1897000E+03	6.3530000E-03	8.3078000E-01	5.2780000E-03	8.6223000E-03
2.1898000E+03	6.6006000E-03	8.3080000E-01	5.4838000E-03	8.9587000E-03
2.1899000E+03	6.8548000E-03	8.3083000E-01	5.6952000E-03	9.3039000E-03
2.1900000E+03	7.1136000E-03	8.3085000E-01	5.9104000E-03	9.6555000E-03
2.1901000E+03	7.3752000E-03	8.3085000E-01	6.1277000E-03	1.0011000E-02
2.1902000E+03	7.6380000E-03	8.3085000E-01	6.3460000E-03	1.0367000E-02
2.1903000E+03	7.9006000E-03	8.3085000E-01	6.5642000E-03	1.0724000E-02
2.1904000E+03	8.1621000E-03	8.3084000E-01	6.7814000E-03	1.1078000E-02
2.1905000E+03	8.4218000E-03	8.3084000E-01	6.9971000E-03	1.1431000E-02
2.1906000E+03	8.6793000E-03	8.3084000E-01	7.2111000E-03	1.1780000E-02
2.1907000E+03	8.9350000E-03	8.3084000E-01	7.4235000E-03	1.2127000E-02
2.1908000E+03	9.1891000E-03	8.3083000E-01	7.6346000E-03	1.2472000E-02
2.1909000E+03	9.4426000E-03	8.3083000E-01	7.8452000E-03	1.2816000E-02

2.1910000E+03	9.6965000E-03	8.3083000E-01	8.0561000E-03	1.3161000E-02
2.1911000E+03	9.9523000E-03	8.3083000E-01	8.2686000E-03	1.3508000E-02
2.1912000E+03	1.0212000E-02	8.3082000E-01	8.4840000E-03	1.3860000E-02
2.1913000E+03	1.0476000E-02	8.3082000E-01	8.7038000E-03	1.4219000E-02
2.1914000E+03	1.0748000E-02	8.3082000E-01	8.9295000E-03	1.4588000E-02
2.1915000E+03	1.1029000E-02	8.3081000E-01	9.1627000E-03	1.4969000E-02
2.1916000E+03	1.1320000E-02	8.3081000E-01	9.4048000E-03	1.5364000E-02
2.1917000E+03	1.1624000E-02	8.3081000E-01	9.6573000E-03	1.5777000E-02
2.1918000E+03	1.1942000E-02	8.3080000E-01	9.9213000E-03	1.6208000E-02
2.1919000E+03	1.2275000E-02	8.3080000E-01	1.0198000E-02	1.6660000E-02
2.1920000E+03	1.2624000E-02	8.3080000E-01	1.0488000E-02	1.7133000E-02
2.1921000E+03	1.2989000E-02	8.3077000E-01	1.0791000E-02	1.7629000E-02
2.1922000E+03	1.3372000E-02	8.3074000E-01	1.1108000E-02	1.8147000E-02
2.1923000E+03	1.3771000E-02	8.3072000E-01	1.1440000E-02	1.8688000E-02
2.1924000E+03	1.4103000E-02	8.3069000E-01	1.1715000E-02	1.9138000E-02
2.1925000E+03	1.4540000E-02	8.3066000E-01	1.2078000E-02	1.9731000E-02
2.1926000E+03	1.4992000E-02	8.3064000E-01	1.2453000E-02	2.0344000E-02
2.1927000E+03	1.5460000E-02	8.3061000E-01	1.2841000E-02	2.0978000E-02
2.1928000E+03	1.5940000E-02	8.3059000E-01	1.3240000E-02	2.1629000E-02
2.1929000E+03	1.6432000E-02	8.3056000E-01	1.3648000E-02	2.2296000E-02
2.1930000E+03	1.6934000E-02	8.3053000E-01	1.4064000E-02	2.2976000E-02
2.1931000E+03	1.7445000E-02	8.3051000E-01	1.4488000E-02	2.3669000E-02
2.1932000E+03	1.7965000E-02	8.3048000E-01	1.4919000E-02	2.4373000E-02
2.1933000E+03	1.8492000E-02	8.3045000E-01	1.5357000E-02	2.5087000E-02
2.1934000E+03	1.9027000E-02	8.3042000E-01	1.5800000E-02	2.5812000E-02
2.1935000E+03	1.9571000E-02	8.3040000E-01	1.6252000E-02	2.6549000E-02
2.1936000E+03	2.0125000E-02	8.3037000E-01	1.6711000E-02	2.7300000E-02
2.1937000E+03	2.0691000E-02	8.3034000E-01	1.7180000E-02	2.8066000E-02
2.1938000E+03	2.1271000E-02	8.3031000E-01	1.7661000E-02	2.8853000E-02
2.1939000E+03	2.1869000E-02	8.3028000E-01	1.8158000E-02	2.9663000E-02
2.1940000E+03	2.2489000E-02	8.3026000E-01	1.8672000E-02	3.0503000E-02
2.1941000E+03	2.3136000E-02	8.3024000E-01	1.9208000E-02	3.1379000E-02
2.1942000E+03	2.3814000E-02	8.3022000E-01	1.9771000E-02	3.2298000E-02
2.1943000E+03	2.4528000E-02	8.3020000E-01	2.0364000E-02	3.3267000E-02
2.1944000E+03	2.5286000E-02	8.3018000E-01	2.0992000E-02	3.4293000E-02
2.1945000E+03	2.6092000E-02	8.3016000E-01	2.1661000E-02	3.5386000E-02
2.1946000E+03	2.6953000E-02	8.3014000E-01	2.2375000E-02	3.6553000E-02
2.1947000E+03	2.7875000E-02	8.3012000E-01	2.3139000E-02	3.7802000E-02
2.1948000E+03	2.8863000E-02	8.3011000E-01	2.3959000E-02	3.9141000E-02
2.1949000E+03	2.9923000E-02	8.3009000E-01	2.4839000E-02	4.0578000E-02
2.1950000E+03	3.1061000E-02	8.3007000E-01	2.5783000E-02	4.2120000E-02
2.1951000E+03	3.2281000E-02	8.3005000E-01	2.6795000E-02	4.3773000E-02
2.1952000E+03	3.3587000E-02	8.3003000E-01	2.7878000E-02	4.5543000E-02

2.1953000E+03	3.4983000E-02	8.3001000E-01	2.9036000E-02	4.7435000E-02
2.1954000E+03	3.6472000E-02	8.3000000E-01	3.0272000E-02	4.9453000E-02
2.1955000E+03	3.8056000E-02	8.2998000E-01	3.1586000E-02	5.1600000E-02
2.1956000E+03	3.9737000E-02	8.2996000E-01	3.2980000E-02	5.3878000E-02
2.1957000E+03	4.1516000E-02	8.2994000E-01	3.4456000E-02	5.6289000E-02
2.1958000E+03	4.3394000E-02	8.2992000E-01	3.6014000E-02	5.8834000E-02
2.1959000E+03	4.5372000E-02	8.2991000E-01	3.7654000E-02	6.1514000E-02
2.1960000E+03	4.7449000E-02	8.2989000E-01	3.9377000E-02	6.4328000E-02
2.1961000E+03	4.9625000E-02	8.2986000E-01	4.1182000E-02	6.7276000E-02
2.1962000E+03	5.1900000E-02	8.2983000E-01	4.3068000E-02	7.0359000E-02
2.1963000E+03	5.4275000E-02	8.2980000E-01	4.5037000E-02	7.3575000E-02
2.1964000E+03	5.6748000E-02	8.2978000E-01	4.7088000E-02	7.6926000E-02
2.1965000E+03	5.9321000E-02	8.2975000E-01	4.9221000E-02	8.0411000E-02
2.1966000E+03	6.1994000E-02	8.2972000E-01	5.1438000E-02	8.4031000E-02
2.1967000E+03	6.4769000E-02	8.2969000E-01	5.3738000E-02	8.7789000E-02
2.1968000E+03	6.7647000E-02	8.2966000E-01	5.6124000E-02	9.1687000E-02
2.1969000E+03	7.0630000E-02	8.2964000E-01	5.8597000E-02	9.5728000E-02
2.1970000E+03	7.3723000E-02	8.2961000E-01	6.1161000E-02	9.9916000E-02
2.1971000E+03	7.6928000E-02	8.2959000E-01	6.3818000E-02	1.0426000E-01
2.1972000E+03	8.0249000E-02	8.2956000E-01	6.6572000E-02	1.0876000E-01
2.1973000E+03	8.3693000E-02	8.2954000E-01	6.9427000E-02	1.1342000E-01
2.1974000E+03	8.7264000E-02	8.2952000E-01	7.2387000E-02	1.1825000E-01
2.1975000E+03	9.0968000E-02	8.2950000E-01	7.5458000E-02	1.2327000E-01
2.1976000E+03	9.4812000E-02	8.2947000E-01	7.8644000E-02	1.2848000E-01
2.1977000E+03	9.8803000E-02	8.2945000E-01	8.1952000E-02	1.3388000E-01
2.1978000E+03	1.0295000E-01	8.2943000E-01	8.5386000E-02	1.3949000E-01
2.1979000E+03	1.0725000E-01	8.2941000E-01	8.8954000E-02	1.4532000E-01
2.1980000E+03	1.1172000E-01	8.2938000E-01	9.2659000E-02	1.5137000E-01
2.1981000E+03	1.1636000E-01	8.2940000E-01	9.6510000E-02	1.5766000E-01
2.1982000E+03	1.2118000E-01	8.2941000E-01	1.0051000E-01	1.6420000E-01
2.1983000E+03	1.2619000E-01	8.2943000E-01	1.0466000E-01	1.7098000E-01
2.1984000E+03	1.3138000E-01	8.2945000E-01	1.0897000E-01	1.7803000E-01
2.1985000E+03	1.3677000E-01	8.2946000E-01	1.1344000E-01	1.8533000E-01
2.1986000E+03	1.4235000E-01	8.2948000E-01	1.1808000E-01	1.9289000E-01
2.1987000E+03	1.4813000E-01	8.2949000E-01	1.2287000E-01	2.0073000E-01
2.1988000E+03	1.5411000E-01	8.2951000E-01	1.2783000E-01	2.0883000E-01
2.1989000E+03	1.6028000E-01	8.2953000E-01	1.3296000E-01	2.1721000E-01
2.1990000E+03	1.6666000E-01	8.2954000E-01	1.3825000E-01	2.2585000E-01
2.1991000E+03	1.7323000E-01	8.2956000E-01	1.4370000E-01	2.3476000E-01
2.1992000E+03	1.7999000E-01	8.2958000E-01	1.4931000E-01	2.4392000E-01
2.1993000E+03	1.8694000E-01	8.2959000E-01	1.5508000E-01	2.5335000E-01
2.1994000E+03	1.9407000E-01	8.2961000E-01	1.6100000E-01	2.6302000E-01
2.1995000E+03	2.0138000E-01	8.2963000E-01	1.6707000E-01	2.7294000E-01

2.1996000E+03	2.0886000E-01	8.2964000E-01	1.7328000E-01	2.8308000E-01
2.1997000E+03	2.1651000E-01	8.2966000E-01	1.7963000E-01	2.9345000E-01
2.1998000E+03	2.2431000E-01	8.2968000E-01	1.8610000E-01	3.0402000E-01
2.1999000E+03	2.3225000E-01	8.2969000E-01	1.9270000E-01	3.1480000E-01
2.2000000E+03	2.4033000E-01	8.2971000E-01	1.9940000E-01	3.2576000E-01
2.2001000E+03	2.4854000E-01	8.2969000E-01	2.0621000E-01	3.3687000E-01
2.2002000E+03	2.5686000E-01	8.2966000E-01	2.1311000E-01	3.4814000E-01
2.2003000E+03	2.6528000E-01	8.2964000E-01	2.2009000E-01	3.5955000E-01
2.2004000E+03	2.7380000E-01	8.2961000E-01	2.2715000E-01	3.7109000E-01
2.2005000E+03	2.8241000E-01	8.2959000E-01	2.3428000E-01	3.8273000E-01
2.2006000E+03	2.9108000E-01	8.2957000E-01	2.4147000E-01	3.9448000E-01
2.2007000E+03	2.9981000E-01	8.2954000E-01	2.4871000E-01	4.0630000E-01
2.2008000E+03	3.0859000E-01	8.2952000E-01	2.5598000E-01	4.1819000E-01
2.2009000E+03	3.1741000E-01	8.2949000E-01	2.6329000E-01	4.3012000E-01
2.2010000E+03	3.2625000E-01	8.2947000E-01	2.7062000E-01	4.4209000E-01
2.2011000E+03	3.3511000E-01	8.2944000E-01	2.7795000E-01	4.5408000E-01
2.2012000E+03	3.4397000E-01	8.2942000E-01	2.8529000E-01	4.6607000E-01
2.2013000E+03	3.5282000E-01	8.2940000E-01	2.9262000E-01	4.7805000E-01
2.2014000E+03	3.6165000E-01	8.2937000E-01	2.9994000E-01	4.9000000E-01
2.2015000E+03	3.7045000E-01	8.2935000E-01	3.0723000E-01	5.0190000E-01
2.2016000E+03	3.7921000E-01	8.2932000E-01	3.1448000E-01	5.1376000E-01
2.2017000E+03	3.8791000E-01	8.2930000E-01	3.2170000E-01	5.2554000E-01
2.2018000E+03	3.9656000E-01	8.2927000E-01	3.2886000E-01	5.3724000E-01
2.2019000E+03	4.0514000E-01	8.2925000E-01	3.3596000E-01	5.4884000E-01
2.2020000E+03	4.1364000E-01	8.2922000E-01	3.4300000E-01	5.6034000E-01
2.2021000E+03	4.2205000E-01	8.2920000E-01	3.4996000E-01	5.7172000E-01
2.2022000E+03	4.3036000E-01	8.2918000E-01	3.5685000E-01	5.8297000E-01
2.2023000E+03	4.3858000E-01	8.2916000E-01	3.6365000E-01	5.9407000E-01
2.2024000E+03	4.4668000E-01	8.2913000E-01	3.7036000E-01	6.0503000E-01
2.2025000E+03	4.5466000E-01	8.2911000E-01	3.7697000E-01	6.1583000E-01
2.2026000E+03	4.6252000E-01	8.2909000E-01	3.8347000E-01	6.2646000E-01
2.2027000E+03	4.7025000E-01	8.2906000E-01	3.8987000E-01	6.3691000E-01
2.2028000E+03	4.7785000E-01	8.2904000E-01	3.9616000E-01	6.4718000E-01
2.2029000E+03	4.8531000E-01	8.2902000E-01	4.0233000E-01	6.5726000E-01
2.2030000E+03	4.9262000E-01	8.2900000E-01	4.0838000E-01	6.6715000E-01
2.2031000E+03	4.9978000E-01	8.2897000E-01	4.1430000E-01	6.7683000E-01
2.2032000E+03	5.0679000E-01	8.2894000E-01	4.2010000E-01	6.8630000E-01
2.2033000E+03	5.1365000E-01	8.2892000E-01	4.2577000E-01	6.9556000E-01
2.2034000E+03	5.2034000E-01	8.2889000E-01	4.3131000E-01	7.0460000E-01
2.2035000E+03	5.2688000E-01	8.2886000E-01	4.3671000E-01	7.1343000E-01
2.2036000E+03	5.3324000E-01	8.2884000E-01	4.4197000E-01	7.2203000E-01
2.2037000E+03	5.3944000E-01	8.2881000E-01	4.4710000E-01	7.3040000E-01
2.2038000E+03	5.4547000E-01	8.2879000E-01	4.5208000E-01	7.3854000E-01

2.2039000E+03	5.5133000E-01	8.2876000E-01	4.5692000E-01	7.4645000E-01
2.2040000E+03	5.5701000E-01	8.2873000E-01	4.6162000E-01	7.5412000E-01
2.2041000E+03	5.6252000E-01	8.2872000E-01	4.6617000E-01	7.6155000E-01
2.2042000E+03	5.6785000E-01	8.2870000E-01	4.7057000E-01	7.6875000E-01
2.2043000E+03	5.7299000E-01	8.2868000E-01	4.7483000E-01	7.7570000E-01
2.2044000E+03	5.7796000E-01	8.2866000E-01	4.7893000E-01	7.8240000E-01
2.2045000E+03	5.8274000E-01	8.2864000E-01	4.8288000E-01	7.8885000E-01
2.2046000E+03	5.8733000E-01	8.2862000E-01	4.8667000E-01	7.9505000E-01
2.2047000E+03	5.9174000E-01	8.2860000E-01	4.9032000E-01	8.0100000E-01
2.2048000E+03	5.9596000E-01	8.2858000E-01	4.9380000E-01	8.0670000E-01
2.2049000E+03	6.0000000E-01	8.2856000E-01	4.9714000E-01	8.1215000E-01
2.2050000E+03	6.0385000E-01	8.2854000E-01	5.0032000E-01	8.1734000E-01
2.2051000E+03	6.0752000E-01	8.2852000E-01	5.0334000E-01	8.2228000E-01
2.2052000E+03	6.1100000E-01	8.2850000E-01	5.0621000E-01	8.2697000E-01
2.2053000E+03	6.1430000E-01	8.2848000E-01	5.0893000E-01	8.3142000E-01
2.2054000E+03	6.1742000E-01	8.2845000E-01	5.1150000E-01	8.3562000E-01
2.2055000E+03	6.2036000E-01	8.2843000E-01	5.1393000E-01	8.3958000E-01
2.2056000E+03	6.2314000E-01	8.2841000E-01	5.1621000E-01	8.4331000E-01
2.2057000E+03	6.2574000E-01	8.2839000E-01	5.1835000E-01	8.4681000E-01
2.2058000E+03	6.2818000E-01	8.2836000E-01	5.2036000E-01	8.5009000E-01
2.2059000E+03	6.3046000E-01	8.2834000E-01	5.2224000E-01	8.5315000E-01
2.2060000E+03	6.3259000E-01	8.2832000E-01	5.2399000E-01	8.5601000E-01
2.2061000E+03	6.3458000E-01	8.2833000E-01	5.2564000E-01	8.5871000E-01
2.2062000E+03	6.3642000E-01	8.2833000E-01	5.2717000E-01	8.6121000E-01
2.2063000E+03	6.3814000E-01	8.2834000E-01	5.2860000E-01	8.6354000E-01
2.2064000E+03	6.3973000E-01	8.2835000E-01	5.2992000E-01	8.6571000E-01
2.2065000E+03	6.4121000E-01	8.2836000E-01	5.3115000E-01	8.6772000E-01
2.2066000E+03	6.4258000E-01	8.2837000E-01	5.3229000E-01	8.6958000E-01
2.2067000E+03	6.4386000E-01	8.2837000E-01	5.3335000E-01	8.7131000E-01
2.2068000E+03	6.4504000E-01	8.2838000E-01	5.3434000E-01	8.7292000E-01
2.2069000E+03	6.4615000E-01	8.2839000E-01	5.3526000E-01	8.7443000E-01
2.2070000E+03	6.4718000E-01	8.2840000E-01	5.3612000E-01	8.7583000E-01
2.2071000E+03	6.4815000E-01	8.2841000E-01	5.3693000E-01	8.7716000E-01
2.2072000E+03	6.4906000E-01	8.2843000E-01	5.3770000E-01	8.7841000E-01
2.2073000E+03	6.4992000E-01	8.2844000E-01	5.3842000E-01	8.7960000E-01
2.2074000E+03	6.5075000E-01	8.2846000E-01	5.3912000E-01	8.8073000E-01
2.2075000E+03	6.5154000E-01	8.2848000E-01	5.3979000E-01	8.8182000E-01
2.2076000E+03	6.5231000E-01	8.2849000E-01	5.4044000E-01	8.8288000E-01
2.2077000E+03	6.5306000E-01	8.2851000E-01	5.4107000E-01	8.8392000E-01
2.2078000E+03	6.5381000E-01	8.2852000E-01	5.4169000E-01	8.8494000E-01
2.2079000E+03	6.5454000E-01	8.2854000E-01	5.4232000E-01	8.8595000E-01
2.2080000E+03	6.5528000E-01	8.2856000E-01	5.4294000E-01	8.8697000E-01
2.2081000E+03	6.5603000E-01	8.2854000E-01	5.4355000E-01	8.8797000E-01

2.2082000E+03	6.5679000E-01	8.2853000E-01	5.4417000E-01	8.8899000E-01
2.2083000E+03	6.5757000E-01	8.2852000E-01	5.4481000E-01	8.9003000E-01
2.2084000E+03	6.5838000E-01	8.2851000E-01	5.4547000E-01	8.9111000E-01
2.2085000E+03	6.5921000E-01	8.2849000E-01	5.4615000E-01	8.9222000E-01
2.2086000E+03	6.6008000E-01	8.2848000E-01	5.4687000E-01	8.9339000E-01
2.2087000E+03	6.6099000E-01	8.2847000E-01	5.4761000E-01	8.9460000E-01
2.2088000E+03	6.6194000E-01	8.2846000E-01	5.4839000E-01	8.9587000E-01
2.2089000E+03	6.6293000E-01	8.2844000E-01	5.4920000E-01	8.9720000E-01
2.2090000E+03	6.6397000E-01	8.2843000E-01	5.5005000E-01	8.9859000E-01
2.2091000E+03	6.6506000E-01	8.2843000E-01	5.5095000E-01	9.0006000E-01
2.2092000E+03	6.6620000E-01	8.2842000E-01	5.5189000E-01	9.0160000E-01
2.2093000E+03	6.6740000E-01	8.2841000E-01	5.5288000E-01	9.0321000E-01
2.2094000E+03	6.6865000E-01	8.2840000E-01	5.5391000E-01	9.0489000E-01
2.2095000E+03	6.6995000E-01	8.2840000E-01	5.5499000E-01	9.0665000E-01
2.2096000E+03	6.7131000E-01	8.2839000E-01	5.5611000E-01	9.0849000E-01
2.2097000E+03	6.7273000E-01	8.2838000E-01	5.5728000E-01	9.1039000E-01
2.2098000E+03	6.7420000E-01	8.2837000E-01	5.5849000E-01	9.1237000E-01
2.2099000E+03	6.7572000E-01	8.2837000E-01	5.5974000E-01	9.1442000E-01
2.2100000E+03	6.7729000E-01	8.2836000E-01	5.6104000E-01	9.1654000E-01
2.2101000E+03	6.7890000E-01	8.2836000E-01	5.6238000E-01	9.1873000E-01
2.2102000E+03	6.8056000E-01	8.2836000E-01	5.6376000E-01	9.2098000E-01
2.2103000E+03	6.8226000E-01	8.2837000E-01	5.6516000E-01	9.2328000E-01
2.2104000E+03	6.8400000E-01	8.2837000E-01	5.6660000E-01	9.2563000E-01
2.2105000E+03	6.8577000E-01	8.2837000E-01	5.6807000E-01	9.2803000E-01
2.2106000E+03	6.8756000E-01	8.2837000E-01	5.6956000E-01	9.3046000E-01
2.2107000E+03	6.8938000E-01	8.2837000E-01	5.7107000E-01	9.3292000E-01
2.2108000E+03	6.9122000E-01	8.2837000E-01	5.7259000E-01	9.3541000E-01
2.2109000E+03	6.9307000E-01	8.2838000E-01	5.7412000E-01	9.3791000E-01
2.2110000E+03	6.9493000E-01	8.2838000E-01	5.7566000E-01	9.4043000E-01
2.2111000E+03	6.9679000E-01	8.2842000E-01	5.7724000E-01	9.4300000E-01
2.2112000E+03	6.9866000E-01	8.2845000E-01	5.7881000E-01	9.4557000E-01
2.2113000E+03	7.0052000E-01	8.2849000E-01	5.8038000E-01	9.4813000E-01
2.2114000E+03	7.0237000E-01	8.2853000E-01	5.8194000E-01	9.5068000E-01
2.2115000E+03	7.0421000E-01	8.2857000E-01	5.8349000E-01	9.5322000E-01
2.2116000E+03	7.0604000E-01	8.2861000E-01	5.8503000E-01	9.5574000E-01
2.2117000E+03	7.0785000E-01	8.2865000E-01	5.8656000E-01	9.5823000E-01
2.2118000E+03	7.0964000E-01	8.2869000E-01	5.8807000E-01	9.6069000E-01
2.2119000E+03	7.1140000E-01	8.2873000E-01	5.8955000E-01	9.6312000E-01
2.2120000E+03	7.1313000E-01	8.2876000E-01	5.9102000E-01	9.6552000E-01
2.2121000E+03	7.1484000E-01	8.2880000E-01	5.9246000E-01	9.6787000E-01
2.2122000E+03	7.1652000E-01	8.2883000E-01	5.9387000E-01	9.7018000E-01
2.2123000E+03	7.1816000E-01	8.2887000E-01	5.9526000E-01	9.7244000E-01
2.2124000E+03	7.1976000E-01	8.2890000E-01	5.9661000E-01	9.7465000E-01

2.2125000E+03	7.2132000E-01	8.2894000E-01	5.9793000E-01	9.7680000E-01
2.2126000E+03	7.2283000E-01	8.2897000E-01	5.9921000E-01	9.7890000E-01
2.2127000E+03	7.2430000E-01	8.2900000E-01	6.0045000E-01	9.8093000E-01
2.2128000E+03	7.2572000E-01	8.2904000E-01	6.0165000E-01	9.8289000E-01
2.2129000E+03	7.2709000E-01	8.2907000E-01	6.0281000E-01	9.8478000E-01
2.2130000E+03	7.2839000E-01	8.2911000E-01	6.0392000E-01	9.8659000E-01
2.2131000E+03	7.2964000E-01	8.2914000E-01	6.0497000E-01	9.8831000E-01
2.2132000E+03	7.3081000E-01	8.2917000E-01	6.0597000E-01	9.8994000E-01
2.2133000E+03	7.3191000E-01	8.2920000E-01	6.0691000E-01	9.9147000E-01
2.2134000E+03	7.3294000E-01	8.2924000E-01	6.0778000E-01	9.9290000E-01
2.2135000E+03	7.3388000E-01	8.2927000E-01	6.0858000E-01	9.9421000E-01
2.2136000E+03	7.3474000E-01	8.2930000E-01	6.0932000E-01	9.9541000E-01
2.2137000E+03	7.3550000E-01	8.2933000E-01	6.0997000E-01	9.9648000E-01
2.2138000E+03	7.3616000E-01	8.2937000E-01	6.1055000E-01	9.9743000E-01
2.2139000E+03	7.3673000E-01	8.2940000E-01	6.1104000E-01	9.9823000E-01
2.2140000E+03	7.3719000E-01	8.2943000E-01	6.1145000E-01	9.9889000E-01
2.2141000E+03	7.3754000E-01	8.2946000E-01	6.1176000E-01	9.9940000E-01
2.2142000E+03	7.3777000E-01	8.2950000E-01	6.1198000E-01	9.9976000E-01
2.2143000E+03	7.3789000E-01	8.2953000E-01	6.1210000E-01	9.9996000E-01
2.2144000E+03	7.3789000E-01	8.2956000E-01	6.1213000E-01	1.0000000E+00
2.2145000E+03	7.3777000E-01	8.2960000E-01	6.1205000E-01	9.9988000E-01
2.2146000E+03	7.3753000E-01	8.2963000E-01	6.1187000E-01	9.9958000E-01
2.2147000E+03	7.3716000E-01	8.2966000E-01	6.1159000E-01	9.9913000E-01
2.2148000E+03	7.3667000E-01	8.2969000E-01	6.1121000E-01	9.9850000E-01
2.2149000E+03	7.3605000E-01	8.2973000E-01	6.1072000E-01	9.9770000E-01
2.2150000E+03	7.3531000E-01	8.2976000E-01	6.1013000E-01	9.9674000E-01
2.2151000E+03	7.3445000E-01	8.2979000E-01	6.0944000E-01	9.9561000E-01
2.2152000E+03	7.3346000E-01	8.2982000E-01	6.0864000E-01	9.9431000E-01
2.2153000E+03	7.3235000E-01	8.2986000E-01	6.0775000E-01	9.9284000E-01
2.2154000E+03	7.3112000E-01	8.2989000E-01	6.0675000E-01	9.9121000E-01
2.2155000E+03	7.2977000E-01	8.2992000E-01	6.0565000E-01	9.8942000E-01
2.2156000E+03	7.2830000E-01	8.2996000E-01	6.0445000E-01	9.8747000E-01
2.2157000E+03	7.2671000E-01	8.2999000E-01	6.0316000E-01	9.8535000E-01
2.2158000E+03	7.2500000E-01	8.3002000E-01	6.0176000E-01	9.8307000E-01
2.2159000E+03	7.2317000E-01	8.3005000E-01	6.0027000E-01	9.8063000E-01
2.2160000E+03	7.2123000E-01	8.3009000E-01	5.9868000E-01	9.7803000E-01
2.2161000E+03	7.1916000E-01	8.3010000E-01	5.9698000E-01	9.7525000E-01
2.2162000E+03	7.1698000E-01	8.3011000E-01	5.9517000E-01	9.7230000E-01
2.2163000E+03	7.1468000E-01	8.3012000E-01	5.9327000E-01	9.6920000E-01
2.2164000E+03	7.1226000E-01	8.3013000E-01	5.9127000E-01	9.6592000E-01
2.2165000E+03	7.0971000E-01	8.3014000E-01	5.8917000E-01	9.6249000E-01
2.2166000E+03	7.0705000E-01	8.3016000E-01	5.8696000E-01	9.5889000E-01
2.2167000E+03	7.0426000E-01	8.3017000E-01	5.8465000E-01	9.5512000E-01

2.2168000E+03	7.0135000E-01	8.3018000E-01	5.8224000E-01	9.5118000E-01
2.2169000E+03	6.9831000E-01	8.3019000E-01	5.7973000E-01	9.4707000E-01
2.2170000E+03	6.9514000E-01	8.3020000E-01	5.7711000E-01	9.4279000E-01
2.2171000E+03	6.9185000E-01	8.3021000E-01	5.7438000E-01	9.3834000E-01
2.2172000E+03	6.8844000E-01	8.3021000E-01	5.7155000E-01	9.3371000E-01
2.2173000E+03	6.8489000E-01	8.3022000E-01	5.6861000E-01	9.2891000E-01
2.2174000E+03	6.8122000E-01	8.3023000E-01	5.6557000E-01	9.2394000E-01
2.2175000E+03	6.7743000E-01	8.3024000E-01	5.6242000E-01	9.1880000E-01
2.2176000E+03	6.7351000E-01	8.3024000E-01	5.5918000E-01	9.1350000E-01
2.2177000E+03	6.6947000E-01	8.3025000E-01	5.5583000E-01	9.0803000E-01
2.2178000E+03	6.6531000E-01	8.3026000E-01	5.5238000E-01	9.0240000E-01
2.2179000E+03	6.6104000E-01	8.3026000E-01	5.4884000E-01	8.9661000E-01
2.2180000E+03	6.5665000E-01	8.3027000E-01	5.4520000E-01	8.9066000E-01
2.2181000E+03	6.5215000E-01	8.3027000E-01	5.4146000E-01	8.8456000E-01
2.2182000E+03	6.4754000E-01	8.3027000E-01	5.3764000E-01	8.7831000E-01
2.2183000E+03	6.4283000E-01	8.3027000E-01	5.3372000E-01	8.7192000E-01
2.2184000E+03	6.3801000E-01	8.3027000E-01	5.2972000E-01	8.6538000E-01
2.2185000E+03	6.3310000E-01	8.3027000E-01	5.2564000E-01	8.5872000E-01
2.2186000E+03	6.2808000E-01	8.3027000E-01	5.2148000E-01	8.5192000E-01
2.2187000E+03	6.2297000E-01	8.3027000E-01	5.1724000E-01	8.4498000E-01
2.2188000E+03	6.1777000E-01	8.3027000E-01	5.1292000E-01	8.3793000E-01
2.2189000E+03	6.1247000E-01	8.3027000E-01	5.0852000E-01	8.3074000E-01
2.2190000E+03	6.0708000E-01	8.3027000E-01	5.0404000E-01	8.2343000E-01
2.2191000E+03	6.0160000E-01	8.3027000E-01	4.9949000E-01	8.1599000E-01
2.2192000E+03	5.9603000E-01	8.3027000E-01	4.9486000E-01	8.0843000E-01
2.2193000E+03	5.9036000E-01	8.3026000E-01	4.9016000E-01	8.0075000E-01
2.2194000E+03	5.8461000E-01	8.3026000E-01	4.8538000E-01	7.9294000E-01
2.2195000E+03	5.7876000E-01	8.3026000E-01	4.8052000E-01	7.8500000E-01
2.2196000E+03	5.7282000E-01	8.3026000E-01	4.7558000E-01	7.7694000E-01
2.2197000E+03	5.6678000E-01	8.3025000E-01	4.7057000E-01	7.6875000E-01
2.2198000E+03	5.6065000E-01	8.3025000E-01	4.6548000E-01	7.6043000E-01
2.2199000E+03	5.5442000E-01	8.3025000E-01	4.6031000E-01	7.5198000E-01
2.2200000E+03	5.4810000E-01	8.3025000E-01	4.5506000E-01	7.4341000E-01
2.2201000E+03	5.4169000E-01	8.3029000E-01	4.4976000E-01	7.3475000E-01
2.2202000E+03	5.3519000E-01	8.3033000E-01	4.4439000E-01	7.2597000E-01
2.2203000E+03	5.2860000E-01	8.3038000E-01	4.3894000E-01	7.1707000E-01
2.2204000E+03	5.2192000E-01	8.3042000E-01	4.3341000E-01	7.0805000E-01
2.2205000E+03	5.1516000E-01	8.3046000E-01	4.2782000E-01	6.9891000E-01
2.2206000E+03	5.0833000E-01	8.3051000E-01	4.2217000E-01	6.8967000E-01
2.2207000E+03	5.0142000E-01	8.3055000E-01	4.1645000E-01	6.8034000E-01
2.2208000E+03	4.9444000E-01	8.3059000E-01	4.1068000E-01	6.7091000E-01
2.2209000E+03	4.8741000E-01	8.3064000E-01	4.0486000E-01	6.6140000E-01
2.2210000E+03	4.8033000E-01	8.3068000E-01	3.9900000E-01	6.5182000E-01

2.2211000E+03	4.7320000E-01	8.3072000E-01	3.9310000E-01	6.4218000E-01
2.2212000E+03	4.6604000E-01	8.3076000E-01	3.8716000E-01	6.3249000E-01
2.2213000E+03	4.5884000E-01	8.3079000E-01	3.8121000E-01	6.2276000E-01
2.2214000E+03	4.5163000E-01	8.3083000E-01	3.7523000E-01	6.1300000E-01
2.2215000E+03	4.4441000E-01	8.3087000E-01	3.6925000E-01	6.0322000E-01
2.2216000E+03	4.3718000E-01	8.3091000E-01	3.6326000E-01	5.9344000E-01
2.2217000E+03	4.2995000E-01	8.3095000E-01	3.5727000E-01	5.8365000E-01
2.2218000E+03	4.2273000E-01	8.3099000E-01	3.5129000E-01	5.7388000E-01
2.2219000E+03	4.1553000E-01	8.3103000E-01	3.4532000E-01	5.6412000E-01
2.2220000E+03	4.0834000E-01	8.3107000E-01	3.3936000E-01	5.5439000E-01
2.2221000E+03	4.0118000E-01	8.3108000E-01	3.3341000E-01	5.4468000E-01
2.2222000E+03	3.9404000E-01	8.3109000E-01	3.2748000E-01	5.3499000E-01
2.2223000E+03	3.8693000E-01	8.3111000E-01	3.2158000E-01	5.2534000E-01
2.2224000E+03	3.7984000E-01	8.3112000E-01	3.1569000E-01	5.1573000E-01
2.2225000E+03	3.7279000E-01	8.3113000E-01	3.0984000E-01	5.0616000E-01
2.2226000E+03	3.6576000E-01	8.3115000E-01	3.0400000E-01	4.9663000E-01
2.2227000E+03	3.5876000E-01	8.3116000E-01	2.9819000E-01	4.8714000E-01
2.2228000E+03	3.5179000E-01	8.3117000E-01	2.9240000E-01	4.7768000E-01
2.2229000E+03	3.4485000E-01	8.3119000E-01	2.8663000E-01	4.6826000E-01
2.2230000E+03	3.3793000E-01	8.3120000E-01	2.8089000E-01	4.5887000E-01
2.2231000E+03	3.3103000E-01	8.3121000E-01	2.7516000E-01	4.4951000E-01
2.2232000E+03	3.2416000E-01	8.3123000E-01	2.6945000E-01	4.4019000E-01
2.2233000E+03	3.1731000E-01	8.3124000E-01	2.6376000E-01	4.3089000E-01
2.2234000E+03	3.1048000E-01	8.3125000E-01	2.5809000E-01	4.2162000E-01
2.2235000E+03	3.0367000E-01	8.3127000E-01	2.5243000E-01	4.1238000E-01
2.2236000E+03	2.9689000E-01	8.3128000E-01	2.4680000E-01	4.0318000E-01
2.2237000E+03	2.9014000E-01	8.3129000E-01	2.4119000E-01	3.9402000E-01
2.2238000E+03	2.8341000E-01	8.3131000E-01	2.3560000E-01	3.8489000E-01
2.2239000E+03	2.7673000E-01	8.3132000E-01	2.3005000E-01	3.7582000E-01
2.2240000E+03	2.7008000E-01	8.3134000E-01	2.2453000E-01	3.6680000E-01
2.2241000E+03	2.6348000E-01	8.3134000E-01	2.1904000E-01	3.5784000E-01
2.2242000E+03	2.5693000E-01	8.3135000E-01	2.1360000E-01	3.4895000E-01
2.2243000E+03	2.5044000E-01	8.3136000E-01	2.0821000E-01	3.4014000E-01
2.2244000E+03	2.4402000E-01	8.3137000E-01	2.0287000E-01	3.3142000E-01
2.2245000E+03	2.3767000E-01	8.3138000E-01	1.9760000E-01	3.2280000E-01
2.2246000E+03	2.3141000E-01	8.3139000E-01	1.9239000E-01	3.1430000E-01
2.2247000E+03	2.2523000E-01	8.3140000E-01	1.8726000E-01	3.0591000E-01
2.2248000E+03	2.1915000E-01	8.3141000E-01	1.8221000E-01	2.9766000E-01
2.2249000E+03	2.1318000E-01	8.3142000E-01	1.7724000E-01	2.8955000E-01
2.2250000E+03	2.0731000E-01	8.3143000E-01	1.7236000E-01	2.8158000E-01
2.2251000E+03	2.0156000E-01	8.3145000E-01	1.6758000E-01	2.7377000E-01
2.2252000E+03	1.9592000E-01	8.3146000E-01	1.6290000E-01	2.6613000E-01
2.2253000E+03	1.9041000E-01	8.3148000E-01	1.5832000E-01	2.5864000E-01

2.2254000E+03	1.8501000E-01	8.3150000E-01	1.5384000E-01	2.5132000E-01
2.2255000E+03	1.7975000E-01	8.3151000E-01	1.4946000E-01	2.4417000E-01
2.2256000E+03	1.7460000E-01	8.3153000E-01	1.4518000E-01	2.3718000E-01
2.2257000E+03	1.6958000E-01	8.3154000E-01	1.4101000E-01	2.3036000E-01
2.2258000E+03	1.6467000E-01	8.3156000E-01	1.3693000E-01	2.2370000E-01
2.2259000E+03	1.5988000E-01	8.3158000E-01	1.3295000E-01	2.1720000E-01
2.2260000E+03	1.5520000E-01	8.3159000E-01	1.2907000E-01	2.1085000E-01
2.2261000E+03	1.5064000E-01	8.3159000E-01	1.2527000E-01	2.0465000E-01
2.2262000E+03	1.4618000E-01	8.3159000E-01	1.2156000E-01	1.9858000E-01
2.2263000E+03	1.4181000E-01	8.3158000E-01	1.1793000E-01	1.9265000E-01
2.2264000E+03	1.3755000E-01	8.3158000E-01	1.1438000E-01	1.8686000E-01
2.2265000E+03	1.3337000E-01	8.3158000E-01	1.1091000E-01	1.8118000E-01
2.2266000E+03	1.2928000E-01	8.3157000E-01	1.0750000E-01	1.7563000E-01
2.2267000E+03	1.2527000E-01	8.3157000E-01	1.0417000E-01	1.7018000E-01
2.2268000E+03	1.2135000E-01	8.3157000E-01	1.0091000E-01	1.6485000E-01
2.2269000E+03	1.1750000E-01	8.3156000E-01	9.7709000E-02	1.5962000E-01
2.2270000E+03	1.1373000E-01	8.3156000E-01	9.4573000E-02	1.5450000E-01
2.2271000E+03	1.1003000E-01	8.3156000E-01	9.1499000E-02	1.4948000E-01
2.2272000E+03	1.0642000E-01	8.3155000E-01	8.8490000E-02	1.4456000E-01
2.2273000E+03	1.0287000E-01	8.3155000E-01	8.5545000E-02	1.3975000E-01
2.2274000E+03	9.9410000E-02	8.3154000E-01	8.2663000E-02	1.3504000E-01
2.2275000E+03	9.6025000E-02	8.3154000E-01	7.9849000E-02	1.3044000E-01
2.2276000E+03	9.2723000E-02	8.3153000E-01	7.7102000E-02	1.2596000E-01
2.2277000E+03	8.9506000E-02	8.3153000E-01	7.4427000E-02	1.2159000E-01
2.2278000E+03	8.6376000E-02	8.3152000E-01	7.1824000E-02	1.1733000E-01
2.2279000E+03	8.3336000E-02	8.3152000E-01	6.9295000E-02	1.1320000E-01
2.2280000E+03	8.0388000E-02	8.3151000E-01	6.6844000E-02	1.0920000E-01
2.2281000E+03	7.7536000E-02	8.3152000E-01	6.4472000E-02	1.0533000E-01
2.2282000E+03	7.4779000E-02	8.3152000E-01	6.2181000E-02	1.0158000E-01
2.2283000E+03	7.2121000E-02	8.3153000E-01	5.9971000E-02	9.7971000E-02
2.2284000E+03	6.9561000E-02	8.3153000E-01	5.7842000E-02	9.4494000E-02
2.2285000E+03	6.7100000E-02	8.3154000E-01	5.5796000E-02	9.1151000E-02
2.2286000E+03	6.4736000E-02	8.3154000E-01	5.3831000E-02	8.7940000E-02
2.2287000E+03	6.2468000E-02	8.3155000E-01	5.1945000E-02	8.4860000E-02
2.2288000E+03	6.0295000E-02	8.3155000E-01	5.0138000E-02	8.1908000E-02
2.2289000E+03	5.8212000E-02	8.3156000E-01	4.8406000E-02	7.9079000E-02
2.2290000E+03	5.6217000E-02	8.3156000E-01	4.6747000E-02	7.6369000E-02
2.2291000E+03	5.4305000E-02	8.3156000E-01	4.5158000E-02	7.3772000E-02
2.2292000E+03	5.2472000E-02	8.3156000E-01	4.3634000E-02	7.1282000E-02
2.2293000E+03	5.0713000E-02	8.3156000E-01	4.2171000E-02	6.8893000E-02
2.2294000E+03	4.9024000E-02	8.3156000E-01	4.0767000E-02	6.6599000E-02
2.2295000E+03	4.7400000E-02	8.3156000E-01	3.9416000E-02	6.4393000E-02
2.2296000E+03	4.5836000E-02	8.3156000E-01	3.8116000E-02	6.2268000E-02

2.2297000E+03	4.4328000E-02	8.3156000E-01	3.6861000E-02	6.0218000E-02
2.2298000E+03	4.2870000E-02	8.3156000E-01	3.5649000E-02	5.8238000E-02
2.2299000E+03	4.1460000E-02	8.3155000E-01	3.4476000E-02	5.6322000E-02
2.2300000E+03	4.0095000E-02	8.3155000E-01	3.3341000E-02	5.4467000E-02
2.2301000E+03	3.8771000E-02	8.3159000E-01	3.2241000E-02	5.2671000E-02
2.2302000E+03	3.7487000E-02	8.3163000E-01	3.1175000E-02	5.0929000E-02
2.2303000E+03	3.6240000E-02	8.3167000E-01	3.0140000E-02	4.9238000E-02
2.2304000E+03	3.5031000E-02	8.3170000E-01	2.9135000E-02	4.7597000E-02
2.2305000E+03	3.3858000E-02	8.3174000E-01	2.8161000E-02	4.6005000E-02
2.2306000E+03	3.2721000E-02	8.3178000E-01	2.7217000E-02	4.4463000E-02
2.2307000E+03	3.1621000E-02	8.3182000E-01	2.6303000E-02	4.2970000E-02
2.2308000E+03	3.0558000E-02	8.3186000E-01	2.5420000E-02	4.1527000E-02
2.2309000E+03	2.9532000E-02	8.3190000E-01	2.4568000E-02	4.0135000E-02
2.2310000E+03	2.8545000E-02	8.3194000E-01	2.3748000E-02	3.8796000E-02
2.2311000E+03	2.7597000E-02	8.3198000E-01	2.2960000E-02	3.7509000E-02
2.2312000E+03	2.6688000E-02	8.3201000E-01	2.2205000E-02	3.6275000E-02
2.2313000E+03	2.5819000E-02	8.3205000E-01	2.1483000E-02	3.5096000E-02
2.2314000E+03	2.4989000E-02	8.3209000E-01	2.0793000E-02	3.3969000E-02
2.2315000E+03	2.4198000E-02	8.3213000E-01	2.0136000E-02	3.2895000E-02
2.2316000E+03	2.3444000E-02	8.3217000E-01	1.9509000E-02	3.1871000E-02
2.2317000E+03	2.2726000E-02	8.3221000E-01	1.8913000E-02	3.0897000E-02
2.2318000E+03	2.2042000E-02	8.3224000E-01	1.8345000E-02	2.9969000E-02
2.2319000E+03	2.1390000E-02	8.3228000E-01	1.7803000E-02	2.9083000E-02
2.2320000E+03	2.0767000E-02	8.3232000E-01	1.7285000E-02	2.8237000E-02
2.2321000E+03	2.0169000E-02	8.3235000E-01	1.6788000E-02	2.7426000E-02
2.2322000E+03	1.9594000E-02	8.3239000E-01	1.6310000E-02	2.6645000E-02
2.2323000E+03	1.9039000E-02	8.3242000E-01	1.5848000E-02	2.5890000E-02
2.2324000E+03	1.8499000E-02	8.3245000E-01	1.5399000E-02	2.5157000E-02
2.2325000E+03	1.7972000E-02	8.3248000E-01	1.4961000E-02	2.4441000E-02
2.2326000E+03	1.7454000E-02	8.3252000E-01	1.4531000E-02	2.3739000E-02
2.2327000E+03	1.6944000E-02	8.3255000E-01	1.4107000E-02	2.3046000E-02
2.2328000E+03	1.6439000E-02	8.3258000E-01	1.3687000E-02	2.2360000E-02
2.2329000E+03	1.5938000E-02	8.3261000E-01	1.3270000E-02	2.1679000E-02
2.2330000E+03	1.5438000E-02	8.3265000E-01	1.2855000E-02	2.1000000E-02
2.2331000E+03	1.4941000E-02	8.3268000E-01	1.2441000E-02	2.0324000E-02
2.2332000E+03	1.4445000E-02	8.3272000E-01	1.2029000E-02	1.9651000E-02
2.2333000E+03	1.3952000E-02	8.3275000E-01	1.1619000E-02	1.8981000E-02
2.2334000E+03	1.3464000E-02	8.3279000E-01	1.1212000E-02	1.8317000E-02
2.2335000E+03	1.2981000E-02	8.3282000E-01	1.0811000E-02	1.7661000E-02
2.2336000E+03	1.2507000E-02	8.3286000E-01	1.0417000E-02	1.7017000E-02
2.2337000E+03	1.2044000E-02	8.3289000E-01	1.0032000E-02	1.6388000E-02
2.2338000E+03	1.1596000E-02	8.3293000E-01	9.6590000E-03	1.5779000E-02
2.2339000E+03	1.1166000E-02	8.3296000E-01	9.3013000E-03	1.5195000E-02

2.2340000E+03	1.0758000E-02	8.3300000E-01	8.9612000E-03	1.4639000E-02
2.2341000E+03	1.0374000E-02	8.3302000E-01	8.6413000E-03	1.4117000E-02
2.2342000E+03	1.0017000E-02	8.3304000E-01	8.3443000E-03	1.3632000E-02
2.2343000E+03	9.6899000E-03	8.3307000E-01	8.0723000E-03	1.3187000E-02
2.2344000E+03	9.3953000E-03	8.3309000E-01	7.8271000E-03	1.2787000E-02
2.2345000E+03	9.1342000E-03	8.3311000E-01	7.6098000E-03	1.2432000E-02
2.2346000E+03	8.9076000E-03	8.3313000E-01	7.4213000E-03	1.2124000E-02
2.2347000E+03	8.7155000E-03	8.3316000E-01	7.2614000E-03	1.1863000E-02
2.2348000E+03	8.5571000E-03	8.3318000E-01	7.1296000E-03	1.1647000E-02
2.2349000E+03	8.4311000E-03	8.3320000E-01	7.0248000E-03	1.1476000E-02
2.2350000E+03	8.3353000E-03	8.3323000E-01	6.9452000E-03	1.1346000E-02
2.2351000E+03	8.2669000E-03	8.3325000E-01	6.8883000E-03	1.1253000E-02
2.2352000E+03	8.2224000E-03	8.3327000E-01	6.8514000E-03	1.1193000E-02
2.2353000E+03	8.1979000E-03	8.3329000E-01	6.8312000E-03	1.1160000E-02
2.2354000E+03	8.1890000E-03	8.3331000E-01	6.8239000E-03	1.1148000E-02
2.2355000E+03	8.1911000E-03	8.3332000E-01	6.8258000E-03	1.1151000E-02
2.2356000E+03	8.1993000E-03	8.3334000E-01	6.8329000E-03	1.1163000E-02
2.2357000E+03	8.2088000E-03	8.3336000E-01	6.8409000E-03	1.1176000E-02
2.2358000E+03	8.2149000E-03	8.3338000E-01	6.8461000E-03	1.1184000E-02
2.2359000E+03	8.2128000E-03	8.3340000E-01	6.8446000E-03	1.1182000E-02
2.2360000E+03	8.1985000E-03	8.3342000E-01	6.8328000E-03	1.1162000E-02
2.2361000E+03	8.1682000E-03	8.3345000E-01	6.8078000E-03	1.1122000E-02
2.2362000E+03	8.1188000E-03	8.3348000E-01	6.7669000E-03	1.1055000E-02
2.2363000E+03	8.0478000E-03	8.3352000E-01	6.7080000E-03	1.0959000E-02
2.2364000E+03	7.9536000E-03	8.3355000E-01	6.6297000E-03	1.0831000E-02
2.2365000E+03	7.8352000E-03	8.3358000E-01	6.5312000E-03	1.0670000E-02
2.2366000E+03	7.6924000E-03	8.3361000E-01	6.4125000E-03	1.0476000E-02
2.2367000E+03	7.5260000E-03	8.3364000E-01	6.2740000E-03	1.0249000E-02
2.2368000E+03	7.3373000E-03	8.3367000E-01	6.1169000E-03	9.9928000E-03
2.2369000E+03	7.1285000E-03	8.3370000E-01	5.9430000E-03	9.7088000E-03
2.2370000E+03	6.9023000E-03	8.3373000E-01	5.7547000E-03	9.4011000E-03
2.2371000E+03	6.6619000E-03	8.3376000E-01	5.5544000E-03	9.0740000E-03
2.2372000E+03	6.4111000E-03	8.3378000E-01	5.3455000E-03	8.7326000E-03
2.2373000E+03	6.1538000E-03	8.3380000E-01	5.1311000E-03	8.3824000E-03
2.2374000E+03	5.9022000E-03	8.3383000E-01	4.9214000E-03	8.0399000E-03
2.2375000E+03	5.6638000E-03	8.3385000E-01	4.7227000E-03	7.7153000E-03
2.2376000E+03	5.4302000E-03	8.3387000E-01	4.5281000E-03	7.3974000E-03
2.2377000E+03	5.2051000E-03	8.3389000E-01	4.3405000E-03	7.0908000E-03
2.2378000E+03	4.9914000E-03	8.3392000E-01	4.1624000E-03	6.7999000E-03
2.2379000E+03	4.7920000E-03	8.3394000E-01	3.9963000E-03	6.5285000E-03
2.2380000E+03	4.6096000E-03	8.3396000E-01	3.8442000E-03	6.2801000E-03
2.2381000E+03	4.4462000E-03	8.3395000E-01	3.7079000E-03	6.0574000E-03
2.2382000E+03	4.3034000E-03	8.3394000E-01	3.5888000E-03	5.8628000E-03

2.2383000E+03	4.1823000E-03	8.3393000E-01	3.4878000E-03	5.6978000E-03
2.2384000E+03	4.0837000E-03	8.3392000E-01	3.4055000E-03	5.5633000E-03
2.2385000E+03	4.0075000E-03	8.3391000E-01	3.3419000E-03	5.4595000E-03
2.2386000E+03	3.9534000E-03	8.3390000E-01	3.2968000E-03	5.3858000E-03
2.2387000E+03	3.9206000E-03	8.3389000E-01	3.2693000E-03	5.3409000E-03
2.2388000E+03	3.9076000E-03	8.3388000E-01	3.2584000E-03	5.3231000E-03
2.2389000E+03	3.9127000E-03	8.3387000E-01	3.2627000E-03	5.3301000E-03
2.2390000E+03	3.9339000E-03	8.3386000E-01	3.2803000E-03	5.3589000E-03
2.2391000E+03	3.9688000E-03	8.3385000E-01	3.3094000E-03	5.4064000E-03
2.2392000E+03	4.0149000E-03	8.3384000E-01	3.3478000E-03	5.4691000E-03
2.2393000E+03	4.0692000E-03	8.3384000E-01	3.3931000E-03	5.5431000E-03
2.2394000E+03	4.1292000E-03	8.3383000E-01	3.4430000E-03	5.6247000E-03
2.2395000E+03	4.1919000E-03	8.3382000E-01	3.4953000E-03	5.7101000E-03
2.2396000E+03	4.2546000E-03	8.3382000E-01	3.5476000E-03	5.7954000E-03
2.2397000E+03	4.3147000E-03	8.3381000E-01	3.5976000E-03	5.8772000E-03
2.2398000E+03	4.3696000E-03	8.3380000E-01	3.6434000E-03	5.9520000E-03
2.2399000E+03	4.4171000E-03	8.3379000E-01	3.6830000E-03	6.0167000E-03
2.2400000E+03	4.4552000E-03	8.3379000E-01	3.7147000E-03	6.0685000E-03
2.2401000E+03	4.4821000E-03	8.3379000E-01	3.7371000E-03	6.1052000E-03
2.2402000E+03	4.4963000E-03	8.3379000E-01	3.7490000E-03	6.1245000E-03
2.2403000E+03	4.4966000E-03	8.3379000E-01	3.7492000E-03	6.1249000E-03
2.2404000E+03	4.4821000E-03	8.3379000E-01	3.7371000E-03	6.1051000E-03
2.2405000E+03	4.4521000E-03	8.3379000E-01	3.7121000E-03	6.0643000E-03
2.2406000E+03	4.4064000E-03	8.3379000E-01	3.6740000E-03	6.0021000E-03
2.2407000E+03	4.3450000E-03	8.3380000E-01	3.6228000E-03	5.9184000E-03
2.2408000E+03	4.2681000E-03	8.3380000E-01	3.5588000E-03	5.8138000E-03
2.2409000E+03	4.1764000E-03	8.3380000E-01	3.4823000E-03	5.6889000E-03
2.2410000E+03	4.0707000E-03	8.3380000E-01	3.3941000E-03	5.5448000E-03
2.2411000E+03	3.9520000E-03	8.3380000E-01	3.2952000E-03	5.3832000E-03
2.2412000E+03	3.8217000E-03	8.3381000E-01	3.1866000E-03	5.2058000E-03
2.2413000E+03	3.6814000E-03	8.3381000E-01	3.0696000E-03	5.0146000E-03
2.2414000E+03	3.5326000E-03	8.3382000E-01	2.9455000E-03	4.8120000E-03
2.2415000E+03	3.3772000E-03	8.3382000E-01	2.8160000E-03	4.6003000E-03
2.2416000E+03	3.2172000E-03	8.3383000E-01	2.6826000E-03	4.3824000E-03
2.2417000E+03	3.0545000E-03	8.3383000E-01	2.5469000E-03	4.1607000E-03
2.2418000E+03	2.8910000E-03	8.3383000E-01	2.4106000E-03	3.9381000E-03
2.2419000E+03	2.7289000E-03	8.3384000E-01	2.2754000E-03	3.7173000E-03
2.2420000E+03	2.5699000E-03	8.3384000E-01	2.1429000E-03	3.5007000E-03
2.2421000E+03	0.0000000E+00	8.3388000E-01	0.0000000E+00	0.0000000E+00
Channel 15				

Wavenumber	HIRS Filter Transmittance	Optical Element Transmittance	Product of the HIRS Filter and Optical Element Transmittances	Normalized Value of Column 4
2.2071000E+03	0.0000000E+00	8.2841000E-01	0.0000000E+00	0.0000000E+00
2.2072000E+03	6.5368000E-03	8.2843000E-01	5.4153000E-03	8.3294000E-03
2.2073000E+03	6.5812000E-03	8.2844000E-01	5.4522000E-03	8.3861000E-03
2.2074000E+03	6.6244000E-03	8.2846000E-01	5.4880000E-03	8.4413000E-03
2.2075000E+03	6.6661000E-03	8.2848000E-01	5.5227000E-03	8.4946000E-03
2.2076000E+03	6.7061000E-03	8.2849000E-01	5.5560000E-03	8.5458000E-03
2.2077000E+03	6.7442000E-03	8.2851000E-01	5.5876000E-03	8.5945000E-03
2.2078000E+03	6.7801000E-03	8.2852000E-01	5.6175000E-03	8.6404000E-03
2.2079000E+03	6.8137000E-03	8.2854000E-01	5.6454000E-03	8.6834000E-03
2.2080000E+03	6.8447000E-03	8.2856000E-01	5.6712000E-03	8.7231000E-03
2.2081000E+03	6.8730000E-03	8.2854000E-01	5.6945000E-03	8.7589000E-03
2.2082000E+03	6.8983000E-03	8.2853000E-01	5.7154000E-03	8.7911000E-03
2.2083000E+03	6.9206000E-03	8.2852000E-01	5.7338000E-03	8.8194000E-03
2.2084000E+03	6.9396000E-03	8.2851000E-01	5.7495000E-03	8.8435000E-03
2.2085000E+03	6.9554000E-03	8.2849000E-01	5.7625000E-03	8.8635000E-03
2.2086000E+03	6.9679000E-03	8.2848000E-01	5.7727000E-03	8.8792000E-03
2.2087000E+03	6.9769000E-03	8.2847000E-01	5.7801000E-03	8.8906000E-03
2.2088000E+03	6.9825000E-03	8.2846000E-01	5.7847000E-03	8.8976000E-03
2.2089000E+03	6.9847000E-03	8.2844000E-01	5.7864000E-03	8.9002000E-03
2.2090000E+03	6.9834000E-03	8.2843000E-01	5.7853000E-03	8.8986000E-03
2.2091000E+03	6.9789000E-03	8.2843000E-01	5.7815000E-03	8.8927000E-03
2.2092000E+03	6.9712000E-03	8.2842000E-01	5.7751000E-03	8.8828000E-03
2.2093000E+03	6.9605000E-03	8.2841000E-01	5.7661000E-03	8.8690000E-03
2.2094000E+03	6.9468000E-03	8.2840000E-01	5.7547000E-03	8.8515000E-03
2.2095000E+03	6.9304000E-03	8.2840000E-01	5.7411000E-03	8.8306000E-03
2.2096000E+03	6.9115000E-03	8.2839000E-01	5.7254000E-03	8.8065000E-03
2.2097000E+03	6.8905000E-03	8.2838000E-01	5.7080000E-03	8.7796000E-03
2.2098000E+03	6.8675000E-03	8.2837000E-01	5.6889000E-03	8.7502000E-03
2.2099000E+03	6.8430000E-03	8.2837000E-01	5.6685000E-03	8.7189000E-03
2.2100000E+03	6.8171000E-03	8.2836000E-01	5.6471000E-03	8.6859000E-03
2.2101000E+03	6.7905000E-03	8.2836000E-01	5.6250000E-03	8.6519000E-03
2.2102000E+03	6.7633000E-03	8.2836000E-01	5.6024000E-03	8.6173000E-03
2.2103000E+03	6.7360000E-03	8.2837000E-01	5.5799000E-03	8.5826000E-03
2.2104000E+03	6.7091000E-03	8.2837000E-01	5.5576000E-03	8.5483000E-03
2.2105000E+03	6.6830000E-03	8.2837000E-01	5.5360000E-03	8.5150000E-03
2.2106000E+03	6.6581000E-03	8.2837000E-01	5.5154000E-03	8.4834000E-03
2.2107000E+03	6.6350000E-03	8.2837000E-01	5.4963000E-03	8.4540000E-03
2.2108000E+03	6.6141000E-03	8.2837000E-01	5.4789000E-03	8.4273000E-03
2.2109000E+03	6.5959000E-03	8.2838000E-01	5.4639000E-03	8.4041000E-03

2.2110000E+03	6.5808000E-03	8.2838000E-01	5.4514000E-03	8.3849000E-03
2.2111000E+03	6.5694000E-03	8.2842000E-01	5.4422000E-03	8.3708000E-03
2.2112000E+03	6.5621000E-03	8.2845000E-01	5.4364000E-03	8.3619000E-03
2.2113000E+03	6.5595000E-03	8.2849000E-01	5.4345000E-03	8.3590000E-03
2.2114000E+03	6.5619000E-03	8.2853000E-01	5.4367000E-03	8.3624000E-03
2.2115000E+03	6.5698000E-03	8.2857000E-01	5.4436000E-03	8.3729000E-03
2.2116000E+03	6.5837000E-03	8.2861000E-01	5.4553000E-03	8.3910000E-03
2.2117000E+03	6.6039000E-03	8.2865000E-01	5.4723000E-03	8.4172000E-03
2.2118000E+03	6.6309000E-03	8.2869000E-01	5.4949000E-03	8.4519000E-03
2.2119000E+03	6.6650000E-03	8.2873000E-01	5.5234000E-03	8.4958000E-03
2.2120000E+03	6.7065000E-03	8.2876000E-01	5.5581000E-03	8.5491000E-03
2.2121000E+03	6.7558000E-03	8.2880000E-01	5.5992000E-03	8.6123000E-03
2.2122000E+03	6.8131000E-03	8.2883000E-01	5.6469000E-03	8.6857000E-03
2.2123000E+03	6.8787000E-03	8.2887000E-01	5.7015000E-03	8.7697000E-03
2.2124000E+03	6.9528000E-03	8.2890000E-01	5.7632000E-03	8.8645000E-03
2.2125000E+03	7.0356000E-03	8.2894000E-01	5.8320000E-03	8.9704000E-03
2.2126000E+03	7.1271000E-03	8.2897000E-01	5.9081000E-03	9.0875000E-03
2.2127000E+03	7.2275000E-03	8.2900000E-01	5.9917000E-03	9.2160000E-03
2.2128000E+03	7.3369000E-03	8.2904000E-01	6.0826000E-03	9.3558000E-03
2.2129000E+03	7.4553000E-03	8.2907000E-01	6.1810000E-03	9.5072000E-03
2.2130000E+03	7.5827000E-03	8.2911000E-01	6.2869000E-03	9.6700000E-03
2.2131000E+03	7.7190000E-03	8.2914000E-01	6.4001000E-03	9.8443000E-03
2.2132000E+03	7.8642000E-03	8.2917000E-01	6.5207000E-03	1.0030000E-02
2.2133000E+03	8.0180000E-03	8.2920000E-01	6.6486000E-03	1.0226000E-02
2.2134000E+03	8.1805000E-03	8.2924000E-01	6.7835000E-03	1.0434000E-02
2.2135000E+03	8.3513000E-03	8.2927000E-01	6.9255000E-03	1.0652000E-02
2.2136000E+03	8.5303000E-03	8.2930000E-01	7.0742000E-03	1.0881000E-02
2.2137000E+03	8.7173000E-03	8.2933000E-01	7.2296000E-03	1.1120000E-02
2.2138000E+03	8.9120000E-03	8.2937000E-01	7.3913000E-03	1.1369000E-02
2.2139000E+03	9.1140000E-03	8.2940000E-01	7.5592000E-03	1.1627000E-02
2.2140000E+03	9.3232000E-03	8.2943000E-01	7.7330000E-03	1.1894000E-02
2.2141000E+03	9.5392000E-03	8.2946000E-01	7.9124000E-03	1.2170000E-02
2.2142000E+03	9.7616000E-03	8.2950000E-01	8.0972000E-03	1.2455000E-02
2.2143000E+03	9.9902000E-03	8.2953000E-01	8.2871000E-03	1.2747000E-02
2.2144000E+03	1.0224000E-02	8.2956000E-01	8.4819000E-03	1.3046000E-02
2.2145000E+03	1.0464000E-02	8.2960000E-01	8.6811000E-03	1.3353000E-02
2.2146000E+03	1.0709000E-02	8.2963000E-01	8.8846000E-03	1.3666000E-02
2.2147000E+03	1.0959000E-02	8.2966000E-01	9.0922000E-03	1.3985000E-02
2.2148000E+03	1.1213000E-02	8.2969000E-01	9.3033000E-03	1.4310000E-02
2.2149000E+03	1.1471000E-02	8.2973000E-01	9.5179000E-03	1.4640000E-02
2.2150000E+03	1.1733000E-02	8.2976000E-01	9.7358000E-03	1.4975000E-02
2.2151000E+03	1.1999000E-02	8.2979000E-01	9.9566000E-03	1.5315000E-02
2.2152000E+03	1.2268000E-02	8.2982000E-01	1.0180000E-02	1.5658000E-02

2.2153000E+03	1.2540000E-02	8.2986000E-01	1.0406000E-02	1.6006000E-02
2.2154000E+03	1.2815000E-02	8.2989000E-01	1.0635000E-02	1.6357000E-02
2.2155000E+03	1.3092000E-02	8.2992000E-01	1.0865000E-02	1.6712000E-02
2.2156000E+03	1.3372000E-02	8.2996000E-01	1.1098000E-02	1.7070000E-02
2.2157000E+03	1.3654000E-02	8.2999000E-01	1.1333000E-02	1.7431000E-02
2.2158000E+03	1.3939000E-02	8.3002000E-01	1.1570000E-02	1.7796000E-02
2.2159000E+03	1.4226000E-02	8.3005000E-01	1.1808000E-02	1.8163000E-02
2.2160000E+03	1.4515000E-02	8.3009000E-01	1.2049000E-02	1.8533000E-02
2.2161000E+03	1.4807000E-02	8.3010000E-01	1.2292000E-02	1.8906000E-02
2.2162000E+03	1.5102000E-02	8.3011000E-01	1.2536000E-02	1.9282000E-02
2.2163000E+03	1.5399000E-02	8.3012000E-01	1.2783000E-02	1.9662000E-02
2.2164000E+03	1.5700000E-02	8.3013000E-01	1.3033000E-02	2.0046000E-02
2.2165000E+03	1.6003000E-02	8.3014000E-01	1.3285000E-02	2.0434000E-02
2.2166000E+03	1.6310000E-02	8.3016000E-01	1.3540000E-02	2.0826000E-02
2.2167000E+03	1.6622000E-02	8.3017000E-01	1.3799000E-02	2.1224000E-02
2.2168000E+03	1.6937000E-02	8.3018000E-01	1.4061000E-02	2.1628000E-02
2.2169000E+03	1.7258000E-02	8.3019000E-01	1.4328000E-02	2.2038000E-02
2.2170000E+03	1.7585000E-02	8.3020000E-01	1.4599000E-02	2.2455000E-02
2.2171000E+03	1.7918000E-02	8.3021000E-01	1.4875000E-02	2.2880000E-02
2.2172000E+03	1.8258000E-02	8.3021000E-01	1.5158000E-02	2.3315000E-02
2.2173000E+03	1.8606000E-02	8.3022000E-01	1.5447000E-02	2.3759000E-02
2.2174000E+03	1.8962000E-02	8.3023000E-01	1.5743000E-02	2.4215000E-02
2.2175000E+03	1.9328000E-02	8.3024000E-01	1.6047000E-02	2.4683000E-02
2.2176000E+03	1.9705000E-02	8.3024000E-01	1.6360000E-02	2.5164000E-02
2.2177000E+03	2.0094000E-02	8.3025000E-01	1.6683000E-02	2.5661000E-02
2.2178000E+03	2.0496000E-02	8.3026000E-01	1.7017000E-02	2.6174000E-02
2.2179000E+03	2.0912000E-02	8.3026000E-01	1.7362000E-02	2.6706000E-02
2.2180000E+03	2.1343000E-02	8.3027000E-01	1.7721000E-02	2.7257000E-02
2.2181000E+03	2.1792000E-02	8.3027000E-01	1.8093000E-02	2.7830000E-02
2.2182000E+03	2.2259000E-02	8.3027000E-01	1.8481000E-02	2.8426000E-02
2.2183000E+03	2.2745000E-02	8.3027000E-01	1.8885000E-02	2.9047000E-02
2.2184000E+03	2.3254000E-02	8.3027000E-01	1.9307000E-02	2.9696000E-02
2.2185000E+03	2.3785000E-02	8.3027000E-01	1.9748000E-02	3.0375000E-02
2.2186000E+03	2.4341000E-02	8.3027000E-01	2.0210000E-02	3.1086000E-02
2.2187000E+03	2.4925000E-02	8.3027000E-01	2.0694000E-02	3.1831000E-02
2.2188000E+03	2.5537000E-02	8.3027000E-01	2.1203000E-02	3.2612000E-02
2.2189000E+03	2.6180000E-02	8.3027000E-01	2.1736000E-02	3.3434000E-02
2.2190000E+03	2.6856000E-02	8.3027000E-01	2.2298000E-02	3.4297000E-02
2.2191000E+03	2.7567000E-02	8.3027000E-01	2.2888000E-02	3.5205000E-02
2.2192000E+03	2.8316000E-02	8.3027000E-01	2.3510000E-02	3.6161000E-02
2.2193000E+03	2.9104000E-02	8.3026000E-01	2.4164000E-02	3.7168000E-02
2.2194000E+03	2.9935000E-02	8.3026000E-01	2.4854000E-02	3.8229000E-02
2.2195000E+03	3.0811000E-02	8.3026000E-01	2.5581000E-02	3.9347000E-02

2.2196000E+03	3.1734000E-02	8.3026000E-01	2.6348000E-02	4.0526000E-02
2.2197000E+03	3.2708000E-02	8.3025000E-01	2.7156000E-02	4.1769000E-02
2.2198000E+03	3.3735000E-02	8.3025000E-01	2.8008000E-02	4.3080000E-02
2.2199000E+03	3.4817000E-02	8.3025000E-01	2.8907000E-02	4.4462000E-02
2.2200000E+03	3.5958000E-02	8.3025000E-01	2.9854000E-02	4.5920000E-02
2.2201000E+03	3.7162000E-02	8.3029000E-01	3.0855000E-02	4.7459000E-02
2.2202000E+03	3.8431000E-02	8.3033000E-01	3.1910000E-02	4.9082000E-02
2.2203000E+03	3.9768000E-02	8.3038000E-01	3.3022000E-02	5.0793000E-02
2.2204000E+03	4.1177000E-02	8.3042000E-01	3.4194000E-02	5.2595000E-02
2.2205000E+03	4.2661000E-02	8.3046000E-01	3.5428000E-02	5.4493000E-02
2.2206000E+03	4.4223000E-02	8.3051000E-01	3.6728000E-02	5.6492000E-02
2.2207000E+03	4.5868000E-02	8.3055000E-01	3.8096000E-02	5.8596000E-02
2.2208000E+03	4.7599000E-02	8.3059000E-01	3.9535000E-02	6.0810000E-02
2.2209000E+03	4.9419000E-02	8.3064000E-01	4.1049000E-02	6.3138000E-02
2.2210000E+03	5.1332000E-02	8.3068000E-01	4.2640000E-02	6.5586000E-02
2.2211000E+03	5.3342000E-02	8.3072000E-01	4.4312000E-02	6.8157000E-02
2.2212000E+03	5.5452000E-02	8.3076000E-01	4.6067000E-02	7.0857000E-02
2.2213000E+03	5.7667000E-02	8.3079000E-01	4.7910000E-02	7.3691000E-02
2.2214000E+03	5.9990000E-02	8.3083000E-01	4.9842000E-02	7.6663000E-02
2.2215000E+03	6.2426000E-02	8.3087000E-01	5.1868000E-02	7.9780000E-02
2.2216000E+03	6.4977000E-02	8.3091000E-01	5.3990000E-02	8.3044000E-02
2.2217000E+03	6.7649000E-02	8.3095000E-01	5.6213000E-02	8.6463000E-02
2.2218000E+03	7.0444000E-02	8.3099000E-01	5.8538000E-02	9.0039000E-02
2.2219000E+03	7.3367000E-02	8.3103000E-01	6.0970000E-02	9.3779000E-02
2.2220000E+03	7.6421000E-02	8.3107000E-01	6.3511000E-02	9.7688000E-02
2.2221000E+03	7.9610000E-02	8.3108000E-01	6.6162000E-02	1.0177000E-01
2.2222000E+03	8.2938000E-02	8.3109000E-01	6.8929000E-02	1.0602000E-01
2.2223000E+03	8.6407000E-02	8.3111000E-01	7.1814000E-02	1.1046000E-01
2.2224000E+03	9.0023000E-02	8.3112000E-01	7.4820000E-02	1.1508000E-01
2.2225000E+03	9.3787000E-02	8.3113000E-01	7.7949000E-02	1.1990000E-01
2.2226000E+03	9.7703000E-02	8.3115000E-01	8.1206000E-02	1.2490000E-01
2.2227000E+03	1.0177000E-01	8.3116000E-01	8.4591000E-02	1.3011000E-01
2.2228000E+03	1.0600000E-01	8.3117000E-01	8.8108000E-02	1.3552000E-01
2.2229000E+03	1.1039000E-01	8.3119000E-01	9.1759000E-02	1.4114000E-01
2.2230000E+03	1.1495000E-01	8.3120000E-01	9.5546000E-02	1.4696000E-01
2.2231000E+03	1.1967000E-01	8.3121000E-01	9.9470000E-02	1.5300000E-01
2.2232000E+03	1.2455000E-01	8.3123000E-01	1.0353000E-01	1.5925000E-01
2.2233000E+03	1.2961000E-01	8.3124000E-01	1.0774000E-01	1.6572000E-01
2.2234000E+03	1.3484000E-01	8.3125000E-01	1.1209000E-01	1.7240000E-01
2.2235000E+03	1.4024000E-01	8.3127000E-01	1.1658000E-01	1.7931000E-01
2.2236000E+03	1.4581000E-01	8.3128000E-01	1.2121000E-01	1.8644000E-01
2.2237000E+03	1.5156000E-01	8.3129000E-01	1.2599000E-01	1.9379000E-01
2.2238000E+03	1.5748000E-01	8.3131000E-01	1.3091000E-01	2.0136000E-01

2.2239000E+03	1.6358000E-01	8.3132000E-01	1.3598000E-01	2.0916000E-01
2.2240000E+03	1.6985000E-01	8.3134000E-01	1.4120000E-01	2.1718000E-01
2.2241000E+03	1.7629000E-01	8.3134000E-01	1.4656000E-01	2.2542000E-01
2.2242000E+03	1.8290000E-01	8.3135000E-01	1.5206000E-01	2.3388000E-01
2.2243000E+03	1.8969000E-01	8.3136000E-01	1.5770000E-01	2.4257000E-01
2.2244000E+03	1.9665000E-01	8.3137000E-01	1.6349000E-01	2.5146000E-01
2.2245000E+03	2.0377000E-01	8.3138000E-01	1.6941000E-01	2.6057000E-01
2.2246000E+03	2.1105000E-01	8.3139000E-01	1.7547000E-01	2.6989000E-01
2.2247000E+03	2.1850000E-01	8.3140000E-01	1.8166000E-01	2.7942000E-01
2.2248000E+03	2.2611000E-01	8.3141000E-01	1.8799000E-01	2.8915000E-01
2.2249000E+03	2.3387000E-01	8.3142000E-01	1.9444000E-01	2.9908000E-01
2.2250000E+03	2.4177000E-01	8.3143000E-01	2.0102000E-01	3.0919000E-01
2.2251000E+03	2.4983000E-01	8.3145000E-01	2.0772000E-01	3.1950000E-01
2.2252000E+03	2.5802000E-01	8.3146000E-01	2.1453000E-01	3.2998000E-01
2.2253000E+03	2.6635000E-01	8.3148000E-01	2.2146000E-01	3.4064000E-01
2.2254000E+03	2.7480000E-01	8.3150000E-01	2.2850000E-01	3.5146000E-01
2.2255000E+03	2.8338000E-01	8.3151000E-01	2.3563000E-01	3.6244000E-01
2.2256000E+03	2.9207000E-01	8.3153000E-01	2.4287000E-01	3.7356000E-01
2.2257000E+03	3.0088000E-01	8.3154000E-01	2.5019000E-01	3.8483000E-01
2.2258000E+03	3.0978000E-01	8.3156000E-01	2.5760000E-01	3.9622000E-01
2.2259000E+03	3.1877000E-01	8.3158000E-01	2.6508000E-01	4.0773000E-01
2.2260000E+03	3.2785000E-01	8.3159000E-01	2.7264000E-01	4.1936000E-01
2.2261000E+03	3.3701000E-01	8.3159000E-01	2.8026000E-01	4.3107000E-01
2.2262000E+03	3.4624000E-01	8.3159000E-01	2.8793000E-01	4.4287000E-01
2.2263000E+03	3.5552000E-01	8.3158000E-01	2.9565000E-01	4.5474000E-01
2.2264000E+03	3.6486000E-01	8.3158000E-01	3.0341000E-01	4.6668000E-01
2.2265000E+03	3.7424000E-01	8.3158000E-01	3.1121000E-01	4.7867000E-01
2.2266000E+03	3.8364000E-01	8.3157000E-01	3.1903000E-01	4.9071000E-01
2.2267000E+03	3.9307000E-01	8.3157000E-01	3.2687000E-01	5.0276000E-01
2.2268000E+03	4.0251000E-01	8.3157000E-01	3.3472000E-01	5.1484000E-01
2.2269000E+03	4.1195000E-01	8.3156000E-01	3.4257000E-01	5.2691000E-01
2.2270000E+03	4.2139000E-01	8.3156000E-01	3.5041000E-01	5.3898000E-01
2.2271000E+03	4.3081000E-01	8.3156000E-01	3.5824000E-01	5.5102000E-01
2.2272000E+03	4.4019000E-01	8.3155000E-01	3.6604000E-01	5.6302000E-01
2.2273000E+03	4.4954000E-01	8.3155000E-01	3.7382000E-01	5.7498000E-01
2.2274000E+03	4.5884000E-01	8.3154000E-01	3.8155000E-01	5.8687000E-01
2.2275000E+03	4.6809000E-01	8.3154000E-01	3.8923000E-01	5.9869000E-01
2.2276000E+03	4.7726000E-01	8.3153000E-01	3.9686000E-01	6.1042000E-01
2.2277000E+03	4.8636000E-01	8.3153000E-01	4.0442000E-01	6.2205000E-01
2.2278000E+03	4.9537000E-01	8.3152000E-01	4.1191000E-01	6.3357000E-01
2.2279000E+03	5.0428000E-01	8.3152000E-01	4.1932000E-01	6.4496000E-01
2.2280000E+03	5.1309000E-01	8.3151000E-01	4.2664000E-01	6.5623000E-01
2.2281000E+03	5.2178000E-01	8.3152000E-01	4.3387000E-01	6.6735000E-01

2.2282000E+03	5.3035000E-01	8.3152000E-01	4.4100000E-01	6.7831000E-01
2.2283000E+03	5.3878000E-01	8.3153000E-01	4.4802000E-01	6.8910000E-01
2.2284000E+03	5.4708000E-01	8.3153000E-01	4.5492000E-01	6.9972000E-01
2.2285000E+03	5.5524000E-01	8.3154000E-01	4.6170000E-01	7.1015000E-01
2.2286000E+03	5.6323000E-01	8.3154000E-01	4.6835000E-01	7.2039000E-01
2.2287000E+03	5.7107000E-01	8.3155000E-01	4.7487000E-01	7.3042000E-01
2.2288000E+03	5.7875000E-01	8.3155000E-01	4.8126000E-01	7.4023000E-01
2.2289000E+03	5.8625000E-01	8.3156000E-01	4.8750000E-01	7.4983000E-01
2.2290000E+03	5.9357000E-01	8.3156000E-01	4.9359000E-01	7.5920000E-01
2.2291000E+03	6.0071000E-01	8.3156000E-01	4.9952000E-01	7.6833000E-01
2.2292000E+03	6.0766000E-01	8.3156000E-01	5.0531000E-01	7.7723000E-01
2.2293000E+03	6.1442000E-01	8.3156000E-01	5.1093000E-01	7.8588000E-01
2.2294000E+03	6.2099000E-01	8.3156000E-01	5.1639000E-01	7.9428000E-01
2.2295000E+03	6.2736000E-01	8.3156000E-01	5.2169000E-01	8.0243000E-01
2.2296000E+03	6.3353000E-01	8.3156000E-01	5.2682000E-01	8.1032000E-01
2.2297000E+03	6.3950000E-01	8.3156000E-01	5.3179000E-01	8.1796000E-01
2.2298000E+03	6.4527000E-01	8.3156000E-01	5.3658000E-01	8.2533000E-01
2.2299000E+03	6.5084000E-01	8.3155000E-01	5.4121000E-01	8.3245000E-01
2.2300000E+03	6.5620000E-01	8.3155000E-01	5.4567000E-01	8.3931000E-01
2.2301000E+03	6.6137000E-01	8.3159000E-01	5.4998000E-01	8.4595000E-01
2.2302000E+03	6.6633000E-01	8.3163000E-01	5.5414000E-01	8.5233000E-01
2.2303000E+03	6.7109000E-01	8.3167000E-01	5.5812000E-01	8.5846000E-01
2.2304000E+03	6.7565000E-01	8.3170000E-01	5.6194000E-01	8.6434000E-01
2.2305000E+03	6.8002000E-01	8.3174000E-01	5.6560000E-01	8.6996000E-01
2.2306000E+03	6.8419000E-01	8.3178000E-01	5.6909000E-01	8.7534000E-01
2.2307000E+03	6.8817000E-01	8.3182000E-01	5.7243000E-01	8.8048000E-01
2.2308000E+03	6.9196000E-01	8.3186000E-01	5.7562000E-01	8.8537000E-01
2.2309000E+03	6.9558000E-01	8.3190000E-01	5.7865000E-01	8.9004000E-01
2.2310000E+03	6.9901000E-01	8.3194000E-01	5.8153000E-01	8.9447000E-01
2.2311000E+03	7.0227000E-01	8.3198000E-01	5.8427000E-01	8.9869000E-01
2.2312000E+03	7.0536000E-01	8.3201000E-01	5.8687000E-01	9.0269000E-01
2.2313000E+03	7.0829000E-01	8.3205000E-01	5.8934000E-01	9.0647000E-01
2.2314000E+03	7.1106000E-01	8.3209000E-01	5.9167000E-01	9.1006000E-01
2.2315000E+03	7.1368000E-01	8.3213000E-01	5.9387000E-01	9.1345000E-01
2.2316000E+03	7.1615000E-01	8.3217000E-01	5.9596000E-01	9.1666000E-01
2.2317000E+03	7.1848000E-01	8.3221000E-01	5.9792000E-01	9.1968000E-01
2.2318000E+03	7.2068000E-01	8.3224000E-01	5.9978000E-01	9.2254000E-01
2.2319000E+03	7.2275000E-01	8.3228000E-01	6.0153000E-01	9.2523000E-01
2.2320000E+03	7.2470000E-01	8.3232000E-01	6.0318000E-01	9.2777000E-01
2.2321000E+03	7.2653000E-01	8.3235000E-01	6.0473000E-01	9.3015000E-01
2.2322000E+03	7.2826000E-01	8.3239000E-01	6.0619000E-01	9.3240000E-01
2.2323000E+03	7.2988000E-01	8.3242000E-01	6.0757000E-01	9.3451000E-01
2.2324000E+03	7.3141000E-01	8.3245000E-01	6.0886000E-01	9.3651000E-01

2.2325000E+03	7.3285000E-01	8.3248000E-01	6.1009000E-01	9.3839000E-01
2.2326000E+03	7.3421000E-01	8.3252000E-01	6.1124000E-01	9.4017000E-01
2.2327000E+03	7.3549000E-01	8.3255000E-01	6.1233000E-01	9.4185000E-01
2.2328000E+03	7.3670000E-01	8.3258000E-01	6.1337000E-01	9.4344000E-01
2.2329000E+03	7.3785000E-01	8.3261000E-01	6.1435000E-01	9.4494000E-01
2.2330000E+03	7.3894000E-01	8.3265000E-01	6.1528000E-01	9.4638000E-01
2.2331000E+03	7.3998000E-01	8.3268000E-01	6.1617000E-01	9.4775000E-01
2.2332000E+03	7.4097000E-01	8.3272000E-01	6.1702000E-01	9.4906000E-01
2.2333000E+03	7.4193000E-01	8.3275000E-01	6.1784000E-01	9.5032000E-01
2.2334000E+03	7.4284000E-01	8.3279000E-01	6.1863000E-01	9.5153000E-01
2.2335000E+03	7.4372000E-01	8.3282000E-01	6.1939000E-01	9.5269000E-01
2.2336000E+03	7.4457000E-01	8.3286000E-01	6.2012000E-01	9.5383000E-01
2.2337000E+03	7.4540000E-01	8.3289000E-01	6.2084000E-01	9.5493000E-01
2.2338000E+03	7.4621000E-01	8.3293000E-01	6.2154000E-01	9.5601000E-01
2.2339000E+03	7.4701000E-01	8.3296000E-01	6.2223000E-01	9.5707000E-01
2.2340000E+03	7.4779000E-01	8.3300000E-01	6.2291000E-01	9.5811000E-01
2.2341000E+03	7.4856000E-01	8.3302000E-01	6.2357000E-01	9.5913000E-01
2.2342000E+03	7.4933000E-01	8.3304000E-01	6.2422000E-01	9.6014000E-01
2.2343000E+03	7.5009000E-01	8.3307000E-01	6.2487000E-01	9.6114000E-01
2.2344000E+03	7.5085000E-01	8.3309000E-01	6.2552000E-01	9.6214000E-01
2.2345000E+03	7.5161000E-01	8.3311000E-01	6.2617000E-01	9.6313000E-01
2.2346000E+03	7.5237000E-01	8.3313000E-01	6.2682000E-01	9.6413000E-01
2.2347000E+03	7.5313000E-01	8.3316000E-01	6.2747000E-01	9.6514000E-01
2.2348000E+03	7.5389000E-01	8.3318000E-01	6.2813000E-01	9.6614000E-01
2.2349000E+03	7.5466000E-01	8.3320000E-01	6.2879000E-01	9.6715000E-01
2.2350000E+03	7.5543000E-01	8.3323000E-01	6.2945000E-01	9.6817000E-01
2.2351000E+03	7.5621000E-01	8.3325000E-01	6.3011000E-01	9.6919000E-01
2.2352000E+03	7.5699000E-01	8.3327000E-01	6.3078000E-01	9.7022000E-01
2.2353000E+03	7.5778000E-01	8.3329000E-01	6.3145000E-01	9.7125000E-01
2.2354000E+03	7.5857000E-01	8.3331000E-01	6.3212000E-01	9.7228000E-01
2.2355000E+03	7.5937000E-01	8.3332000E-01	6.3280000E-01	9.7332000E-01
2.2356000E+03	7.6016000E-01	8.3334000E-01	6.3348000E-01	9.7437000E-01
2.2357000E+03	7.6096000E-01	8.3336000E-01	6.3416000E-01	9.7542000E-01
2.2358000E+03	7.6176000E-01	8.3338000E-01	6.3484000E-01	9.7646000E-01
2.2359000E+03	7.6256000E-01	8.3340000E-01	6.3552000E-01	9.7751000E-01
2.2360000E+03	7.6336000E-01	8.3342000E-01	6.3620000E-01	9.7856000E-01
2.2361000E+03	7.6415000E-01	8.3345000E-01	6.3689000E-01	9.7961000E-01
2.2362000E+03	7.6495000E-01	8.3348000E-01	6.3757000E-01	9.8067000E-01
2.2363000E+03	7.6573000E-01	8.3352000E-01	6.3825000E-01	9.8171000E-01
2.2364000E+03	7.6651000E-01	8.3355000E-01	6.3892000E-01	9.8274000E-01
2.2365000E+03	7.6728000E-01	8.3358000E-01	6.3959000E-01	9.8377000E-01
2.2366000E+03	7.6804000E-01	8.3361000E-01	6.4024000E-01	9.8478000E-01
2.2367000E+03	7.6878000E-01	8.3364000E-01	6.4089000E-01	9.8577000E-01

2.2368000E+03	7.6952000E-01	8.3367000E-01	6.4153000E-01	9.8675000E-01
2.2369000E+03	7.7024000E-01	8.3370000E-01	6.4215000E-01	9.8771000E-01
2.2370000E+03	7.7094000E-01	8.3373000E-01	6.4276000E-01	9.8864000E-01
2.2371000E+03	7.7162000E-01	8.3376000E-01	6.4334000E-01	9.8955000E-01
2.2372000E+03	7.7228000E-01	8.3378000E-01	6.4391000E-01	9.9042000E-01
2.2373000E+03	7.7293000E-01	8.3380000E-01	6.4447000E-01	9.9127000E-01
2.2374000E+03	7.7355000E-01	8.3383000E-01	6.4500000E-01	9.9210000E-01
2.2375000E+03	7.7414000E-01	8.3385000E-01	6.4552000E-01	9.9289000E-01
2.2376000E+03	7.7471000E-01	8.3387000E-01	6.4601000E-01	9.9365000E-01
2.2377000E+03	7.7526000E-01	8.3389000E-01	6.4648000E-01	9.9437000E-01
2.2378000E+03	7.7578000E-01	8.3392000E-01	6.4693000E-01	9.9507000E-01
2.2379000E+03	7.7627000E-01	8.3394000E-01	6.4736000E-01	9.9572000E-01
2.2380000E+03	7.7672000E-01	8.3396000E-01	6.4776000E-01	9.9634000E-01
2.2381000E+03	7.7715000E-01	8.3395000E-01	6.4811000E-01	9.9688000E-01
2.2382000E+03	7.7755000E-01	8.3394000E-01	6.4843000E-01	9.9737000E-01
2.2383000E+03	7.7792000E-01	8.3393000E-01	6.4873000E-01	9.9783000E-01
2.2384000E+03	7.7825000E-01	8.3392000E-01	6.4900000E-01	9.9825000E-01
2.2385000E+03	7.7856000E-01	8.3391000E-01	6.4925000E-01	9.9862000E-01
2.2386000E+03	7.7882000E-01	8.3390000E-01	6.4946000E-01	9.9895000E-01
2.2387000E+03	7.7906000E-01	8.3389000E-01	6.4965000E-01	9.9924000E-01
2.2388000E+03	7.7925000E-01	8.3388000E-01	6.4980000E-01	9.9948000E-01
2.2389000E+03	7.7942000E-01	8.3387000E-01	6.4993000E-01	9.9968000E-01
2.2390000E+03	7.7954000E-01	8.3386000E-01	6.5003000E-01	9.9983000E-01
2.2391000E+03	7.7963000E-01	8.3385000E-01	6.5010000E-01	9.9993000E-01
2.2392000E+03	7.7968000E-01	8.3384000E-01	6.5013000E-01	9.9999000E-01
2.2393000E+03	7.7970000E-01	8.3384000E-01	6.5014000E-01	1.0000000E+00
2.2394000E+03	7.7967000E-01	8.3383000E-01	6.5011000E-01	9.9996000E-01
2.2395000E+03	7.7961000E-01	8.3382000E-01	6.5006000E-01	9.9987000E-01
2.2396000E+03	7.7951000E-01	8.3382000E-01	6.4996000E-01	9.9973000E-01
2.2397000E+03	7.7936000E-01	8.3381000E-01	6.4984000E-01	9.9954000E-01
2.2398000E+03	7.7918000E-01	8.3380000E-01	6.4968000E-01	9.9929000E-01
2.2399000E+03	7.7895000E-01	8.3379000E-01	6.4948000E-01	9.9899000E-01
2.2400000E+03	7.7868000E-01	8.3379000E-01	6.4925000E-01	9.9863000E-01
2.2401000E+03	7.7836000E-01	8.3379000E-01	6.4899000E-01	9.9823000E-01
2.2402000E+03	7.7800000E-01	8.3379000E-01	6.4869000E-01	9.9777000E-01
2.2403000E+03	7.7759000E-01	8.3379000E-01	6.4835000E-01	9.9725000E-01
2.2404000E+03	7.7714000E-01	8.3379000E-01	6.4797000E-01	9.9666000E-01
2.2405000E+03	7.7663000E-01	8.3379000E-01	6.4755000E-01	9.9602000E-01
2.2406000E+03	7.7608000E-01	8.3379000E-01	6.4709000E-01	9.9530000E-01
2.2407000E+03	7.7547000E-01	8.3380000E-01	6.4658000E-01	9.9452000E-01
2.2408000E+03	7.7480000E-01	8.3380000E-01	6.4602000E-01	9.9367000E-01
2.2409000E+03	7.7408000E-01	8.3380000E-01	6.4542000E-01	9.9274000E-01
2.2410000E+03	7.7329000E-01	8.3380000E-01	6.4477000E-01	9.9174000E-01

2.2411000E+03	7.7245000E-01	8.3380000E-01	6.4407000E-01	9.9066000E-01
2.2412000E+03	7.7154000E-01	8.3381000E-01	6.4332000E-01	9.8950000E-01
2.2413000E+03	7.7056000E-01	8.3381000E-01	6.4251000E-01	9.8826000E-01
2.2414000E+03	7.6952000E-01	8.3382000E-01	6.4164000E-01	9.8692000E-01
2.2415000E+03	7.6840000E-01	8.3382000E-01	6.4071000E-01	9.8549000E-01
2.2416000E+03	7.6721000E-01	8.3383000E-01	6.3972000E-01	9.8397000E-01
2.2417000E+03	7.6594000E-01	8.3383000E-01	6.3866000E-01	9.8234000E-01
2.2418000E+03	7.6458000E-01	8.3383000E-01	6.3754000E-01	9.8061000E-01
2.2419000E+03	7.6315000E-01	8.3384000E-01	6.3634000E-01	9.7877000E-01
2.2420000E+03	7.6162000E-01	8.3384000E-01	6.3507000E-01	9.7682000E-01
2.2421000E+03	7.6000000E-01	8.3388000E-01	6.3375000E-01	9.7479000E-01
2.2422000E+03	7.5829000E-01	8.3391000E-01	6.3235000E-01	9.7263000E-01
2.2423000E+03	7.5648000E-01	8.3394000E-01	6.3086000E-01	9.7034000E-01
2.2424000E+03	7.5456000E-01	8.3398000E-01	6.2929000E-01	9.6793000E-01
2.2425000E+03	7.5254000E-01	8.3401000E-01	6.2763000E-01	9.6537000E-01
2.2426000E+03	7.5041000E-01	8.3405000E-01	6.2588000E-01	9.6268000E-01
2.2427000E+03	7.4817000E-01	8.3408000E-01	6.2403000E-01	9.5984000E-01
2.2428000E+03	7.4581000E-01	8.3411000E-01	6.2209000E-01	9.5685000E-01
2.2429000E+03	7.4333000E-01	8.3415000E-01	6.2004000E-01	9.5371000E-01
2.2430000E+03	7.4072000E-01	8.3418000E-01	6.1790000E-01	9.5040000E-01
2.2431000E+03	7.3799000E-01	8.3421000E-01	6.1564000E-01	9.4694000E-01
2.2432000E+03	7.3513000E-01	8.3425000E-01	6.1328000E-01	9.4330000E-01
2.2433000E+03	7.3213000E-01	8.3428000E-01	6.1080000E-01	9.3949000E-01
2.2434000E+03	7.2899000E-01	8.3432000E-01	6.0821000E-01	9.3551000E-01
2.2435000E+03	7.2572000E-01	8.3435000E-01	6.0550000E-01	9.3134000E-01
2.2436000E+03	7.2230000E-01	8.3439000E-01	6.0268000E-01	9.2699000E-01
2.2437000E+03	7.1873000E-01	8.3442000E-01	5.9973000E-01	9.2246000E-01
2.2438000E+03	7.1502000E-01	8.3445000E-01	5.9665000E-01	9.1773000E-01
2.2439000E+03	7.1115000E-01	8.3449000E-01	5.9345000E-01	9.1280000E-01
2.2440000E+03	7.0714000E-01	8.3452000E-01	5.9012000E-01	9.0768000E-01
2.2441000E+03	7.0296000E-01	8.3454000E-01	5.8665000E-01	9.0234000E-01
2.2442000E+03	6.9863000E-01	8.3456000E-01	5.8305000E-01	8.9680000E-01
2.2443000E+03	6.9414000E-01	8.3457000E-01	5.7931000E-01	8.9106000E-01
2.2444000E+03	6.8949000E-01	8.3459000E-01	5.7544000E-01	8.8510000E-01
2.2445000E+03	6.8468000E-01	8.3461000E-01	5.7144000E-01	8.7895000E-01
2.2446000E+03	6.7971000E-01	8.3463000E-01	5.6730000E-01	8.7258000E-01
2.2447000E+03	6.7457000E-01	8.3464000E-01	5.6303000E-01	8.6601000E-01
2.2448000E+03	6.6927000E-01	8.3466000E-01	5.5862000E-01	8.5923000E-01
2.2449000E+03	6.6381000E-01	8.3468000E-01	5.5407000E-01	8.5223000E-01
2.2450000E+03	6.5819000E-01	8.3470000E-01	5.4939000E-01	8.4503000E-01
2.2451000E+03	6.5241000E-01	8.3471000E-01	5.4457000E-01	8.3762000E-01
2.2452000E+03	6.4647000E-01	8.3473000E-01	5.3962000E-01	8.3001000E-01
2.2453000E+03	6.4037000E-01	8.3474000E-01	5.3454000E-01	8.2219000E-01

2.2454000E+03	6.3411000E-01	8.3477000E-01	5.2933000E-01	8.1418000E-01
2.2455000E+03	6.2769000E-01	8.3481000E-01	5.2400000E-01	8.0598000E-01
2.2456000E+03	6.2113000E-01	8.3484000E-01	5.1854000E-01	7.9759000E-01
2.2457000E+03	6.1441000E-01	8.3488000E-01	5.1296000E-01	7.8900000E-01
2.2458000E+03	6.0755000E-01	8.3492000E-01	5.0725000E-01	7.8022000E-01
2.2459000E+03	6.0054000E-01	8.3495000E-01	5.0142000E-01	7.7125000E-01
2.2460000E+03	5.9339000E-01	8.3499000E-01	4.9547000E-01	7.6210000E-01
2.2461000E+03	5.8611000E-01	8.3502000E-01	4.8941000E-01	7.5278000E-01
2.2462000E+03	5.7869000E-01	8.3505000E-01	4.8324000E-01	7.4328000E-01
2.2463000E+03	5.7114000E-01	8.3508000E-01	4.7695000E-01	7.3361000E-01
2.2464000E+03	5.6348000E-01	8.3511000E-01	4.7057000E-01	7.2379000E-01
2.2465000E+03	5.5569000E-01	8.3514000E-01	4.6408000E-01	7.1382000E-01
2.2466000E+03	5.4779000E-01	8.3517000E-01	4.5750000E-01	7.0370000E-01
2.2467000E+03	5.3978000E-01	8.3521000E-01	4.5083000E-01	6.9343000E-01
2.2468000E+03	5.3167000E-01	8.3524000E-01	4.4407000E-01	6.8304000E-01
2.2469000E+03	5.2347000E-01	8.3527000E-01	4.3724000E-01	6.7252000E-01
2.2470000E+03	5.1517000E-01	8.3530000E-01	4.3032000E-01	6.6189000E-01
2.2471000E+03	5.0679000E-01	8.3532000E-01	4.2334000E-01	6.5114000E-01
2.2472000E+03	4.9834000E-01	8.3534000E-01	4.1628000E-01	6.4030000E-01
2.2473000E+03	4.8981000E-01	8.3537000E-01	4.0917000E-01	6.2936000E-01
2.2474000E+03	4.8122000E-01	8.3539000E-01	4.0200000E-01	6.1833000E-01
2.2475000E+03	4.7257000E-01	8.3541000E-01	3.9479000E-01	6.0724000E-01
2.2476000E+03	4.6387000E-01	8.3544000E-01	3.8753000E-01	5.9608000E-01
2.2477000E+03	4.5513000E-01	8.3546000E-01	3.8024000E-01	5.8486000E-01
2.2478000E+03	4.4635000E-01	8.3548000E-01	3.7292000E-01	5.7360000E-01
2.2479000E+03	4.3754000E-01	8.3551000E-01	3.6557000E-01	5.6229000E-01
2.2480000E+03	4.2871000E-01	8.3553000E-01	3.5820000E-01	5.5096000E-01
2.2481000E+03	4.1987000E-01	8.3553000E-01	3.5082000E-01	5.3960000E-01
2.2482000E+03	4.1102000E-01	8.3553000E-01	3.4342000E-01	5.2823000E-01
2.2483000E+03	4.0218000E-01	8.3553000E-01	3.3603000E-01	5.1685000E-01
2.2484000E+03	3.9334000E-01	8.3552000E-01	3.2864000E-01	5.0549000E-01
2.2485000E+03	3.8451000E-01	8.3552000E-01	3.2127000E-01	4.9415000E-01
2.2486000E+03	3.7571000E-01	8.3552000E-01	3.1391000E-01	4.8283000E-01
2.2487000E+03	3.6693000E-01	8.3552000E-01	3.0658000E-01	4.7156000E-01
2.2488000E+03	3.5820000E-01	8.3552000E-01	2.9928000E-01	4.6033000E-01
2.2489000E+03	3.4950000E-01	8.3551000E-01	2.9201000E-01	4.4915000E-01
2.2490000E+03	3.4086000E-01	8.3551000E-01	2.8479000E-01	4.3804000E-01
2.2491000E+03	3.3227000E-01	8.3551000E-01	2.7761000E-01	4.2701000E-01
2.2492000E+03	3.2375000E-01	8.3550000E-01	2.7049000E-01	4.1605000E-01
2.2493000E+03	3.1529000E-01	8.3550000E-01	2.6342000E-01	4.0518000E-01
2.2494000E+03	3.0691000E-01	8.3549000E-01	2.5642000E-01	3.9441000E-01
2.2495000E+03	2.9862000E-01	8.3549000E-01	2.4949000E-01	3.8375000E-01
2.2496000E+03	2.9041000E-01	8.3548000E-01	2.4263000E-01	3.7319000E-01

2.2497000E+03	2.8229000E-01	8.3548000E-01	2.3585000E-01	3.6276000E-01
2.2498000E+03	2.7427000E-01	8.3547000E-01	2.2915000E-01	3.5246000E-01
2.2499000E+03	2.6636000E-01	8.3547000E-01	2.2254000E-01	3.4229000E-01
2.2500000E+03	2.5855000E-01	8.3546000E-01	2.1601000E-01	3.3226000E-01
2.2501000E+03	2.5086000E-01	8.3549000E-01	2.0959000E-01	3.2238000E-01
2.2502000E+03	2.4329000E-01	8.3552000E-01	2.0327000E-01	3.1266000E-01
2.2503000E+03	2.3584000E-01	8.3555000E-01	1.9706000E-01	3.0310000E-01
2.2504000E+03	2.2851000E-01	8.3558000E-01	1.9094000E-01	2.9369000E-01
2.2505000E+03	2.2132000E-01	8.3561000E-01	1.8494000E-01	2.8446000E-01
2.2506000E+03	2.1426000E-01	8.3564000E-01	1.7904000E-01	2.7539000E-01
2.2507000E+03	2.0733000E-01	8.3567000E-01	1.7326000E-01	2.6650000E-01
2.2508000E+03	2.0054000E-01	8.3570000E-01	1.6759000E-01	2.5778000E-01
2.2509000E+03	1.9390000E-01	8.3572000E-01	1.6205000E-01	2.4925000E-01
2.2510000E+03	1.8740000E-01	8.3575000E-01	1.5662000E-01	2.4090000E-01
2.2511000E+03	1.8104000E-01	8.3578000E-01	1.5131000E-01	2.3274000E-01
2.2512000E+03	1.7484000E-01	8.3581000E-01	1.4613000E-01	2.2477000E-01
2.2513000E+03	1.6878000E-01	8.3584000E-01	1.4107000E-01	2.1699000E-01
2.2514000E+03	1.6287000E-01	8.3586000E-01	1.3614000E-01	2.0940000E-01
2.2515000E+03	1.5712000E-01	8.3589000E-01	1.3134000E-01	2.0201000E-01
2.2516000E+03	1.5152000E-01	8.3592000E-01	1.2666000E-01	1.9481000E-01
2.2517000E+03	1.4607000E-01	8.3595000E-01	1.2210000E-01	1.8781000E-01
2.2518000E+03	1.4077000E-01	8.3597000E-01	1.1768000E-01	1.8101000E-01
2.2519000E+03	1.3563000E-01	8.3600000E-01	1.1338000E-01	1.7440000E-01
2.2520000E+03	1.3063000E-01	8.3603000E-01	1.0921000E-01	1.6798000E-01
2.2521000E+03	1.2579000E-01	8.3606000E-01	1.0517000E-01	1.6177000E-01
2.2522000E+03	1.2110000E-01	8.3610000E-01	1.0125000E-01	1.5574000E-01
2.2523000E+03	1.1656000E-01	8.3613000E-01	9.7461000E-02	1.4991000E-01
2.2524000E+03	1.1217000E-01	8.3617000E-01	9.3794000E-02	1.4427000E-01
2.2525000E+03	1.0793000E-01	8.3620000E-01	9.0249000E-02	1.3881000E-01
2.2526000E+03	1.0383000E-01	8.3623000E-01	8.6825000E-02	1.3355000E-01
2.2527000E+03	9.9873000E-02	8.3627000E-01	8.3521000E-02	1.2847000E-01
2.2528000E+03	9.6060000E-02	8.3630000E-01	8.0335000E-02	1.2357000E-01
2.2529000E+03	9.2386000E-02	8.3634000E-01	7.7266000E-02	1.1884000E-01
2.2530000E+03	8.8848000E-02	8.3637000E-01	7.4310000E-02	1.1430000E-01
2.2531000E+03	8.5445000E-02	8.3641000E-01	7.1467000E-02	1.0993000E-01
2.2532000E+03	8.2174000E-02	8.3645000E-01	6.8734000E-02	1.0572000E-01
2.2533000E+03	7.9032000E-02	8.3648000E-01	6.6109000E-02	1.0168000E-01
2.2534000E+03	7.6015000E-02	8.3652000E-01	6.3588000E-02	9.7806000E-02
2.2535000E+03	7.3121000E-02	8.3655000E-01	6.1170000E-02	9.4087000E-02
2.2536000E+03	7.0347000E-02	8.3659000E-01	5.8852000E-02	9.0522000E-02
2.2537000E+03	6.7690000E-02	8.3663000E-01	5.6631000E-02	8.7106000E-02
2.2538000E+03	6.5145000E-02	8.3666000E-01	5.4504000E-02	8.3835000E-02
2.2539000E+03	6.2710000E-02	8.3670000E-01	5.2469000E-02	8.0705000E-02

2.2540000E+03	6.0381000E-02	8.3673000E-01	5.0523000E-02	7.7711000E-02
2.2541000E+03	5.8155000E-02	8.3677000E-01	4.8662000E-02	7.4849000E-02
2.2542000E+03	5.6029000E-02	8.3680000E-01	4.6885000E-02	7.2114000E-02
2.2543000E+03	5.3998000E-02	8.3683000E-01	4.5187000E-02	6.9503000E-02
2.2544000E+03	5.2058000E-02	8.3686000E-01	4.3566000E-02	6.7010000E-02
2.2545000E+03	5.0208000E-02	8.3689000E-01	4.2019000E-02	6.4630000E-02
2.2546000E+03	4.8442000E-02	8.3692000E-01	4.0542000E-02	6.2360000E-02
2.2547000E+03	4.6758000E-02	8.3695000E-01	3.9134000E-02	6.0194000E-02
2.2548000E+03	4.5152000E-02	8.3697000E-01	3.7790000E-02	5.8127000E-02
2.2549000E+03	4.3620000E-02	8.3698000E-01	3.6509000E-02	5.6155000E-02
2.2550000E+03	4.2159000E-02	8.3699000E-01	3.5286000E-02	5.4275000E-02
2.2551000E+03	4.0765000E-02	8.3701000E-01	3.4121000E-02	5.2482000E-02
2.2552000E+03	3.9436000E-02	8.3702000E-01	3.3009000E-02	5.0772000E-02
2.2553000E+03	3.8167000E-02	8.3704000E-01	3.1948000E-02	4.9139000E-02
2.2554000E+03	3.6957000E-02	8.3705000E-01	3.0935000E-02	4.7582000E-02
2.2555000E+03	3.5801000E-02	8.3707000E-01	2.9968000E-02	4.6094000E-02
2.2556000E+03	3.4696000E-02	8.3709000E-01	2.9043000E-02	4.4673000E-02
2.2557000E+03	3.3640000E-02	8.3710000E-01	2.8160000E-02	4.3314000E-02
2.2558000E+03	3.2630000E-02	8.3712000E-01	2.7315000E-02	4.2014000E-02
2.2559000E+03	3.1663000E-02	8.3713000E-01	2.6506000E-02	4.0770000E-02
2.2560000E+03	3.0736000E-02	8.3715000E-01	2.5731000E-02	3.9577000E-02
2.2561000E+03	2.9847000E-02	8.3716000E-01	2.4987000E-02	3.8433000E-02
2.2562000E+03	2.8994000E-02	8.3716000E-01	2.4272000E-02	3.7334000E-02
2.2563000E+03	2.8173000E-02	8.3717000E-01	2.3586000E-02	3.6278000E-02
2.2564000E+03	2.7384000E-02	8.3718000E-01	2.2925000E-02	3.5262000E-02
2.2565000E+03	2.6624000E-02	8.3719000E-01	2.2289000E-02	3.4283000E-02
2.2566000E+03	2.5890000E-02	8.3719000E-01	2.1675000E-02	3.3339000E-02
2.2567000E+03	2.5182000E-02	8.3720000E-01	2.1082000E-02	3.2427000E-02
2.2568000E+03	2.4497000E-02	8.3721000E-01	2.0509000E-02	3.1546000E-02
2.2569000E+03	2.3834000E-02	8.3721000E-01	1.9954000E-02	3.0692000E-02
2.2570000E+03	2.3191000E-02	8.3722000E-01	1.9416000E-02	2.9864000E-02
2.2571000E+03	2.2567000E-02	8.3723000E-01	1.8894000E-02	2.9062000E-02
2.2572000E+03	2.1961000E-02	8.3724000E-01	1.8387000E-02	2.8281000E-02
2.2573000E+03	2.1372000E-02	8.3725000E-01	1.7894000E-02	2.7523000E-02
2.2574000E+03	2.0798000E-02	8.3725000E-01	1.7413000E-02	2.6784000E-02
2.2575000E+03	2.0239000E-02	8.3726000E-01	1.6946000E-02	2.6065000E-02
2.2576000E+03	1.9694000E-02	8.3727000E-01	1.6489000E-02	2.5363000E-02
2.2577000E+03	1.9162000E-02	8.3728000E-01	1.6044000E-02	2.4678000E-02
2.2578000E+03	1.8643000E-02	8.3729000E-01	1.5609000E-02	2.4009000E-02
2.2579000E+03	1.8135000E-02	8.3729000E-01	1.5184000E-02	2.3356000E-02
2.2580000E+03	1.7639000E-02	8.3730000E-01	1.4769000E-02	2.2717000E-02
2.2581000E+03	1.7154000E-02	8.3730000E-01	1.4363000E-02	2.2093000E-02
2.2582000E+03	1.6681000E-02	8.3730000E-01	1.3967000E-02	2.1483000E-02

2.2583000E+03	1.6217000E-02	8.3730000E-01	1.3579000E-02	2.0886000E-02
2.2584000E+03	1.5765000E-02	8.3730000E-01	1.3200000E-02	2.0303000E-02
2.2585000E+03	1.5322000E-02	8.3730000E-01	1.2829000E-02	1.9733000E-02
2.2586000E+03	1.4891000E-02	8.3729000E-01	1.2468000E-02	1.9177000E-02
2.2587000E+03	1.4469000E-02	8.3729000E-01	1.2115000E-02	1.8634000E-02
2.2588000E+03	1.4058000E-02	8.3729000E-01	1.1771000E-02	1.8105000E-02
2.2589000E+03	1.3657000E-02	8.3729000E-01	1.1435000E-02	1.7589000E-02
2.2590000E+03	1.3267000E-02	8.3729000E-01	1.1108000E-02	1.7086000E-02
2.2591000E+03	1.2888000E-02	8.3729000E-01	1.0791000E-02	1.6598000E-02
2.2592000E+03	1.2519000E-02	8.3728000E-01	1.0482000E-02	1.6123000E-02
2.2593000E+03	1.2162000E-02	8.3728000E-01	1.0183000E-02	1.5662000E-02
2.2594000E+03	1.1815000E-02	8.3728000E-01	9.8928000E-03	1.5216000E-02
2.2595000E+03	1.1480000E-02	8.3728000E-01	9.6123000E-03	1.4785000E-02
2.2596000E+03	1.1157000E-02	8.3728000E-01	9.3415000E-03	1.4368000E-02
2.2597000E+03	1.0845000E-02	8.3727000E-01	9.0804000E-03	1.3967000E-02
2.2598000E+03	1.0545000E-02	8.3727000E-01	8.8294000E-03	1.3581000E-02
2.2599000E+03	1.0258000E-02	8.3727000E-01	8.5883000E-03	1.3210000E-02
2.2600000E+03	9.9818000E-03	8.3727000E-01	8.3574000E-03	1.2855000E-02
2.2601000E+03	9.7183000E-03	8.3729000E-01	8.1371000E-03	1.2516000E-02
2.2602000E+03	9.4672000E-03	8.3732000E-01	7.9270000E-03	1.2193000E-02
2.2603000E+03	9.2284000E-03	8.3734000E-01	7.7273000E-03	1.1886000E-02
2.2604000E+03	9.0021000E-03	8.3737000E-01	7.5380000E-03	1.1594000E-02
2.2605000E+03	8.7882000E-03	8.3736000E-01	7.3588000E-03	1.1319000E-02
2.2606000E+03	8.5866000E-03	8.3735000E-01	7.1900000E-03	1.1059000E-02
2.2607000E+03	8.3974000E-03	8.3734000E-01	7.0315000E-03	1.0815000E-02
2.2608000E+03	8.2204000E-03	8.3733000E-01	6.8832000E-03	1.0587000E-02
2.2609000E+03	8.0554000E-03	8.3732000E-01	6.7450000E-03	1.0375000E-02
2.2610000E+03	7.9023000E-03	8.3731000E-01	6.6167000E-03	1.0177000E-02
2.2611000E+03	7.7609000E-03	8.3730000E-01	6.4982000E-03	9.9951000E-03
2.2612000E+03	7.6308000E-03	8.3729000E-01	6.3892000E-03	9.8275000E-03
2.2613000E+03	7.5119000E-03	8.3728000E-01	6.2896000E-03	9.6742000E-03
2.2614000E+03	7.4037000E-03	8.3728000E-01	6.1990000E-03	9.5348000E-03
2.2615000E+03	7.3060000E-03	8.3727000E-01	6.1171000E-03	9.4089000E-03
2.2616000E+03	7.2183000E-03	8.3726000E-01	6.0436000E-03	9.2958000E-03
2.2617000E+03	7.1402000E-03	8.3725000E-01	5.9781000E-03	9.1951000E-03
2.2618000E+03	7.0712000E-03	8.3724000E-01	5.9202000E-03	9.1061000E-03
2.2619000E+03	7.0108000E-03	8.3723000E-01	5.8697000E-03	9.0283000E-03
2.2620000E+03	6.9585000E-03	8.3722000E-01	5.8258000E-03	8.9609000E-03
2.2621000E+03	6.9139000E-03	8.3720000E-01	5.7884000E-03	8.9032000E-03
2.2622000E+03	6.8763000E-03	8.3719000E-01	5.7568000E-03	8.8546000E-03
2.2623000E+03	6.8452000E-03	8.3717000E-01	5.7306000E-03	8.8144000E-03
2.2624000E+03	6.8200000E-03	8.3715000E-01	5.7094000E-03	8.7817000E-03
2.2625000E+03	6.8001000E-03	8.3713000E-01	5.6926000E-03	8.7559000E-03

2.2626000E+03	6.7848000E-03	8.3712000E-01	5.6797000E-03	8.7361000E-03
2.2627000E+03	6.7738000E-03	8.3710000E-01	5.6703000E-03	8.7217000E-03
2.2628000E+03	6.7661000E-03	8.3708000E-01	5.6638000E-03	8.7117000E-03
2.2629000E+03	6.7615000E-03	8.3707000E-01	5.6598000E-03	8.7055000E-03
2.2630000E+03	6.7591000E-03	8.3705000E-01	5.6577000E-03	8.7023000E-03
2.2631000E+03	6.7585000E-03	8.3703000E-01	5.6571000E-03	8.7013000E-03
2.2632000E+03	6.7590000E-03	8.3701000E-01	5.6574000E-03	8.7018000E-03
2.2633000E+03	6.7602000E-03	8.3699000E-01	5.6582000E-03	8.7031000E-03
2.2634000E+03	6.7614000E-03	8.3697000E-01	5.6591000E-03	8.7045000E-03
2.2635000E+03	6.7622000E-03	8.3696000E-01	5.6597000E-03	8.7053000E-03
2.2636000E+03	6.7621000E-03	8.3694000E-01	5.6594000E-03	8.7050000E-03
2.2637000E+03	6.7606000E-03	8.3692000E-01	5.6581000E-03	8.7028000E-03
2.2638000E+03	6.7573000E-03	8.3690000E-01	5.6552000E-03	8.6984000E-03
2.2639000E+03	6.7517000E-03	8.3688000E-01	5.6504000E-03	8.6910000E-03
2.2640000E+03	6.7435000E-03	8.3686000E-01	5.6434000E-03	8.6803000E-03
2.2641000E+03	6.7324000E-03	8.3685000E-01	5.6340000E-03	8.6659000E-03
2.2642000E+03	6.7181000E-03	8.3684000E-01	5.6219000E-03	8.6472000E-03
2.2643000E+03	6.7002000E-03	8.3682000E-01	5.6069000E-03	8.6241000E-03
2.2644000E+03	6.6786000E-03	8.3681000E-01	5.5887000E-03	8.5961000E-03
2.2645000E+03	6.6530000E-03	8.3679000E-01	5.5672000E-03	8.5630000E-03
2.2646000E+03	6.6233000E-03	8.3678000E-01	5.5422000E-03	8.5246000E-03
2.2647000E+03	6.5893000E-03	8.3677000E-01	5.5137000E-03	8.4808000E-03
2.2648000E+03	6.5511000E-03	8.3675000E-01	5.4816000E-03	8.4315000E-03
2.2649000E+03	6.5085000E-03	8.3674000E-01	5.4459000E-03	8.3765000E-03
2.2650000E+03	6.4615000E-03	8.3673000E-01	5.4065000E-03	8.3160000E-03
2.2651000E+03	6.4103000E-03	8.3671000E-01	5.3635000E-03	8.2498000E-03
2.2652000E+03	6.3547000E-03	8.3670000E-01	5.3170000E-03	8.1782000E-03
2.2653000E+03	6.2950000E-03	8.3669000E-01	5.2670000E-03	8.1013000E-03
2.2654000E+03	6.2313000E-03	8.3667000E-01	5.2135000E-03	8.0190000E-03
2.2655000E+03	6.1637000E-03	8.3664000E-01	5.1568000E-03	7.9318000E-03
2.2656000E+03	6.0924000E-03	8.3661000E-01	5.0970000E-03	7.8398000E-03
2.2657000E+03	6.0177000E-03	8.3659000E-01	5.0344000E-03	7.7435000E-03
2.2658000E+03	5.9399000E-03	8.3656000E-01	4.9691000E-03	7.6431000E-03
2.2659000E+03	5.8591000E-03	8.3653000E-01	4.9013000E-03	7.5389000E-03
2.2660000E+03	5.7757000E-03	8.3651000E-01	4.8314000E-03	7.4314000E-03
2.2661000E+03	5.6900000E-03	8.3648000E-01	4.7596000E-03	7.3208000E-03
2.2662000E+03	5.6024000E-03	8.3644000E-01	4.6861000E-03	7.2078000E-03
2.2663000E+03	5.5132000E-03	8.3641000E-01	4.6113000E-03	7.0927000E-03
2.2664000E+03	5.4227000E-03	8.3638000E-01	4.5354000E-03	6.9760000E-03
2.2665000E+03	5.3313000E-03	8.3634000E-01	4.4588000E-03	6.8582000E-03
2.2666000E+03	5.2395000E-03	8.3631000E-01	4.3818000E-03	6.7398000E-03
2.2667000E+03	5.1475000E-03	8.3628000E-01	4.3047000E-03	6.6212000E-03
2.2668000E+03	5.0557000E-03	8.3624000E-01	4.2278000E-03	6.5029000E-03

2.2669000E+03	4.9646000E-03	8.3621000E-01	4.1515000E-03	6.3855000E-03
2.2670000E+03	4.8745000E-03	8.3618000E-01	4.0760000E-03	6.2693000E-03
2.2671000E+03	4.7858000E-03	8.3615000E-01	4.0016000E-03	6.1550000E-03
2.2672000E+03	4.6987000E-03	8.3612000E-01	3.9287000E-03	6.0429000E-03
2.2673000E+03	4.6138000E-03	8.3609000E-01	3.8575000E-03	5.9334000E-03
2.2674000E+03	4.5312000E-03	8.3607000E-01	3.7884000E-03	5.8270000E-03
2.2675000E+03	4.4513000E-03	8.3604000E-01	3.7214000E-03	5.7240000E-03
2.2676000E+03	4.3743000E-03	8.3601000E-01	3.6570000E-03	5.6249000E-03
2.2677000E+03	4.3006000E-03	8.3598000E-01	3.5952000E-03	5.5299000E-03
2.2678000E+03	4.2487000E-03	8.3596000E-01	3.5518000E-03	5.4631000E-03
2.2679000E+03	4.1832000E-03	8.3593000E-01	3.4968000E-03	5.3786000E-03
2.2680000E+03	4.1214000E-03	8.3590000E-01	3.4451000E-03	5.2990000E-03
2.2681000E+03	4.0635000E-03	8.3587000E-01	3.3966000E-03	5.2244000E-03
2.2682000E+03	0.0000000E+00	8.3584000E-01	0.0000000E+00	0.0000000E+00
Channel 16				
Wavenumber	HIRS Filter Transmittance	Optical Element Transmittance	Product of the HIRS Filter and Optical Element Transmittances	Normalized Value of Column 4
2.2149000E+03	0.0000000E+00	8.2973000E-01	0.0000000E+00	0.0000000E+00
2.2150000E+03	1.2338000E-03	8.2976000E-01	1.0238000E-03	1.5397000E-03
2.2151000E+03	1.3013000E-03	8.2979000E-01	1.0798000E-03	1.6240000E-03
2.2152000E+03	1.3679000E-03	8.2982000E-01	1.1352000E-03	1.7072000E-03
2.2153000E+03	1.4338000E-03	8.2986000E-01	1.1898000E-03	1.7895000E-03
2.2154000E+03	1.4990000E-03	8.2989000E-01	1.2440000E-03	1.8709000E-03
2.2155000E+03	1.5639000E-03	8.2992000E-01	1.2979000E-03	1.9520000E-03
2.2156000E+03	1.6287000E-03	8.2996000E-01	1.3518000E-03	2.0330000E-03
2.2157000E+03	1.6939000E-03	8.2999000E-01	1.4060000E-03	2.1145000E-03
2.2158000E+03	1.7599000E-03	8.3002000E-01	1.4608000E-03	2.1969000E-03
2.2159000E+03	1.8271000E-03	8.3005000E-01	1.5166000E-03	2.2808000E-03
2.2160000E+03	1.8958000E-03	8.3009000E-01	1.5737000E-03	2.3668000E-03
2.2161000E+03	1.9667000E-03	8.3010000E-01	1.6325000E-03	2.4552000E-03
2.2162000E+03	2.0399000E-03	8.3011000E-01	1.6933000E-03	2.5467000E-03
2.2163000E+03	2.1158000E-03	8.3012000E-01	1.7564000E-03	2.6415000E-03
2.2164000E+03	2.1947000E-03	8.3013000E-01	1.8219000E-03	2.7400000E-03
2.2165000E+03	2.2766000E-03	8.3014000E-01	1.8899000E-03	2.8424000E-03
2.2166000E+03	2.3619000E-03	8.3016000E-01	1.9607000E-03	2.9488000E-03
2.2167000E+03	2.4503000E-03	8.3017000E-01	2.0341000E-03	3.0592000E-03
2.2168000E+03	2.5418000E-03	8.3018000E-01	2.1101000E-03	3.1735000E-03
2.2169000E+03	2.6362000E-03	8.3019000E-01	2.1886000E-03	3.2915000E-03
2.2170000E+03	2.7334000E-03	8.3020000E-01	2.2692000E-03	3.4128000E-03
2.2171000E+03	2.8328000E-03	8.3021000E-01	2.3518000E-03	3.5370000E-03
2.2172000E+03	2.9342000E-03	8.3021000E-01	2.4360000E-03	3.6636000E-03

2.2173000E+03	3.0370000E-03	8.3022000E-01	2.5213000E-03	3.7919000E-03
2.2174000E+03	3.1406000E-03	8.3023000E-01	2.6075000E-03	3.9214000E-03
2.2175000E+03	3.2447000E-03	8.3024000E-01	2.6938000E-03	4.0513000E-03
2.2176000E+03	3.3484000E-03	8.3024000E-01	2.7800000E-03	4.1809000E-03
2.2177000E+03	3.4512000E-03	8.3025000E-01	2.8654000E-03	4.3093000E-03
2.2178000E+03	3.5525000E-03	8.3026000E-01	2.9494000E-03	4.4358000E-03
2.2179000E+03	3.6515000E-03	8.3026000E-01	3.0317000E-03	4.5595000E-03
2.2180000E+03	3.7478000E-03	8.3027000E-01	3.1117000E-03	4.6797000E-03
2.2181000E+03	3.8406000E-03	8.3027000E-01	3.1887000E-03	4.7956000E-03
2.2182000E+03	3.9293000E-03	8.3027000E-01	3.2624000E-03	4.9064000E-03
2.2183000E+03	4.0134000E-03	8.3027000E-01	3.3322000E-03	5.0115000E-03
2.2184000E+03	4.0924000E-03	8.3027000E-01	3.3978000E-03	5.1101000E-03
2.2185000E+03	4.1657000E-03	8.3027000E-01	3.4587000E-03	5.2017000E-03
2.2186000E+03	4.2330000E-03	8.3027000E-01	3.5145000E-03	5.2857000E-03
2.2187000E+03	4.2938000E-03	8.3027000E-01	3.5650000E-03	5.3616000E-03
2.2188000E+03	4.3478000E-03	8.3027000E-01	3.6099000E-03	5.4290000E-03
2.2189000E+03	4.3947000E-03	8.3027000E-01	3.6488000E-03	5.4876000E-03
2.2190000E+03	4.4344000E-03	8.3027000E-01	3.6818000E-03	5.5371000E-03
2.2191000E+03	4.4667000E-03	8.3027000E-01	3.7085000E-03	5.5774000E-03
2.2192000E+03	4.4915000E-03	8.3027000E-01	3.7291000E-03	5.6083000E-03
2.2193000E+03	4.5088000E-03	8.3026000E-01	3.7435000E-03	5.6300000E-03
2.2194000E+03	4.5188000E-03	8.3026000E-01	3.7518000E-03	5.6424000E-03
2.2195000E+03	4.5215000E-03	8.3026000E-01	3.7540000E-03	5.6458000E-03
2.2196000E+03	4.5173000E-03	8.3026000E-01	3.7506000E-03	5.6406000E-03
2.2197000E+03	4.5065000E-03	8.3025000E-01	3.7415000E-03	5.6270000E-03
2.2198000E+03	4.4894000E-03	8.3025000E-01	3.7274000E-03	5.6057000E-03
2.2199000E+03	4.4666000E-03	8.3025000E-01	3.7084000E-03	5.5772000E-03
2.2200000E+03	4.4386000E-03	8.3025000E-01	3.6851000E-03	5.5422000E-03
2.2201000E+03	4.4061000E-03	8.3029000E-01	3.6583000E-03	5.5019000E-03
2.2202000E+03	4.3697000E-03	8.3033000E-01	3.6283000E-03	5.4568000E-03
2.2203000E+03	4.3303000E-03	8.3038000E-01	3.5958000E-03	5.4078000E-03
2.2204000E+03	4.2888000E-03	8.3042000E-01	3.5615000E-03	5.3562000E-03
2.2205000E+03	4.2460000E-03	8.3046000E-01	3.5261000E-03	5.3031000E-03
2.2206000E+03	4.2029000E-03	8.3051000E-01	3.4905000E-03	5.2495000E-03
2.2207000E+03	4.1606000E-03	8.3055000E-01	3.4556000E-03	5.1970000E-03
2.2208000E+03	4.1201000E-03	8.3059000E-01	3.4221000E-03	5.1467000E-03
2.2209000E+03	4.0826000E-03	8.3064000E-01	3.3911000E-03	5.1001000E-03
2.2210000E+03	4.0491000E-03	8.3068000E-01	3.3635000E-03	5.0584000E-03
2.2211000E+03	4.0207000E-03	8.3072000E-01	3.3400000E-03	5.0232000E-03
2.2212000E+03	3.9985000E-03	8.3076000E-01	3.3218000E-03	4.9957000E-03
2.2213000E+03	3.9836000E-03	8.3079000E-01	3.3095000E-03	4.9773000E-03
2.2214000E+03	3.9769000E-03	8.3083000E-01	3.3042000E-03	4.9693000E-03
2.2215000E+03	3.9795000E-03	8.3087000E-01	3.3065000E-03	4.9727000E-03

2.2216000E+03	3.9922000E-03	8.3091000E-01	3.3171000E-03	4.9888000E-03
2.2217000E+03	4.0157000E-03	8.3095000E-01	3.3369000E-03	5.0184000E-03
2.2218000E+03	4.0509000E-03	8.3099000E-01	3.3662000E-03	5.0626000E-03
2.2219000E+03	4.0982000E-03	8.3103000E-01	3.4057000E-03	5.1220000E-03
2.2220000E+03	4.1583000E-03	8.3107000E-01	3.4558000E-03	5.1973000E-03
2.2221000E+03	4.2315000E-03	8.3108000E-01	3.5167000E-03	5.2889000E-03
2.2222000E+03	4.3182000E-03	8.3109000E-01	3.5888000E-03	5.3974000E-03
2.2223000E+03	4.4187000E-03	8.3111000E-01	3.6724000E-03	5.5231000E-03
2.2224000E+03	4.5333000E-03	8.3112000E-01	3.7677000E-03	5.6664000E-03
2.2225000E+03	4.6622000E-03	8.3113000E-01	3.8749000E-03	5.8276000E-03
2.2226000E+03	4.8054000E-03	8.3115000E-01	3.9939000E-03	6.0066000E-03
2.2227000E+03	4.9630000E-03	8.3116000E-01	4.1251000E-03	6.2038000E-03
2.2228000E+03	5.1353000E-03	8.3117000E-01	4.2683000E-03	6.4192000E-03
2.2229000E+03	5.3222000E-03	8.3119000E-01	4.4237000E-03	6.6530000E-03
2.2230000E+03	5.5238000E-03	8.3120000E-01	4.5914000E-03	6.9052000E-03
2.2231000E+03	5.7403000E-03	8.3121000E-01	4.7714000E-03	7.1758000E-03
2.2232000E+03	5.9715000E-03	8.3123000E-01	4.9637000E-03	7.4651000E-03
2.2233000E+03	6.2177000E-03	8.3124000E-01	5.1684000E-03	7.7729000E-03
2.2234000E+03	6.4788000E-03	8.3125000E-01	5.3855000E-03	8.0994000E-03
2.2235000E+03	6.7548000E-03	8.3127000E-01	5.6150000E-03	8.4446000E-03
2.2236000E+03	7.0456000E-03	8.3128000E-01	5.8569000E-03	8.8084000E-03
2.2237000E+03	7.3514000E-03	8.3129000E-01	6.1112000E-03	9.1908000E-03
2.2238000E+03	7.6719000E-03	8.3131000E-01	6.3777000E-03	9.5917000E-03
2.2239000E+03	8.0071000E-03	8.3132000E-01	6.6565000E-03	1.0011000E-02
2.2240000E+03	8.3569000E-03	8.3134000E-01	6.9474000E-03	1.0448000E-02
2.2241000E+03	8.7210000E-03	8.3134000E-01	7.2501000E-03	1.0904000E-02
2.2242000E+03	9.0992000E-03	8.3135000E-01	7.5647000E-03	1.1377000E-02
2.2243000E+03	9.4913000E-03	8.3136000E-01	7.8907000E-03	1.1867000E-02
2.2244000E+03	9.8971000E-03	8.3137000E-01	8.2281000E-03	1.2375000E-02
2.2245000E+03	1.0316000E-02	8.3138000E-01	8.5766000E-03	1.2899000E-02
2.2246000E+03	1.0748000E-02	8.3139000E-01	8.9359000E-03	1.3439000E-02
2.2247000E+03	1.1193000E-02	8.3140000E-01	9.3056000E-03	1.3995000E-02
2.2248000E+03	1.1649000E-02	8.3141000E-01	9.6855000E-03	1.4566000E-02
2.2249000E+03	1.2118000E-02	8.3142000E-01	1.0075000E-02	1.5153000E-02
2.2250000E+03	1.2599000E-02	8.3143000E-01	1.0475000E-02	1.5754000E-02
2.2251000E+03	1.3090000E-02	8.3145000E-01	1.0884000E-02	1.6369000E-02
2.2252000E+03	1.3593000E-02	8.3146000E-01	1.1302000E-02	1.6997000E-02
2.2253000E+03	1.4106000E-02	8.3148000E-01	1.1729000E-02	1.7639000E-02
2.2254000E+03	1.4629000E-02	8.3150000E-01	1.2164000E-02	1.8294000E-02
2.2255000E+03	1.5163000E-02	8.3151000E-01	1.2609000E-02	1.8962000E-02
2.2256000E+03	1.5708000E-02	8.3153000E-01	1.3061000E-02	1.9643000E-02
2.2257000E+03	1.6262000E-02	8.3154000E-01	1.3522000E-02	2.0337000E-02
2.2258000E+03	1.6826000E-02	8.3156000E-01	1.3992000E-02	2.1043000E-02

2.2259000E+03	1.7402000E-02	8.3158000E-01	1.4471000E-02	2.1763000E-02
2.2260000E+03	1.7988000E-02	8.3159000E-01	1.4958000E-02	2.2496000E-02
2.2261000E+03	1.8585000E-02	8.3159000E-01	1.5455000E-02	2.3243000E-02
2.2262000E+03	1.9194000E-02	8.3159000E-01	1.5961000E-02	2.4005000E-02
2.2263000E+03	1.9815000E-02	8.3158000E-01	1.6478000E-02	2.4782000E-02
2.2264000E+03	2.0450000E-02	8.3158000E-01	1.7006000E-02	2.5575000E-02
2.2265000E+03	2.1099000E-02	8.3158000E-01	1.7546000E-02	2.6387000E-02
2.2266000E+03	2.1764000E-02	8.3157000E-01	1.8098000E-02	2.7219000E-02
2.2267000E+03	2.2446000E-02	8.3157000E-01	1.8665000E-02	2.8071000E-02
2.2268000E+03	2.3146000E-02	8.3157000E-01	1.9247000E-02	2.8947000E-02
2.2269000E+03	2.3866000E-02	8.3156000E-01	1.9846000E-02	2.9848000E-02
2.2270000E+03	2.4609000E-02	8.3156000E-01	2.0464000E-02	3.0776000E-02
2.2271000E+03	2.5376000E-02	8.3156000E-01	2.1101000E-02	3.1735000E-02
2.2272000E+03	2.6169000E-02	8.3155000E-01	2.1761000E-02	3.2728000E-02
2.2273000E+03	2.6992000E-02	8.3155000E-01	2.2445000E-02	3.3756000E-02
2.2274000E+03	2.7847000E-02	8.3154000E-01	2.3156000E-02	3.4825000E-02
2.2275000E+03	2.8736000E-02	8.3154000E-01	2.3895000E-02	3.5937000E-02
2.2276000E+03	2.9663000E-02	8.3153000E-01	2.4666000E-02	3.7096000E-02
2.2277000E+03	3.0632000E-02	8.3153000E-01	2.5471000E-02	3.8307000E-02
2.2278000E+03	3.1406000E-02	8.3152000E-01	2.6115000E-02	3.9275000E-02
2.2279000E+03	3.2448000E-02	8.3152000E-01	2.6981000E-02	4.0578000E-02
2.2280000E+03	3.3542000E-02	8.3151000E-01	2.7890000E-02	4.1946000E-02
2.2281000E+03	3.4691000E-02	8.3152000E-01	2.8846000E-02	4.3383000E-02
2.2282000E+03	3.5900000E-02	8.3152000E-01	2.9851000E-02	4.4895000E-02
2.2283000E+03	3.7173000E-02	8.3153000E-01	3.0910000E-02	4.6487000E-02
2.2284000E+03	3.8514000E-02	8.3153000E-01	3.2026000E-02	4.8165000E-02
2.2285000E+03	3.9929000E-02	8.3154000E-01	3.3203000E-02	4.9935000E-02
2.2286000E+03	4.1423000E-02	8.3154000E-01	3.4445000E-02	5.1802000E-02
2.2287000E+03	4.2999000E-02	8.3155000E-01	3.5756000E-02	5.3774000E-02
2.2288000E+03	4.4664000E-02	8.3155000E-01	3.7140000E-02	5.5856000E-02
2.2289000E+03	4.6422000E-02	8.3156000E-01	3.8602000E-02	5.8055000E-02
2.2290000E+03	4.8278000E-02	8.3156000E-01	4.0146000E-02	6.0377000E-02
2.2291000E+03	5.0238000E-02	8.3156000E-01	4.1776000E-02	6.2828000E-02
2.2292000E+03	5.2307000E-02	8.3156000E-01	4.3496000E-02	6.5416000E-02
2.2293000E+03	5.4490000E-02	8.3156000E-01	4.5312000E-02	6.8146000E-02
2.2294000E+03	5.6792000E-02	8.3156000E-01	4.7226000E-02	7.1026000E-02
2.2295000E+03	5.9220000E-02	8.3156000E-01	4.9245000E-02	7.4061000E-02
2.2296000E+03	6.1777000E-02	8.3156000E-01	5.1371000E-02	7.7259000E-02
2.2297000E+03	6.4469000E-02	8.3156000E-01	5.3610000E-02	8.0626000E-02
2.2298000E+03	6.7301000E-02	8.3156000E-01	5.5965000E-02	8.4167000E-02
2.2299000E+03	7.0279000E-02	8.3155000E-01	5.8440000E-02	8.7891000E-02
2.2300000E+03	7.3406000E-02	8.3155000E-01	6.1041000E-02	9.1801000E-02
2.2301000E+03	7.6688000E-02	8.3159000E-01	6.3773000E-02	9.5911000E-02

2.2302000E+03	8.0130000E-02	8.3163000E-01	6.6638000E-02	1.0022000E-01
2.2303000E+03	8.3735000E-02	8.3167000E-01	6.9639000E-02	1.0473000E-01
2.2304000E+03	8.7508000E-02	8.3170000E-01	7.2780000E-02	1.0946000E-01
2.2305000E+03	9.1452000E-02	8.3174000E-01	7.6065000E-02	1.1440000E-01
2.2306000E+03	9.5573000E-02	8.3178000E-01	7.9495000E-02	1.1956000E-01
2.2307000E+03	9.9872000E-02	8.3182000E-01	8.3075000E-02	1.2494000E-01
2.2308000E+03	1.0435000E-01	8.3186000E-01	8.6807000E-02	1.3055000E-01
2.2309000E+03	1.0902000E-01	8.3190000E-01	9.0694000E-02	1.3640000E-01
2.2310000E+03	1.1387000E-01	8.3194000E-01	9.4736000E-02	1.4248000E-01
2.2311000E+03	1.1892000E-01	8.3198000E-01	9.8938000E-02	1.4880000E-01
2.2312000E+03	1.2415000E-01	8.3201000E-01	1.0330000E-01	1.5535000E-01
2.2313000E+03	1.2958000E-01	8.3205000E-01	1.0782000E-01	1.6216000E-01
2.2314000E+03	1.3521000E-01	8.3209000E-01	1.1251000E-01	1.6920000E-01
2.2315000E+03	1.4103000E-01	8.3213000E-01	1.1735000E-01	1.7649000E-01
2.2316000E+03	1.4704000E-01	8.3217000E-01	1.2236000E-01	1.8403000E-01
2.2317000E+03	1.5325000E-01	8.3221000E-01	1.2754000E-01	1.9181000E-01
2.2318000E+03	1.5966000E-01	8.3224000E-01	1.3288000E-01	1.9984000E-01
2.2319000E+03	1.6626000E-01	8.3228000E-01	1.3838000E-01	2.0811000E-01
2.2320000E+03	1.7305000E-01	8.3232000E-01	1.4404000E-01	2.1662000E-01
2.2321000E+03	1.8004000E-01	8.3235000E-01	1.4985000E-01	2.2537000E-01
2.2322000E+03	1.8721000E-01	8.3239000E-01	1.5583000E-01	2.3436000E-01
2.2323000E+03	1.9457000E-01	8.3242000E-01	1.6196000E-01	2.4358000E-01
2.2324000E+03	2.0211000E-01	8.3245000E-01	1.6825000E-01	2.5303000E-01
2.2325000E+03	2.0983000E-01	8.3248000E-01	1.7468000E-01	2.6271000E-01
2.2326000E+03	2.1773000E-01	8.3252000E-01	1.8126000E-01	2.7261000E-01
2.2327000E+03	2.2579000E-01	8.3255000E-01	1.8798000E-01	2.8272000E-01
2.2328000E+03	2.3403000E-01	8.3258000E-01	1.9485000E-01	2.9304000E-01
2.2329000E+03	2.4242000E-01	8.3261000E-01	2.0184000E-01	3.0356000E-01
2.2330000E+03	2.5096000E-01	8.3265000E-01	2.0897000E-01	3.1427000E-01
2.2331000E+03	2.5966000E-01	8.3268000E-01	2.1621000E-01	3.2517000E-01
2.2332000E+03	2.6849000E-01	8.3272000E-01	2.2358000E-01	3.3625000E-01
2.2333000E+03	2.7746000E-01	8.3275000E-01	2.3106000E-01	3.4750000E-01
2.2334000E+03	2.8656000E-01	8.3279000E-01	2.3864000E-01	3.5890000E-01
2.2335000E+03	2.9577000E-01	8.3282000E-01	2.4633000E-01	3.7046000E-01
2.2336000E+03	3.0510000E-01	8.3286000E-01	2.5410000E-01	3.8216000E-01
2.2337000E+03	3.1453000E-01	8.3289000E-01	2.6197000E-01	3.9398000E-01
2.2338000E+03	3.2405000E-01	8.3293000E-01	2.6991000E-01	4.0592000E-01
2.2339000E+03	3.3365000E-01	8.3296000E-01	2.7792000E-01	4.1797000E-01
2.2340000E+03	3.4333000E-01	8.3300000E-01	2.8599000E-01	4.3011000E-01
2.2341000E+03	3.5307000E-01	8.3302000E-01	2.9412000E-01	4.4233000E-01
2.2342000E+03	3.6287000E-01	8.3304000E-01	3.0229000E-01	4.5462000E-01
2.2343000E+03	3.7272000E-01	8.3307000E-01	3.1050000E-01	4.6697000E-01
2.2344000E+03	3.8260000E-01	8.3309000E-01	3.1874000E-01	4.7936000E-01

2.2345000E+03	3.9250000E-01	8.3311000E-01	3.2699000E-01	4.9178000E-01
2.2346000E+03	4.0242000E-01	8.3313000E-01	3.3527000E-01	5.0422000E-01
2.2347000E+03	4.1234000E-01	8.3316000E-01	3.4354000E-01	5.1666000E-01
2.2348000E+03	4.2225000E-01	8.3318000E-01	3.5181000E-01	5.2910000E-01
2.2349000E+03	4.3215000E-01	8.3320000E-01	3.6007000E-01	5.4152000E-01
2.2350000E+03	4.4202000E-01	8.3323000E-01	3.6830000E-01	5.5390000E-01
2.2351000E+03	4.5185000E-01	8.3325000E-01	3.7650000E-01	5.6623000E-01
2.2352000E+03	4.6163000E-01	8.3327000E-01	3.8466000E-01	5.7850000E-01
2.2353000E+03	4.7135000E-01	8.3329000E-01	3.9277000E-01	5.9070000E-01
2.2354000E+03	4.8100000E-01	8.3331000E-01	4.0082000E-01	6.0281000E-01
2.2355000E+03	4.9057000E-01	8.3332000E-01	4.0880000E-01	6.1482000E-01
2.2356000E+03	5.0005000E-01	8.3334000E-01	4.1672000E-01	6.2671000E-01
2.2357000E+03	5.0943000E-01	8.3336000E-01	4.2454000E-01	6.3849000E-01
2.2358000E+03	5.1871000E-01	8.3338000E-01	4.3228000E-01	6.5012000E-01
2.2359000E+03	5.2786000E-01	8.3340000E-01	4.3992000E-01	6.6161000E-01
2.2360000E+03	5.3689000E-01	8.3342000E-01	4.4746000E-01	6.7295000E-01
2.2361000E+03	5.4578000E-01	8.3345000E-01	4.5488000E-01	6.8412000E-01
2.2362000E+03	5.5453000E-01	8.3348000E-01	4.6219000E-01	6.9511000E-01
2.2363000E+03	5.6313000E-01	8.3352000E-01	4.6938000E-01	7.0591000E-01
2.2364000E+03	5.7156000E-01	8.3355000E-01	4.7642000E-01	7.1651000E-01
2.2365000E+03	5.7983000E-01	8.3358000E-01	4.8334000E-01	7.2691000E-01
2.2366000E+03	5.8793000E-01	8.3361000E-01	4.9010000E-01	7.3708000E-01
2.2367000E+03	5.9585000E-01	8.3364000E-01	4.9672000E-01	7.4704000E-01
2.2368000E+03	6.0358000E-01	8.3367000E-01	5.0318000E-01	7.5676000E-01
2.2369000E+03	6.1112000E-01	8.3370000E-01	5.0949000E-01	7.6624000E-01
2.2370000E+03	6.1846000E-01	8.3373000E-01	5.1563000E-01	7.7548000E-01
2.2371000E+03	6.2560000E-01	8.3376000E-01	5.2160000E-01	7.8445000E-01
2.2372000E+03	6.3254000E-01	8.3378000E-01	5.2740000E-01	7.9318000E-01
2.2373000E+03	6.3927000E-01	8.3380000E-01	5.3303000E-01	8.0164000E-01
2.2374000E+03	6.4579000E-01	8.3383000E-01	5.3848000E-01	8.0984000E-01
2.2375000E+03	6.5210000E-01	8.3385000E-01	5.4375000E-01	8.1777000E-01
2.2376000E+03	6.5819000E-01	8.3387000E-01	5.4885000E-01	8.2543000E-01
2.2377000E+03	6.6406000E-01	8.3389000E-01	5.5376000E-01	8.3282000E-01
2.2378000E+03	6.6972000E-01	8.3392000E-01	5.5849000E-01	8.3993000E-01
2.2379000E+03	6.7516000E-01	8.3394000E-01	5.6304000E-01	8.4678000E-01
2.2380000E+03	6.8038000E-01	8.3396000E-01	5.6741000E-01	8.5335000E-01
2.2381000E+03	6.8538000E-01	8.3395000E-01	5.7157000E-01	8.5961000E-01
2.2382000E+03	6.9016000E-01	8.3394000E-01	5.7556000E-01	8.6560000E-01
2.2383000E+03	6.9473000E-01	8.3393000E-01	5.7936000E-01	8.7132000E-01
2.2384000E+03	6.9909000E-01	8.3392000E-01	5.8298000E-01	8.7677000E-01
2.2385000E+03	7.0323000E-01	8.3391000E-01	5.8643000E-01	8.8196000E-01
2.2386000E+03	7.0717000E-01	8.3390000E-01	5.8971000E-01	8.8688000E-01
2.2387000E+03	7.1090000E-01	8.3389000E-01	5.9281000E-01	8.9155000E-01

2.2388000E+03	7.1443000E-01	8.3388000E-01	5.9574000E-01	8.9596000E-01
2.2389000E+03	7.1776000E-01	8.3387000E-01	5.9851000E-01	9.0013000E-01
2.2390000E+03	7.2089000E-01	8.3386000E-01	6.0112000E-01	9.0405000E-01
2.2391000E+03	7.2384000E-01	8.3385000E-01	6.0358000E-01	9.0774000E-01
2.2392000E+03	7.2661000E-01	8.3384000E-01	6.0588000E-01	9.1120000E-01
2.2393000E+03	7.2919000E-01	8.3384000E-01	6.0803000E-01	9.1443000E-01
2.2394000E+03	7.3160000E-01	8.3383000E-01	6.1003000E-01	9.1745000E-01
2.2395000E+03	7.3385000E-01	8.3382000E-01	6.1190000E-01	9.2026000E-01
2.2396000E+03	7.3593000E-01	8.3382000E-01	6.1363000E-01	9.2286000E-01
2.2397000E+03	7.3786000E-01	8.3381000E-01	6.1524000E-01	9.2527000E-01
2.2398000E+03	7.3964000E-01	8.3380000E-01	6.1672000E-01	9.2750000E-01
2.2399000E+03	7.4128000E-01	8.3379000E-01	6.1808000E-01	9.2955000E-01
2.2400000E+03	7.4278000E-01	8.3379000E-01	6.1932000E-01	9.3142000E-01
2.2401000E+03	7.4416000E-01	8.3379000E-01	6.2047000E-01	9.3315000E-01
2.2402000E+03	7.4541000E-01	8.3379000E-01	6.2152000E-01	9.3472000E-01
2.2403000E+03	7.4655000E-01	8.3379000E-01	6.2246000E-01	9.3615000E-01
2.2404000E+03	7.4758000E-01	8.3379000E-01	6.2332000E-01	9.3744000E-01
2.2405000E+03	7.4851000E-01	8.3379000E-01	6.2410000E-01	9.3860000E-01
2.2406000E+03	7.4934000E-01	8.3379000E-01	6.2480000E-01	9.3965000E-01
2.2407000E+03	7.5009000E-01	8.3380000E-01	6.2542000E-01	9.4059000E-01
2.2408000E+03	7.5076000E-01	8.3380000E-01	6.2598000E-01	9.4143000E-01
2.2409000E+03	7.5135000E-01	8.3380000E-01	6.2647000E-01	9.4218000E-01
2.2410000E+03	7.5188000E-01	8.3380000E-01	6.2692000E-01	9.4284000E-01
2.2411000E+03	7.5235000E-01	8.3380000E-01	6.2731000E-01	9.4343000E-01
2.2412000E+03	7.5276000E-01	8.3381000E-01	6.2766000E-01	9.4396000E-01
2.2413000E+03	7.5313000E-01	8.3381000E-01	6.2797000E-01	9.4442000E-01
2.2414000E+03	7.5345000E-01	8.3382000E-01	6.2824000E-01	9.4484000E-01
2.2415000E+03	7.5375000E-01	8.3382000E-01	6.2849000E-01	9.4521000E-01
2.2416000E+03	7.5401000E-01	8.3383000E-01	6.2871000E-01	9.4554000E-01
2.2417000E+03	7.5424000E-01	8.3383000E-01	6.2891000E-01	9.4584000E-01
2.2418000E+03	7.5446000E-01	8.3383000E-01	6.2910000E-01	9.4612000E-01
2.2419000E+03	7.5467000E-01	8.3384000E-01	6.2927000E-01	9.4639000E-01
2.2420000E+03	7.5487000E-01	8.3384000E-01	6.2944000E-01	9.4664000E-01
2.2421000E+03	7.5506000E-01	8.3388000E-01	6.2963000E-01	9.4692000E-01
2.2422000E+03	7.5525000E-01	8.3391000E-01	6.2981000E-01	9.4720000E-01
2.2423000E+03	7.5545000E-01	8.3394000E-01	6.3000000E-01	9.4748000E-01
2.2424000E+03	7.5565000E-01	8.3398000E-01	6.3020000E-01	9.4778000E-01
2.2425000E+03	7.5587000E-01	8.3401000E-01	6.3041000E-01	9.4809000E-01
2.2426000E+03	7.5611000E-01	8.3405000E-01	6.3063000E-01	9.4842000E-01
2.2427000E+03	7.5635000E-01	8.3408000E-01	6.3086000E-01	9.4877000E-01
2.2428000E+03	7.5663000E-01	8.3411000E-01	6.3111000E-01	9.4915000E-01
2.2429000E+03	7.5692000E-01	8.3415000E-01	6.3138000E-01	9.4956000E-01
2.2430000E+03	7.5724000E-01	8.3418000E-01	6.3167000E-01	9.5000000E-01

2.2431000E+03	7.5758000E-01	8.3421000E-01	6.3199000E-01	9.5047000E-01
2.2432000E+03	7.5796000E-01	8.3425000E-01	6.3233000E-01	9.5098000E-01
2.2433000E+03	7.5836000E-01	8.3428000E-01	6.3269000E-01	9.5152000E-01
2.2434000E+03	7.5880000E-01	8.3432000E-01	6.3308000E-01	9.5211000E-01
2.2435000E+03	7.5927000E-01	8.3435000E-01	6.3350000E-01	9.5274000E-01
2.2436000E+03	7.5977000E-01	8.3439000E-01	6.3394000E-01	9.5340000E-01
2.2437000E+03	7.6030000E-01	8.3442000E-01	6.3441000E-01	9.5411000E-01
2.2438000E+03	7.6086000E-01	8.3445000E-01	6.3491000E-01	9.5486000E-01
2.2439000E+03	7.6146000E-01	8.3449000E-01	6.3543000E-01	9.5565000E-01
2.2440000E+03	7.6209000E-01	8.3452000E-01	6.3598000E-01	9.5648000E-01
2.2441000E+03	7.6276000E-01	8.3454000E-01	6.3655000E-01	9.5733000E-01
2.2442000E+03	7.6345000E-01	8.3456000E-01	6.3714000E-01	9.5822000E-01
2.2443000E+03	7.6418000E-01	8.3457000E-01	6.3776000E-01	9.5915000E-01
2.2444000E+03	7.6493000E-01	8.3459000E-01	6.3841000E-01	9.6012000E-01
2.2445000E+03	7.6571000E-01	8.3461000E-01	6.3907000E-01	9.6112000E-01
2.2446000E+03	7.6652000E-01	8.3463000E-01	6.3976000E-01	9.6216000E-01
2.2447000E+03	7.6736000E-01	8.3464000E-01	6.4047000E-01	9.6323000E-01
2.2448000E+03	7.6822000E-01	8.3466000E-01	6.4120000E-01	9.6432000E-01
2.2449000E+03	7.6910000E-01	8.3468000E-01	6.4195000E-01	9.6545000E-01
2.2450000E+03	7.7000000E-01	8.3470000E-01	6.4271000E-01	9.6660000E-01
2.2451000E+03	7.7092000E-01	8.3471000E-01	6.4349000E-01	9.6777000E-01
2.2452000E+03	7.7185000E-01	8.3473000E-01	6.4428000E-01	9.6896000E-01
2.2453000E+03	7.7280000E-01	8.3474000E-01	6.4509000E-01	9.7017000E-01
2.2454000E+03	7.7376000E-01	8.3477000E-01	6.4591000E-01	9.7141000E-01
2.2455000E+03	7.7473000E-01	8.3481000E-01	6.4675000E-01	9.7267000E-01
2.2456000E+03	7.7571000E-01	8.3484000E-01	6.4760000E-01	9.7394000E-01
2.2457000E+03	7.7669000E-01	8.3488000E-01	6.4844000E-01	9.7522000E-01
2.2458000E+03	7.7768000E-01	8.3492000E-01	6.4930000E-01	9.7650000E-01
2.2459000E+03	7.7866000E-01	8.3495000E-01	6.5015000E-01	9.7778000E-01
2.2460000E+03	7.7965000E-01	8.3499000E-01	6.5099000E-01	9.7905000E-01
2.2461000E+03	7.8062000E-01	8.3502000E-01	6.5184000E-01	9.8032000E-01
2.2462000E+03	7.8159000E-01	8.3505000E-01	6.5267000E-01	9.8157000E-01
2.2463000E+03	7.8255000E-01	8.3508000E-01	6.5350000E-01	9.8282000E-01
2.2464000E+03	7.8350000E-01	8.3511000E-01	6.5431000E-01	9.8404000E-01
2.2465000E+03	7.8443000E-01	8.3514000E-01	6.5511000E-01	9.8525000E-01
2.2466000E+03	7.8535000E-01	8.3517000E-01	6.5590000E-01	9.8643000E-01
2.2467000E+03	7.8624000E-01	8.3521000E-01	6.5667000E-01	9.8759000E-01
2.2468000E+03	7.8711000E-01	8.3524000E-01	6.5742000E-01	9.8872000E-01
2.2469000E+03	7.8795000E-01	8.3527000E-01	6.5815000E-01	9.8982000E-01
2.2470000E+03	7.8877000E-01	8.3530000E-01	6.5886000E-01	9.9088000E-01
2.2471000E+03	7.8956000E-01	8.3532000E-01	6.5953000E-01	9.9190000E-01
2.2472000E+03	7.9031000E-01	8.3534000E-01	6.6018000E-01	9.9287000E-01
2.2473000E+03	7.9103000E-01	8.3537000E-01	6.6080000E-01	9.9380000E-01

2.2474000E+03	7.9170000E-01	8.3539000E-01	6.6138000E-01	9.9468000E-01
2.2475000E+03	7.9234000E-01	8.3541000E-01	6.6193000E-01	9.9550000E-01
2.2476000E+03	7.9293000E-01	8.3544000E-01	6.6244000E-01	9.9627000E-01
2.2477000E+03	7.9348000E-01	8.3546000E-01	6.6292000E-01	9.9699000E-01
2.2478000E+03	7.9397000E-01	8.3548000E-01	6.6335000E-01	9.9764000E-01
2.2479000E+03	7.9441000E-01	8.3551000E-01	6.6374000E-01	9.9822000E-01
2.2480000E+03	7.9480000E-01	8.3553000E-01	6.6408000E-01	9.9873000E-01
2.2481000E+03	7.9513000E-01	8.3553000E-01	6.6436000E-01	9.9915000E-01
2.2482000E+03	7.9540000E-01	8.3553000E-01	6.6458000E-01	9.9948000E-01
2.2483000E+03	7.9561000E-01	8.3553000E-01	6.6475000E-01	9.9974000E-01
2.2484000E+03	7.9575000E-01	8.3552000E-01	6.6486000E-01	9.9991000E-01
2.2485000E+03	7.9582000E-01	8.3552000E-01	6.6492000E-01	1.0000000E+00
2.2486000E+03	7.9581000E-01	8.3552000E-01	6.6492000E-01	1.0000000E+00
2.2487000E+03	7.9574000E-01	8.3552000E-01	6.6485000E-01	9.9990000E-01
2.2488000E+03	7.9558000E-01	8.3552000E-01	6.6472000E-01	9.9970000E-01
2.2489000E+03	7.9535000E-01	8.3551000E-01	6.6452000E-01	9.9940000E-01
2.2490000E+03	7.9503000E-01	8.3551000E-01	6.6426000E-01	9.9900000E-01
2.2491000E+03	7.9462000E-01	8.3551000E-01	6.6391000E-01	9.9848000E-01
2.2492000E+03	7.9412000E-01	8.3550000E-01	6.6349000E-01	9.9785000E-01
2.2493000E+03	7.9353000E-01	8.3550000E-01	6.6299000E-01	9.9710000E-01
2.2494000E+03	7.9284000E-01	8.3549000E-01	6.6241000E-01	9.9623000E-01
2.2495000E+03	7.9206000E-01	8.3549000E-01	6.6175000E-01	9.9523000E-01
2.2496000E+03	7.9116000E-01	8.3548000E-01	6.6100000E-01	9.9411000E-01
2.2497000E+03	7.9017000E-01	8.3548000E-01	6.6017000E-01	9.9285000E-01
2.2498000E+03	7.8906000E-01	8.3547000E-01	6.5924000E-01	9.9145000E-01
2.2499000E+03	7.8784000E-01	8.3547000E-01	6.5821000E-01	9.8991000E-01
2.2500000E+03	7.8650000E-01	8.3546000E-01	6.5709000E-01	9.8822000E-01
2.2501000E+03	7.8504000E-01	8.3549000E-01	6.5590000E-01	9.8642000E-01
2.2502000E+03	7.8346000E-01	8.3552000E-01	6.5460000E-01	9.8447000E-01
2.2503000E+03	7.8175000E-01	8.3555000E-01	6.5319000E-01	9.8236000E-01
2.2504000E+03	7.7992000E-01	8.3558000E-01	6.5168000E-01	9.8009000E-01
2.2505000E+03	7.7795000E-01	8.3561000E-01	6.5006000E-01	9.7765000E-01
2.2506000E+03	7.7584000E-01	8.3564000E-01	6.4832000E-01	9.7503000E-01
2.2507000E+03	7.7359000E-01	8.3567000E-01	6.4647000E-01	9.7225000E-01
2.2508000E+03	7.7121000E-01	8.3570000E-01	6.4449000E-01	9.6928000E-01
2.2509000E+03	7.6867000E-01	8.3572000E-01	6.4240000E-01	9.6613000E-01
2.2510000E+03	7.6599000E-01	8.3575000E-01	6.4018000E-01	9.6279000E-01
2.2511000E+03	7.6316000E-01	8.3578000E-01	6.3783000E-01	9.5926000E-01
2.2512000E+03	7.6017000E-01	8.3581000E-01	6.3536000E-01	9.5553000E-01
2.2513000E+03	7.5702000E-01	8.3584000E-01	6.3275000E-01	9.5161000E-01
2.2514000E+03	7.5372000E-01	8.3586000E-01	6.3001000E-01	9.4749000E-01
2.2515000E+03	7.5025000E-01	8.3589000E-01	6.2713000E-01	9.4316000E-01
2.2516000E+03	7.4662000E-01	8.3592000E-01	6.2411000E-01	9.3863000E-01

2.2517000E+03	7.4282000E-01	8.3595000E-01	6.2096000E-01	9.3388000E-01
2.2518000E+03	7.3886000E-01	8.3597000E-01	6.1767000E-01	9.2893000E-01
2.2519000E+03	7.3472000E-01	8.3600000E-01	6.1423000E-01	9.2376000E-01
2.2520000E+03	7.3042000E-01	8.3603000E-01	6.1065000E-01	9.1838000E-01
2.2521000E+03	7.2594000E-01	8.3606000E-01	6.0693000E-01	9.1278000E-01
2.2522000E+03	7.2128000E-01	8.3610000E-01	6.0306000E-01	9.0697000E-01
2.2523000E+03	7.1645000E-01	8.3613000E-01	5.9905000E-01	9.0093000E-01
2.2524000E+03	7.1145000E-01	8.3617000E-01	5.9489000E-01	8.9467000E-01
2.2525000E+03	7.0627000E-01	8.3620000E-01	5.9058000E-01	8.8819000E-01
2.2526000E+03	7.0091000E-01	8.3623000E-01	5.8612000E-01	8.8149000E-01
2.2527000E+03	6.9538000E-01	8.3627000E-01	5.8152000E-01	8.7457000E-01
2.2528000E+03	6.8967000E-01	8.3630000E-01	5.7677000E-01	8.6743000E-01
2.2529000E+03	6.8378000E-01	8.3634000E-01	5.7187000E-01	8.6006000E-01
2.2530000E+03	6.7772000E-01	8.3637000E-01	5.6683000E-01	8.5247000E-01
2.2531000E+03	6.7149000E-01	8.3641000E-01	5.6164000E-01	8.4467000E-01
2.2532000E+03	6.6509000E-01	8.3645000E-01	5.5631000E-01	8.3665000E-01
2.2533000E+03	6.5851000E-01	8.3648000E-01	5.5083000E-01	8.2842000E-01
2.2534000E+03	6.5177000E-01	8.3652000E-01	5.4522000E-01	8.1998000E-01
2.2535000E+03	6.4487000E-01	8.3655000E-01	5.3947000E-01	8.1132000E-01
2.2536000E+03	6.3780000E-01	8.3659000E-01	5.3358000E-01	8.0246000E-01
2.2537000E+03	6.3057000E-01	8.3663000E-01	5.2755000E-01	7.9341000E-01
2.2538000E+03	6.2319000E-01	8.3666000E-01	5.2140000E-01	7.8415000E-01
2.2539000E+03	6.1565000E-01	8.3670000E-01	5.1512000E-01	7.7470000E-01
2.2540000E+03	6.0797000E-01	8.3673000E-01	5.0871000E-01	7.6507000E-01
2.2541000E+03	6.0014000E-01	8.3677000E-01	5.0218000E-01	7.5524000E-01
2.2542000E+03	5.9218000E-01	8.3680000E-01	4.9553000E-01	7.4525000E-01
2.2543000E+03	5.8407000E-01	8.3683000E-01	4.8877000E-01	7.3508000E-01
2.2544000E+03	5.7584000E-01	8.3686000E-01	4.8190000E-01	7.2475000E-01
2.2545000E+03	5.6749000E-01	8.3689000E-01	4.7493000E-01	7.1426000E-01
2.2546000E+03	5.5902000E-01	8.3692000E-01	4.6785000E-01	7.0362000E-01
2.2547000E+03	5.5043000E-01	8.3695000E-01	4.6069000E-01	6.9284000E-01
2.2548000E+03	5.4174000E-01	8.3697000E-01	4.5342000E-01	6.8191000E-01
2.2549000E+03	5.3295000E-01	8.3698000E-01	4.4607000E-01	6.7086000E-01
2.2550000E+03	5.2407000E-01	8.3699000E-01	4.3864000E-01	6.5969000E-01
2.2551000E+03	5.1510000E-01	8.3701000E-01	4.3114000E-01	6.4841000E-01
2.2552000E+03	5.0606000E-01	8.3702000E-01	4.2358000E-01	6.3704000E-01
2.2553000E+03	4.9694000E-01	8.3704000E-01	4.1596000E-01	6.2557000E-01
2.2554000E+03	4.8776000E-01	8.3705000E-01	4.0828000E-01	6.1402000E-01
2.2555000E+03	4.7852000E-01	8.3707000E-01	4.0055000E-01	6.0240000E-01
2.2556000E+03	4.6923000E-01	8.3709000E-01	3.9279000E-01	5.9072000E-01
2.2557000E+03	4.5990000E-01	8.3710000E-01	3.8498000E-01	5.7899000E-01
2.2558000E+03	4.5054000E-01	8.3712000E-01	3.7715000E-01	5.6722000E-01
2.2559000E+03	4.4115000E-01	8.3713000E-01	3.6930000E-01	5.5541000E-01

2.2560000E+03	4.3175000E-01	8.3715000E-01	3.6144000E-01	5.4358000E-01
2.2561000E+03	4.2234000E-01	8.3716000E-01	3.5356000E-01	5.3174000E-01
2.2562000E+03	4.1293000E-01	8.3716000E-01	3.4569000E-01	5.1989000E-01
2.2563000E+03	4.0352000E-01	8.3717000E-01	3.3782000E-01	5.0805000E-01
2.2564000E+03	3.9413000E-01	8.3718000E-01	3.2996000E-01	4.9623000E-01
2.2565000E+03	3.8476000E-01	8.3719000E-01	3.2212000E-01	4.8445000E-01
2.2566000E+03	3.7543000E-01	8.3719000E-01	3.1431000E-01	4.7270000E-01
2.2567000E+03	3.6613000E-01	8.3720000E-01	3.0653000E-01	4.6100000E-01
2.2568000E+03	3.5688000E-01	8.3721000E-01	2.9879000E-01	4.4936000E-01
2.2569000E+03	3.4769000E-01	8.3721000E-01	2.9109000E-01	4.3778000E-01
2.2570000E+03	3.3856000E-01	8.3722000E-01	2.8345000E-01	4.2629000E-01
2.2571000E+03	3.2950000E-01	8.3723000E-01	2.7587000E-01	4.1489000E-01
2.2572000E+03	3.2052000E-01	8.3724000E-01	2.6835000E-01	4.0358000E-01
2.2573000E+03	3.1162000E-01	8.3725000E-01	2.6090000E-01	3.9238000E-01
2.2574000E+03	3.0281000E-01	8.3725000E-01	2.5353000E-01	3.8129000E-01
2.2575000E+03	2.9410000E-01	8.3726000E-01	2.4624000E-01	3.7033000E-01
2.2576000E+03	2.8550000E-01	8.3727000E-01	2.3904000E-01	3.5950000E-01
2.2577000E+03	2.7700000E-01	8.3728000E-01	2.3193000E-01	3.4880000E-01
2.2578000E+03	2.6862000E-01	8.3729000E-01	2.2491000E-01	3.3826000E-01
2.2579000E+03	2.6037000E-01	8.3729000E-01	2.1800000E-01	3.2786000E-01
2.2580000E+03	2.5224000E-01	8.3730000E-01	2.1120000E-01	3.1763000E-01
2.2581000E+03	2.4424000E-01	8.3730000E-01	2.0450000E-01	3.0756000E-01
2.2582000E+03	2.3638000E-01	8.3730000E-01	1.9792000E-01	2.9766000E-01
2.2583000E+03	2.2866000E-01	8.3730000E-01	1.9146000E-01	2.8794000E-01
2.2584000E+03	2.2109000E-01	8.3730000E-01	1.8511000E-01	2.7840000E-01
2.2585000E+03	2.1366000E-01	8.3730000E-01	1.7890000E-01	2.6905000E-01
2.2586000E+03	2.0639000E-01	8.3729000E-01	1.7281000E-01	2.5990000E-01
2.2587000E+03	1.9928000E-01	8.3729000E-01	1.6685000E-01	2.5094000E-01
2.2588000E+03	1.9232000E-01	8.3729000E-01	1.6103000E-01	2.4218000E-01
2.2589000E+03	1.8553000E-01	8.3729000E-01	1.5534000E-01	2.3362000E-01
2.2590000E+03	1.7889000E-01	8.3729000E-01	1.4979000E-01	2.2527000E-01
2.2591000E+03	1.7243000E-01	8.3729000E-01	1.4437000E-01	2.1713000E-01
2.2592000E+03	1.6613000E-01	8.3728000E-01	1.3910000E-01	2.0919000E-01
2.2593000E+03	1.6000000E-01	8.3728000E-01	1.3396000E-01	2.0147000E-01
2.2594000E+03	1.5404000E-01	8.3728000E-01	1.2897000E-01	1.9396000E-01
2.2595000E+03	1.4824000E-01	8.3728000E-01	1.2412000E-01	1.8667000E-01
2.2596000E+03	1.4262000E-01	8.3728000E-01	1.1941000E-01	1.7959000E-01
2.2597000E+03	1.3716000E-01	8.3727000E-01	1.1484000E-01	1.7272000E-01
2.2598000E+03	1.3188000E-01	8.3727000E-01	1.1042000E-01	1.6606000E-01
2.2599000E+03	1.2676000E-01	8.3727000E-01	1.0613000E-01	1.5961000E-01
2.2600000E+03	1.2181000E-01	8.3727000E-01	1.0199000E-01	1.5338000E-01
2.2601000E+03	1.1702000E-01	8.3729000E-01	9.7982000E-02	1.4736000E-01
2.2602000E+03	1.1240000E-01	8.3732000E-01	9.4114000E-02	1.4154000E-01

2.2603000E+03	1.0794000E-01	8.3734000E-01	9.0383000E-02	1.3593000E-01
2.2604000E+03	1.0364000E-01	8.3737000E-01	8.6786000E-02	1.3052000E-01
2.2605000E+03	9.9500000E-02	8.3736000E-01	8.3317000E-02	1.2530000E-01
2.2606000E+03	9.5514000E-02	8.3735000E-01	7.9979000E-02	1.2028000E-01
2.2607000E+03	9.1680000E-02	8.3734000E-01	7.6768000E-02	1.1545000E-01
2.2608000E+03	8.7997000E-02	8.3733000E-01	7.3682000E-02	1.1081000E-01
2.2609000E+03	8.4459000E-02	8.3732000E-01	7.0720000E-02	1.0636000E-01
2.2610000E+03	8.1065000E-02	8.3731000E-01	6.7877000E-02	1.0208000E-01
2.2611000E+03	7.7811000E-02	8.3730000E-01	6.5152000E-02	9.7984000E-02
2.2612000E+03	7.4694000E-02	8.3729000E-01	6.2541000E-02	9.4057000E-02
2.2613000E+03	7.1709000E-02	8.3728000E-01	6.0041000E-02	9.0298000E-02
2.2614000E+03	6.8853000E-02	8.3728000E-01	5.7649000E-02	8.6700000E-02
2.2615000E+03	6.6122000E-02	8.3727000E-01	5.5362000E-02	8.3261000E-02
2.2616000E+03	6.3513000E-02	8.3726000E-01	5.3176000E-02	7.9974000E-02
2.2617000E+03	6.1020000E-02	8.3725000E-01	5.1089000E-02	7.6834000E-02
2.2618000E+03	5.8640000E-02	8.3724000E-01	4.9096000E-02	7.3837000E-02
2.2619000E+03	5.6370000E-02	8.3723000E-01	4.7195000E-02	7.0978000E-02
2.2620000E+03	5.4204000E-02	8.3722000E-01	4.5381000E-02	6.8250000E-02
2.2621000E+03	5.2139000E-02	8.3720000E-01	4.3651000E-02	6.5649000E-02
2.2622000E+03	5.0171000E-02	8.3719000E-01	4.2002000E-02	6.3169000E-02
2.2623000E+03	4.8295000E-02	8.3717000E-01	4.0431000E-02	6.0806000E-02
2.2624000E+03	4.6507000E-02	8.3715000E-01	3.8934000E-02	5.8554000E-02
2.2625000E+03	4.4804000E-02	8.3713000E-01	3.7507000E-02	5.6408000E-02
2.2626000E+03	4.3181000E-02	8.3712000E-01	3.6147000E-02	5.4363000E-02
2.2627000E+03	4.1634000E-02	8.3710000E-01	3.4852000E-02	5.2415000E-02
2.2628000E+03	4.0160000E-02	8.3708000E-01	3.3617000E-02	5.0558000E-02
2.2629000E+03	3.8754000E-02	8.3707000E-01	3.2440000E-02	4.8787000E-02
2.2630000E+03	3.7414000E-02	8.3705000E-01	3.1317000E-02	4.7099000E-02
2.2631000E+03	3.6134000E-02	8.3703000E-01	3.0245000E-02	4.5487000E-02
2.2632000E+03	3.4913000E-02	8.3701000E-01	2.9223000E-02	4.3949000E-02
2.2633000E+03	3.3746000E-02	8.3699000E-01	2.8245000E-02	4.2479000E-02
2.2634000E+03	3.2631000E-02	8.3697000E-01	2.7311000E-02	4.1074000E-02
2.2635000E+03	3.1563000E-02	8.3696000E-01	2.6417000E-02	3.9729000E-02
2.2636000E+03	3.0541000E-02	8.3694000E-01	2.5561000E-02	3.8442000E-02
2.2637000E+03	2.9561000E-02	8.3692000E-01	2.4740000E-02	3.7208000E-02
2.2638000E+03	2.8621000E-02	8.3690000E-01	2.3953000E-02	3.6024000E-02
2.2639000E+03	2.7718000E-02	8.3688000E-01	2.3197000E-02	3.4886000E-02
2.2640000E+03	2.6849000E-02	8.3686000E-01	2.2469000E-02	3.3792000E-02
2.2641000E+03	2.6013000E-02	8.3685000E-01	2.1769000E-02	3.2739000E-02
2.2642000E+03	2.5207000E-02	8.3684000E-01	2.1094000E-02	3.1724000E-02
2.2643000E+03	2.4429000E-02	8.3682000E-01	2.0443000E-02	3.0745000E-02
2.2644000E+03	2.3678000E-02	8.3681000E-01	1.9814000E-02	2.9799000E-02
2.2645000E+03	2.2951000E-02	8.3679000E-01	1.9206000E-02	2.8884000E-02

2.2646000E+03	2.2248000E-02	8.3678000E-01	1.8617000E-02	2.7998000E-02
2.2647000E+03	2.1566000E-02	8.3677000E-01	1.8046000E-02	2.7139000E-02
2.2648000E+03	2.0904000E-02	8.3675000E-01	1.7492000E-02	2.6306000E-02
2.2649000E+03	2.0262000E-02	8.3674000E-01	1.6954000E-02	2.5497000E-02
2.2650000E+03	1.9637000E-02	8.3673000E-01	1.6431000E-02	2.4711000E-02
2.2651000E+03	1.9030000E-02	8.3671000E-01	1.5922000E-02	2.3946000E-02
2.2652000E+03	1.8438000E-02	8.3670000E-01	1.5427000E-02	2.3202000E-02
2.2653000E+03	1.7862000E-02	8.3669000E-01	1.4945000E-02	2.2476000E-02
2.2654000E+03	1.7301000E-02	8.3667000E-01	1.4475000E-02	2.1769000E-02
2.2655000E+03	1.6754000E-02	8.3664000E-01	1.4017000E-02	2.1080000E-02
2.2656000E+03	1.6220000E-02	8.3661000E-01	1.3570000E-02	2.0408000E-02
2.2657000E+03	1.5699000E-02	8.3659000E-01	1.3134000E-02	1.9752000E-02
2.2658000E+03	1.5191000E-02	8.3656000E-01	1.2708000E-02	1.9112000E-02
2.2659000E+03	1.4695000E-02	8.3653000E-01	1.2293000E-02	1.8488000E-02
2.2660000E+03	1.4211000E-02	8.3651000E-01	1.1888000E-02	1.7878000E-02
2.2661000E+03	1.3739000E-02	8.3648000E-01	1.1492000E-02	1.7284000E-02
2.2662000E+03	1.3279000E-02	8.3644000E-01	1.1107000E-02	1.6704000E-02
2.2663000E+03	1.2830000E-02	8.3641000E-01	1.0731000E-02	1.6138000E-02
2.2664000E+03	1.2392000E-02	8.3638000E-01	1.0364000E-02	1.5587000E-02
2.2665000E+03	1.1965000E-02	8.3634000E-01	1.0007000E-02	1.5050000E-02
2.2666000E+03	1.1550000E-02	8.3631000E-01	9.6591000E-03	1.4527000E-02
2.2667000E+03	1.1145000E-02	8.3628000E-01	9.3205000E-03	1.4017000E-02
2.2668000E+03	1.0752000E-02	8.3624000E-01	8.9912000E-03	1.3522000E-02
2.2669000E+03	1.0370000E-02	8.3621000E-01	8.6712000E-03	1.3041000E-02
2.2670000E+03	9.9983000E-03	8.3618000E-01	8.3603000E-03	1.2573000E-02
2.2671000E+03	9.6936000E-03	8.3615000E-01	8.1053000E-03	1.2190000E-02
2.2672000E+03	9.3447000E-03	8.3612000E-01	7.8133000E-03	1.1751000E-02
2.2673000E+03	9.0070000E-03	8.3609000E-01	7.5307000E-03	1.1326000E-02
2.2674000E+03	8.6806000E-03	8.3607000E-01	7.2576000E-03	1.0915000E-02
2.2675000E+03	8.3656000E-03	8.3604000E-01	6.9940000E-03	1.0518000E-02
2.2676000E+03	8.0620000E-03	8.3601000E-01	6.7399000E-03	1.0136000E-02
2.2677000E+03	7.7699000E-03	8.3598000E-01	6.4956000E-03	9.7689000E-03
2.2678000E+03	7.4895000E-03	8.3596000E-01	6.2609000E-03	9.4160000E-03
2.2679000E+03	7.2209000E-03	8.3593000E-01	6.0362000E-03	9.0780000E-03
2.2680000E+03	6.9642000E-03	8.3590000E-01	5.8214000E-03	8.7550000E-03
2.2681000E+03	6.7194000E-03	8.3587000E-01	5.6166000E-03	8.4470000E-03
2.2682000E+03	6.4868000E-03	8.3584000E-01	5.4219000E-03	8.1543000E-03
2.2683000E+03	6.2664000E-03	8.3581000E-01	5.2375000E-03	7.8769000E-03
2.2684000E+03	6.0584000E-03	8.3578000E-01	5.0634000E-03	7.6151000E-03
2.2685000E+03	5.8627000E-03	8.3575000E-01	4.8997000E-03	7.3689000E-03
2.2686000E+03	5.6794000E-03	8.3572000E-01	4.7464000E-03	7.1383000E-03
2.2687000E+03	5.5086000E-03	8.3569000E-01	4.6035000E-03	6.9233000E-03
2.2688000E+03	5.3502000E-03	8.3566000E-01	4.4709000E-03	6.7239000E-03

2.2689000E+03	5.2040000E-03	8.3563000E-01	4.3486000E-03	6.5400000E-03
2.2690000E+03	5.0700000E-03	8.3560000E-01	4.2364000E-03	6.3713000E-03
2.2691000E+03	4.9478000E-03	8.3556000E-01	4.1342000E-03	6.2176000E-03
2.2692000E+03	4.8373000E-03	8.3553000E-01	4.0417000E-03	6.0785000E-03
2.2693000E+03	4.7380000E-03	8.3550000E-01	3.9586000E-03	5.9535000E-03
2.2694000E+03	4.6495000E-03	8.3547000E-01	3.8845000E-03	5.8420000E-03
2.2695000E+03	4.5712000E-03	8.3544000E-01	3.8190000E-03	5.7435000E-03
2.2696000E+03	4.5026000E-03	8.3541000E-01	3.7615000E-03	5.6571000E-03
2.2697000E+03	4.4430000E-03	8.3538000E-01	3.7116000E-03	5.5819000E-03
2.2698000E+03	4.3917000E-03	8.3535000E-01	3.6686000E-03	5.5173000E-03
2.2699000E+03	4.3479000E-03	8.3532000E-01	3.6319000E-03	5.4621000E-03
2.2700000E+03	4.3109000E-03	8.3528000E-01	3.6009000E-03	5.4155000E-03
2.2701000E+03	4.2799000E-03	8.3527000E-01	3.5749000E-03	5.3764000E-03
2.2702000E+03	4.2541000E-03	8.3526000E-01	3.5533000E-03	5.3439000E-03
2.2703000E+03	4.2326000E-03	8.3525000E-01	3.5353000E-03	5.3168000E-03
2.2704000E+03	4.2146000E-03	8.3524000E-01	3.5202000E-03	5.2942000E-03
2.2705000E+03	4.1995000E-03	8.3523000E-01	3.5076000E-03	5.2752000E-03
2.2706000E+03	4.1865000E-03	8.3522000E-01	3.4966000E-03	5.2587000E-03
2.2707000E+03	4.1749000E-03	8.3521000E-01	3.4869000E-03	5.2441000E-03
2.2708000E+03	4.1641000E-03	8.3520000E-01	3.4778000E-03	5.2305000E-03
2.2709000E+03	4.1535000E-03	8.3519000E-01	3.4690000E-03	5.2171000E-03
2.2710000E+03	4.1426000E-03	8.3518000E-01	3.4599000E-03	5.2034000E-03
2.2711000E+03	4.1311000E-03	8.3517000E-01	3.4502000E-03	5.1888000E-03
2.2712000E+03	4.1184000E-03	8.3516000E-01	3.4395000E-03	5.1728000E-03
2.2713000E+03	4.1043000E-03	8.3515000E-01	3.4277000E-03	5.1551000E-03
2.2714000E+03	4.0885000E-03	8.3514000E-01	3.4145000E-03	5.1352000E-03
2.2715000E+03	4.0709000E-03	8.3512000E-01	3.3997000E-03	5.1129000E-03
2.2716000E+03	4.0512000E-03	8.3511000E-01	3.3832000E-03	5.0881000E-03
2.2717000E+03	4.0293000E-03	8.3510000E-01	3.3649000E-03	5.0606000E-03
2.2718000E+03	4.0053000E-03	8.3509000E-01	3.3448000E-03	5.0303000E-03
2.2719000E+03	3.9791000E-03	8.3507000E-01	3.3228000E-03	4.9973000E-03
2.2720000E+03	3.9506000E-03	8.3506000E-01	3.2990000E-03	4.9615000E-03
2.2721000E+03	3.9201000E-03	8.3502000E-01	3.2733000E-03	4.9229000E-03
2.2722000E+03	3.8875000E-03	8.3497000E-01	3.2459000E-03	4.8816000E-03
2.2723000E+03	3.8529000E-03	8.3493000E-01	3.2169000E-03	4.8380000E-03
2.2724000E+03	3.8165000E-03	8.3488000E-01	3.1863000E-03	4.7920000E-03
2.2725000E+03	3.7784000E-03	8.3483000E-01	3.1543000E-03	4.7439000E-03
2.2726000E+03	3.7386000E-03	8.3479000E-01	3.1210000E-03	4.6937000E-03
2.2727000E+03	3.6974000E-03	8.3474000E-01	3.0864000E-03	4.6418000E-03
2.2728000E+03	3.6549000E-03	8.3470000E-01	3.0507000E-03	4.5881000E-03
2.2729000E+03	3.6111000E-03	8.3465000E-01	3.0140000E-03	4.5329000E-03
2.2730000E+03	3.5662000E-03	8.3461000E-01	2.9764000E-03	4.4762000E-03
2.2731000E+03	3.5201000E-03	8.3456000E-01	2.9378000E-03	4.4182000E-03

2.2732000E+03	3.4731000E-03	8.3452000E-01	2.8983000E-03	4.3589000E-03
2.2733000E+03	3.4250000E-03	8.3447000E-01	2.8581000E-03	4.2983000E-03
2.2734000E+03	3.3759000E-03	8.3442000E-01	2.8169000E-03	4.2365000E-03
2.2735000E+03	3.3258000E-03	8.3437000E-01	2.7750000E-03	4.1734000E-03
2.2736000E+03	3.2747000E-03	8.3432000E-01	2.7321000E-03	4.1089000E-03
2.2737000E+03	3.2224000E-03	8.3427000E-01	2.6883000E-03	4.0431000E-03
2.2738000E+03	3.1688000E-03	8.3422000E-01	2.6435000E-03	3.9757000E-03
2.2739000E+03	3.1140000E-03	8.3417000E-01	2.5976000E-03	3.9066000E-03
2.2740000E+03	3.0577000E-03	8.3411000E-01	2.5505000E-03	3.8358000E-03
2.2741000E+03	2.9999000E-03	8.3406000E-01	2.5021000E-03	3.7630000E-03
2.2742000E+03	2.9403000E-03	8.3401000E-01	2.4522000E-03	3.6880000E-03
2.2743000E+03	2.8789000E-03	8.3396000E-01	2.4009000E-03	3.6107000E-03
2.2744000E+03	2.8155000E-03	8.3390000E-01	2.3478000E-03	3.5310000E-03
2.2745000E+03	2.7500000E-03	8.3385000E-01	2.2931000E-03	3.4486000E-03
2.2746000E+03	2.6823000E-03	8.3380000E-01	2.2365000E-03	3.3635000E-03
2.2747000E+03	2.6122000E-03	8.3374000E-01	2.1779000E-03	3.2755000E-03
2.2748000E+03	2.5399000E-03	8.3369000E-01	2.1175000E-03	3.1845000E-03
2.2749000E+03	2.4651000E-03	8.3364000E-01	2.0550000E-03	3.0906000E-03
2.2750000E+03	2.3879000E-03	8.3359000E-01	1.9905000E-03	2.9936000E-03
2.2751000E+03	2.3083000E-03	8.3354000E-01	1.9241000E-03	2.8937000E-03
2.2752000E+03	2.2265000E-03	8.3349000E-01	1.8558000E-03	2.7910000E-03
2.2753000E+03	2.1426000E-03	8.3343000E-01	1.7857000E-03	2.6856000E-03
2.2754000E+03	2.0567000E-03	8.3338000E-01	1.7140000E-03	2.5778000E-03
2.2755000E+03	1.9692000E-03	8.3333000E-01	1.6410000E-03	2.4679000E-03
2.2756000E+03	1.8803000E-03	8.3328000E-01	1.5668000E-03	2.3564000E-03
2.2757000E+03	1.7905000E-03	8.3323000E-01	1.4919000E-03	2.2438000E-03
2.2758000E+03	1.7004000E-03	8.3318000E-01	1.4167000E-03	2.1307000E-03
2.2759000E+03	1.6105000E-03	8.3313000E-01	1.3418000E-03	2.0179000E-03
2.2760000E+03	1.5216000E-03	8.3308000E-01	1.2676000E-03	1.9064000E-03
2.2761000E+03	1.4346000E-03	8.3304000E-01	1.1950000E-03	1.7973000E-03
2.2762000E+03	1.3504000E-03	8.3299000E-01	1.1249000E-03	1.6918000E-03
2.2763000E+03	1.2704000E-03	8.3295000E-01	1.0582000E-03	1.5914000E-03
2.2764000E+03	1.1956000E-03	8.3290000E-01	9.9582000E-04	1.4977000E-03
2.2765000E+03	1.1275000E-03	8.3286000E-01	9.3901000E-04	1.4122000E-03
2.2766000E+03	1.0672000E-03	8.3282000E-01	8.8875000E-04	1.3366000E-03
2.2767000E+03	1.0159000E-03	8.3277000E-01	8.4600000E-04	1.2723000E-03
2.2768000E+03	9.7456000E-04	8.3273000E-01	8.1155000E-04	1.2205000E-03
2.2769000E+03	9.4381000E-04	8.3268000E-01	7.8590000E-04	1.1819000E-03
2.2770000E+03	9.2395000E-04	8.3264000E-01	7.6932000E-04	1.1570000E-03
2.2771000E+03	9.1496000E-04	8.3260000E-01	7.6179000E-04	1.1457000E-03
2.2772000E+03	0.0000000E+00	8.3256000E-01	0.0000000E+00	0.0000000E+00
Channel 17				

Wavenumber	HIRS Filter Transmittance	Optical Element Transmittance	Product of the HIRS Filter and Optical Element Transmittances	Normalized Value of Column 4
2.3817000E+03	0.0000000E+00	8.1785000E-01	0.0000000E+00	0.0000000E+00
2.3818000E+03	7.8632000E-04	8.1769000E-01	6.4297000E-04	1.0508000E-03
2.3819000E+03	7.9479000E-04	8.1754000E-01	6.4977000E-04	1.0620000E-03
2.3820000E+03	8.0299000E-04	8.1739000E-01	6.5636000E-04	1.0727000E-03
2.3821000E+03	8.1098000E-04	8.1729000E-01	6.6280000E-04	1.0833000E-03
2.3822000E+03	8.1880000E-04	8.1719000E-01	6.6911000E-04	1.0936000E-03
2.3823000E+03	8.2630000E-04	8.1709000E-01	6.7516000E-04	1.1035000E-03
2.3824000E+03	8.3430000E-04	8.1699000E-01	6.8162000E-04	1.1140000E-03
2.3825000E+03	8.4234000E-04	8.1689000E-01	6.8810000E-04	1.1246000E-03
2.3826000E+03	8.5051000E-04	8.1679000E-01	6.9469000E-04	1.1354000E-03
2.3827000E+03	8.5888000E-04	8.1669000E-01	7.0144000E-04	1.1464000E-03
2.3828000E+03	8.6754000E-04	8.1659000E-01	7.0842000E-04	1.1578000E-03
2.3829000E+03	8.7658000E-04	8.1649000E-01	7.1572000E-04	1.1697000E-03
2.3830000E+03	8.8610000E-04	8.1639000E-01	7.2341000E-04	1.1823000E-03
2.3831000E+03	8.9621000E-04	8.1629000E-01	7.3157000E-04	1.1956000E-03
2.3832000E+03	9.0702000E-04	8.1619000E-01	7.4030000E-04	1.2099000E-03
2.3833000E+03	9.1866000E-04	8.1609000E-01	7.4970000E-04	1.2253000E-03
2.3834000E+03	9.3123000E-04	8.1599000E-01	7.5987000E-04	1.2419000E-03
2.3835000E+03	9.4489000E-04	8.1589000E-01	7.7092000E-04	1.2600000E-03
2.3836000E+03	9.5975000E-04	8.1578000E-01	7.8295000E-04	1.2796000E-03
2.3837000E+03	9.7597000E-04	8.1568000E-01	7.9608000E-04	1.3011000E-03
2.3838000E+03	9.9368000E-04	8.1558000E-01	8.1043000E-04	1.3245000E-03
2.3839000E+03	1.0130000E-03	8.1548000E-01	8.2611000E-04	1.3502000E-03
2.3840000E+03	1.0342000E-03	8.1538000E-01	8.4323000E-04	1.3781000E-03
2.3841000E+03	1.0572000E-03	8.1531000E-01	8.6196000E-04	1.4088000E-03
2.3842000E+03	1.0824000E-03	8.1524000E-01	8.8238000E-04	1.4421000E-03
2.3843000E+03	1.1097000E-03	8.1517000E-01	9.0459000E-04	1.4784000E-03
2.3844000E+03	1.1394000E-03	8.1511000E-01	9.2872000E-04	1.5179000E-03
2.3845000E+03	1.1716000E-03	8.1504000E-01	9.5486000E-04	1.5606000E-03
2.3846000E+03	1.2063000E-03	8.1497000E-01	9.8312000E-04	1.6068000E-03
2.3847000E+03	1.2438000E-03	8.1490000E-01	1.0136000E-03	1.6566000E-03
2.3848000E+03	1.2842000E-03	8.1483000E-01	1.0464000E-03	1.7101000E-03
2.3849000E+03	1.3274000E-03	8.1477000E-01	1.0815000E-03	1.7676000E-03
2.3850000E+03	1.3737000E-03	8.1470000E-01	1.1192000E-03	1.8291000E-03
2.3851000E+03	1.4232000E-03	8.1463000E-01	1.1593000E-03	1.8948000E-03
2.3852000E+03	1.4758000E-03	8.1456000E-01	1.2021000E-03	1.9647000E-03
2.3853000E+03	1.5317000E-03	8.1449000E-01	1.2476000E-03	2.0390000E-03
2.3854000E+03	1.5910000E-03	8.1442000E-01	1.2957000E-03	2.1177000E-03
2.3855000E+03	1.6536000E-03	8.1435000E-01	1.3466000E-03	2.2009000E-03

2.3856000E+03	1.7197000E-03	8.1428000E-01	1.4004000E-03	2.2887000E-03
2.3857000E+03	1.7894000E-03	8.1421000E-01	1.4569000E-03	2.3811000E-03
2.3858000E+03	1.8625000E-03	8.1414000E-01	1.5164000E-03	2.4783000E-03
2.3859000E+03	1.9393000E-03	8.1408000E-01	1.5787000E-03	2.5802000E-03
2.3860000E+03	2.0197000E-03	8.1401000E-01	1.6440000E-03	2.6870000E-03
2.3861000E+03	2.1038000E-03	8.1395000E-01	1.7124000E-03	2.7986000E-03
2.3862000E+03	2.1915000E-03	8.1390000E-01	1.7837000E-03	2.9152000E-03
2.3863000E+03	2.2830000E-03	8.1384000E-01	1.8580000E-03	3.0367000E-03
2.3864000E+03	2.3783000E-03	8.1379000E-01	1.9354000E-03	3.1631000E-03
2.3865000E+03	2.4773000E-03	8.1373000E-01	2.0159000E-03	3.2946000E-03
2.3866000E+03	2.5802000E-03	8.1367000E-01	2.0994000E-03	3.4312000E-03
2.3867000E+03	2.6869000E-03	8.1361000E-01	2.1861000E-03	3.5728000E-03
2.3868000E+03	2.7975000E-03	8.1355000E-01	2.2759000E-03	3.7196000E-03
2.3869000E+03	2.9120000E-03	8.1349000E-01	2.3689000E-03	3.8716000E-03
2.3870000E+03	3.0305000E-03	8.1343000E-01	2.4651000E-03	4.0288000E-03
2.3871000E+03	3.1529000E-03	8.1337000E-01	2.5645000E-03	4.1913000E-03
2.3872000E+03	3.2794000E-03	8.1331000E-01	2.6672000E-03	4.3591000E-03
2.3873000E+03	3.4100000E-03	8.1325000E-01	2.7732000E-03	4.5323000E-03
2.3874000E+03	3.5447000E-03	8.1319000E-01	2.8825000E-03	4.7110000E-03
2.3875000E+03	3.6835000E-03	8.1313000E-01	2.9951000E-03	4.8951000E-03
2.3876000E+03	3.8265000E-03	8.1307000E-01	3.1112000E-03	5.0848000E-03
2.3877000E+03	3.9738000E-03	8.1301000E-01	3.2307000E-03	5.2802000E-03
2.3878000E+03	4.1254000E-03	8.1295000E-01	3.3537000E-03	5.4812000E-03
2.3879000E+03	4.2814000E-03	8.1289000E-01	3.4803000E-03	5.6880000E-03
2.3880000E+03	4.4418000E-03	8.1283000E-01	3.6104000E-03	5.9007000E-03
2.3881000E+03	4.6067000E-03	8.1278000E-01	3.7443000E-03	6.1195000E-03
2.3882000E+03	4.7762000E-03	8.1274000E-01	3.8818000E-03	6.3443000E-03
2.3883000E+03	4.9503000E-03	8.1270000E-01	4.0231000E-03	6.5752000E-03
2.3884000E+03	5.1291000E-03	8.1265000E-01	4.1682000E-03	6.8123000E-03
2.3885000E+03	5.3128000E-03	8.1261000E-01	4.3172000E-03	7.0558000E-03
2.3886000E+03	5.5013000E-03	8.1256000E-01	4.4701000E-03	7.3058000E-03
2.3887000E+03	5.6947000E-03	8.1252000E-01	4.6271000E-03	7.5623000E-03
2.3888000E+03	5.8933000E-03	8.1248000E-01	4.7881000E-03	7.8255000E-03
2.3889000E+03	6.0969000E-03	8.1243000E-01	4.9534000E-03	8.0956000E-03
2.3890000E+03	6.3059000E-03	8.1239000E-01	5.1228000E-03	8.3726000E-03
2.3891000E+03	6.5202000E-03	8.1234000E-01	5.2966000E-03	8.6566000E-03
2.3892000E+03	6.7400000E-03	8.1230000E-01	5.4749000E-03	8.9479000E-03
2.3893000E+03	6.9654000E-03	8.1225000E-01	5.6576000E-03	9.2466000E-03
2.3894000E+03	7.1965000E-03	8.1220000E-01	5.8450000E-03	9.5528000E-03
2.3895000E+03	7.4334000E-03	8.1215000E-01	6.0370000E-03	9.8667000E-03
2.3896000E+03	7.6763000E-03	8.1211000E-01	6.2339000E-03	1.0188000E-02
2.3897000E+03	7.9252000E-03	8.1206000E-01	6.4358000E-03	1.0518000E-02
2.3898000E+03	8.1805000E-03	8.1201000E-01	6.6426000E-03	1.0856000E-02

2.3899000E+03	8.4421000E-03	8.1196000E-01	6.8547000E-03	1.1203000E-02
2.3900000E+03	8.7102000E-03	8.1192000E-01	7.0719000E-03	1.1558000E-02
2.3901000E+03	8.9850000E-03	8.1188000E-01	7.2948000E-03	1.1922000E-02
2.3902000E+03	9.2666000E-03	8.1185000E-01	7.5231000E-03	1.2295000E-02
2.3903000E+03	9.5553000E-03	8.1182000E-01	7.7571000E-03	1.2678000E-02
2.3904000E+03	9.8510000E-03	8.1178000E-01	7.9969000E-03	1.3070000E-02
2.3905000E+03	1.0154000E-02	8.1175000E-01	8.2427000E-03	1.3471000E-02
2.3906000E+03	1.0465000E-02	8.1171000E-01	8.4944000E-03	1.3883000E-02
2.3907000E+03	1.0783000E-02	8.1168000E-01	8.7524000E-03	1.4305000E-02
2.3908000E+03	1.1109000E-02	8.1165000E-01	9.0168000E-03	1.4737000E-02
2.3909000E+03	1.1444000E-02	8.1161000E-01	9.2878000E-03	1.5180000E-02
2.3910000E+03	1.1786000E-02	8.1158000E-01	9.5653000E-03	1.5633000E-02
2.3911000E+03	1.2137000E-02	8.1154000E-01	9.8497000E-03	1.6098000E-02
2.3912000E+03	1.2497000E-02	8.1150000E-01	1.0141000E-02	1.6574000E-02
2.3913000E+03	1.2865000E-02	8.1146000E-01	1.0440000E-02	1.7062000E-02
2.3914000E+03	1.3243000E-02	8.1142000E-01	1.0746000E-02	1.7562000E-02
2.3915000E+03	1.3630000E-02	8.1138000E-01	1.1059000E-02	1.8074000E-02
2.3916000E+03	1.4026000E-02	8.1135000E-01	1.1380000E-02	1.8599000E-02
2.3917000E+03	1.4432000E-02	8.1131000E-01	1.1709000E-02	1.9136000E-02
2.3918000E+03	1.4848000E-02	8.1127000E-01	1.2046000E-02	1.9687000E-02
2.3919000E+03	1.5274000E-02	8.1123000E-01	1.2391000E-02	2.0252000E-02
2.3920000E+03	1.5711000E-02	8.1119000E-01	1.2745000E-02	2.0830000E-02
2.3921000E+03	1.6159000E-02	8.1115000E-01	1.3107000E-02	2.1422000E-02
2.3922000E+03	1.6617000E-02	8.1111000E-01	1.3478000E-02	2.2028000E-02
2.3923000E+03	1.7087000E-02	8.1107000E-01	1.3859000E-02	2.2650000E-02
2.3924000E+03	1.7568000E-02	8.1103000E-01	1.4248000E-02	2.3287000E-02
2.3925000E+03	1.8061000E-02	8.1099000E-01	1.4647000E-02	2.3939000E-02
2.3926000E+03	1.8566000E-02	8.1095000E-01	1.5056000E-02	2.4607000E-02
2.3927000E+03	1.9083000E-02	8.1091000E-01	1.5475000E-02	2.5292000E-02
2.3928000E+03	1.9614000E-02	8.1087000E-01	1.5904000E-02	2.5993000E-02
2.3929000E+03	2.0157000E-02	8.1082000E-01	1.6344000E-02	2.6711000E-02
2.3930000E+03	2.0713000E-02	8.1078000E-01	1.6794000E-02	2.7447000E-02
2.3931000E+03	2.1283000E-02	8.1074000E-01	1.7255000E-02	2.8201000E-02
2.3932000E+03	2.1868000E-02	8.1070000E-01	1.7728000E-02	2.8974000E-02
2.3933000E+03	2.2466000E-02	8.1065000E-01	1.8212000E-02	2.9766000E-02
2.3934000E+03	2.3080000E-02	8.1061000E-01	1.8709000E-02	3.0577000E-02
2.3935000E+03	2.3709000E-02	8.1057000E-01	1.9218000E-02	3.1408000E-02
2.3936000E+03	2.4353000E-02	8.1053000E-01	1.9739000E-02	3.2260000E-02
2.3937000E+03	2.5014000E-02	8.1048000E-01	2.0273000E-02	3.3134000E-02
2.3938000E+03	2.5691000E-02	8.1044000E-01	2.0821000E-02	3.4029000E-02
2.3939000E+03	2.6385000E-02	8.1040000E-01	2.1382000E-02	3.4946000E-02
2.3940000E+03	2.7097000E-02	8.1036000E-01	2.1958000E-02	3.5887000E-02
2.3941000E+03	2.7826000E-02	8.1030000E-01	2.2548000E-02	3.6851000E-02

2.3942000E+03	2.8575000E-02	8.1024000E-01	2.3153000E-02	3.7840000E-02
2.3943000E+03	2.9343000E-02	8.1018000E-01	2.3773000E-02	3.8854000E-02
2.3944000E+03	3.0130000E-02	8.1012000E-01	2.4409000E-02	3.9894000E-02
2.3945000E+03	3.0939000E-02	8.1007000E-01	2.5062000E-02	4.0961000E-02
2.3946000E+03	3.1768000E-02	8.1001000E-01	2.5732000E-02	4.2055000E-02
2.3947000E+03	3.2619000E-02	8.0995000E-01	2.6420000E-02	4.3179000E-02
2.3948000E+03	3.3492000E-02	8.0989000E-01	2.7125000E-02	4.4332000E-02
2.3949000E+03	3.4389000E-02	8.0983000E-01	2.7850000E-02	4.5516000E-02
2.3950000E+03	3.5310000E-02	8.0978000E-01	2.8594000E-02	4.6732000E-02
2.3951000E+03	3.6256000E-02	8.0972000E-01	2.9358000E-02	4.7981000E-02
2.3952000E+03	3.7228000E-02	8.0966000E-01	3.0142000E-02	4.9263000E-02
2.3953000E+03	3.8227000E-02	8.0961000E-01	3.0949000E-02	5.0581000E-02
2.3954000E+03	3.9253000E-02	8.0955000E-01	3.1777000E-02	5.1935000E-02
2.3955000E+03	4.0307000E-02	8.0949000E-01	3.2628000E-02	5.3326000E-02
2.3956000E+03	4.1391000E-02	8.0944000E-01	3.3504000E-02	5.4757000E-02
2.3957000E+03	4.2506000E-02	8.0938000E-01	3.4403000E-02	5.6227000E-02
2.3958000E+03	4.3652000E-02	8.0932000E-01	3.5328000E-02	5.7739000E-02
2.3959000E+03	4.4831000E-02	8.0927000E-01	3.6280000E-02	5.9294000E-02
2.3960000E+03	4.6043000E-02	8.0921000E-01	3.7259000E-02	6.0894000E-02
2.3961000E+03	4.7291000E-02	8.0914000E-01	3.8265000E-02	6.2539000E-02
2.3962000E+03	4.8574000E-02	8.0908000E-01	3.9301000E-02	6.4231000E-02
2.3963000E+03	4.9896000E-02	8.0902000E-01	4.0366000E-02	6.5973000E-02
2.3964000E+03	5.1056000E-02	8.0895000E-01	4.1302000E-02	6.7502000E-02
2.3965000E+03	5.2449000E-02	8.0889000E-01	4.2426000E-02	6.9339000E-02
2.3966000E+03	5.3883000E-02	8.0882000E-01	4.3582000E-02	7.1229000E-02
2.3967000E+03	5.5360000E-02	8.0876000E-01	4.4773000E-02	7.3175000E-02
2.3968000E+03	5.6880000E-02	8.0870000E-01	4.5998000E-02	7.5178000E-02
2.3969000E+03	5.8445000E-02	8.0863000E-01	4.7261000E-02	7.7241000E-02
2.3970000E+03	6.0057000E-02	8.0857000E-01	4.8560000E-02	7.9365000E-02
2.3971000E+03	6.1717000E-02	8.0851000E-01	4.9899000E-02	8.1552000E-02
2.3972000E+03	6.3426000E-02	8.0846000E-01	5.1277000E-02	8.3805000E-02
2.3973000E+03	6.5186000E-02	8.0840000E-01	5.2697000E-02	8.6125000E-02
2.3974000E+03	6.6999000E-02	8.0834000E-01	5.4158000E-02	8.8514000E-02
2.3975000E+03	6.8866000E-02	8.0829000E-01	5.5663000E-02	9.0974000E-02
2.3976000E+03	7.0788000E-02	8.0823000E-01	5.7213000E-02	9.3506000E-02
2.3977000E+03	7.2767000E-02	8.0817000E-01	5.8808000E-02	9.6114000E-02
2.3978000E+03	7.4804000E-02	8.0812000E-01	6.0451000E-02	9.8798000E-02
2.3979000E+03	7.6902000E-02	8.0806000E-01	6.2141000E-02	1.0156000E-01
2.3980000E+03	7.9061000E-02	8.0800000E-01	6.3882000E-02	1.0441000E-01
2.3981000E+03	8.1283000E-02	8.0797000E-01	6.5674000E-02	1.0734000E-01
2.3982000E+03	8.3569000E-02	8.0794000E-01	6.7519000E-02	1.1035000E-01
2.3983000E+03	8.5922000E-02	8.0791000E-01	6.9417000E-02	1.1345000E-01
2.3984000E+03	8.8341000E-02	8.0788000E-01	7.1369000E-02	1.1664000E-01

2.3985000E+03	9.0830000E-02	8.0785000E-01	7.3377000E-02	1.1992000E-01
2.3986000E+03	9.3389000E-02	8.0781000E-01	7.5441000E-02	1.2330000E-01
2.3987000E+03	9.6020000E-02	8.0778000E-01	7.7563000E-02	1.2677000E-01
2.3988000E+03	9.8723000E-02	8.0775000E-01	7.9744000E-02	1.3033000E-01
2.3989000E+03	1.0150000E-01	8.0772000E-01	8.1984000E-02	1.3399000E-01
2.3990000E+03	1.0435000E-01	8.0769000E-01	8.4286000E-02	1.3775000E-01
2.3991000E+03	1.0729000E-01	8.0766000E-01	8.6650000E-02	1.4162000E-01
2.3992000E+03	1.1029000E-01	8.0763000E-01	8.9076000E-02	1.4558000E-01
2.3993000E+03	1.1338000E-01	8.0760000E-01	9.1566000E-02	1.4965000E-01
2.3994000E+03	1.1655000E-01	8.0757000E-01	9.4121000E-02	1.5383000E-01
2.3995000E+03	1.1980000E-01	8.0755000E-01	9.6741000E-02	1.5811000E-01
2.3996000E+03	1.2313000E-01	8.0752000E-01	9.9426000E-02	1.6250000E-01
2.3997000E+03	1.2654000E-01	8.0749000E-01	1.0218000E-01	1.6700000E-01
2.3998000E+03	1.3004000E-01	8.0746000E-01	1.0500000E-01	1.7161000E-01
2.3999000E+03	1.3362000E-01	8.0743000E-01	1.0789000E-01	1.7633000E-01
2.4000000E+03	1.3728000E-01	8.0740000E-01	1.1084000E-01	1.8116000E-01
2.4001000E+03	1.4103000E-01	8.0737000E-01	1.1387000E-01	1.8610000E-01
2.4002000E+03	1.4487000E-01	8.0733000E-01	1.1696000E-01	1.9115000E-01
2.4003000E+03	1.4879000E-01	8.0730000E-01	1.2012000E-01	1.9632000E-01
2.4004000E+03	1.5280000E-01	8.0727000E-01	1.2335000E-01	2.0160000E-01
2.4005000E+03	1.5690000E-01	8.0723000E-01	1.2665000E-01	2.0700000E-01
2.4006000E+03	1.6108000E-01	8.0720000E-01	1.3002000E-01	2.1251000E-01
2.4007000E+03	1.6535000E-01	8.0716000E-01	1.3346000E-01	2.1813000E-01
2.4008000E+03	1.6971000E-01	8.0713000E-01	1.3697000E-01	2.2386000E-01
2.4009000E+03	1.7415000E-01	8.0709000E-01	1.4055000E-01	2.2971000E-01
2.4010000E+03	1.7867000E-01	8.0706000E-01	1.4420000E-01	2.3567000E-01
2.4011000E+03	1.8328000E-01	8.0703000E-01	1.4792000E-01	2.4175000E-01
2.4012000E+03	1.8798000E-01	8.0699000E-01	1.5170000E-01	2.4793000E-01
2.4013000E+03	1.9276000E-01	8.0696000E-01	1.5555000E-01	2.5422000E-01
2.4014000E+03	1.9762000E-01	8.0693000E-01	1.5947000E-01	2.6062000E-01
2.4015000E+03	2.0256000E-01	8.0689000E-01	1.6345000E-01	2.6713000E-01
2.4016000E+03	2.0759000E-01	8.0686000E-01	1.6750000E-01	2.7375000E-01
2.4017000E+03	2.1269000E-01	8.0683000E-01	1.7161000E-01	2.8046000E-01
2.4018000E+03	2.1787000E-01	8.0679000E-01	1.7578000E-01	2.8728000E-01
2.4019000E+03	2.2313000E-01	8.0676000E-01	1.8001000E-01	2.9420000E-01
2.4020000E+03	2.2846000E-01	8.0673000E-01	1.8431000E-01	3.0122000E-01
2.4021000E+03	2.3386000E-01	8.0672000E-01	1.8866000E-01	3.0834000E-01
2.4022000E+03	2.3934000E-01	8.0671000E-01	1.9308000E-01	3.1556000E-01
2.4023000E+03	2.4489000E-01	8.0670000E-01	1.9755000E-01	3.2287000E-01
2.4024000E+03	2.5050000E-01	8.0669000E-01	2.0207000E-01	3.3026000E-01
2.4025000E+03	2.5617000E-01	8.0668000E-01	2.0665000E-01	3.3774000E-01
2.4026000E+03	2.6191000E-01	8.0668000E-01	2.1128000E-01	3.4530000E-01
2.4027000E+03	2.6771000E-01	8.0667000E-01	2.1595000E-01	3.5295000E-01

2.4028000E+03	2.7357000E-01	8.0666000E-01	2.2068000E-01	3.6066000E-01
2.4029000E+03	2.7948000E-01	8.0665000E-01	2.2544000E-01	3.6845000E-01
2.4030000E+03	2.8544000E-01	8.0664000E-01	2.3025000E-01	3.7631000E-01
2.4031000E+03	2.9145000E-01	8.0663000E-01	2.3509000E-01	3.8423000E-01
2.4032000E+03	2.9751000E-01	8.0661000E-01	2.3998000E-01	3.9221000E-01
2.4033000E+03	3.0361000E-01	8.0659000E-01	2.4489000E-01	4.0024000E-01
2.4034000E+03	3.0976000E-01	8.0658000E-01	2.4984000E-01	4.0833000E-01
2.4035000E+03	3.1593000E-01	8.0656000E-01	2.5482000E-01	4.1647000E-01
2.4036000E+03	3.2215000E-01	8.0654000E-01	2.5983000E-01	4.2465000E-01
2.4037000E+03	3.2839000E-01	8.0653000E-01	2.6486000E-01	4.3287000E-01
2.4038000E+03	3.3466000E-01	8.0651000E-01	2.6991000E-01	4.4113000E-01
2.4039000E+03	3.4096000E-01	8.0650000E-01	2.7498000E-01	4.4942000E-01
2.4040000E+03	3.4727000E-01	8.0648000E-01	2.8007000E-01	4.5773000E-01
2.4041000E+03	3.5360000E-01	8.0642000E-01	2.8515000E-01	4.6604000E-01
2.4042000E+03	3.5995000E-01	8.0636000E-01	2.9025000E-01	4.7437000E-01
2.4043000E+03	3.6630000E-01	8.0630000E-01	2.9535000E-01	4.8271000E-01
2.4044000E+03	3.7266000E-01	8.0624000E-01	3.0046000E-01	4.9105000E-01
2.4045000E+03	3.7903000E-01	8.0618000E-01	3.0556000E-01	4.9940000E-01
2.4046000E+03	3.8539000E-01	8.0612000E-01	3.1067000E-01	5.0774000E-01
2.4047000E+03	3.9175000E-01	8.0606000E-01	3.1577000E-01	5.1608000E-01
2.4048000E+03	3.9809000E-01	8.0600000E-01	3.2086000E-01	5.2441000E-01
2.4049000E+03	4.0443000E-01	8.0594000E-01	3.2595000E-01	5.3271000E-01
2.4050000E+03	4.1075000E-01	8.0588000E-01	3.3102000E-01	5.4100000E-01
2.4051000E+03	4.1705000E-01	8.0582000E-01	3.3607000E-01	5.4926000E-01
2.4052000E+03	4.2333000E-01	8.0577000E-01	3.4111000E-01	5.5749000E-01
2.4053000E+03	4.2958000E-01	8.0571000E-01	3.4612000E-01	5.6568000E-01
2.4054000E+03	4.3580000E-01	8.0565000E-01	3.5111000E-01	5.7383000E-01
2.4055000E+03	4.4199000E-01	8.0560000E-01	3.5607000E-01	5.8194000E-01
2.4056000E+03	4.4815000E-01	8.0554000E-01	3.6100000E-01	5.9000000E-01
2.4057000E+03	4.5426000E-01	8.0548000E-01	3.6590000E-01	5.9800000E-01
2.4058000E+03	4.6033000E-01	8.0543000E-01	3.7076000E-01	6.0595000E-01
2.4059000E+03	4.6635000E-01	8.0537000E-01	3.7558000E-01	6.1383000E-01
2.4060000E+03	4.7232000E-01	8.0531000E-01	3.8036000E-01	6.2165000E-01
2.4061000E+03	4.7824000E-01	8.0526000E-01	3.8511000E-01	6.2940000E-01
2.4062000E+03	4.8410000E-01	8.0521000E-01	3.8980000E-01	6.3708000E-01
2.4063000E+03	4.8991000E-01	8.0516000E-01	3.9445000E-01	6.4468000E-01
2.4064000E+03	4.9565000E-01	8.0511000E-01	3.9905000E-01	6.5220000E-01
2.4065000E+03	5.0133000E-01	8.0506000E-01	4.0360000E-01	6.5963000E-01
2.4066000E+03	5.0695000E-01	8.0500000E-01	4.0809000E-01	6.6697000E-01
2.4067000E+03	5.1249000E-01	8.0495000E-01	4.1253000E-01	6.7422000E-01
2.4068000E+03	5.1796000E-01	8.0490000E-01	4.1691000E-01	6.8138000E-01
2.4069000E+03	5.2336000E-01	8.0485000E-01	4.2123000E-01	6.8844000E-01
2.4070000E+03	5.2869000E-01	8.0480000E-01	4.2549000E-01	6.9540000E-01

2.4071000E+03	5.3394000E-01	8.0476000E-01	4.2969000E-01	7.0226000E-01
2.4072000E+03	5.3910000E-01	8.0471000E-01	4.3382000E-01	7.0902000E-01
2.4073000E+03	5.4419000E-01	8.0467000E-01	4.3789000E-01	7.1567000E-01
2.4074000E+03	5.4919000E-01	8.0463000E-01	4.4190000E-01	7.2222000E-01
2.4075000E+03	5.5411000E-01	8.0459000E-01	4.4583000E-01	7.2865000E-01
2.4076000E+03	5.5895000E-01	8.0454000E-01	4.4970000E-01	7.3497000E-01
2.4077000E+03	5.6369000E-01	8.0450000E-01	4.5349000E-01	7.4117000E-01
2.4078000E+03	5.6835000E-01	8.0446000E-01	4.5722000E-01	7.4726000E-01
2.4079000E+03	5.7293000E-01	8.0442000E-01	4.6087000E-01	7.5323000E-01
2.4080000E+03	5.7741000E-01	8.0438000E-01	4.6445000E-01	7.5908000E-01
2.4081000E+03	5.8180000E-01	8.0435000E-01	4.6797000E-01	7.6483000E-01
2.4082000E+03	5.8610000E-01	8.0432000E-01	4.7141000E-01	7.7046000E-01
2.4083000E+03	5.9031000E-01	8.0429000E-01	4.7479000E-01	7.7597000E-01
2.4084000E+03	5.9443000E-01	8.0427000E-01	4.7808000E-01	7.8136000E-01
2.4085000E+03	5.9846000E-01	8.0424000E-01	4.8131000E-01	7.8663000E-01
2.4086000E+03	6.0240000E-01	8.0421000E-01	4.8446000E-01	7.9178000E-01
2.4087000E+03	6.0625000E-01	8.0419000E-01	4.8754000E-01	7.9681000E-01
2.4088000E+03	6.1000000E-01	8.0416000E-01	4.9054000E-01	8.0172000E-01
2.4089000E+03	6.1367000E-01	8.0413000E-01	4.9347000E-01	8.0651000E-01
2.4090000E+03	6.1725000E-01	8.0411000E-01	4.9633000E-01	8.1119000E-01
2.4091000E+03	6.2073000E-01	8.0408000E-01	4.9912000E-01	8.1574000E-01
2.4092000E+03	6.2414000E-01	8.0405000E-01	5.0184000E-01	8.2018000E-01
2.4093000E+03	6.2745000E-01	8.0402000E-01	5.0448000E-01	8.2450000E-01
2.4094000E+03	6.3067000E-01	8.0399000E-01	5.0705000E-01	8.2871000E-01
2.4095000E+03	6.3381000E-01	8.0396000E-01	5.0956000E-01	8.3281000E-01
2.4096000E+03	6.3687000E-01	8.0393000E-01	5.1200000E-01	8.3679000E-01
2.4097000E+03	6.3985000E-01	8.0390000E-01	5.1437000E-01	8.4067000E-01
2.4098000E+03	6.4274000E-01	8.0387000E-01	5.1668000E-01	8.4444000E-01
2.4099000E+03	6.4555000E-01	8.0384000E-01	5.1892000E-01	8.4810000E-01
2.4100000E+03	6.4829000E-01	8.0381000E-01	5.2110000E-01	8.5167000E-01
2.4101000E+03	6.5095000E-01	8.0378000E-01	5.2321000E-01	8.5512000E-01
2.4102000E+03	6.5353000E-01	8.0374000E-01	5.2527000E-01	8.5847000E-01
2.4103000E+03	6.5604000E-01	8.0370000E-01	5.2726000E-01	8.6173000E-01
2.4104000E+03	6.5848000E-01	8.0366000E-01	5.2919000E-01	8.6489000E-01
2.4105000E+03	6.6085000E-01	8.0362000E-01	5.3107000E-01	8.6796000E-01
2.4106000E+03	6.6315000E-01	8.0359000E-01	5.3290000E-01	8.7095000E-01
2.4107000E+03	6.6539000E-01	8.0355000E-01	5.3467000E-01	8.7384000E-01
2.4108000E+03	6.6756000E-01	8.0351000E-01	5.3639000E-01	8.7665000E-01
2.4109000E+03	6.6967000E-01	8.0347000E-01	5.3806000E-01	8.7939000E-01
2.4110000E+03	6.7172000E-01	8.0344000E-01	5.3969000E-01	8.8204000E-01
2.4111000E+03	6.7372000E-01	8.0339000E-01	5.4126000E-01	8.8461000E-01
2.4112000E+03	6.7566000E-01	8.0335000E-01	5.4279000E-01	8.8711000E-01
2.4113000E+03	6.7755000E-01	8.0331000E-01	5.4428000E-01	8.8955000E-01

2.4114000E+03	6.7938000E-01	8.0327000E-01	5.4572000E-01	8.9191000E-01
2.4115000E+03	6.8117000E-01	8.0322000E-01	5.4713000E-01	8.9421000E-01
2.4116000E+03	6.8291000E-01	8.0318000E-01	5.4850000E-01	8.9645000E-01
2.4117000E+03	6.8461000E-01	8.0314000E-01	5.4984000E-01	8.9863000E-01
2.4118000E+03	6.8626000E-01	8.0310000E-01	5.5114000E-01	9.0075000E-01
2.4119000E+03	6.8788000E-01	8.0305000E-01	5.5240000E-01	9.0282000E-01
2.4120000E+03	6.8945000E-01	8.0301000E-01	5.5364000E-01	9.0485000E-01
2.4121000E+03	6.9100000E-01	8.0298000E-01	5.5485000E-01	9.0683000E-01
2.4122000E+03	6.9250000E-01	8.0294000E-01	5.5604000E-01	9.0877000E-01
2.4123000E+03	6.9398000E-01	8.0291000E-01	5.5720000E-01	9.1066000E-01
2.4124000E+03	6.9542000E-01	8.0287000E-01	5.5834000E-01	9.1252000E-01
2.4125000E+03	6.9684000E-01	8.0284000E-01	5.5945000E-01	9.1434000E-01
2.4126000E+03	6.9823000E-01	8.0280000E-01	5.6054000E-01	9.1613000E-01
2.4127000E+03	6.9960000E-01	8.0277000E-01	5.6162000E-01	9.1788000E-01
2.4128000E+03	7.0094000E-01	8.0274000E-01	5.6267000E-01	9.1961000E-01
2.4129000E+03	7.0227000E-01	8.0270000E-01	5.6371000E-01	9.2130000E-01
2.4130000E+03	7.0357000E-01	8.0267000E-01	5.6473000E-01	9.2297000E-01
2.4131000E+03	7.0485000E-01	8.0263000E-01	5.6574000E-01	9.2462000E-01
2.4132000E+03	7.0612000E-01	8.0260000E-01	5.6674000E-01	9.2625000E-01
2.4133000E+03	7.0738000E-01	8.0257000E-01	5.6772000E-01	9.2786000E-01
2.4134000E+03	7.0862000E-01	8.0254000E-01	5.6869000E-01	9.2945000E-01
2.4135000E+03	7.0985000E-01	8.0250000E-01	5.6966000E-01	9.3102000E-01
2.4136000E+03	7.1107000E-01	8.0247000E-01	5.7061000E-01	9.3258000E-01
2.4137000E+03	7.1227000E-01	8.0244000E-01	5.7156000E-01	9.3413000E-01
2.4138000E+03	7.1347000E-01	8.0241000E-01	5.7249000E-01	9.3566000E-01
2.4139000E+03	7.1466000E-01	8.0237000E-01	5.7343000E-01	9.3719000E-01
2.4140000E+03	7.1585000E-01	8.0234000E-01	5.7435000E-01	9.3870000E-01
2.4141000E+03	7.1703000E-01	8.0231000E-01	5.7528000E-01	9.4021000E-01
2.4142000E+03	7.1820000E-01	8.0227000E-01	5.7619000E-01	9.4170000E-01
2.4143000E+03	7.1937000E-01	8.0224000E-01	5.7711000E-01	9.4320000E-01
2.4144000E+03	7.2053000E-01	8.0221000E-01	5.7801000E-01	9.4468000E-01
2.4145000E+03	7.2169000E-01	8.0218000E-01	5.7892000E-01	9.4616000E-01
2.4146000E+03	7.2284000E-01	8.0214000E-01	5.7982000E-01	9.4764000E-01
2.4147000E+03	7.2400000E-01	8.0211000E-01	5.8073000E-01	9.4911000E-01
2.4148000E+03	7.2515000E-01	8.0208000E-01	5.8162000E-01	9.5058000E-01
2.4149000E+03	7.2629000E-01	8.0204000E-01	5.8252000E-01	9.5204000E-01
2.4150000E+03	7.2744000E-01	8.0201000E-01	5.8341000E-01	9.5351000E-01
2.4151000E+03	7.2858000E-01	8.0198000E-01	5.8430000E-01	9.5496000E-01
2.4152000E+03	7.2972000E-01	8.0194000E-01	5.8519000E-01	9.5641000E-01
2.4153000E+03	7.3085000E-01	8.0191000E-01	5.8608000E-01	9.5786000E-01
2.4154000E+03	7.3198000E-01	8.0188000E-01	5.8696000E-01	9.5930000E-01
2.4155000E+03	7.3311000E-01	8.0184000E-01	5.8784000E-01	9.6074000E-01
2.4156000E+03	7.3424000E-01	8.0181000E-01	5.8872000E-01	9.6218000E-01

2.4157000E+03	7.3536000E-01	8.0178000E-01	5.8959000E-01	9.6360000E-01
2.4158000E+03	7.3647000E-01	8.0174000E-01	5.9046000E-01	9.6502000E-01
2.4159000E+03	7.3758000E-01	8.0171000E-01	5.9132000E-01	9.6643000E-01
2.4160000E+03	7.3868000E-01	8.0168000E-01	5.9218000E-01	9.6784000E-01
2.4161000E+03	7.3978000E-01	8.0162000E-01	5.9302000E-01	9.6920000E-01
2.4162000E+03	7.4086000E-01	8.0156000E-01	5.9384000E-01	9.7055000E-01
2.4163000E+03	7.4194000E-01	8.0150000E-01	5.9466000E-01	9.7189000E-01
2.4164000E+03	7.4301000E-01	8.0144000E-01	5.9548000E-01	9.7322000E-01
2.4165000E+03	7.4407000E-01	8.0138000E-01	5.9628000E-01	9.7453000E-01
2.4166000E+03	7.4512000E-01	8.0132000E-01	5.9707000E-01	9.7583000E-01
2.4167000E+03	7.4615000E-01	8.0126000E-01	5.9786000E-01	9.7711000E-01
2.4168000E+03	7.4717000E-01	8.0120000E-01	5.9863000E-01	9.7838000E-01
2.4169000E+03	7.4818000E-01	8.0114000E-01	5.9939000E-01	9.7962000E-01
2.4170000E+03	7.4917000E-01	8.0108000E-01	6.0014000E-01	9.8084000E-01
2.4171000E+03	7.5014000E-01	8.0101000E-01	6.0087000E-01	9.8204000E-01
2.4172000E+03	7.5110000E-01	8.0095000E-01	6.0159000E-01	9.8322000E-01
2.4173000E+03	7.5203000E-01	8.0089000E-01	6.0230000E-01	9.8437000E-01
2.4174000E+03	7.5295000E-01	8.0083000E-01	6.0299000E-01	9.8549000E-01
2.4175000E+03	7.5384000E-01	8.0077000E-01	6.0366000E-01	9.8659000E-01
2.4176000E+03	7.5471000E-01	8.0071000E-01	6.0431000E-01	9.8765000E-01
2.4177000E+03	7.5555000E-01	8.0065000E-01	6.0494000E-01	9.8868000E-01
2.4178000E+03	7.5637000E-01	8.0059000E-01	6.0555000E-01	9.8968000E-01
2.4179000E+03	7.5717000E-01	8.0053000E-01	6.0614000E-01	9.9064000E-01
2.4180000E+03	7.5793000E-01	8.0047000E-01	6.0670000E-01	9.9157000E-01
2.4181000E+03	7.5867000E-01	8.0042000E-01	6.0725000E-01	9.9246000E-01
2.4182000E+03	7.5937000E-01	8.0036000E-01	6.0777000E-01	9.9331000E-01
2.4183000E+03	7.6004000E-01	8.0030000E-01	6.0826000E-01	9.9412000E-01
2.4184000E+03	7.6068000E-01	8.0025000E-01	6.0873000E-01	9.9488000E-01
2.4185000E+03	7.6128000E-01	8.0019000E-01	6.0917000E-01	9.9560000E-01
2.4186000E+03	7.6184000E-01	8.0014000E-01	6.0958000E-01	9.9627000E-01
2.4187000E+03	7.6237000E-01	8.0008000E-01	6.0996000E-01	9.9689000E-01
2.4188000E+03	7.6286000E-01	8.0002000E-01	6.1031000E-01	9.9746000E-01
2.4189000E+03	7.6331000E-01	7.9997000E-01	6.1062000E-01	9.9798000E-01
2.4190000E+03	7.6372000E-01	7.9991000E-01	6.1091000E-01	9.9844000E-01
2.4191000E+03	7.6408000E-01	7.9985000E-01	6.1115000E-01	9.9884000E-01
2.4192000E+03	7.6441000E-01	7.9979000E-01	6.1136000E-01	9.9918000E-01
2.4193000E+03	7.6468000E-01	7.9972000E-01	6.1154000E-01	9.9947000E-01
2.4194000E+03	7.6492000E-01	7.9966000E-01	6.1167000E-01	9.9970000E-01
2.4195000E+03	7.6510000E-01	7.9960000E-01	6.1178000E-01	9.9986000E-01
2.4196000E+03	7.6524000E-01	7.9954000E-01	6.1184000E-01	9.9996000E-01
2.4197000E+03	7.6533000E-01	7.9947000E-01	6.1186000E-01	1.0000000E+00
2.4198000E+03	7.6537000E-01	7.9941000E-01	6.1184000E-01	9.9997000E-01
2.4199000E+03	7.6536000E-01	7.9935000E-01	6.1179000E-01	9.9988000E-01

2.420000E+03	7.652900E-01	7.992900E-01	6.116900E-01	9.997200E-01
2.420100E+03	7.651800E-01	7.992200E-01	6.115500E-01	9.994900E-01
2.420200E+03	7.650100E-01	7.991500E-01	6.113600E-01	9.991800E-01
2.420300E+03	7.647900E-01	7.990900E-01	6.111300E-01	9.988100E-01
2.420400E+03	7.645100E-01	7.990200E-01	6.108600E-01	9.983600E-01
2.420500E+03	7.641800E-01	7.989600E-01	6.105400E-01	9.978500E-01
2.420600E+03	7.637900E-01	7.988900E-01	6.101800E-01	9.972600E-01
2.420700E+03	7.633400E-01	7.988200E-01	6.097800E-01	9.965900E-01
2.420800E+03	7.628400E-01	7.987600E-01	6.093200E-01	9.958500E-01
2.420900E+03	7.622800E-01	7.986900E-01	6.088300E-01	9.950400E-01
2.421000E+03	7.616600E-01	7.986200E-01	6.082800E-01	9.941500E-01
2.421100E+03	7.609900E-01	7.985600E-01	6.076900E-01	9.931800E-01
2.421200E+03	7.602500E-01	7.984900E-01	6.070500E-01	9.921400E-01
2.421300E+03	7.594600E-01	7.984200E-01	6.063700E-01	9.910200E-01
2.421400E+03	7.586000E-01	7.983600E-01	6.056300E-01	9.898200E-01
2.421500E+03	7.576900E-01	7.982900E-01	6.048500E-01	9.885500E-01
2.421600E+03	7.567200E-01	7.982200E-01	6.040300E-01	9.871900E-01
2.421700E+03	7.556800E-01	7.981500E-01	6.031500E-01	9.857600E-01
2.421800E+03	7.545900E-01	7.980900E-01	6.022300E-01	9.842600E-01
2.421900E+03	7.534400E-01	7.980200E-01	6.012600E-01	9.826700E-01
2.422000E+03	7.522200E-01	7.979500E-01	6.002400E-01	9.810000E-01
2.422100E+03	7.509500E-01	7.978800E-01	5.991600E-01	9.792500E-01
2.422200E+03	7.496100E-01	7.978000E-01	5.980400E-01	9.774200E-01
2.422300E+03	7.482200E-01	7.977300E-01	5.968700E-01	9.755000E-01
2.422400E+03	7.467700E-01	7.976500E-01	5.956600E-01	9.735200E-01
2.422500E+03	7.452500E-01	7.975700E-01	5.943900E-01	9.714500E-01
2.422600E+03	7.436800E-01	7.975000E-01	5.930800E-01	9.693100E-01
2.422700E+03	7.420400E-01	7.974200E-01	5.917200E-01	9.670900E-01
2.422800E+03	7.403500E-01	7.973500E-01	5.903200E-01	9.647900E-01
2.422900E+03	7.386000E-01	7.973000E-01	5.888800E-01	9.624500E-01
2.423000E+03	7.367900E-01	7.972400E-01	5.874000E-01	9.600200E-01
2.423100E+03	7.349200E-01	7.971900E-01	5.858700E-01	9.575300E-01
2.423200E+03	7.329900E-01	7.971400E-01	5.843000E-01	9.549600E-01
2.423300E+03	7.310100E-01	7.970900E-01	5.826800E-01	9.523100E-01
2.423400E+03	7.289700E-01	7.970400E-01	5.810200E-01	9.495900E-01
2.423500E+03	7.268700E-01	7.969900E-01	5.793100E-01	9.468000E-01
2.423600E+03	7.247200E-01	7.969400E-01	5.775600E-01	9.439400E-01
2.423700E+03	7.225100E-01	7.968900E-01	5.757600E-01	9.410000E-01
2.423800E+03	7.202400E-01	7.968400E-01	5.739200E-01	9.379900E-01
2.423900E+03	7.179200E-01	7.967900E-01	5.720300E-01	9.349100E-01
2.424000E+03	7.155400E-01	7.967400E-01	5.701100E-01	9.317600E-01
2.424100E+03	7.131100E-01	7.967300E-01	5.681600E-01	9.285700E-01
2.424200E+03	7.106300E-01	7.967100E-01	5.661700E-01	9.253200E-01

2.4243000E+03	7.0810000E-01	7.9669000E-01	5.6413000E-01	9.2199000E-01
2.4244000E+03	7.0551000E-01	7.9667000E-01	5.6206000E-01	9.1860000E-01
2.4245000E+03	7.0287000E-01	7.9665000E-01	5.5994000E-01	9.1515000E-01
2.4246000E+03	7.0018000E-01	7.9663000E-01	5.5778000E-01	9.1162000E-01
2.4247000E+03	6.9744000E-01	7.9661000E-01	5.5559000E-01	9.0803000E-01
2.4248000E+03	6.9465000E-01	7.9659000E-01	5.5335000E-01	9.0437000E-01
2.4249000E+03	6.9181000E-01	7.9657000E-01	5.5108000E-01	9.0065000E-01
2.4250000E+03	6.8892000E-01	7.9655000E-01	5.4876000E-01	8.9687000E-01
2.4251000E+03	6.8598000E-01	7.9654000E-01	5.4641000E-01	8.9303000E-01
2.4252000E+03	6.8299000E-01	7.9652000E-01	5.4402000E-01	8.8912000E-01
2.4253000E+03	6.7996000E-01	7.9650000E-01	5.4159000E-01	8.8515000E-01
2.4254000E+03	6.7688000E-01	7.9649000E-01	5.3913000E-01	8.8113000E-01
2.4255000E+03	6.7376000E-01	7.9647000E-01	5.3663000E-01	8.7704000E-01
2.4256000E+03	6.7058000E-01	7.9645000E-01	5.3409000E-01	8.7289000E-01
2.4257000E+03	6.6737000E-01	7.9643000E-01	5.3152000E-01	8.6869000E-01
2.4258000E+03	6.6411000E-01	7.9642000E-01	5.2891000E-01	8.6442000E-01
2.4259000E+03	6.6080000E-01	7.9640000E-01	5.2626000E-01	8.6010000E-01
2.4260000E+03	6.5746000E-01	7.9638000E-01	5.2359000E-01	8.5573000E-01
2.4261000E+03	6.5407000E-01	7.9633000E-01	5.2086000E-01	8.5127000E-01
2.4262000E+03	6.5064000E-01	7.9628000E-01	5.1809000E-01	8.4675000E-01
2.4263000E+03	6.4717000E-01	7.9624000E-01	5.1530000E-01	8.4218000E-01
2.4264000E+03	6.4365000E-01	7.9619000E-01	5.1247000E-01	8.3755000E-01
2.4265000E+03	6.4010000E-01	7.9614000E-01	5.0961000E-01	8.3288000E-01
2.4266000E+03	6.3650000E-01	7.9609000E-01	5.0671000E-01	8.2815000E-01
2.4267000E+03	6.3287000E-01	7.9604000E-01	5.0379000E-01	8.2338000E-01
2.4268000E+03	6.2920000E-01	7.9599000E-01	5.0084000E-01	8.1855000E-01
2.4269000E+03	6.2549000E-01	7.9594000E-01	4.9786000E-01	8.1367000E-01
2.4270000E+03	6.2174000E-01	7.9589000E-01	4.9484000E-01	8.0875000E-01
2.4271000E+03	6.1796000E-01	7.9584000E-01	4.9180000E-01	8.0377000E-01
2.4272000E+03	6.1414000E-01	7.9579000E-01	4.8873000E-01	7.9875000E-01
2.4273000E+03	6.1029000E-01	7.9573000E-01	4.8562000E-01	7.9368000E-01
2.4274000E+03	6.0640000E-01	7.9568000E-01	4.8250000E-01	7.8857000E-01
2.4275000E+03	6.0247000E-01	7.9562000E-01	4.7934000E-01	7.8341000E-01
2.4276000E+03	5.9851000E-01	7.9557000E-01	4.7616000E-01	7.7821000E-01
2.4277000E+03	5.9452000E-01	7.9552000E-01	4.7295000E-01	7.7297000E-01
2.4278000E+03	5.9049000E-01	7.9546000E-01	4.6972000E-01	7.6768000E-01
2.4279000E+03	5.8643000E-01	7.9541000E-01	4.6646000E-01	7.6236000E-01
2.4280000E+03	5.8234000E-01	7.9536000E-01	4.6317000E-01	7.5699000E-01
2.4281000E+03	5.7822000E-01	7.9531000E-01	4.5987000E-01	7.5159000E-01
2.4282000E+03	5.7407000E-01	7.9527000E-01	4.5654000E-01	7.4615000E-01
2.4283000E+03	5.6989000E-01	7.9522000E-01	4.5319000E-01	7.4067000E-01
2.4284000E+03	5.6568000E-01	7.9518000E-01	4.4982000E-01	7.3516000E-01
2.4285000E+03	5.6144000E-01	7.9514000E-01	4.4642000E-01	7.2961000E-01

2.4286000E+03	5.5717000E-01	7.9509000E-01	4.4300000E-01	7.2402000E-01
2.4287000E+03	5.5287000E-01	7.9505000E-01	4.3956000E-01	7.1840000E-01
2.4288000E+03	5.4855000E-01	7.9501000E-01	4.3610000E-01	7.1275000E-01
2.4289000E+03	5.4421000E-01	7.9497000E-01	4.3262000E-01	7.0706000E-01
2.4290000E+03	5.3983000E-01	7.9492000E-01	4.2912000E-01	7.0134000E-01
2.4291000E+03	5.3543000E-01	7.9489000E-01	4.2561000E-01	6.9559000E-01
2.4292000E+03	5.3101000E-01	7.9485000E-01	4.2207000E-01	6.8982000E-01
2.4293000E+03	5.2656000E-01	7.9481000E-01	4.1852000E-01	6.8401000E-01
2.4294000E+03	5.2210000E-01	7.9477000E-01	4.1494000E-01	6.7817000E-01
2.4295000E+03	5.1760000E-01	7.9473000E-01	4.1135000E-01	6.7230000E-01
2.4296000E+03	5.1309000E-01	7.9469000E-01	4.0775000E-01	6.6641000E-01
2.4297000E+03	5.0856000E-01	7.9465000E-01	4.0413000E-01	6.6049000E-01
2.4298000E+03	5.0401000E-01	7.9461000E-01	4.0049000E-01	6.5455000E-01
2.4299000E+03	4.9944000E-01	7.9457000E-01	3.9684000E-01	6.4858000E-01
2.4300000E+03	4.9485000E-01	7.9453000E-01	3.9317000E-01	6.4259000E-01
2.4301000E+03	4.9024000E-01	7.9450000E-01	3.8950000E-01	6.3658000E-01
2.4302000E+03	4.8562000E-01	7.9447000E-01	3.8581000E-01	6.3055000E-01
2.4303000E+03	4.8098000E-01	7.9443000E-01	3.8211000E-01	6.2450000E-01
2.4304000E+03	4.7633000E-01	7.9440000E-01	3.7840000E-01	6.1843000E-01
2.4305000E+03	4.7166000E-01	7.9436000E-01	3.7467000E-01	6.1235000E-01
2.4306000E+03	4.6699000E-01	7.9433000E-01	3.7094000E-01	6.0625000E-01
2.4307000E+03	4.6229000E-01	7.9429000E-01	3.6720000E-01	6.0013000E-01
2.4308000E+03	4.5759000E-01	7.9426000E-01	3.6345000E-01	5.9400000E-01
2.4309000E+03	4.5288000E-01	7.9423000E-01	3.5969000E-01	5.8786000E-01
2.4310000E+03	4.4816000E-01	7.9419000E-01	3.5593000E-01	5.8171000E-01
2.4311000E+03	4.4343000E-01	7.9416000E-01	3.5216000E-01	5.7555000E-01
2.4312000E+03	4.3870000E-01	7.9413000E-01	3.4838000E-01	5.6938000E-01
2.4313000E+03	4.3395000E-01	7.9410000E-01	3.4460000E-01	5.6321000E-01
2.4314000E+03	4.2921000E-01	7.9407000E-01	3.4082000E-01	5.5703000E-01
2.4315000E+03	4.2446000E-01	7.9404000E-01	3.3704000E-01	5.5084000E-01
2.4316000E+03	4.1970000E-01	7.9402000E-01	3.3325000E-01	5.4465000E-01
2.4317000E+03	4.1495000E-01	7.9399000E-01	3.2946000E-01	5.3846000E-01
2.4318000E+03	4.1019000E-01	7.9396000E-01	3.2567000E-01	5.3226000E-01
2.4319000E+03	4.0543000E-01	7.9393000E-01	3.2188000E-01	5.2607000E-01
2.4320000E+03	4.0067000E-01	7.9390000E-01	3.1810000E-01	5.1988000E-01
2.4321000E+03	3.9592000E-01	7.9387000E-01	3.1431000E-01	5.1369000E-01
2.4322000E+03	3.9117000E-01	7.9383000E-01	3.1052000E-01	5.0751000E-01
2.4323000E+03	3.8642000E-01	7.9380000E-01	3.0674000E-01	5.0133000E-01
2.4324000E+03	3.8168000E-01	7.9377000E-01	3.0297000E-01	4.9516000E-01
2.4325000E+03	3.7695000E-01	7.9374000E-01	2.9920000E-01	4.8900000E-01
2.4326000E+03	3.7222000E-01	7.9370000E-01	2.9543000E-01	4.8284000E-01
2.4327000E+03	3.6750000E-01	7.9367000E-01	2.9168000E-01	4.7670000E-01
2.4328000E+03	3.6279000E-01	7.9364000E-01	2.8793000E-01	4.7058000E-01

2.4329000E+03	3.5810000E-01	7.9361000E-01	2.8419000E-01	4.6446000E-01
2.4330000E+03	3.5341000E-01	7.9357000E-01	2.8046000E-01	4.5837000E-01
2.4331000E+03	3.4874000E-01	7.9354000E-01	2.7674000E-01	4.5229000E-01
2.4332000E+03	3.4408000E-01	7.9351000E-01	2.7303000E-01	4.4623000E-01
2.4333000E+03	3.3943000E-01	7.9348000E-01	2.6933000E-01	4.4019000E-01
2.4334000E+03	3.3480000E-01	7.9345000E-01	2.6565000E-01	4.3417000E-01
2.4335000E+03	3.3019000E-01	7.9342000E-01	2.6198000E-01	4.2817000E-01
2.4336000E+03	3.2560000E-01	7.9339000E-01	2.5833000E-01	4.2220000E-01
2.4337000E+03	3.2102000E-01	7.9336000E-01	2.5469000E-01	4.1625000E-01
2.4338000E+03	3.1647000E-01	7.9333000E-01	2.5106000E-01	4.1033000E-01
2.4339000E+03	3.1194000E-01	7.9329000E-01	2.4746000E-01	4.0443000E-01
2.4340000E+03	3.0742000E-01	7.9326000E-01	2.4387000E-01	3.9857000E-01
2.4341000E+03	3.0294000E-01	7.9326000E-01	2.4031000E-01	3.9275000E-01
2.4342000E+03	2.9847000E-01	7.9325000E-01	2.3676000E-01	3.8695000E-01
2.4343000E+03	2.9403000E-01	7.9324000E-01	2.3324000E-01	3.8119000E-01
2.4344000E+03	2.8962000E-01	7.9323000E-01	2.2973000E-01	3.7546000E-01
2.4345000E+03	2.8523000E-01	7.9323000E-01	2.2625000E-01	3.6977000E-01
2.4346000E+03	2.8087000E-01	7.9322000E-01	2.2279000E-01	3.6412000E-01
2.4347000E+03	2.7653000E-01	7.9321000E-01	2.1935000E-01	3.5849000E-01
2.4348000E+03	2.7223000E-01	7.9320000E-01	2.1593000E-01	3.5291000E-01
2.4349000E+03	2.6796000E-01	7.9320000E-01	2.1254000E-01	3.4737000E-01
2.4350000E+03	2.6371000E-01	7.9319000E-01	2.0917000E-01	3.4186000E-01
2.4351000E+03	2.5950000E-01	7.9318000E-01	2.0583000E-01	3.3640000E-01
2.4352000E+03	2.5532000E-01	7.9317000E-01	2.0251000E-01	3.3098000E-01
2.4353000E+03	2.5117000E-01	7.9316000E-01	1.9922000E-01	3.2560000E-01
2.4354000E+03	2.4706000E-01	7.9316000E-01	1.9595000E-01	3.2026000E-01
2.4355000E+03	2.4298000E-01	7.9315000E-01	1.9272000E-01	3.1497000E-01
2.4356000E+03	2.3893000E-01	7.9314000E-01	1.8950000E-01	3.0972000E-01
2.4357000E+03	2.3492000E-01	7.9313000E-01	1.8632000E-01	3.0452000E-01
2.4358000E+03	2.3095000E-01	7.9312000E-01	1.8317000E-01	2.9936000E-01
2.4359000E+03	2.2701000E-01	7.9311000E-01	1.8004000E-01	2.9425000E-01
2.4360000E+03	2.2310000E-01	7.9311000E-01	1.7695000E-01	2.8919000E-01
2.4361000E+03	2.1924000E-01	7.9311000E-01	1.7388000E-01	2.8419000E-01
2.4362000E+03	2.1542000E-01	7.9312000E-01	1.7085000E-01	2.7923000E-01
2.4363000E+03	2.1163000E-01	7.9313000E-01	1.6785000E-01	2.7432000E-01
2.4364000E+03	2.0788000E-01	7.9314000E-01	1.6488000E-01	2.6947000E-01
2.4365000E+03	2.0417000E-01	7.9315000E-01	1.6194000E-01	2.6466000E-01
2.4366000E+03	2.0050000E-01	7.9316000E-01	1.5903000E-01	2.5991000E-01
2.4367000E+03	1.9687000E-01	7.9316000E-01	1.5615000E-01	2.5520000E-01
2.4368000E+03	1.9328000E-01	7.9317000E-01	1.5330000E-01	2.5055000E-01
2.4369000E+03	1.8973000E-01	7.9318000E-01	1.5049000E-01	2.4595000E-01
2.4370000E+03	1.8622000E-01	7.9319000E-01	1.4771000E-01	2.4141000E-01
2.4371000E+03	1.8275000E-01	7.9320000E-01	1.4496000E-01	2.3692000E-01

2.4372000E+03	1.7933000E-01	7.9320000E-01	1.4224000E-01	2.3248000E-01
2.4373000E+03	1.7595000E-01	7.9321000E-01	1.3956000E-01	2.2809000E-01
2.4374000E+03	1.7260000E-01	7.9321000E-01	1.3691000E-01	2.2376000E-01
2.4375000E+03	1.6930000E-01	7.9322000E-01	1.3429000E-01	2.1949000E-01
2.4376000E+03	1.6605000E-01	7.9322000E-01	1.3171000E-01	2.1526000E-01
2.4377000E+03	1.6283000E-01	7.9323000E-01	1.2916000E-01	2.1110000E-01
2.4378000E+03	1.5966000E-01	7.9323000E-01	1.2665000E-01	2.0698000E-01
2.4379000E+03	1.5653000E-01	7.9324000E-01	1.2416000E-01	2.0293000E-01
2.4380000E+03	1.5344000E-01	7.9324000E-01	1.2172000E-01	1.9893000E-01
2.4381000E+03	1.5040000E-01	7.9323000E-01	1.1930000E-01	1.9498000E-01
2.4382000E+03	1.4739000E-01	7.9322000E-01	1.1691000E-01	1.9108000E-01
2.4383000E+03	1.4443000E-01	7.9320000E-01	1.1457000E-01	1.8724000E-01
2.4384000E+03	1.4152000E-01	7.9319000E-01	1.1225000E-01	1.8346000E-01
2.4385000E+03	1.3864000E-01	7.9318000E-01	1.0997000E-01	1.7973000E-01
2.4386000E+03	1.3581000E-01	7.9317000E-01	1.0772000E-01	1.7606000E-01
2.4387000E+03	1.3302000E-01	7.9315000E-01	1.0551000E-01	1.7244000E-01
2.4388000E+03	1.3028000E-01	7.9314000E-01	1.0333000E-01	1.6888000E-01
2.4389000E+03	1.2757000E-01	7.9313000E-01	1.0118000E-01	1.6537000E-01
2.4390000E+03	1.2491000E-01	7.9312000E-01	9.9071000E-02	1.6192000E-01
2.4391000E+03	1.2229000E-01	7.9310000E-01	9.6992000E-02	1.5852000E-01
2.4392000E+03	1.1972000E-01	7.9309000E-01	9.4948000E-02	1.5518000E-01
2.4393000E+03	1.1718000E-01	7.9307000E-01	9.2936000E-02	1.5189000E-01
2.4394000E+03	1.1469000E-01	7.9306000E-01	9.0958000E-02	1.4866000E-01
2.4395000E+03	1.1224000E-01	7.9305000E-01	8.9013000E-02	1.4548000E-01
2.4396000E+03	1.0983000E-01	7.9303000E-01	8.7101000E-02	1.4235000E-01
2.4397000E+03	1.0746000E-01	7.9302000E-01	8.5221000E-02	1.3928000E-01
2.4398000E+03	1.0514000E-01	7.9301000E-01	8.3375000E-02	1.3626000E-01
2.4399000E+03	1.0285000E-01	7.9299000E-01	8.1561000E-02	1.3330000E-01
2.4400000E+03	1.0061000E-01	7.9298000E-01	7.9779000E-02	1.3039000E-01
2.4401000E+03	9.8402000E-02	7.9295000E-01	7.8027000E-02	1.2752000E-01
2.4402000E+03	9.6237000E-02	7.9291000E-01	7.6307000E-02	1.2471000E-01
2.4403000E+03	9.4112000E-02	7.9288000E-01	7.4619000E-02	1.2195000E-01
2.4404000E+03	9.2026000E-02	7.9285000E-01	7.2962000E-02	1.1925000E-01
2.4405000E+03	8.9979000E-02	7.9281000E-01	7.1337000E-02	1.1659000E-01
2.4406000E+03	8.7972000E-02	7.9278000E-01	6.9742000E-02	1.1398000E-01
2.4407000E+03	8.6003000E-02	7.9275000E-01	6.8179000E-02	1.1143000E-01
2.4408000E+03	8.4072000E-02	7.9271000E-01	6.6645000E-02	1.0892000E-01
2.4409000E+03	8.2179000E-02	7.9268000E-01	6.5142000E-02	1.0646000E-01
2.4410000E+03	8.0324000E-02	7.9265000E-01	6.3668000E-02	1.0406000E-01
2.4411000E+03	7.8505000E-02	7.9261000E-01	6.2224000E-02	1.0170000E-01
2.4412000E+03	7.6723000E-02	7.9257000E-01	6.0809000E-02	9.9383000E-02
2.4413000E+03	7.4978000E-02	7.9254000E-01	5.9423000E-02	9.7118000E-02
2.4414000E+03	7.3268000E-02	7.9250000E-01	5.8065000E-02	9.4899000E-02

2.4415000E+03	7.1594000E-02	7.9246000E-01	5.6735000E-02	9.2726000E-02
2.4416000E+03	6.9955000E-02	7.9243000E-01	5.5434000E-02	9.0599000E-02
2.4417000E+03	6.8350000E-02	7.9239000E-01	5.4160000E-02	8.8517000E-02
2.4418000E+03	6.6780000E-02	7.9235000E-01	5.2913000E-02	8.6479000E-02
2.4419000E+03	6.5243000E-02	7.9232000E-01	5.1693000E-02	8.4485000E-02
2.4420000E+03	6.3739000E-02	7.9228000E-01	5.0499000E-02	8.2534000E-02
2.4421000E+03	6.2268000E-02	7.9226000E-01	4.9333000E-02	8.0628000E-02
2.4422000E+03	6.0830000E-02	7.9225000E-01	4.8192000E-02	7.8763000E-02
2.4423000E+03	5.9423000E-02	7.9223000E-01	4.7077000E-02	7.6940000E-02
2.4424000E+03	5.8047000E-02	7.9222000E-01	4.5986000E-02	7.5158000E-02
2.4425000E+03	5.6703000E-02	7.9220000E-01	4.4920000E-02	7.3415000E-02
2.4426000E+03	5.5388000E-02	7.9218000E-01	4.3878000E-02	7.1712000E-02
2.4427000E+03	5.4104000E-02	7.9217000E-01	4.2859000E-02	7.0047000E-02
2.4428000E+03	5.2848000E-02	7.9215000E-01	4.1864000E-02	6.8420000E-02
2.4429000E+03	5.1622000E-02	7.9214000E-01	4.0891000E-02	6.6831000E-02
2.4430000E+03	5.0423000E-02	7.9212000E-01	3.9941000E-02	6.5278000E-02
2.4431000E+03	4.9252000E-02	7.9210000E-01	3.9013000E-02	6.3760000E-02
2.4432000E+03	4.8108000E-02	7.9208000E-01	3.8106000E-02	6.2278000E-02
2.4433000E+03	4.7122000E-02	7.9206000E-01	3.7323000E-02	6.1000000E-02
2.4434000E+03	4.6028000E-02	7.9203000E-01	3.6456000E-02	5.9582000E-02
2.4435000E+03	4.4960000E-02	7.9201000E-01	3.5609000E-02	5.8198000E-02
2.4436000E+03	4.3917000E-02	7.9199000E-01	3.4782000E-02	5.6846000E-02
2.4437000E+03	4.2899000E-02	7.9197000E-01	3.3975000E-02	5.5527000E-02
2.4438000E+03	4.1904000E-02	7.9195000E-01	3.3186000E-02	5.4238000E-02
2.4439000E+03	4.0933000E-02	7.9193000E-01	3.2416000E-02	5.2979000E-02
2.4440000E+03	3.9985000E-02	7.9191000E-01	3.1664000E-02	5.1751000E-02
2.4441000E+03	3.9059000E-02	7.9188000E-01	3.0930000E-02	5.0551000E-02
2.4442000E+03	3.8155000E-02	7.9185000E-01	3.0213000E-02	4.9379000E-02
2.4443000E+03	3.7272000E-02	7.9183000E-01	2.9513000E-02	4.8235000E-02
2.4444000E+03	3.6410000E-02	7.9180000E-01	2.8830000E-02	4.7118000E-02
2.4445000E+03	3.5569000E-02	7.9178000E-01	2.8163000E-02	4.6028000E-02
2.4446000E+03	3.4747000E-02	7.9175000E-01	2.7511000E-02	4.4963000E-02
2.4447000E+03	3.3945000E-02	7.9172000E-01	2.6875000E-02	4.3923000E-02
2.4448000E+03	3.3161000E-02	7.9170000E-01	2.6254000E-02	4.2908000E-02
2.4449000E+03	3.2396000E-02	7.9167000E-01	2.5647000E-02	4.1917000E-02
2.4450000E+03	3.1649000E-02	7.9164000E-01	2.5055000E-02	4.0948000E-02
2.4451000E+03	3.0919000E-02	7.9162000E-01	2.4476000E-02	4.0002000E-02
2.4452000E+03	3.0206000E-02	7.9159000E-01	2.3911000E-02	3.9078000E-02
2.4453000E+03	2.9509000E-02	7.9156000E-01	2.3358000E-02	3.8176000E-02
2.4454000E+03	2.8829000E-02	7.9153000E-01	2.2819000E-02	3.7294000E-02
2.4455000E+03	2.8164000E-02	7.9150000E-01	2.2292000E-02	3.6433000E-02
2.4456000E+03	2.7514000E-02	7.9147000E-01	2.1777000E-02	3.5591000E-02
2.4457000E+03	2.6880000E-02	7.9144000E-01	2.1274000E-02	3.4769000E-02

2.4458000E+03	2.6259000E-02	7.9142000E-01	2.0782000E-02	3.3965000E-02
2.4459000E+03	2.5652000E-02	7.9139000E-01	2.0301000E-02	3.3179000E-02
2.4460000E+03	2.5060000E-02	7.9136000E-01	1.9831000E-02	3.2412000E-02
2.4461000E+03	2.4480000E-02	7.9133000E-01	1.9372000E-02	3.1660000E-02
2.4462000E+03	2.3913000E-02	7.9129000E-01	1.8922000E-02	3.0926000E-02
2.4463000E+03	2.3359000E-02	7.9125000E-01	1.8483000E-02	3.0208000E-02
2.4464000E+03	2.2817000E-02	7.9121000E-01	1.8053000E-02	2.9506000E-02
2.4465000E+03	2.2287000E-02	7.9118000E-01	1.7633000E-02	2.8819000E-02
2.4466000E+03	2.1769000E-02	7.9114000E-01	1.7222000E-02	2.8147000E-02
2.4467000E+03	2.1262000E-02	7.9110000E-01	1.6820000E-02	2.7490000E-02
2.4468000E+03	2.0766000E-02	7.9107000E-01	1.6427000E-02	2.6847000E-02
2.4469000E+03	2.0280000E-02	7.9103000E-01	1.6042000E-02	2.6219000E-02
2.4470000E+03	1.9805000E-02	7.9099000E-01	1.5666000E-02	2.5604000E-02
2.4471000E+03	1.9341000E-02	7.9095000E-01	1.5297000E-02	2.5002000E-02
2.4472000E+03	1.8886000E-02	7.9091000E-01	1.4937000E-02	2.4413000E-02
2.4473000E+03	1.8441000E-02	7.9087000E-01	1.4584000E-02	2.3836000E-02
2.4474000E+03	1.8006000E-02	7.9082000E-01	1.4239000E-02	2.3272000E-02
2.4475000E+03	1.7580000E-02	7.9078000E-01	1.3902000E-02	2.2720000E-02
2.4476000E+03	1.7163000E-02	7.9074000E-01	1.3571000E-02	2.2180000E-02
2.4477000E+03	1.6755000E-02	7.9070000E-01	1.3248000E-02	2.1652000E-02
2.4478000E+03	1.6355000E-02	7.9066000E-01	1.2932000E-02	2.1135000E-02
2.4479000E+03	1.5965000E-02	7.9062000E-01	1.2622000E-02	2.0629000E-02
2.4480000E+03	1.5582000E-02	7.9058000E-01	1.2319000E-02	2.0134000E-02
2.4481000E+03	1.5208000E-02	7.9055000E-01	1.2023000E-02	1.9650000E-02
2.4482000E+03	1.4842000E-02	7.9052000E-01	1.1733000E-02	1.9176000E-02
2.4483000E+03	1.4484000E-02	7.9050000E-01	1.1450000E-02	1.8713000E-02
2.4484000E+03	1.4134000E-02	7.9047000E-01	1.1172000E-02	1.8260000E-02
2.4485000E+03	1.3791000E-02	7.9044000E-01	1.0901000E-02	1.7816000E-02
2.4486000E+03	1.3456000E-02	7.9042000E-01	1.0636000E-02	1.7383000E-02
2.4487000E+03	1.3129000E-02	7.9039000E-01	1.0377000E-02	1.6959000E-02
2.4488000E+03	1.2808000E-02	7.9037000E-01	1.0123000E-02	1.6545000E-02
2.4489000E+03	1.2495000E-02	7.9034000E-01	9.8751000E-03	1.6139000E-02
2.4490000E+03	1.2189000E-02	7.9031000E-01	9.6329000E-03	1.5744000E-02
2.4491000E+03	1.1889000E-02	7.9029000E-01	9.3960000E-03	1.5356000E-02
2.4492000E+03	1.1597000E-02	7.9026000E-01	9.1647000E-03	1.4978000E-02
2.4493000E+03	1.1311000E-02	7.9023000E-01	8.9386000E-03	1.4609000E-02
2.4494000E+03	1.1032000E-02	7.9020000E-01	8.7178000E-03	1.4248000E-02
2.4495000E+03	1.0760000E-02	7.9018000E-01	8.5022000E-03	1.3896000E-02
2.4496000E+03	1.0494000E-02	7.9015000E-01	8.2918000E-03	1.3552000E-02
2.4497000E+03	1.0234000E-02	7.9012000E-01	8.0862000E-03	1.3216000E-02
2.4498000E+03	9.9806000E-03	7.9010000E-01	7.8857000E-03	1.2888000E-02
2.4499000E+03	9.7333000E-03	7.9007000E-01	7.6900000E-03	1.2568000E-02
2.4500000E+03	9.4919000E-03	7.9004000E-01	7.4990000E-03	1.2256000E-02

2.4501000E+03	9.2565000E-03	7.9002000E-01	7.3128000E-03	1.1952000E-02
2.4502000E+03	9.0269000E-03	7.9000000E-01	7.1313000E-03	1.1655000E-02
2.4503000E+03	8.8031000E-03	7.8998000E-01	6.9542000E-03	1.1366000E-02
2.4504000E+03	8.5848000E-03	7.8996000E-01	6.7816000E-03	1.1084000E-02
2.4505000E+03	8.3721000E-03	7.8993000E-01	6.6134000E-03	1.0809000E-02
2.4506000E+03	8.1647000E-03	7.8991000E-01	6.4494000E-03	1.0541000E-02
2.4507000E+03	7.9626000E-03	7.8989000E-01	6.2896000E-03	1.0280000E-02
2.4508000E+03	7.7658000E-03	7.8987000E-01	6.1339000E-03	1.0025000E-02
2.4509000E+03	7.5739000E-03	7.8985000E-01	5.9823000E-03	9.7772000E-03
2.4510000E+03	7.3870000E-03	7.8983000E-01	5.8345000E-03	9.5356000E-03
2.4511000E+03	7.2049000E-03	7.8981000E-01	5.6905000E-03	9.3004000E-03
2.4512000E+03	7.0276000E-03	7.8979000E-01	5.5503000E-03	9.0712000E-03
2.4513000E+03	6.8547000E-03	7.8977000E-01	5.4137000E-03	8.8479000E-03
2.4514000E+03	6.6863000E-03	7.8975000E-01	5.2806000E-03	8.6304000E-03
2.4515000E+03	6.5223000E-03	7.8974000E-01	5.1509000E-03	8.4184000E-03
2.4516000E+03	6.3624000E-03	7.8972000E-01	5.0245000E-03	8.2118000E-03
2.4517000E+03	6.2065000E-03	7.8970000E-01	4.9013000E-03	8.0104000E-03
2.4518000E+03	6.0546000E-03	7.8968000E-01	4.7812000E-03	7.8141000E-03
2.4519000E+03	5.9064000E-03	7.8966000E-01	4.6640000E-03	7.6227000E-03
2.4520000E+03	5.7618000E-03	7.8964000E-01	4.5498000E-03	7.4359000E-03
2.4521000E+03	5.6207000E-03	7.8963000E-01	4.4383000E-03	7.2537000E-03
2.4522000E+03	5.4830000E-03	7.8961000E-01	4.3294000E-03	7.0758000E-03
2.4523000E+03	5.3485000E-03	7.8960000E-01	4.2231000E-03	6.9021000E-03
2.4524000E+03	5.2170000E-03	7.8958000E-01	4.1192000E-03	6.7323000E-03
2.4525000E+03	5.0884000E-03	7.8957000E-01	4.0177000E-03	6.5663000E-03
2.4526000E+03	4.9627000E-03	7.8955000E-01	3.9183000E-03	6.4039000E-03
2.4527000E+03	4.8396000E-03	7.8954000E-01	3.8211000E-03	6.2450000E-03
2.4528000E+03	4.7191000E-03	7.8952000E-01	3.7258000E-03	6.0893000E-03
2.4529000E+03	4.6009000E-03	7.8951000E-01	3.6324000E-03	5.9367000E-03
2.4530000E+03	4.4850000E-03	7.8949000E-01	3.5409000E-03	5.7870000E-03
2.4531000E+03	4.3713000E-03	7.8948000E-01	3.4510000E-03	5.6402000E-03
2.4532000E+03	4.2595000E-03	7.8947000E-01	3.3628000E-03	5.4960000E-03
2.4533000E+03	4.1497000E-03	7.8946000E-01	3.2761000E-03	5.3543000E-03
2.4534000E+03	4.0417000E-03	7.8945000E-01	3.1908000E-03	5.2149000E-03
2.4535000E+03	3.9355000E-03	7.8944000E-01	3.1068000E-03	5.0777000E-03
2.4536000E+03	3.8308000E-03	7.8943000E-01	3.0242000E-03	4.9426000E-03
2.4537000E+03	3.7277000E-03	7.8942000E-01	2.9427000E-03	4.8094000E-03
2.4538000E+03	3.6260000E-03	7.8941000E-01	2.8624000E-03	4.6781000E-03
2.4539000E+03	3.5256000E-03	7.8940000E-01	2.7831000E-03	4.5486000E-03
2.4540000E+03	3.4266000E-03	7.8939000E-01	2.7049000E-03	4.4208000E-03
2.4541000E+03	3.3288000E-03	7.8939000E-01	2.6277000E-03	4.2946000E-03
2.4542000E+03	3.2322000E-03	7.8939000E-01	2.5514000E-03	4.1700000E-03
2.4543000E+03	3.1367000E-03	7.8939000E-01	2.4761000E-03	4.0468000E-03

2.4544000E+03	3.0423000E-03	7.8939000E-01	2.4016000E-03	3.9250000E-03
2.4545000E+03	2.9490000E-03	7.8939000E-01	2.3279000E-03	3.8046000E-03
2.4546000E+03	2.8567000E-03	7.8939000E-01	2.2551000E-03	3.6856000E-03
2.4547000E+03	2.7655000E-03	7.8939000E-01	2.1831000E-03	3.5679000E-03
2.4548000E+03	2.6753000E-03	7.8939000E-01	2.1118000E-03	3.4515000E-03
2.4549000E+03	2.5861000E-03	7.8939000E-01	2.0414000E-03	3.3364000E-03
2.4550000E+03	2.4979000E-03	7.8939000E-01	1.9718000E-03	3.2226000E-03
2.4551000E+03	2.4107000E-03	7.8940000E-01	1.9030000E-03	3.1102000E-03
2.4552000E+03	2.3246000E-03	7.8940000E-01	1.8351000E-03	2.9992000E-03
2.4553000E+03	2.2396000E-03	7.8941000E-01	1.7680000E-03	2.8895000E-03
2.4554000E+03	2.1557000E-03	7.8941000E-01	1.7017000E-03	2.7812000E-03
2.4555000E+03	2.0729000E-03	7.8942000E-01	1.6364000E-03	2.6744000E-03
2.4556000E+03	1.9912000E-03	7.8942000E-01	1.5719000E-03	2.5691000E-03
2.4557000E+03	1.9108000E-03	7.8943000E-01	1.5084000E-03	2.4653000E-03
2.4558000E+03	1.8316000E-03	7.8943000E-01	1.4460000E-03	2.3632000E-03
2.4559000E+03	1.7538000E-03	7.8944000E-01	1.3845000E-03	2.2627000E-03
2.4560000E+03	1.6772000E-03	7.8944000E-01	1.3241000E-03	2.1640000E-03
2.4561000E+03	1.6021000E-03	7.8944000E-01	1.2648000E-03	2.0671000E-03
2.4562000E+03	1.5284000E-03	7.8943000E-01	1.2066000E-03	1.9720000E-03
2.4563000E+03	1.4562000E-03	7.8941000E-01	1.1496000E-03	1.8788000E-03
2.4564000E+03	1.3856000E-03	7.8940000E-01	1.0938000E-03	1.7877000E-03
2.4565000E+03	1.3166000E-03	7.8939000E-01	1.0393000E-03	1.6986000E-03
2.4566000E+03	1.2493000E-03	7.8937000E-01	9.8612000E-04	1.6117000E-03
2.4567000E+03	1.1836000E-03	7.8936000E-01	9.3428000E-04	1.5270000E-03
2.4568000E+03	1.1197000E-03	7.8934000E-01	8.8384000E-04	1.4445000E-03
2.4569000E+03	1.0576000E-03	7.8933000E-01	8.3483000E-04	1.3644000E-03
2.4570000E+03	9.9741000E-04	7.8931000E-01	7.8727000E-04	1.2867000E-03
2.4571000E+03	9.3907000E-04	7.8930000E-01	7.4121000E-04	1.2114000E-03
2.4572000E+03	8.8266000E-04	7.8929000E-01	6.9667000E-04	1.1386000E-03
2.4573000E+03	8.2822000E-04	7.8927000E-01	6.5369000E-04	1.0684000E-03
2.4574000E+03	7.7576000E-04	7.8926000E-01	6.1227000E-04	1.0007000E-03
2.4575000E+03	7.2532000E-04	7.8924000E-01	5.7246000E-04	9.3560000E-04
2.4576000E+03	0.0000000E+00	7.8923000E-01	0.0000000E+00	0.0000000E+00
Channel 18				
Wavenumber	HIRS Filter Transmittance	Optical Element Transmittance	Product of the HIRS Filter and Optical Element Transmittances	Normalized Value of Column 4
2.4607000E+03	0.0000000E+00	7.8925000E-01	0.0000000E+00	0.0000000E+00
2.4608000E+03	3.9459000E-03	7.8925000E-01	3.1143000E-03	5.6654000E-03
2.4609000E+03	3.9470000E-03	7.8924000E-01	3.1151000E-03	5.6667000E-03
2.4610000E+03	3.9489000E-03	7.8923000E-01	3.1166000E-03	5.6694000E-03
2.4611000E+03	3.9518000E-03	7.8922000E-01	3.1189000E-03	5.6736000E-03

2.4612000E+03	3.9558000E-03	7.8920000E-01	3.1219000E-03	5.6792000E-03
2.4613000E+03	3.9609000E-03	7.8919000E-01	3.1259000E-03	5.6864000E-03
2.4614000E+03	3.9670000E-03	7.8918000E-01	3.1307000E-03	5.6951000E-03
2.4615000E+03	3.9743000E-03	7.8916000E-01	3.1364000E-03	5.7054000E-03
2.4616000E+03	3.9827000E-03	7.8915000E-01	3.1429000E-03	5.7174000E-03
2.4617000E+03	3.9923000E-03	7.8914000E-01	3.1504000E-03	5.7310000E-03
2.4618000E+03	4.0031000E-03	7.8912000E-01	3.1589000E-03	5.7464000E-03
2.4619000E+03	4.0151000E-03	7.8911000E-01	3.1683000E-03	5.7636000E-03
2.4620000E+03	4.0283000E-03	7.8910000E-01	3.1787000E-03	5.7825000E-03
2.4621000E+03	4.0428000E-03	7.8908000E-01	3.1901000E-03	5.8032000E-03
2.4622000E+03	4.0586000E-03	7.8906000E-01	3.2025000E-03	5.8257000E-03
2.4623000E+03	4.0757000E-03	7.8904000E-01	3.2159000E-03	5.8500000E-03
2.4624000E+03	4.0940000E-03	7.8902000E-01	3.2303000E-03	5.8763000E-03
2.4625000E+03	4.1137000E-03	7.8900000E-01	3.2457000E-03	5.9044000E-03
2.4626000E+03	4.1347000E-03	7.8899000E-01	3.2622000E-03	5.9344000E-03
2.4627000E+03	4.1571000E-03	7.8897000E-01	3.2798000E-03	5.9663000E-03
2.4628000E+03	4.1807000E-03	7.8895000E-01	3.2984000E-03	6.0002000E-03
2.4629000E+03	4.2058000E-03	7.8893000E-01	3.3181000E-03	6.0359000E-03
2.4630000E+03	4.2321000E-03	7.8891000E-01	3.3388000E-03	6.0736000E-03
2.4631000E+03	4.2598000E-03	7.8889000E-01	3.3605000E-03	6.1132000E-03
2.4632000E+03	4.2889000E-03	7.8887000E-01	3.3833000E-03	6.1547000E-03
2.4633000E+03	4.3192000E-03	7.8885000E-01	3.4072000E-03	6.1981000E-03
2.4634000E+03	4.3509000E-03	7.8882000E-01	3.4321000E-03	6.2434000E-03
2.4635000E+03	4.3840000E-03	7.8880000E-01	3.4581000E-03	6.2907000E-03
2.4636000E+03	4.4183000E-03	7.8878000E-01	3.4850000E-03	6.3397000E-03
2.4637000E+03	4.4539000E-03	7.8875000E-01	3.5131000E-03	6.3907000E-03
2.4638000E+03	4.4908000E-03	7.8873000E-01	3.5421000E-03	6.4434000E-03
2.4639000E+03	4.5290000E-03	7.8871000E-01	3.5721000E-03	6.4980000E-03
2.4640000E+03	4.5684000E-03	7.8869000E-01	3.6031000E-03	6.5544000E-03
2.4641000E+03	4.6091000E-03	7.8866000E-01	3.6350000E-03	6.6124000E-03
2.4642000E+03	4.6509000E-03	7.8863000E-01	3.6678000E-03	6.6722000E-03
2.4643000E+03	4.6939000E-03	7.8860000E-01	3.7016000E-03	6.7337000E-03
2.4644000E+03	4.7381000E-03	7.8857000E-01	3.7363000E-03	6.7968000E-03
2.4645000E+03	4.7834000E-03	7.8854000E-01	3.7719000E-03	6.8615000E-03
2.4646000E+03	4.8298000E-03	7.8852000E-01	3.8084000E-03	6.9279000E-03
2.4647000E+03	4.8772000E-03	7.8849000E-01	3.8456000E-03	6.9957000E-03
2.4648000E+03	4.9257000E-03	7.8846000E-01	3.8837000E-03	7.0649000E-03
2.4649000E+03	4.9751000E-03	7.8843000E-01	3.9226000E-03	7.1356000E-03
2.4650000E+03	5.0256000E-03	7.8840000E-01	3.9622000E-03	7.2077000E-03
2.4651000E+03	5.0769000E-03	7.8837000E-01	4.0025000E-03	7.2811000E-03
2.4652000E+03	5.1292000E-03	7.8834000E-01	4.0436000E-03	7.3557000E-03
2.4653000E+03	5.1822000E-03	7.8832000E-01	4.0852000E-03	7.4315000E-03
2.4654000E+03	5.2361000E-03	7.8829000E-01	4.1276000E-03	7.5085000E-03

2.4655000E+03	5.2908000E-03	7.8826000E-01	4.1705000E-03	7.5866000E-03
2.4656000E+03	5.3461000E-03	7.8823000E-01	4.2139000E-03	7.6657000E-03
2.4657000E+03	5.4021000E-03	7.8820000E-01	4.2580000E-03	7.7457000E-03
2.4658000E+03	5.4588000E-03	7.8817000E-01	4.3024000E-03	7.8267000E-03
2.4659000E+03	5.5160000E-03	7.8814000E-01	4.3474000E-03	7.9085000E-03
2.4660000E+03	5.5738000E-03	7.8811000E-01	4.3928000E-03	7.9910000E-03
2.4661000E+03	5.6320000E-03	7.8809000E-01	4.4386000E-03	8.0743000E-03
2.4662000E+03	5.6907000E-03	7.8807000E-01	4.4847000E-03	8.1582000E-03
2.4663000E+03	5.7498000E-03	7.8805000E-01	4.5311000E-03	8.2427000E-03
2.4664000E+03	5.8092000E-03	7.8803000E-01	4.5778000E-03	8.3276000E-03
2.4665000E+03	5.8690000E-03	7.8800000E-01	4.6248000E-03	8.4130000E-03
2.4666000E+03	5.9290000E-03	7.8798000E-01	4.6719000E-03	8.4988000E-03
2.4667000E+03	5.9891000E-03	7.8796000E-01	4.7192000E-03	8.5848000E-03
2.4668000E+03	6.0495000E-03	7.8794000E-01	4.7666000E-03	8.6710000E-03
2.4669000E+03	6.1099000E-03	7.8792000E-01	4.8141000E-03	8.7574000E-03
2.4670000E+03	6.1704000E-03	7.8789000E-01	4.8616000E-03	8.8439000E-03
2.4671000E+03	6.2309000E-03	7.8788000E-01	4.9092000E-03	8.9305000E-03
2.4672000E+03	6.2914000E-03	7.8786000E-01	4.9568000E-03	9.0169000E-03
2.4673000E+03	6.3518000E-03	7.8784000E-01	5.0042000E-03	9.1033000E-03
2.4674000E+03	6.4121000E-03	7.8783000E-01	5.0516000E-03	9.1895000E-03
2.4675000E+03	6.4722000E-03	7.8781000E-01	5.0989000E-03	9.2755000E-03
2.4676000E+03	6.5321000E-03	7.8780000E-01	5.1460000E-03	9.3611000E-03
2.4677000E+03	6.5918000E-03	7.8778000E-01	5.1929000E-03	9.4465000E-03
2.4678000E+03	6.6512000E-03	7.8776000E-01	5.2395000E-03	9.5313000E-03
2.4679000E+03	6.7102000E-03	7.8775000E-01	5.2859000E-03	9.6157000E-03
2.4680000E+03	6.7689000E-03	7.8773000E-01	5.3320000E-03	9.6996000E-03
2.4681000E+03	6.8271000E-03	7.8770000E-01	5.3777000E-03	9.7828000E-03
2.4682000E+03	6.8850000E-03	7.8768000E-01	5.4231000E-03	9.8653000E-03
2.4683000E+03	6.9423000E-03	7.8765000E-01	5.4681000E-03	9.9472000E-03
2.4684000E+03	6.9992000E-03	7.8763000E-01	5.5127000E-03	1.0028000E-02
2.4685000E+03	7.0555000E-03	7.8760000E-01	5.5569000E-03	1.0109000E-02
2.4686000E+03	7.1113000E-03	7.8757000E-01	5.6007000E-03	1.0188000E-02
2.4687000E+03	7.1665000E-03	7.8755000E-01	5.6439000E-03	1.0267000E-02
2.4688000E+03	7.2211000E-03	7.8752000E-01	5.6867000E-03	1.0345000E-02
2.4689000E+03	7.2750000E-03	7.8749000E-01	5.7290000E-03	1.0422000E-02
2.4690000E+03	7.3283000E-03	7.8747000E-01	5.7708000E-03	1.0498000E-02
2.4691000E+03	7.3810000E-03	7.8744000E-01	5.8121000E-03	1.0573000E-02
2.4692000E+03	7.4330000E-03	7.8741000E-01	5.8528000E-03	1.0647000E-02
2.4693000E+03	7.4843000E-03	7.8739000E-01	5.8930000E-03	1.0720000E-02
2.4694000E+03	7.5348000E-03	7.8736000E-01	5.9326000E-03	1.0792000E-02
2.4695000E+03	7.5848000E-03	7.8733000E-01	5.9717000E-03	1.0863000E-02
2.4696000E+03	7.6339000E-03	7.8730000E-01	6.0102000E-03	1.0933000E-02
2.4697000E+03	7.6824000E-03	7.8727000E-01	6.0482000E-03	1.1002000E-02

2.4698000E+03	7.7302000E-03	7.8725000E-01	6.0856000E-03	1.1070000E-02
2.4699000E+03	7.7773000E-03	7.8722000E-01	6.1224000E-03	1.1137000E-02
2.4700000E+03	7.8237000E-03	7.8719000E-01	6.1587000E-03	1.1203000E-02
2.4701000E+03	7.8693000E-03	7.8716000E-01	6.1944000E-03	1.1268000E-02
2.4702000E+03	7.9144000E-03	7.8712000E-01	6.2296000E-03	1.1332000E-02
2.4703000E+03	7.9588000E-03	7.8709000E-01	6.2643000E-03	1.1395000E-02
2.4704000E+03	8.0025000E-03	7.8706000E-01	6.2984000E-03	1.1458000E-02
2.4705000E+03	8.0456000E-03	7.8703000E-01	6.3321000E-03	1.1519000E-02
2.4706000E+03	8.0881000E-03	7.8699000E-01	6.3653000E-03	1.1579000E-02
2.4707000E+03	8.1300000E-03	7.8696000E-01	6.3980000E-03	1.1639000E-02
2.4708000E+03	8.1715000E-03	7.8692000E-01	6.4303000E-03	1.1698000E-02
2.4709000E+03	8.2124000E-03	7.8689000E-01	6.4622000E-03	1.1756000E-02
2.4710000E+03	8.2528000E-03	7.8686000E-01	6.4938000E-03	1.1813000E-02
2.4711000E+03	8.2928000E-03	7.8682000E-01	6.5249000E-03	1.1870000E-02
2.4712000E+03	8.3324000E-03	7.8679000E-01	6.5558000E-03	1.1926000E-02
2.4713000E+03	8.3717000E-03	7.8675000E-01	6.5864000E-03	1.1981000E-02
2.4714000E+03	8.4106000E-03	7.8671000E-01	6.6167000E-03	1.2037000E-02
2.4715000E+03	8.4493000E-03	7.8668000E-01	6.6469000E-03	1.2091000E-02
2.4716000E+03	8.4878000E-03	7.8664000E-01	6.6769000E-03	1.2146000E-02
2.4717000E+03	8.5262000E-03	7.8661000E-01	6.7067000E-03	1.2200000E-02
2.4718000E+03	8.5644000E-03	7.8657000E-01	6.7365000E-03	1.2255000E-02
2.4719000E+03	8.6026000E-03	7.8653000E-01	6.7663000E-03	1.2309000E-02
2.4720000E+03	8.6409000E-03	7.8650000E-01	6.7960000E-03	1.2363000E-02
2.4721000E+03	8.6792000E-03	7.8647000E-01	6.8260000E-03	1.2417000E-02
2.4722000E+03	8.7177000E-03	7.8645000E-01	6.8560000E-03	1.2472000E-02
2.4723000E+03	8.7564000E-03	7.8642000E-01	6.8862000E-03	1.2527000E-02
2.4724000E+03	8.7954000E-03	7.8639000E-01	6.9167000E-03	1.2582000E-02
2.4725000E+03	8.8348000E-03	7.8637000E-01	6.9474000E-03	1.2638000E-02
2.4726000E+03	8.8746000E-03	7.8634000E-01	6.9785000E-03	1.2695000E-02
2.4727000E+03	8.9150000E-03	7.8631000E-01	7.0099000E-03	1.2752000E-02
2.4728000E+03	8.9559000E-03	7.8629000E-01	7.0419000E-03	1.2810000E-02
2.4729000E+03	8.9975000E-03	7.8626000E-01	7.0744000E-03	1.2869000E-02
2.4730000E+03	9.0398000E-03	7.8623000E-01	7.1074000E-03	1.2929000E-02
2.4731000E+03	9.0830000E-03	7.8621000E-01	7.1412000E-03	1.2991000E-02
2.4732000E+03	9.1271000E-03	7.8619000E-01	7.1756000E-03	1.3053000E-02
2.4733000E+03	9.1722000E-03	7.8616000E-01	7.2109000E-03	1.3117000E-02
2.4734000E+03	9.2184000E-03	7.8614000E-01	7.2470000E-03	1.3183000E-02
2.4735000E+03	9.2657000E-03	7.8612000E-01	7.2840000E-03	1.3250000E-02
2.4736000E+03	9.3144000E-03	7.8610000E-01	7.3220000E-03	1.3320000E-02
2.4737000E+03	9.3643000E-03	7.8607000E-01	7.3611000E-03	1.3391000E-02
2.4738000E+03	9.4157000E-03	7.8605000E-01	7.4012000E-03	1.3464000E-02
2.4739000E+03	9.4687000E-03	7.8603000E-01	7.4426000E-03	1.3539000E-02
2.4740000E+03	9.5232000E-03	7.8601000E-01	7.4853000E-03	1.3617000E-02

2.4741000E+03	9.5794000E-03	7.8597000E-01	7.5292000E-03	1.3696000E-02
2.4742000E+03	9.6374000E-03	7.8594000E-01	7.5745000E-03	1.3779000E-02
2.4743000E+03	9.6973000E-03	7.8591000E-01	7.6212000E-03	1.3864000E-02
2.4744000E+03	9.7592000E-03	7.8588000E-01	7.6696000E-03	1.3952000E-02
2.4745000E+03	9.8231000E-03	7.8585000E-01	7.7195000E-03	1.4043000E-02
2.4746000E+03	9.8892000E-03	7.8581000E-01	7.7711000E-03	1.4137000E-02
2.4747000E+03	9.9575000E-03	7.8578000E-01	7.8245000E-03	1.4234000E-02
2.4748000E+03	1.0028000E-02	7.8575000E-01	7.8797000E-03	1.4334000E-02
2.4749000E+03	1.0101000E-02	7.8572000E-01	7.9367000E-03	1.4438000E-02
2.4750000E+03	1.0177000E-02	7.8569000E-01	7.9958000E-03	1.4545000E-02
2.4751000E+03	1.0255000E-02	7.8566000E-01	8.0569000E-03	1.4656000E-02
2.4752000E+03	1.0336000E-02	7.8563000E-01	8.1201000E-03	1.4771000E-02
2.4753000E+03	1.0419000E-02	7.8561000E-01	8.1854000E-03	1.4890000E-02
2.4754000E+03	1.0506000E-02	7.8558000E-01	8.2529000E-03	1.5013000E-02
2.4755000E+03	1.0595000E-02	7.8555000E-01	8.3228000E-03	1.5140000E-02
2.4756000E+03	1.0687000E-02	7.8553000E-01	8.3950000E-03	1.5272000E-02
2.4757000E+03	1.0782000E-02	7.8550000E-01	8.4696000E-03	1.5407000E-02
2.4758000E+03	1.0881000E-02	7.8547000E-01	8.5466000E-03	1.5547000E-02
2.4759000E+03	1.0983000E-02	7.8544000E-01	8.6261000E-03	1.5692000E-02
2.4760000E+03	1.1087000E-02	7.8542000E-01	8.7083000E-03	1.5841000E-02
2.4761000E+03	1.1196000E-02	7.8540000E-01	8.7932000E-03	1.5996000E-02
2.4762000E+03	1.1308000E-02	7.8538000E-01	8.8808000E-03	1.6155000E-02
2.4763000E+03	1.1423000E-02	7.8536000E-01	8.9711000E-03	1.6319000E-02
2.4764000E+03	1.1542000E-02	7.8535000E-01	9.0642000E-03	1.6489000E-02
2.4765000E+03	1.1664000E-02	7.8533000E-01	9.1601000E-03	1.6663000E-02
2.4766000E+03	1.1790000E-02	7.8531000E-01	9.2590000E-03	1.6843000E-02
2.4767000E+03	1.1920000E-02	7.8529000E-01	9.3608000E-03	1.7028000E-02
2.4768000E+03	1.2054000E-02	7.8527000E-01	9.4655000E-03	1.7219000E-02
2.4769000E+03	1.2191000E-02	7.8526000E-01	9.5733000E-03	1.7415000E-02
2.4770000E+03	1.2333000E-02	7.8524000E-01	9.6841000E-03	1.7617000E-02
2.4771000E+03	1.2478000E-02	7.8522000E-01	9.7981000E-03	1.7824000E-02
2.4772000E+03	1.2628000E-02	7.8521000E-01	9.9153000E-03	1.8037000E-02
2.4773000E+03	1.2781000E-02	7.8520000E-01	1.0036000E-02	1.8256000E-02
2.4774000E+03	1.2939000E-02	7.8518000E-01	1.0159000E-02	1.8481000E-02
2.4775000E+03	1.3100000E-02	7.8517000E-01	1.0286000E-02	1.8712000E-02
2.4776000E+03	1.3266000E-02	7.8515000E-01	1.0416000E-02	1.8948000E-02
2.4777000E+03	1.3436000E-02	7.8514000E-01	1.0550000E-02	1.9191000E-02
2.4778000E+03	1.3611000E-02	7.8512000E-01	1.0686000E-02	1.9440000E-02
2.4779000E+03	1.3790000E-02	7.8511000E-01	1.0826000E-02	1.9694000E-02
2.4780000E+03	1.3973000E-02	7.8509000E-01	1.0970000E-02	1.9956000E-02
2.4781000E+03	1.4160000E-02	7.8512000E-01	1.1117000E-02	2.0224000E-02
2.4782000E+03	1.4352000E-02	7.8514000E-01	1.1268000E-02	2.0499000E-02
2.4783000E+03	1.4548000E-02	7.8517000E-01	1.1423000E-02	2.0780000E-02

2.4784000E+03	1.4749000E-02	7.8519000E-01	1.1581000E-02	2.1067000E-02
2.4785000E+03	1.4954000E-02	7.8521000E-01	1.1742000E-02	2.1361000E-02
2.4786000E+03	1.5164000E-02	7.8524000E-01	1.1907000E-02	2.1661000E-02
2.4787000E+03	1.5378000E-02	7.8526000E-01	1.2076000E-02	2.1968000E-02
2.4788000E+03	1.5597000E-02	7.8528000E-01	1.2248000E-02	2.2281000E-02
2.4789000E+03	1.5821000E-02	7.8531000E-01	1.2424000E-02	2.2601000E-02
2.4790000E+03	1.6049000E-02	7.8533000E-01	1.2604000E-02	2.2928000E-02
2.4791000E+03	1.6282000E-02	7.8535000E-01	1.2787000E-02	2.3261000E-02
2.4792000E+03	1.6519000E-02	7.8538000E-01	1.2974000E-02	2.3601000E-02
2.4793000E+03	1.6761000E-02	7.8540000E-01	1.3164000E-02	2.3947000E-02
2.4794000E+03	1.7008000E-02	7.8542000E-01	1.3358000E-02	2.4300000E-02
2.4795000E+03	1.7259000E-02	7.8545000E-01	1.3556000E-02	2.4660000E-02
2.4796000E+03	1.7515000E-02	7.8547000E-01	1.3758000E-02	2.5027000E-02
2.4797000E+03	1.7776000E-02	7.8549000E-01	1.3963000E-02	2.5400000E-02
2.4798000E+03	1.8042000E-02	7.8551000E-01	1.4172000E-02	2.5781000E-02
2.4799000E+03	1.8312000E-02	7.8554000E-01	1.4385000E-02	2.6168000E-02
2.4800000E+03	1.8588000E-02	7.8556000E-01	1.4602000E-02	2.6562000E-02
2.4801000E+03	1.8868000E-02	7.8555000E-01	1.4822000E-02	2.6962000E-02
2.4802000E+03	1.9153000E-02	7.8554000E-01	1.5045000E-02	2.7369000E-02
2.4803000E+03	1.9443000E-02	7.8552000E-01	1.5273000E-02	2.7783000E-02
2.4804000E+03	1.9738000E-02	7.8551000E-01	1.5504000E-02	2.8204000E-02
2.4805000E+03	2.0038000E-02	7.8550000E-01	1.5740000E-02	2.8632000E-02
2.4806000E+03	2.0343000E-02	7.8549000E-01	1.5979000E-02	2.9067000E-02
2.4807000E+03	2.0652000E-02	7.8547000E-01	1.6222000E-02	2.9509000E-02
2.4808000E+03	2.0967000E-02	7.8544000E-01	1.6469000E-02	2.9958000E-02
2.4809000E+03	2.1287000E-02	7.8541000E-01	1.6719000E-02	3.0414000E-02
2.4810000E+03	2.1612000E-02	7.8539000E-01	1.6974000E-02	3.0878000E-02
2.4811000E+03	2.1943000E-02	7.8536000E-01	1.7233000E-02	3.1349000E-02
2.4812000E+03	2.2278000E-02	7.8534000E-01	1.7496000E-02	3.1827000E-02
2.4813000E+03	2.2619000E-02	7.8532000E-01	1.7763000E-02	3.2313000E-02
2.4814000E+03	2.2965000E-02	7.8529000E-01	1.8034000E-02	3.2807000E-02
2.4815000E+03	2.3317000E-02	7.8527000E-01	1.8310000E-02	3.3308000E-02
2.4816000E+03	2.3674000E-02	7.8525000E-01	1.8590000E-02	3.3817000E-02
2.4817000E+03	2.4036000E-02	7.8522000E-01	1.8874000E-02	3.4333000E-02
2.4818000E+03	2.4404000E-02	7.8520000E-01	1.9162000E-02	3.4858000E-02
2.4819000E+03	2.4778000E-02	7.8518000E-01	1.9455000E-02	3.5391000E-02
2.4820000E+03	2.5157000E-02	7.8516000E-01	1.9752000E-02	3.5932000E-02
2.4821000E+03	2.5542000E-02	7.8509000E-01	2.0053000E-02	3.6479000E-02
2.4822000E+03	2.5933000E-02	7.8503000E-01	2.0358000E-02	3.7035000E-02
2.4823000E+03	2.6330000E-02	7.8497000E-01	2.0669000E-02	3.7599000E-02
2.4824000E+03	2.6733000E-02	7.8491000E-01	2.0983000E-02	3.8171000E-02
2.4825000E+03	2.7143000E-02	7.8485000E-01	2.1303000E-02	3.8753000E-02
2.4826000E+03	2.7558000E-02	7.8479000E-01	2.1627000E-02	3.9343000E-02

2.4827000E+03	2.7980000E-02	7.8473000E-01	2.1957000E-02	3.9942000E-02
2.4828000E+03	2.8408000E-02	7.8467000E-01	2.2291000E-02	4.0550000E-02
2.4829000E+03	2.8843000E-02	7.8461000E-01	2.2631000E-02	4.1168000E-02
2.4830000E+03	2.9285000E-02	7.8455000E-01	2.2976000E-02	4.1796000E-02
2.4831000E+03	2.9734000E-02	7.8449000E-01	2.3326000E-02	4.2433000E-02
2.4832000E+03	3.0190000E-02	7.8443000E-01	2.3682000E-02	4.3080000E-02
2.4833000E+03	3.0653000E-02	7.8437000E-01	2.4043000E-02	4.3737000E-02
2.4834000E+03	3.1123000E-02	7.8431000E-01	2.4410000E-02	4.4404000E-02
2.4835000E+03	3.1600000E-02	7.8425000E-01	2.4783000E-02	4.5082000E-02
2.4836000E+03	3.2086000E-02	7.8419000E-01	2.5161000E-02	4.5771000E-02
2.4837000E+03	3.2579000E-02	7.8413000E-01	2.5546000E-02	4.6471000E-02
2.4838000E+03	3.3080000E-02	7.8407000E-01	2.5937000E-02	4.7182000E-02
2.4839000E+03	3.3589000E-02	7.8401000E-01	2.6334000E-02	4.7905000E-02
2.4840000E+03	3.4107000E-02	7.8394000E-01	2.6738000E-02	4.8639000E-02
2.4841000E+03	3.4633000E-02	7.8387000E-01	2.7148000E-02	4.9385000E-02
2.4842000E+03	3.5168000E-02	7.8380000E-01	2.7564000E-02	5.0143000E-02
2.4843000E+03	3.5712000E-02	7.8373000E-01	2.7988000E-02	5.0914000E-02
2.4844000E+03	3.6265000E-02	7.8365000E-01	2.8419000E-02	5.1697000E-02
2.4845000E+03	3.6827000E-02	7.8358000E-01	2.8857000E-02	5.2494000E-02
2.4846000E+03	3.7399000E-02	7.8351000E-01	2.9302000E-02	5.3304000E-02
2.4847000E+03	3.7981000E-02	7.8343000E-01	2.9755000E-02	5.4129000E-02
2.4848000E+03	3.8573000E-02	7.8336000E-01	3.0216000E-02	5.4967000E-02
2.4849000E+03	3.9175000E-02	7.8329000E-01	3.0685000E-02	5.5820000E-02
2.4850000E+03	3.9787000E-02	7.8322000E-01	3.1162000E-02	5.6688000E-02
2.4851000E+03	4.0411000E-02	7.8314000E-01	3.1647000E-02	5.7570000E-02
2.4852000E+03	4.1046000E-02	7.8306000E-01	3.2141000E-02	5.8468000E-02
2.4853000E+03	4.1692000E-02	7.8297000E-01	3.2643000E-02	5.9382000E-02
2.4854000E+03	4.2349000E-02	7.8290000E-01	3.3155000E-02	6.0313000E-02
2.4855000E+03	4.3019000E-02	7.8282000E-01	3.3676000E-02	6.1260000E-02
2.4856000E+03	4.3700000E-02	7.8274000E-01	3.4206000E-02	6.2224000E-02
2.4857000E+03	4.4394000E-02	7.8266000E-01	3.4745000E-02	6.3206000E-02
2.4858000E+03	4.5101000E-02	7.8258000E-01	3.5295000E-02	6.4205000E-02
2.4859000E+03	4.5821000E-02	7.8249000E-01	3.5854000E-02	6.5223000E-02
2.4860000E+03	4.6553000E-02	7.8241000E-01	3.6424000E-02	6.6260000E-02
2.4861000E+03	4.7300000E-02	7.8239000E-01	3.7007000E-02	6.7321000E-02
2.4862000E+03	4.8061000E-02	7.8237000E-01	3.7601000E-02	6.8401000E-02
2.4863000E+03	4.8836000E-02	7.8234000E-01	3.8206000E-02	6.9502000E-02
2.4864000E+03	4.9625000E-02	7.8232000E-01	3.8823000E-02	7.0623000E-02
2.4865000E+03	5.0429000E-02	7.8230000E-01	3.9450000E-02	7.1765000E-02
2.4866000E+03	5.1248000E-02	7.8227000E-01	4.0090000E-02	7.2929000E-02
2.4867000E+03	5.2083000E-02	7.8225000E-01	4.0742000E-02	7.4115000E-02
2.4868000E+03	5.2934000E-02	7.8222000E-01	4.1406000E-02	7.5323000E-02
2.4869000E+03	5.3801000E-02	7.8220000E-01	4.2083000E-02	7.6554000E-02

2.4870000E+03	5.4684000E-02	7.8218000E-01	4.2772000E-02	7.7808000E-02
2.4871000E+03	5.5584000E-02	7.8216000E-01	4.3475000E-02	7.9087000E-02
2.4872000E+03	5.6501000E-02	7.8213000E-01	4.4191000E-02	8.0389000E-02
2.4873000E+03	5.7435000E-02	7.8211000E-01	4.4921000E-02	8.1716000E-02
2.4874000E+03	5.8387000E-02	7.8209000E-01	4.5664000E-02	8.3069000E-02
2.4875000E+03	5.9358000E-02	7.8207000E-01	4.6422000E-02	8.4447000E-02
2.4876000E+03	6.0346000E-02	7.8205000E-01	4.7194000E-02	8.5851000E-02
2.4877000E+03	6.1354000E-02	7.8202000E-01	4.7980000E-02	8.7282000E-02
2.4878000E+03	6.2380000E-02	7.8200000E-01	4.8782000E-02	8.8740000E-02
2.4879000E+03	6.3426000E-02	7.8198000E-01	4.9598000E-02	9.0225000E-02
2.4880000E+03	6.4492000E-02	7.8196000E-01	5.0430000E-02	9.1738000E-02
2.4881000E+03	6.5577000E-02	7.8194000E-01	5.1277000E-02	9.3280000E-02
2.4882000E+03	6.6683000E-02	7.8192000E-01	5.2141000E-02	9.4850000E-02
2.4883000E+03	6.7810000E-02	7.8189000E-01	5.3020000E-02	9.6450000E-02
2.4884000E+03	6.8957000E-02	7.8187000E-01	5.3916000E-02	9.8080000E-02
2.4885000E+03	7.0126000E-02	7.8185000E-01	5.4828000E-02	9.9739000E-02
2.4886000E+03	7.1316000E-02	7.8183000E-01	5.5757000E-02	1.0143000E-01
2.4887000E+03	7.2528000E-02	7.8181000E-01	5.6703000E-02	1.0315000E-01
2.4888000E+03	7.3763000E-02	7.8179000E-01	5.7667000E-02	1.0490000E-01
2.4889000E+03	7.5020000E-02	7.8177000E-01	5.8648000E-02	1.0669000E-01
2.4890000E+03	7.6299000E-02	7.8174000E-01	5.9646000E-02	1.0850000E-01
2.4891000E+03	7.7602000E-02	7.8172000E-01	6.0663000E-02	1.1035000E-01
2.4892000E+03	7.8927000E-02	7.8170000E-01	6.1698000E-02	1.1224000E-01
2.4893000E+03	8.0277000E-02	7.8168000E-01	6.2751000E-02	1.1415000E-01
2.4894000E+03	8.1650000E-02	7.8167000E-01	6.3823000E-02	1.1610000E-01
2.4895000E+03	8.3047000E-02	7.8165000E-01	6.4913000E-02	1.1809000E-01
2.4896000E+03	8.4469000E-02	7.8163000E-01	6.6023000E-02	1.2010000E-01
2.4897000E+03	8.5915000E-02	7.8161000E-01	6.7151000E-02	1.2216000E-01
2.4898000E+03	8.7385000E-02	7.8159000E-01	6.8299000E-02	1.2424000E-01
2.4899000E+03	8.8881000E-02	7.8157000E-01	6.9466000E-02	1.2637000E-01
2.4900000E+03	9.0402000E-02	7.8155000E-01	7.0653000E-02	1.2853000E-01
2.4901000E+03	9.1949000E-02	7.8149000E-01	7.1857000E-02	1.3072000E-01
2.4902000E+03	9.3520000E-02	7.8144000E-01	7.3080000E-02	1.3294000E-01
2.4903000E+03	9.5118000E-02	7.8138000E-01	7.4324000E-02	1.3520000E-01
2.4904000E+03	9.6742000E-02	7.8133000E-01	7.5587000E-02	1.3750000E-01
2.4905000E+03	9.8392000E-02	7.8128000E-01	7.6871000E-02	1.3984000E-01
2.4906000E+03	1.0007000E-01	7.8122000E-01	7.8175000E-02	1.4221000E-01
2.4907000E+03	1.0177000E-01	7.8117000E-01	7.9499000E-02	1.4462000E-01
2.4908000E+03	1.0350000E-01	7.8111000E-01	8.0844000E-02	1.4707000E-01
2.4909000E+03	1.0525000E-01	7.8106000E-01	8.2210000E-02	1.4955000E-01
2.4910000E+03	1.0704000E-01	7.8100000E-01	8.3596000E-02	1.5207000E-01
2.4911000E+03	1.0885000E-01	7.8095000E-01	8.5004000E-02	1.5463000E-01
2.4912000E+03	1.1068000E-01	7.8090000E-01	8.6432000E-02	1.5723000E-01

2.4913000E+03	1.1254000E-01	7.8085000E-01	8.7881000E-02	1.5987000E-01
2.4914000E+03	1.1444000E-01	7.8080000E-01	8.9351000E-02	1.6254000E-01
2.4915000E+03	1.1635000E-01	7.8075000E-01	9.0842000E-02	1.6525000E-01
2.4916000E+03	1.1830000E-01	7.8070000E-01	9.2353000E-02	1.6800000E-01
2.4917000E+03	1.2027000E-01	7.8065000E-01	9.3887000E-02	1.7079000E-01
2.4918000E+03	1.2227000E-01	7.8060000E-01	9.5440000E-02	1.7362000E-01
2.4919000E+03	1.2429000E-01	7.8055000E-01	9.7016000E-02	1.7648000E-01
2.4920000E+03	1.2634000E-01	7.8049000E-01	9.8612000E-02	1.7939000E-01
2.4921000E+03	1.2842000E-01	7.8047000E-01	1.0023000E-01	1.8233000E-01
2.4922000E+03	1.3053000E-01	7.8044000E-01	1.0187000E-01	1.8532000E-01
2.4923000E+03	1.3266000E-01	7.8041000E-01	1.0353000E-01	1.8834000E-01
2.4924000E+03	1.3483000E-01	7.8039000E-01	1.0522000E-01	1.9140000E-01
2.4925000E+03	1.3701000E-01	7.8036000E-01	1.0692000E-01	1.9450000E-01
2.4926000E+03	1.3923000E-01	7.8033000E-01	1.0864000E-01	1.9764000E-01
2.4927000E+03	1.4147000E-01	7.8031000E-01	1.1039000E-01	2.0081000E-01
2.4928000E+03	1.4374000E-01	7.8028000E-01	1.1215000E-01	2.0402000E-01
2.4929000E+03	1.4603000E-01	7.8025000E-01	1.1394000E-01	2.0727000E-01
2.4930000E+03	1.4835000E-01	7.8023000E-01	1.1575000E-01	2.1055000E-01
2.4931000E+03	1.5069000E-01	7.8020000E-01	1.1757000E-01	2.1388000E-01
2.4932000E+03	1.5306000E-01	7.8018000E-01	1.1942000E-01	2.1724000E-01
2.4933000E+03	1.5546000E-01	7.8015000E-01	1.2128000E-01	2.2063000E-01
2.4934000E+03	1.5788000E-01	7.8013000E-01	1.2317000E-01	2.2406000E-01
2.4935000E+03	1.6033000E-01	7.8010000E-01	1.2507000E-01	2.2753000E-01
2.4936000E+03	1.6280000E-01	7.8007000E-01	1.2700000E-01	2.3103000E-01
2.4937000E+03	1.6530000E-01	7.8005000E-01	1.2894000E-01	2.3456000E-01
2.4938000E+03	1.6782000E-01	7.8002000E-01	1.3090000E-01	2.3813000E-01
2.4939000E+03	1.7037000E-01	7.8000000E-01	1.3289000E-01	2.4173000E-01
2.4940000E+03	1.7293000E-01	7.7997000E-01	1.3488000E-01	2.4537000E-01
2.4941000E+03	1.7553000E-01	7.7995000E-01	1.3690000E-01	2.4904000E-01
2.4942000E+03	1.7814000E-01	7.7993000E-01	1.3894000E-01	2.5274000E-01
2.4943000E+03	1.8078000E-01	7.7990000E-01	1.4099000E-01	2.5648000E-01
2.4944000E+03	1.8344000E-01	7.7988000E-01	1.4306000E-01	2.6025000E-01
2.4945000E+03	1.8612000E-01	7.7986000E-01	1.4515000E-01	2.6404000E-01
2.4946000E+03	1.8883000E-01	7.7984000E-01	1.4725000E-01	2.6787000E-01
2.4947000E+03	1.9155000E-01	7.7981000E-01	1.4938000E-01	2.7173000E-01
2.4948000E+03	1.9430000E-01	7.7979000E-01	1.5151000E-01	2.7562000E-01
2.4949000E+03	1.9707000E-01	7.7977000E-01	1.5367000E-01	2.7954000E-01
2.4950000E+03	1.9985000E-01	7.7974000E-01	1.5584000E-01	2.8348000E-01
2.4951000E+03	2.0266000E-01	7.7972000E-01	1.5802000E-01	2.8746000E-01
2.4952000E+03	2.0549000E-01	7.7970000E-01	1.6022000E-01	2.9146000E-01
2.4953000E+03	2.0833000E-01	7.7968000E-01	1.6243000E-01	2.9548000E-01
2.4954000E+03	2.1119000E-01	7.7966000E-01	1.6466000E-01	2.9954000E-01
2.4955000E+03	2.1407000E-01	7.7964000E-01	1.6690000E-01	3.0361000E-01

2.4956000E+03	2.1697000E-01	7.7962000E-01	1.6916000E-01	3.0772000E-01
2.4957000E+03	2.1989000E-01	7.7960000E-01	1.7142000E-01	3.1184000E-01
2.4958000E+03	2.2282000E-01	7.7958000E-01	1.7371000E-01	3.1599000E-01
2.4959000E+03	2.2577000E-01	7.7956000E-01	1.7600000E-01	3.2016000E-01
2.4960000E+03	2.2873000E-01	7.7953000E-01	1.7830000E-01	3.2436000E-01
2.4961000E+03	2.3171000E-01	7.7948000E-01	1.8061000E-01	3.2856000E-01
2.4962000E+03	2.3470000E-01	7.7943000E-01	1.8293000E-01	3.3278000E-01
2.4963000E+03	2.3771000E-01	7.7936000E-01	1.8526000E-01	3.3701000E-01
2.4964000E+03	2.4073000E-01	7.7930000E-01	1.8760000E-01	3.4127000E-01
2.4965000E+03	2.4376000E-01	7.7924000E-01	1.8995000E-01	3.4554000E-01
2.4966000E+03	2.4680000E-01	7.7918000E-01	1.9230000E-01	3.4983000E-01
2.4967000E+03	2.4986000E-01	7.7912000E-01	1.9467000E-01	3.5413000E-01
2.4968000E+03	2.5293000E-01	7.7905000E-01	1.9705000E-01	3.5845000E-01
2.4969000E+03	2.5601000E-01	7.7899000E-01	1.9943000E-01	3.6278000E-01
2.4970000E+03	2.5910000E-01	7.7893000E-01	2.0182000E-01	3.6713000E-01
2.4971000E+03	2.6219000E-01	7.7886000E-01	2.0421000E-01	3.7149000E-01
2.4972000E+03	2.6530000E-01	7.7880000E-01	2.0662000E-01	3.7586000E-01
2.4973000E+03	2.6842000E-01	7.7874000E-01	2.0903000E-01	3.8024000E-01
2.4974000E+03	2.7154000E-01	7.7867000E-01	2.1144000E-01	3.8464000E-01
2.4975000E+03	2.7467000E-01	7.7861000E-01	2.1386000E-01	3.8904000E-01
2.4976000E+03	2.7781000E-01	7.7854000E-01	2.1629000E-01	3.9345000E-01
2.4977000E+03	2.8095000E-01	7.7848000E-01	2.1871000E-01	3.9787000E-01
2.4978000E+03	2.8410000E-01	7.7841000E-01	2.2115000E-01	4.0230000E-01
2.4979000E+03	2.8726000E-01	7.7835000E-01	2.2359000E-01	4.0673000E-01
2.4980000E+03	2.9041000E-01	7.7828000E-01	2.2603000E-01	4.1117000E-01
2.4981000E+03	2.9358000E-01	7.7825000E-01	2.2848000E-01	4.1563000E-01
2.4982000E+03	2.9675000E-01	7.7822000E-01	2.3093000E-01	4.2009000E-01
2.4983000E+03	2.9991000E-01	7.7818000E-01	2.3339000E-01	4.2456000E-01
2.4984000E+03	3.0309000E-01	7.7815000E-01	2.3585000E-01	4.2903000E-01
2.4985000E+03	3.0626000E-01	7.7812000E-01	2.3831000E-01	4.3351000E-01
2.4986000E+03	3.0944000E-01	7.7808000E-01	2.4077000E-01	4.3798000E-01
2.4987000E+03	3.1261000E-01	7.7805000E-01	2.4323000E-01	4.4246000E-01
2.4988000E+03	3.1579000E-01	7.7801000E-01	2.4569000E-01	4.4694000E-01
2.4989000E+03	3.1897000E-01	7.7798000E-01	2.4815000E-01	4.5141000E-01
2.4990000E+03	3.2214000E-01	7.7795000E-01	2.5061000E-01	4.5589000E-01
2.4991000E+03	3.2532000E-01	7.7791000E-01	2.5307000E-01	4.6036000E-01
2.4992000E+03	3.2849000E-01	7.7788000E-01	2.5552000E-01	4.6483000E-01
2.4993000E+03	3.3166000E-01	7.7785000E-01	2.5798000E-01	4.6930000E-01
2.4994000E+03	3.3483000E-01	7.7781000E-01	2.6043000E-01	4.7376000E-01
2.4995000E+03	3.3799000E-01	7.7778000E-01	2.6288000E-01	4.7822000E-01
2.4996000E+03	3.4115000E-01	7.7775000E-01	2.6533000E-01	4.8267000E-01
2.4997000E+03	3.4431000E-01	7.7771000E-01	2.6778000E-01	4.8712000E-01
2.4998000E+03	3.4747000E-01	7.7768000E-01	2.7022000E-01	4.9156000E-01

2.4999000E+03	3.5061000E-01	7.7765000E-01	2.7265000E-01	4.9599000E-01
2.5000000E+03	3.5376000E-01	7.7761000E-01	2.7509000E-01	5.0042000E-01
2.5001000E+03	3.5689000E-01	7.7758000E-01	2.7751000E-01	5.0483000E-01
2.5002000E+03	3.6003000E-01	7.7754000E-01	2.7993000E-01	5.0924000E-01
2.5003000E+03	3.6315000E-01	7.7750000E-01	2.8235000E-01	5.1363000E-01
2.5004000E+03	3.6627000E-01	7.7746000E-01	2.8476000E-01	5.1802000E-01
2.5005000E+03	3.6938000E-01	7.7742000E-01	2.8717000E-01	5.2239000E-01
2.5006000E+03	3.7249000E-01	7.7739000E-01	2.8957000E-01	5.2675000E-01
2.5007000E+03	3.7558000E-01	7.7735000E-01	2.9196000E-01	5.3111000E-01
2.5008000E+03	3.7867000E-01	7.7731000E-01	2.9434000E-01	5.3545000E-01
2.5009000E+03	3.8175000E-01	7.7727000E-01	2.9672000E-01	5.3978000E-01
2.5010000E+03	3.8482000E-01	7.7723000E-01	2.9910000E-01	5.4409000E-01
2.5011000E+03	3.8788000E-01	7.7719000E-01	3.0146000E-01	5.4839000E-01
2.5012000E+03	3.9094000E-01	7.7715000E-01	3.0382000E-01	5.5268000E-01
2.5013000E+03	3.9398000E-01	7.7711000E-01	3.0617000E-01	5.5695000E-01
2.5014000E+03	3.9701000E-01	7.7707000E-01	3.0851000E-01	5.6121000E-01
2.5015000E+03	4.0004000E-01	7.7703000E-01	3.1084000E-01	5.6545000E-01
2.5016000E+03	4.0305000E-01	7.7699000E-01	3.1316000E-01	5.6968000E-01
2.5017000E+03	4.0605000E-01	7.7695000E-01	3.1548000E-01	5.7390000E-01
2.5018000E+03	4.0904000E-01	7.7690000E-01	3.1779000E-01	5.7809000E-01
2.5019000E+03	4.1203000E-01	7.7686000E-01	3.2009000E-01	5.8228000E-01
2.5020000E+03	4.1500000E-01	7.7682000E-01	3.2238000E-01	5.8644000E-01
2.5021000E+03	4.1795000E-01	7.7678000E-01	3.2466000E-01	5.9059000E-01
2.5022000E+03	4.2090000E-01	7.7674000E-01	3.2693000E-01	5.9473000E-01
2.5023000E+03	4.2384000E-01	7.7670000E-01	3.2919000E-01	5.9884000E-01
2.5024000E+03	4.2676000E-01	7.7666000E-01	3.3145000E-01	6.0294000E-01
2.5025000E+03	4.2968000E-01	7.7661000E-01	3.3369000E-01	6.0703000E-01
2.5026000E+03	4.3258000E-01	7.7657000E-01	3.3593000E-01	6.1109000E-01
2.5027000E+03	4.3547000E-01	7.7653000E-01	3.3815000E-01	6.1514000E-01
2.5028000E+03	4.3834000E-01	7.7649000E-01	3.4037000E-01	6.1917000E-01
2.5029000E+03	4.4121000E-01	7.7645000E-01	3.4258000E-01	6.2319000E-01
2.5030000E+03	4.4407000E-01	7.7641000E-01	3.4477000E-01	6.2719000E-01
2.5031000E+03	4.4691000E-01	7.7636000E-01	3.4696000E-01	6.3117000E-01
2.5032000E+03	4.4974000E-01	7.7632000E-01	3.4914000E-01	6.3513000E-01
2.5033000E+03	4.5256000E-01	7.7628000E-01	3.5131000E-01	6.3907000E-01
2.5034000E+03	4.5536000E-01	7.7623000E-01	3.5347000E-01	6.4300000E-01
2.5035000E+03	4.5815000E-01	7.7619000E-01	3.5561000E-01	6.4691000E-01
2.5036000E+03	4.6094000E-01	7.7615000E-01	3.5775000E-01	6.5080000E-01
2.5037000E+03	4.6371000E-01	7.7610000E-01	3.5988000E-01	6.5467000E-01
2.5038000E+03	4.6646000E-01	7.7606000E-01	3.6200000E-01	6.5853000E-01
2.5039000E+03	4.6921000E-01	7.7602000E-01	3.6411000E-01	6.6237000E-01
2.5040000E+03	4.7194000E-01	7.7597000E-01	3.6621000E-01	6.6619000E-01
2.5041000E+03	4.7466000E-01	7.7592000E-01	3.6830000E-01	6.6998000E-01

2.5042000E+03	4.7737000E-01	7.7586000E-01	3.7038000E-01	6.7376000E-01
2.5043000E+03	4.8007000E-01	7.7581000E-01	3.7244000E-01	6.7752000E-01
2.5044000E+03	4.8276000E-01	7.7575000E-01	3.7450000E-01	6.8126000E-01
2.5045000E+03	4.8544000E-01	7.7570000E-01	3.7655000E-01	6.8499000E-01
2.5046000E+03	4.8810000E-01	7.7564000E-01	3.7859000E-01	6.8870000E-01
2.5047000E+03	4.9075000E-01	7.7559000E-01	3.8062000E-01	6.9239000E-01
2.5048000E+03	4.9339000E-01	7.7553000E-01	3.8264000E-01	6.9607000E-01
2.5049000E+03	4.9602000E-01	7.7548000E-01	3.8465000E-01	6.9973000E-01
2.5050000E+03	4.9864000E-01	7.7542000E-01	3.8666000E-01	7.0338000E-01
2.5051000E+03	5.0125000E-01	7.7537000E-01	3.8865000E-01	7.0700000E-01
2.5052000E+03	5.0384000E-01	7.7531000E-01	3.9064000E-01	7.1062000E-01
2.5053000E+03	5.0643000E-01	7.7526000E-01	3.9261000E-01	7.1421000E-01
2.5054000E+03	5.0901000E-01	7.7520000E-01	3.9458000E-01	7.1780000E-01
2.5055000E+03	5.1157000E-01	7.7515000E-01	3.9654000E-01	7.2136000E-01
2.5056000E+03	5.1413000E-01	7.7509000E-01	3.9850000E-01	7.2491000E-01
2.5057000E+03	5.1667000E-01	7.7504000E-01	4.0044000E-01	7.2845000E-01
2.5058000E+03	5.1921000E-01	7.7498000E-01	4.0238000E-01	7.3197000E-01
2.5059000E+03	5.2173000E-01	7.7493000E-01	4.0430000E-01	7.3548000E-01
2.5060000E+03	5.2424000E-01	7.7487000E-01	4.0622000E-01	7.3897000E-01
2.5061000E+03	5.2675000E-01	7.7483000E-01	4.0814000E-01	7.4245000E-01
2.5062000E+03	5.2924000E-01	7.7478000E-01	4.1005000E-01	7.4592000E-01
2.5063000E+03	5.3173000E-01	7.7473000E-01	4.1194000E-01	7.4938000E-01
2.5064000E+03	5.3420000E-01	7.7468000E-01	4.1384000E-01	7.5282000E-01
2.5065000E+03	5.3667000E-01	7.7463000E-01	4.1572000E-01	7.5625000E-01
2.5066000E+03	5.3913000E-01	7.7458000E-01	4.1760000E-01	7.5966000E-01
2.5067000E+03	5.4157000E-01	7.7454000E-01	4.1947000E-01	7.6306000E-01
2.5068000E+03	5.4401000E-01	7.7449000E-01	4.2133000E-01	7.6645000E-01
2.5069000E+03	5.4644000E-01	7.7444000E-01	4.2318000E-01	7.6982000E-01
2.5070000E+03	5.4886000E-01	7.7439000E-01	4.2503000E-01	7.7318000E-01
2.5071000E+03	5.5127000E-01	7.7434000E-01	4.2687000E-01	7.7652000E-01
2.5072000E+03	5.5367000E-01	7.7428000E-01	4.2870000E-01	7.7985000E-01
2.5073000E+03	5.5606000E-01	7.7422000E-01	4.3052000E-01	7.8316000E-01
2.5074000E+03	5.5845000E-01	7.7417000E-01	4.3233000E-01	7.8646000E-01
2.5075000E+03	5.6082000E-01	7.7411000E-01	4.3414000E-01	7.8975000E-01
2.5076000E+03	5.6319000E-01	7.7405000E-01	4.3594000E-01	7.9302000E-01
2.5077000E+03	5.6554000E-01	7.7400000E-01	4.3773000E-01	7.9628000E-01
2.5078000E+03	5.6789000E-01	7.7394000E-01	4.3952000E-01	7.9953000E-01
2.5079000E+03	5.7023000E-01	7.7389000E-01	4.4129000E-01	8.0277000E-01
2.5080000E+03	5.7256000E-01	7.7383000E-01	4.4306000E-01	8.0599000E-01
2.5081000E+03	5.7488000E-01	7.7381000E-01	4.4485000E-01	8.0923000E-01
2.5082000E+03	5.7719000E-01	7.7378000E-01	4.4662000E-01	8.1246000E-01
2.5083000E+03	5.7950000E-01	7.7376000E-01	4.4839000E-01	8.1568000E-01
2.5084000E+03	5.8179000E-01	7.7374000E-01	4.5015000E-01	8.1888000E-01

2.5085000E+03	5.8407000E-01	7.7371000E-01	4.5191000E-01	8.2207000E-01
2.5086000E+03	5.8635000E-01	7.7369000E-01	4.5365000E-01	8.2525000E-01
2.5087000E+03	5.8862000E-01	7.7367000E-01	4.5539000E-01	8.2842000E-01
2.5088000E+03	5.9087000E-01	7.7365000E-01	4.5713000E-01	8.3157000E-01
2.5089000E+03	5.9312000E-01	7.7362000E-01	4.5885000E-01	8.3471000E-01
2.5090000E+03	5.9536000E-01	7.7360000E-01	4.6057000E-01	8.3783000E-01
2.5091000E+03	5.9758000E-01	7.7357000E-01	4.6227000E-01	8.4093000E-01
2.5092000E+03	5.9980000E-01	7.7355000E-01	4.6397000E-01	8.4402000E-01
2.5093000E+03	6.0201000E-01	7.7352000E-01	4.6566000E-01	8.4710000E-01
2.5094000E+03	6.0420000E-01	7.7350000E-01	4.6735000E-01	8.5016000E-01
2.5095000E+03	6.0638000E-01	7.7347000E-01	4.6902000E-01	8.5320000E-01
2.5096000E+03	6.0856000E-01	7.7344000E-01	4.7068000E-01	8.5623000E-01
2.5097000E+03	6.1072000E-01	7.7342000E-01	4.7234000E-01	8.5925000E-01
2.5098000E+03	6.1287000E-01	7.7339000E-01	4.7399000E-01	8.6225000E-01
2.5099000E+03	6.1501000E-01	7.7337000E-01	4.7563000E-01	8.6523000E-01
2.5100000E+03	6.1714000E-01	7.7334000E-01	4.7726000E-01	8.6819000E-01
2.5101000E+03	6.1925000E-01	7.7330000E-01	4.7887000E-01	8.7112000E-01
2.5102000E+03	6.2135000E-01	7.7327000E-01	4.8047000E-01	8.7404000E-01
2.5103000E+03	6.2344000E-01	7.7323000E-01	4.8207000E-01	8.7694000E-01
2.5104000E+03	6.2552000E-01	7.7319000E-01	4.8365000E-01	8.7982000E-01
2.5105000E+03	6.2758000E-01	7.7316000E-01	4.8522000E-01	8.8268000E-01
2.5106000E+03	6.2963000E-01	7.7312000E-01	4.8678000E-01	8.8552000E-01
2.5107000E+03	6.3167000E-01	7.7309000E-01	4.8833000E-01	8.8834000E-01
2.5108000E+03	6.3369000E-01	7.7305000E-01	4.8987000E-01	8.9114000E-01
2.5109000E+03	6.3569000E-01	7.7301000E-01	4.9140000E-01	8.9392000E-01
2.5110000E+03	6.3768000E-01	7.7298000E-01	4.9291000E-01	8.9667000E-01
2.5111000E+03	6.3966000E-01	7.7294000E-01	4.9442000E-01	8.9941000E-01
2.5112000E+03	6.4162000E-01	7.7291000E-01	4.9591000E-01	9.0212000E-01
2.5113000E+03	6.4356000E-01	7.7287000E-01	4.9739000E-01	9.0481000E-01
2.5114000E+03	6.4548000E-01	7.7284000E-01	4.9885000E-01	9.0747000E-01
2.5115000E+03	6.4739000E-01	7.7280000E-01	5.0030000E-01	9.1011000E-01
2.5116000E+03	6.4928000E-01	7.7277000E-01	5.0174000E-01	9.1273000E-01
2.5117000E+03	6.5115000E-01	7.7273000E-01	5.0316000E-01	9.1532000E-01
2.5118000E+03	6.5301000E-01	7.7270000E-01	5.0457000E-01	9.1788000E-01
2.5119000E+03	6.5484000E-01	7.7266000E-01	5.0597000E-01	9.2042000E-01
2.5120000E+03	6.5665000E-01	7.7262000E-01	5.0735000E-01	9.2293000E-01
2.5121000E+03	6.5845000E-01	7.7256000E-01	5.0869000E-01	9.2537000E-01
2.5122000E+03	6.6022000E-01	7.7249000E-01	5.1001000E-01	9.2778000E-01
2.5123000E+03	6.6198000E-01	7.7242000E-01	5.1132000E-01	9.3016000E-01
2.5124000E+03	6.6371000E-01	7.7235000E-01	5.1262000E-01	9.3251000E-01
2.5125000E+03	6.6542000E-01	7.7228000E-01	5.1389000E-01	9.3483000E-01
2.5126000E+03	6.6711000E-01	7.7221000E-01	5.1515000E-01	9.3712000E-01
2.5127000E+03	6.6877000E-01	7.7214000E-01	5.1639000E-01	9.3937000E-01

2.5128000E+03	6.7042000E-01	7.7207000E-01	5.1761000E-01	9.4160000E-01
2.5129000E+03	6.7204000E-01	7.7200000E-01	5.1881000E-01	9.4379000E-01
2.5130000E+03	6.7363000E-01	7.7194000E-01	5.2000000E-01	9.4594000E-01
2.5131000E+03	6.7520000E-01	7.7187000E-01	5.2117000E-01	9.4807000E-01
2.5132000E+03	6.7675000E-01	7.7180000E-01	5.2231000E-01	9.5015000E-01
2.5133000E+03	6.7827000E-01	7.7173000E-01	5.2344000E-01	9.5220000E-01
2.5134000E+03	6.7976000E-01	7.7166000E-01	5.2455000E-01	9.5422000E-01
2.5135000E+03	6.8123000E-01	7.7159000E-01	5.2563000E-01	9.5619000E-01
2.5136000E+03	6.8267000E-01	7.7153000E-01	5.2670000E-01	9.5813000E-01
2.5137000E+03	6.8409000E-01	7.7146000E-01	5.2774000E-01	9.6003000E-01
2.5138000E+03	6.8547000E-01	7.7139000E-01	5.2877000E-01	9.6189000E-01
2.5139000E+03	6.8683000E-01	7.7132000E-01	5.2977000E-01	9.6372000E-01
2.5140000E+03	6.8817000E-01	7.7125000E-01	5.3075000E-01	9.6550000E-01
2.5141000E+03	6.8947000E-01	7.7119000E-01	5.3171000E-01	9.6725000E-01
2.5142000E+03	6.9074000E-01	7.7113000E-01	5.3265000E-01	9.6896000E-01
2.5143000E+03	6.9198000E-01	7.7107000E-01	5.3357000E-01	9.7063000E-01
2.5144000E+03	6.9319000E-01	7.7101000E-01	5.3446000E-01	9.7225000E-01
2.5145000E+03	6.9438000E-01	7.7095000E-01	5.3533000E-01	9.7383000E-01
2.5146000E+03	6.9553000E-01	7.7089000E-01	5.3618000E-01	9.7537000E-01
2.5147000E+03	6.9665000E-01	7.7083000E-01	5.3700000E-01	9.7687000E-01
2.5148000E+03	6.9774000E-01	7.7077000E-01	5.3780000E-01	9.7832000E-01
2.5149000E+03	6.9880000E-01	7.7071000E-01	5.3857000E-01	9.7973000E-01
2.5150000E+03	6.9982000E-01	7.7065000E-01	5.3932000E-01	9.8109000E-01
2.5151000E+03	7.0082000E-01	7.7059000E-01	5.4004000E-01	9.8240000E-01
2.5152000E+03	7.0178000E-01	7.7053000E-01	5.4074000E-01	9.8366000E-01
2.5153000E+03	7.0270000E-01	7.7046000E-01	5.4141000E-01	9.8488000E-01
2.5154000E+03	7.0360000E-01	7.7040000E-01	5.4205000E-01	9.8606000E-01
2.5155000E+03	7.0446000E-01	7.7034000E-01	5.4267000E-01	9.8718000E-01
2.5156000E+03	7.0528000E-01	7.7027000E-01	5.4326000E-01	9.8826000E-01
2.5157000E+03	7.0608000E-01	7.7021000E-01	5.4383000E-01	9.8929000E-01
2.5158000E+03	7.0683000E-01	7.7015000E-01	5.4437000E-01	9.9027000E-01
2.5159000E+03	7.0756000E-01	7.7008000E-01	5.4488000E-01	9.9120000E-01
2.5160000E+03	7.0825000E-01	7.7002000E-01	5.4536000E-01	9.9209000E-01
2.5161000E+03	7.0890000E-01	7.6998000E-01	5.4584000E-01	9.9295000E-01
2.5162000E+03	7.0952000E-01	7.6995000E-01	5.4629000E-01	9.9377000E-01
2.5163000E+03	7.1010000E-01	7.6991000E-01	5.4671000E-01	9.9454000E-01
2.5164000E+03	7.1065000E-01	7.6987000E-01	5.4711000E-01	9.9526000E-01
2.5165000E+03	7.1116000E-01	7.6983000E-01	5.4747000E-01	9.9592000E-01
2.5166000E+03	7.1164000E-01	7.6979000E-01	5.4781000E-01	9.9654000E-01
2.5167000E+03	7.1208000E-01	7.6975000E-01	5.4813000E-01	9.9711000E-01
2.5168000E+03	7.1249000E-01	7.6972000E-01	5.4841000E-01	9.9763000E-01
2.5169000E+03	7.1285000E-01	7.6968000E-01	5.4867000E-01	9.9809000E-01
2.5170000E+03	7.1319000E-01	7.6964000E-01	5.4890000E-01	9.9851000E-01

2.5171000E+03	7.1348000E-01	7.6960000E-01	5.4910000E-01	9.9887000E-01
2.5172000E+03	7.1374000E-01	7.6956000E-01	5.4927000E-01	9.9919000E-01
2.5173000E+03	7.1397000E-01	7.6952000E-01	5.4941000E-01	9.9945000E-01
2.5174000E+03	7.1416000E-01	7.6948000E-01	5.4953000E-01	9.9966000E-01
2.5175000E+03	7.1431000E-01	7.6944000E-01	5.4962000E-01	9.9982000E-01
2.5176000E+03	7.1442000E-01	7.6940000E-01	5.4968000E-01	9.9993000E-01
2.5177000E+03	7.1450000E-01	7.6936000E-01	5.4971000E-01	9.9999000E-01
2.5178000E+03	7.1455000E-01	7.6932000E-01	5.4972000E-01	1.0000000E+00
2.5179000E+03	7.1455000E-01	7.6928000E-01	5.4969000E-01	9.9996000E-01
2.5180000E+03	7.1452000E-01	7.6924000E-01	5.4964000E-01	9.9986000E-01
2.5181000E+03	7.1446000E-01	7.6921000E-01	5.4957000E-01	9.9973000E-01
2.5182000E+03	7.1435000E-01	7.6918000E-01	5.4947000E-01	9.9954000E-01
2.5183000E+03	7.1422000E-01	7.6915000E-01	5.4934000E-01	9.9931000E-01
2.5184000E+03	7.1404000E-01	7.6911000E-01	5.4918000E-01	9.9902000E-01
2.5185000E+03	7.1383000E-01	7.6908000E-01	5.4899000E-01	9.9869000E-01
2.5186000E+03	7.1359000E-01	7.6905000E-01	5.4878000E-01	9.9830000E-01
2.5187000E+03	7.1330000E-01	7.6901000E-01	5.4854000E-01	9.9786000E-01
2.5188000E+03	7.1299000E-01	7.6898000E-01	5.4827000E-01	9.9738000E-01
2.5189000E+03	7.1264000E-01	7.6895000E-01	5.4798000E-01	9.9684000E-01
2.5190000E+03	7.1225000E-01	7.6891000E-01	5.4766000E-01	9.9626000E-01
2.5191000E+03	7.1183000E-01	7.6888000E-01	5.4731000E-01	9.9563000E-01
2.5192000E+03	7.1137000E-01	7.6885000E-01	5.4694000E-01	9.9495000E-01
2.5193000E+03	7.1087000E-01	7.6882000E-01	5.4654000E-01	9.9422000E-01
2.5194000E+03	7.1034000E-01	7.6879000E-01	5.4611000E-01	9.9344000E-01
2.5195000E+03	7.0978000E-01	7.6876000E-01	5.4565000E-01	9.9261000E-01
2.5196000E+03	7.0918000E-01	7.6873000E-01	5.4517000E-01	9.9174000E-01
2.5197000E+03	7.0855000E-01	7.6870000E-01	5.4467000E-01	9.9081000E-01
2.5198000E+03	7.0789000E-01	7.6867000E-01	5.4413000E-01	9.8984000E-01
2.5199000E+03	7.0718000E-01	7.6864000E-01	5.4357000E-01	9.8882000E-01
2.5200000E+03	7.0645000E-01	7.6861000E-01	5.4299000E-01	9.8776000E-01
2.5201000E+03	7.0568000E-01	7.6856000E-01	5.4236000E-01	9.8661000E-01
2.5202000E+03	7.0488000E-01	7.6850000E-01	5.4170000E-01	9.8542000E-01
2.5203000E+03	7.0404000E-01	7.6845000E-01	5.4102000E-01	9.8418000E-01
2.5204000E+03	7.0317000E-01	7.6839000E-01	5.4031000E-01	9.8289000E-01
2.5205000E+03	7.0227000E-01	7.6834000E-01	5.3958000E-01	9.8156000E-01
2.5206000E+03	7.0133000E-01	7.6828000E-01	5.3882000E-01	9.8018000E-01
2.5207000E+03	7.0036000E-01	7.6823000E-01	5.3804000E-01	9.7875000E-01
2.5208000E+03	6.9936000E-01	7.6817000E-01	5.3723000E-01	9.7728000E-01
2.5209000E+03	6.9832000E-01	7.6812000E-01	5.3639000E-01	9.7576000E-01
2.5210000E+03	6.9725000E-01	7.6806000E-01	5.3553000E-01	9.7420000E-01
2.5211000E+03	6.9615000E-01	7.6800000E-01	5.3465000E-01	9.7259000E-01
2.5212000E+03	6.9502000E-01	7.6794000E-01	5.3373000E-01	9.7092000E-01
2.5213000E+03	6.9385000E-01	7.6788000E-01	5.3279000E-01	9.6922000E-01

2.5214000E+03	6.9265000E-01	7.6782000E-01	5.3183000E-01	9.6747000E-01
2.5215000E+03	6.9142000E-01	7.6776000E-01	5.3085000E-01	9.6567000E-01
2.5216000E+03	6.9016000E-01	7.6770000E-01	5.2983000E-01	9.6383000E-01
2.5217000E+03	6.8886000E-01	7.6764000E-01	5.2880000E-01	9.6195000E-01
2.5218000E+03	6.8753000E-01	7.6758000E-01	5.2774000E-01	9.6002000E-01
2.5219000E+03	6.8617000E-01	7.6752000E-01	5.2665000E-01	9.5804000E-01
2.5220000E+03	6.8478000E-01	7.6746000E-01	5.2554000E-01	9.5602000E-01
2.5221000E+03	6.8335000E-01	7.6740000E-01	5.2440000E-01	9.5395000E-01
2.5222000E+03	6.8190000E-01	7.6733000E-01	5.2324000E-01	9.5184000E-01
2.5223000E+03	6.8041000E-01	7.6726000E-01	5.2205000E-01	9.4968000E-01
2.5224000E+03	6.7889000E-01	7.6719000E-01	5.2084000E-01	9.4747000E-01
2.5225000E+03	6.7734000E-01	7.6713000E-01	5.1960000E-01	9.4522000E-01
2.5226000E+03	6.7575000E-01	7.6706000E-01	5.1834000E-01	9.4293000E-01
2.5227000E+03	6.7414000E-01	7.6699000E-01	5.1706000E-01	9.4059000E-01
2.5228000E+03	6.7249000E-01	7.6693000E-01	5.1575000E-01	9.3821000E-01
2.5229000E+03	6.7081000E-01	7.6686000E-01	5.1442000E-01	9.3579000E-01
2.5230000E+03	6.6910000E-01	7.6679000E-01	5.1306000E-01	9.3332000E-01
2.5231000E+03	6.6736000E-01	7.6673000E-01	5.1168000E-01	9.3081000E-01
2.5232000E+03	6.6558000E-01	7.6666000E-01	5.1027000E-01	9.2825000E-01
2.5233000E+03	6.6378000E-01	7.6659000E-01	5.0884000E-01	9.2565000E-01
2.5234000E+03	6.6194000E-01	7.6652000E-01	5.0739000E-01	9.2300000E-01
2.5235000E+03	6.6006000E-01	7.6645000E-01	5.0591000E-01	9.2031000E-01
2.5236000E+03	6.5816000E-01	7.6638000E-01	5.0440000E-01	9.1757000E-01
2.5237000E+03	6.5623000E-01	7.6631000E-01	5.0288000E-01	9.1479000E-01
2.5238000E+03	6.5426000E-01	7.6625000E-01	5.0132000E-01	9.1197000E-01
2.5239000E+03	6.5226000E-01	7.6618000E-01	4.9975000E-01	9.0910000E-01
2.5240000E+03	6.5022000E-01	7.6611000E-01	4.9814000E-01	9.0619000E-01
2.5241000E+03	6.4816000E-01	7.6604000E-01	4.9652000E-01	9.0323000E-01
2.5242000E+03	6.4606000E-01	7.6597000E-01	4.9487000E-01	9.0022000E-01
2.5243000E+03	6.4393000E-01	7.6590000E-01	4.9319000E-01	8.9717000E-01
2.5244000E+03	6.4177000E-01	7.6584000E-01	4.9149000E-01	8.9408000E-01
2.5245000E+03	6.3957000E-01	7.6577000E-01	4.8976000E-01	8.9094000E-01
2.5246000E+03	6.3734000E-01	7.6570000E-01	4.8801000E-01	8.8776000E-01
2.5247000E+03	6.3508000E-01	7.6563000E-01	4.8624000E-01	8.8453000E-01
2.5248000E+03	6.3279000E-01	7.6556000E-01	4.8444000E-01	8.8125000E-01
2.5249000E+03	6.3046000E-01	7.6549000E-01	4.8261000E-01	8.7793000E-01
2.5250000E+03	6.2810000E-01	7.6543000E-01	4.8076000E-01	8.7456000E-01
2.5251000E+03	6.2570000E-01	7.6536000E-01	4.7889000E-01	8.7115000E-01
2.5252000E+03	6.2327000E-01	7.6530000E-01	4.7699000E-01	8.6770000E-01
2.5253000E+03	6.2081000E-01	7.6523000E-01	4.7507000E-01	8.6420000E-01
2.5254000E+03	6.1831000E-01	7.6517000E-01	4.7312000E-01	8.6066000E-01
2.5255000E+03	6.1579000E-01	7.6511000E-01	4.7114000E-01	8.5706000E-01
2.5256000E+03	6.1322000E-01	7.6504000E-01	4.6914000E-01	8.5342000E-01

2.5257000E+03	6.1063000E-01	7.6498000E-01	4.6711000E-01	8.4974000E-01
2.5258000E+03	6.0799000E-01	7.6491000E-01	4.6506000E-01	8.4601000E-01
2.5259000E+03	6.0533000E-01	7.6485000E-01	4.6299000E-01	8.4223000E-01
2.5260000E+03	6.0263000E-01	7.6478000E-01	4.6088000E-01	8.3840000E-01
2.5261000E+03	5.9990000E-01	7.6476000E-01	4.5878000E-01	8.3458000E-01
2.5262000E+03	5.9713000E-01	7.6474000E-01	4.5665000E-01	8.3071000E-01
2.5263000E+03	5.9433000E-01	7.6472000E-01	4.5450000E-01	8.2679000E-01
2.5264000E+03	5.9150000E-01	7.6470000E-01	4.5232000E-01	8.2282000E-01
2.5265000E+03	5.8863000E-01	7.6468000E-01	4.5011000E-01	8.1881000E-01
2.5266000E+03	5.8573000E-01	7.6466000E-01	4.4788000E-01	8.1475000E-01
2.5267000E+03	5.8279000E-01	7.6464000E-01	4.4562000E-01	8.1064000E-01
2.5268000E+03	5.7982000E-01	7.6462000E-01	4.4334000E-01	8.0649000E-01
2.5269000E+03	5.7681000E-01	7.6460000E-01	4.4103000E-01	8.0229000E-01
2.5270000E+03	5.7378000E-01	7.6458000E-01	4.3870000E-01	7.9804000E-01
2.5271000E+03	5.7070000E-01	7.6456000E-01	4.3634000E-01	7.9375000E-01
2.5272000E+03	5.6760000E-01	7.6454000E-01	4.3395000E-01	7.8941000E-01
2.5273000E+03	5.6446000E-01	7.6452000E-01	4.3154000E-01	7.8503000E-01
2.5274000E+03	5.6129000E-01	7.6451000E-01	4.2911000E-01	7.8060000E-01
2.5275000E+03	5.5808000E-01	7.6449000E-01	4.2665000E-01	7.7613000E-01
2.5276000E+03	5.5484000E-01	7.6447000E-01	4.2416000E-01	7.7160000E-01
2.5277000E+03	5.5157000E-01	7.6446000E-01	4.2165000E-01	7.6704000E-01
2.5278000E+03	5.4827000E-01	7.6444000E-01	4.1912000E-01	7.6243000E-01
2.5279000E+03	5.4493000E-01	7.6442000E-01	4.1656000E-01	7.5777000E-01
2.5280000E+03	5.4157000E-01	7.6440000E-01	4.1397000E-01	7.5307000E-01
2.5281000E+03	5.3817000E-01	7.6440000E-01	4.1137000E-01	7.4834000E-01
2.5282000E+03	5.3474000E-01	7.6440000E-01	4.0875000E-01	7.4357000E-01
2.5283000E+03	5.3127000E-01	7.6439000E-01	4.0610000E-01	7.3875000E-01
2.5284000E+03	5.2778000E-01	7.6439000E-01	4.0343000E-01	7.3389000E-01
2.5285000E+03	5.2426000E-01	7.6439000E-01	4.0073000E-01	7.2898000E-01
2.5286000E+03	5.2070000E-01	7.6438000E-01	3.9802000E-01	7.2404000E-01
2.5287000E+03	5.1712000E-01	7.6438000E-01	3.9528000E-01	7.1905000E-01
2.5288000E+03	5.1351000E-01	7.6438000E-01	3.9251000E-01	7.1403000E-01
2.5289000E+03	5.0986000E-01	7.6437000E-01	3.8973000E-01	7.0896000E-01
2.5290000E+03	5.0620000E-01	7.6437000E-01	3.8692000E-01	7.0386000E-01
2.5291000E+03	5.0250000E-01	7.6436000E-01	3.8409000E-01	6.9871000E-01
2.5292000E+03	4.9877000E-01	7.6436000E-01	3.8124000E-01	6.9352000E-01
2.5293000E+03	4.9502000E-01	7.6435000E-01	3.7837000E-01	6.8830000E-01
2.5294000E+03	4.9124000E-01	7.6434000E-01	3.7548000E-01	6.8304000E-01
2.5295000E+03	4.8744000E-01	7.6434000E-01	3.7257000E-01	6.7775000E-01
2.5296000E+03	4.8361000E-01	7.6433000E-01	3.6964000E-01	6.7242000E-01
2.5297000E+03	4.7976000E-01	7.6432000E-01	3.6669000E-01	6.6706000E-01
2.5298000E+03	4.7588000E-01	7.6432000E-01	3.6373000E-01	6.6166000E-01
2.5299000E+03	4.7198000E-01	7.6431000E-01	3.6074000E-01	6.5624000E-01

2.5300000E+03	4.6806000E-01	7.6430000E-01	3.5774000E-01	6.5078000E-01
2.5301000E+03	4.6412000E-01	7.6427000E-01	3.5471000E-01	6.4526000E-01
2.5302000E+03	4.6015000E-01	7.6423000E-01	3.5166000E-01	6.3972000E-01
2.5303000E+03	4.5617000E-01	7.6419000E-01	3.4860000E-01	6.3415000E-01
2.5304000E+03	4.5217000E-01	7.6415000E-01	3.4552000E-01	6.2855000E-01
2.5305000E+03	4.4814000E-01	7.6411000E-01	3.4243000E-01	6.2293000E-01
2.5306000E+03	4.4410000E-01	7.6408000E-01	3.3933000E-01	6.1728000E-01
2.5307000E+03	4.4004000E-01	7.6404000E-01	3.3621000E-01	6.1161000E-01
2.5308000E+03	4.3597000E-01	7.6400000E-01	3.3308000E-01	6.0592000E-01
2.5309000E+03	4.3188000E-01	7.6396000E-01	3.2994000E-01	6.0021000E-01
2.5310000E+03	4.2778000E-01	7.6392000E-01	3.2679000E-01	5.9447000E-01
2.5311000E+03	4.2366000E-01	7.6389000E-01	3.2363000E-01	5.8873000E-01
2.5312000E+03	4.1953000E-01	7.6385000E-01	3.2046000E-01	5.8296000E-01
2.5313000E+03	4.1539000E-01	7.6381000E-01	3.1728000E-01	5.7718000E-01
2.5314000E+03	4.1124000E-01	7.6377000E-01	3.1410000E-01	5.7138000E-01
2.5315000E+03	4.0708000E-01	7.6374000E-01	3.1090000E-01	5.6557000E-01
2.5316000E+03	4.0291000E-01	7.6370000E-01	3.0770000E-01	5.5975000E-01
2.5317000E+03	3.9873000E-01	7.6366000E-01	3.0450000E-01	5.5392000E-01
2.5318000E+03	3.9455000E-01	7.6362000E-01	3.0129000E-01	5.4808000E-01
2.5319000E+03	3.9036000E-01	7.6359000E-01	2.9807000E-01	5.4223000E-01
2.5320000E+03	3.8616000E-01	7.6355000E-01	2.9485000E-01	5.3637000E-01
2.5321000E+03	3.8196000E-01	7.6349000E-01	2.9163000E-01	5.3050000E-01
2.5322000E+03	3.7776000E-01	7.6343000E-01	2.8840000E-01	5.2463000E-01
2.5323000E+03	3.7356000E-01	7.6338000E-01	2.8516000E-01	5.1875000E-01
2.5324000E+03	3.6935000E-01	7.6332000E-01	2.8193000E-01	5.1287000E-01
2.5325000E+03	3.6515000E-01	7.6326000E-01	2.7870000E-01	5.0699000E-01
2.5326000E+03	3.6094000E-01	7.6320000E-01	2.7547000E-01	5.0112000E-01
2.5327000E+03	3.5675000E-01	7.6314000E-01	2.7225000E-01	4.9525000E-01
2.5328000E+03	3.5255000E-01	7.6309000E-01	2.6902000E-01	4.8939000E-01
2.5329000E+03	3.4835000E-01	7.6303000E-01	2.6581000E-01	4.8353000E-01
2.5330000E+03	3.4417000E-01	7.6297000E-01	2.6259000E-01	4.7768000E-01
2.5331000E+03	3.3999000E-01	7.6292000E-01	2.5938000E-01	4.7185000E-01
2.5332000E+03	3.3581000E-01	7.6287000E-01	2.5618000E-01	4.6602000E-01
2.5333000E+03	3.3165000E-01	7.6281000E-01	2.5299000E-01	4.6021000E-01
2.5334000E+03	3.2749000E-01	7.6276000E-01	2.4980000E-01	4.5441000E-01
2.5335000E+03	3.2335000E-01	7.6271000E-01	2.4662000E-01	4.4863000E-01
2.5336000E+03	3.1922000E-01	7.6265000E-01	2.4345000E-01	4.4287000E-01
2.5337000E+03	3.1510000E-01	7.6260000E-01	2.4029000E-01	4.3712000E-01
2.5338000E+03	3.1099000E-01	7.6255000E-01	2.3714000E-01	4.3139000E-01
2.5339000E+03	3.0690000E-01	7.6250000E-01	2.3401000E-01	4.2569000E-01
2.5340000E+03	3.0282000E-01	7.6244000E-01	2.3088000E-01	4.2001000E-01
2.5341000E+03	2.9876000E-01	7.6239000E-01	2.2777000E-01	4.1435000E-01
2.5342000E+03	2.9472000E-01	7.6235000E-01	2.2468000E-01	4.0871000E-01

2.5343000E+03	2.9070000E-01	7.6230000E-01	2.2160000E-01	4.0311000E-01
2.5344000E+03	2.8669000E-01	7.6225000E-01	2.1853000E-01	3.9753000E-01
2.5345000E+03	2.8271000E-01	7.6220000E-01	2.1548000E-01	3.9198000E-01
2.5346000E+03	2.7874000E-01	7.6215000E-01	2.1244000E-01	3.8646000E-01
2.5347000E+03	2.7480000E-01	7.6210000E-01	2.0943000E-01	3.8097000E-01
2.5348000E+03	2.7088000E-01	7.6205000E-01	2.0643000E-01	3.7552000E-01
2.5349000E+03	2.6699000E-01	7.6201000E-01	2.0345000E-01	3.7010000E-01
2.5350000E+03	2.6312000E-01	7.6196000E-01	2.0049000E-01	3.6471000E-01
2.5351000E+03	2.5928000E-01	7.6191000E-01	1.9754000E-01	3.5936000E-01
2.5352000E+03	2.5546000E-01	7.6186000E-01	1.9462000E-01	3.5404000E-01
2.5353000E+03	2.5167000E-01	7.6181000E-01	1.9172000E-01	3.4877000E-01
2.5354000E+03	2.4791000E-01	7.6176000E-01	1.8884000E-01	3.4353000E-01
2.5355000E+03	2.4417000E-01	7.6171000E-01	1.8599000E-01	3.3833000E-01
2.5356000E+03	2.4047000E-01	7.6167000E-01	1.8315000E-01	3.3318000E-01
2.5357000E+03	2.3679000E-01	7.6162000E-01	1.8034000E-01	3.2807000E-01
2.5358000E+03	2.3314000E-01	7.6157000E-01	1.7756000E-01	3.2299000E-01
2.5359000E+03	2.2953000E-01	7.6152000E-01	1.7479000E-01	3.1797000E-01
2.5360000E+03	2.2595000E-01	7.6147000E-01	1.7205000E-01	3.1299000E-01
2.5361000E+03	2.2240000E-01	7.6145000E-01	1.6935000E-01	3.0806000E-01
2.5362000E+03	2.1888000E-01	7.6143000E-01	1.6666000E-01	3.0318000E-01
2.5363000E+03	2.1540000E-01	7.6141000E-01	1.6401000E-01	2.9835000E-01
2.5364000E+03	2.1195000E-01	7.6139000E-01	1.6138000E-01	2.9356000E-01
2.5365000E+03	2.0853000E-01	7.6137000E-01	1.5877000E-01	2.8883000E-01
2.5366000E+03	2.0515000E-01	7.6135000E-01	1.5619000E-01	2.8414000E-01
2.5367000E+03	2.0181000E-01	7.6133000E-01	1.5364000E-01	2.7950000E-01
2.5368000E+03	1.9850000E-01	7.6131000E-01	1.5112000E-01	2.7491000E-01
2.5369000E+03	1.9523000E-01	7.6129000E-01	1.4863000E-01	2.7037000E-01
2.5370000E+03	1.9199000E-01	7.6127000E-01	1.4616000E-01	2.6588000E-01
2.5371000E+03	1.8879000E-01	7.6126000E-01	1.4372000E-01	2.6144000E-01
2.5372000E+03	1.8563000E-01	7.6124000E-01	1.4131000E-01	2.5706000E-01
2.5373000E+03	1.8251000E-01	7.6123000E-01	1.3893000E-01	2.5273000E-01
2.5374000E+03	1.7942000E-01	7.6121000E-01	1.3658000E-01	2.4845000E-01
2.5375000E+03	1.7637000E-01	7.6120000E-01	1.3425000E-01	2.4422000E-01
2.5376000E+03	1.7336000E-01	7.6118000E-01	1.3196000E-01	2.4005000E-01
2.5377000E+03	1.7039000E-01	7.6117000E-01	1.2969000E-01	2.3593000E-01
2.5378000E+03	1.6745000E-01	7.6115000E-01	1.2746000E-01	2.3186000E-01
2.5379000E+03	1.6456000E-01	7.6114000E-01	1.2525000E-01	2.2785000E-01
2.5380000E+03	1.6170000E-01	7.6112000E-01	1.2307000E-01	2.2389000E-01
2.5381000E+03	1.5889000E-01	7.6113000E-01	1.2093000E-01	2.1999000E-01
2.5382000E+03	1.5611000E-01	7.6114000E-01	1.1882000E-01	2.1615000E-01
2.5383000E+03	1.5337000E-01	7.6116000E-01	1.1674000E-01	2.1236000E-01
2.5384000E+03	1.5067000E-01	7.6117000E-01	1.1468000E-01	2.0862000E-01
2.5385000E+03	1.4800000E-01	7.6118000E-01	1.1266000E-01	2.0494000E-01

2.5386000E+03	1.4538000E-01	7.6119000E-01	1.1066000E-01	2.0131000E-01
2.5387000E+03	1.4280000E-01	7.6121000E-01	1.0870000E-01	1.9773000E-01
2.5388000E+03	1.4025000E-01	7.6122000E-01	1.0676000E-01	1.9421000E-01
2.5389000E+03	1.3774000E-01	7.6123000E-01	1.0486000E-01	1.9074000E-01
2.5390000E+03	1.3528000E-01	7.6125000E-01	1.0298000E-01	1.8733000E-01
2.5391000E+03	1.3285000E-01	7.6126000E-01	1.0113000E-01	1.8397000E-01
2.5392000E+03	1.3045000E-01	7.6127000E-01	9.9311000E-02	1.8066000E-01
2.5393000E+03	1.2810000E-01	7.6128000E-01	9.7520000E-02	1.7740000E-01
2.5394000E+03	1.2578000E-01	7.6130000E-01	9.5760000E-02	1.7420000E-01
2.5395000E+03	1.2351000E-01	7.6131000E-01	9.4027000E-02	1.7105000E-01
2.5396000E+03	1.2127000E-01	7.6132000E-01	9.2323000E-02	1.6795000E-01
2.5397000E+03	1.1906000E-01	7.6134000E-01	9.0647000E-02	1.6490000E-01
2.5398000E+03	1.1690000E-01	7.6135000E-01	8.8999000E-02	1.6190000E-01
2.5399000E+03	1.1477000E-01	7.6136000E-01	8.7378000E-02	1.5895000E-01
2.5400000E+03	1.1267000E-01	7.6137000E-01	8.5786000E-02	1.5606000E-01
2.5401000E+03	1.1062000E-01	7.6137000E-01	8.4219000E-02	1.5320000E-01
2.5402000E+03	1.0859000E-01	7.6136000E-01	8.2679000E-02	1.5040000E-01
2.5403000E+03	1.0661000E-01	7.6135000E-01	8.1165000E-02	1.4765000E-01
2.5404000E+03	1.0466000E-01	7.6134000E-01	7.9679000E-02	1.4495000E-01
2.5405000E+03	1.0274000E-01	7.6134000E-01	7.8219000E-02	1.4229000E-01
2.5406000E+03	1.0086000E-01	7.6133000E-01	7.6785000E-02	1.3968000E-01
2.5407000E+03	9.9009000E-02	7.6132000E-01	7.5378000E-02	1.3712000E-01
2.5408000E+03	9.7194000E-02	7.6131000E-01	7.3995000E-02	1.3461000E-01
2.5409000E+03	9.5413000E-02	7.6131000E-01	7.2638000E-02	1.3214000E-01
2.5410000E+03	9.3664000E-02	7.6130000E-01	7.1306000E-02	1.2971000E-01
2.5411000E+03	9.1948000E-02	7.6129000E-01	6.9999000E-02	1.2734000E-01
2.5412000E+03	9.0263000E-02	7.6129000E-01	6.8716000E-02	1.2500000E-01
2.5413000E+03	8.8610000E-02	7.6128000E-01	6.7457000E-02	1.2271000E-01
2.5414000E+03	8.6989000E-02	7.6127000E-01	6.6222000E-02	1.2047000E-01
2.5415000E+03	8.5397000E-02	7.6127000E-01	6.5010000E-02	1.1826000E-01
2.5416000E+03	8.3837000E-02	7.6127000E-01	6.3822000E-02	1.1610000E-01
2.5417000E+03	8.2306000E-02	7.6127000E-01	6.2656000E-02	1.1398000E-01
2.5418000E+03	8.0804000E-02	7.6127000E-01	6.1513000E-02	1.1190000E-01
2.5419000E+03	7.9331000E-02	7.6126000E-01	6.0392000E-02	1.0986000E-01
2.5420000E+03	7.7887000E-02	7.6126000E-01	5.9292000E-02	1.0786000E-01
2.5421000E+03	7.6470000E-02	7.6124000E-01	5.8212000E-02	1.0590000E-01
2.5422000E+03	7.5081000E-02	7.6122000E-01	5.7153000E-02	1.0397000E-01
2.5423000E+03	7.3720000E-02	7.6120000E-01	5.6115000E-02	1.0208000E-01
2.5424000E+03	7.2385000E-02	7.6118000E-01	5.5097000E-02	1.0023000E-01
2.5425000E+03	7.1076000E-02	7.6115000E-01	5.4100000E-02	9.8414000E-02
2.5426000E+03	6.9793000E-02	7.6113000E-01	5.3121000E-02	9.6634000E-02
2.5427000E+03	6.8535000E-02	7.6111000E-01	5.2162000E-02	9.4890000E-02
2.5428000E+03	6.7301000E-02	7.6109000E-01	5.1222000E-02	9.3180000E-02

2.5429000E+03	6.6093000E-02	7.6107000E-01	5.0301000E-02	9.1504000E-02
2.5430000E+03	6.4908000E-02	7.6104000E-01	4.9398000E-02	8.9861000E-02
2.5431000E+03	6.3747000E-02	7.6102000E-01	4.8512000E-02	8.8250000E-02
2.5432000E+03	6.2609000E-02	7.6099000E-01	4.7645000E-02	8.6672000E-02
2.5433000E+03	6.1493000E-02	7.6097000E-01	4.6794000E-02	8.5124000E-02
2.5434000E+03	6.0400000E-02	7.6094000E-01	4.5961000E-02	8.3608000E-02
2.5435000E+03	5.9328000E-02	7.6091000E-01	4.5144000E-02	8.2122000E-02
2.5436000E+03	5.8278000E-02	7.6089000E-01	4.4343000E-02	8.0665000E-02
2.5437000E+03	5.7249000E-02	7.6086000E-01	4.3558000E-02	7.9238000E-02
2.5438000E+03	5.6240000E-02	7.6083000E-01	4.2789000E-02	7.7839000E-02
2.5439000E+03	5.5251000E-02	7.6081000E-01	4.2036000E-02	7.6468000E-02
2.5440000E+03	5.4282000E-02	7.6078000E-01	4.1297000E-02	7.5124000E-02
2.5441000E+03	5.3333000E-02	7.6071000E-01	4.0571000E-02	7.3803000E-02
2.5442000E+03	5.2402000E-02	7.6064000E-01	3.9859000E-02	7.2509000E-02
2.5443000E+03	5.1490000E-02	7.6057000E-01	3.9162000E-02	7.1240000E-02
2.5444000E+03	5.0596000E-02	7.6050000E-01	3.8478000E-02	6.9996000E-02
2.5445000E+03	4.9720000E-02	7.6043000E-01	3.7808000E-02	6.8778000E-02
2.5446000E+03	4.8861000E-02	7.6036000E-01	3.7152000E-02	6.7583000E-02
2.5447000E+03	4.8019000E-02	7.6029000E-01	3.6508000E-02	6.6413000E-02
2.5448000E+03	4.7194000E-02	7.6021000E-01	3.5878000E-02	6.5266000E-02
2.5449000E+03	4.6386000E-02	7.6014000E-01	3.5260000E-02	6.4142000E-02
2.5450000E+03	4.5593000E-02	7.6007000E-01	3.4654000E-02	6.3040000E-02
2.5451000E+03	4.4816000E-02	7.6000000E-01	3.4060000E-02	6.1960000E-02
2.5452000E+03	4.4055000E-02	7.5992000E-01	3.3478000E-02	6.0901000E-02
2.5453000E+03	4.3308000E-02	7.5985000E-01	3.2908000E-02	5.9863000E-02
2.5454000E+03	4.2576000E-02	7.5977000E-01	3.2348000E-02	5.8845000E-02
2.5455000E+03	4.1859000E-02	7.5970000E-01	3.1800000E-02	5.7848000E-02
2.5456000E+03	4.1156000E-02	7.5962000E-01	3.1263000E-02	5.6871000E-02
2.5457000E+03	4.0466000E-02	7.5955000E-01	3.0736000E-02	5.5913000E-02
2.5458000E+03	3.9790000E-02	7.5947000E-01	3.0220000E-02	5.4973000E-02
2.5459000E+03	3.9128000E-02	7.5940000E-01	2.9713000E-02	5.4052000E-02
2.5460000E+03	3.8478000E-02	7.5932000E-01	2.9217000E-02	5.3150000E-02
2.5461000E+03	3.7841000E-02	7.5926000E-01	2.8731000E-02	5.2266000E-02
2.5462000E+03	3.7217000E-02	7.5920000E-01	2.8255000E-02	5.1399000E-02
2.5463000E+03	3.6604000E-02	7.5914000E-01	2.7788000E-02	5.0550000E-02
2.5464000E+03	3.6004000E-02	7.5909000E-01	2.7330000E-02	4.9717000E-02
2.5465000E+03	3.5415000E-02	7.5903000E-01	2.6881000E-02	4.8900000E-02
2.5466000E+03	3.4838000E-02	7.5897000E-01	2.6441000E-02	4.8099000E-02
2.5467000E+03	3.4272000E-02	7.5891000E-01	2.6009000E-02	4.7314000E-02
2.5468000E+03	3.3717000E-02	7.5885000E-01	2.5586000E-02	4.6544000E-02
2.5469000E+03	3.3173000E-02	7.5879000E-01	2.5171000E-02	4.5790000E-02
2.5470000E+03	3.2639000E-02	7.5873000E-01	2.4764000E-02	4.5049000E-02
2.5471000E+03	3.2116000E-02	7.5867000E-01	2.4365000E-02	4.4324000E-02

2.5472000E+03	3.1603000E-02	7.5861000E-01	2.3974000E-02	4.3612000E-02
2.5473000E+03	3.1100000E-02	7.5855000E-01	2.3591000E-02	4.2915000E-02
2.5474000E+03	3.0606000E-02	7.5850000E-01	2.3215000E-02	4.2230000E-02
2.5475000E+03	3.0122000E-02	7.5844000E-01	2.2846000E-02	4.1559000E-02
2.5476000E+03	2.9648000E-02	7.5838000E-01	2.2484000E-02	4.0901000E-02
2.5477000E+03	2.9182000E-02	7.5832000E-01	2.2130000E-02	4.0256000E-02
2.5478000E+03	2.8726000E-02	7.5826000E-01	2.1782000E-02	3.9624000E-02
2.5479000E+03	2.8278000E-02	7.5821000E-01	2.1441000E-02	3.9003000E-02
2.5480000E+03	2.7839000E-02	7.5815000E-01	2.1106000E-02	3.8395000E-02
2.5481000E+03	2.7409000E-02	7.5812000E-01	2.0779000E-02	3.7800000E-02
2.5482000E+03	2.6986000E-02	7.5809000E-01	2.0458000E-02	3.7216000E-02
2.5483000E+03	2.6572000E-02	7.5806000E-01	2.0144000E-02	3.6644000E-02
2.5484000E+03	2.6166000E-02	7.5803000E-01	1.9835000E-02	3.6082000E-02
2.5485000E+03	2.5768000E-02	7.5801000E-01	1.9532000E-02	3.5532000E-02
2.5486000E+03	2.5378000E-02	7.5798000E-01	1.9236000E-02	3.4992000E-02
2.5487000E+03	2.4994000E-02	7.5795000E-01	1.8945000E-02	3.4462000E-02
2.5488000E+03	2.4619000E-02	7.5792000E-01	1.8659000E-02	3.3943000E-02
2.5489000E+03	2.4250000E-02	7.5789000E-01	1.8379000E-02	3.3434000E-02
2.5490000E+03	2.3889000E-02	7.5786000E-01	1.8105000E-02	3.2935000E-02
2.5491000E+03	2.3535000E-02	7.5784000E-01	1.7836000E-02	3.2445000E-02
2.5492000E+03	2.3187000E-02	7.5781000E-01	1.7572000E-02	3.1965000E-02
2.5493000E+03	2.2846000E-02	7.5778000E-01	1.7313000E-02	3.1494000E-02
2.5494000E+03	2.2512000E-02	7.5775000E-01	1.7059000E-02	3.1032000E-02
2.5495000E+03	2.2184000E-02	7.5772000E-01	1.6810000E-02	3.0579000E-02
2.5496000E+03	2.1863000E-02	7.5770000E-01	1.6565000E-02	3.0134000E-02
2.5497000E+03	2.1548000E-02	7.5767000E-01	1.6326000E-02	2.9699000E-02
2.5498000E+03	2.1238000E-02	7.5764000E-01	1.6091000E-02	2.9271000E-02
2.5499000E+03	2.0935000E-02	7.5761000E-01	1.5861000E-02	2.8852000E-02
2.5500000E+03	2.0637000E-02	7.5758000E-01	1.5635000E-02	2.8441000E-02
2.5501000E+03	2.0346000E-02	7.5756000E-01	1.5413000E-02	2.8038000E-02
2.5502000E+03	2.0059000E-02	7.5754000E-01	1.5196000E-02	2.7643000E-02
2.5503000E+03	1.9779000E-02	7.5752000E-01	1.4983000E-02	2.7256000E-02
2.5504000E+03	1.9503000E-02	7.5750000E-01	1.4774000E-02	2.6876000E-02
2.5505000E+03	1.9233000E-02	7.5748000E-01	1.4569000E-02	2.6503000E-02
2.5506000E+03	1.8969000E-02	7.5746000E-01	1.4368000E-02	2.6137000E-02
2.5507000E+03	1.8709000E-02	7.5744000E-01	1.4171000E-02	2.5778000E-02
2.5508000E+03	1.8454000E-02	7.5742000E-01	1.3977000E-02	2.5426000E-02
2.5509000E+03	1.8204000E-02	7.5741000E-01	1.3787000E-02	2.5081000E-02
2.5510000E+03	1.7958000E-02	7.5739000E-01	1.3601000E-02	2.4743000E-02
2.5511000E+03	1.7718000E-02	7.5737000E-01	1.3419000E-02	2.4410000E-02
2.5512000E+03	1.7482000E-02	7.5735000E-01	1.3240000E-02	2.4085000E-02
2.5513000E+03	1.7250000E-02	7.5734000E-01	1.3064000E-02	2.3765000E-02
2.5514000E+03	1.7022000E-02	7.5732000E-01	1.2891000E-02	2.3451000E-02

2.5515000E+03	1.6799000E-02	7.5730000E-01	1.2722000E-02	2.3143000E-02
2.5516000E+03	1.6580000E-02	7.5728000E-01	1.2556000E-02	2.2841000E-02
2.5517000E+03	1.6366000E-02	7.5727000E-01	1.2393000E-02	2.2545000E-02
2.5518000E+03	1.6155000E-02	7.5725000E-01	1.2233000E-02	2.2254000E-02
2.5519000E+03	1.5948000E-02	7.5723000E-01	1.2076000E-02	2.1968000E-02
2.5520000E+03	1.5745000E-02	7.5722000E-01	1.1922000E-02	2.1688000E-02
2.5521000E+03	1.5546000E-02	7.5721000E-01	1.1771000E-02	2.1413000E-02
2.5522000E+03	1.5350000E-02	7.5720000E-01	1.1623000E-02	2.1144000E-02
2.5523000E+03	1.5158000E-02	7.5720000E-01	1.1477000E-02	2.0879000E-02
2.5524000E+03	1.4969000E-02	7.5719000E-01	1.1335000E-02	2.0619000E-02
2.5525000E+03	1.4784000E-02	7.5718000E-01	1.1194000E-02	2.0364000E-02
2.5526000E+03	1.4602000E-02	7.5718000E-01	1.1057000E-02	2.0113000E-02
2.5527000E+03	1.4424000E-02	7.5717000E-01	1.0921000E-02	1.9867000E-02
2.5528000E+03	1.4248000E-02	7.5716000E-01	1.0788000E-02	1.9625000E-02
2.5529000E+03	1.4076000E-02	7.5716000E-01	1.0658000E-02	1.9388000E-02
2.5530000E+03	1.3907000E-02	7.5715000E-01	1.0530000E-02	1.9155000E-02
2.5531000E+03	1.3741000E-02	7.5714000E-01	1.0404000E-02	1.8926000E-02
2.5532000E+03	1.3578000E-02	7.5714000E-01	1.0280000E-02	1.8701000E-02
2.5533000E+03	1.3417000E-02	7.5713000E-01	1.0159000E-02	1.8480000E-02
2.5534000E+03	1.3260000E-02	7.5713000E-01	1.0039000E-02	1.8263000E-02
2.5535000E+03	1.3105000E-02	7.5712000E-01	9.9219000E-03	1.8049000E-02
2.5536000E+03	1.2953000E-02	7.5711000E-01	9.8067000E-03	1.7840000E-02
2.5537000E+03	1.2803000E-02	7.5711000E-01	9.6933000E-03	1.7633000E-02
2.5538000E+03	1.2656000E-02	7.5710000E-01	9.5820000E-03	1.7431000E-02
2.5539000E+03	1.2512000E-02	7.5709000E-01	9.4725000E-03	1.7232000E-02
2.5540000E+03	1.2370000E-02	7.5709000E-01	9.3650000E-03	1.7036000E-02
2.5541000E+03	1.2230000E-02	7.5705000E-01	9.2589000E-03	1.6843000E-02
2.5542000E+03	1.2093000E-02	7.5702000E-01	9.1546000E-03	1.6653000E-02
2.5543000E+03	1.1958000E-02	7.5698000E-01	9.0520000E-03	1.6467000E-02
2.5544000E+03	1.1825000E-02	7.5695000E-01	8.9512000E-03	1.6283000E-02
2.5545000E+03	1.1695000E-02	7.5691000E-01	8.8521000E-03	1.6103000E-02
2.5546000E+03	1.1567000E-02	7.5688000E-01	8.7546000E-03	1.5926000E-02
2.5547000E+03	1.1441000E-02	7.5685000E-01	8.6588000E-03	1.5751000E-02
2.5548000E+03	1.1316000E-02	7.5681000E-01	8.5644000E-03	1.5580000E-02
2.5549000E+03	1.1195000E-02	7.5678000E-01	8.4718000E-03	1.5411000E-02
2.5550000E+03	1.1075000E-02	7.5674000E-01	8.3806000E-03	1.5245000E-02
2.5551000E+03	1.0957000E-02	7.5671000E-01	8.2909000E-03	1.5082000E-02
2.5552000E+03	1.0841000E-02	7.5667000E-01	8.2028000E-03	1.4922000E-02
2.5553000E+03	1.0726000E-02	7.5664000E-01	8.1160000E-03	1.4764000E-02
2.5554000E+03	1.0614000E-02	7.5660000E-01	8.0307000E-03	1.4609000E-02
2.5555000E+03	1.0504000E-02	7.5657000E-01	7.9468000E-03	1.4456000E-02
2.5556000E+03	1.0395000E-02	7.5653000E-01	7.8643000E-03	1.4306000E-02
2.5557000E+03	1.0288000E-02	7.5649000E-01	7.7830000E-03	1.4158000E-02

2.5558000E+03	1.0183000E-02	7.5646000E-01	7.7032000E-03	1.4013000E-02
2.5559000E+03	1.0080000E-02	7.5642000E-01	7.6247000E-03	1.3870000E-02
2.5560000E+03	9.9783000E-03	7.5639000E-01	7.5475000E-03	1.3730000E-02
2.5561000E+03	9.8783000E-03	7.5632000E-01	7.4712000E-03	1.3591000E-02
2.5562000E+03	9.7800000E-03	7.5626000E-01	7.3962000E-03	1.3455000E-02
2.5563000E+03	9.6833000E-03	7.5619000E-01	7.3225000E-03	1.3321000E-02
2.5564000E+03	9.5882000E-03	7.5613000E-01	7.2500000E-03	1.3189000E-02
2.5565000E+03	9.4948000E-03	7.5607000E-01	7.1787000E-03	1.3059000E-02
2.5566000E+03	9.4028000E-03	7.5600000E-01	7.1085000E-03	1.2931000E-02
2.5567000E+03	9.3124000E-03	7.5594000E-01	7.0396000E-03	1.2806000E-02
2.5568000E+03	9.2235000E-03	7.5587000E-01	6.9718000E-03	1.2683000E-02
2.5569000E+03	9.1362000E-03	7.5581000E-01	6.9052000E-03	1.2561000E-02
2.5570000E+03	9.0503000E-03	7.5574000E-01	6.8397000E-03	1.2442000E-02
2.5571000E+03	8.9658000E-03	7.5569000E-01	6.7754000E-03	1.2325000E-02
2.5572000E+03	8.8828000E-03	7.5564000E-01	6.7122000E-03	1.2210000E-02
2.5573000E+03	8.8012000E-03	7.5558000E-01	6.6500000E-03	1.2097000E-02
2.5574000E+03	8.7211000E-03	7.5553000E-01	6.5890000E-03	1.1986000E-02
2.5575000E+03	8.6422000E-03	7.5547000E-01	6.5290000E-03	1.1877000E-02
2.5576000E+03	8.5648000E-03	7.5542000E-01	6.4700000E-03	1.1770000E-02
2.5577000E+03	8.4887000E-03	7.5537000E-01	6.4121000E-03	1.1664000E-02
2.5578000E+03	8.4140000E-03	7.5531000E-01	6.3552000E-03	1.1561000E-02
2.5579000E+03	8.3405000E-03	7.5526000E-01	6.2993000E-03	1.1459000E-02
2.5580000E+03	8.2684000E-03	7.5521000E-01	6.2443000E-03	1.1359000E-02
2.5581000E+03	8.1975000E-03	7.5516000E-01	6.1905000E-03	1.1261000E-02
2.5582000E+03	8.1279000E-03	7.5512000E-01	6.1375000E-03	1.1165000E-02
2.5583000E+03	8.0595000E-03	7.5508000E-01	6.0856000E-03	1.1070000E-02
2.5584000E+03	7.9923000E-03	7.5504000E-01	6.0345000E-03	1.0978000E-02
2.5585000E+03	7.9264000E-03	7.5499000E-01	5.9844000E-03	1.0886000E-02
2.5586000E+03	7.8616000E-03	7.5495000E-01	5.9351000E-03	1.0797000E-02
2.5587000E+03	7.7980000E-03	7.5491000E-01	5.8868000E-03	1.0709000E-02
2.5588000E+03	7.7355000E-03	7.5487000E-01	5.8393000E-03	1.0622000E-02
2.5589000E+03	7.6742000E-03	7.5482000E-01	5.7926000E-03	1.0538000E-02
2.5590000E+03	7.6139000E-03	7.5478000E-01	5.7469000E-03	1.0454000E-02
2.5591000E+03	7.5548000E-03	7.5474000E-01	5.7019000E-03	1.0372000E-02
2.5592000E+03	7.4967000E-03	7.5470000E-01	5.6578000E-03	1.0292000E-02
2.5593000E+03	7.4396000E-03	7.5467000E-01	5.6144000E-03	1.0213000E-02
2.5594000E+03	7.3836000E-03	7.5463000E-01	5.5719000E-03	1.0136000E-02
2.5595000E+03	7.3285000E-03	7.5459000E-01	5.5300000E-03	1.0060000E-02
2.5596000E+03	7.2745000E-03	7.5455000E-01	5.4890000E-03	9.9851000E-03
2.5597000E+03	7.2214000E-03	7.5451000E-01	5.4486000E-03	9.9117000E-03
2.5598000E+03	7.1692000E-03	7.5447000E-01	5.4090000E-03	9.8396000E-03
2.5599000E+03	7.1180000E-03	7.5444000E-01	5.3701000E-03	9.7688000E-03
2.5600000E+03	7.0676000E-03	7.5440000E-01	5.3318000E-03	9.6992000E-03

2.5601000E+03	7.0181000E-03	7.5437000E-01	5.2943000E-03	9.6309000E-03
2.5602000E+03	6.9695000E-03	7.5435000E-01	5.2574000E-03	9.5639000E-03
2.5603000E+03	6.9216000E-03	7.5432000E-01	5.2211000E-03	9.4979000E-03
2.5604000E+03	6.8746000E-03	7.5430000E-01	5.1855000E-03	9.4330000E-03
2.5605000E+03	6.8283000E-03	7.5427000E-01	5.1504000E-03	9.3693000E-03
2.5606000E+03	6.7828000E-03	7.5425000E-01	5.1159000E-03	9.3065000E-03
2.5607000E+03	6.7380000E-03	7.5423000E-01	5.0820000E-03	9.2447000E-03
2.5608000E+03	6.6939000E-03	7.5420000E-01	5.0486000E-03	9.1839000E-03
2.5609000E+03	6.6505000E-03	7.5418000E-01	5.0157000E-03	9.1241000E-03
2.5610000E+03	6.6077000E-03	7.5415000E-01	4.9832000E-03	9.0651000E-03
2.5611000E+03	6.5656000E-03	7.5412000E-01	4.9513000E-03	9.0070000E-03
2.5612000E+03	6.5241000E-03	7.5409000E-01	4.9198000E-03	8.9497000E-03
2.5613000E+03	6.4832000E-03	7.5406000E-01	4.8887000E-03	8.8932000E-03
2.5614000E+03	6.4428000E-03	7.5404000E-01	4.8581000E-03	8.8375000E-03
2.5615000E+03	6.4030000E-03	7.5401000E-01	4.8279000E-03	8.7825000E-03
2.5616000E+03	6.3637000E-03	7.5398000E-01	4.7981000E-03	8.7282000E-03
2.5617000E+03	6.3248000E-03	7.5395000E-01	4.7686000E-03	8.6746000E-03
2.5618000E+03	6.2865000E-03	7.5392000E-01	4.7395000E-03	8.6217000E-03
2.5619000E+03	6.2485000E-03	7.5389000E-01	4.7107000E-03	8.5694000E-03
2.5620000E+03	6.2111000E-03	7.5386000E-01	4.6823000E-03	8.5176000E-03
2.5621000E+03	6.1740000E-03	7.5384000E-01	4.6542000E-03	8.4665000E-03
2.5622000E+03	6.1373000E-03	7.5381000E-01	4.6264000E-03	8.4160000E-03
2.5623000E+03	6.1010000E-03	7.5379000E-01	4.5989000E-03	8.3659000E-03
2.5624000E+03	6.0650000E-03	7.5377000E-01	4.5716000E-03	8.3163000E-03
2.5625000E+03	6.0294000E-03	7.5374000E-01	4.5446000E-03	8.2672000E-03
2.5626000E+03	5.9940000E-03	7.5372000E-01	4.5178000E-03	8.2184000E-03
2.5627000E+03	5.9589000E-03	7.5370000E-01	4.4912000E-03	8.1701000E-03
2.5628000E+03	5.9241000E-03	7.5367000E-01	4.4649000E-03	8.1222000E-03
2.5629000E+03	5.8896000E-03	7.5365000E-01	4.4387000E-03	8.0746000E-03
2.5630000E+03	5.8553000E-03	7.5363000E-01	4.4127000E-03	8.0273000E-03
2.5631000E+03	5.8213000E-03	7.5360000E-01	4.3869000E-03	7.9803000E-03
2.5632000E+03	5.7874000E-03	7.5357000E-01	4.3612000E-03	7.9336000E-03
2.5633000E+03	5.7537000E-03	7.5355000E-01	4.3357000E-03	7.8872000E-03
2.5634000E+03	5.7203000E-03	7.5352000E-01	4.3103000E-03	7.8410000E-03
2.5635000E+03	5.6869000E-03	7.5349000E-01	4.2851000E-03	7.7951000E-03
2.5636000E+03	5.6538000E-03	7.5346000E-01	4.2600000E-03	7.7494000E-03
2.5637000E+03	5.6208000E-03	7.5344000E-01	4.2349000E-03	7.7038000E-03
2.5638000E+03	5.5879000E-03	7.5341000E-01	4.2100000E-03	7.6585000E-03
2.5639000E+03	5.5552000E-03	7.5338000E-01	4.1852000E-03	7.6133000E-03
2.5640000E+03	5.5226000E-03	7.5336000E-01	4.1604000E-03	7.5684000E-03
2.5641000E+03	5.4900000E-03	7.5333000E-01	4.1358000E-03	7.5236000E-03
2.5642000E+03	5.4576000E-03	7.5331000E-01	4.1113000E-03	7.4790000E-03
2.5643000E+03	5.4253000E-03	7.5329000E-01	4.0869000E-03	7.4345000E-03

2.5644000E+03	5.3931000E-03	7.5327000E-01	4.0625000E-03	7.3902000E-03
2.5645000E+03	5.3610000E-03	7.5325000E-01	4.0382000E-03	7.3459000E-03
2.5646000E+03	5.3289000E-03	7.5323000E-01	4.0139000E-03	7.3018000E-03
2.5647000E+03	5.2970000E-03	7.5321000E-01	3.9897000E-03	7.2578000E-03
2.5648000E+03	5.2651000E-03	7.5319000E-01	3.9656000E-03	7.2139000E-03
2.5649000E+03	5.2333000E-03	7.5317000E-01	3.9416000E-03	7.1702000E-03
2.5650000E+03	5.2020000E-03	7.5315000E-01	3.9179000E-03	7.1271000E-03
2.5651000E+03	5.1704000E-03	7.5313000E-01	3.8940000E-03	7.0836000E-03
2.5652000E+03	5.1388000E-03	7.5311000E-01	3.8701000E-03	7.0402000E-03
2.5653000E+03	5.1074000E-03	7.5309000E-01	3.8463000E-03	6.9969000E-03
2.5654000E+03	5.0760000E-03	7.5308000E-01	3.8226000E-03	6.9538000E-03
2.5655000E+03	5.0447000E-03	7.5306000E-01	3.7990000E-03	6.9108000E-03
2.5656000E+03	5.0135000E-03	7.5304000E-01	3.7754000E-03	6.8679000E-03
2.5657000E+03	4.9825000E-03	7.5303000E-01	3.7519000E-03	6.8252000E-03
2.5658000E+03	4.9515000E-03	7.5301000E-01	3.7285000E-03	6.7826000E-03
2.5659000E+03	4.9206000E-03	7.5299000E-01	3.7052000E-03	6.7402000E-03
2.5660000E+03	4.8899000E-03	7.5297000E-01	3.6820000E-03	6.6980000E-03
2.5661000E+03	4.8593000E-03	7.5296000E-01	3.6589000E-03	6.6559000E-03
2.5662000E+03	4.8288000E-03	7.5295000E-01	3.6359000E-03	6.6141000E-03
2.5663000E+03	4.7985000E-03	7.5294000E-01	3.6130000E-03	6.5724000E-03
2.5664000E+03	4.7683000E-03	7.5293000E-01	3.5902000E-03	6.5310000E-03
2.5665000E+03	4.7383000E-03	7.5291000E-01	3.5675000E-03	6.4898000E-03
2.5666000E+03	4.7084000E-03	7.5290000E-01	3.5450000E-03	6.4488000E-03
2.5667000E+03	4.6787000E-03	7.5289000E-01	3.5226000E-03	6.4080000E-03
2.5668000E+03	4.6492000E-03	7.5288000E-01	3.5003000E-03	6.3675000E-03
2.5669000E+03	4.6199000E-03	7.5287000E-01	3.4782000E-03	6.3273000E-03
2.5670000E+03	4.5909000E-03	7.5286000E-01	3.4563000E-03	6.2874000E-03
2.5671000E+03	4.5620000E-03	7.5285000E-01	3.4345000E-03	6.2478000E-03
2.5672000E+03	4.5333000E-03	7.5284000E-01	3.4129000E-03	6.2085000E-03
2.5673000E+03	4.5049000E-03	7.5284000E-01	3.3915000E-03	6.1695000E-03
2.5674000E+03	4.4768000E-03	7.5283000E-01	3.3702000E-03	6.1309000E-03
2.5675000E+03	4.4489000E-03	7.5282000E-01	3.3492000E-03	6.0926000E-03
2.5676000E+03	4.4212000E-03	7.5282000E-01	3.3284000E-03	6.0547000E-03
2.5677000E+03	4.3939000E-03	7.5281000E-01	3.3078000E-03	6.0172000E-03
2.5678000E+03	4.3668000E-03	7.5280000E-01	3.2874000E-03	5.9801000E-03
2.5679000E+03	4.3400000E-03	7.5280000E-01	3.2672000E-03	5.9434000E-03
2.5680000E+03	4.3136000E-03	7.5279000E-01	3.2472000E-03	5.9071000E-03
2.5681000E+03	4.2875000E-03	7.5273000E-01	3.2273000E-03	5.8709000E-03
2.5682000E+03	4.2616000E-03	7.5268000E-01	3.2076000E-03	5.8351000E-03
2.5683000E+03	4.2362000E-03	7.5262000E-01	3.1882000E-03	5.7997000E-03
2.5684000E+03	4.2110000E-03	7.5256000E-01	3.1691000E-03	5.7649000E-03
2.5685000E+03	4.1862000E-03	7.5250000E-01	3.1502000E-03	5.7305000E-03
2.5686000E+03	4.1618000E-03	7.5245000E-01	3.1315000E-03	5.6967000E-03

2.5687000E+03	4.1378000E-03	7.5239000E-01	3.1132000E-03	5.6633000E-03
2.5688000E+03	4.1141000E-03	7.5233000E-01	3.0952000E-03	5.6305000E-03
2.5689000E+03	4.0908000E-03	7.5227000E-01	3.0774000E-03	5.5981000E-03
2.5690000E+03	4.0679000E-03	7.5222000E-01	3.0599000E-03	5.5664000E-03
2.5691000E+03	4.0454000E-03	7.5215000E-01	3.0427000E-03	5.5351000E-03
2.5692000E+03	4.0232000E-03	7.5209000E-01	3.0258000E-03	5.5044000E-03
2.5693000E+03	4.0015000E-03	7.5203000E-01	3.0093000E-03	5.4742000E-03
2.5694000E+03	3.9802000E-03	7.5197000E-01	2.9930000E-03	5.4446000E-03
2.5695000E+03	3.9593000E-03	7.5191000E-01	2.9770000E-03	5.4156000E-03
2.5696000E+03	3.9388000E-03	7.5185000E-01	2.9614000E-03	5.3871000E-03
2.5697000E+03	3.9187000E-03	7.5178000E-01	2.9460000E-03	5.3592000E-03
2.5698000E+03	3.8991000E-03	7.5172000E-01	2.9310000E-03	5.3319000E-03
2.5699000E+03	0.0000000E+00	7.5172000E-01	0.0000000E+00	0.0000000E+00
Channel 19				
Wavenumber	HIRS Filter Transmittance	Optical Element Transmittance	Product of the HIRS Filter and Optical Element Transmittances	Normalized Value of Column 4
2.5518000E+03	0.0000000E+00	7.5725000E-01	0.0000000E+00	0.0000000E+00
2.5520000E+03	1.9255000E-03	7.5722000E-01	1.4580000E-03	2.5133000E-03
2.5522000E+03	1.9503000E-03	7.5720000E-01	1.4767000E-03	2.5455000E-03
2.5524000E+03	1.9747000E-03	7.5719000E-01	1.4952000E-03	2.5773000E-03
2.5526000E+03	1.9986000E-03	7.5718000E-01	1.5133000E-03	2.6085000E-03
2.5528000E+03	2.0221000E-03	7.5716000E-01	1.5310000E-03	2.6391000E-03
2.5530000E+03	2.0417000E-03	7.5715000E-01	1.5459000E-03	2.6646000E-03
2.5532000E+03	2.0636000E-03	7.5714000E-01	1.5624000E-03	2.6932000E-03
2.5534000E+03	2.0849000E-03	7.5713000E-01	1.5785000E-03	2.7209000E-03
2.5536000E+03	2.1054000E-03	7.5711000E-01	1.5940000E-03	2.7476000E-03
2.5538000E+03	2.1252000E-03	7.5710000E-01	1.6090000E-03	2.7734000E-03
2.5540000E+03	2.1441000E-03	7.5709000E-01	1.6233000E-03	2.7981000E-03
2.5542000E+03	2.1624000E-03	7.5702000E-01	1.6370000E-03	2.8216000E-03
2.5544000E+03	2.1798000E-03	7.5695000E-01	1.6500000E-03	2.8441000E-03
2.5546000E+03	2.1965000E-03	7.5688000E-01	1.6624000E-03	2.8656000E-03
2.5548000E+03	2.2124000E-03	7.5681000E-01	1.6743000E-03	2.8861000E-03
2.5550000E+03	2.2275000E-03	7.5674000E-01	1.6857000E-03	2.9056000E-03
2.5552000E+03	2.2421000E-03	7.5667000E-01	1.6965000E-03	2.9243000E-03
2.5554000E+03	2.2561000E-03	7.5660000E-01	1.7069000E-03	2.9423000E-03
2.5556000E+03	2.2695000E-03	7.5653000E-01	1.7169000E-03	2.9595000E-03
2.5558000E+03	2.2825000E-03	7.5646000E-01	1.7266000E-03	2.9762000E-03
2.5560000E+03	2.2952000E-03	7.5639000E-01	1.7361000E-03	2.9925000E-03
2.5562000E+03	2.3078000E-03	7.5626000E-01	1.7453000E-03	3.0084000E-03
2.5564000E+03	2.3203000E-03	7.5613000E-01	1.7544000E-03	3.0242000E-03
2.5566000E+03	2.3329000E-03	7.5600000E-01	1.7637000E-03	3.0401000E-03

2.5568000E+03	2.3458000E-03	7.5587000E-01	1.7731000E-03	3.0563000E-03
2.5570000E+03	2.3591000E-03	7.5574000E-01	1.7829000E-03	3.0732000E-03
2.5572000E+03	2.3730000E-03	7.5564000E-01	1.7932000E-03	3.0909000E-03
2.5574000E+03	2.3878000E-03	7.5553000E-01	1.8041000E-03	3.1097000E-03
2.5576000E+03	2.4036000E-03	7.5542000E-01	1.8158000E-03	3.1298000E-03
2.5578000E+03	2.4207000E-03	7.5531000E-01	1.8284000E-03	3.1516000E-03
2.5580000E+03	2.4391000E-03	7.5521000E-01	1.8421000E-03	3.1752000E-03
2.5582000E+03	2.4593000E-03	7.5512000E-01	1.8571000E-03	3.2010000E-03
2.5584000E+03	2.4813000E-03	7.5504000E-01	1.8735000E-03	3.2293000E-03
2.5586000E+03	2.5054000E-03	7.5495000E-01	1.8915000E-03	3.2603000E-03
2.5588000E+03	2.5318000E-03	7.5487000E-01	1.9112000E-03	3.2943000E-03
2.5590000E+03	2.5607000E-03	7.5478000E-01	1.9327000E-03	3.3315000E-03
2.5592000E+03	2.5922000E-03	7.5470000E-01	1.9564000E-03	3.3722000E-03
2.5594000E+03	2.6266000E-03	7.5463000E-01	1.9821000E-03	3.4166000E-03
2.5596000E+03	2.6640000E-03	7.5455000E-01	2.0101000E-03	3.4649000E-03
2.5598000E+03	2.7045000E-03	7.5447000E-01	2.0405000E-03	3.5173000E-03
2.5600000E+03	2.7483000E-03	7.5440000E-01	2.0733000E-03	3.5739000E-03
2.5602000E+03	2.7955000E-03	7.5435000E-01	2.1088000E-03	3.6350000E-03
2.5604000E+03	2.8462000E-03	7.5430000E-01	2.1469000E-03	3.7006000E-03
2.5606000E+03	2.9003000E-03	7.5425000E-01	2.1876000E-03	3.7708000E-03
2.5608000E+03	2.9580000E-03	7.5420000E-01	2.2310000E-03	3.8455000E-03
2.5610000E+03	3.0194000E-03	7.5415000E-01	2.2770000E-03	3.9250000E-03
2.5612000E+03	3.0842000E-03	7.5409000E-01	2.3258000E-03	4.0090000E-03
2.5614000E+03	3.1526000E-03	7.5404000E-01	2.3772000E-03	4.0976000E-03
2.5616000E+03	3.2246000E-03	7.5398000E-01	2.4313000E-03	4.1908000E-03
2.5618000E+03	3.3000000E-03	7.5392000E-01	2.4879000E-03	4.2885000E-03
2.5620000E+03	3.3788000E-03	7.5386000E-01	2.5471000E-03	4.3905000E-03
2.5622000E+03	3.4608000E-03	7.5381000E-01	2.6088000E-03	4.4969000E-03
2.5624000E+03	3.5461000E-03	7.5377000E-01	2.6730000E-03	4.6074000E-03
2.5626000E+03	3.6345000E-03	7.5372000E-01	2.7394000E-03	4.7219000E-03
2.5628000E+03	3.7258000E-03	7.5367000E-01	2.8080000E-03	4.8403000E-03
2.5630000E+03	3.8200000E-03	7.5363000E-01	2.8788000E-03	4.9623000E-03
2.5632000E+03	3.9168000E-03	7.5357000E-01	2.9516000E-03	5.0877000E-03
2.5634000E+03	4.0162000E-03	7.5352000E-01	3.0263000E-03	5.2165000E-03
2.5636000E+03	4.1180000E-03	7.5346000E-01	3.1028000E-03	5.3483000E-03
2.5638000E+03	4.2221000E-03	7.5341000E-01	3.1810000E-03	5.4831000E-03
2.5640000E+03	4.3283000E-03	7.5336000E-01	3.2607000E-03	5.6206000E-03
2.5642000E+03	4.4364000E-03	7.5331000E-01	3.3420000E-03	5.7607000E-03
2.5644000E+03	4.5463000E-03	7.5327000E-01	3.4246000E-03	5.9031000E-03
2.5646000E+03	4.6579000E-03	7.5323000E-01	3.5085000E-03	6.0477000E-03
2.5648000E+03	4.7711000E-03	7.5319000E-01	3.5935000E-03	6.1942000E-03
2.5650000E+03	4.8855000E-03	7.5315000E-01	3.6795000E-03	6.3424000E-03
2.5652000E+03	5.0012000E-03	7.5311000E-01	3.7665000E-03	6.4923000E-03

2.5654000E+03	5.1180000E-03	7.5308000E-01	3.8542000E-03	6.6436000E-03
2.5656000E+03	5.2357000E-03	7.5304000E-01	3.9427000E-03	6.7960000E-03
2.5658000E+03	5.3541000E-03	7.5301000E-01	4.0317000E-03	6.9495000E-03
2.5660000E+03	5.4733000E-03	7.5297000E-01	4.1213000E-03	7.1039000E-03
2.5662000E+03	5.5930000E-03	7.5295000E-01	4.2113000E-03	7.2591000E-03
2.5664000E+03	5.7132000E-03	7.5293000E-01	4.3016000E-03	7.4148000E-03
2.5666000E+03	5.8337000E-03	7.5290000E-01	4.3922000E-03	7.5709000E-03
2.5668000E+03	5.9544000E-03	7.5288000E-01	4.4829000E-03	7.7273000E-03
2.5670000E+03	6.0752000E-03	7.5286000E-01	4.5737000E-03	7.8838000E-03
2.5672000E+03	6.1960000E-03	7.5284000E-01	4.6646000E-03	8.0404000E-03
2.5674000E+03	6.3167000E-03	7.5283000E-01	4.7554000E-03	8.1970000E-03
2.5676000E+03	6.4373000E-03	7.5282000E-01	4.8461000E-03	8.3533000E-03
2.5678000E+03	6.5576000E-03	7.5280000E-01	4.9366000E-03	8.5093000E-03
2.5680000E+03	6.6776000E-03	7.5279000E-01	5.0269000E-03	8.6649000E-03
2.5682000E+03	6.7973000E-03	7.5268000E-01	5.1162000E-03	8.8188000E-03
2.5684000E+03	6.9166000E-03	7.5256000E-01	5.2051000E-03	8.9722000E-03
2.5686000E+03	7.0353000E-03	7.5245000E-01	5.2937000E-03	9.1248000E-03
2.5688000E+03	7.1536000E-03	7.5233000E-01	5.3819000E-03	9.2768000E-03
2.5690000E+03	7.2713000E-03	7.5222000E-01	5.4696000E-03	9.4280000E-03
2.5692000E+03	7.3884000E-03	7.5209000E-01	5.5567000E-03	9.5783000E-03
2.5694000E+03	7.5049000E-03	7.5197000E-01	5.6435000E-03	9.7277000E-03
2.5696000E+03	7.6208000E-03	7.5185000E-01	5.7297000E-03	9.8763000E-03
2.5698000E+03	7.7361000E-03	7.5172000E-01	5.8154000E-03	1.0024000E-02
2.5700000E+03	7.8508000E-03	7.5160000E-01	5.9006000E-03	1.0171000E-02
2.5702000E+03	7.9649000E-03	7.5151000E-01	5.9857000E-03	1.0318000E-02
2.5704000E+03	8.0784000E-03	7.5143000E-01	6.0703000E-03	1.0463000E-02
2.5706000E+03	8.1913000E-03	7.5134000E-01	6.1545000E-03	1.0609000E-02
2.5708000E+03	8.3038000E-03	7.5125000E-01	6.2382000E-03	1.0753000E-02
2.5710000E+03	8.4157000E-03	7.5116000E-01	6.3216000E-03	1.0897000E-02
2.5712000E+03	8.5272000E-03	7.5107000E-01	6.4046000E-03	1.1040000E-02
2.5714000E+03	8.6384000E-03	7.5098000E-01	6.4873000E-03	1.1182000E-02
2.5716000E+03	8.7492000E-03	7.5089000E-01	6.5697000E-03	1.1324000E-02
2.5718000E+03	8.8598000E-03	7.5080000E-01	6.6519000E-03	1.1466000E-02
2.5720000E+03	8.9703000E-03	7.5070000E-01	6.7340000E-03	1.1608000E-02
2.5722000E+03	9.0807000E-03	7.5063000E-01	6.8162000E-03	1.1749000E-02
2.5724000E+03	9.1911000E-03	7.5055000E-01	6.8984000E-03	1.1891000E-02
2.5726000E+03	9.3016000E-03	7.5048000E-01	6.9807000E-03	1.2033000E-02
2.5728000E+03	9.4124000E-03	7.5040000E-01	7.0631000E-03	1.2175000E-02
2.5730000E+03	9.5236000E-03	7.5033000E-01	7.1458000E-03	1.2317000E-02
2.5732000E+03	9.6352000E-03	7.5025000E-01	7.2289000E-03	1.2461000E-02
2.5734000E+03	9.7475000E-03	7.5018000E-01	7.3124000E-03	1.2604000E-02
2.5736000E+03	9.8605000E-03	7.5010000E-01	7.3964000E-03	1.2749000E-02
2.5738000E+03	9.9744000E-03	7.5003000E-01	7.4811000E-03	1.2895000E-02

2.5740000E+03	1.0089000E-02	7.4996000E-01	7.5666000E-03	1.3043000E-02
2.5742000E+03	1.0206000E-02	7.4995000E-01	7.6536000E-03	1.3193000E-02
2.5744000E+03	1.0323000E-02	7.4993000E-01	7.7417000E-03	1.3345000E-02
2.5746000E+03	1.0442000E-02	7.4992000E-01	7.8310000E-03	1.3498000E-02
2.5748000E+03	1.0563000E-02	7.4991000E-01	7.9216000E-03	1.3655000E-02
2.5750000E+03	1.0686000E-02	7.4990000E-01	8.0136000E-03	1.3813000E-02
2.5752000E+03	1.0811000E-02	7.4989000E-01	8.1072000E-03	1.3975000E-02
2.5754000E+03	1.0939000E-02	7.4986000E-01	8.2023000E-03	1.4138000E-02
2.5756000E+03	1.1068000E-02	7.4982000E-01	8.2993000E-03	1.4306000E-02
2.5758000E+03	1.1201000E-02	7.4978000E-01	8.3982000E-03	1.4476000E-02
2.5760000E+03	1.1337000E-02	7.4973000E-01	8.4994000E-03	1.4651000E-02
2.5762000E+03	1.1475000E-02	7.4969000E-01	8.6030000E-03	1.4829000E-02
2.5764000E+03	1.1618000E-02	7.4964000E-01	8.7091000E-03	1.5012000E-02
2.5766000E+03	1.1764000E-02	7.4959000E-01	8.8180000E-03	1.5200000E-02
2.5768000E+03	1.1914000E-02	7.4955000E-01	8.9298000E-03	1.5392000E-02
2.5770000E+03	1.2068000E-02	7.4950000E-01	9.0447000E-03	1.5590000E-02
2.5772000E+03	1.2226000E-02	7.4944000E-01	9.1628000E-03	1.5794000E-02
2.5774000E+03	1.2389000E-02	7.4939000E-01	9.2844000E-03	1.6004000E-02
2.5776000E+03	1.2557000E-02	7.4933000E-01	9.4096000E-03	1.6219000E-02
2.5778000E+03	1.2731000E-02	7.4928000E-01	9.5387000E-03	1.6442000E-02
2.5780000E+03	1.2909000E-02	7.4922000E-01	9.6720000E-03	1.6672000E-02
2.5782000E+03	1.3094000E-02	7.4908000E-01	9.8083000E-03	1.6907000E-02
2.5784000E+03	1.3284000E-02	7.4893000E-01	9.9491000E-03	1.7149000E-02
2.5786000E+03	1.3481000E-02	7.4879000E-01	1.0095000E-02	1.7400000E-02
2.5788000E+03	1.3684000E-02	7.4865000E-01	1.0245000E-02	1.7659000E-02
2.5790000E+03	1.3894000E-02	7.4851000E-01	1.0400000E-02	1.7927000E-02
2.5792000E+03	1.4112000E-02	7.4837000E-01	1.0561000E-02	1.8204000E-02
2.5794000E+03	1.4336000E-02	7.4823000E-01	1.0727000E-02	1.8490000E-02
2.5796000E+03	1.4568000E-02	7.4809000E-01	1.0898000E-02	1.8785000E-02
2.5798000E+03	1.4808000E-02	7.4796000E-01	1.1076000E-02	1.9091000E-02
2.5800000E+03	1.5056000E-02	7.4782000E-01	1.1259000E-02	1.9407000E-02
2.5802000E+03	1.5312000E-02	7.4773000E-01	1.1449000E-02	1.9736000E-02
2.5804000E+03	1.5577000E-02	7.4764000E-01	1.1646000E-02	2.0075000E-02
2.5806000E+03	1.5851000E-02	7.4755000E-01	1.1849000E-02	2.0425000E-02
2.5808000E+03	1.6134000E-02	7.4746000E-01	1.2059000E-02	2.0787000E-02
2.5810000E+03	1.6426000E-02	7.4737000E-01	1.2276000E-02	2.1160000E-02
2.5812000E+03	1.6727000E-02	7.4728000E-01	1.2500000E-02	2.1546000E-02
2.5814000E+03	1.7038000E-02	7.4719000E-01	1.2731000E-02	2.1944000E-02
2.5816000E+03	1.7360000E-02	7.4710000E-01	1.2969000E-02	2.2355000E-02
2.5818000E+03	1.7691000E-02	7.4701000E-01	1.3215000E-02	2.2779000E-02
2.5820000E+03	1.8032000E-02	7.4692000E-01	1.3468000E-02	2.3216000E-02
2.5822000E+03	1.8384000E-02	7.4684000E-01	1.3730000E-02	2.3666000E-02
2.5824000E+03	1.8746000E-02	7.4677000E-01	1.3999000E-02	2.4130000E-02

2.5826000E+03	1.9119000E-02	7.4669000E-01	1.4276000E-02	2.4608000E-02
2.5828000E+03	1.9503000E-02	7.4662000E-01	1.4561000E-02	2.5099000E-02
2.5830000E+03	1.9897000E-02	7.4654000E-01	1.4854000E-02	2.5604000E-02
2.5832000E+03	2.0303000E-02	7.4646000E-01	1.5155000E-02	2.6124000E-02
2.5834000E+03	2.0720000E-02	7.4638000E-01	1.5465000E-02	2.6657000E-02
2.5836000E+03	2.1148000E-02	7.4630000E-01	1.5783000E-02	2.7205000E-02
2.5838000E+03	2.1587000E-02	7.4622000E-01	1.6109000E-02	2.7767000E-02
2.5840000E+03	2.2038000E-02	7.4614000E-01	1.6443000E-02	2.8344000E-02
2.5842000E+03	2.2500000E-02	7.4604000E-01	1.6786000E-02	2.8934000E-02
2.5844000E+03	2.2974000E-02	7.4595000E-01	1.7137000E-02	2.9539000E-02
2.5846000E+03	2.3458000E-02	7.4585000E-01	1.7496000E-02	3.0159000E-02
2.5848000E+03	2.3955000E-02	7.4575000E-01	1.7864000E-02	3.0793000E-02
2.5850000E+03	2.4463000E-02	7.4565000E-01	1.8241000E-02	3.1442000E-02
2.5852000E+03	2.4982000E-02	7.4555000E-01	1.8626000E-02	3.2105000E-02
2.5854000E+03	2.5513000E-02	7.4546000E-01	1.9019000E-02	3.2784000E-02
2.5856000E+03	2.6056000E-02	7.4536000E-01	1.9421000E-02	3.3477000E-02
2.5858000E+03	2.6610000E-02	7.4526000E-01	1.9832000E-02	3.4184000E-02
2.5860000E+03	2.7176000E-02	7.4517000E-01	2.0250000E-02	3.4906000E-02
2.5862000E+03	2.7753000E-02	7.4508000E-01	2.0678000E-02	3.5643000E-02
2.5864000E+03	2.8341000E-02	7.4499000E-01	2.1114000E-02	3.6395000E-02
2.5866000E+03	2.8941000E-02	7.4490000E-01	2.1558000E-02	3.7161000E-02
2.5868000E+03	2.9553000E-02	7.4481000E-01	2.2011000E-02	3.7941000E-02
2.5870000E+03	3.0176000E-02	7.4472000E-01	2.2472000E-02	3.8736000E-02
2.5872000E+03	3.0810000E-02	7.4462000E-01	2.2942000E-02	3.9545000E-02
2.5874000E+03	3.1456000E-02	7.4452000E-01	2.3420000E-02	4.0369000E-02
2.5876000E+03	3.2113000E-02	7.4442000E-01	2.3906000E-02	4.1207000E-02
2.5878000E+03	3.2782000E-02	7.4432000E-01	2.4400000E-02	4.2059000E-02
2.5880000E+03	3.3461000E-02	7.4422000E-01	2.4903000E-02	4.2925000E-02
2.5882000E+03	3.4153000E-02	7.4412000E-01	2.5414000E-02	4.3806000E-02
2.5884000E+03	3.4855000E-02	7.4401000E-01	2.5933000E-02	4.4701000E-02
2.5886000E+03	3.5570000E-02	7.4391000E-01	2.6460000E-02	4.5610000E-02
2.5888000E+03	3.6295000E-02	7.4380000E-01	2.6996000E-02	4.6534000E-02
2.5890000E+03	3.7032000E-02	7.4370000E-01	2.7541000E-02	4.7472000E-02
2.5892000E+03	3.7781000E-02	7.4358000E-01	2.8093000E-02	4.8425000E-02
2.5894000E+03	3.8541000E-02	7.4347000E-01	2.8654000E-02	4.9392000E-02
2.5896000E+03	3.9313000E-02	7.4336000E-01	2.9224000E-02	5.0374000E-02
2.5898000E+03	4.0097000E-02	7.4324000E-01	2.9802000E-02	5.1370000E-02
2.5900000E+03	4.0893000E-02	7.4313000E-01	3.0389000E-02	5.2382000E-02
2.5902000E+03	4.1701000E-02	7.4301000E-01	3.0984000E-02	5.3408000E-02
2.5904000E+03	4.2521000E-02	7.4288000E-01	3.1588000E-02	5.4449000E-02
2.5906000E+03	4.3354000E-02	7.4276000E-01	3.2201000E-02	5.5506000E-02
2.5908000E+03	4.4199000E-02	7.4263000E-01	3.2824000E-02	5.6579000E-02
2.5910000E+03	4.5057000E-02	7.4251000E-01	3.3455000E-02	5.7668000E-02

2.5912000E+03	4.5928000E-02	7.4238000E-01	3.4096000E-02	5.8772000E-02
2.5914000E+03	4.6813000E-02	7.4224000E-01	3.4747000E-02	5.9893000E-02
2.5916000E+03	4.7711000E-02	7.4211000E-01	3.5407000E-02	6.1031000E-02
2.5918000E+03	4.8623000E-02	7.4198000E-01	3.6077000E-02	6.2187000E-02
2.5920000E+03	4.9550000E-02	7.4184000E-01	3.6758000E-02	6.3360000E-02
2.5922000E+03	5.0416000E-02	7.4175000E-01	3.7396000E-02	6.4460000E-02
2.5924000E+03	5.1370000E-02	7.4166000E-01	3.8099000E-02	6.5671000E-02
2.5926000E+03	5.2339000E-02	7.4156000E-01	3.8813000E-02	6.6902000E-02
2.5928000E+03	5.3324000E-02	7.4147000E-01	3.9538000E-02	6.8153000E-02
2.5930000E+03	5.4325000E-02	7.4138000E-01	4.0275000E-02	6.9423000E-02
2.5932000E+03	5.5343000E-02	7.4128000E-01	4.1025000E-02	7.0716000E-02
2.5934000E+03	5.6378000E-02	7.4119000E-01	4.1787000E-02	7.2029000E-02
2.5936000E+03	5.7431000E-02	7.4110000E-01	4.2562000E-02	7.3366000E-02
2.5938000E+03	5.8503000E-02	7.4101000E-01	4.3351000E-02	7.4725000E-02
2.5940000E+03	5.9593000E-02	7.4092000E-01	4.4154000E-02	7.6108000E-02
2.5942000E+03	6.0704000E-02	7.4079000E-01	4.4968000E-02	7.7513000E-02
2.5944000E+03	6.1834000E-02	7.4066000E-01	4.5798000E-02	7.8942000E-02
2.5946000E+03	6.2986000E-02	7.4053000E-01	4.6643000E-02	8.0399000E-02
2.5948000E+03	6.4159000E-02	7.4040000E-01	4.7503000E-02	8.1882000E-02
2.5950000E+03	6.5355000E-02	7.4027000E-01	4.8380000E-02	8.3394000E-02
2.5952000E+03	6.6575000E-02	7.4015000E-01	4.9275000E-02	8.4936000E-02
2.5954000E+03	6.7819000E-02	7.4002000E-01	5.0187000E-02	8.6509000E-02
2.5956000E+03	6.9087000E-02	7.3990000E-01	5.1118000E-02	8.8113000E-02
2.5958000E+03	7.0382000E-02	7.3978000E-01	5.2067000E-02	8.9749000E-02
2.5960000E+03	7.1704000E-02	7.3965000E-01	5.3036000E-02	9.1420000E-02
2.5962000E+03	7.3054000E-02	7.3953000E-01	5.4026000E-02	9.3125000E-02
2.5964000E+03	7.4433000E-02	7.3940000E-01	5.5036000E-02	9.4866000E-02
2.5966000E+03	7.5842000E-02	7.3928000E-01	5.6068000E-02	9.6645000E-02
2.5968000E+03	7.7281000E-02	7.3915000E-01	5.7122000E-02	9.8463000E-02
2.5970000E+03	7.8753000E-02	7.3903000E-01	5.8200000E-02	1.0032000E-01
2.5972000E+03	8.0257000E-02	7.3890000E-01	5.9302000E-02	1.0222000E-01
2.5974000E+03	8.1796000E-02	7.3877000E-01	6.0428000E-02	1.0416000E-01
2.5976000E+03	8.3370000E-02	7.3864000E-01	6.1580000E-02	1.0615000E-01
2.5978000E+03	8.4981000E-02	7.3851000E-01	6.2759000E-02	1.0818000E-01
2.5980000E+03	8.6629000E-02	7.3838000E-01	6.3965000E-02	1.1026000E-01
2.5982000E+03	8.8316000E-02	7.3830000E-01	6.5204000E-02	1.1239000E-01
2.5984000E+03	9.0044000E-02	7.3823000E-01	6.6473000E-02	1.1458000E-01
2.5986000E+03	9.1812000E-02	7.3816000E-01	6.7772000E-02	1.1682000E-01
2.5988000E+03	9.3623000E-02	7.3808000E-01	6.9101000E-02	1.1911000E-01
2.5990000E+03	9.5477000E-02	7.3792000E-01	7.0454000E-02	1.2144000E-01
2.5992000E+03	9.7377000E-02	7.3765000E-01	7.1830000E-02	1.2381000E-01
2.5994000E+03	9.9322000E-02	7.3756000E-01	7.3257000E-02	1.2627000E-01
2.5996000E+03	1.0132000E-01	7.3748000E-01	7.4719000E-02	1.2879000E-01

2.5998000E+03	1.0336000E-01	7.3740000E-01	7.6216000E-02	1.3138000E-01
2.6000000E+03	1.0545000E-01	7.3732000E-01	7.7750000E-02	1.3402000E-01
2.6002000E+03	1.0759000E-01	7.3727000E-01	7.9325000E-02	1.3673000E-01
2.6004000E+03	1.0979000E-01	7.3721000E-01	8.0938000E-02	1.3951000E-01
2.6006000E+03	1.1204000E-01	7.3716000E-01	8.2590000E-02	1.4236000E-01
2.6008000E+03	1.1434000E-01	7.3711000E-01	8.4283000E-02	1.4528000E-01
2.6010000E+03	1.1670000E-01	7.3706000E-01	8.6017000E-02	1.4827000E-01
2.6012000E+03	1.1912000E-01	7.3700000E-01	8.7794000E-02	1.5133000E-01
2.6014000E+03	1.2160000E-01	7.3695000E-01	8.9614000E-02	1.5447000E-01
2.6016000E+03	1.2414000E-01	7.3690000E-01	9.1477000E-02	1.5768000E-01
2.6018000E+03	1.2674000E-01	7.3685000E-01	9.3385000E-02	1.6097000E-01
2.6020000E+03	1.2940000E-01	7.3680000E-01	9.5339000E-02	1.6434000E-01
2.6022000E+03	1.3212000E-01	7.3668000E-01	9.7331000E-02	1.6777000E-01
2.6024000E+03	1.3491000E-01	7.3657000E-01	9.9369000E-02	1.7128000E-01
2.6026000E+03	1.3776000E-01	7.3646000E-01	1.0146000E-01	1.7488000E-01
2.6028000E+03	1.4068000E-01	7.3634000E-01	1.0359000E-01	1.7856000E-01
2.6030000E+03	1.4367000E-01	7.3623000E-01	1.0578000E-01	1.8233000E-01
2.6032000E+03	1.4673000E-01	7.3612000E-01	1.0801000E-01	1.8618000E-01
2.6034000E+03	1.4986000E-01	7.3601000E-01	1.1030000E-01	1.9012000E-01
2.6036000E+03	1.5305000E-01	7.3590000E-01	1.1263000E-01	1.9414000E-01
2.6038000E+03	1.5632000E-01	7.3579000E-01	1.1502000E-01	1.9826000E-01
2.6040000E+03	1.5966000E-01	7.3568000E-01	1.1746000E-01	2.0247000E-01
2.6042000E+03	1.6307000E-01	7.3560000E-01	1.1996000E-01	2.0677000E-01
2.6044000E+03	1.6656000E-01	7.3551000E-01	1.2251000E-01	2.1117000E-01
2.6046000E+03	1.7012000E-01	7.3543000E-01	1.2511000E-01	2.1566000E-01
2.6048000E+03	1.7376000E-01	7.3534000E-01	1.2777000E-01	2.2024000E-01
2.6050000E+03	1.7747000E-01	7.3526000E-01	1.3048000E-01	2.2492000E-01
2.6052000E+03	1.8125000E-01	7.3517000E-01	1.3325000E-01	2.2969000E-01
2.6054000E+03	1.8511000E-01	7.3508000E-01	1.3608000E-01	2.3455000E-01
2.6056000E+03	1.8905000E-01	7.3500000E-01	1.3895000E-01	2.3952000E-01
2.6058000E+03	1.9307000E-01	7.3491000E-01	1.4189000E-01	2.4458000E-01
2.6060000E+03	1.9716000E-01	7.3482000E-01	1.4488000E-01	2.4973000E-01
2.6062000E+03	2.0133000E-01	7.3475000E-01	1.4793000E-01	2.5498000E-01
2.6064000E+03	2.0558000E-01	7.3467000E-01	1.5103000E-01	2.6033000E-01
2.6066000E+03	2.0990000E-01	7.3459000E-01	1.5419000E-01	2.6578000E-01
2.6068000E+03	2.1430000E-01	7.3451000E-01	1.5741000E-01	2.7133000E-01
2.6070000E+03	2.1878000E-01	7.3443000E-01	1.6068000E-01	2.7697000E-01
2.6072000E+03	2.2333000E-01	7.3434000E-01	1.6400000E-01	2.8269000E-01
2.6074000E+03	2.2797000E-01	7.3424000E-01	1.6738000E-01	2.8852000E-01
2.6076000E+03	2.3267000E-01	7.3415000E-01	1.7082000E-01	2.9444000E-01
2.6078000E+03	2.3745000E-01	7.3406000E-01	1.7431000E-01	3.0045000E-01
2.6080000E+03	2.4231000E-01	7.3397000E-01	1.7785000E-01	3.0656000E-01
2.6082000E+03	2.4724000E-01	7.3386000E-01	1.8144000E-01	3.1275000E-01

2.6084000E+03	2.5225000E-01	7.3375000E-01	1.8509000E-01	3.1904000E-01
2.6086000E+03	2.5733000E-01	7.3364000E-01	1.8878000E-01	3.2541000E-01
2.6088000E+03	2.6248000E-01	7.3353000E-01	1.9253000E-01	3.3187000E-01
2.6090000E+03	2.6770000E-01	7.3342000E-01	1.9633000E-01	3.3842000E-01
2.6092000E+03	2.7299000E-01	7.3330000E-01	2.0018000E-01	3.4506000E-01
2.6094000E+03	2.7835000E-01	7.3317000E-01	2.0408000E-01	3.5177000E-01
2.6096000E+03	2.8377000E-01	7.3305000E-01	2.0802000E-01	3.5857000E-01
2.6098000E+03	2.8927000E-01	7.3293000E-01	2.1201000E-01	3.6545000E-01
2.6100000E+03	2.9482000E-01	7.3281000E-01	2.1605000E-01	3.7241000E-01
2.6102000E+03	3.0045000E-01	7.3268000E-01	2.2013000E-01	3.7945000E-01
2.6104000E+03	3.0613000E-01	7.3256000E-01	2.2426000E-01	3.8656000E-01
2.6106000E+03	3.1187000E-01	7.3244000E-01	2.2843000E-01	3.9375000E-01
2.6108000E+03	3.1768000E-01	7.3232000E-01	2.3264000E-01	4.0100000E-01
2.6110000E+03	3.2353000E-01	7.3219000E-01	2.3689000E-01	4.0833000E-01
2.6112000E+03	3.2945000E-01	7.3206000E-01	2.4118000E-01	4.1572000E-01
2.6114000E+03	3.3542000E-01	7.3193000E-01	2.4550000E-01	4.2318000E-01
2.6116000E+03	3.4143000E-01	7.3180000E-01	2.4986000E-01	4.3069000E-01
2.6118000E+03	3.4750000E-01	7.3167000E-01	2.5426000E-01	4.3826000E-01
2.6120000E+03	3.5362000E-01	7.3153000E-01	2.5868000E-01	4.4590000E-01
2.6122000E+03	3.5978000E-01	7.3142000E-01	2.6315000E-01	4.5359000E-01
2.6124000E+03	3.6598000E-01	7.3130000E-01	2.6764000E-01	4.6134000E-01
2.6126000E+03	3.7222000E-01	7.3119000E-01	2.7216000E-01	4.6913000E-01
2.6128000E+03	3.7850000E-01	7.3107000E-01	2.7671000E-01	4.7697000E-01
2.6130000E+03	3.8481000E-01	7.3096000E-01	2.8128000E-01	4.8485000E-01
2.6132000E+03	3.9116000E-01	7.3085000E-01	2.8588000E-01	4.9278000E-01
2.6134000E+03	3.9754000E-01	7.3074000E-01	2.9050000E-01	5.0074000E-01
2.6136000E+03	4.0394000E-01	7.3063000E-01	2.9514000E-01	5.0873000E-01
2.6138000E+03	4.1037000E-01	7.3053000E-01	2.9979000E-01	5.1675000E-01
2.6140000E+03	4.1683000E-01	7.3042000E-01	3.0446000E-01	5.2480000E-01
2.6142000E+03	4.2330000E-01	7.3034000E-01	3.0915000E-01	5.3289000E-01
2.6144000E+03	4.2979000E-01	7.3026000E-01	3.1386000E-01	5.4100000E-01
2.6146000E+03	4.3629000E-01	7.3017000E-01	3.1857000E-01	5.4912000E-01
2.6148000E+03	4.4281000E-01	7.3009000E-01	3.2329000E-01	5.5726000E-01
2.6150000E+03	4.4933000E-01	7.3001000E-01	3.2802000E-01	5.6541000E-01
2.6152000E+03	4.5586000E-01	7.2994000E-01	3.3275000E-01	5.7357000E-01
2.6154000E+03	4.6239000E-01	7.2987000E-01	3.3748000E-01	5.8173000E-01
2.6156000E+03	4.6892000E-01	7.2980000E-01	3.4222000E-01	5.8989000E-01
2.6158000E+03	4.7545000E-01	7.2973000E-01	3.4695000E-01	5.9804000E-01
2.6160000E+03	4.8197000E-01	7.2966000E-01	3.5167000E-01	6.0618000E-01
2.6162000E+03	4.8848000E-01	7.2951000E-01	3.5635000E-01	6.1425000E-01
2.6164000E+03	4.9497000E-01	7.2937000E-01	3.6102000E-01	6.2229000E-01
2.6166000E+03	5.0146000E-01	7.2922000E-01	3.6567000E-01	6.3032000E-01
2.6168000E+03	5.0792000E-01	7.2908000E-01	3.7031000E-01	6.3832000E-01

2.6170000E+03	5.1437000E-01	7.2893000E-01	3.7494000E-01	6.4629000E-01
2.6172000E+03	5.2078000E-01	7.2877000E-01	3.7953000E-01	6.5421000E-01
2.6174000E+03	5.2718000E-01	7.2862000E-01	3.8411000E-01	6.6210000E-01
2.6176000E+03	5.3354000E-01	7.2846000E-01	3.8866000E-01	6.6994000E-01
2.6178000E+03	5.3987000E-01	7.2830000E-01	3.9319000E-01	6.7774000E-01
2.6180000E+03	5.4616000E-01	7.2815000E-01	3.9768000E-01	6.8549000E-01
2.6182000E+03	5.5241000E-01	7.2797000E-01	4.0214000E-01	6.9318000E-01
2.6184000E+03	5.5863000E-01	7.2780000E-01	4.0657000E-01	7.0081000E-01
2.6186000E+03	5.6479000E-01	7.2762000E-01	4.1096000E-01	7.0837000E-01
2.6188000E+03	5.7091000E-01	7.2745000E-01	4.1531000E-01	7.1588000E-01
2.6190000E+03	5.7699000E-01	7.2727000E-01	4.1963000E-01	7.2332000E-01
2.6192000E+03	5.8300000E-01	7.2710000E-01	4.2390000E-01	7.3068000E-01
2.6194000E+03	5.8896000E-01	7.2692000E-01	4.2813000E-01	7.3797000E-01
2.6196000E+03	5.9487000E-01	7.2674000E-01	4.3231000E-01	7.4518000E-01
2.6198000E+03	6.0071000E-01	7.2656000E-01	4.3645000E-01	7.5232000E-01
2.6200000E+03	6.0649000E-01	7.2637000E-01	4.4054000E-01	7.5937000E-01
2.6202000E+03	6.1221000E-01	7.2629000E-01	4.4464000E-01	7.6643000E-01
2.6204000E+03	6.1786000E-01	7.2620000E-01	4.4869000E-01	7.7341000E-01
2.6206000E+03	6.2344000E-01	7.2611000E-01	4.5268000E-01	7.8029000E-01
2.6208000E+03	6.2894000E-01	7.2602000E-01	4.5662000E-01	7.8709000E-01
2.6210000E+03	6.3437000E-01	7.2593000E-01	4.6051000E-01	7.9379000E-01
2.6212000E+03	6.3973000E-01	7.2584000E-01	4.6434000E-01	8.0039000E-01
2.6214000E+03	6.4500000E-01	7.2576000E-01	4.6812000E-01	8.0690000E-01
2.6216000E+03	6.5020000E-01	7.2568000E-01	4.7184000E-01	8.1331000E-01
2.6218000E+03	6.5531000E-01	7.2560000E-01	4.7549000E-01	8.1961000E-01
2.6220000E+03	6.6034000E-01	7.2551000E-01	4.7909000E-01	8.2581000E-01
2.6222000E+03	6.6529000E-01	7.2541000E-01	4.8261000E-01	8.3187000E-01
2.6224000E+03	6.7014000E-01	7.2531000E-01	4.8606000E-01	8.3783000E-01
2.6226000E+03	6.7491000E-01	7.2520000E-01	4.8945000E-01	8.4367000E-01
2.6228000E+03	6.7959000E-01	7.2510000E-01	4.9277000E-01	8.4940000E-01
2.6230000E+03	6.8417000E-01	7.2500000E-01	4.9603000E-01	8.5501000E-01
2.6232000E+03	6.8867000E-01	7.2490000E-01	4.9922000E-01	8.6051000E-01
2.6234000E+03	6.9307000E-01	7.2481000E-01	5.0234000E-01	8.6589000E-01
2.6236000E+03	6.9737000E-01	7.2471000E-01	5.0539000E-01	8.7116000E-01
2.6238000E+03	7.0158000E-01	7.2462000E-01	5.0838000E-01	8.7630000E-01
2.6240000E+03	7.0569000E-01	7.2452000E-01	5.1129000E-01	8.8132000E-01
2.6242000E+03	7.0971000E-01	7.2439000E-01	5.1411000E-01	8.8618000E-01
2.6244000E+03	7.1362000E-01	7.2427000E-01	5.1685000E-01	8.9091000E-01
2.6246000E+03	7.1744000E-01	7.2414000E-01	5.1952000E-01	8.9551000E-01
2.6248000E+03	7.2116000E-01	7.2401000E-01	5.2213000E-01	9.0000000E-01
2.6250000E+03	7.2478000E-01	7.2388000E-01	5.2465000E-01	9.0435000E-01
2.6252000E+03	7.2829000E-01	7.2375000E-01	5.2710000E-01	9.0857000E-01
2.6254000E+03	7.3171000E-01	7.2361000E-01	5.2948000E-01	9.1267000E-01

2.6256000E+03	7.3503000E-01	7.2348000E-01	5.3178000E-01	9.1664000E-01
2.6258000E+03	7.3825000E-01	7.2335000E-01	5.3401000E-01	9.2048000E-01
2.6260000E+03	7.4136000E-01	7.2321000E-01	5.3616000E-01	9.2420000E-01
2.6262000E+03	7.4438000E-01	7.2312000E-01	5.3828000E-01	9.2784000E-01
2.6264000E+03	7.4730000E-01	7.2303000E-01	5.4032000E-01	9.3136000E-01
2.6266000E+03	7.5012000E-01	7.2294000E-01	5.4229000E-01	9.3475000E-01
2.6268000E+03	7.5284000E-01	7.2284000E-01	5.4418000E-01	9.3802000E-01
2.6270000E+03	7.5546000E-01	7.2275000E-01	5.4601000E-01	9.4116000E-01
2.6272000E+03	7.5798000E-01	7.2265000E-01	5.4775000E-01	9.4417000E-01
2.6274000E+03	7.6041000E-01	7.2254000E-01	5.4943000E-01	9.4706000E-01
2.6276000E+03	7.6274000E-01	7.2244000E-01	5.5103000E-01	9.4983000E-01
2.6278000E+03	7.6498000E-01	7.2234000E-01	5.5257000E-01	9.5247000E-01
2.6280000E+03	7.6712000E-01	7.2223000E-01	5.5404000E-01	9.5500000E-01
2.6282000E+03	7.6917000E-01	7.2213000E-01	5.5544000E-01	9.5742000E-01
2.6284000E+03	7.7112000E-01	7.2202000E-01	5.5677000E-01	9.5971000E-01
2.6286000E+03	7.7299000E-01	7.2192000E-01	5.5804000E-01	9.6190000E-01
2.6288000E+03	7.7477000E-01	7.2182000E-01	5.5924000E-01	9.6397000E-01
2.6290000E+03	7.7645000E-01	7.2171000E-01	5.6037000E-01	9.6593000E-01
2.6292000E+03	7.7805000E-01	7.2161000E-01	5.6145000E-01	9.6778000E-01
2.6294000E+03	7.7957000E-01	7.2151000E-01	5.6246000E-01	9.6953000E-01
2.6296000E+03	7.8100000E-01	7.2140000E-01	5.6342000E-01	9.7117000E-01
2.6298000E+03	7.8235000E-01	7.2130000E-01	5.6431000E-01	9.7271000E-01
2.6300000E+03	7.8362000E-01	7.2120000E-01	5.6515000E-01	9.7415000E-01
2.6302000E+03	7.8481000E-01	7.2111000E-01	5.6594000E-01	9.7552000E-01
2.6304000E+03	7.8593000E-01	7.2102000E-01	5.6667000E-01	9.7678000E-01
2.6306000E+03	7.8697000E-01	7.2094000E-01	5.6735000E-01	9.7795000E-01
2.6308000E+03	7.8793000E-01	7.2085000E-01	5.6798000E-01	9.7903000E-01
2.6310000E+03	7.8882000E-01	7.2076000E-01	5.6855000E-01	9.8002000E-01
2.6312000E+03	7.8965000E-01	7.2067000E-01	5.6908000E-01	9.8093000E-01
2.6314000E+03	7.9041000E-01	7.2058000E-01	5.6955000E-01	9.8175000E-01
2.6316000E+03	7.9110000E-01	7.2049000E-01	5.6998000E-01	9.8249000E-01
2.6318000E+03	7.9173000E-01	7.2041000E-01	5.7036000E-01	9.8315000E-01
2.6320000E+03	7.9229000E-01	7.2032000E-01	5.7070000E-01	9.8373000E-01
2.6322000E+03	7.9280000E-01	7.2025000E-01	5.7101000E-01	9.8426000E-01
2.6324000E+03	7.9325000E-01	7.2018000E-01	5.7128000E-01	9.8472000E-01
2.6326000E+03	7.9365000E-01	7.2011000E-01	5.7151000E-01	9.8512000E-01
2.6328000E+03	7.9399000E-01	7.2004000E-01	5.7170000E-01	9.8545000E-01
2.6330000E+03	7.9428000E-01	7.1997000E-01	5.7185000E-01	9.8571000E-01
2.6332000E+03	7.9452000E-01	7.1989000E-01	5.7197000E-01	9.8592000E-01
2.6334000E+03	7.9472000E-01	7.1982000E-01	5.7206000E-01	9.8606000E-01
2.6336000E+03	7.9487000E-01	7.1975000E-01	5.7211000E-01	9.8615000E-01
2.6338000E+03	7.9498000E-01	7.1967000E-01	5.7213000E-01	9.8619000E-01
2.6340000E+03	7.9505000E-01	7.1960000E-01	5.7212000E-01	9.8618000E-01

2.6342000E+03	7.9509000E-01	7.1945000E-01	5.7202000E-01	9.8601000E-01
2.6344000E+03	7.9508000E-01	7.1930000E-01	5.7190000E-01	9.8580000E-01
2.6346000E+03	7.9505000E-01	7.1915000E-01	5.7176000E-01	9.8555000E-01
2.6348000E+03	7.9498000E-01	7.1900000E-01	5.7159000E-01	9.8525000E-01
2.6350000E+03	7.9488000E-01	7.1885000E-01	5.7140000E-01	9.8493000E-01
2.6352000E+03	7.9476000E-01	7.1869000E-01	5.7119000E-01	9.8457000E-01
2.6354000E+03	7.9461000E-01	7.1854000E-01	5.7096000E-01	9.8417000E-01
2.6356000E+03	7.9444000E-01	7.1839000E-01	5.7071000E-01	9.8375000E-01
2.6358000E+03	7.9424000E-01	7.1824000E-01	5.7045000E-01	9.8330000E-01
2.6360000E+03	7.9403000E-01	7.1808000E-01	5.7018000E-01	9.8283000E-01
2.6362000E+03	7.9380000E-01	7.1795000E-01	5.6991000E-01	9.8236000E-01
2.6364000E+03	7.9356000E-01	7.1781000E-01	5.6962000E-01	9.8187000E-01
2.6366000E+03	7.9330000E-01	7.1768000E-01	5.6933000E-01	9.8137000E-01
2.6368000E+03	7.9303000E-01	7.1754000E-01	5.6903000E-01	9.8085000E-01
2.6370000E+03	7.9275000E-01	7.1743000E-01	5.6874000E-01	9.8034000E-01
2.6372000E+03	7.9246000E-01	7.1730000E-01	5.6843000E-01	9.7982000E-01
2.6374000E+03	7.9217000E-01	7.1718000E-01	5.6812000E-01	9.7928000E-01
2.6376000E+03	7.9187000E-01	7.1705000E-01	5.6781000E-01	9.7874000E-01
2.6378000E+03	7.9157000E-01	7.1693000E-01	5.6749000E-01	9.7820000E-01
2.6380000E+03	7.9126000E-01	7.1680000E-01	5.6718000E-01	9.7766000E-01
2.6382000E+03	7.9096000E-01	7.1669000E-01	5.6687000E-01	9.7713000E-01
2.6384000E+03	7.9066000E-01	7.1658000E-01	5.6657000E-01	9.7661000E-01
2.6386000E+03	7.9036000E-01	7.1647000E-01	5.6627000E-01	9.7608000E-01
2.6388000E+03	7.9007000E-01	7.1636000E-01	5.6597000E-01	9.7557000E-01
2.6390000E+03	7.8978000E-01	7.1624000E-01	5.6567000E-01	9.7506000E-01
2.6392000E+03	7.8950000E-01	7.1614000E-01	5.6539000E-01	9.7457000E-01
2.6394000E+03	7.8922000E-01	7.1603000E-01	5.6511000E-01	9.7408000E-01
2.6396000E+03	7.8896000E-01	7.1592000E-01	5.6483000E-01	9.7361000E-01
2.6398000E+03	7.8870000E-01	7.1581000E-01	5.6457000E-01	9.7315000E-01
2.6400000E+03	7.8846000E-01	7.1571000E-01	5.6431000E-01	9.7271000E-01
2.6402000E+03	7.8823000E-01	7.1560000E-01	5.6406000E-01	9.7228000E-01
2.6404000E+03	7.8802000E-01	7.1549000E-01	5.6382000E-01	9.7186000E-01
2.6406000E+03	7.8781000E-01	7.1538000E-01	5.6359000E-01	9.7146000E-01
2.6408000E+03	7.8762000E-01	7.1528000E-01	5.6337000E-01	9.7109000E-01
2.6410000E+03	7.8745000E-01	7.1517000E-01	5.6316000E-01	9.7073000E-01
2.6412000E+03	7.8729000E-01	7.1506000E-01	5.6297000E-01	9.7039000E-01
2.6414000E+03	7.8715000E-01	7.1496000E-01	5.6278000E-01	9.7008000E-01
2.6416000E+03	7.8703000E-01	7.1486000E-01	5.6261000E-01	9.6978000E-01
2.6418000E+03	7.8693000E-01	7.1475000E-01	5.6246000E-01	9.6951000E-01
2.6420000E+03	7.8684000E-01	7.1465000E-01	5.6231000E-01	9.6926000E-01
2.6422000E+03	7.8677000E-01	7.1455000E-01	5.6219000E-01	9.6905000E-01
2.6424000E+03	7.8672000E-01	7.1445000E-01	5.6208000E-01	9.6886000E-01
2.6426000E+03	7.8669000E-01	7.1436000E-01	5.6198000E-01	9.6869000E-01

2.6428000E+03	7.8668000E-01	7.1426000E-01	5.6189000E-01	9.6855000E-01
2.6430000E+03	7.8669000E-01	7.1416000E-01	5.6183000E-01	9.6843000E-01
2.6432000E+03	7.8672000E-01	7.1407000E-01	5.6177000E-01	9.6834000E-01
2.6434000E+03	7.8677000E-01	7.1397000E-01	5.6173000E-01	9.6827000E-01
2.6436000E+03	7.8684000E-01	7.1388000E-01	5.6171000E-01	9.6823000E-01
2.6438000E+03	7.8693000E-01	7.1378000E-01	5.6170000E-01	9.6821000E-01
2.6440000E+03	7.8704000E-01	7.1369000E-01	5.6170000E-01	9.6821000E-01
2.6442000E+03	7.8717000E-01	7.1361000E-01	5.6173000E-01	9.6827000E-01
2.6444000E+03	7.8732000E-01	7.1353000E-01	5.6178000E-01	9.6835000E-01
2.6446000E+03	7.8749000E-01	7.1347000E-01	5.6185000E-01	9.6847000E-01
2.6448000E+03	7.8768000E-01	7.1341000E-01	5.6194000E-01	9.6862000E-01
2.6450000E+03	7.8788000E-01	7.1335000E-01	5.6204000E-01	9.6879000E-01
2.6452000E+03	7.8811000E-01	7.1328000E-01	5.6214000E-01	9.6898000E-01
2.6454000E+03	7.8835000E-01	7.1322000E-01	5.6227000E-01	9.6919000E-01
2.6456000E+03	7.8861000E-01	7.1315000E-01	5.6240000E-01	9.6942000E-01
2.6458000E+03	7.8889000E-01	7.1308000E-01	5.6255000E-01	9.6967000E-01
2.6460000E+03	7.8919000E-01	7.1302000E-01	5.6271000E-01	9.6994000E-01
2.6462000E+03	7.8950000E-01	7.1300000E-01	5.6291000E-01	9.7030000E-01
2.6464000E+03	7.8983000E-01	7.1298000E-01	5.6313000E-01	9.7068000E-01
2.6466000E+03	7.9018000E-01	7.1296000E-01	5.6337000E-01	9.7108000E-01
2.6468000E+03	7.9053000E-01	7.1294000E-01	5.6361000E-01	9.7150000E-01
2.6470000E+03	7.9091000E-01	7.1293000E-01	5.6386000E-01	9.7193000E-01
2.6472000E+03	7.9130000E-01	7.1289000E-01	5.6411000E-01	9.7237000E-01
2.6474000E+03	7.9170000E-01	7.1286000E-01	5.6437000E-01	9.7282000E-01
2.6476000E+03	7.9211000E-01	7.1283000E-01	5.6464000E-01	9.7328000E-01
2.6478000E+03	7.9254000E-01	7.1280000E-01	5.6492000E-01	9.7376000E-01
2.6480000E+03	7.9298000E-01	7.1277000E-01	5.6521000E-01	9.7426000E-01
2.6482000E+03	7.9343000E-01	7.1267000E-01	5.6545000E-01	9.7468000E-01
2.6484000E+03	7.9388000E-01	7.1258000E-01	5.6571000E-01	9.7512000E-01
2.6486000E+03	7.9435000E-01	7.1249000E-01	5.6597000E-01	9.7557000E-01
2.6488000E+03	7.9483000E-01	7.1239000E-01	5.6623000E-01	9.7602000E-01
2.6490000E+03	7.9531000E-01	7.1230000E-01	5.6650000E-01	9.7649000E-01
2.6492000E+03	7.9581000E-01	7.1221000E-01	5.6678000E-01	9.7697000E-01
2.6494000E+03	7.9631000E-01	7.1212000E-01	5.6707000E-01	9.7746000E-01
2.6496000E+03	7.9681000E-01	7.1203000E-01	5.6736000E-01	9.7796000E-01
2.6498000E+03	7.9732000E-01	7.1194000E-01	5.6765000E-01	9.7846000E-01
2.6500000E+03	7.9783000E-01	7.1185000E-01	5.6794000E-01	9.7897000E-01
2.6502000E+03	7.9835000E-01	7.1174000E-01	5.6822000E-01	9.7945000E-01
2.6504000E+03	7.9887000E-01	7.1162000E-01	5.6850000E-01	9.7993000E-01
2.6506000E+03	7.9940000E-01	7.1151000E-01	5.6878000E-01	9.8041000E-01
2.6508000E+03	7.9993000E-01	7.1139000E-01	5.6906000E-01	9.8090000E-01
2.6510000E+03	8.0045000E-01	7.1127000E-01	5.6934000E-01	9.8138000E-01
2.6512000E+03	8.0098000E-01	7.1116000E-01	5.6963000E-01	9.8187000E-01

2.6514000E+03	8.0151000E-01	7.1105000E-01	5.6991000E-01	9.8236000E-01
2.6516000E+03	8.0204000E-01	7.1093000E-01	5.7019000E-01	9.8285000E-01
2.6518000E+03	8.0256000E-01	7.1082000E-01	5.7048000E-01	9.8334000E-01
2.6520000E+03	8.0309000E-01	7.1071000E-01	5.7076000E-01	9.8383000E-01
2.6522000E+03	8.0361000E-01	7.1062000E-01	5.7106000E-01	9.8435000E-01
2.6524000E+03	8.0413000E-01	7.1054000E-01	5.7136000E-01	9.8486000E-01
2.6526000E+03	8.0464000E-01	7.1045000E-01	5.7166000E-01	9.8537000E-01
2.6528000E+03	8.0515000E-01	7.1036000E-01	5.7195000E-01	9.8588000E-01
2.6530000E+03	8.0566000E-01	7.1028000E-01	5.7224000E-01	9.8638000E-01
2.6532000E+03	8.0616000E-01	7.1019000E-01	5.7252000E-01	9.8687000E-01
2.6534000E+03	8.0665000E-01	7.1010000E-01	5.7280000E-01	9.8735000E-01
2.6536000E+03	8.0714000E-01	7.1001000E-01	5.7308000E-01	9.8783000E-01
2.6538000E+03	8.0762000E-01	7.0992000E-01	5.7335000E-01	9.8830000E-01
2.6540000E+03	8.0810000E-01	7.0984000E-01	5.7362000E-01	9.8876000E-01
2.6542000E+03	8.0857000E-01	7.0978000E-01	5.7391000E-01	9.8925000E-01
2.6544000E+03	8.0903000E-01	7.0973000E-01	5.7419000E-01	9.8974000E-01
2.6546000E+03	8.0948000E-01	7.0967000E-01	5.7447000E-01	9.9022000E-01
2.6548000E+03	8.0993000E-01	7.0962000E-01	5.7474000E-01	9.9069000E-01
2.6550000E+03	8.1036000E-01	7.0958000E-01	5.7502000E-01	9.9116000E-01
2.6552000E+03	8.1079000E-01	7.0956000E-01	5.7530000E-01	9.9166000E-01
2.6554000E+03	8.1120000E-01	7.0955000E-01	5.7558000E-01	9.9214000E-01
2.6556000E+03	8.1161000E-01	7.0953000E-01	5.7586000E-01	9.9262000E-01
2.6558000E+03	8.1201000E-01	7.0951000E-01	5.7613000E-01	9.9308000E-01
2.6560000E+03	8.1239000E-01	7.0949000E-01	5.7639000E-01	9.9353000E-01
2.6562000E+03	8.1277000E-01	7.0947000E-01	5.7663000E-01	9.9395000E-01
2.6564000E+03	8.1313000E-01	7.0944000E-01	5.7687000E-01	9.9436000E-01
2.6566000E+03	8.1349000E-01	7.0941000E-01	5.7710000E-01	9.9475000E-01
2.6568000E+03	8.1383000E-01	7.0938000E-01	5.7732000E-01	9.9514000E-01
2.6570000E+03	8.1417000E-01	7.0935000E-01	5.7753000E-01	9.9550000E-01
2.6572000E+03	8.1449000E-01	7.0933000E-01	5.7774000E-01	9.9587000E-01
2.6574000E+03	8.1480000E-01	7.0931000E-01	5.7795000E-01	9.9621000E-01
2.6576000E+03	8.1510000E-01	7.0929000E-01	5.7814000E-01	9.9655000E-01
2.6578000E+03	8.1539000E-01	7.0927000E-01	5.7833000E-01	9.9687000E-01
2.6580000E+03	8.1566000E-01	7.0924000E-01	5.7850000E-01	9.9718000E-01
2.6582000E+03	8.1593000E-01	7.0920000E-01	5.7866000E-01	9.9744000E-01
2.6584000E+03	8.1618000E-01	7.0916000E-01	5.7881000E-01	9.9770000E-01
2.6586000E+03	8.1642000E-01	7.0912000E-01	5.7894000E-01	9.9793000E-01
2.6588000E+03	8.1665000E-01	7.0908000E-01	5.7907000E-01	9.9816000E-01
2.6590000E+03	8.1687000E-01	7.0904000E-01	5.7919000E-01	9.9837000E-01
2.6592000E+03	8.1708000E-01	7.0900000E-01	5.7931000E-01	9.9856000E-01
2.6594000E+03	8.1727000E-01	7.0896000E-01	5.7941000E-01	9.9874000E-01
2.6596000E+03	8.1746000E-01	7.0891000E-01	5.7951000E-01	9.9891000E-01
2.6598000E+03	8.1763000E-01	7.0887000E-01	5.7960000E-01	9.9906000E-01

2.6600000E+03	8.1779000E-01	7.0883000E-01	5.7968000E-01	9.9920000E-01
2.6602000E+03	8.1794000E-01	7.0881000E-01	5.7976000E-01	9.9935000E-01
2.6604000E+03	8.1808000E-01	7.0878000E-01	5.7984000E-01	9.9948000E-01
2.6606000E+03	8.1821000E-01	7.0876000E-01	5.7991000E-01	9.9960000E-01
2.6608000E+03	8.1832000E-01	7.0873000E-01	5.7997000E-01	9.9971000E-01
2.6610000E+03	8.1843000E-01	7.0871000E-01	5.8003000E-01	9.9980000E-01
2.6612000E+03	8.1852000E-01	7.0868000E-01	5.8007000E-01	9.9987000E-01
2.6614000E+03	8.1860000E-01	7.0864000E-01	5.8010000E-01	9.9992000E-01
2.6616000E+03	8.1867000E-01	7.0861000E-01	5.8012000E-01	9.9996000E-01
2.6618000E+03	8.1873000E-01	7.0857000E-01	5.8013000E-01	9.9999000E-01
2.6620000E+03	8.1878000E-01	7.0854000E-01	5.8014000E-01	1.0000000E+00
2.6622000E+03	8.1882000E-01	7.0850000E-01	5.8014000E-01	9.9999000E-01
2.6624000E+03	8.1885000E-01	7.0846000E-01	5.8012000E-01	9.9997000E-01
2.6626000E+03	8.1887000E-01	7.0842000E-01	5.8010000E-01	9.9993000E-01
2.6628000E+03	8.1887000E-01	7.0838000E-01	5.8007000E-01	9.9988000E-01
2.6630000E+03	8.1887000E-01	7.0834000E-01	5.8004000E-01	9.9982000E-01
2.6632000E+03	8.1885000E-01	7.0830000E-01	5.7999000E-01	9.9974000E-01
2.6634000E+03	8.1883000E-01	7.0825000E-01	5.7994000E-01	9.9965000E-01
2.6636000E+03	8.1879000E-01	7.0821000E-01	5.7988000E-01	9.9954000E-01
2.6638000E+03	8.1875000E-01	7.0817000E-01	5.7981000E-01	9.9943000E-01
2.6640000E+03	8.1869000E-01	7.0812000E-01	5.7973000E-01	9.9930000E-01
2.6642000E+03	8.1862000E-01	7.0804000E-01	5.7962000E-01	9.9910000E-01
2.6644000E+03	8.1854000E-01	7.0796000E-01	5.7950000E-01	9.9889000E-01
2.6646000E+03	8.1846000E-01	7.0789000E-01	5.7937000E-01	9.9868000E-01
2.6648000E+03	8.1836000E-01	7.0781000E-01	5.7924000E-01	9.9844000E-01
2.6650000E+03	8.1825000E-01	7.0773000E-01	5.7910000E-01	9.9820000E-01
2.6652000E+03	8.1813000E-01	7.0765000E-01	5.7895000E-01	9.9795000E-01
2.6654000E+03	8.1800000E-01	7.0758000E-01	5.7880000E-01	9.9768000E-01
2.6656000E+03	8.1786000E-01	7.0750000E-01	5.7864000E-01	9.9741000E-01
2.6658000E+03	8.1771000E-01	7.0743000E-01	5.7847000E-01	9.9712000E-01
2.6660000E+03	8.1754000E-01	7.0735000E-01	5.7829000E-01	9.9681000E-01
2.6662000E+03	8.1737000E-01	7.0729000E-01	5.7812000E-01	9.9651000E-01
2.6664000E+03	8.1719000E-01	7.0722000E-01	5.7794000E-01	9.9620000E-01
2.6666000E+03	8.1699000E-01	7.0716000E-01	5.7774000E-01	9.9587000E-01
2.6668000E+03	8.1679000E-01	7.0709000E-01	5.7755000E-01	9.9553000E-01
2.6670000E+03	8.1657000E-01	7.0703000E-01	5.7734000E-01	9.9517000E-01
2.6672000E+03	8.1634000E-01	7.0698000E-01	5.7714000E-01	9.9482000E-01
2.6674000E+03	8.1610000E-01	7.0693000E-01	5.7693000E-01	9.9446000E-01
2.6676000E+03	8.1585000E-01	7.0688000E-01	5.7671000E-01	9.9409000E-01
2.6678000E+03	8.1559000E-01	7.0683000E-01	5.7649000E-01	9.9370000E-01
2.6680000E+03	8.1532000E-01	7.0678000E-01	5.7625000E-01	9.9330000E-01
2.6682000E+03	8.1503000E-01	7.0680000E-01	5.7606000E-01	9.9297000E-01
2.6684000E+03	8.1473000E-01	7.0681000E-01	5.7586000E-01	9.9262000E-01

2.6686000E+03	8.1442000E-01	7.0682000E-01	5.7565000E-01	9.9226000E-01
2.6688000E+03	8.1410000E-01	7.0683000E-01	5.7543000E-01	9.9188000E-01
2.6690000E+03	8.1376000E-01	7.0685000E-01	5.7521000E-01	9.9149000E-01
2.6692000E+03	8.1342000E-01	7.0685000E-01	5.7497000E-01	9.9108000E-01
2.6694000E+03	8.1306000E-01	7.0686000E-01	5.7472000E-01	9.9065000E-01
2.6696000E+03	8.1268000E-01	7.0687000E-01	5.7446000E-01	9.9021000E-01
2.6698000E+03	8.1230000E-01	7.0688000E-01	5.7420000E-01	9.8975000E-01
2.6700000E+03	8.1190000E-01	7.0689000E-01	5.7392000E-01	9.8928000E-01
2.6702000E+03	8.1149000E-01	7.0687000E-01	5.7361000E-01	9.8875000E-01
2.6704000E+03	8.1106000E-01	7.0685000E-01	5.7330000E-01	9.8820000E-01
2.6706000E+03	8.1062000E-01	7.0683000E-01	5.7297000E-01	9.8764000E-01
2.6708000E+03	8.1017000E-01	7.0681000E-01	5.7263000E-01	9.8706000E-01
2.6710000E+03	8.0970000E-01	7.0679000E-01	5.7229000E-01	9.8646000E-01
2.6712000E+03	8.0922000E-01	7.0676000E-01	5.7193000E-01	9.8584000E-01
2.6714000E+03	8.0872000E-01	7.0674000E-01	5.7156000E-01	9.8520000E-01
2.6716000E+03	8.0822000E-01	7.0672000E-01	5.7118000E-01	9.8455000E-01
2.6718000E+03	8.0769000E-01	7.0669000E-01	5.7079000E-01	9.8388000E-01
2.6720000E+03	8.0716000E-01	7.0667000E-01	5.7039000E-01	9.8320000E-01
2.6722000E+03	8.0660000E-01	7.0664000E-01	5.6998000E-01	9.8249000E-01
2.6724000E+03	8.0604000E-01	7.0662000E-01	5.6956000E-01	9.8176000E-01
2.6726000E+03	8.0546000E-01	7.0659000E-01	5.6913000E-01	9.8102000E-01
2.6728000E+03	8.0486000E-01	7.0657000E-01	5.6869000E-01	9.8026000E-01
2.6730000E+03	8.0425000E-01	7.0654000E-01	5.6824000E-01	9.7948000E-01
2.6732000E+03	8.0362000E-01	7.0652000E-01	5.6778000E-01	9.7869000E-01
2.6734000E+03	8.0299000E-01	7.0650000E-01	5.6731000E-01	9.7789000E-01
2.6736000E+03	8.0233000E-01	7.0648000E-01	5.6684000E-01	9.7706000E-01
2.6738000E+03	8.0167000E-01	7.0647000E-01	5.6635000E-01	9.7623000E-01
2.6740000E+03	8.0098000E-01	7.0645000E-01	5.6585000E-01	9.7537000E-01
2.6742000E+03	8.0029000E-01	7.0639000E-01	5.6531000E-01	9.7444000E-01
2.6744000E+03	7.9958000E-01	7.0633000E-01	5.6476000E-01	9.7349000E-01
2.6746000E+03	7.9885000E-01	7.0627000E-01	5.6420000E-01	9.7253000E-01
2.6748000E+03	7.9811000E-01	7.0621000E-01	5.6363000E-01	9.7155000E-01
2.6750000E+03	7.9736000E-01	7.0615000E-01	5.6306000E-01	9.7055000E-01
2.6752000E+03	7.9660000E-01	7.0609000E-01	5.6247000E-01	9.6954000E-01
2.6754000E+03	7.9582000E-01	7.0603000E-01	5.6187000E-01	9.6851000E-01
2.6756000E+03	7.9503000E-01	7.0597000E-01	5.6126000E-01	9.6746000E-01
2.6758000E+03	7.9422000E-01	7.0591000E-01	5.6065000E-01	9.6640000E-01
2.6760000E+03	7.9341000E-01	7.0585000E-01	5.6002000E-01	9.6532000E-01
2.6762000E+03	7.9258000E-01	7.0583000E-01	5.5943000E-01	9.6429000E-01
2.6764000E+03	7.9174000E-01	7.0581000E-01	5.5882000E-01	9.6324000E-01
2.6766000E+03	7.9089000E-01	7.0579000E-01	5.5820000E-01	9.6218000E-01
2.6768000E+03	7.9003000E-01	7.0577000E-01	5.5758000E-01	9.6111000E-01
2.6770000E+03	7.8916000E-01	7.0575000E-01	5.5695000E-01	9.6002000E-01

2.6772000E+03	7.8827000E-01	7.0574000E-01	5.5632000E-01	9.5893000E-01
2.6774000E+03	7.8738000E-01	7.0573000E-01	5.5568000E-01	9.5783000E-01
2.6776000E+03	7.8648000E-01	7.0572000E-01	5.5503000E-01	9.5672000E-01
2.6778000E+03	7.8557000E-01	7.0570000E-01	5.5438000E-01	9.5560000E-01
2.6780000E+03	7.8466000E-01	7.0569000E-01	5.5372000E-01	9.5446000E-01
2.6782000E+03	7.8373000E-01	7.0565000E-01	5.5304000E-01	9.5329000E-01
2.6784000E+03	7.8280000E-01	7.0561000E-01	5.5235000E-01	9.5210000E-01
2.6786000E+03	7.8187000E-01	7.0557000E-01	5.5166000E-01	9.5091000E-01
2.6788000E+03	7.8092000E-01	7.0553000E-01	5.5096000E-01	9.4971000E-01
2.6790000E+03	7.7998000E-01	7.0549000E-01	5.5027000E-01	9.4850000E-01
2.6792000E+03	7.7903000E-01	7.0545000E-01	5.4956000E-01	9.4729000E-01
2.6794000E+03	7.7807000E-01	7.0541000E-01	5.4886000E-01	9.4607000E-01
2.6796000E+03	7.7711000E-01	7.0537000E-01	5.4815000E-01	9.4486000E-01
2.6798000E+03	7.7616000E-01	7.0533000E-01	5.4744000E-01	9.4364000E-01
2.6800000E+03	7.7520000E-01	7.0528000E-01	5.4673000E-01	9.4241000E-01
2.6802000E+03	7.7424000E-01	7.0523000E-01	5.4602000E-01	9.4118000E-01
2.6804000E+03	7.7328000E-01	7.0517000E-01	5.4530000E-01	9.3994000E-01
2.6806000E+03	7.7232000E-01	7.0512000E-01	5.4458000E-01	9.3870000E-01
2.6808000E+03	7.7136000E-01	7.0507000E-01	5.4386000E-01	9.3747000E-01
2.6810000E+03	7.7041000E-01	7.0501000E-01	5.4315000E-01	9.3624000E-01
2.6812000E+03	7.6947000E-01	7.0496000E-01	5.4244000E-01	9.3501000E-01
2.6814000E+03	7.6852000E-01	7.0491000E-01	5.4173000E-01	9.3380000E-01
2.6816000E+03	7.6758000E-01	7.0485000E-01	5.4103000E-01	9.3259000E-01
2.6818000E+03	7.6665000E-01	7.0480000E-01	5.4034000E-01	9.3139000E-01
2.6820000E+03	7.6573000E-01	7.0475000E-01	5.3965000E-01	9.3020000E-01
2.6822000E+03	7.6481000E-01	7.0466000E-01	5.3893000E-01	9.2896000E-01
2.6824000E+03	7.6391000E-01	7.0456000E-01	5.3822000E-01	9.2774000E-01
2.6826000E+03	7.6301000E-01	7.0447000E-01	5.3752000E-01	9.2653000E-01
2.6828000E+03	7.6213000E-01	7.0438000E-01	5.3683000E-01	9.2534000E-01
2.6830000E+03	7.6125000E-01	7.0429000E-01	5.3614000E-01	9.2416000E-01
2.6832000E+03	7.6039000E-01	7.0420000E-01	5.3547000E-01	9.2299000E-01
2.6834000E+03	7.5955000E-01	7.0410000E-01	5.3480000E-01	9.2184000E-01
2.6836000E+03	7.5871000E-01	7.0401000E-01	5.3414000E-01	9.2071000E-01
2.6838000E+03	7.5790000E-01	7.0392000E-01	5.3350000E-01	9.1960000E-01
2.6840000E+03	7.5710000E-01	7.0382000E-01	5.3286000E-01	9.1851000E-01
2.6842000E+03	7.5631000E-01	7.0378000E-01	5.3227000E-01	9.1749000E-01
2.6844000E+03	7.5555000E-01	7.0373000E-01	5.3170000E-01	9.1650000E-01
2.6846000E+03	7.5480000E-01	7.0368000E-01	5.3113000E-01	9.1553000E-01
2.6848000E+03	7.5407000E-01	7.0363000E-01	5.3058000E-01	9.1458000E-01
2.6850000E+03	7.5336000E-01	7.0358000E-01	5.3005000E-01	9.1366000E-01
2.6852000E+03	7.5268000E-01	7.0353000E-01	5.2953000E-01	9.1276000E-01
2.6854000E+03	7.5201000E-01	7.0348000E-01	5.2903000E-01	9.1189000E-01
2.6856000E+03	7.5137000E-01	7.0343000E-01	5.2854000E-01	9.1105000E-01

2.6858000E+03	7.5075000E-01	7.0338000E-01	5.2806000E-01	9.1023000E-01
2.6860000E+03	7.5015000E-01	7.0334000E-01	5.2761000E-01	9.0945000E-01
2.6862000E+03	7.4958000E-01	7.0332000E-01	5.2719000E-01	9.0873000E-01
2.6864000E+03	7.4903000E-01	7.0330000E-01	5.2679000E-01	9.0804000E-01
2.6866000E+03	7.4850000E-01	7.0328000E-01	5.2641000E-01	9.0738000E-01
2.6868000E+03	7.4800000E-01	7.0327000E-01	5.2604000E-01	9.0675000E-01
2.6870000E+03	7.4753000E-01	7.0325000E-01	5.2570000E-01	9.0616000E-01
2.6872000E+03	7.4708000E-01	7.0324000E-01	5.2538000E-01	9.0560000E-01
2.6874000E+03	7.4666000E-01	7.0323000E-01	5.2508000E-01	9.0508000E-01
2.6876000E+03	7.4626000E-01	7.0323000E-01	5.2479000E-01	9.0460000E-01
2.6878000E+03	7.4590000E-01	7.0322000E-01	5.2453000E-01	9.0414000E-01
2.6880000E+03	7.4555000E-01	7.0322000E-01	5.2428000E-01	9.0372000E-01
2.6882000E+03	7.4524000E-01	7.0316000E-01	5.2402000E-01	9.0327000E-01
2.6884000E+03	7.4495000E-01	7.0310000E-01	5.2377000E-01	9.0283000E-01
2.6886000E+03	7.4469000E-01	7.0302000E-01	5.2353000E-01	9.0241000E-01
2.6888000E+03	7.4445000E-01	7.0294000E-01	5.2330000E-01	9.0203000E-01
2.6890000E+03	7.4425000E-01	7.0286000E-01	5.2310000E-01	9.0167000E-01
2.6892000E+03	7.4406000E-01	7.0277000E-01	5.2290000E-01	9.0134000E-01
2.6894000E+03	7.4391000E-01	7.0268000E-01	5.2273000E-01	9.0104000E-01
2.6896000E+03	7.4378000E-01	7.0259000E-01	5.2257000E-01	9.0077000E-01
2.6898000E+03	7.4367000E-01	7.0250000E-01	5.2243000E-01	9.0053000E-01
2.6900000E+03	7.4359000E-01	7.0241000E-01	5.2231000E-01	9.0032000E-01
2.6902000E+03	7.4354000E-01	7.0231000E-01	5.2220000E-01	9.0012000E-01
2.6904000E+03	7.4351000E-01	7.0221000E-01	5.2210000E-01	8.9995000E-01
2.6906000E+03	7.4350000E-01	7.0211000E-01	5.2202000E-01	8.9981000E-01
2.6908000E+03	7.4351000E-01	7.0201000E-01	5.2195000E-01	8.9970000E-01
2.6910000E+03	7.4354000E-01	7.0191000E-01	5.2190000E-01	8.9961000E-01
2.6912000E+03	7.4360000E-01	7.0181000E-01	5.2186000E-01	8.9954000E-01
2.6914000E+03	7.4368000E-01	7.0170000E-01	5.2184000E-01	8.9950000E-01
2.6916000E+03	7.4377000E-01	7.0159000E-01	5.2182000E-01	8.9948000E-01
2.6918000E+03	7.4388000E-01	7.0149000E-01	5.2182000E-01	8.9947000E-01
2.6920000E+03	7.4401000E-01	7.0138000E-01	5.2183000E-01	8.9949000E-01
2.6922000E+03	7.4415000E-01	7.0131000E-01	5.2188000E-01	8.9957000E-01
2.6924000E+03	7.4431000E-01	7.0123000E-01	5.2193000E-01	8.9967000E-01
2.6926000E+03	7.4448000E-01	7.0116000E-01	5.2200000E-01	8.9978000E-01
2.6928000E+03	7.4466000E-01	7.0109000E-01	5.2207000E-01	8.9990000E-01
2.6930000E+03	7.4485000E-01	7.0101000E-01	5.2215000E-01	9.0004000E-01
2.6932000E+03	7.4505000E-01	7.0094000E-01	5.2224000E-01	9.0019000E-01
2.6934000E+03	7.4525000E-01	7.0087000E-01	5.2233000E-01	9.0035000E-01
2.6936000E+03	7.4547000E-01	7.0080000E-01	5.2243000E-01	9.0051000E-01
2.6938000E+03	7.4568000E-01	7.0073000E-01	5.2252000E-01	9.0068000E-01
2.6940000E+03	7.4590000E-01	7.0066000E-01	5.2262000E-01	9.0085000E-01
2.6942000E+03	7.4611000E-01	7.0061000E-01	5.2273000E-01	9.0104000E-01

2.6944000E+03	7.4632000E-01	7.0055000E-01	5.2284000E-01	9.0123000E-01
2.6946000E+03	7.4653000E-01	7.0050000E-01	5.2295000E-01	9.0141000E-01
2.6948000E+03	7.4674000E-01	7.0044000E-01	5.2305000E-01	9.0158000E-01
2.6950000E+03	7.4693000E-01	7.0039000E-01	5.2314000E-01	9.0175000E-01
2.6952000E+03	7.4712000E-01	7.0033000E-01	5.2323000E-01	9.0190000E-01
2.6954000E+03	7.4729000E-01	7.0028000E-01	5.2331000E-01	9.0205000E-01
2.6956000E+03	7.4745000E-01	7.0023000E-01	5.2339000E-01	9.0217000E-01
2.6958000E+03	7.4759000E-01	7.0018000E-01	5.2345000E-01	9.0227000E-01
2.6960000E+03	7.4772000E-01	7.0012000E-01	5.2349000E-01	9.0236000E-01
2.6962000E+03	7.4782000E-01	7.0006000E-01	5.2352000E-01	9.0240000E-01
2.6964000E+03	7.4790000E-01	7.0000000E-01	5.2353000E-01	9.0242000E-01
2.6966000E+03	7.4796000E-01	6.9994000E-01	5.2353000E-01	9.0241000E-01
2.6968000E+03	7.4798000E-01	6.9988000E-01	5.2350000E-01	9.0237000E-01
2.6970000E+03	7.4798000E-01	6.9982000E-01	5.2345000E-01	9.0229000E-01
2.6972000E+03	7.4794000E-01	6.9977000E-01	5.2339000E-01	9.0217000E-01
2.6974000E+03	7.4787000E-01	6.9972000E-01	5.2330000E-01	9.0202000E-01
2.6976000E+03	7.4777000E-01	6.9967000E-01	5.2319000E-01	9.0183000E-01
2.6978000E+03	7.4762000E-01	6.9962000E-01	5.2305000E-01	9.0158000E-01
2.6980000E+03	7.4743000E-01	6.9957000E-01	5.2288000E-01	9.0129000E-01
2.6982000E+03	7.4719000E-01	6.9946000E-01	5.2263000E-01	9.0087000E-01
2.6984000E+03	7.4691000E-01	6.9936000E-01	5.2236000E-01	9.0040000E-01
2.6986000E+03	7.4658000E-01	6.9926000E-01	5.2205000E-01	8.9987000E-01
2.6988000E+03	7.4620000E-01	6.9916000E-01	5.2171000E-01	8.9928000E-01
2.6990000E+03	7.4577000E-01	6.9905000E-01	5.2133000E-01	8.9863000E-01
2.6992000E+03	7.4527000E-01	6.9895000E-01	5.2091000E-01	8.9791000E-01
2.6994000E+03	7.4472000E-01	6.9886000E-01	5.2045000E-01	8.9711000E-01
2.6996000E+03	7.4411000E-01	6.9876000E-01	5.1995000E-01	8.9625000E-01
2.6998000E+03	7.4344000E-01	6.9866000E-01	5.1941000E-01	8.9531000E-01
2.7000000E+03	7.4270000E-01	6.9856000E-01	5.1882000E-01	8.9429000E-01
2.7002000E+03	7.4189000E-01	6.9844000E-01	5.1816000E-01	8.9317000E-01
2.7004000E+03	7.4101000E-01	6.9832000E-01	5.1746000E-01	8.9196000E-01
2.7006000E+03	7.4006000E-01	6.9820000E-01	5.1671000E-01	8.9066000E-01
2.7008000E+03	7.3904000E-01	6.9808000E-01	5.1590000E-01	8.8927000E-01
2.7010000E+03	7.3794000E-01	6.9796000E-01	5.1505000E-01	8.8780000E-01
2.7012000E+03	7.3676000E-01	6.9784000E-01	5.1414000E-01	8.8623000E-01
2.7014000E+03	7.3550000E-01	6.9772000E-01	5.1317000E-01	8.8456000E-01
2.7016000E+03	7.3416000E-01	6.9760000E-01	5.1215000E-01	8.8280000E-01
2.7018000E+03	7.3274000E-01	6.9748000E-01	5.1107000E-01	8.8094000E-01
2.7020000E+03	7.3123000E-01	6.9736000E-01	5.0993000E-01	8.7898000E-01
2.7022000E+03	7.2963000E-01	6.9730000E-01	5.0877000E-01	8.7698000E-01
2.7024000E+03	7.2795000E-01	6.9724000E-01	5.0755000E-01	8.7488000E-01
2.7026000E+03	7.2617000E-01	6.9717000E-01	5.0627000E-01	8.7266000E-01
2.7028000E+03	7.2430000E-01	6.9711000E-01	5.0492000E-01	8.7034000E-01

2.7030000E+03	7.2234000E-01	6.9705000E-01	5.0351000E-01	8.6791000E-01
2.7032000E+03	7.2029000E-01	6.9698000E-01	5.0203000E-01	8.6535000E-01
2.7034000E+03	7.1814000E-01	6.9691000E-01	5.0048000E-01	8.6268000E-01
2.7036000E+03	7.1589000E-01	6.9684000E-01	4.9886000E-01	8.5990000E-01
2.7038000E+03	7.1355000E-01	6.9677000E-01	4.9718000E-01	8.5700000E-01
2.7040000E+03	7.1110000E-01	6.9670000E-01	4.9543000E-01	8.5398000E-01
2.7042000E+03	7.0856000E-01	6.9661000E-01	4.9359000E-01	8.5081000E-01
2.7044000E+03	7.0591000E-01	6.9652000E-01	4.9169000E-01	8.4753000E-01
2.7046000E+03	7.0317000E-01	6.9643000E-01	4.8971000E-01	8.4412000E-01
2.7048000E+03	7.0032000E-01	6.9634000E-01	4.8767000E-01	8.4060000E-01
2.7050000E+03	6.9737000E-01	6.9626000E-01	4.8555000E-01	8.3695000E-01
2.7052000E+03	6.9432000E-01	6.9617000E-01	4.8336000E-01	8.3318000E-01
2.7054000E+03	6.9117000E-01	6.9608000E-01	4.8111000E-01	8.2929000E-01
2.7056000E+03	6.8791000E-01	6.9599000E-01	4.7878000E-01	8.2528000E-01
2.7058000E+03	6.8455000E-01	6.9590000E-01	4.7638000E-01	8.2114000E-01
2.7060000E+03	6.8109000E-01	6.9581000E-01	4.7391000E-01	8.1689000E-01
2.7062000E+03	6.7752000E-01	6.9576000E-01	4.7140000E-01	8.1255000E-01
2.7064000E+03	6.7386000E-01	6.9571000E-01	4.6881000E-01	8.0809000E-01
2.7066000E+03	6.7009000E-01	6.9566000E-01	4.6615000E-01	8.0351000E-01
2.7068000E+03	6.6622000E-01	6.9561000E-01	4.6342000E-01	7.9881000E-01
2.7070000E+03	6.6224000E-01	6.9556000E-01	4.6063000E-01	7.9399000E-01
2.7072000E+03	6.5817000E-01	6.9552000E-01	4.5777000E-01	7.8907000E-01
2.7074000E+03	6.5400000E-01	6.9549000E-01	4.5485000E-01	7.8403000E-01
2.7076000E+03	6.4973000E-01	6.9545000E-01	4.5186000E-01	7.7887000E-01
2.7078000E+03	6.4536000E-01	6.9542000E-01	4.4880000E-01	7.7360000E-01
2.7080000E+03	6.4090000E-01	6.9538000E-01	4.4567000E-01	7.6821000E-01
2.7082000E+03	6.3634000E-01	6.9532000E-01	4.4246000E-01	7.6267000E-01
2.7084000E+03	6.3168000E-01	6.9524000E-01	4.3917000E-01	7.5700000E-01
2.7086000E+03	6.2694000E-01	6.9514000E-01	4.3581000E-01	7.5121000E-01
2.7088000E+03	6.2210000E-01	6.9504000E-01	4.3239000E-01	7.4531000E-01
2.7090000E+03	6.1717000E-01	6.9494000E-01	4.2890000E-01	7.3930000E-01
2.7092000E+03	6.1216000E-01	6.9484000E-01	4.2536000E-01	7.3319000E-01
2.7094000E+03	6.0706000E-01	6.9474000E-01	4.2175000E-01	7.2698000E-01
2.7096000E+03	6.0188000E-01	6.9464000E-01	4.1809000E-01	7.2067000E-01
2.7098000E+03	5.9661000E-01	6.9454000E-01	4.1437000E-01	7.1426000E-01
2.7100000E+03	5.9126000E-01	6.9444000E-01	4.1060000E-01	7.0776000E-01
2.7102000E+03	5.8584000E-01	6.9433000E-01	4.0677000E-01	7.0115000E-01
2.7104000E+03	5.8034000E-01	6.9421000E-01	4.0288000E-01	6.9445000E-01
2.7106000E+03	5.7477000E-01	6.9410000E-01	3.9895000E-01	6.8767000E-01
2.7108000E+03	5.6913000E-01	6.9398000E-01	3.9496000E-01	6.8081000E-01
2.7110000E+03	5.6342000E-01	6.9386000E-01	3.9093000E-01	6.7386000E-01
2.7112000E+03	5.5764000E-01	6.9374000E-01	3.8686000E-01	6.6684000E-01
2.7114000E+03	5.5180000E-01	6.9362000E-01	3.8274000E-01	6.5974000E-01

2.7116000E+03	5.4590000E-01	6.9350000E-01	3.7859000E-01	6.5257000E-01
2.7118000E+03	5.3995000E-01	6.9338000E-01	3.7439000E-01	6.4534000E-01
2.7120000E+03	5.3393000E-01	6.9326000E-01	3.7016000E-01	6.3805000E-01
2.7122000E+03	5.2787000E-01	6.9313000E-01	3.6588000E-01	6.3068000E-01
2.7124000E+03	5.2176000E-01	6.9300000E-01	3.6158000E-01	6.2325000E-01
2.7126000E+03	5.1560000E-01	6.9286000E-01	3.5724000E-01	6.1578000E-01
2.7128000E+03	5.0939000E-01	6.9273000E-01	3.5287000E-01	6.0825000E-01
2.7130000E+03	5.0315000E-01	6.9260000E-01	3.4848000E-01	6.0068000E-01
2.7132000E+03	4.9687000E-01	6.9247000E-01	3.4407000E-01	5.9308000E-01
2.7134000E+03	4.9056000E-01	6.9235000E-01	3.3964000E-01	5.8544000E-01
2.7136000E+03	4.8421000E-01	6.9222000E-01	3.3518000E-01	5.7776000E-01
2.7138000E+03	4.7784000E-01	6.9209000E-01	3.3071000E-01	5.7005000E-01
2.7140000E+03	4.7144000E-01	6.9197000E-01	3.2622000E-01	5.6232000E-01
2.7142000E+03	4.6502000E-01	6.9186000E-01	3.2173000E-01	5.5458000E-01
2.7144000E+03	4.5859000E-01	6.9176000E-01	3.1723000E-01	5.4682000E-01
2.7146000E+03	4.5213000E-01	6.9165000E-01	3.1272000E-01	5.3904000E-01
2.7148000E+03	4.4567000E-01	6.9154000E-01	3.0820000E-01	5.3125000E-01
2.7150000E+03	4.3920000E-01	6.9144000E-01	3.0368000E-01	5.2346000E-01
2.7152000E+03	4.3272000E-01	6.9134000E-01	2.9916000E-01	5.1566000E-01
2.7154000E+03	4.2624000E-01	6.9125000E-01	2.9464000E-01	5.0787000E-01
2.7156000E+03	4.1976000E-01	6.9115000E-01	2.9012000E-01	5.0008000E-01
2.7158000E+03	4.1329000E-01	6.9105000E-01	2.8560000E-01	4.9230000E-01
2.7160000E+03	4.0682000E-01	6.9096000E-01	2.8109000E-01	4.8453000E-01
2.7162000E+03	4.0036000E-01	6.9086000E-01	2.7659000E-01	4.7677000E-01
2.7164000E+03	3.9391000E-01	6.9076000E-01	2.7210000E-01	4.6902000E-01
2.7166000E+03	3.8749000E-01	6.9065000E-01	2.6762000E-01	4.6130000E-01
2.7168000E+03	3.8108000E-01	6.9055000E-01	2.6315000E-01	4.5360000E-01
2.7170000E+03	3.7469000E-01	6.9045000E-01	2.5871000E-01	4.4594000E-01
2.7172000E+03	3.6833000E-01	6.9035000E-01	2.5428000E-01	4.3830000E-01
2.7174000E+03	3.6200000E-01	6.9026000E-01	2.4987000E-01	4.3071000E-01
2.7176000E+03	3.5569000E-01	6.9015000E-01	2.4548000E-01	4.2314000E-01
2.7178000E+03	3.4942000E-01	6.9002000E-01	2.4111000E-01	4.1561000E-01
2.7180000E+03	3.4319000E-01	6.8990000E-01	2.3677000E-01	4.0812000E-01
2.7182000E+03	3.3700000E-01	6.8977000E-01	2.3245000E-01	4.0068000E-01
2.7184000E+03	3.3085000E-01	6.8965000E-01	2.2817000E-01	3.9330000E-01
2.7186000E+03	3.2474000E-01	6.8952000E-01	2.2391000E-01	3.8596000E-01
2.7188000E+03	3.1868000E-01	6.8940000E-01	2.1969000E-01	3.7869000E-01
2.7190000E+03	3.1266000E-01	6.8927000E-01	2.1551000E-01	3.7148000E-01
2.7192000E+03	3.0670000E-01	6.8914000E-01	2.1136000E-01	3.6433000E-01
2.7194000E+03	3.0080000E-01	6.8900000E-01	2.0725000E-01	3.5724000E-01
2.7196000E+03	2.9495000E-01	6.8887000E-01	2.0318000E-01	3.5022000E-01
2.7198000E+03	2.8915000E-01	6.8874000E-01	1.9915000E-01	3.4328000E-01
2.7200000E+03	2.8342000E-01	6.8860000E-01	1.9516000E-01	3.3641000E-01

2.7202000E+03	2.7775000E-01	6.8851000E-01	1.9123000E-01	3.2963000E-01
2.7204000E+03	2.7214000E-01	6.8842000E-01	1.8734000E-01	3.2293000E-01
2.7206000E+03	2.6659000E-01	6.8832000E-01	1.8350000E-01	3.1631000E-01
2.7208000E+03	2.6112000E-01	6.8823000E-01	1.7971000E-01	3.0977000E-01
2.7210000E+03	2.5571000E-01	6.8814000E-01	1.7596000E-01	3.0331000E-01
2.7212000E+03	2.5037000E-01	6.8805000E-01	1.7227000E-01	2.9694000E-01
2.7214000E+03	2.4511000E-01	6.8796000E-01	1.6862000E-01	2.9066000E-01
2.7216000E+03	2.3991000E-01	6.8787000E-01	1.6503000E-01	2.8446000E-01
2.7218000E+03	2.3479000E-01	6.8778000E-01	1.6149000E-01	2.7836000E-01
2.7220000E+03	2.2975000E-01	6.8769000E-01	1.5800000E-01	2.7234000E-01
2.7222000E+03	2.2478000E-01	6.8759000E-01	1.5456000E-01	2.6641000E-01
2.7224000E+03	2.1989000E-01	6.8749000E-01	1.5117000E-01	2.6058000E-01
2.7226000E+03	2.1508000E-01	6.8740000E-01	1.4784000E-01	2.5484000E-01
2.7228000E+03	2.1034000E-01	6.8730000E-01	1.4457000E-01	2.4919000E-01
2.7230000E+03	2.0569000E-01	6.8720000E-01	1.4135000E-01	2.4365000E-01
2.7232000E+03	2.0111000E-01	6.8710000E-01	1.3819000E-01	2.3819000E-01
2.7234000E+03	1.9662000E-01	6.8701000E-01	1.3508000E-01	2.3284000E-01
2.7236000E+03	1.9220000E-01	6.8692000E-01	1.3203000E-01	2.2758000E-01
2.7238000E+03	1.8787000E-01	6.8683000E-01	1.2904000E-01	2.2242000E-01
2.7240000E+03	1.8362000E-01	6.8673000E-01	1.2610000E-01	2.1736000E-01
2.7242000E+03	1.7945000E-01	6.8663000E-01	1.2322000E-01	2.1239000E-01
2.7244000E+03	1.7537000E-01	6.8653000E-01	1.2039000E-01	2.0752000E-01
2.7246000E+03	1.7136000E-01	6.8643000E-01	1.1763000E-01	2.0275000E-01
2.7248000E+03	1.6743000E-01	6.8633000E-01	1.1492000E-01	1.9808000E-01
2.7250000E+03	1.6359000E-01	6.8623000E-01	1.1226000E-01	1.9351000E-01
2.7252000E+03	1.5983000E-01	6.8613000E-01	1.0966000E-01	1.8903000E-01
2.7254000E+03	1.5615000E-01	6.8603000E-01	1.0712000E-01	1.8465000E-01
2.7256000E+03	1.5255000E-01	6.8593000E-01	1.0464000E-01	1.8036000E-01
2.7258000E+03	1.4902000E-01	6.8583000E-01	1.0220000E-01	1.7617000E-01
2.7260000E+03	1.4558000E-01	6.8573000E-01	9.9830000E-02	1.7208000E-01
2.7262000E+03	1.4222000E-01	6.8557000E-01	9.7501000E-02	1.6806000E-01
2.7264000E+03	1.3893000E-01	6.8542000E-01	9.5227000E-02	1.6414000E-01
2.7266000E+03	1.3572000E-01	6.8526000E-01	9.3006000E-02	1.6032000E-01
2.7268000E+03	1.3259000E-01	6.8510000E-01	9.0839000E-02	1.5658000E-01
2.7270000E+03	1.2954000E-01	6.8493000E-01	8.8724000E-02	1.5293000E-01
2.7272000E+03	1.2655000E-01	6.8476000E-01	8.6659000E-02	1.4938000E-01
2.7274000E+03	1.2365000E-01	6.8459000E-01	8.4647000E-02	1.4591000E-01
2.7276000E+03	1.2081000E-01	6.8442000E-01	8.2685000E-02	1.4252000E-01
2.7278000E+03	1.1805000E-01	6.8425000E-01	8.0773000E-02	1.3923000E-01
2.7280000E+03	1.1535000E-01	6.8408000E-01	7.8909000E-02	1.3602000E-01
2.7282000E+03	1.1273000E-01	6.8391000E-01	7.7095000E-02	1.3289000E-01
2.7284000E+03	1.1017000E-01	6.8373000E-01	7.5328000E-02	1.2984000E-01
2.7286000E+03	1.0768000E-01	6.8356000E-01	7.3607000E-02	1.2688000E-01

2.7288000E+03	1.0526000E-01	6.8339000E-01	7.1932000E-02	1.2399000E-01
2.7290000E+03	1.0290000E-01	6.8322000E-01	7.0302000E-02	1.2118000E-01
2.7292000E+03	1.0060000E-01	6.8306000E-01	6.8715000E-02	1.1845000E-01
2.7294000E+03	9.8364000E-02	6.8289000E-01	6.7172000E-02	1.1578000E-01
2.7296000E+03	9.6189000E-02	6.8272000E-01	6.5670000E-02	1.1320000E-01
2.7298000E+03	9.4073000E-02	6.8255000E-01	6.4209000E-02	1.1068000E-01
2.7300000E+03	9.2014000E-02	6.8238000E-01	6.2788000E-02	1.0823000E-01
2.7302000E+03	9.0011000E-02	6.8221000E-01	6.1406000E-02	1.0585000E-01
2.7304000E+03	8.8063000E-02	6.8204000E-01	6.0062000E-02	1.0353000E-01
2.7306000E+03	8.6167000E-02	6.8186000E-01	5.8754000E-02	1.0128000E-01
2.7308000E+03	8.4324000E-02	6.8169000E-01	5.7483000E-02	9.9084000E-02
2.7310000E+03	8.2530000E-02	6.8152000E-01	5.6246000E-02	9.6952000E-02
2.7312000E+03	8.0786000E-02	6.8135000E-01	5.5043000E-02	9.4879000E-02
2.7314000E+03	7.9089000E-02	6.8117000E-01	5.3873000E-02	9.2863000E-02
2.7316000E+03	7.7438000E-02	6.8100000E-01	5.2735000E-02	9.0901000E-02
2.7318000E+03	7.5832000E-02	6.8083000E-01	5.1628000E-02	8.8993000E-02
2.7320000E+03	7.4268000E-02	6.8066000E-01	5.0551000E-02	8.7136000E-02
2.7322000E+03	7.2747000E-02	6.8050000E-01	4.9504000E-02	8.5331000E-02
2.7324000E+03	7.1265000E-02	6.8035000E-01	4.8485000E-02	8.3575000E-02
2.7326000E+03	6.9823000E-02	6.8020000E-01	4.7493000E-02	8.1865000E-02
2.7328000E+03	6.8418000E-02	6.8005000E-01	4.6528000E-02	8.0200000E-02
2.7330000E+03	6.7050000E-02	6.7989000E-01	4.5587000E-02	7.8578000E-02
2.7332000E+03	6.5716000E-02	6.7973000E-01	4.4669000E-02	7.6998000E-02
2.7334000E+03	6.4416000E-02	6.7957000E-01	4.3776000E-02	7.5457000E-02
2.7336000E+03	6.3149000E-02	6.7941000E-01	4.2904000E-02	7.3955000E-02
2.7338000E+03	6.1913000E-02	6.7925000E-01	4.2054000E-02	7.2490000E-02
2.7340000E+03	6.0706000E-02	6.7909000E-01	4.1225000E-02	7.1060000E-02
2.7342000E+03	5.9529000E-02	6.7890000E-01	4.0414000E-02	6.9663000E-02
2.7344000E+03	5.8379000E-02	6.7871000E-01	3.9622000E-02	6.8298000E-02
2.7346000E+03	5.7255000E-02	6.7852000E-01	3.8849000E-02	6.6965000E-02
2.7348000E+03	5.6157000E-02	6.7833000E-01	3.8093000E-02	6.5662000E-02
2.7350000E+03	5.5083000E-02	6.7814000E-01	3.7354000E-02	6.4388000E-02
2.7352000E+03	5.4033000E-02	6.7796000E-01	3.6632000E-02	6.3143000E-02
2.7354000E+03	5.3005000E-02	6.7777000E-01	3.5925000E-02	6.1924000E-02
2.7356000E+03	5.1998000E-02	6.7758000E-01	3.5232000E-02	6.0731000E-02
2.7358000E+03	5.1011000E-02	6.7739000E-01	3.4554000E-02	5.9562000E-02
2.7360000E+03	5.0045000E-02	6.7720000E-01	3.3890000E-02	5.8417000E-02
2.7362000E+03	4.9186000E-02	6.7703000E-01	3.3300000E-02	5.7400000E-02
2.7364000E+03	4.8252000E-02	6.7685000E-01	3.2660000E-02	5.6296000E-02
2.7366000E+03	4.7336000E-02	6.7668000E-01	3.2031000E-02	5.5212000E-02
2.7368000E+03	4.6435000E-02	6.7651000E-01	3.1414000E-02	5.4149000E-02
2.7370000E+03	4.5551000E-02	6.7634000E-01	3.0808000E-02	5.3104000E-02
2.7372000E+03	4.4682000E-02	6.7617000E-01	3.0213000E-02	5.2078000E-02

2.7374000E+03	4.3827000E-02	6.7601000E-01	2.9628000E-02	5.1070000E-02
2.7376000E+03	4.2987000E-02	6.7585000E-01	2.9053000E-02	5.0079000E-02
2.7378000E+03	4.2160000E-02	6.7569000E-01	2.8487000E-02	4.9103000E-02
2.7380000E+03	4.1346000E-02	6.7553000E-01	2.7930000E-02	4.8144000E-02
2.7382000E+03	4.0544000E-02	6.7536000E-01	2.7382000E-02	4.7198000E-02
2.7384000E+03	3.9754000E-02	6.7519000E-01	2.6842000E-02	4.6268000E-02
2.7386000E+03	3.8976000E-02	6.7502000E-01	2.6310000E-02	4.5350000E-02
2.7388000E+03	3.8209000E-02	6.7485000E-01	2.5785000E-02	4.4447000E-02
2.7390000E+03	3.7453000E-02	6.7467000E-01	2.5269000E-02	4.3556000E-02
2.7392000E+03	3.6707000E-02	6.7450000E-01	2.4759000E-02	4.2678000E-02
2.7394000E+03	3.5972000E-02	6.7433000E-01	2.4257000E-02	4.1812000E-02
2.7396000E+03	3.5246000E-02	6.7415000E-01	2.3762000E-02	4.0958000E-02
2.7398000E+03	3.4531000E-02	6.7398000E-01	2.3273000E-02	4.0116000E-02
2.7400000E+03	3.3825000E-02	6.7381000E-01	2.2791000E-02	3.9286000E-02
2.7402000E+03	3.3128000E-02	6.7369000E-01	2.2318000E-02	3.8470000E-02
2.7404000E+03	3.2440000E-02	6.7358000E-01	2.1851000E-02	3.7665000E-02
2.7406000E+03	3.1762000E-02	6.7347000E-01	2.1391000E-02	3.6871000E-02
2.7408000E+03	3.1093000E-02	6.7335000E-01	2.0936000E-02	3.6088000E-02
2.7410000E+03	3.0432000E-02	6.7324000E-01	2.0488000E-02	3.5316000E-02
2.7412000E+03	2.9780000E-02	6.7313000E-01	2.0046000E-02	3.4554000E-02
2.7414000E+03	2.9138000E-02	6.7302000E-01	1.9610000E-02	3.3802000E-02
2.7416000E+03	2.8504000E-02	6.7291000E-01	1.9180000E-02	3.3061000E-02
2.7418000E+03	2.7879000E-02	6.7280000E-01	1.8757000E-02	3.2331000E-02
2.7420000E+03	2.7262000E-02	6.7268000E-01	1.8339000E-02	3.1611000E-02
2.7422000E+03	2.6655000E-02	6.7253000E-01	1.7926000E-02	3.0900000E-02
2.7424000E+03	2.6056000E-02	6.7238000E-01	1.7520000E-02	3.0199000E-02
2.7426000E+03	2.5467000E-02	6.7223000E-01	1.7119000E-02	2.9509000E-02
2.7428000E+03	2.4886000E-02	6.7207000E-01	1.6725000E-02	2.8830000E-02
2.7430000E+03	2.4315000E-02	6.7192000E-01	1.6338000E-02	2.8161000E-02
2.7432000E+03	2.3753000E-02	6.7178000E-01	1.5957000E-02	2.7505000E-02
2.7434000E+03	2.3200000E-02	6.7164000E-01	1.5582000E-02	2.6859000E-02
2.7436000E+03	2.2656000E-02	6.7150000E-01	1.5214000E-02	2.6224000E-02
2.7438000E+03	2.2122000E-02	6.7136000E-01	1.4852000E-02	2.5601000E-02
2.7440000E+03	2.1598000E-02	6.7121000E-01	1.4497000E-02	2.4988000E-02
2.7442000E+03	2.1083000E-02	6.7108000E-01	1.4148000E-02	2.4388000E-02
2.7444000E+03	2.0578000E-02	6.7094000E-01	1.3807000E-02	2.3799000E-02
2.7446000E+03	2.0084000E-02	6.7080000E-01	1.3472000E-02	2.3222000E-02
2.7448000E+03	1.9599000E-02	6.7067000E-01	1.3144000E-02	2.2657000E-02
2.7450000E+03	1.9124000E-02	6.7053000E-01	1.2823000E-02	2.2103000E-02
2.7452000E+03	1.8659000E-02	6.7040000E-01	1.2509000E-02	2.1562000E-02
2.7454000E+03	1.8205000E-02	6.7026000E-01	1.2202000E-02	2.1033000E-02
2.7456000E+03	1.7761000E-02	6.7013000E-01	1.1902000E-02	2.0517000E-02
2.7458000E+03	1.7328000E-02	6.7000000E-01	1.1610000E-02	2.0012000E-02

2.7460000E+03	1.6905000E-02	6.6987000E-01	1.1324000E-02	1.9520000E-02
2.7462000E+03	1.6493000E-02	6.6975000E-01	1.1046000E-02	1.9041000E-02
2.7464000E+03	1.6092000E-02	6.6963000E-01	1.0775000E-02	1.8574000E-02
2.7466000E+03	1.5701000E-02	6.6951000E-01	1.0512000E-02	1.8120000E-02
2.7468000E+03	1.5321000E-02	6.6939000E-01	1.0256000E-02	1.7678000E-02
2.7470000E+03	1.4952000E-02	6.6928000E-01	1.0007000E-02	1.7249000E-02
2.7472000E+03	1.4593000E-02	6.6916000E-01	9.7650000E-03	1.6832000E-02
2.7474000E+03	1.4245000E-02	6.6905000E-01	9.5305000E-03	1.6428000E-02
2.7476000E+03	1.3908000E-02	6.6894000E-01	9.3034000E-03	1.6036000E-02
2.7478000E+03	1.3581000E-02	6.6882000E-01	9.0834000E-03	1.5657000E-02
2.7480000E+03	1.3265000E-02	6.6871000E-01	8.8705000E-03	1.5290000E-02
2.7482000E+03	1.2959000E-02	6.6855000E-01	8.6641000E-03	1.4934000E-02
2.7484000E+03	1.2664000E-02	6.6839000E-01	8.4647000E-03	1.4591000E-02
2.7486000E+03	1.2380000E-02	6.6823000E-01	8.2724000E-03	1.4259000E-02
2.7488000E+03	1.2105000E-02	6.6807000E-01	8.0869000E-03	1.3939000E-02
2.7490000E+03	1.1840000E-02	6.6791000E-01	7.9082000E-03	1.3631000E-02
2.7492000E+03	1.1586000E-02	6.6775000E-01	7.7362000E-03	1.3335000E-02
2.7494000E+03	1.1341000E-02	6.6759000E-01	7.5708000E-03	1.3050000E-02
2.7496000E+03	1.1105000E-02	6.6743000E-01	7.4119000E-03	1.2776000E-02
2.7498000E+03	1.0879000E-02	6.6727000E-01	7.2593000E-03	1.2513000E-02
2.7500000E+03	1.0662000E-02	6.6711000E-01	7.1129000E-03	1.2261000E-02
2.7502000E+03	1.0454000E-02	6.6692000E-01	6.9723000E-03	1.2018000E-02
2.7504000E+03	1.0255000E-02	6.6674000E-01	6.8376000E-03	1.1786000E-02
2.7506000E+03	1.0065000E-02	6.6656000E-01	6.7087000E-03	1.1564000E-02
2.7508000E+03	9.8822000E-03	6.6638000E-01	6.5853000E-03	1.1351000E-02
2.7510000E+03	9.7079000E-03	6.6620000E-01	6.4674000E-03	1.1148000E-02
2.7512000E+03	9.5413000E-03	6.6601000E-01	6.3546000E-03	1.0954000E-02
2.7514000E+03	9.3823000E-03	6.6583000E-01	6.2470000E-03	1.0768000E-02
2.7516000E+03	9.2305000E-03	6.6565000E-01	6.1442000E-03	1.0591000E-02
2.7518000E+03	9.0856000E-03	6.6547000E-01	6.0462000E-03	1.0422000E-02
2.7520000E+03	8.9475000E-03	6.6528000E-01	5.9526000E-03	1.0261000E-02
2.7522000E+03	8.8158000E-03	6.6507000E-01	5.8631000E-03	1.0106000E-02
2.7524000E+03	8.6903000E-03	6.6488000E-01	5.7780000E-03	9.9597000E-03
2.7526000E+03	8.5707000E-03	6.6470000E-01	5.6969000E-03	9.8199000E-03
2.7528000E+03	8.4567000E-03	6.6452000E-01	5.6196000E-03	9.6867000E-03
2.7530000E+03	8.3480000E-03	6.6434000E-01	5.5459000E-03	9.5596000E-03
2.7532000E+03	8.2443000E-03	6.6416000E-01	5.4755000E-03	9.4382000E-03
2.7534000E+03	8.1455000E-03	6.6397000E-01	5.4083000E-03	9.3224000E-03
2.7536000E+03	8.0511000E-03	6.6378000E-01	5.3442000E-03	9.2119000E-03
2.7538000E+03	7.9610000E-03	6.6360000E-01	5.2829000E-03	9.1062000E-03
2.7540000E+03	7.8749000E-03	6.6341000E-01	5.2243000E-03	9.0051000E-03
2.7542000E+03	7.7925000E-03	6.6328000E-01	5.1686000E-03	8.9092000E-03
2.7544000E+03	7.7135000E-03	6.6315000E-01	5.1152000E-03	8.8171000E-03

2.7546000E+03	7.6377000E-03	6.6302000E-01	5.0640000E-03	8.7288000E-03
2.7548000E+03	7.5649000E-03	6.6289000E-01	5.0147000E-03	8.6439000E-03
2.7550000E+03	7.4947000E-03	6.6276000E-01	4.9672000E-03	8.5620000E-03
2.7552000E+03	7.4270000E-03	6.6263000E-01	4.9213000E-03	8.4829000E-03
2.7554000E+03	7.3614000E-03	6.6249000E-01	4.8769000E-03	8.4064000E-03
2.7556000E+03	7.2978000E-03	6.6236000E-01	4.8338000E-03	8.3321000E-03
2.7558000E+03	7.2360000E-03	6.6222000E-01	4.7918000E-03	8.2598000E-03
2.7560000E+03	7.1756000E-03	6.6209000E-01	4.7509000E-03	8.1892000E-03
2.7562000E+03	7.1165000E-03	6.6194000E-01	4.7107000E-03	8.1198000E-03
2.7564000E+03	7.0584000E-03	6.6179000E-01	4.6711000E-03	8.0517000E-03
2.7566000E+03	7.0011000E-03	6.6163000E-01	4.6322000E-03	7.9846000E-03
2.7568000E+03	6.9445000E-03	6.6148000E-01	4.5937000E-03	7.9182000E-03
2.7570000E+03	6.8883000E-03	6.6133000E-01	4.5554000E-03	7.8523000E-03
2.7572000E+03	6.8322000E-03	6.6119000E-01	4.5174000E-03	7.7868000E-03
2.7574000E+03	6.7762000E-03	6.6106000E-01	4.4795000E-03	7.7213000E-03
2.7576000E+03	6.7200000E-03	6.6092000E-01	4.4414000E-03	7.6557000E-03
2.7578000E+03	6.6635000E-03	6.6078000E-01	4.4031000E-03	7.5897000E-03
2.7580000E+03	6.6065000E-03	6.6064000E-01	4.3645000E-03	7.5232000E-03
2.7582000E+03	6.5487000E-03	6.6053000E-01	4.3256000E-03	7.4562000E-03
2.7584000E+03	6.4902000E-03	6.6041000E-01	4.2862000E-03	7.3882000E-03
2.7586000E+03	6.4306000E-03	6.6030000E-01	4.2461000E-03	7.3191000E-03
2.7588000E+03	6.3699000E-03	6.6018000E-01	4.2053000E-03	7.2488000E-03
2.7590000E+03	6.3080000E-03	6.6007000E-01	4.1637000E-03	7.1770000E-03
2.7592000E+03	6.2447000E-03	6.5996000E-01	4.1213000E-03	7.1039000E-03
2.7594000E+03	6.1799000E-03	6.5986000E-01	4.0779000E-03	7.0291000E-03
2.7596000E+03	6.1135000E-03	6.5975000E-01	4.0334000E-03	6.9525000E-03
2.7598000E+03	6.0455000E-03	6.5965000E-01	3.9879000E-03	6.8740000E-03
2.7600000E+03	5.9757000E-03	6.5955000E-01	3.9413000E-03	6.7936000E-03
2.7602000E+03	5.9041000E-03	6.5945000E-01	3.8935000E-03	6.7112000E-03
2.7604000E+03	5.8306000E-03	6.5936000E-01	3.8445000E-03	6.6268000E-03
2.7606000E+03	5.7552000E-03	6.5927000E-01	3.7942000E-03	6.5402000E-03
2.7608000E+03	5.6778000E-03	6.5918000E-01	3.7427000E-03	6.4514000E-03
2.7610000E+03	5.5985000E-03	6.5908000E-01	3.6899000E-03	6.3603000E-03
2.7612000E+03	5.5172000E-03	6.5900000E-01	3.6358000E-03	6.2671000E-03
2.7614000E+03	5.4338000E-03	6.5891000E-01	3.5804000E-03	6.1716000E-03
2.7616000E+03	5.3485000E-03	6.5882000E-01	3.5237000E-03	6.0739000E-03
2.7618000E+03	5.2612000E-03	6.5873000E-01	3.4657000E-03	5.9740000E-03
2.7620000E+03	5.1720000E-03	6.5864000E-01	3.4065000E-03	5.8719000E-03
2.7622000E+03	5.0809000E-03	6.5852000E-01	3.3459000E-03	5.7673000E-03
2.7624000E+03	4.9880000E-03	6.5839000E-01	3.2840000E-03	5.6607000E-03
2.7626000E+03	4.8933000E-03	6.5826000E-01	3.2211000E-03	5.5522000E-03
2.7628000E+03	4.7969000E-03	6.5813000E-01	3.1570000E-03	5.4418000E-03
2.7630000E+03	4.6989000E-03	6.5801000E-01	3.0919000E-03	5.3295000E-03

2.7632000E+03	4.5994000E-03	6.5788000E-01	3.0258000E-03	5.2157000E-03
2.7634000E+03	4.4984000E-03	6.5776000E-01	2.9589000E-03	5.1003000E-03
2.7636000E+03	4.3962000E-03	6.5763000E-01	2.8911000E-03	4.9834000E-03
2.7638000E+03	4.2928000E-03	6.5751000E-01	2.8226000E-03	4.8653000E-03
2.7640000E+03	4.1884000E-03	6.5739000E-01	2.7534000E-03	4.7461000E-03
2.7642000E+03	4.0831000E-03	6.5728000E-01	2.6837000E-03	4.6260000E-03
2.7644000E+03	3.9771000E-03	6.5717000E-01	2.6136000E-03	4.5051000E-03
2.7646000E+03	3.8704000E-03	6.5706000E-01	2.5431000E-03	4.3836000E-03
2.7648000E+03	3.7634000E-03	6.5696000E-01	2.4724000E-03	4.2617000E-03
2.7650000E+03	3.6562000E-03	6.5685000E-01	2.4016000E-03	4.1396000E-03
2.7652000E+03	3.5489000E-03	6.5674000E-01	2.3307000E-03	4.0175000E-03
2.7654000E+03	3.4418000E-03	6.5663000E-01	2.2600000E-03	3.8956000E-03
2.7656000E+03	3.3350000E-03	6.5653000E-01	2.1895000E-03	3.7741000E-03
2.7658000E+03	3.2288000E-03	6.5642000E-01	2.1194000E-03	3.6533000E-03
2.7660000E+03	3.1233000E-03	6.5631000E-01	2.0499000E-03	3.5334000E-03
2.7662000E+03	3.0189000E-03	6.5624000E-01	1.9811000E-03	3.4149000E-03
2.7664000E+03	2.9157000E-03	6.5617000E-01	1.9132000E-03	3.2978000E-03
2.7666000E+03	2.8139000E-03	6.5610000E-01	1.8462000E-03	3.1823000E-03
2.7668000E+03	2.7138000E-03	6.5603000E-01	1.7804000E-03	3.0688000E-03
2.7670000E+03	2.6157000E-03	6.5596000E-01	1.7158000E-03	2.9576000E-03
2.7672000E+03	2.5198000E-03	6.5590000E-01	1.6527000E-03	2.8488000E-03
2.7674000E+03	2.4263000E-03	6.5583000E-01	1.5912000E-03	2.7429000E-03
2.7676000E+03	2.3355000E-03	6.5577000E-01	1.5316000E-03	2.6400000E-03
2.7678000E+03	2.2477000E-03	6.5571000E-01	1.4738000E-03	2.5404000E-03
2.7680000E+03	2.1630000E-03	6.5565000E-01	1.4182000E-03	2.4446000E-03
2.7682000E+03	2.0819000E-03	6.5554000E-01	1.3647000E-03	2.3524000E-03
2.7684000E+03	2.0044000E-03	6.5543000E-01	1.3137000E-03	2.2645000E-03
2.7686000E+03	1.9308000E-03	6.5532000E-01	1.2653000E-03	2.1810000E-03
2.7688000E+03	1.8614000E-03	6.5521000E-01	1.2196000E-03	2.1023000E-03
2.7690000E+03	1.7963000E-03	6.5510000E-01	1.1768000E-03	2.0284000E-03
2.7692000E+03	1.7357000E-03	6.5498000E-01	1.1369000E-03	1.9596000E-03
2.7694000E+03	1.6797000E-03	6.5487000E-01	1.1000000E-03	1.8961000E-03
2.7696000E+03	1.6285000E-03	6.5475000E-01	1.0662000E-03	1.8379000E-03
2.7698000E+03	1.5820000E-03	6.5464000E-01	1.0356000E-03	1.7851000E-03
2.7700000E+03	1.5403000E-03	6.5453000E-01	1.0081000E-03	1.7377000E-03
2.7702000E+03	1.5033000E-03	6.5438000E-01	9.8372000E-04	1.6957000E-03
2.7704000E+03	1.4710000E-03	6.5423000E-01	9.6236000E-04	1.6588000E-03
2.7706000E+03	1.4432000E-03	6.5408000E-01	9.4396000E-04	1.6271000E-03
2.7708000E+03	1.4197000E-03	6.5394000E-01	9.2839000E-04	1.6003000E-03
2.7710000E+03	1.4003000E-03	6.5382000E-01	9.1554000E-04	1.5781000E-03
2.7712000E+03	1.3848000E-03	6.5369000E-01	9.0520000E-04	1.5603000E-03
2.7714000E+03	1.3727000E-03	6.5357000E-01	8.9718000E-04	1.5465000E-03
2.7716000E+03	1.3639000E-03	6.5345000E-01	8.9126000E-04	1.5363000E-03

2.7718000E+03	1.3580000E-03	6.5333000E-01	8.8722000E-04	1.5293000E-03
2.7720000E+03	1.3546000E-03	6.5320000E-01	8.8483000E-04	1.5252000E-03
2.7722000E+03	1.3534000E-03	6.5316000E-01	8.8399000E-04	1.5238000E-03
2.7724000E+03	0.0000000E+00	6.5312000E-01	0.0000000E+00	0.0000000E+00

Table D.5-14 contains the pre- and post-launch calibration slope and intercept values for MetOp-A HIRS/306 Channel 20.

Table D.5-14. MetOp-A HIRS/306 Channel 20 Slope and Intercept (Albedo %).		
Source	Slope	Intercept
Pre-launch calibration	0.023770	67.7300
Post-launch calibration	TBD	TBD

AMSU:

Table D.5-15. MetOp-A AMSU-A1 (S/N 106, ID=21) PRT Temperature Conversion Coefficients.					
	PRT #	f_{k0} (K)	f_{k1} (K/count)	f_{k2} (K/count²)	f_{k3} (K/count³)
Scan Motor A1-1	1	263.9870	1.731689E-03	3.822561E-09	1.028422E-14
Scan Motor A1-2	2	263.9702	1.733920E-03	3.767659E-09	1.082943E-14
Feedhorn A1-1	3	262.9015	1.733436E-03	3.664060E-09	1.218533E-14
Feedhorn A1-2	4	263.6334	1.735609E-03	3.725756E-09	1.052431E-14
RF Mux A1-1	5	262.9389	1.731870E-03	3.623842E-09	1.211609E-14
RF Mux A1-2	6	263.4331	1.735790E-03	3.669909E-09	1.211365E-14
L.O. CH 3	7	263.5560	1.735983E-03	3.967949E-09	7.681595E-15
L.O. CH 4	8	262.9373	1.734014E-03	3.761015E-09	1.121131E-14
L.O. CH 5	9	262.8178	1.731163E-03	3.752029E-09	9.505904E-15
L.O. CH 6	10	263.4417	1.734077E-03	3.917796E-09	1.128447E-14
L.O. CH 7	11	262.9996	1.747369E-03	3.343567E-09	9.155990E-15
L.O. CH 8	12	263.3053	1.741015E-03	3.500605E-09	1.183477E-14
L.O. CH 15	13	263.6873	1.736346E-03	3.610864E-09	1.205842E-14
PLLO #2 CH9-14	14	263.3672	1.735200E-03	3.709033E-09	1.101641E-14
PLLO #1 CH9-14	15	263.6137	1.733371E-03	3.764484E-09	9.452957E-15
Not Used	16	263.6137	1.733371E-03	3.764484E-09	9.452957E-15
Mixer/IF CH 3	17	264.0699	1.734028E-03	3.767572E-09	9.111964E-15
Mixer/IF CH 4	18	263.9319	1.748879E-03	3.388072E-09	9.858723E-15
Mixer/IF CH 5	19	263.6916	1.745153E-03	3.560328E-09	8.698514E-15
Mixer/IF CH 6	20	262.6377	1.723487E-03	3.583203E-09	1.212495E-14
Mixer/IF CH 7	21	263.06421	1.738316E-03	3.631971E-09	1.190380E-14
Mixer/IF CH 8	22	263.4369	1.743099E-03	3.495317E-09	1.188741E-14
Mixer/IF CH9 -14	23	262.7352	1.728822E-03	3.735996E-09	1.120497E-14

Mixer/IF CH 15	24	262.9482	1.731860E-03	3.694364E-09	1.190977E-14
IF Amp.CH11 - 14	25	263.2314	1.732163E-03	3.762795E-09	9.773389E-15
IF Amp. CH 9	26	263.0380	1.741121E-03	3.748129E-09	9.851083E-15
IF Amp. Ch.10	27	263.3186	1.742946E-03	3.730115E-09	1.125205E-14
IF Amp. Ch.11	28	264.0114	1.742906E-03	3.647763E-09	1.123192E-14
DC/DC Converter	29	262.2898	1.726485E-03	3.956736E-09	1.243824E-14
IF Amp. Ch.13	30	263.5477	1.73392E-03	3.646014E-09	1.166024E-14
IF Amp. Ch.14	31	263.2184	1.740073E-03	3.755627E-09	1.069445E-14
IF Amp. Ch.12	32	263.2916	1.732509E-03	3.836888E-09	9.925257E-15
RF Shelf A1-1	33	263.6981	1.731287E-03	3.778609E-09	9.565021E-15
RF Shelf A1-2	34	264.3354	1.748171E-03	3.357364E-09	1.082636E-14
Detector/PreAmp	35	263.7312	1.736234E-03	3.693059E-09	1.127579E-14
A1-1WarmLoad#1	36	254.5321	1.639002E-03	5.869509E-09	3.072612E-14
A1-1WarmLoad#2	37	254.0022	1.607209E-02	8.022662E-09	-2.009460E-14
A1-1WarmLoad#3	38	254.2602	1.644751E-02	5.892945E-09	3.041434E-14
A1-1WarmLoad#4	39	255.1122	1.608134E-03	6.005212E-09	3.373968E-14
A1-1WmLdCenter	40	254.8325	1.635428E-03	5.877971E-09	3.002280E-14
A1-2WarmLoad#1	41	254.4281	1.633255E-03	5.821995E-09	3.044200E-14
A1-2WarmLoad#2	42	254.4755	1.640935E-03	5.779129E-09	3.013209E-14
A1-2WarmLoad#3	43	2.542934	1.634954E-03	5.864132E-09	3.073197E-14
A1-2WarmLoad#4	44	254.5471	1.635103E-03	5.858410E-09	3.093710E-14
A1-2WmLdCenter	45	254.6261	1.639420E-03	5.849467E-09	3.133734E-14

Table D.5-16. METOP-A AMSU-A2 (S/N 108) PRT Temperature Conversion Coefficients.					
	PRT #	f_{k0} (K)	f_{k1} (K/count)	f_{k2} (K/count2)	f_{k3} (K/count3)
Scan Motor	1	263.1324	1.746917E-03	3.795735E-09	1.231495E-14
Feedhorn	2	263.3740	1.749617E-03	3.831875E-09	1.103431E-14
RF Diplexer	3	264.3925	1.753566E-03	3.744340E-09	1.018223E-14
Mixer/IF Ch 1	4	263.1567	1.749016E-03	3.802419E-09	1.137400E-14
Mixer/IF Ch 2	5	263.1198	1.756348E-03	3.787283E-09	1.159493E-14
Ch1 DRO	6	263.5626	1.748585E-03	3.751691E-09	1.205580E-14
Ch2 DRO	7	263.9182	1.751247E-03	3.825043E-09	9.937291E-15
Compensator Motor	8	254.4755	1.745011E-03	4.094067E-09	1.029310E-14
Sub Reflector	9	263.4419	1.747650E-03	3.750830E-09	1.029786E-14
DC/DC Converter	10	263.3896	1.748861E-03	3.783287E-09	1.118430E-14
RF Shelf	11	263.2304	1.743369E-03	3.927309E-09	1.077412E-14
Detector Pre-Amp	12	2.635447	1.746484E-03	3.886169E-09	8.975719E-15
Warm Load Ctr	13	254.7548	1.647906E-03	5.906964E-09	3.154537E-14
Warm Load #1	14	254.7590	1.646893E-03	5.917976E-09	3.057754E-14

Warm Load #2	15	254.7516	1.651416E-03	5.905144E-09	2.987418E-14
Warm Load #3	16	254.5520	1.657917E-03	5.767012E-09	2.812747E-14
Warm Load #4	17	2.546245	1.640567E-03	5.931309E-09	3.082734E-14
Warm Load #5	18	254.5462	1.642780E-03	5.836231E-09	3.181955E-14
Warm Load #6	19	2.546566	1.658447E-03	5.775657E-09	3.352912E-14

Table D.5-17 contains the measured channel characteristics for METOP-A AMSU-A (channels 1-15). The central frequencies are interpolated from the temperature dependent data to 15 C. The f1, f2, f3, and f4 for channels 11-14 are computed from tabulated values. All values are for 15 C. Detailed information on the terminology used in this table can be found in Section 3.3.2.1.

Ch #	Instrument/Serial #	Central Frequency (GHz)	Central Wavenumber (cm ⁻¹)	I/F Frequencies (GHz)			
				Sideband 1		Sideband 2	
				Begin (f ₁)	End (f ₂)	Begin (f ₃)	End (f ₄)
1*	A2/108	23.80084	0.793910	0.00872	0.13423	N/A	N/A
2*	A2/108	31.39952	1.047375	0.00877	0.08912	N/A	N/A
3*	A1-2/106	50.29974	1.677819	0.00890	0.08900	N/A	N/A
4*	A1-2/106	52.80007	1.761221	0.00912	0.19916	N/A	N/A
5	A1-2/106	53.59597	1.787769	0.03138	0.19886	N/A	N/A
6*	A1-1/106	54.40008	1.814591	0.00915	0.19933	N/A	N/A
7*	A1-1/106	54.94034	1.832612	0.00910	0.19919	N/A	N/A
8*	A1-2/106	55.50025	1.851289	0.00914	0.16402	N/A	N/A
9*	A1-1/106	57.29034	1.911000	0.00911	0.16415	N/A	N/A
10	A1-1/106	57.29034	1.911000	0.17901	0.25534	N/A	N/A
11	A1-1/106	57.29034	1.911000	0.25681	0.29166	0.35266	0.38803
12	A1-1/106	57.29034	1.911000	0.29255	0.30798	0.33633	0.35183
13	A1-1/106	57.29034	1.911000	0.30829	0.31614	0.32822	0.33609
14	A1-1/106	57.29034	1.911000	0.31632	0.31925	0.32531	0.32825
15*	A1-1/106	89.00971	2.969044	0.49208	1.48898	N/A	N/A

* The lower frequency cutoff in these single passband channels is due to the stop band.

MHS:

PRT #	f _{k0}	f _{k1}	f _{k2}	f _{k3}	PIE-A/B
A1	25.60900	2.406243	5.543381E-04	1.374451E-06	PIE-A
A2	26.81260	2.372602	8.631135E-04	4.432206E-07	
A3	27.62996	2.346835	1.130614E-03	-4.71123E-07	
A4	28.16592	2.333204	1.244376E-03	-7.811037E-07	
A5	41.24812	1.962822	4.728064E-03	-1.166794E-05	

B1	24.15548	2.446940	1.755666E-04	2.548063E-05	PIE-B
B2	27.44668	2.354256	1.042066E-03	-1.443646E-07	
B3	26.04405	2.395764	6.324133E-03	1.202906E-06	
B4	28.15415	2.330453	1.300758E-03	-1.058064E-06	
B5	28.10611	2.334389	1.238290E-02	-7.799834E-07	

Table D.5-19. MetOp-A MHS Resistances (Ohms) for Three PRT Calibration Channels.

Rcal_1	Rcal_2	Rcal_3	PIE-A or -B
117.989	95.286	80.597	PIE-A
117.997	95.291	80.600	PIE-B

Table D.5-20. MetOp-A MHS Coefficients for Converting Counts into Temperatures (K).

g ₀	g ₁	g ₂	g ₃	g ₄
355.9982	-0.239278	-4.85712E-03	3.59838E-05	-8.02652E-08

Note:

1. One set of coefficients applies to 24 housekeeping thermistors.

Table D.5-21 MetOp-A MHS Coefficients for Converting Counts into Current (amps) for Current Monitors .

Name	Intercept	Slope
RDM Motor	0.0	0.013370
FDM Motor	0.0	0.013370
EE+SM+5V	0.0	0.016810
Receiver+8V	-0.127700	0.021891
Receiver+15V	-0.105230	0.008110
Receiver-15V	-0.168600	0.001882

Table D.5-22. MetOp-A MHS Coefficients for Converting Volts into Temperatures (K).

h ₀	h ₁	h ₂	h ₃	h ₄	h ₅
363.4522	-108.10	64.212	-22.8659	4.110	-0.295

Table D.5-23. MetOp-A MHS Values of the Nonlinearity Parameters μ (m²-sr-cm⁻¹)/mW.

Instrument Temp. (See Note 1)	Ch 16	Ch 17	Ch. 18	Ch. 19	Ch. 20	LO (C)
14.4	-1.254186 E-01	-1.53510 2E-02	-5.114453E-02	-4.692729E-02	-7.954219E-03	LO-A
25.4	-5.638002 E-03	-2.39221 3E-04	-2.953739E-02	-2.247278E-02	-2.606214E-03	LO-A
38.1	1.180412 E-02	1.670801 E-02	-1.999693E-02	-1.342902E-02	-5.011249E-04	LO-A

14.4	-7.236113 E-02	-9.90711 4E-04	-3.668495E-02	-4.150773E-02	-9.350563E-03	LO-B
25.4	-2.888378 E-02	9.733833 E-04	-1.885327E-02	-2.785992E-02	-4.907237E-03	LO-B
38.1	3.080002 E-02	3.064643 E-02	-1.339739E-02	-1.900996E-02	3.557148E-03	LO-B
Note:						
1. QBS5 temperature.						

Table D.5-24. MetOp-A MHS Wavenumbers and Band-Correction Factors.			
Channel Number	Wavenumber (cm-1)	Band-correction factors: $T_w = b + c * T_w$	
		b	c
16	2.968720	0.0	1.0
17	5.236956	0.0	1.0
18	6.114597	0.0	1.0
19	6.114597	-0.0031	1.00027
20	6.348092	0.0	1.0

Table D.5-25. MetOp-A MHS (PFM, S/N=103) Channel IF Characteristics.				
Channel	Nominal Center Frequency (GHz)	Lower IF -3 dB Frequency (GHz)	Upper IF -3 dB Frequency (GHz)	# Bandpasses
H1	89.000	0.111	1.206	1
H2	157.000	0.112	1.208	1
H3	183.311	0.750	1.210	2
H4	183.311	2.525	3.434	2
H5	190.311	0.113	1.079	1

D.6 NOAA-19 (P)

Launch date February 6, 2009

Operational dates: XXXXX YY, 2009 - present

Afternoon orbit: 1400 LST ascending node, 0200 LST descending node

AVHRR instrument: 6 channels (AVHRR/3)

Spacecraft ID (PACS): 8

- AVHRR: 13
- TIP 1 (TIP side 1): 15
- TIP 2 (TIP side 2): 0

Abnormalities:

Up to date information regarding abnormalities on the POES spacecraft and instruments can be found at: <http://www.oso.noaa.gov/poesstatus/>. This website allows a user to search and sort on any POES spacecraft, subsystem or instrument status. Once a user narrows down their window of interest, further details can be obtained by going to the NOAA/NESDIS/Office of Satellite Operations' (OSO) archive of weekly status reports at: <http://noaasis.noaa.gov/NOAASIS/ml/podocs.html>.

AVHRR:

Table D.6-1 contains the PRT weighting factors for NOAA-19 and Table D.6-2 contains the radiance of space and the coefficients for nonlinear radiance correction quadratic for NOAA-19.

Table D.6-1. NOAA-19 PRT Weighting Factors.			
b₁	b₂	b₃	b₄
1.00	1.00	1.00	1.00

Table D.6-2. NOAA-19 Radiance of Space and Coefficients for Nonlinear Radiance Correction Quadratic.				
	N_S	b₀	b₁	b₂
Channel 4	-5.49	5.70	-0.11187	0.00054668
Channel 5	-3.39	3.58	-0.05991	0.00024985

Table D.6-3 contains NOAA-19 coefficients d_0 , d_1 , d_2 , d_3 and d_4 that relate temperature, T_{PRT} (Kelvin) of each PRT to count value, C_{PRT} , by the equation:

$$T_{PRT} = d_0 + d_1 C_{PRT} + d_2 C_{PRT}^2 + d_3 C_{PRT}^3 + d_4 C_{PRT}^4$$

Table D.6-3. NOAA-19 AVHRR/3 Conversion Coefficients.
--

PRT	d ₀	d ₁	d ₂	d ₃	d ₄
1	276.6067	0.051111	1.405783E-06	0	0
2	276.6119	0.051090	1496037E-06	0	0
3	276.6311	0.051033	1.496990E-06	0	0
4	276.6268	0.051058	1.493110E-06	0	0

Table D.6-4 contains the pre-launch calibration coefficients (albedo representation) for the AVHRR/3 instrument on NOAA-19.

Table D.6-4. NOAA-19 AVHRR/3 Pre-launch Calibration Coefficients (Albedo Representation).			
Channel #	Contents	Slope	Intercept
1	Low albedo range (0-25%)	0.055091	-2.1415
	High albedo range (26 - 100%)	0.16253	-55.863
2	Low albedo range (0-25%)	0.054892	-2.1288
	High albedo range (26 - 100%)	0.16325	-56.445
3A	Low albedo range (0-12.5%)	0.027174	-1.0881
	High albedo range (12.6 - 100%)	0.18798	-81.491

Note: The albedo ranges given in parentheses are nominal; the points of intersection of the two regression lines are located at 496.43, 500.37 and 496.11 counts for channels 1, 2, and 3A respectively. This information is based on the data in AVHRR S/N A308 Alignment/ Calibration Handbook (Report 8172845, Rev B), January 2002.

Table D.6-5 contains a summary of the spectral response data as a function of wavenumber for all channels of the NOAA-19 AVHRR/3.

Table D.6-5. Summary of NOAA-19 AVHRR Spectral Response Data (as a Function of Wavenumber) for Each Channel.		
Channel 1		
The peak wavenumber was at 15245.00 and had a value of 1.00.		
File starting point is at wavenumber = 12050.00.		
File ending point is at wavenumber = 23250.00		
Moment Center Wavenumber = 15784.2371		
Percent line at which curve crosses	Wavenumber (cm ⁻¹)	μm
0.10%	14277.3867	0.7004
1.00%	14435.2715	0.6927
5.00%	14547.8086	0.6874
10.00%	14596.3428	0.6851
20.00%	14646.1045	0.6828
50.00%	14719.5938	0.6794
80.00%	14775.4219	0.6768
80.00%	16136.7061	0.6197
50.00%	16975.2773	0.5891
20.00%	17092.8984	0.5850

10.00%	17135.2090	0.5836		
5.00%	17173.8555	0.5823		
1.00%	17257.7148	0.5795		
0.10%	17381.7168	0.5753		
Area Point Limits	Lower (cm⁻¹)	Upper (cm⁻¹)		
99%	14611.3325	17155.3547		
96%	14713.6513	17020.1521		
70%	14999.1219	16578.3560		
50%	15197.3522	16304.9342		
0% (area center)	15706.8209	15706.8209		
Crossing	Lower (cm⁻¹)	Upper (cm⁻¹)	Width (cm⁻¹)	Center (cm⁻¹)
80%	14775.4219	16136.7061	1361.2842	15456.0645
50%	14719.5938	16975.2773	2255.6836	15847.4355
20%	14646.1045	17092.8984	2446.7939	15869.5020
5%	14575.8086	17173.8555	2626.0469	15860.8320
Channel 2				
The peak wavenumber was at 13015.00 and had a value of 1.00				
File starting point is at wavenumber = 9330.0				
File ending point is at wavenumber = 19995.00				
Moment Center Wavenumber = 12118.8910				
Percent line at which curve crosses	Wavenumber (cm⁻¹)	μm		
0.10%	9733.5342	1.0274		
1.00%	9887.1338	1.0114		
5.00%	9990.2021	1.0010		
10.00%	10037.7236	0.9962		
20.00%	10090.7480	0.9910		
50.00%	10326.6875	0.9684		
80.00%	11177.6660	0.8946		
80.00%	13599.9355	0.7353		
50.00%	13682.8701	0.7308		
20.00%	14088.4570	0.7098		
10.00%	14169.1123	0.7058		
5.00%	14204.4639	0.7040		
1.00%	14262.6563	0.7011		
0.10%	14311.8359	0.6987		
Area Point Limits	Lower (cm⁻¹)	Upper (cm⁻¹)		
99%	10091.7059	14112.1979		
96%	10223.4542	13894.4594		
70%	10886.0980	13272.9090		
50%	11286.8298	12953.4698		
0% (area center)	12159.4505	12159.4505		
Crossing	Lower (cm⁻¹)	Upper (cm⁻¹)	Width (cm⁻¹)	Center (cm⁻¹)
80%	11177.6660	13599.9355	2422.2695	12388.8008

50%	10326.6875	13682.8701	3356.1826	12004.7793
20%	10090.7480	14088.4580	3997.7090	12089.6025
5%	9990.2021	14204.4639	4214.2617	12097.3330
Channel 3A				
The peak wavenumber was at 6235.00 and had a value of 1.00				
File starting point is at wavenumber = 5785.00				
File ending point is at wavenumber = 6705.00				
Moment Center Wavenumber 6211.8197				
Percent line at which curve crosses		Wavenumber (cm⁻¹)		µm
0.10%		6046.6797		1.6538
1.00%		6072.6411		1.6467
5.00%		6090.9370		1.6418
10.00%		6098.2715		1.6398
20.00%		6106.4868		1.6376
50.00%		6119.6953		1.6341
80.00%		6139.9287		1.6287
80.00%		6284.6509		1.5912
50.00%		6298.6855		1.5876
20.00%		6314.8867		1.5836
10.00%		6324.3354		1.5812
5.00%		6333.8184		1.5788
1.00%		6353.1025		1.5740
0.10%		6378.2261		1.5678
Area Point Limits	Lower (cm⁻¹)		Upper (cm⁻¹)	
99%	6090.0225		6325.4298	
96%	6105.7971		6307.1501	
70%	6140.6003		6270.4051	
50%	6161.3471		6252.5217	
0% (area center)	6207.9813		6207.9813	
Crossing	Lower (cm⁻¹)	Upper (cm⁻¹)	Width (cm⁻¹)	Center (cm⁻¹)
80%	6139.9287	6284.6509	144.7222	6212.2900
50%	6119.6953	6298.6855	178.9902	6209.1904
20%	6106.4868	6314.8867	208.3999	6210.6585
5%	6090.9370	6333.8184	242.8813	6212.3779
Channel 3B				
The peak wavenumber was 2637.10 and had a value of 1.00				
File starting point is at wavenumber = 2222.80				
File ending point is at wavenumber = 3355.50				
Moment Center Wavenumber = 2671.6576				
Percent line at which curve crosses		Wavenumber (cm⁻¹)		µm
0.10%		2448.4192		4.0843
1.00%		2484.5686		4.0248
5.00%		2506.5439		3.9896

10.00%	2514.9836	3.9762		
20.00%	2523.1853	3.9632		
50.00%	2536.3921	3.9426		
80.00%	2547.4993	3.9254		
80.00%	2788.9141	3.5856		
50.00%	2807.8833	3.5614		
20.00%	2825.3647	3.5394		
10.00%	2836.7681	3.5251		
5.00%	2849.6602	3.5092		
1.00%	2892.9617	3.4567		
0.10%	2932.2212	3.4104		
Area Point Limits	Lower (cm⁻¹)	Upper (cm⁻¹)		
99%	2515.1558	2847.6939		
96%	2532.6810	2819.0035		
70%	2574.3126	2768.6907		
50%	2602.5630	2739.4841		
0% (area center)	2670.1419	2670.1419		
Crossing	Lower (cm⁻¹)	Upper (cm⁻¹)	Width (cm⁻¹)	Center (cm⁻¹)
80%	2547.4993	2788.9141	241.4148	2668.2065
50%	2536.3921	2807.8833	271.4912	2672.1377
20%	2523.1853	2825.3647	302.1794	2674.2749
5%	2506.5439	2849.6602	343.1162	2678.1021
Channel 4				
The peak wavenumber was at 930.10 and had a value of 1.00				
File starting point is at wavenumber = 781.30				
File ending point is at wavenumber = 1136.20				
Moment Center Wavenumber = 927.8562				
Percent line at which curve crosses	Wavenumber (cm⁻¹)		µm	
0.10%	860.4455		11.6219	
1.00%	867.0934		11.5328	
5.00%	873.5565		11.4475	
10.00%	876.3755		11.4106	
20.00%	879.3934		11.3715	
50.00%	884.9036		11.3007	
80.00%	891.6128		11.2156	
80.00%	982.7612		10.3868	
50.00%	969.4493		10.3151	
20.00%	976.8189		10.2373	
10.00%	980.9343		10.1944	
5.00%	984.2503		10.1600	
1.00%	991.1509		10.0893	
0.10%	998.7431		10.0126	
Area Point Limits	Lower (cm⁻¹)		Upper (cm⁻¹)	

99%	876.3665		981.2958	
96%	882.2563		974.2485	
70%	897.5380		957.5587	
50%	906.5371		948.8781	
0% (area center)	927.8242		927.8242	
Crossing	Lower (cm⁻¹)	Upper (cm⁻¹)	Width (cm⁻¹)	Center (cm⁻¹)
80%	891.6128	962.7612	71.1484	927.1870
50%	884.9036	969.4493	84.5458	927.1765
20%	879.3934	976.8189	97.4255	928.1061
5%	873.5565	984.2503	110.6938	928.9034
Channel 5				
The peak wavenumber was at 829.20 and had a value of 1.00				
File starting point is at wavenumber = 714.30				
File ending point is at wavenumber = 999.90				
Moment Center Wavenumber = 831.1655				
Percent line at which curve crosses		Wavenumber (cm⁻¹)	µm	
0.10%		787.1896	12.7037	
1.00%		789.5375	12.6656	
5.00%		792.3710	12.6204	
10.00%		793.3877	12.6042	
20.00%		794.7257	12.5830	
50.00%		797.0346	12.5465	
80.00%		799.4598	12.5084	
80.00%		862.8540	11.5894	
50.00%		864.9755	11.5610	
20.00%		867.2474	11.5307	
10.00%		868.6052	11.5127	
5.00%		869.9035	11.4955	
1.00%		872.5797	11.4603	
0.10%		875.9991	11.4155	
Area Point Limits	Lower (cm⁻¹)		Upper (cm⁻¹)	
99%	793.8878		867.7935	
96%	797.0874		864.6695	
70%	807.1328		854.7998	
50%	814.1522		847.9620	
0% (area center)	831.1863		831.1863	
Crossing	Lower (cm⁻¹)	Upper (cm⁻¹)	Width (cm⁻¹)	Center (cm⁻¹)
80%	799.4598	862.8540	63.3942	831.1569
50%	797.0346	864.9755	67.9409	831.0050
20%	794.7257	867.2474	72.5217	830.9866
5%	792.3710	869.9035	77.5325	831.1372

Table D.6-6 contains NOAA-19 AVHRR/3 solar reflectance channel information such as equivalent width, w , effective central wavelength, λ_e , and in-band solar irradiance, F .

Table D.6-6. NOAA-19 AVHRR/3 Solar Reflectance Channel Information.			
Channel	Equivalent Width w (μm)	Effective Wavelength λ_e (μm)	Extraterrestrial Solar Irradiance in Band F (W/m^2)
1	0.077580	0.636153	126.773
2	0.217591	0.832045	225.698
3A	0.436100	1.610063	10.650

Note: These quantities are based on the solar irradiance data of *Neckel and Labs* (1984), which is a widely used source of such data.

Table D.6-7 contains the temperature-to-radiance coefficients for NOAA-19 AVHRR/3 Channels 3B, 4 and 5.

Table D.6-7. NOAA-19 AVHRR/3 Thermal Channel Temperature-to-Radiance Coefficients			
	ν_c	A	B
Channel 3B	2670.0	1.67396	0.997364
Channel 4	928.9	0.53959	0.998534
Channel 5	831.9	0.36064	0.998913

Tables D.6-8 and D.6-9 contain the corresponding spectral response values for NOAA-19 AVHRR/3 Channels 1, 2, 3A and Channels 3B, 4 and 5, respectively. Note: Negative response values were caused by system response noise and are to be ignored but are included in the table for completeness.

Table D.6-8. NOAA-19 AVHRR/3 Spectral Response Values for Channels 1, 2 and 3A.					
Channel 1		Channel 2		Channel 3A	
Wavelength (μm)	Relative Response	Wavelength (μm)	Relative Response	Wavelength (μm)	Relative Response
0.430	-2.9943E-02	0.500	-5.0261E-03	1.490	2.4373E-04
0.432	9.2429E-03	0.504	6.3735E-03	1.491	-2.2604E-05
0.434	6.0742E-03	0.508	2.9337E-03	1.492	-6.9208E-05
0.436	2.7478E-03	0.512	-5.8908E-03	1.493	-7.7964E-04
0.438	3.2893E-03	0.516	4.3506E-03	1.494	-6.8317E-05
0.440	-7.1737E-03	0.520	-4.7338E-03	1.495	1.1481E-04
0.442	5.9890E-03	0.524	-3.6317E-03	1.496	-4.6999E-04
0.444	-7.5075E-03	0.528	-2.8002E-03	1.497	5.4964E-04
0.446	-1.0913E-02	0.532	2.4736E-03	1.498	2.5358E-04
0.448	2.9692E-04	0.536	-3.8531E-03	1.499	-6.0007E-05

0.450	-1.0079E-02	0.540	-5.5811E-03	1.500	3.2662E-04
0.452	3.0344E-03	0.544	-1.8047E-03	1.501	-8.4790E-05
0.454	-8.8801E-04	0.548	2.8162E-03	1.502	3.2176E-04
0.456	2.7729E-03	0.552	-1.0478E-04	1.503	4.0471E-04
0.458	5.1723E-03	0.556	-1.7851E-03	1.505	6.3005E-05
0.460	6.2540E-03	0.560	1.3201E-03	1.506	-2.6885E-04
0.462	6.2540E-03	0.564	2.4365E-03	1.507	-5.3276E-04
0.464	3.9368E-03	0.568	-2.6308E-04	1.508	-1.0498E-03
0.466	-3.3706E-03	0.572	-1.9784E-03	1.509	-1.3701E-03
0.468	-4.4691E-03	0.576	-1.0509E-03	1.510	-1.7843E-04
0.470	-4.2346E-03	0.580	-4.8359E-04	1.511	-4.8055E-04
0.472	1.8317E-03	0.584	-3.0880E-04	1.512	2.5209E-04
0.474	6.5196E-04	0.588	1.0308E-03	1.513	-7.2523E-04
0.476	-1.1851E-03	0.592	2.0307E-04	1.514	2.4294E-04
0.478	-5.1779E-03	0.596	1.8671E-03	1.516	6.5051E-04
0.480	4.3210E-03	0.600	2.0190E-03	1.515	-1.4115E-03
0.482	-1.2852E-03	0.604	3.9268E-04	1.517	-1.2555E-03
0.484	1.1640E-03	0.608	1.7316E-04	1.518	-1.1165E-03
0.486	7.7510E-04	0.612	-1.6066E-03	1.519	-9.9899E-04
0.488	1.8405E-03	0.616	5.3819E-05	1.520	-4.4164E-05
0.490	-7.8470E-05	0.620	-1.3930E-04	1.521	-1.9976E-04
0.492	1.1779E-03	0.624	5.1013E-04	1.522	2.6514E-04
0.494	8.7176E-04	0.628	6.3060E-04	1.523	-9.2285E-04
0.496	2.5191E-04	0.632	6.7945E-04	1.524	-4.6372E-04
0.498	-4.6756E-04	0.636	1.8426E-04	1.525	-1.8411E-04
0.500	6.3085E-05	0.640	8.9384E-05	1.526	2.5693E-04
0.502	-1.1229E-03	0.644	-7.0120E-04	1.527	5.3200E-05
0.504	2.8985E-04	0.648	-3.8943E-04	1.528	-3.3899E-04
0.506	2.1955E-03	0.652	9.4570E-05	1.529	-3.2231E-04
0.508	-3.7142E-04	0.656	-3.6516E-04	1.530	-7.3016E-04
0.510	2.9956E-04	0.660	4.6551E-04	1.531	-3.9427E-04
0.512	-4.4650E-04	0.664	1.2291E-03	1.532	3.9237E-04
0.514	2.7264E-04	0.668	-5.8268E-04	1.533	2.1647E-04
0.516	2.9213E-04	0.672	2.2996E-04	1.534	-2.5796E-04
0.518	5.4828E-04	0.676	6.5962E-04	1.535	3.9057E-04
0.520	1.1532E-04	0.680	9.6439E-04	1.536	6.7845E-05
0.522	5.3993E-04	0.684	2.9117E-04	1.537	-1.6842E-04
0.524	-3.3914E-04	0.688	-6.6994E-04	1.538	-3.8447E-05
0.526	4.1488E-04	0.692	-8.1379E-04	1.539	-1.4491E-04
0.528	7.0550E-04	0.692	-8.1379E-04	1.540	-2.5205E-04
0.530	-7.6043E-04	0.696	2.0777E-05	1.541	-7.8803E-05
0.532	7.4705E-04	0.700	4.1248E-03	1.542	-4.9909E-04
0.534	-7.3284E-04	0.704	4.9883E-02	1.543	8.4768E-04

0.536	1.5574E-04	0.708	1.6646E-01	1.544	-2.3240E-04
0.538	-7.6428E-04	0.712	2.1896E-01	1.545	-1.5828E-03
0.540	-3.2720E-04	0.716	2.2092E-01	1.546	-4.2156E-04
0.542	8.3113E-05	0.720	2.3091E-01	1.547	-1.2965E-05
0.544	-1.4336E-03	0.724	2.6893E-01	1.548	-1.2591E-03
0.546	2.4389E-04	0.728	3.5781E-01	1.549	1.0484E-04
0.548	4.1211E-04	0.732	5.7614E-01	1.550	4.5950E-04
0.550	-5.8985E-04	0.736	8.3174E-01	1.551	5.0971E-04
0.552	-1.1015E-03	0.740	8.6574E-01	1.552	2.5695E-04
0.554	-6.2537E-04	0.744	8.7314E-01	1.553	-8.2996E-04
0.556	-2.4298E-04	0.748	9.0842E-01	1.554	-9.0095E-04
0.558	-5.1894E-04	0.752	9.3928E-01	1.555	-4.6079E-04
0.560	6.5793E-04	0.756	9.5824E-01	1.556	4.7326E-04
0.562	-5.7906E-04	0.760	9.7731E-01	1.557	1.8289E-04
0.564	-1.3792E-04	0.764	9.8472E-01	1.558	4.3296E-04
0.566	-1.3750E-04	0.768	1.0000E+00	1.559	-6.8567E-04
0.568	5.4153E-04	0.772	9.9069E-01	1.560	-5.7773E-05
0.570	-7.2616E-05	0.776	9.9136E-01	1.561	3.0230E-04
0.572	-1.4429E-04	0.780	9.8762E-01	1.562	6.0411E-04
0.574	2.1713E-04	0.784	9.7624E-01	1.563	-3.9514E-04
0.576	1.4840E-03	0.788	9.8295E-01	1.564	-5.0335E-06
0.578	3.9810E-03	0.792	9.9059E-01	1.565	5.2504E-04
0.580	1.3881E-02	0.796	9.9221E-01	1.566	8.3718E-04
0.582	4.2846E-02	0.800	9.8953E-01	1.567	3.4234E-04
0.584	1.2288E-01	0.804	9.7948E-01	1.568	1.3839E-03
0.586	2.8621E-01	0.808	9.8666E-01	1.569	1.6536E-03
0.588	4.5575E-01	0.812	9.8475E-01	1.570	2.3012E-03
0.590	5.1453E-01	0.816	9.8296E-01	1.571	3.4033E-03
0.592	5.1965E-01	0.820	9.7133E-01	1.572	4.6242E-03
0.594	5.3681E-01	0.824	9.5878E-01	1.573	7.2385E-03
0.596	5.7012E-01	0.828	9.5319E-01	1.574	9.4639E-03
0.598	6.0850E-01	0.832	9.5154E-01	1.575	1.3567E-02
0.600	6.4139E-01	0.836	9.4219E-01	1.576	1.9459E-02
0.602	6.6934E-01	0.840	8.9081E-01	1.577	2.7512E-02
0.604	6.8482E-01	0.844	9.1471E-01	1.578	3.6578E-02
0.606	6.9256E-01	0.848	8.9603E-01	1.579	5.2677E-02
0.608	7.0133E-01	0.852	8.7506E-01	1.580	7.3386E-02
0.610	7.1354E-01	0.856	8.7178E-01	1.581	9.3609E-02
0.612	7.2765E-01	0.860	8.6962E-01	1.582	1.2570E-01
0.614	7.4481E-01	0.864	8.7270E-01	1.583	1.7316E-01
0.616	7.6429E-01	0.868	8.7396E-01	1.584	2.2347E-01
0.618	7.8278E-01	0.872	8.7461E-01	1.585	2.9052E-01
0.620	8.0269E-01	0.876	8.6916E-01	1.586	3.5618E-01

0.622	8.1636E-01	0.880	8.5654E-01	1.587	4.4414E-01
0.624	8.2512E-01	0.884	8.4021E-01	1.588	5.3144E-01
0.626	8.2641E-01	0.888	8.2235E-01	1.589	6.2332E-01
0.628	8.2204E-01	0.892	8.0865E-01	1.590	6.9553E-01
0.630	8.1813E-01	0.896	7.9412E-01	1.591	7.8787E-01
0.632	8.1621E-01	0.900	7.7293E-01	1.592	8.5588E-01
0.634	8.1921E-01	0.904	7.6644E-01	1.593	8.8924E-01
0.636	8.3074E-01	0.908	7.5983E-01	1.594	9.2640E-01
0.638	8.6522E-01	0.912	7.5791E-01	1.595	9.4272E-01
0.640	8.7247E-01	0.916	7.5408E-01	1.596	9.2135E-01
0.642	8.9990E-01	0.920	7.4768E-01	1.597	9.8539E-01
0.644	9.3020E-01	0.924	7.3407E-01	1.598	9.6125E-01
0.646	9.5450E-01	0.928	7.1713E-01	1.599	9.6392E-01
0.648	9.7145E-01	0.932	6.9676E-01	1.600	9.5103E-01
0.650	9.8451E-01	0.936	6.7667E-01	1.601	9.2583E-01
0.652	9.9220E-01	0.940	6.5775E-01	1.602	9.2063E-01
0.654	9.9734E-01	0.944	6.3547E-01	1.603	9.6318E-01
0.656	1.0000E+00	0.948	6.1595E-01	1.604	1.0000E+00
0.658	9.9658E-01	0.952	5.9274E-01	1.605	9.4541E-01
0.660	9.8962E-01	0.956	5.6570E-01	1.606	9.4715E-01
0.662	9.7593E-01	0.960	5.4043E-01	1.607	9.1251E-01
0.664	9.5595E-01	0.964	5.1978E-01	1.608	9.4454E-01
0.666	9.3995E-01	0.968	5.0162E-01	1.609	9.2512E-01
0.668	9.3151E-01	0.972	4.8427E-01	1.610	9.5262E-01
0.670	9.3820E-01	0.976	4.6435E-01	1.611	9.2287E-01
0.672	9.5769E-01	0.980	4.3105E-01	1.612	9.5803E-01
0.674	9.5948E-01	0.984	3.6929E-01	1.613	9.0318E-01
0.676	8.7178E-01	0.988	2.7605E-01	1.614	9.4496E-01
0.678	6.6531E-01	0.992	1.7687E-01	1.615	8.8500E-01
0.680	4.2825E-01	0.996	1.0340E-01	1.616	9.1539E-01
0.682	2.5001E-01	1.000	5.8061E-02	1.617	9.1773E-01
0.684	1.3896E-01	1.004	3.1059E-02	1.618	8.7004E-01
0.686	7.6362E-02	1.008	1.7129E-02	1.619	9.2697E-01
0.688	4.1400E-02	1.012	9.0969E-03	1.620	8.7580E-01
0.690	2.2800E-02	1.016	5.0946E-03	1.621	8.0638E-01
0.692	1.2642E-02	1.020	2.8882E-03	1.622	8.1260E-01
0.694	6.7116E-03	1.024	1.7904E-03	1.623	8.1246E-01
0.696	4.0024E-03	1.028	8.6130E-04	1.624	8.0479E-01
0.698	2.0872E-03	1.032	3.0328E-04	1.625	8.1646E-01
0.700	1.0729E-03	1.036	4.4367E-04	1.626	8.1218E-01
0.702	7.4570E-04	1.040	2.8758E-06	1.627	8.1875E-01
0.704	6.7405E-05	1.044	3.0576E-05	1.628	8.2461E-01
0.706	5.4160E-04	1.048	5.9338E-05	1.629	7.9180E-01

0.708	1.3081E-04	1.052	1.8313E-04	1.630	7.9113E-01
0.710	1.1105E-04	1.056	-2.3012E-05	1.631	7.3096E-01
0.712	-7.0116E-04	1.060	-4.5070E-05	1.632	6.7012E-01
0.714	4.9319E-04	1.064	1.1312E-05	1.633	5.8548E-01
0.716	2.9259E-04	1.068	-9.9343E-05	1.634	5.0800E-01
0.718	-3.3320E-05	1.072	2.2232E-04	1.635	3.9659E-01
0.720	4.7742E-04			1.636	3.1241E-01
0.722	2.7332E-04			1.637	2.4013E-01
0.724	-4.6719E-04			1.638	1.7304E-01
0.726	1.3695E-04			1.639	1.3048E-01
0.728	3.9248E-04			1.640	9.0034E-02
0.730	-7.1954E-04			1.641	6.2458E-02
0.732	3.3948E-04			1.642	4.6096E-02
0.734	-1.8894E-05			1.643	3.2768E-02
0.736	-6.4194E-05			1.644	2.4271E-02
0.738	2.6601E-05			1.645	1.7752E-02
0.740	-5.3629E-04			1.646	1.2576E-02
0.742	7.5733E-06			1.647	8.5135E-03
0.744	-6.6665E-04			1.648	6.7330E-03
0.746	-4.3763E-06			1.649	4.3174E-03
0.748	-4.7935E-04			1.650	3.1974E-03
0.750	-2.6972E-05			1.651	1.9867E-03
0.752	7.6734E-05			1.652	1.4869E-03
0.754	-5.4855E-04			1.653	1.9413E-03
0.756	1.7352E-04			1.654	8.0586E-04
0.758	1.6267E-04			1.655	1.7052E-05
0.760	1.2034E-04			1.656	-7.7357E-05
0.762	3.1201E-04			1.657	2.8368E-04
0.764	-1.7706E-04			1.658	-3.8791E-04
0.766	3.4303E-04			1.659	4.4410E-04
0.768	1.8588E-04			1.660	3.8053E-04
0.770	-2.7590E-04			1.661	1.4949E-04
0.772	1.1495E-04			1.662	4.0254E-04
0.774	-4.3011E-07			1.663	-4.7127E-04
0.776	1.9273E-04			1.664	1.4883E-04
0.778	5.3607E-05			1.665	3.0713E-04
0.780	-4.5914E-04			1.666	6.8972E-05
0.782	2.3406E-05			1.667	-2.1537E-04
0.784	-1.1351E-03			1.668	-1.9702E-04
0.786	4.3329E-04			1.669	3.0395E-04
0.788	2.5103E-04			1.670	5.9870E-04
0.790	1.1779E-03			1.670	5.9870E-04
0.792	8.1592E-05			1.671	6.8043E-04

0.794	7.8020E-04			1.672	1.0607E-04
0.796	-2.5775E-04			1.673	-2.7909E-05
0.798	-2.7705E-04			1.674	-1.0946E-03
0.800	3.0293E-04			1.675	1.9403E-04
0.802	1.2478E-04			1.676	2.6866E-04
0.804	-6.1366E-04			1.677	-4.0022E-04
0.806	5.8777E-04			1.678	-1.9190E-04
0.808	1.4699E-04			1.679	4.3249E-04
0.810	-1.0326E-03			1.680	7.3851E-04
0.812	7.8381E-04			1.681	-2.7595E-04
0.814	-5.0694E-04			1.682	7.6072E-05
0.816	3.2526E-04			1.683	7.5412E-05
0.818	-9.5339E-04			1.684	-2.6819E-04
0.820	1.0490E-04			1.685	-1.0360E-04
0.822	3.7156E-04			1.686	-2.8719E-05
0.824	3.3002E-04			1.687	-1.3566E-04
0.826	-3.5976E-04			1.688	7.3114E-06
0.828	-2.9196E-04			1.689	-3.4162E-04
0.830	-1.3384E-04			1.690	-8.3979E-04
				1.691	5.7519E-04
				1.692	2.1525E-04
				1.693	-4.6752E-04
				1.694	-1.5867E-03
				1.695	-4.0829E-04
				1.696	-2.8730E-04
				1.697	-1.7545E-04
				1.698	1.3792E-04
				1.699	-4.6143E-04
				1.700	-1.4469E-04
				1.701	6.6102E-05
				1.702	7.1965E-04
				1.703	-6.5688E-04
				1.704	2.8322E-04
				1.705	6.3412E-04
				1.706	5.1053E-04
				1.707	1.9481E-04
				1.708	1.6537E-04
				1.709	1.5471E-04
				1.710	-5.7936E-05
				1.711	-7.5810E-05
				1.712	7.1483E-04
				1.713	-1.5504E-04
				1.714	1.4941E-04

				1.715	8.3300E-04
				1.716	5.7810E-04
				1.717	3.7068E-05
				1.718	1.1283E-04
				1.719	-3.9059E-04
				1.720	-2.2420E-04
				1.721	-4.2307E-04
				1.722	-1.6457E-04
				1.723	3.4163E-04
				1.724	-7.0276E-04
				1.725	4.3032E-04
				1.726	-1.0234E-03
				1.727	3.2052E-04
				1.728	-3.2346E-04
				1.729	5.0819E-04
				1.730	-5.2272E-04

Table D.6-9. NOAA-19 AVHRR/3 Spectral Response Values for Channels 3B, 4 and 5.

Channel 3B		Channel 4		Channel 5	
Wavelength (μm)	Relative Response	Wavelength (μm)	Relative Response	Wavelength (μm)	Relative Response
2.980	3.4501E-06	8.800	3.6861E-04	10.000	5.6318E-04
2.987	8.3767E-06	8.820	2.9838E-04	10.020	-6.2907E-04
2.994	1.5767E-05	8.840	4.8992E-04	10.040	-2.1863E-04
3.001	-5.1658E-05	8.860	6.6138E-05	10.060	-7.2595E-04
3.008	-2.9619E-05	8.880	1.7468E-04	10.080	-3.3386E-04
3.015	2.6856E-06	8.900	9.3140E-05	10.100	-5.4509E-04
3.022	2.5951E-05	8.920	2.7873E-06	10.120	-6.0754E-04
3.029	-1.9897E-05	8.940	1.6380E-04	10.140	-1.0729E-03
3.036	3.3018E-05	8.960	3.2264E-05	10.160	-3.5918E-04
3.043	2.1270E-05	8.980	-2.4380E-05	10.180	5.2489E-05
3.050	1.9397E-05	9.000	-8.6566E-06	10.200	-4.1883E-04
3.057	-3.4031E-05	9.020	1.3346E-05	10.220	-6.2141E-04
3.064	-1.8114E-05	9.040	2.7965E-05	10.240	-7.8193E-04
3.071	4.1908E-05	9.060	5.1193E-05	10.260	-4.8686E-04
3.078	8.1638E-06	9.080	-1.1371E-04	10.280	6.6547E-05
3.085	-7.6704E-05	9.100	-2.1066E-05	10.300	-9.0574E-04
3.092	-1.0538E-04	9.120	-1.2132E-04	10.320	-4.3211E-04
3.099	-2.8440E-05	9.140	-8.8341E-06	10.340	-8.1826E-04
3.106	4.7786E-05	9.160	9.4186E-06	10.360	-8.3298E-04
3.113	2.7159E-05	9.180	-4.0183E-05	10.380	-9.8842E-04
3.120	2.0938E-05	9.200	-4.8348E-05	10.400	4.4988E-05
3.127	1.0109E-05	9.220	1.6809E-04	10.420	8.8586E-01
3.134	-1.9824E-05	9.240	1.5505E-04	10.440	9.1841E-01
3.141	3.0857E-05	9.260	1.3673E-04	10.460	9.3837E-01
3.148	-3.6742E-06	9.280	-1.5771E-05	10.480	9.5512E-01
3.155	-2.2168E-05	9.300	1.2265E-04	10.500	9.5959E-01
3.162	-6.4889E-05	9.320	-7.9080E-05	10.520	9.6115E-01
3.169	6.7681E-06	9.340	-1.6404E-04	10.540	9.6494E-01
3.176	8.5868E-06	9.360	5.6598E-04	10.560	9.7232E-01
3.183	-2.3139E-05	9.380	1.8401E-04	10.580	9.7247E-01
3.190	-2.4762E-05	9.400	8.2740E-05	10.600	9.6773E-01
3.197	-3.4833E-05	9.420	6.3869E-05	10.620	9.6102E-01
3.204	-8.3428E-06	9.440	-7.9399E-05	10.640	9.7473E-01
3.211	2.5956E-05	9.460	-1.6312E-04	10.660	9.7451E-01
3.218	1.2721E-05	9.480	1.3116E-04	10.680	9.9368E-01
3.225	-6.1647E-05	9.500	-1.6674E-04	10.700	9.8649E-01
3.232	7.7748E-05	9.520	-5.8907E-06	10.720	9.9700E-01
3.239	-9.1399E-06	9.540	-2.5484E-04	10.740	1.0000E+00
3.246	-1.8269E-05	9.560	-1.8493E-04	10.760	9.9961E-01

3.253	8.7131E-06	9.580	4.4130E-05	10.780	9.8938E-0
3.260	2.7112E-05	9.600	-1.7856E-05	10.800	9.7762E-01
3.267	-7.0045E-05	9.620	-2.8859E-05	10.820	1.0441E-03
3.274	4.8549E-05	9.640	2.3102E-04	10.840	8.5037E-05
3.281	2.4700E-05	9.660	-1.8940E-04	10.860	2.8112E-03
3.288	9.7179E-06	9.680	-5.1825E-05	10.880	1.0848E-03
3.295	4.6883E-05	9.700	-2.3170E-04	10.900	5.2293E-04
3.302	1.3811E-04	9.720	-2.2936E-04	10.920	1.5944E-03
3.316	5.2427E-05	9.740	-3.0975E-04	10.940	1.0311E-03
3.309	1.6350E-04	9.760	-2.2820E-04	10.960	-9.9573E-05
3.323	3.5735E-05	9.780	-1.6011E-04	10.980	4.1718E-04
3.330	1.3522E-04	9.800	-2.8371E-05	11.000	-7.0797E-04
3.337	8.3772E-05	9.820	-2.4630E-04	11.020	-1.5227E-03
3.344	7.9643E-05	9.840	3.8566E-05	11.040	-8.9280E-04
3.351	1.4066E-04	9.860	-1.6060E-04	11.060	-1.3871E-03
3.358	1.1526E-04	9.880	-3.6850E-05	11.080	-1.9214E-04
3.365	1.5506E-04	9.900	1.5881E-04	11.100	8.4211E-04
3.372	1.5009E-04	9.920	7.1544E-05	11.120	5.7674E-04
3.379	1.7844E-04	9.940	-3.6366E-04	11.140	-1.2968E-04
3.386	3.4738E-04	9.960	2.6271E-05	11.160	-1.6632E-03
3.393	3.7636E-04	9.980	2.9011E-04	11.180	-9.1153E-04
3.400	5.9970E-04	10.000	6.3338E-04	11.200	-8.5143E-04
3.407	8.0918E-04	10.020	1.3145E-03	11.220	-1.4113E-03
3.414	1.2406E-03	10.040	2.6344E-03	11.240	-9.4531E-04
3.421	1.7939E-03	10.060	4.6452E-03	11.260	4.3440E-04
3.428	2.8513E-03	10.080	7.9761E-03	11.280	-1.1453E-03
3.435	3.9479E-03	10.100	1.2900E-02	11.300	-1.2577E-03
3.442	5.5813E-03	10.120	2.0627E-02	11.320	-1.1730E-03
3.449	7.5315E-03	10.140	3.2227E-02	11.340	-5.8341E-04
3.456	9.7840E-03	10.160	5.0001E-02	11.360	-4.9172E-04
3.463	1.2122E-02	10.180	7.5545E-02	11.380	-8.7076E-04
3.470	1.4971E-02	10.200	1.1074E-01	11.400	-3.6770E-04
3.477	1.8290E-02	10.220	1.5356E-01	11.420	1.2294E-03
3.484	2.1854E-02	10.240	2.0807E-01	11.440	2.0724E-03
3.491	2.6709E-02	10.260	2.7227E-01	11.460	9.8480E-03
3.498	3.3221E-02	10.280	3.4463E-01	11.480	2.5554E-02
3.505	4.2994E-02	10.300	4.3445E-01	11.500	6.0109E-02
3.512	5.5757E-02	10.320	5.2173E-01	11.520	1.3300E-01
3.519	7.5815E-02	10.340	6.1521E-01	11.540	2.7534E-01
3.526	1.0415E-01	10.360	7.0200E-01	11.560	4.8804E-01
3.533	1.4699E-01	10.380	7.7698E-01	11.580	7.1559E-01
3.540	2.0600E-01	10.400	8.4099E-01	11.600	8.6876E-01
3.547	2.8264E-01	10.420	8.8586E-01	11.620	9.2259E-01

3.554	3.8244E-01	10.440	9.1841E-01	11.640	9.1984E-01
3.561	4.9380E-01	10.460	9.3837E-01	11.660	9.2366E-01
3.568	5.9713E-01	10.480	9.5512E-01	11.680	9.2348E-01
3.575	6.9190E-01	10.500	9.5959E-01	11.700	9.3083E-01
3.582	7.6436E-01	10.520	9.6115E-01	11.720	9.5631E-01
3.589	8.2872E-01	10.540	9.6494E-01	11.740	9.5621E-01
3.596	8.6492E-01	10.560	9.7232E-01	11.760	9.6991E-01
3.603	8.9214E-01	10.580	9.7247E-01	11.780	9.7494E-01
3.610	9.0558E-01	10.600	9.6773E-01	11.800	9.8129E-01
3.617	9.1453E-01	10.620	9.6102E-01	11.820	9.7413E-01
3.624	9.1096E-01	10.640	9.7473E-01	11.840	9.7974E-01
3.631	9.0796E-01	10.660	9.7451E-01	11.860	9.8314E-01
3.638	9.0382E-01	10.680	9.9368E-01	11.880	9.7241E-01
3.645	9.0130E-01	10.700	9.8649E-01	11.900	9.7657E-01
3.652	9.0422E-01	10.720	9.9700E-01	11.920	9.7378E-01
3.659	9.0366E-01	10.740	1.0000E+00	11.940	9.7118E-01
3.666	9.1531E-01	10.760	9.9961E-01	11.960	9.7575E-01
3.673	9.2803E-01	10.780	9.8938E-01	11.980	9.8938E-01
3.680	9.3934E-01	10.800	9.7762E-01	12.000	9.7946E-01
3.687	9.5372E-01	10.820	9.8638E-01	12.020	9.8884E-01
3.694	9.5759E-01	10.840	9.9476E-01	12.040	9.9137E-01
3.701	9.7589E-01	10.860	9.8885E-01	12.060	1.0000E+00
3.708	9.8014E-01	10.880	9.8265E-01	12.080	9.8730E-01
3.715	9.9019E-01	10.900	9.7301E-01	12.100	9.7913E-01
3.722	9.8800E-01	10.920	9.7002E-01	12.120	9.7358E-01
3.729	9.8418E-01	10.940	9.6011E-01	12.140	9.6800E-01
3.736	9.8123E-01	10.960	9.5979E-01	12.160	9.5843E-01
3.743	9.7556E-01	10.980	9.5986E-01	12.180	9.5541E-01
3.750	9.7869E-01	11.000	9.3594E-01	12.200	9.4383E-01
3.757	9.7276E-01	11.020	9.4132E-01	12.220	9.4400E-01
3.764	9.7472E-01	11.040	9.3047E-01	12.240	9.4149E-01
3.771	9.7198E-01	11.060	9.2911E-01	12.260	9.3329E-01
3.778	9.8662E-01	11.080	9.2088E-01	12.280	9.4086E-01
3.785	9.9507E-01	11.100	9.1154E-01	12.300	9.4037E-01
3.792	1.0000E+00	11.120	9.0967E-01	12.320	9.4119E-01
3.799	9.9732E-01	11.140	8.9268E-01	12.340	9.3364E-01
3.806	9.9988E-01	11.160	8.8832E-01	12.360	9.3111E-01
3.813	9.9354E-01	11.180	8.6102E-01	12.380	9.2813E-01
3.820	9.7937E-01	11.200	8.4395E-01	12.400	9.2528E-01
3.827	9.7078E-01	11.220	7.8712E-01	12.420	9.2541E-01
3.834	9.5287E-01	11.240	7.3715E-01	12.440	9.1432E-01
3.841	9.4278E-01	11.260	6.6806E-01	12.460	9.0642E-01
3.848	9.3521E-01	11.280	5.8056E-01	12.480	8.9346E-01

3.855	9.2745E-01	11.300	5.0304E-01	12.500	8.4529E-01
3.862	9.3919E-01	11.320	4.1062E-01	12.520	7.2033E-01
3.869	9.3402E-01	11.340	3.2347E-01	12.540	5.5962E-01
3.876	9.3879E-01	11.360	2.4164E-01	12.560	3.7422E-01
3.883	9.6360E-01	11.380	1.7292E-01	12.580	2.1811E-01
3.890	9.8024E-01	11.400	1.2201E-01	12.600	1.1665E-01
3.897	9.8914E-01	11.420	8.3555E-02	12.620	5.0735E-02
3.904	9.8183E-01	11.440	5.7620E-02	12.640	2.4995E-02
3.911	9.5019E-01	11.460	3.9189E-02	12.660	1.2569E-02
3.918	9.0288E-01	11.480	2.6890E-02	12.680	5.2662E-03
3.925	8.0616E-01	11.500	1.8626E-02	12.700	1.7609E-03
3.932	7.0042E-01	11.520	1.2873E-02	12.720	-2.0185E-03
3.939	5.6767E-01	11.540	8.5899E-03	12.740	5.1316E-04
3.946	4.3992E-01	11.560	5.5348E-03	12.760	1.5293E-03
3.953	3.2747E-01	11.580	3.8567E-03	12.780	-1.5160E-03
3.960	2.3467E-01	11.600	2.0738E-03	12.800	-3.1090E-03
3.967	1.6534E-01	11.620	1.0736E-03	12.820	2.2310E-03
3.974	1.1289E-01	11.640	3.0688E-04	12.840	1.0898E-03
3.981	7.6794E-02	11.660	-2.2371E-04	12.860	-6.9668E-04
3.988	5.4095E-02	11.680	-1.1780E-04	12.880	1.5709E-03
3.995	3.7780E-02	11.700	-4.8047E-04	12.900	-2.8091E-03
4.002	2.7385E-02	11.720	-8.8911E-04	12.920	-3.6009E-03
4.009	1.9912E-02	11.740	-1.0445E-03	12.940	1.1234E-03
4.016	1.4608E-02	11.760	-9.9123E-04	12.960	-2.8745E-03
4.023	1.0763E-02	11.780	-1.0905E-03	12.980	5.2712E-04
4.030	8.2325E-03	11.800	-1.1851E-03	13.000	2.1117E-03
4.037	6.1867E-03	11.820	-7.1932E-04	13.020	3.0497E-03
4.044	4.7484E-03	11.840	-7.7288E-04	13.040	1.7662E-03
4.051	3.7593E-03	11.860	-1.1312E-03	13.060	3.1135E-03
4.058	2.7803E-03	11.880	-1.1462E-03	13.080	2.1812E-03
4.065	2.2390E-03	11.900	-9.6370E-04	13.100	4.2311E-03
4.072	1.5665E-03	11.920	-7.6331E-04	13.120	6.5949E-04
4.079	1.2247E-03	11.940	-7.1854E-04	13.140	-3.9169E-03
4.086	9.3591E-04	11.960	-6.8194E-04	13.160	3.1409E-03
4.093	6.4123E-04	11.980	-1.0468E-03	13.180	-2.8488E-03
4.100	1.7287E-04	12.000	-2.7409E-04	13.200	-2.9508E-03
4.107	7.0091E-04	12.020	-6.4053E-04	13.220	1.1889E-03
4.114	2.7715E-04	12.040	-6.4127E-04	13.240	2.9075E-03
4.121	4.3325E-05	12.060	-8.2835E-04	13.260	8.3141E-03
4.128	3.0629E-04	12.080	-7.8308E-04	13.280	1.1068E-03
4.135	1.4117E-04	12.100	-4.0789E-04	13.300	1.3109E-03
4.142	-1.2798E-06	12.120	-5.8763E-04	13.320	-1.0423E-03
4.149	3.1982E-05	12.140	-3.5761E-04	13.340	1.0096E-03

4.156	8.5938E-05	12.160	-9.8685E-04	13.360	9.3922E-04
4.163	6.9751E-05	12.180	-8.8345E-04	13.380	-3.0155E-03
4.170	9.5377E-05	12.200	-1.1272E-03	13.400	-1.0521E-03
4.177	6.1372E-05	12.220	-8.3628E-04	13.420	-2.0113E-03
4.184	1.7407E-05	12.240	-7.4991E-04	13.440	-4.9590E-03
4.191	6.2281E-05	12.260	-8.5222E-04	13.460	-1.8866E-03
4.198	5.8117E-05	12.280	-8.6444E-04	13.480	2.0419E-03
4.205	2.3845E-05	12.300	-7.8923E-04	13.500	8.1562E-04
4.212	4.8791E-04	12.320	-1.1551E-03	13.520	5.8922E-04
4.219	-1.8287E-04	12.340	-8.6298E-04	13.540	4.0422E-03
4.226	2.3553E-04	12.360	-7.9067E-04	13.560	3.8654E-04
4.233	1.0004E-03	12.380	-1.2841E-03	13.580	1.4531E-03
4.240	4.9754E-04	12.400	-1.3980E-03	13.600	5.1084E-04
4.247	5.0812E-04	12.420	-5.2309E-04	13.620	3.8194E-03
4.254	3.8839E-04	12.440	7.0705E-04	13.640	6.4042E-03
4.261	-2.4124E-05	12.460	-1.2969E-03	13.660	1.3007E-03
4.268	6.3954E-04	12.480	-1.1000E-03	13.680	3.3742E-03
4.275	8.4231E-04	12.500	-1.1896E-03	13.700	5.1996E-03
4.282	5.1458E-05	12.520	1.0108E-05	13.720	3.0482E-03
4.289	-7.4100E-05	12.540	1.9474E-03	13.740	3.8239E-04
4.296	1.3217E-04	12.560	-3.9400E-04	13.760	6.1277E-05
4.303	-6.0247E-05	12.580	3.0787E-03	13.780	-1.1969E-03
4.310	4.5193E-04	12.600	2.2264E-03	13.800	-3.8475E-03
4.317	7.5920E-05	12.620	-2.9207E-05	13.820	4.8614E-03
4.324	3.4108E-04	12.640	-3.8597E-04	13.840	-3.2408E-03
4.331	8.7045E-05	12.660	-1.1220E-03	13.860	-8.7508E-04
4.338	1.0477E-04	12.680	-6.2125E-04	13.880	6.5528E-03
4.345	4.4552E-07	12.700	-1.1212E-03	13.900	-9.4813E-05
4.352	-3.2384E-05	12.720	-8.2469E-04	13.920	3.9176E-03
4.359	6.2439E-05	12.740	-6.9329E-04	13.940	-1.6755E-03
4.366	3.2560E-07	12.760	-7.1305E-04	13.960	-3.2505E-03
4.373	4.6320E-05	12.780	-1.0039E-03	13.980	-2.4497E-03
4.380	-1.0052E-05	12.800	-8.1531E-04	14.000	1.9097E-03
4.387	2.4575E-06				
4.394	-3.2284E-05				
4.401	-4.0997E-05				
4.408	-5.3227E-05				
4.415	-6.4098E-05				
4.422	-1.6948E-04				
4.429	3.8139E-05				
4.436	9.8060E-06				
4.443	2.4418E-05				
4.450	6.8658E-05				

4.457	2.3386E-05				
4.464	7.4846E-06				
4.471	-1.6875E-04				
4.478	-1.3578E-05				
4.485	-2.3604E-05				
4.492	-4.8950E-05				
4.499	1.4251E-04				

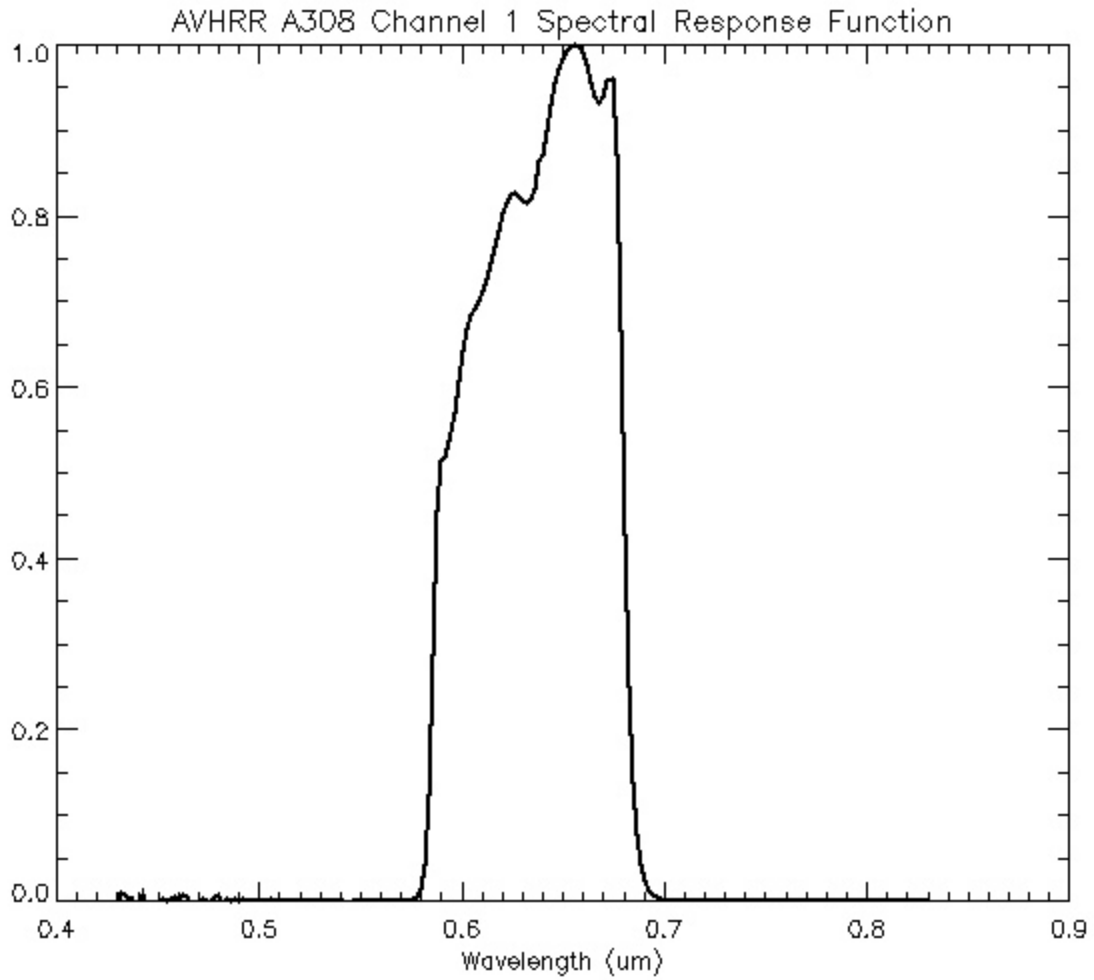

Figure D.6-1. Spectral Response Curve for NOAA-19 Channel 1.

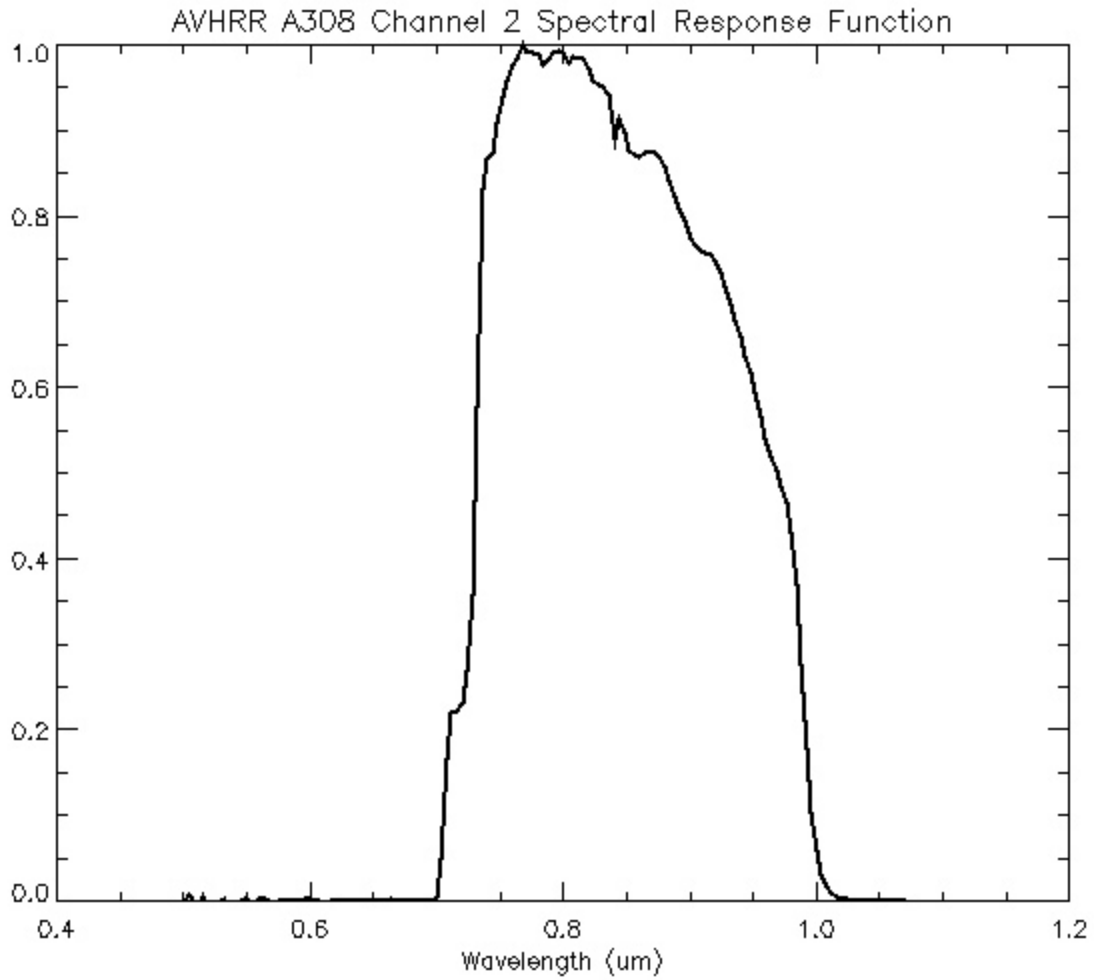

Figure D.6-2. Spectral Response Curve for NOAA-19 Channel 2.

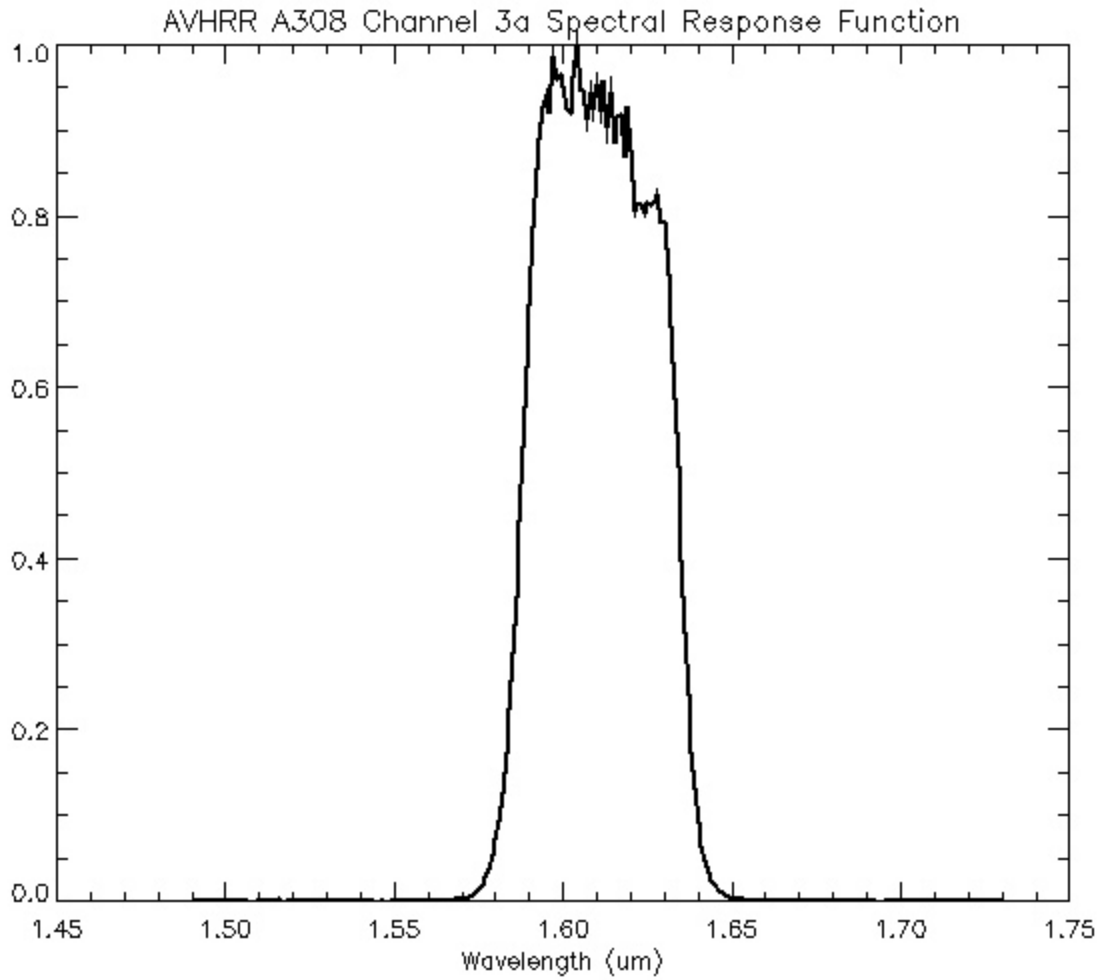

Figure D.6-3. Spectral Response Curve for NOAA-19 Channel 3A.

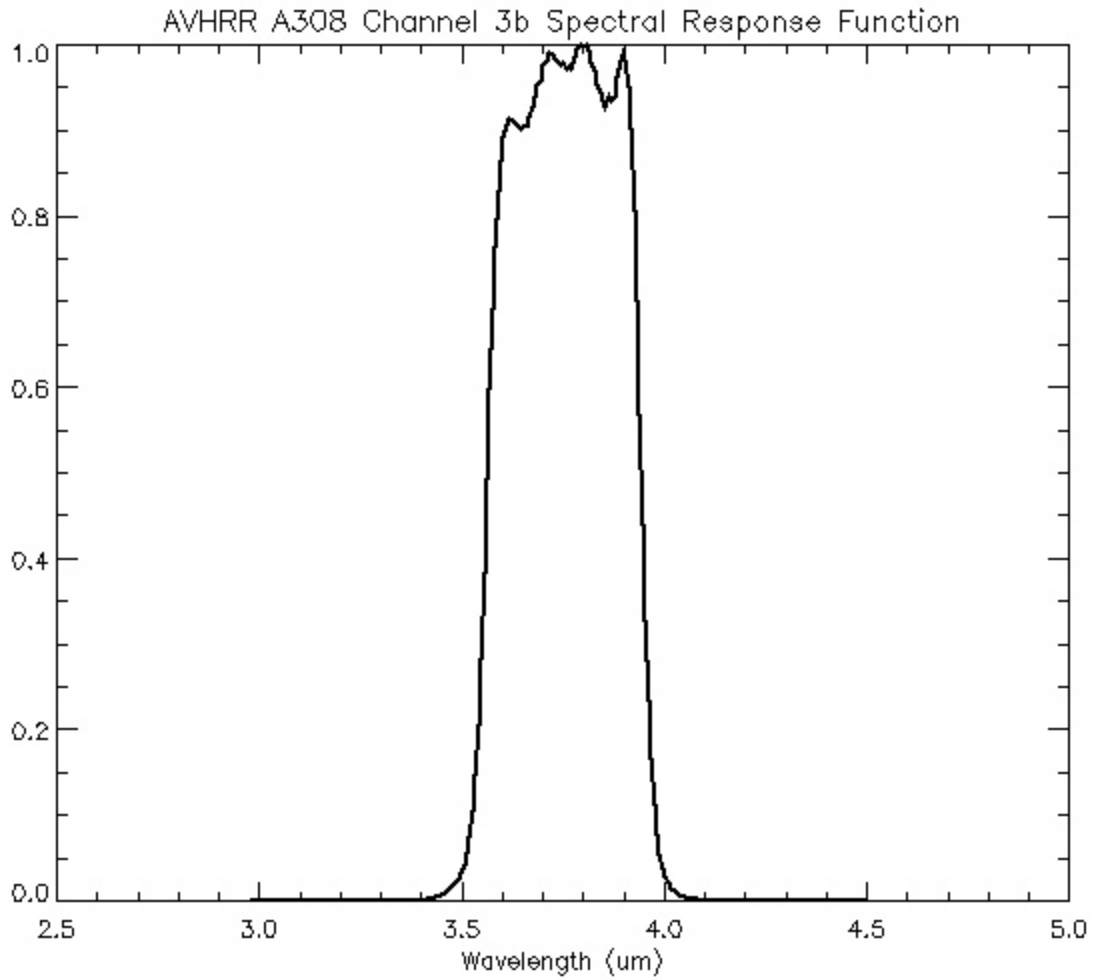

Figure D.6-4. Spectral Response Curve for NOAA-19 Channel 3B.

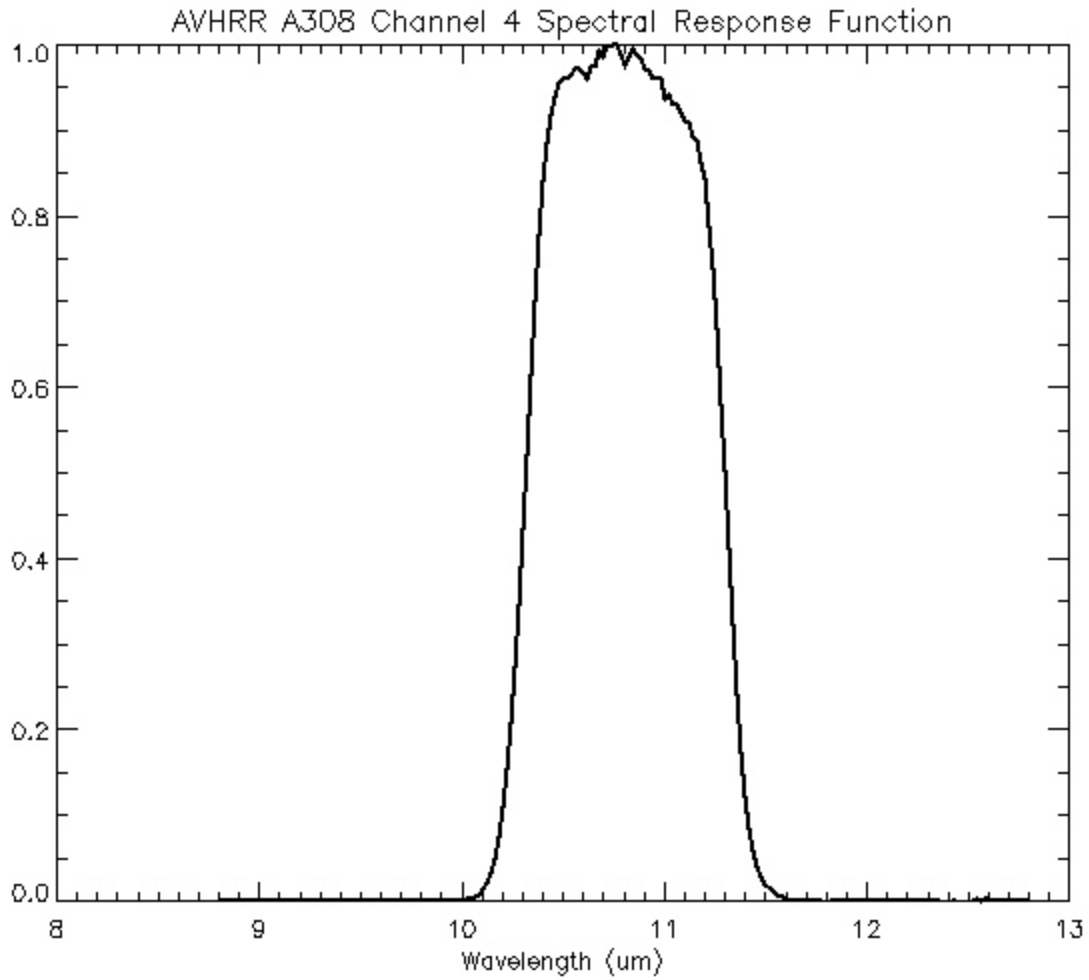

Figure D.6-5. Spectral Response Curve for NOAA-19 Channel 4.

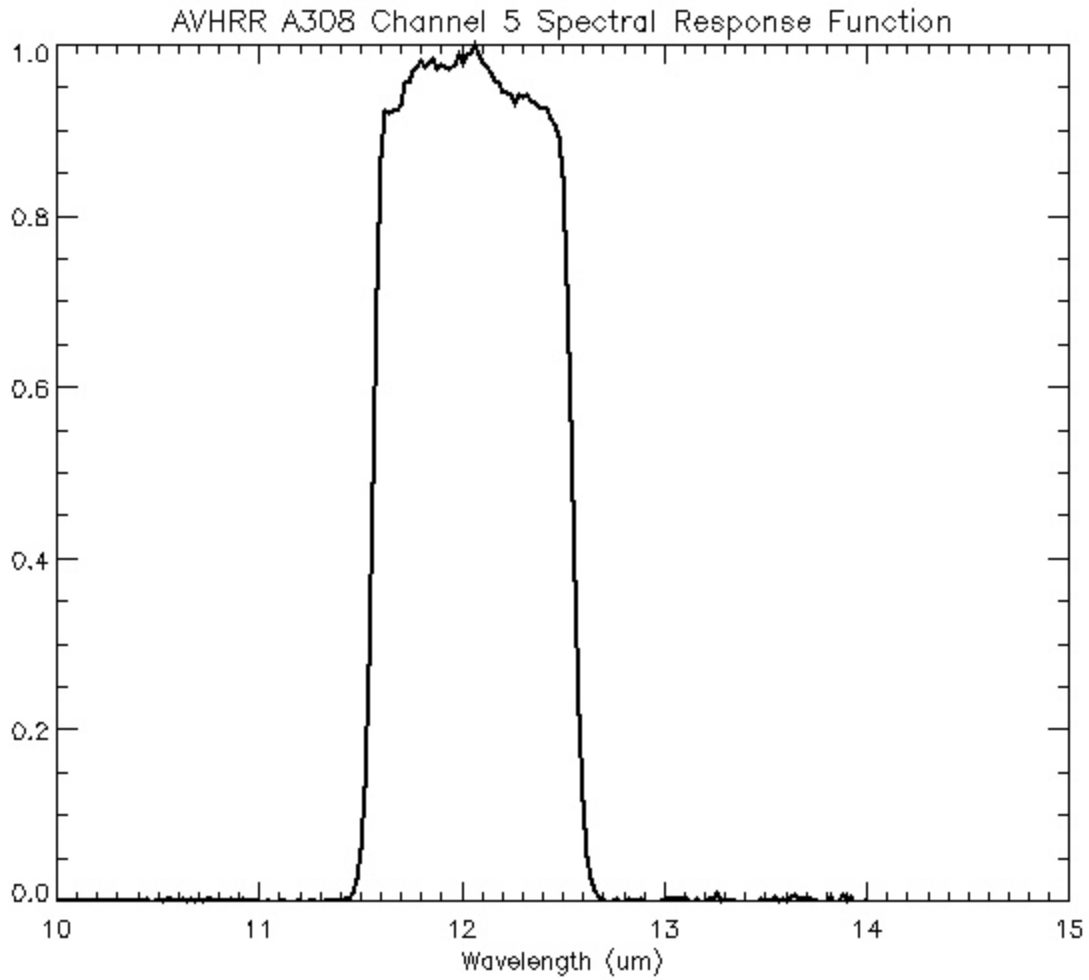

Figure D.6-6. Spectral Response Curve for NOAA-19 Channel 5.

HIRS:

Table D.6-10 contains the NOAA-P HIRS/H308 central wave numbers, half power bandwidth and band correction coefficients for the thermal channels.

Channel #	ν_C (cm⁻¹)	Half power bandwidth (cm⁻¹)	b	c
1	669.33	3.73	0.001311	0.99999
2	680.31	10.18	0.007803	0.99996
3	688.85	14.48	0.018599	0.99991
4	702.65	14.64	0.018578	0.99992
5	715.80	13.96	0.018657	0.99992
6	733.39	17.05	0.019877	0.99991
7	749.12	17.36	0.020736	0.99991
8	899.46	34.63	0.065019	0.99977
9	1028.14	22.55	0.038021	0.99988
10	802.32	15.10	0.016169	0.99994
11	1362.20	39.29	0.075651	0.99981
12	1531.04	51.52	0.104860	0.99997
13	2185.02	20.47	0.016756	0.99997
14	2213.95	21.55	0.017841	0.99997
15	2232.65	21.03	0.016756	0.99997
16	2246.86	21.66	0.017311	0.99997
17	2420.81	30.96	0.032879	0.99995
18	2518.41	32.23	0.045757	0.99993
19	2661.92	101.52	0.276520	0.99962

Table D.6-11 contains the Internal Warm Temperature (IWT) PRT count to temperature coefficients for the NOAA-19 HIRS/H308 instrument.

PRT	A	B	C	D	E	F
1	301.3430	6.559203 E-03	8.890766 E-08	3.698309 E-11	1.035249 E-15	5.511736 E-19
2	301.3513	6.57007 E-03	8.810926 E-08	3.661233 E-11	1.102671 E-15	5.730959 E-19
3	301.3393	6.568216 E-03	8.870932 E-08	3.686241 E-11	1.072081 E-15	5.644733 E-19
4	301.4060	6.565761 E-03	8.805033 E-08	3.693582 E-11	1.126270 E-15	5.590464 E-19
5	301.3661	6.555488 E-03	8.867036 E-08	3.673157 E-11	1.104859 E-15	5.673649 E-19

This information is based on the data in HIRS/4 H308 Alignment/Calibration Handbook, Revision E,

Table D.6-12 contains the primary, secondary and tertiary telescope temperature coefficients for the NOAA-19 HIRS/H308 instrument.

	A	B	C	D	E	F
Primary	260.1752	1.776047 E-02	-3.942533 E-06	1.450393 E-09	-2.857401 E-13	2.971761 E-17
Secondary	260.1312	1.770731 E-02	-3.892618 E-06	1.440120 E-09	-2.872664 E-13	3.019747 E-017
Tertiary	260.1109	1.759282 E-02	1.303540 E-06	-2.473824 E-09	-2.473842 E-13	2.604968 E-17

This information is based on the data in HIRS/4 H308 Alignment/Calibration Handbook, Revision E, May 2003.

Table D.6-13 contains the actual filter functions for NOAA-19 HIRS/H308. The same information can be downloaded as an ASCII file or viewed as a graphic file from the following website: <http://www.orbit.nesdis.noaa.gov/smcd/spb/calibration/hirs/srf/hirssrf.html>.

Channel 1				
Wavenumber	HIRS Filter Transmittance	Optical Element Transmittance	Product of the HIRS Filter and Optical Element Transmittances	Normalized Value of Column 4
0.66350E+03	0.00000E+00	0.17659E+00	0.00000E+00	0.00000E+00
0.66360E+03	0.20000E-04	0.17694E+00	0.35387E-05	0.46798E-04
0.66370E+03	0.78000E-04	0.17728E+00	0.13828E-04	0.18287E-03
0.66380E+03	0.14600E-03	0.17763E+00	0.25934E-04	0.34296E-03
0.66390E+03	0.27500E-03	0.17798E+00	0.48944E-04	0.64725E-03
0.66400E+03	0.44800E-03	0.17833E+00	0.79890E-04	0.10565E-02
0.66410E+03	0.64300E-03	0.17868E+00	0.11489E-03	0.15193E-02
0.66420E+03	0.90600E-03	0.17903E+00	0.16220E-03	0.21450E-02
0.66430E+03	0.12060E-02	0.17938E+00	0.21633E-03	0.28609E-02
0.66440E+03	0.15330E-02	0.17973E+00	0.27553E-03	0.36437E-02
0.66450E+03	0.18950E-02	0.18009E+00	0.34126E-03	0.45130E-02
0.66460E+03	0.22810E-02	0.18044E+00	0.41158E-03	0.54429E-02
0.66470E+03	0.27180E-02	0.18079E+00	0.49139E-03	0.64984E-02
0.66480E+03	0.31960E-02	0.18115E+00	0.57894E-03	0.76561E-02
0.66490E+03	0.37080E-02	0.18150E+00	0.67299E-03	0.88999E-02

0.66500E+03	0.42280E-02	0.18185E+00	0.76886E-03	0.10168E-01
0.66510E+03	0.47630E-02	0.18220E+00	0.86782E-03	0.11476E-01
0.66520E+03	0.53030E-02	0.18255E+00	0.96808E-03	0.12802E-01
0.66530E+03	0.58500E-02	0.18291E+00	0.10700E-02	0.14150E-01
0.66540E+03	0.63990E-02	0.18326E+00	0.11727E-02	0.15508E-01
0.66550E+03	0.70410E-02	0.18359E+00	0.12927E-02	0.17095E-01
0.66560E+03	0.80650E-02	0.18394E+00	0.14835E-02	0.19618E-01
0.66570E+03	0.95880E-02	0.18428E+00	0.17669E-02	0.23366E-01
0.66580E+03	0.11734E-01	0.18463E+00	0.21664E-02	0.28650E-01
0.66590E+03	0.14633E-01	0.18497E+00	0.27067E-02	0.35795E-01
0.66600E+03	0.18415E-01	0.18532E+00	0.34127E-02	0.45131E-01
0.66610E+03	0.23205E-01	0.18570E+00	0.43091E-02	0.56986E-01
0.66620E+03	0.29117E-01	0.18608E+00	0.54180E-02	0.71650E-01
0.66630E+03	0.36245E-01	0.18646E+00	0.67582E-02	0.89373E-01
0.66640E+03	0.44664E-01	0.18684E+00	0.83450E-02	0.11036E+00
0.66650E+03	0.54417E-01	0.18722E+00	0.10188E-01	0.13473E+00
0.66660E+03	0.65515E-01	0.18761E+00	0.12291E-01	0.16254E+00
0.66670E+03	0.77934E-01	0.18799E+00	0.14651E-01	0.19375E+00
0.66680E+03	0.91612E-01	0.18837E+00	0.17257E-01	0.22822E+00
0.66690E+03	0.10645E+00	0.18876E+00	0.20093E-01	0.26572E+00
0.66700E+03	0.12231E+00	0.18915E+00	0.23134E-01	0.30594E+00
0.66710E+03	0.13903E+00	0.18953E+00	0.26351E-01	0.34847E+00
0.66720E+03	0.15642E+00	0.18992E+00	0.29707E-01	0.39285E+00
0.66730E+03	0.17426E+00	0.19031E+00	0.33162E-01	0.43855E+00
0.66740E+03	0.19233E+00	0.19069E+00	0.36676E-01	0.48502E+00
0.66750E+03	0.21041E+00	0.19109E+00	0.40207E-01	0.53171E+00
0.66760E+03	0.22827E+00	0.19148E+00	0.43709E-01	0.57802E+00
0.66770E+03	0.24569E+00	0.19188E+00	0.47142E-01	0.62343E+00
0.66780E+03	0.26248E+00	0.19227E+00	0.50469E-01	0.66742E+00
0.66790E+03	0.27848E+00	0.19267E+00	0.53655E-01	0.70955E+00
0.66800E+03	0.29353E+00	0.19307E+00	0.56671E-01	0.74944E+00
0.66810E+03	0.30753E+00	0.19347E+00	0.59498E-01	0.78682E+00
0.66820E+03	0.32037E+00	0.19388E+00	0.62113E-01	0.82141E+00
0.66830E+03	0.33202E+00	0.19428E+00	0.64506E-01	0.85305E+00
0.66840E+03	0.34243E+00	0.19469E+00	0.66668E-01	0.88165E+00
0.66850E+03	0.35160E+00	0.19510E+00	0.68596E-01	0.90714E+00
0.66860E+03	0.35952E+00	0.19551E+00	0.70288E-01	0.92951E+00
0.66870E+03	0.36620E+00	0.19592E+00	0.71745E-01	0.94878E+00
0.66880E+03	0.37167E+00	0.19633E+00	0.72969E-01	0.96497E+00
0.66890E+03	0.37593E+00	0.19674E+00	0.73962E-01	0.97810E+00
0.66900E+03	0.37901E+00	0.19716E+00	0.74725E-01	0.98819E+00
0.66910E+03	0.38091E+00	0.19757E+00	0.75257E-01	0.99522E+00
0.66920E+03	0.38161E+00	0.19799E+00	0.75556E-01	0.99918E+00

0.66930E+03	0.38112E+00	0.19841E+00	0.75618E-01	0.10000E+01
0.66940E+03	0.37941E+00	0.19883E+00	0.75439E-01	0.99764E+00
0.66950E+03	0.37645E+00	0.19926E+00	0.75013E-01	0.99200E+00
0.66960E+03	0.37224E+00	0.19969E+00	0.74332E-01	0.98300E+00
0.66970E+03	0.36674E+00	0.20012E+00	0.73392E-01	0.97056E+00
0.66980E+03	0.35994E+00	0.20055E+00	0.72188E-01	0.95465E+00
0.66990E+03	0.35187E+00	0.20099E+00	0.70722E-01	0.93525E+00
0.67000E+03	0.34253E+00	0.20142E+00	0.68994E-01	0.91240E+00
0.67010E+03	0.33198E+00	0.20186E+00	0.67012E-01	0.88619E+00
0.67020E+03	0.32028E+00	0.20229E+00	0.64790E-01	0.85680E+00
0.67030E+03	0.30753E+00	0.20272E+00	0.62343E-01	0.82444E+00
0.67040E+03	0.29383E+00	0.20316E+00	0.59694E-01	0.78941E+00
0.67050E+03	0.27932E+00	0.20360E+00	0.56869E-01	0.75206E+00
0.67060E+03	0.26416E+00	0.20403E+00	0.53897E-01	0.71276E+00
0.67070E+03	0.24851E+00	0.20447E+00	0.50812E-01	0.67196E+00
0.67080E+03	0.23253E+00	0.20490E+00	0.47647E-01	0.63010E+00
0.67090E+03	0.21640E+00	0.20534E+00	0.44436E-01	0.58764E+00
0.67100E+03	0.20029E+00	0.20578E+00	0.41215E-01	0.54505E+00
0.67110E+03	0.18435E+00	0.20622E+00	0.38017E-01	0.50275E+00
0.67120E+03	0.16874E+00	0.20666E+00	0.34871E-01	0.46115E+00
0.67130E+03	0.15358E+00	0.20710E+00	0.31807E-01	0.42062E+00
0.67140E+03	0.13899E+00	0.20754E+00	0.28847E-01	0.38148E+00
0.67150E+03	0.12507E+00	0.20799E+00	0.26013E-01	0.34400E+00
0.67160E+03	0.11188E+00	0.20843E+00	0.23320E-01	0.30840E+00
0.67170E+03	0.99497E-01	0.20888E+00	0.20783E-01	0.27484E+00
0.67180E+03	0.87950E-01	0.20932E+00	0.18410E-01	0.24346E+00
0.67190E+03	0.77267E-01	0.20977E+00	0.16208E-01	0.21434E+00
0.67200E+03	0.67462E-01	0.21022E+00	0.14182E-01	0.18754E+00
0.67210E+03	0.58534E-01	0.21068E+00	0.12332E-01	0.16308E+00
0.67220E+03	0.50476E-01	0.21113E+00	0.10657E-01	0.14093E+00
0.67230E+03	0.43271E-01	0.21159E+00	0.91558E-02	0.12108E+00
0.67240E+03	0.36891E-01	0.21205E+00	0.78228E-02	0.10345E+00
0.67250E+03	0.31307E-01	0.21251E+00	0.66531E-02	0.87983E-01
0.67260E+03	0.26477E-01	0.21297E+00	0.56388E-02	0.74569E-01
0.67270E+03	0.22357E-01	0.21343E+00	0.47716E-02	0.63102E-01
0.67280E+03	0.18893E-01	0.21389E+00	0.40410E-02	0.53439E-01
0.67290E+03	0.16026E-01	0.21435E+00	0.34351E-02	0.45427E-01
0.67300E+03	0.13692E-01	0.21481E+00	0.29411E-02	0.38894E-01
0.67310E+03	0.11823E-01	0.21527E+00	0.25451E-02	0.33657E-01
0.67320E+03	0.10346E-01	0.21572E+00	0.22319E-02	0.29515E-01
0.67330E+03	0.91900E-02	0.21617E+00	0.19866E-02	0.26271E-01
0.67340E+03	0.82840E-02	0.21661E+00	0.17944E-02	0.23729E-01
0.67350E+03	0.74680E-02	0.21705E+00	0.16209E-02	0.21436E-01

0.67360E+03	0.66740E-02	0.21749E+00	0.14515E-02	0.19196E-01
0.67370E+03	0.59520E-02	0.21793E+00	0.12971E-02	0.17154E-01
0.67380E+03	0.52310E-02	0.21838E+00	0.11423E-02	0.15106E-01
0.67390E+03	0.46280E-02	0.21882E+00	0.10127E-02	0.13392E-01
0.67400E+03	0.40320E-02	0.21926E+00	0.88407E-03	0.11691E-01
0.67410E+03	0.34640E-02	0.21971E+00	0.76108E-03	0.10065E-01
0.67420E+03	0.29440E-02	0.22016E+00	0.64816E-03	0.85715E-02
0.67430E+03	0.24620E-02	0.22061E+00	0.54315E-03	0.71828E-02
0.67440E+03	0.19930E-02	0.22106E+00	0.44058E-03	0.58264E-02
0.67450E+03	0.15240E-02	0.22152E+00	0.33759E-03	0.44644E-02
0.67460E+03	0.10560E-02	0.22197E+00	0.23440E-03	0.30998E-02
0.67470E+03	0.59700E-03	0.22242E+00	0.13278E-03	0.17560E-02
0.67480E+03	0.15700E-03	0.22287E+00	0.34991E-04	0.46274E-03
0.67490E+03	0.00000E+00	0.22333E+00	0.00000E+04	0.00000E+03
Channel 2				
Wavenumber	HIRS Filter Transmittance	Optical Element Transmittance	Product of the HIRS Filter and Optical Element Transmittances	Normalized Value of Column 4
0.66890E+03	0.00000E+00	0.19674E+00	0.00000E+00	0.00000E+00
0.66900E+03	0.34000E-04	0.19716E+00	0.67033E-05	0.51343E-04
0.66910E+03	0.71900E-04	0.19757E+00	0.14205E-04	0.10880E-03
0.66920E+03	0.10800E-03	0.19799E+00	0.21383E-04	0.16378E-03
0.66930E+03	0.14700E-03	0.19841E+00	0.29166E-04	0.22339E-03
0.66940E+03	0.19700E-03	0.19883E+00	0.39170E-04	0.30002E-03
0.66950E+03	0.26100E-03	0.19926E+00	0.52007E-04	0.39834E-03
0.66960E+03	0.34600E-03	0.19969E+00	0.69093E-04	0.52920E-03
0.66970E+03	0.45800E-03	0.20012E+00	0.91656E-04	0.70202E-03
0.66980E+03	0.60200E-03	0.20055E+00	0.12073E-03	0.92473E-03
0.66990E+03	0.78500E-03	0.20099E+00	0.15778E-03	0.12084E-02
0.67000E+03	0.10100E-02	0.20142E+00	0.20344E-03	0.15582E-02
0.67010E+03	0.12900E-02	0.20186E+00	0.26039E-03	0.19944E-02
0.67020E+03	0.16200E-02	0.20229E+00	0.32771E-03	0.25100E-02
0.67030E+03	0.20100E-02	0.20272E+00	0.40748E-03	0.31210E-02
0.67040E+03	0.24700E-02	0.20316E+00	0.50180E-03	0.38434E-02
0.67050E+03	0.30000E-02	0.20360E+00	0.61079E-03	0.46782E-02
0.67060E+03	0.36100E-02	0.20403E+00	0.73655E-03	0.56414E-02
0.67070E+03	0.43100E-02	0.20447E+00	0.88126E-03	0.67498E-02
0.67080E+03	0.50900E-02	0.20490E+00	0.10430E-02	0.79883E-02
0.67090E+03	0.59700E-02	0.20534E+00	0.12259E-02	0.93894E-02
0.67100E+03	0.69600E-02	0.20578E+00	0.14322E-02	0.10970E-01
0.67110E+03	0.80500E-02	0.20622E+00	0.16601E-02	0.12715E-01
0.67120E+03	0.92500E-02	0.20666E+00	0.19116E-02	0.14641E-01

0.67130E+03	0.10600E-01	0.20710E+00	0.21953E-02	0.16814E-01
0.67140E+03	0.12000E-01	0.20754E+00	0.24905E-02	0.19076E-01
0.67150E+03	0.13600E-01	0.20799E+00	0.28286E-02	0.21665E-01
0.67160E+03	0.15300E-01	0.20843E+00	0.31890E-02	0.24425E-01
0.67170E+03	0.17200E-01	0.20888E+00	0.35927E-02	0.27517E-01
0.67180E+03	0.19200E-01	0.20932E+00	0.40190E-02	0.30783E-01
0.67190E+03	0.21300E-01	0.20977E+00	0.44681E-02	0.34222E-01
0.67200E+03	0.23615E-01	0.21022E+00	0.49643E-02	0.38023E-01
0.67210E+03	0.26144E-01	0.21068E+00	0.55079E-02	0.42186E-01
0.67220E+03	0.29093E-01	0.21113E+00	0.61425E-02	0.47047E-01
0.67230E+03	0.32504E-01	0.21159E+00	0.68776E-02	0.52677E-01
0.67240E+03	0.36415E-01	0.21205E+00	0.77219E-02	0.59144E-01
0.67250E+03	0.40861E-01	0.21251E+00	0.86834E-02	0.66508E-01
0.67260E+03	0.45873E-01	0.21297E+00	0.97695E-02	0.74827E-01
0.67270E+03	0.51478E-01	0.21343E+00	0.10987E-01	0.84151E-01
0.67280E+03	0.57696E-01	0.21389E+00	0.12340E-01	0.94519E-01
0.67290E+03	0.64543E-01	0.21435E+00	0.13835E-01	0.10596E+00
0.67300E+03	0.72027E-01	0.21481E+00	0.15472E-01	0.11850E+00
0.67310E+03	0.80151E-01	0.21527E+00	0.17254E-01	0.13215E+00
0.67320E+03	0.88907E-01	0.21572E+00	0.19179E-01	0.14690E+00
0.67330E+03	0.98283E-01	0.21617E+00	0.21245E-01	0.16272E+00
0.67340E+03	0.10826E+00	0.21661E+00	0.23449E-01	0.17960E+00
0.67350E+03	0.11880E+00	0.21705E+00	0.25784E-01	0.19749E+00
0.67360E+03	0.12986E+00	0.21749E+00	0.28244E-01	0.21633E+00
0.67370E+03	0.14141E+00	0.21793E+00	0.30819E-01	0.23605E+00
0.67380E+03	0.15339E+00	0.21838E+00	0.33497E-01	0.25656E+00
0.67390E+03	0.16574E+00	0.21882E+00	0.36266E-01	0.27777E+00
0.67400E+03	0.17838E+00	0.21926E+00	0.39111E-01	0.29956E+00
0.67410E+03	0.19124E+00	0.21971E+00	0.42017E-01	0.32182E+00
0.67420E+03	0.20424E+00	0.22016E+00	0.44965E-01	0.34440E+00
0.67430E+03	0.21729E+00	0.22061E+00	0.47938E-01	0.36717E+00
0.67440E+03	0.23031E+00	0.22106E+00	0.50914E-01	0.38996E+00
0.67450E+03	0.24321E+00	0.22152E+00	0.53875E-01	0.41264E+00
0.67460E+03	0.25589E+00	0.22197E+00	0.56800E-01	0.43505E+00
0.67470E+03	0.26827E+00	0.22242E+00	0.59668E-01	0.45701E+00
0.67480E+03	0.28025E+00	0.22287E+00	0.62460E-01	0.47840E+00
0.67490E+03	0.29175E+00	0.22333E+00	0.65156E-01	0.49905E+00
0.67500E+03	0.30270E+00	0.22378E+00	0.67738E-01	0.51883E+00
0.67510E+03	0.31302E+00	0.22424E+00	0.70190E-01	0.53760E+00
0.67520E+03	0.32265E+00	0.22466E+00	0.72485E-01	0.55518E+00
0.67530E+03	0.33152E+00	0.22507E+00	0.74615E-01	0.57150E+00
0.67540E+03	0.33962E+00	0.22548E+00	0.76575E-01	0.58651E+00
0.67550E+03	0.34689E+00	0.22589E+00	0.78357E-01	0.60016E+00

0.67560E+03	0.35331E+00	0.22630E+00	0.79954E-01	0.61239E+00
0.67570E+03	0.35889E+00	0.22671E+00	0.81363E-01	0.62318E+00
0.67580E+03	0.36363E+00	0.22712E+00	0.82586E-01	0.63255E+00
0.67590E+03	0.36753E+00	0.22753E+00	0.83624E-01	0.64050E+00
0.67600E+03	0.37064E+00	0.22794E+00	0.84484E-01	0.64708E+00
0.67610E+03	0.37299E+00	0.22836E+00	0.85174E-01	0.65237E+00
0.67620E+03	0.37463E+00	0.22877E+00	0.85705E-01	0.65643E+00
0.67630E+03	0.37561E+00	0.22919E+00	0.86087E-01	0.65937E+00
0.67640E+03	0.37602E+00	0.22961E+00	0.86337E-01	0.66128E+00
0.67650E+03	0.37591E+00	0.23003E+00	0.86470E-01	0.66229E+00
0.67660E+03	0.37537E+00	0.23044E+00	0.86502E-01	0.66254E+00
0.67670E+03	0.37447E+00	0.23086E+00	0.86451E-01	0.66216E+00
0.67680E+03	0.37330E+00	0.23128E+00	0.86337E-01	0.66128E+00
0.67690E+03	0.37193E+00	0.23170E+00	0.86176E-01	0.66005E+00
0.67700E+03	0.37044E+00	0.23212E+00	0.85986E-01	0.65859E+00
0.67710E+03	0.36891E+00	0.23252E+00	0.85781E-01	0.65702E+00
0.67720E+03	0.36741E+00	0.23291E+00	0.85574E-01	0.65543E+00
0.67730E+03	0.36599E+00	0.23330E+00	0.85386E-01	0.65399E+00
0.67740E+03	0.36472E+00	0.23369E+00	0.85231E-01	0.65281E+00
0.67750E+03	0.36365E+00	0.23407E+00	0.85121E-01	0.65196E+00
0.67760E+03	0.36282E+00	0.23446E+00	0.85067E-01	0.65155E+00
0.67770E+03	0.36227E+00	0.23485E+00	0.85077E-01	0.65162E+00
0.67780E+03	0.36202E+00	0.23523E+00	0.85157E-01	0.65224E+00
0.67790E+03	0.36209E+00	0.23562E+00	0.85315E-01	0.65345E+00
0.67800E+03	0.36252E+00	0.23600E+00	0.85554E-01	0.65528E+00
0.67810E+03	0.36329E+00	0.23638E+00	0.85876E-01	0.65775E+00
0.67820E+03	0.36443E+00	0.23676E+00	0.86284E-01	0.66087E+00
0.67830E+03	0.36593E+00	0.23715E+00	0.86778E-01	0.66466E+00
0.67840E+03	0.36778E+00	0.23753E+00	0.87359E-01	0.66911E+00
0.67850E+03	0.36999E+00	0.23791E+00	0.88026E-01	0.67421E+00
0.67860E+03	0.37255E+00	0.23829E+00	0.88777E-01	0.67997E+00
0.67870E+03	0.37545E+00	0.23868E+00	0.89612E-01	0.68636E+00
0.67880E+03	0.37868E+00	0.23906E+00	0.90528E-01	0.69338E+00
0.67890E+03	0.38223E+00	0.23944E+00	0.91523E-01	0.70100E+00
0.67900E+03	0.38609E+00	0.23983E+00	0.92596E-01	0.70921E+00
0.67910E+03	0.39025E+00	0.24021E+00	0.93742E-01	0.71800E+00
0.67920E+03	0.39469E+00	0.24059E+00	0.94961E-01	0.72733E+00
0.67930E+03	0.39941E+00	0.24098E+00	0.96249E-01	0.73719E+00
0.67940E+03	0.40437E+00	0.24137E+00	0.97602E-01	0.74756E+00
0.67950E+03	0.40958E+00	0.24175E+00	0.99016E-01	0.75839E+00
0.67960E+03	0.41500E+00	0.24214E+00	0.10049E+00	0.76966E+00
0.67970E+03	0.42062E+00	0.24252E+00	0.10201E+00	0.78132E+00
0.67980E+03	0.42641E+00	0.24291E+00	0.10358E+00	0.79334E+00

0.67990E+03	0.43234E+00	0.24330E+00	0.10519E+00	0.80566E+00
0.68000E+03	0.43838E+00	0.24369E+00	0.10683E+00	0.81822E+00
0.68010E+03	0.44450E+00	0.24406E+00	0.10848E+00	0.83091E+00
0.68020E+03	0.45066E+00	0.24443E+00	0.11016E+00	0.84371E+00
0.68030E+03	0.45681E+00	0.24481E+00	0.11183E+00	0.85655E+00
0.68040E+03	0.46292E+00	0.24519E+00	0.11350E+00	0.86933E+00
0.68050E+03	0.46893E+00	0.24556E+00	0.11515E+00	0.88198E+00
0.68060E+03	0.47481E+00	0.24594E+00	0.11677E+00	0.89440E+00
0.68070E+03	0.48051E+00	0.24631E+00	0.11836E+00	0.90652E+00
0.68080E+03	0.48597E+00	0.24669E+00	0.11989E+00	0.91823E+00
0.68090E+03	0.49116E+00	0.24707E+00	0.12135E+00	0.92945E+00
0.68100E+03	0.49603E+00	0.24744E+00	0.12274E+00	0.94008E+00
0.68110E+03	0.50054E+00	0.24781E+00	0.12404E+00	0.95005E+00
0.68120E+03	0.50464E+00	0.24818E+00	0.12524E+00	0.95928E+00
0.68130E+03	0.50832E+00	0.24855E+00	0.12634E+00	0.96770E+00
0.68140E+03	0.51152E+00	0.24893E+00	0.12733E+00	0.97526E+00
0.68150E+03	0.51423E+00	0.24930E+00	0.12820E+00	0.98189E+00
0.68160E+03	0.51642E+00	0.24967E+00	0.12894E+00	0.98755E+00
0.68170E+03	0.51808E+00	0.25004E+00	0.12954E+00	0.99220E+00
0.68180E+03	0.51918E+00	0.25041E+00	0.13001E+00	0.99579E+00
0.68190E+03	0.51972E+00	0.25079E+00	0.13034E+00	0.99831E+00
0.68200E+03	0.51969E+00	0.25116E+00	0.13053E+00	0.99973E+00
0.68210E+03	0.51907E+00	0.25153E+00	0.13056E+00	0.10000E+01
0.68220E+03	0.51788E+00	0.25189E+00	0.13045E+00	0.99915E+00
0.68230E+03	0.51609E+00	0.25226E+00	0.13019E+00	0.99715E+00
0.68240E+03	0.51372E+00	0.25263E+00	0.12978E+00	0.99401E+00
0.68250E+03	0.51076E+00	0.25299E+00	0.12922E+00	0.98972E+00
0.68260E+03	0.50721E+00	0.25336E+00	0.12851E+00	0.98427E+00
0.68270E+03	0.50307E+00	0.25373E+00	0.12764E+00	0.97765E+00
0.68280E+03	0.49834E+00	0.25410E+00	0.12663E+00	0.96987E+00
0.68290E+03	0.49303E+00	0.25446E+00	0.12545E+00	0.96089E+00
0.68300E+03	0.48713E+00	0.25481E+00	0.12413E+00	0.95072E+00
0.68310E+03	0.48064E+00	0.25517E+00	0.12264E+00	0.93936E+00
0.68320E+03	0.47357E+00	0.25552E+00	0.12101E+00	0.92683E+00
0.68330E+03	0.46591E+00	0.25588E+00	0.11922E+00	0.91312E+00
0.68340E+03	0.45768E+00	0.25624E+00	0.11728E+00	0.89824E+00
0.68350E+03	0.44888E+00	0.25659E+00	0.11518E+00	0.88220E+00
0.68360E+03	0.43953E+00	0.25695E+00	0.11294E+00	0.86502E+00
0.68370E+03	0.42963E+00	0.25731E+00	0.11055E+00	0.84671E+00
0.68380E+03	0.41921E+00	0.25766E+00	0.10802E+00	0.82732E+00
0.68390E+03	0.40828E+00	0.25802E+00	0.10535E+00	0.80688E+00
0.68400E+03	0.39688E+00	0.25838E+00	0.10255E+00	0.78543E+00
0.68410E+03	0.38504E+00	0.25873E+00	0.99620E-01	0.76302E+00

0.68420E+03	0.37278E+00	0.25908E+00	0.96580E-01	0.73973E+00
0.68430E+03	0.36016E+00	0.25943E+00	0.93437E-01	0.71566E+00
0.68440E+03	0.34722E+00	0.25978E+00	0.90201E-01	0.69087E+00
0.68450E+03	0.33400E+00	0.26013E+00	0.86885E-01	0.66547E+00
0.68460E+03	0.32057E+00	0.26049E+00	0.83503E-01	0.63957E+00
0.68470E+03	0.30697E+00	0.26084E+00	0.80069E-01	0.61327E+00
0.68480E+03	0.29327E+00	0.26119E+00	0.76597E-01	0.58668E+00
0.68490E+03	0.27952E+00	0.26153E+00	0.73102E-01	0.55991E+00
0.68500E+03	0.26579E+00	0.26187E+00	0.69602E-01	0.53310E+00
0.68510E+03	0.25213E+00	0.26221E+00	0.66112E-01	0.50637E+00
0.68520E+03	0.23862E+00	0.26255E+00	0.62650E-01	0.47985E+00
0.68530E+03	0.22530E+00	0.26288E+00	0.59227E-01	0.45364E+00
0.68540E+03	0.21224E+00	0.26321E+00	0.55863E-01	0.42787E+00
0.68550E+03	0.19948E+00	0.26354E+00	0.52571E-01	0.40265E+00
0.68560E+03	0.18708E+00	0.26387E+00	0.49366E-01	0.37810E+00
0.68570E+03	0.17509E+00	0.26420E+00	0.46259E-01	0.35431E+00
0.68580E+03	0.16355E+00	0.26453E+00	0.43263E-01	0.33136E+00
0.68590E+03	0.15248E+00	0.26486E+00	0.40386E-01	0.30933E+00
0.68600E+03	0.14193E+00	0.26519E+00	0.37639E-01	0.28829E+00
0.68610E+03	0.13192E+00	0.26554E+00	0.35031E-01	0.26831E+00
0.68620E+03	0.12247E+00	0.26589E+00	0.32564E-01	0.24941E+00
0.68630E+03	0.11359E+00	0.26624E+00	0.30242E-01	0.23163E+00
0.68640E+03	0.10528E+00	0.26659E+00	0.28067E-01	0.21497E+00
0.68650E+03	0.97554E-01	0.26694E+00	0.26041E-01	0.19945E+00
0.68660E+03	0.90394E-01	0.26729E+00	0.24161E-01	0.18506E+00
0.68670E+03	0.83789E-01	0.26764E+00	0.22425E-01	0.17176E+00
0.68680E+03	0.77721E-01	0.26798E+00	0.20828E-01	0.15953E+00
0.68690E+03	0.72166E-01	0.26833E+00	0.19364E-01	0.14831E+00
0.68700E+03	0.67094E-01	0.26867E+00	0.18026E-01	0.13807E+00
0.68710E+03	0.62472E-01	0.26901E+00	0.16806E-01	0.12872E+00
0.68720E+03	0.58263E-01	0.26936E+00	0.15694E-01	0.12020E+00
0.68730E+03	0.54426E-01	0.26970E+00	0.14679E-01	0.11243E+00
0.68740E+03	0.50920E-01	0.27005E+00	0.13751E-01	0.10532E+00
0.68750E+03	0.47703E-01	0.27039E+00	0.12898E-01	0.98793E-01
0.68760E+03	0.44731E-01	0.27073E+00	0.12110E-01	0.92756E-01
0.68770E+03	0.41965E-01	0.27108E+00	0.11376E-01	0.87131E-01
0.68780E+03	0.39365E-01	0.27142E+00	0.10685E-01	0.81836E-01
0.68790E+03	0.36415E-01	0.27177E+00	0.98965E-02	0.75800E-01
0.68800E+03	0.32504E-01	0.27211E+00	0.88448E-02	0.67745E-01
0.68810E+03	0.29093E-01	0.27243E+00	0.79259E-02	0.60706E-01
0.68820E+03	0.26144E-01	0.27275E+00	0.71308E-02	0.54617E-01
0.68830E+03	0.23615E-01	0.27307E+00	0.64485E-02	0.49391E-01
0.68840E+03	0.21300E-01	0.27339E+00	0.58232E-02	0.44601E-01

0.68850E+03	0.19200E-01	0.27371E+00	0.52552E-02	0.40251E-01
0.68860E+03	0.17200E-01	0.27403E+00	0.47133E-02	0.36100E-01
0.68870E+03	0.15300E-01	0.27433E+00	0.41973E-02	0.32148E-01
0.68880E+03	0.13600E-01	0.27463E+00	0.37350E-02	0.28607E-01
0.68890E+03	0.12000E-01	0.27493E+00	0.32992E-02	0.25269E-01
0.68900E+03	0.10600E-01	0.27523E+00	0.29174E-02	0.22345E-01
0.68910E+03	0.92500E-02	0.27553E+00	0.25486E-02	0.19521E-01
0.68920E+03	0.80500E-02	0.27583E+00	0.22204E-02	0.17007E-01
0.68930E+03	0.69600E-02	0.27612E+00	0.19218E-02	0.14720E-01
0.68940E+03	0.59700E-02	0.27642E+00	0.16502E-02	0.12640E-01
0.68950E+03	0.50900E-02	0.27672E+00	0.14085E-02	0.10788E-01
0.68960E+03	0.43100E-02	0.27702E+00	0.11939E-02	0.91448E-02
0.68970E+03	0.36100E-02	0.27732E+00	0.10011E-02	0.76678E-02
0.68980E+03	0.30000E-02	0.27761E+00	0.83284E-03	0.63790E-02
0.68990E+03	0.24700E-02	0.27791E+00	0.68644E-03	0.52577E-02
0.69000E+03	0.20100E-02	0.27821E+00	0.55920E-03	0.42831E-02
0.69010E+03	0.16200E-02	0.27847E+00	0.45112E-03	0.34553E-02
0.69020E+03	0.12900E-02	0.27873E+00	0.35956E-03	0.27540E-02
0.69030E+03	0.10100E-02	0.27899E+00	0.28178E-03	0.21582E-02
0.69040E+03	0.78500E-03	0.27925E+00	0.21921E-03	0.16790E-02
0.69050E+03	0.60200E-03	0.27951E+00	0.16827E-03	0.12888E-02
0.69060E+03	0.45800E-03	0.27977E+00	0.12814E-03	0.98143E-03
0.69070E+03	0.34600E-03	0.28003E+00	0.96890E-04	0.74210E-03
0.69080E+03	0.26100E-03	0.28028E+00	0.73154E-04	0.56030E-03
0.69090E+03	0.19700E-03	0.28054E+00	0.55266E-04	0.42330E-03
0.69100E+03	0.14700E-03	0.28079E+00	0.41277E-04	0.31615E-03
0.69110E+03	0.10800E-03	0.28105E+00	0.30353E-04	0.23248E-03
0.69120E+03	0.71900E-04	0.28130E+00	0.20226E-04	0.15491E-03
0.69130E+03	0.34000E-04	0.28155E+00	0.95728E-05	0.73321E-04
0.69140E+03	0.00000E+00	0.28181E+00	0.00000E+00	0.00000E+00
Channel 3				
Wavenumber	HIRS Filter Transmittance	Optical Element Transmittance	Product of the HIRS Filter and Optical Element Transmittances	Normalized Value of Column 4
0.67085E+03	0.00000E+00	0.20512E+00	0.00000E+00	0.00000E+00
0.67090E+03	0.82887E-04	0.20534E+00	0.17020E-04	0.76210E-04
0.67095E+03	0.17499E-03	0.20556E+00	0.35971E-04	0.16106E-03
0.67100E+03	0.26731E-03	0.20578E+00	0.55006E-04	0.24630E-03
0.67105E+03	0.36001E-03	0.20600E+00	0.74161E-04	0.33207E-03
0.67110E+03	0.45368E-03	0.20622E+00	0.93557E-04	0.41891E-03
0.67115E+03	0.54771E-03	0.20644E+00	0.11307E-03	0.50628E-03
0.67120E+03	0.64256E-03	0.20666E+00	0.13279E-03	0.59459E-03

0.67125E+03	0.73823E-03	0.20688E+00	0.15272E-03	0.68384E-03
0.67130E+03	0.83434E-03	0.20710E+00	0.17279E-03	0.77370E-03
0.67135E+03	0.93123E-03	0.20732E+00	0.19306E-03	0.86447E-03
0.67140E+03	0.10285E-02	0.20754E+00	0.21347E-03	0.95583E-03
0.67145E+03	0.11284E-02	0.20776E+00	0.23444E-03	0.10497E-02
0.67150E+03	0.12284E-02	0.20799E+00	0.25549E-03	0.11440E-02
0.67155E+03	0.13299E-02	0.20821E+00	0.27689E-03	0.12398E-02
0.67160E+03	0.14326E-02	0.20843E+00	0.29860E-03	0.13370E-02
0.67165E+03	0.15373E-02	0.20865E+00	0.32077E-03	0.14363E-02
0.67170E+03	0.16462E-02	0.20888E+00	0.34385E-03	0.15396E-02
0.67175E+03	0.17570E-02	0.20910E+00	0.36739E-03	0.16450E-02
0.67180E+03	0.18682E-02	0.20932E+00	0.39107E-03	0.17511E-02
0.67185E+03	0.19799E-02	0.20955E+00	0.41488E-03	0.18577E-02
0.67190E+03	0.20952E-02	0.20977E+00	0.43950E-03	0.19679E-02
0.67195E+03	0.22107E-02	0.20999E+00	0.46423E-03	0.20786E-02
0.67200E+03	0.23290E-02	0.21022E+00	0.48960E-03	0.21922E-02
0.67205E+03	0.24475E-02	0.21045E+00	0.51507E-03	0.23063E-02
0.67210E+03	0.25685E-02	0.21068E+00	0.54111E-03	0.24229E-02
0.67215E+03	0.26904E-02	0.21090E+00	0.56742E-03	0.25407E-02
0.67220E+03	0.28124E-02	0.21113E+00	0.59379E-03	0.26588E-02
0.67225E+03	0.29369E-02	0.21136E+00	0.62075E-03	0.27795E-02
0.67230E+03	0.30632E-02	0.21159E+00	0.64814E-03	0.29021E-02
0.67235E+03	0.31898E-02	0.21182E+00	0.67568E-03	0.30255E-02
0.67240E+03	0.33171E-02	0.21205E+00	0.70339E-03	0.31495E-02
0.67245E+03	0.34485E-02	0.21228E+00	0.73206E-03	0.32779E-02
0.67250E+03	0.35841E-02	0.21251E+00	0.76165E-03	0.34104E-02
0.67255E+03	0.37201E-02	0.21274E+00	0.79141E-03	0.35436E-02
0.67260E+03	0.38583E-02	0.21297E+00	0.82170E-03	0.36793E-02
0.67265E+03	0.39988E-02	0.21320E+00	0.85255E-03	0.38174E-02
0.67270E+03	0.41395E-02	0.21343E+00	0.88349E-03	0.39560E-02
0.67275E+03	0.42820E-02	0.21366E+00	0.91489E-03	0.40965E-02
0.67280E+03	0.44248E-02	0.21389E+00	0.94641E-03	0.42377E-02
0.67285E+03	0.45690E-02	0.21412E+00	0.97829E-03	0.43804E-02
0.67290E+03	0.47191E-02	0.21435E+00	0.10115E-02	0.45292E-02
0.67295E+03	0.48705E-02	0.21458E+00	0.10451E-02	0.46796E-02
0.67300E+03	0.50271E-02	0.21481E+00	0.10799E-02	0.48352E-02
0.67305E+03	0.51844E-02	0.21504E+00	0.11148E-02	0.49918E-02
0.67310E+03	0.53482E-02	0.21527E+00	0.11513E-02	0.51550E-02
0.67315E+03	0.55120E-02	0.21549E+00	0.11878E-02	0.53186E-02
0.67320E+03	0.56771E-02	0.21572E+00	0.12247E-02	0.54838E-02
0.67325E+03	0.58438E-02	0.21595E+00	0.12619E-02	0.56505E-02
0.67330E+03	0.60106E-02	0.21617E+00	0.12993E-02	0.58178E-02
0.67335E+03	0.61799E-02	0.21639E+00	0.13373E-02	0.59877E-02

0.67340E+03	0.63536E-02	0.21661E+00	0.13762E-02	0.61622E-02
0.67345E+03	0.65288E-02	0.21683E+00	0.14156E-02	0.63386E-02
0.67350E+03	0.67042E-02	0.21705E+00	0.14551E-02	0.65155E-02
0.67355E+03	0.68797E-02	0.21727E+00	0.14947E-02	0.66929E-02
0.67360E+03	0.70561E-02	0.21749E+00	0.15346E-02	0.68715E-02
0.67365E+03	0.72325E-02	0.21771E+00	0.15746E-02	0.70505E-02
0.67370E+03	0.74107E-02	0.21793E+00	0.16150E-02	0.72315E-02
0.67375E+03	0.75933E-02	0.21815E+00	0.16565E-02	0.74172E-02
0.67380E+03	0.77860E-02	0.21838E+00	0.17003E-02	0.76132E-02
0.67385E+03	0.79828E-02	0.21860E+00	0.17450E-02	0.78135E-02
0.67390E+03	0.81839E-02	0.21882E+00	0.17908E-02	0.80185E-02
0.67395E+03	0.83851E-02	0.21904E+00	0.18367E-02	0.82240E-02
0.67400E+03	0.85869E-02	0.21926E+00	0.18828E-02	0.84305E-02
0.67405E+03	0.87909E-02	0.21949E+00	0.19295E-02	0.86395E-02
0.67410E+03	0.89953E-02	0.21971E+00	0.19764E-02	0.88495E-02
0.67415E+03	0.92079E-02	0.21994E+00	0.20252E-02	0.90680E-02
0.67420E+03	0.94403E-02	0.22016E+00	0.20784E-02	0.93063E-02
0.67425E+03	0.96743E-02	0.22039E+00	0.21321E-02	0.95467E-02
0.67430E+03	0.99224E-02	0.22061E+00	0.21890E-02	0.98015E-02
0.67435E+03	0.10171E-01	0.22084E+00	0.22461E-02	0.10057E-01
0.67440E+03	0.10430E-01	0.22106E+00	0.23057E-02	0.10324E-01
0.67445E+03	0.10691E-01	0.22129E+00	0.23658E-02	0.10593E-01
0.67450E+03	0.10960E-01	0.22152E+00	0.24279E-02	0.10871E-01
0.67455E+03	0.11233E-01	0.22174E+00	0.24909E-02	0.11153E-01
0.67460E+03	0.11515E-01	0.22197E+00	0.25560E-02	0.11445E-01
0.67465E+03	0.11800E-01	0.22219E+00	0.26218E-02	0.11739E-01
0.67470E+03	0.12091E-01	0.22242E+00	0.26892E-02	0.12041E-01
0.67475E+03	0.12384E-01	0.22265E+00	0.27573E-02	0.12346E-01
0.67480E+03	0.12679E-01	0.22287E+00	0.28259E-02	0.12653E-01
0.67485E+03	0.12977E-01	0.22310E+00	0.28952E-02	0.12964E-01
0.67490E+03	0.13321E-01	0.22333E+00	0.29750E-02	0.13321E-01
0.67495E+03	0.13715E-01	0.22355E+00	0.30661E-02	0.13729E-01
0.67500E+03	0.14171E-01	0.22378E+00	0.31712E-02	0.14199E-01
0.67505E+03	0.14687E-01	0.22401E+00	0.32900E-02	0.14731E-01
0.67510E+03	0.15264E-01	0.22424E+00	0.34228E-02	0.15326E-01
0.67515E+03	0.15882E-01	0.22445E+00	0.35649E-02	0.15962E-01
0.67520E+03	0.16538E-01	0.22466E+00	0.37155E-02	0.16636E-01
0.67525E+03	0.17224E-01	0.22486E+00	0.38729E-02	0.17342E-01
0.67530E+03	0.17930E-01	0.22507E+00	0.40354E-02	0.18069E-01
0.67535E+03	0.18642E-01	0.22527E+00	0.41994E-02	0.18804E-01
0.67540E+03	0.19367E-01	0.22548E+00	0.43667E-02	0.19552E-01
0.67545E+03	0.20099E-01	0.22568E+00	0.45360E-02	0.20311E-01
0.67550E+03	0.20833E-01	0.22589E+00	0.47058E-02	0.21071E-01

0.67555E+03	0.21569E-01	0.22609E+00	0.48767E-02	0.21836E-01
0.67560E+03	0.22309E-01	0.22630E+00	0.50484E-02	0.22605E-01
0.67565E+03	0.23049E-01	0.22650E+00	0.52205E-02	0.23376E-01
0.67570E+03	0.23790E-01	0.22671E+00	0.53934E-02	0.24150E-01
0.67575E+03	0.24492E-01	0.22691E+00	0.55576E-02	0.24885E-01
0.67580E+03	0.25172E-01	0.22712E+00	0.57170E-02	0.25599E-01
0.67585E+03	0.25832E-01	0.22732E+00	0.58721E-02	0.26293E-01
0.67590E+03	0.26476E-01	0.22753E+00	0.60241E-02	0.26974E-01
0.67595E+03	0.27108E-01	0.22773E+00	0.61735E-02	0.27643E-01
0.67600E+03	0.27725E-01	0.22794E+00	0.63195E-02	0.28297E-01
0.67605E+03	0.28335E-01	0.22815E+00	0.64647E-02	0.28946E-01
0.67610E+03	0.28953E-01	0.22836E+00	0.66115E-02	0.29604E-01
0.67615E+03	0.29575E-01	0.22857E+00	0.67599E-02	0.30268E-01
0.67620E+03	0.30226E-01	0.22877E+00	0.69148E-02	0.30962E-01
0.67625E+03	0.30907E-01	0.22898E+00	0.70772E-02	0.31689E-01
0.67630E+03	0.31623E-01	0.22919E+00	0.72477E-02	0.32453E-01
0.67635E+03	0.32368E-01	0.22940E+00	0.74252E-02	0.33247E-01
0.67640E+03	0.33177E-01	0.22961E+00	0.76178E-02	0.34110E-01
0.67645E+03	0.34043E-01	0.22982E+00	0.78236E-02	0.35031E-01
0.67650E+03	0.34954E-01	0.23003E+00	0.80402E-02	0.36001E-01
0.67655E+03	0.35895E-01	0.23024E+00	0.82643E-02	0.37005E-01
0.67660E+03	0.36853E-01	0.23044E+00	0.84925E-02	0.38026E-01
0.67665E+03	0.37823E-01	0.23065E+00	0.87240E-02	0.39063E-01
0.67670E+03	0.38804E-01	0.23086E+00	0.89583E-02	0.40112E-01
0.67675E+03	0.39797E-01	0.23107E+00	0.91961E-02	0.41177E-01
0.67680E+03	0.40793E-01	0.23128E+00	0.94346E-02	0.42245E-01
0.67685E+03	0.41796E-01	0.23149E+00	0.96754E-02	0.43323E-01
0.67690E+03	0.42815E-01	0.23170E+00	0.99203E-02	0.44420E-01
0.67695E+03	0.43861E-01	0.23191E+00	0.10172E-01	0.45546E-01
0.67700E+03	0.44955E-01	0.23212E+00	0.10435E-01	0.46723E-01
0.67705E+03	0.46101E-01	0.23233E+00	0.10710E-01	0.47957E-01
0.67710E+03	0.47303E-01	0.23252E+00	0.10999E-01	0.49250E-01
0.67715E+03	0.48570E-01	0.23272E+00	0.11303E-01	0.50612E-01
0.67720E+03	0.49930E-01	0.23291E+00	0.11629E-01	0.52072E-01
0.67725E+03	0.51385E-01	0.23311E+00	0.11978E-01	0.53633E-01
0.67730E+03	0.52934E-01	0.23330E+00	0.12349E-01	0.55296E-01
0.67735E+03	0.54555E-01	0.23349E+00	0.12738E-01	0.57037E-01
0.67740E+03	0.56249E-01	0.23369E+00	0.13145E-01	0.58857E-01
0.67745E+03	0.58008E-01	0.23388E+00	0.13567E-01	0.60748E-01
0.67750E+03	0.59826E-01	0.23407E+00	0.14004E-01	0.62703E-01
0.67755E+03	0.61711E-01	0.23427E+00	0.14457E-01	0.64732E-01
0.67760E+03	0.63672E-01	0.23446E+00	0.14929E-01	0.66845E-01
0.67765E+03	0.65709E-01	0.23465E+00	0.15419E-01	0.69040E-01

0.67770E+03	0.67821E-01	0.23485E+00	0.15927E-01	0.71318E-01
0.67775E+03	0.69992E-01	0.23504E+00	0.16451E-01	0.73660E-01
0.67780E+03	0.72226E-01	0.23523E+00	0.16990E-01	0.76074E-01
0.67785E+03	0.74516E-01	0.23542E+00	0.17543E-01	0.78550E-01
0.67790E+03	0.76854E-01	0.23562E+00	0.18108E-01	0.81081E-01
0.67795E+03	0.79249E-01	0.23581E+00	0.18688E-01	0.83676E-01
0.67800E+03	0.81714E-01	0.23600E+00	0.19284E-01	0.86349E-01
0.67805E+03	0.84245E-01	0.23619E+00	0.19898E-01	0.89095E-01
0.67810E+03	0.86839E-01	0.23638E+00	0.20527E-01	0.91913E-01
0.67815E+03	0.89502E-01	0.23657E+00	0.21174E-01	0.94809E-01
0.67820E+03	0.92260E-01	0.23676E+00	0.21844E-01	0.97809E-01
0.67825E+03	0.95111E-01	0.23696E+00	0.22537E-01	0.10091E+00
0.67830E+03	0.98054E-01	0.23715E+00	0.23253E-01	0.10412E+00
0.67835E+03	0.10108E+00	0.23734E+00	0.23990E-01	0.10742E+00
0.67840E+03	0.10419E+00	0.23753E+00	0.24747E-01	0.11081E+00
0.67845E+03	0.10738E+00	0.23772E+00	0.25527E-01	0.11430E+00
0.67850E+03	0.11066E+00	0.23791E+00	0.26328E-01	0.11789E+00
0.67855E+03	0.11403E+00	0.23810E+00	0.27151E-01	0.12157E+00
0.67860E+03	0.11748E+00	0.23829E+00	0.27995E-01	0.12535E+00
0.67865E+03	0.12102E+00	0.23848E+00	0.28862E-01	0.12924E+00
0.67870E+03	0.12466E+00	0.23868E+00	0.29754E-01	0.13323E+00
0.67875E+03	0.12839E+00	0.23887E+00	0.30669E-01	0.13733E+00
0.67880E+03	0.13222E+00	0.23906E+00	0.31608E-01	0.14153E+00
0.67885E+03	0.13614E+00	0.23925E+00	0.32571E-01	0.14584E+00
0.67890E+03	0.14016E+00	0.23944E+00	0.33560E-01	0.15027E+00
0.67895E+03	0.14430E+00	0.23963E+00	0.34579E-01	0.15483E+00
0.67900E+03	0.14858E+00	0.23983E+00	0.35633E-01	0.15955E+00
0.67905E+03	0.15300E+00	0.24002E+00	0.36722E-01	0.16443E+00
0.67910E+03	0.15756E+00	0.24021E+00	0.37849E-01	0.16947E+00
0.67915E+03	0.16226E+00	0.24040E+00	0.39008E-01	0.17466E+00
0.67920E+03	0.16709E+00	0.24059E+00	0.40200E-01	0.18000E+00
0.67925E+03	0.17204E+00	0.24079E+00	0.41425E-01	0.18548E+00
0.67930E+03	0.17710E+00	0.24098E+00	0.42679E-01	0.19110E+00
0.67935E+03	0.18230E+00	0.24117E+00	0.43965E-01	0.19686E+00
0.67940E+03	0.18760E+00	0.24137E+00	0.45281E-01	0.20275E+00
0.67945E+03	0.19303E+00	0.24156E+00	0.46627E-01	0.20878E+00
0.67950E+03	0.19857E+00	0.24175E+00	0.48004E-01	0.21495E+00
0.67955E+03	0.20425E+00	0.24194E+00	0.49417E-01	0.22127E+00
0.67960E+03	0.21007E+00	0.24214E+00	0.50867E-01	0.22776E+00
0.67965E+03	0.21606E+00	0.24233E+00	0.52357E-01	0.23444E+00
0.67970E+03	0.22221E+00	0.24252E+00	0.53891E-01	0.24130E+00
0.67975E+03	0.22852E+00	0.24272E+00	0.55466E-01	0.24835E+00
0.67980E+03	0.23500E+00	0.24291E+00	0.57083E-01	0.25560E+00

0.67985E+03	0.24164E+00	0.24310E+00	0.58745E-01	0.26304E+00
0.67990E+03	0.24847E+00	0.24330E+00	0.60453E-01	0.27069E+00
0.67995E+03	0.25544E+00	0.24349E+00	0.62199E-01	0.27850E+00
0.68000E+03	0.26252E+00	0.24369E+00	0.63973E-01	0.28645E+00
0.68005E+03	0.26971E+00	0.24387E+00	0.65775E-01	0.29452E+00
0.68010E+03	0.27700E+00	0.24406E+00	0.67603E-01	0.30270E+00
0.68015E+03	0.28438E+00	0.24425E+00	0.69460E-01	0.31102E+00
0.68020E+03	0.29186E+00	0.24443E+00	0.71340E-01	0.31944E+00
0.68025E+03	0.29941E+00	0.24462E+00	0.73242E-01	0.32795E+00
0.68030E+03	0.30704E+00	0.24481E+00	0.75166E-01	0.33657E+00
0.68035E+03	0.31476E+00	0.24500E+00	0.77116E-01	0.34530E+00
0.68040E+03	0.32258E+00	0.24519E+00	0.79092E-01	0.35415E+00
0.68045E+03	0.33050E+00	0.24537E+00	0.81095E-01	0.36311E+00
0.68050E+03	0.33851E+00	0.24556E+00	0.83126E-01	0.37221E+00
0.68055E+03	0.34662E+00	0.24575E+00	0.85182E-01	0.38141E+00
0.68060E+03	0.35480E+00	0.24594E+00	0.87260E-01	0.39072E+00
0.68065E+03	0.36306E+00	0.24613E+00	0.89359E-01	0.40012E+00
0.68070E+03	0.37139E+00	0.24631E+00	0.91480E-01	0.40961E+00
0.68075E+03	0.37978E+00	0.24650E+00	0.93617E-01	0.41918E+00
0.68080E+03	0.38819E+00	0.24669E+00	0.95762E-01	0.42879E+00
0.68085E+03	0.39661E+00	0.24688E+00	0.97915E-01	0.43843E+00
0.68090E+03	0.40504E+00	0.24707E+00	0.10007E+00	0.44809E+00
0.68095E+03	0.41348E+00	0.24726E+00	0.10224E+00	0.45778E+00
0.68100E+03	0.42191E+00	0.24744E+00	0.10440E+00	0.46746E+00
0.68105E+03	0.43032E+00	0.24763E+00	0.10656E+00	0.47714E+00
0.68110E+03	0.43872E+00	0.24781E+00	0.10872E+00	0.48681E+00
0.68115E+03	0.44708E+00	0.24800E+00	0.11088E+00	0.49646E+00
0.68120E+03	0.45539E+00	0.24818E+00	0.11302E+00	0.50606E+00
0.68125E+03	0.46365E+00	0.24837E+00	0.11515E+00	0.51562E+00
0.68130E+03	0.47185E+00	0.24855E+00	0.11728E+00	0.52513E+00
0.68135E+03	0.47998E+00	0.24874E+00	0.11939E+00	0.53459E+00
0.68140E+03	0.48802E+00	0.24893E+00	0.12148E+00	0.54395E+00
0.68145E+03	0.49597E+00	0.24911E+00	0.12355E+00	0.55322E+00
0.68150E+03	0.50384E+00	0.24930E+00	0.12561E+00	0.56242E+00
0.68155E+03	0.51162E+00	0.24948E+00	0.12764E+00	0.57153E+00
0.68160E+03	0.51929E+00	0.24967E+00	0.12965E+00	0.58053E+00
0.68165E+03	0.52686E+00	0.24986E+00	0.13164E+00	0.58943E+00
0.68170E+03	0.53433E+00	0.25004E+00	0.13361E+00	0.59824E+00
0.68175E+03	0.54169E+00	0.25023E+00	0.13555E+00	0.60693E+00
0.68180E+03	0.54893E+00	0.25041E+00	0.13746E+00	0.61549E+00
0.68185E+03	0.55603E+00	0.25060E+00	0.13934E+00	0.62392E+00
0.68190E+03	0.56300E+00	0.25079E+00	0.14119E+00	0.63222E+00
0.68195E+03	0.56983E+00	0.25097E+00	0.14301E+00	0.64036E+00

0.68200E+03	0.57649E+00	0.25116E+00	0.14479E+00	0.64833E+00
0.68205E+03	0.58298E+00	0.25134E+00	0.14653E+00	0.65610E+00
0.68210E+03	0.58929E+00	0.25153E+00	0.14822E+00	0.66369E+00
0.68215E+03	0.59543E+00	0.25171E+00	0.14988E+00	0.67109E+00
0.68220E+03	0.60137E+00	0.25189E+00	0.15148E+00	0.67827E+00
0.68225E+03	0.60710E+00	0.25208E+00	0.15304E+00	0.68524E+00
0.68230E+03	0.61264E+00	0.25226E+00	0.15454E+00	0.69200E+00
0.68235E+03	0.61799E+00	0.25244E+00	0.15601E+00	0.69855E+00
0.68240E+03	0.62316E+00	0.25263E+00	0.15743E+00	0.70490E+00
0.68245E+03	0.62816E+00	0.25281E+00	0.15881E+00	0.71107E+00
0.68250E+03	0.63299E+00	0.25299E+00	0.16014E+00	0.71707E+00
0.68255E+03	0.63765E+00	0.25318E+00	0.16144E+00	0.72286E+00
0.68260E+03	0.64211E+00	0.25336E+00	0.16269E+00	0.72845E+00
0.68265E+03	0.64638E+00	0.25355E+00	0.16389E+00	0.73383E+00
0.68270E+03	0.65047E+00	0.25373E+00	0.16504E+00	0.73901E+00
0.68275E+03	0.65438E+00	0.25391E+00	0.16616E+00	0.74398E+00
0.68280E+03	0.65811E+00	0.25410E+00	0.16722E+00	0.74877E+00
0.68285E+03	0.66168E+00	0.25428E+00	0.16825E+00	0.75336E+00
0.68290E+03	0.66506E+00	0.25446E+00	0.16923E+00	0.75775E+00
0.68295E+03	0.66828E+00	0.25464E+00	0.17017E+00	0.76195E+00
0.68300E+03	0.67133E+00	0.25481E+00	0.17106E+00	0.76596E+00
0.68305E+03	0.67421E+00	0.25499E+00	0.17192E+00	0.76978E+00
0.68310E+03	0.67692E+00	0.25517E+00	0.17273E+00	0.77342E+00
0.68315E+03	0.67947E+00	0.25535E+00	0.17350E+00	0.77687E+00
0.68320E+03	0.68186E+00	0.25552E+00	0.17423E+00	0.78015E+00
0.68325E+03	0.68410E+00	0.25570E+00	0.17493E+00	0.78326E+00
0.68330E+03	0.68618E+00	0.25588E+00	0.17558E+00	0.78619E+00
0.68335E+03	0.68810E+00	0.25606E+00	0.17620E+00	0.78894E+00
0.68340E+03	0.68986E+00	0.25624E+00	0.17677E+00	0.79150E+00
0.68345E+03	0.69145E+00	0.25642E+00	0.17730E+00	0.79388E+00
0.68350E+03	0.69287E+00	0.25659E+00	0.17778E+00	0.79606E+00
0.68355E+03	0.69412E+00	0.25677E+00	0.17823E+00	0.79806E+00
0.68360E+03	0.69522E+00	0.25695E+00	0.17864E+00	0.79987E+00
0.68365E+03	0.69614E+00	0.25713E+00	0.17900E+00	0.80149E+00
0.68370E+03	0.69691E+00	0.25731E+00	0.17932E+00	0.80293E+00
0.68375E+03	0.69754E+00	0.25749E+00	0.17961E+00	0.80421E+00
0.68380E+03	0.69805E+00	0.25766E+00	0.17986E+00	0.80536E+00
0.68385E+03	0.69846E+00	0.25784E+00	0.18009E+00	0.80639E+00
0.68390E+03	0.69876E+00	0.25802E+00	0.18030E+00	0.80730E+00
0.68395E+03	0.69897E+00	0.25820E+00	0.18047E+00	0.80810E+00
0.68400E+03	0.69909E+00	0.25838E+00	0.18063E+00	0.80879E+00
0.68405E+03	0.69911E+00	0.25855E+00	0.18076E+00	0.80937E+00
0.68410E+03	0.69905E+00	0.25873E+00	0.18086E+00	0.80984E+00

0.68415E+03	0.69891E+00	0.25890E+00	0.18095E+00	0.81023E+00
0.68420E+03	0.69872E+00	0.25908E+00	0.18103E+00	0.81057E+00
0.68425E+03	0.69850E+00	0.25926E+00	0.18109E+00	0.81085E+00
0.68430E+03	0.69822E+00	0.25943E+00	0.18114E+00	0.81107E+00
0.68435E+03	0.69789E+00	0.25961E+00	0.18118E+00	0.81124E+00
0.68440E+03	0.69750E+00	0.25978E+00	0.18120E+00	0.81134E+00
0.68445E+03	0.69705E+00	0.25996E+00	0.18120E+00	0.81137E+00
0.68450E+03	0.69655E+00	0.26013E+00	0.18120E+00	0.81133E+00
0.68455E+03	0.69600E+00	0.26031E+00	0.18118E+00	0.81124E+00
0.68460E+03	0.69543E+00	0.26049E+00	0.18115E+00	0.81112E+00
0.68465E+03	0.69482E+00	0.26066E+00	0.18111E+00	0.81096E+00
0.68470E+03	0.69417E+00	0.26084E+00	0.18107E+00	0.81075E+00
0.68475E+03	0.69350E+00	0.26101E+00	0.18101E+00	0.81052E+00
0.68480E+03	0.69280E+00	0.26119E+00	0.18095E+00	0.81024E+00
0.68485E+03	0.69208E+00	0.26136E+00	0.18088E+00	0.80992E+00
0.68490E+03	0.69132E+00	0.26153E+00	0.18080E+00	0.80956E+00
0.68495E+03	0.69054E+00	0.26170E+00	0.18071E+00	0.80917E+00
0.68500E+03	0.68975E+00	0.26187E+00	0.18062E+00	0.80877E+00
0.68505E+03	0.68895E+00	0.26204E+00	0.18053E+00	0.80835E+00
0.68510E+03	0.68813E+00	0.26221E+00	0.18043E+00	0.80792E+00
0.68515E+03	0.68732E+00	0.26238E+00	0.18034E+00	0.80750E+00
0.68520E+03	0.68652E+00	0.26255E+00	0.18025E+00	0.80708E+00
0.68525E+03	0.68573E+00	0.26272E+00	0.18015E+00	0.80665E+00
0.68530E+03	0.68496E+00	0.26288E+00	0.18006E+00	0.80625E+00
0.68535E+03	0.68422E+00	0.26304E+00	0.17998E+00	0.80588E+00
0.68540E+03	0.68351E+00	0.26321E+00	0.17991E+00	0.80556E+00
0.68545E+03	0.68286E+00	0.26337E+00	0.17985E+00	0.80529E+00
0.68550E+03	0.68223E+00	0.26354E+00	0.17979E+00	0.80505E+00
0.68555E+03	0.68164E+00	0.26370E+00	0.17975E+00	0.80486E+00
0.68560E+03	0.68110E+00	0.26387E+00	0.17972E+00	0.80472E+00
0.68565E+03	0.68059E+00	0.26403E+00	0.17970E+00	0.80463E+00
0.68570E+03	0.68012E+00	0.26420E+00	0.17969E+00	0.80457E+00
0.68575E+03	0.67969E+00	0.26436E+00	0.17968E+00	0.80456E+00
0.68580E+03	0.67929E+00	0.26453E+00	0.17969E+00	0.80459E+00
0.68585E+03	0.67892E+00	0.26469E+00	0.17970E+00	0.80465E+00
0.68590E+03	0.67858E+00	0.26486E+00	0.17973E+00	0.80476E+00
0.68595E+03	0.67829E+00	0.26502E+00	0.17976E+00	0.80491E+00
0.68600E+03	0.67804E+00	0.26519E+00	0.17981E+00	0.80512E+00
0.68605E+03	0.67784E+00	0.26536E+00	0.17987E+00	0.80541E+00
0.68610E+03	0.67768E+00	0.26554E+00	0.17995E+00	0.80575E+00
0.68615E+03	0.67758E+00	0.26571E+00	0.18004E+00	0.80616E+00
0.68620E+03	0.67755E+00	0.26589E+00	0.18015E+00	0.80666E+00
0.68625E+03	0.67759E+00	0.26606E+00	0.18028E+00	0.80723E+00

0.68630E+03	0.67770E+00	0.26624E+00	0.18043E+00	0.80790E+00
0.68635E+03	0.67787E+00	0.26641E+00	0.18059E+00	0.80863E+00
0.68640E+03	0.67808E+00	0.26659E+00	0.18077E+00	0.80941E+00
0.68645E+03	0.67834E+00	0.26676E+00	0.18095E+00	0.81024E+00
0.68650E+03	0.67863E+00	0.26694E+00	0.18115E+00	0.81113E+00
0.68655E+03	0.67896E+00	0.26711E+00	0.18136E+00	0.81206E+00
0.68660E+03	0.67935E+00	0.26729E+00	0.18158E+00	0.81306E+00
0.68665E+03	0.67979E+00	0.26746E+00	0.18182E+00	0.81411E+00
0.68670E+03	0.68027E+00	0.26764E+00	0.18207E+00	0.81523E+00
0.68675E+03	0.68080E+00	0.26781E+00	0.18232E+00	0.81638E+00
0.68680E+03	0.68136E+00	0.26798E+00	0.18259E+00	0.81758E+00
0.68685E+03	0.68196E+00	0.26815E+00	0.18287E+00	0.81883E+00
0.68690E+03	0.68259E+00	0.26833E+00	0.18316E+00	0.82011E+00
0.68695E+03	0.68324E+00	0.26850E+00	0.18345E+00	0.82142E+00
0.68700E+03	0.68391E+00	0.26867E+00	0.18375E+00	0.82275E+00
0.68705E+03	0.68459E+00	0.26884E+00	0.18405E+00	0.82410E+00
0.68710E+03	0.68528E+00	0.26901E+00	0.18435E+00	0.82545E+00
0.68715E+03	0.68597E+00	0.26919E+00	0.18465E+00	0.82682E+00
0.68720E+03	0.68667E+00	0.26936E+00	0.18496E+00	0.82818E+00
0.68725E+03	0.68737E+00	0.26953E+00	0.18527E+00	0.82956E+00
0.68730E+03	0.68808E+00	0.26970E+00	0.18558E+00	0.83094E+00
0.68735E+03	0.68879E+00	0.26987E+00	0.18589E+00	0.83233E+00
0.68740E+03	0.68952E+00	0.27005E+00	0.18620E+00	0.83375E+00
0.68745E+03	0.69027E+00	0.27022E+00	0.18652E+00	0.83518E+00
0.68750E+03	0.69103E+00	0.27039E+00	0.18685E+00	0.83664E+00
0.68755E+03	0.69183E+00	0.27056E+00	0.18718E+00	0.83814E+00
0.68760E+03	0.69266E+00	0.27073E+00	0.18753E+00	0.83968E+00
0.68765E+03	0.69354E+00	0.27091E+00	0.18788E+00	0.84128E+00
0.68770E+03	0.69447E+00	0.27108E+00	0.18826E+00	0.84294E+00
0.68775E+03	0.69544E+00	0.27125E+00	0.18864E+00	0.84466E+00
0.68780E+03	0.69645E+00	0.27142E+00	0.18903E+00	0.84643E+00
0.68785E+03	0.69752E+00	0.27160E+00	0.18944E+00	0.84826E+00
0.68790E+03	0.69862E+00	0.27177E+00	0.18986E+00	0.85014E+00
0.68795E+03	0.69977E+00	0.27194E+00	0.19030E+00	0.85208E+00
0.68800E+03	0.70096E+00	0.27211E+00	0.19074E+00	0.85408E+00
0.68805E+03	0.70221E+00	0.27227E+00	0.19119E+00	0.85609E+00
0.68810E+03	0.70351E+00	0.27243E+00	0.19166E+00	0.85818E+00
0.68815E+03	0.70485E+00	0.27259E+00	0.19214E+00	0.86032E+00
0.68820E+03	0.70622E+00	0.27275E+00	0.19262E+00	0.86250E+00
0.68825E+03	0.70762E+00	0.27291E+00	0.19312E+00	0.86471E+00
0.68830E+03	0.70906E+00	0.27307E+00	0.19362E+00	0.86697E+00
0.68835E+03	0.71053E+00	0.27323E+00	0.19414E+00	0.86927E+00
0.68840E+03	0.71203E+00	0.27339E+00	0.19466E+00	0.87163E+00

0.68845E+03	0.71358E+00	0.27355E+00	0.19520E+00	0.87402E+00
0.68850E+03	0.71516E+00	0.27371E+00	0.19574E+00	0.87647E+00
0.68855E+03	0.71678E+00	0.27387E+00	0.19630E+00	0.87897E+00
0.68860E+03	0.71845E+00	0.27403E+00	0.19687E+00	0.88153E+00
0.68865E+03	0.72017E+00	0.27418E+00	0.19746E+00	0.88415E+00
0.68870E+03	0.72194E+00	0.27433E+00	0.19805E+00	0.88680E+00
0.68875E+03	0.72376E+00	0.27448E+00	0.19866E+00	0.88952E+00
0.68880E+03	0.72561E+00	0.27463E+00	0.19927E+00	0.89228E+00
0.68885E+03	0.72750E+00	0.27478E+00	0.19990E+00	0.89510E+00
0.68890E+03	0.72944E+00	0.27493E+00	0.20054E+00	0.89797E+00
0.68895E+03	0.73140E+00	0.27508E+00	0.20119E+00	0.90087E+00
0.68900E+03	0.73336E+00	0.27523E+00	0.20184E+00	0.90378E+00
0.68905E+03	0.73532E+00	0.27538E+00	0.20249E+00	0.90669E+00
0.68910E+03	0.73728E+00	0.27553E+00	0.20314E+00	0.90959E+00
0.68915E+03	0.73922E+00	0.27568E+00	0.20379E+00	0.91248E+00
0.68920E+03	0.74114E+00	0.27583E+00	0.20443E+00	0.91534E+00
0.68925E+03	0.74302E+00	0.27598E+00	0.20506E+00	0.91817E+00
0.68930E+03	0.74487E+00	0.27612E+00	0.20568E+00	0.92094E+00
0.68935E+03	0.74668E+00	0.27627E+00	0.20629E+00	0.92368E+00
0.68940E+03	0.74847E+00	0.27642E+00	0.20689E+00	0.92639E+00
0.68945E+03	0.75023E+00	0.27657E+00	0.20749E+00	0.92907E+00
0.68950E+03	0.75197E+00	0.27672E+00	0.20809E+00	0.93173E+00
0.68955E+03	0.75369E+00	0.27687E+00	0.20867E+00	0.93437E+00
0.68960E+03	0.75538E+00	0.27702E+00	0.20925E+00	0.93696E+00
0.68965E+03	0.75704E+00	0.27717E+00	0.20983E+00	0.93952E+00
0.68970E+03	0.75867E+00	0.27732E+00	0.21039E+00	0.94206E+00
0.68975E+03	0.76028E+00	0.27746E+00	0.21095E+00	0.94456E+00
0.68980E+03	0.76186E+00	0.27761E+00	0.21150E+00	0.94703E+00
0.68985E+03	0.76340E+00	0.27776E+00	0.21204E+00	0.94946E+00
0.68990E+03	0.76492E+00	0.27791E+00	0.21258E+00	0.95185E+00
0.68995E+03	0.76640E+00	0.27806E+00	0.21311E+00	0.95422E+00
0.69000E+03	0.76787E+00	0.27821E+00	0.21363E+00	0.95655E+00
0.69005E+03	0.76931E+00	0.27834E+00	0.21413E+00	0.95879E+00
0.69010E+03	0.77073E+00	0.27847E+00	0.21462E+00	0.96101E+00
0.69015E+03	0.77212E+00	0.27860E+00	0.21511E+00	0.96320E+00
0.69020E+03	0.77348E+00	0.27873E+00	0.21559E+00	0.96535E+00
0.69025E+03	0.77480E+00	0.27886E+00	0.21606E+00	0.96745E+00
0.69030E+03	0.77610E+00	0.27899E+00	0.21653E+00	0.96952E+00
0.69035E+03	0.77736E+00	0.27912E+00	0.21698E+00	0.97155E+00
0.69040E+03	0.77859E+00	0.27925E+00	0.21742E+00	0.97354E+00
0.69045E+03	0.77977E+00	0.27938E+00	0.21786E+00	0.97548E+00
0.69050E+03	0.78093E+00	0.27951E+00	0.21828E+00	0.97739E+00
0.69055E+03	0.78205E+00	0.27964E+00	0.21870E+00	0.97925E+00

0.69060E+03	0.78313E+00	0.27977E+00	0.21910E+00	0.98105E+00
0.69065E+03	0.78416E+00	0.27990E+00	0.21949E+00	0.98279E+00
0.69070E+03	0.78514E+00	0.28003E+00	0.21986E+00	0.98446E+00
0.69075E+03	0.78607E+00	0.28016E+00	0.22022E+00	0.98608E+00
0.69080E+03	0.78695E+00	0.28028E+00	0.22057E+00	0.98763E+00
0.69085E+03	0.78777E+00	0.28041E+00	0.22090E+00	0.98910E+00
0.69090E+03	0.78853E+00	0.28054E+00	0.22121E+00	0.99051E+00
0.69095E+03	0.78923E+00	0.28067E+00	0.22151E+00	0.99184E+00
0.69100E+03	0.78985E+00	0.28079E+00	0.22179E+00	0.99308E+00
0.69105E+03	0.79039E+00	0.28092E+00	0.22204E+00	0.99420E+00
0.69110E+03	0.79085E+00	0.28105E+00	0.22226E+00	0.99522E+00
0.69115E+03	0.79123E+00	0.28117E+00	0.22247E+00	0.99616E+00
0.69120E+03	0.79154E+00	0.28130E+00	0.22266E+00	0.99700E+00
0.69125E+03	0.79179E+00	0.28143E+00	0.22283E+00	0.99776E+00
0.69130E+03	0.79198E+00	0.28155E+00	0.22298E+00	0.99845E+00
0.69135E+03	0.79208E+00	0.28168E+00	0.22312E+00	0.99903E+00
0.69140E+03	0.79209E+00	0.28181E+00	0.22322E+00	0.99949E+00
0.69145E+03	0.79198E+00	0.28193E+00	0.22329E+00	0.99980E+00
0.69150E+03	0.79176E+00	0.28206E+00	0.22333E+00	0.99997E+00
0.69155E+03	0.79143E+00	0.28219E+00	0.22333E+00	0.10000E+01
0.69160E+03	0.79097E+00	0.28232E+00	0.22330E+00	0.99987E+00
0.69165E+03	0.79038E+00	0.28244E+00	0.22324E+00	0.99958E+00
0.69170E+03	0.78966E+00	0.28257E+00	0.22313E+00	0.99911E+00
0.69175E+03	0.78881E+00	0.28270E+00	0.22299E+00	0.99849E+00
0.69180E+03	0.78784E+00	0.28282E+00	0.22282E+00	0.99771E+00
0.69185E+03	0.78675E+00	0.28295E+00	0.22261E+00	0.99677E+00
0.69190E+03	0.78553E+00	0.28308E+00	0.22237E+00	0.99568E+00
0.69195E+03	0.78421E+00	0.28321E+00	0.22209E+00	0.99445E+00
0.69200E+03	0.78278E+00	0.28333E+00	0.22179E+00	0.99308E+00
0.69205E+03	0.78125E+00	0.28345E+00	0.22144E+00	0.99155E+00
0.69210E+03	0.77963E+00	0.28356E+00	0.22108E+00	0.98989E+00
0.69215E+03	0.77791E+00	0.28368E+00	0.22068E+00	0.98811E+00
0.69220E+03	0.77606E+00	0.28379E+00	0.22024E+00	0.98616E+00
0.69225E+03	0.77408E+00	0.28391E+00	0.21977E+00	0.98405E+00
0.69230E+03	0.77198E+00	0.28403E+00	0.21926E+00	0.98177E+00
0.69235E+03	0.76974E+00	0.28414E+00	0.21871E+00	0.97933E+00
0.69240E+03	0.76737E+00	0.28426E+00	0.21813E+00	0.97671E+00
0.69245E+03	0.76487E+00	0.28437E+00	0.21751E+00	0.97392E+00
0.69250E+03	0.76222E+00	0.28449E+00	0.21684E+00	0.97094E+00
0.69255E+03	0.75943E+00	0.28461E+00	0.21614E+00	0.96779E+00
0.69260E+03	0.75650E+00	0.28473E+00	0.21540E+00	0.96447E+00
0.69265E+03	0.75343E+00	0.28485E+00	0.21461E+00	0.96096E+00
0.69270E+03	0.75020E+00	0.28497E+00	0.21379E+00	0.95725E+00

0.69275E+03	0.74683E+00	0.28509E+00	0.21291E+00	0.95335E+00
0.69280E+03	0.74331E+00	0.28521E+00	0.21200E+00	0.94925E+00
0.69285E+03	0.73961E+00	0.28533E+00	0.21103E+00	0.94493E+00
0.69290E+03	0.73575E+00	0.28545E+00	0.21002E+00	0.94039E+00
0.69295E+03	0.73172E+00	0.28557E+00	0.20896E+00	0.93564E+00
0.69300E+03	0.72754E+00	0.28569E+00	0.20785E+00	0.93068E+00
0.69305E+03	0.72320E+00	0.28581E+00	0.20670E+00	0.92551E+00
0.69310E+03	0.71870E+00	0.28593E+00	0.20550E+00	0.92014E+00
0.69315E+03	0.71405E+00	0.28605E+00	0.20425E+00	0.91457E+00
0.69320E+03	0.70926E+00	0.28617E+00	0.20297E+00	0.90881E+00
0.69325E+03	0.70433E+00	0.28629E+00	0.20164E+00	0.90287E+00
0.69330E+03	0.69926E+00	0.28641E+00	0.20027E+00	0.89675E+00
0.69335E+03	0.69408E+00	0.28653E+00	0.19887E+00	0.89047E+00
0.69340E+03	0.68878E+00	0.28665E+00	0.19744E+00	0.88404E+00
0.69345E+03	0.68337E+00	0.28677E+00	0.19597E+00	0.87747E+00
0.69350E+03	0.67786E+00	0.28688E+00	0.19447E+00	0.87075E+00
0.69355E+03	0.67224E+00	0.28700E+00	0.19294E+00	0.86390E+00
0.69360E+03	0.66652E+00	0.28712E+00	0.19137E+00	0.85691E+00
0.69365E+03	0.66070E+00	0.28724E+00	0.18978E+00	0.84978E+00
0.69370E+03	0.65477E+00	0.28736E+00	0.18816E+00	0.84250E+00
0.69375E+03	0.64875E+00	0.28748E+00	0.18650E+00	0.83510E+00
0.69380E+03	0.64264E+00	0.28760E+00	0.18482E+00	0.82758E+00
0.69385E+03	0.63644E+00	0.28772E+00	0.18312E+00	0.81994E+00
0.69390E+03	0.63016E+00	0.28784E+00	0.18139E+00	0.81218E+00
0.69395E+03	0.62380E+00	0.28796E+00	0.17963E+00	0.80432E+00
0.69400E+03	0.61738E+00	0.28808E+00	0.17786E+00	0.79637E+00
0.69405E+03	0.61091E+00	0.28819E+00	0.17606E+00	0.78831E+00
0.69410E+03	0.60438E+00	0.28829E+00	0.17424E+00	0.78018E+00
0.69415E+03	0.59779E+00	0.28840E+00	0.17240E+00	0.77196E+00
0.69420E+03	0.59113E+00	0.28851E+00	0.17055E+00	0.76364E+00
0.69425E+03	0.58441E+00	0.28861E+00	0.16867E+00	0.75524E+00
0.69430E+03	0.57762E+00	0.28872E+00	0.16677E+00	0.74674E+00
0.69435E+03	0.57077E+00	0.28883E+00	0.16485E+00	0.73815E+00
0.69440E+03	0.56388E+00	0.28893E+00	0.16292E+00	0.72952E+00
0.69445E+03	0.55696E+00	0.28904E+00	0.16098E+00	0.72083E+00
0.69450E+03	0.55000E+00	0.28915E+00	0.15903E+00	0.71209E+00
0.69455E+03	0.54301E+00	0.28925E+00	0.15707E+00	0.70329E+00
0.69460E+03	0.53598E+00	0.28936E+00	0.15509E+00	0.69445E+00
0.69465E+03	0.52893E+00	0.28947E+00	0.15311E+00	0.68557E+00
0.69470E+03	0.52185E+00	0.28957E+00	0.15111E+00	0.67664E+00
0.69475E+03	0.51474E+00	0.28968E+00	0.14911E+00	0.66767E+00
0.69480E+03	0.50762E+00	0.28979E+00	0.14710E+00	0.65867E+00
0.69485E+03	0.50048E+00	0.28989E+00	0.14509E+00	0.64964E+00

0.69490E+03	0.49332E+00	0.29000E+00	0.14306E+00	0.64058E+00
0.69495E+03	0.48614E+00	0.29011E+00	0.14103E+00	0.63150E+00
0.69500E+03	0.47897E+00	0.29021E+00	0.13901E+00	0.62242E+00
0.69505E+03	0.47181E+00	0.29032E+00	0.13698E+00	0.61332E+00
0.69510E+03	0.46464E+00	0.29043E+00	0.13494E+00	0.60423E+00
0.69515E+03	0.45748E+00	0.29053E+00	0.13291E+00	0.59514E+00
0.69520E+03	0.45035E+00	0.29064E+00	0.13089E+00	0.58607E+00
0.69525E+03	0.44324E+00	0.29074E+00	0.12887E+00	0.57702E+00
0.69530E+03	0.43615E+00	0.29085E+00	0.12685E+00	0.56800E+00
0.69535E+03	0.42910E+00	0.29095E+00	0.12485E+00	0.55902E+00
0.69540E+03	0.42209E+00	0.29106E+00	0.12285E+00	0.55009E+00
0.69545E+03	0.41513E+00	0.29117E+00	0.12087E+00	0.54122E+00
0.69550E+03	0.40822E+00	0.29127E+00	0.11890E+00	0.53241E+00
0.69555E+03	0.40137E+00	0.29138E+00	0.11695E+00	0.52367E+00
0.69560E+03	0.39459E+00	0.29148E+00	0.11502E+00	0.51501E+00
0.69565E+03	0.38789E+00	0.29159E+00	0.11310E+00	0.50644E+00
0.69570E+03	0.38125E+00	0.29170E+00	0.11121E+00	0.49795E+00
0.69575E+03	0.37468E+00	0.29180E+00	0.10933E+00	0.48955E+00
0.69580E+03	0.36821E+00	0.29191E+00	0.10748E+00	0.48127E+00
0.69585E+03	0.36183E+00	0.29201E+00	0.10566E+00	0.47310E+00
0.69590E+03	0.35553E+00	0.29212E+00	0.10386E+00	0.46503E+00
0.69595E+03	0.34931E+00	0.29223E+00	0.10208E+00	0.45707E+00
0.69600E+03	0.34316E+00	0.29233E+00	0.10032E+00	0.44918E+00
0.69605E+03	0.33707E+00	0.29241E+00	0.98561E-01	0.44132E+00
0.69610E+03	0.33104E+00	0.29248E+00	0.96823E-01	0.43354E+00
0.69615E+03	0.32508E+00	0.29256E+00	0.95103E-01	0.42584E+00
0.69620E+03	0.31918E+00	0.29263E+00	0.93401E-01	0.41822E+00
0.69625E+03	0.31334E+00	0.29270E+00	0.91716E-01	0.41067E+00
0.69630E+03	0.30757E+00	0.29278E+00	0.90049E-01	0.40321E+00
0.69635E+03	0.30185E+00	0.29285E+00	0.88399E-01	0.39582E+00
0.69640E+03	0.29622E+00	0.29293E+00	0.86771E-01	0.38853E+00
0.69645E+03	0.29066E+00	0.29300E+00	0.85163E-01	0.38133E+00
0.69650E+03	0.28516E+00	0.29308E+00	0.83575E-01	0.37422E+00
0.69655E+03	0.27974E+00	0.29315E+00	0.82006E-01	0.36720E+00
0.69660E+03	0.27439E+00	0.29323E+00	0.80459E-01	0.36027E+00
0.69665E+03	0.26912E+00	0.29330E+00	0.78933E-01	0.35343E+00
0.69670E+03	0.26392E+00	0.29338E+00	0.77427E-01	0.34669E+00
0.69675E+03	0.25878E+00	0.29345E+00	0.75939E-01	0.34003E+00
0.69680E+03	0.25372E+00	0.29352E+00	0.74472E-01	0.33346E+00
0.69685E+03	0.24872E+00	0.29360E+00	0.73025E-01	0.32698E+00
0.69690E+03	0.24381E+00	0.29367E+00	0.71600E-01	0.32060E+00
0.69695E+03	0.23896E+00	0.29375E+00	0.70193E-01	0.31430E+00
0.69700E+03	0.23417E+00	0.29382E+00	0.68805E-01	0.30808E+00

0.69705E+03	0.22945E+00	0.29389E+00	0.67435E-01	0.30195E+00
0.69710E+03	0.22480E+00	0.29397E+00	0.66085E-01	0.29590E+00
0.69715E+03	0.22022E+00	0.29404E+00	0.64753E-01	0.28994E+00
0.69720E+03	0.21571E+00	0.29411E+00	0.63442E-01	0.28407E+00
0.69725E+03	0.21127E+00	0.29419E+00	0.62153E-01	0.27830E+00
0.69730E+03	0.20691E+00	0.29426E+00	0.60886E-01	0.27262E+00
0.69735E+03	0.20263E+00	0.29433E+00	0.59639E-01	0.26704E+00
0.69740E+03	0.19842E+00	0.29441E+00	0.58416E-01	0.26157E+00
0.69745E+03	0.19430E+00	0.29448E+00	0.57217E-01	0.25620E+00
0.69750E+03	0.19026E+00	0.29455E+00	0.56041E-01	0.25093E+00
0.69755E+03	0.18630E+00	0.29462E+00	0.54887E-01	0.24576E+00
0.69760E+03	0.18239E+00	0.29470E+00	0.53751E-01	0.24068E+00
0.69765E+03	0.17856E+00	0.29477E+00	0.52634E-01	0.23567E+00
0.69770E+03	0.17478E+00	0.29484E+00	0.51533E-01	0.23075E+00
0.69775E+03	0.17107E+00	0.29492E+00	0.50450E-01	0.22590E+00
0.69780E+03	0.16742E+00	0.29499E+00	0.49387E-01	0.22114E+00
0.69785E+03	0.16385E+00	0.29506E+00	0.48345E-01	0.21647E+00
0.69790E+03	0.16035E+00	0.29514E+00	0.47326E-01	0.21191E+00
0.69795E+03	0.15693E+00	0.29521E+00	0.46327E-01	0.20743E+00
0.69800E+03	0.15357E+00	0.29528E+00	0.45346E-01	0.20304E+00
0.69805E+03	0.15028E+00	0.29535E+00	0.44384E-01	0.19873E+00
0.69810E+03	0.14705E+00	0.29541E+00	0.43440E-01	0.19451E+00
0.69815E+03	0.14388E+00	0.29548E+00	0.42514E-01	0.19036E+00
0.69820E+03	0.14078E+00	0.29554E+00	0.41605E-01	0.18629E+00
0.69825E+03	0.13773E+00	0.29561E+00	0.40713E-01	0.18230E+00
0.69830E+03	0.13474E+00	0.29567E+00	0.39839E-01	0.17838E+00
0.69835E+03	0.13181E+00	0.29574E+00	0.38980E-01	0.17454E+00
0.69840E+03	0.12893E+00	0.29581E+00	0.38140E-01	0.17078E+00
0.69845E+03	0.12613E+00	0.29587E+00	0.37317E-01	0.16709E+00
0.69850E+03	0.12338E+00	0.29594E+00	0.36513E-01	0.16349E+00
0.69855E+03	0.12069E+00	0.29600E+00	0.35726E-01	0.15997E+00
0.69860E+03	0.11806E+00	0.29607E+00	0.34955E-01	0.15652E+00
0.69865E+03	0.11550E+00	0.29614E+00	0.34203E-01	0.15315E+00
0.69870E+03	0.11299E+00	0.29620E+00	0.33466E-01	0.14985E+00
0.69875E+03	0.11053E+00	0.29627E+00	0.32745E-01	0.14662E+00
0.69880E+03	0.10812E+00	0.29633E+00	0.32038E-01	0.14346E+00
0.69885E+03	0.10575E+00	0.29640E+00	0.31345E-01	0.14035E+00
0.69890E+03	0.10344E+00	0.29647E+00	0.30665E-01	0.13731E+00
0.69895E+03	0.10117E+00	0.29653E+00	0.30000E-01	0.13433E+00
0.69900E+03	0.98957E-01	0.29660E+00	0.29350E-01	0.13142E+00
0.69905E+03	0.96796E-01	0.29666E+00	0.28716E-01	0.12858E+00
0.69910E+03	0.94698E-01	0.29673E+00	0.28100E-01	0.12582E+00
0.69915E+03	0.92661E-01	0.29679E+00	0.27501E-01	0.12314E+00

0.69920E+03	0.90683E-01	0.29686E+00	0.26920E-01	0.12054E+00
0.69925E+03	0.88771E-01	0.29692E+00	0.26358E-01	0.11802E+00
0.69930E+03	0.86927E-01	0.29699E+00	0.25816E-01	0.11560E+00
0.69935E+03	0.85138E-01	0.29705E+00	0.25291E-01	0.11324E+00
0.69940E+03	0.83396E-01	0.29712E+00	0.24778E-01	0.11095E+00
0.69945E+03	0.81695E-01	0.29718E+00	0.24278E-01	0.10871E+00
0.69950E+03	0.80026E-01	0.29725E+00	0.23787E-01	0.10651E+00
0.69955E+03	0.78389E-01	0.29731E+00	0.23306E-01	0.10436E+00
0.69960E+03	0.76790E-01	0.29737E+00	0.22836E-01	0.10225E+00
0.69965E+03	0.75228E-01	0.29744E+00	0.22376E-01	0.10019E+00
0.69970E+03	0.73700E-01	0.29750E+00	0.21926E-01	0.98177E-01
0.69975E+03	0.72203E-01	0.29757E+00	0.21485E-01	0.96204E-01
0.69980E+03	0.70739E-01	0.29763E+00	0.21054E-01	0.94273E-01
0.69985E+03	0.69311E-01	0.29770E+00	0.20633E-01	0.92389E-01
0.69990E+03	0.67919E-01	0.29776E+00	0.20224E-01	0.90554E-01
0.69995E+03	0.66559E-01	0.29782E+00	0.19823E-01	0.88759E-01
0.70000E+03	0.65225E-01	0.29789E+00	0.19430E-01	0.86999E-01
0.70005E+03	0.63919E-01	0.29795E+00	0.19044E-01	0.85274E-01
0.70010E+03	0.62645E-01	0.29801E+00	0.18669E-01	0.83591E-01
0.70015E+03	0.61395E-01	0.29806E+00	0.18300E-01	0.81939E-01
0.70020E+03	0.60160E-01	0.29812E+00	0.17935E-01	0.80307E-01
0.70025E+03	0.58940E-01	0.29818E+00	0.17575E-01	0.78693E-01
0.70030E+03	0.57735E-01	0.29824E+00	0.17219E-01	0.77100E-01
0.70035E+03	0.56547E-01	0.29830E+00	0.16868E-01	0.75528E-01
0.70040E+03	0.55374E-01	0.29836E+00	0.16521E-01	0.73976E-01
0.70045E+03	0.54217E-01	0.29842E+00	0.16180E-01	0.72446E-01
0.70050E+03	0.53079E-01	0.29848E+00	0.15843E-01	0.70939E-01
0.70055E+03	0.51962E-01	0.29854E+00	0.15513E-01	0.69459E-01
0.70060E+03	0.50870E-01	0.29860E+00	0.15190E-01	0.68014E-01
0.70065E+03	0.49808E-01	0.29866E+00	0.14876E-01	0.66608E-01
0.70070E+03	0.48780E-01	0.29871E+00	0.14571E-01	0.65245E-01
0.70075E+03	0.47784E-01	0.29877E+00	0.14277E-01	0.63925E-01
0.70080E+03	0.46820E-01	0.29883E+00	0.13991E-01	0.62648E-01
0.70085E+03	0.45890E-01	0.29889E+00	0.13716E-01	0.61416E-01
0.70090E+03	0.45000E-01	0.29895E+00	0.13453E-01	0.60236E-01
0.70095E+03	0.44143E-01	0.29901E+00	0.13199E-01	0.59100E-01
0.70100E+03	0.43320E-01	0.29907E+00	0.12956E-01	0.58010E-01
0.70105E+03	0.42534E-01	0.29912E+00	0.12723E-01	0.56968E-01
0.70110E+03	0.41781E-01	0.29918E+00	0.12500E-01	0.55970E-01
0.70115E+03	0.41053E-01	0.29924E+00	0.12285E-01	0.55006E-01
0.70120E+03	0.40343E-01	0.29929E+00	0.12074E-01	0.54064E-01
0.70125E+03	0.39644E-01	0.29935E+00	0.11868E-01	0.53139E-01
0.70130E+03	0.38956E-01	0.29941E+00	0.11664E-01	0.52226E-01

0.70135E+03	0.38279E-01	0.29946E+00	0.11463E-01	0.51327E-01
0.70140E+03	0.37614E-01	0.29952E+00	0.11266E-01	0.50446E-01
0.70145E+03	0.36963E-01	0.29958E+00	0.11073E-01	0.49582E-01
0.70150E+03	0.36326E-01	0.29963E+00	0.10885E-01	0.48737E-01
0.70155E+03	0.35698E-01	0.29969E+00	0.10698E-01	0.47903E-01
0.70160E+03	0.35072E-01	0.29975E+00	0.10513E-01	0.47072E-01
0.70165E+03	0.34446E-01	0.29980E+00	0.10327E-01	0.46240E-01
0.70170E+03	0.33820E-01	0.29986E+00	0.10141E-01	0.45409E-01
0.70175E+03	0.33199E-01	0.29991E+00	0.99569E-02	0.44583E-01
0.70180E+03	0.32588E-01	0.29997E+00	0.97756E-02	0.43771E-01
0.70185E+03	0.31992E-01	0.30003E+00	0.95985E-02	0.42979E-01
0.70190E+03	0.31413E-01	0.30008E+00	0.94266E-02	0.42209E-01
0.70195E+03	0.30849E-01	0.30014E+00	0.92589E-02	0.41458E-01
0.70200E+03	0.30300E-01	0.30019E+00	0.90960E-02	0.40729E-01
0.70205E+03	0.29771E-01	0.30024E+00	0.89386E-02	0.40024E-01
0.70210E+03	0.29258E-01	0.30029E+00	0.87861E-02	0.39341E-01
0.70215E+03	0.28755E-01	0.30034E+00	0.86362E-02	0.38670E-01
0.70220E+03	0.28247E-01	0.30038E+00	0.84850E-02	0.37993E-01
0.70225E+03	0.27730E-01	0.30043E+00	0.83309E-02	0.37303E-01
0.70230E+03	0.27204E-01	0.30047E+00	0.81739E-02	0.36600E-01
0.70235E+03	0.26670E-01	0.30051E+00	0.80146E-02	0.35886E-01
0.70240E+03	0.26128E-01	0.30056E+00	0.78529E-02	0.35163E-01
0.70245E+03	0.25579E-01	0.30060E+00	0.76892E-02	0.34429E-01
0.70250E+03	0.25024E-01	0.30064E+00	0.75234E-02	0.33687E-01
0.70255E+03	0.24467E-01	0.30069E+00	0.73570E-02	0.32942E-01
0.70260E+03	0.23914E-01	0.30073E+00	0.71918E-02	0.32202E-01
0.70265E+03	0.23369E-01	0.30077E+00	0.70288E-02	0.31472E-01
0.70270E+03	0.22835E-01	0.30082E+00	0.68690E-02	0.30757E-01
0.70275E+03	0.22314E-01	0.30086E+00	0.67135E-02	0.30060E-01
0.70280E+03	0.21813E-01	0.30090E+00	0.65637E-02	0.29390E-01
0.70285E+03	0.21337E-01	0.30094E+00	0.64213E-02	0.28752E-01
0.70290E+03	0.20890E-01	0.30099E+00	0.62876E-02	0.28154E-01
0.70295E+03	0.20469E-01	0.30103E+00	0.61617E-02	0.27590E-01
0.70300E+03	0.20068E-01	0.30107E+00	0.60420E-02	0.27054E-01
0.70305E+03	0.19690E-01	0.30111E+00	0.59288E-02	0.26547E-01
0.70310E+03	0.19335E-01	0.30116E+00	0.58227E-02	0.26072E-01
0.70315E+03	0.19002E-01	0.30120E+00	0.57232E-02	0.25627E-01
0.70320E+03	0.18692E-01	0.30124E+00	0.56307E-02	0.25212E-01
0.70325E+03	0.18407E-01	0.30128E+00	0.55456E-02	0.24831E-01
0.70330E+03	0.18143E-01	0.30132E+00	0.54669E-02	0.24479E-01
0.70335E+03	0.17896E-01	0.30136E+00	0.53933E-02	0.24149E-01
0.70340E+03	0.17661E-01	0.30140E+00	0.53230E-02	0.23835E-01
0.70345E+03	0.17432E-01	0.30144E+00	0.52549E-02	0.23529E-01

0.70350E+03	0.17207E-01	0.30148E+00	0.51878E-02	0.23229E-01
0.70355E+03	0.16984E-01	0.30153E+00	0.51210E-02	0.22930E-01
0.70360E+03	0.16757E-01	0.30157E+00	0.50533E-02	0.22627E-01
0.70365E+03	0.16522E-01	0.30161E+00	0.49831E-02	0.22312E-01
0.70370E+03	0.16278E-01	0.30165E+00	0.49101E-02	0.21986E-01
0.70375E+03	0.16027E-01	0.30169E+00	0.48351E-02	0.21650E-01
0.70380E+03	0.15776E-01	0.30173E+00	0.47601E-02	0.21314E-01
0.70385E+03	0.15529E-01	0.30177E+00	0.46861E-02	0.20983E-01
0.70390E+03	0.15282E-01	0.30181E+00	0.46123E-02	0.20652E-01
0.70395E+03	0.15034E-01	0.30185E+00	0.45380E-02	0.20319E-01
0.70400E+03	0.14780E-01	0.30189E+00	0.44619E-02	0.19979E-01
0.70405E+03	0.14518E-01	0.30193E+00	0.43835E-02	0.19628E-01
0.70410E+03	0.14250E-01	0.30197E+00	0.43032E-02	0.19268E-01
0.70415E+03	0.13977E-01	0.30201E+00	0.42211E-02	0.18900E-01
0.70420E+03	0.13703E-01	0.30204E+00	0.41388E-02	0.18532E-01
0.70425E+03	0.13432E-01	0.30208E+00	0.40577E-02	0.18169E-01
0.70430E+03	0.13165E-01	0.30212E+00	0.39773E-02	0.17809E-01
0.70435E+03	0.12900E-01	0.30216E+00	0.38978E-02	0.17453E-01
0.70440E+03	0.12632E-01	0.30219E+00	0.38172E-02	0.17092E-01
0.70445E+03	0.12358E-01	0.30223E+00	0.37349E-02	0.16724E-01
0.70450E+03	0.12086E-01	0.30227E+00	0.36531E-02	0.16357E-01
0.70455E+03	0.11815E-01	0.30231E+00	0.35717E-02	0.15993E-01
0.70460E+03	0.11544E-01	0.30234E+00	0.34902E-02	0.15628E-01
0.70465E+03	0.11275E-01	0.30238E+00	0.34094E-02	0.15266E-01
0.70470E+03	0.11009E-01	0.30242E+00	0.33294E-02	0.14908E-01
0.70475E+03	0.10749E-01	0.30245E+00	0.32512E-02	0.14558E-01
0.70480E+03	0.10497E-01	0.30249E+00	0.31752E-02	0.14217E-01
0.70485E+03	0.10252E-01	0.30253E+00	0.31014E-02	0.13887E-01
0.70490E+03	0.10017E-01	0.30257E+00	0.30308E-02	0.13571E-01
0.70495E+03	0.97932E-02	0.30260E+00	0.29634E-02	0.13269E-01
0.70500E+03	0.95858E-02	0.30264E+00	0.29011E-02	0.12990E-01
0.70505E+03	0.93991E-02	0.30267E+00	0.28449E-02	0.12738E-01
0.70510E+03	0.92236E-02	0.30271E+00	0.27921E-02	0.12502E-01
0.70515E+03	0.90487E-02	0.30274E+00	0.27394E-02	0.12266E-01
0.70520E+03	0.88748E-02	0.30277E+00	0.26870E-02	0.12032E-01
0.70525E+03	0.87039E-02	0.30281E+00	0.26356E-02	0.11801E-01
0.70530E+03	0.85340E-02	0.30284E+00	0.25845E-02	0.11572E-01
0.70535E+03	0.83642E-02	0.30288E+00	0.25333E-02	0.11343E-01
0.70540E+03	0.81944E-02	0.30291E+00	0.24822E-02	0.11114E-01
0.70545E+03	0.80271E-02	0.30294E+00	0.24318E-02	0.10889E-01
0.70550E+03	0.78608E-02	0.30298E+00	0.23816E-02	0.10664E-01
0.70555E+03	0.76951E-02	0.30301E+00	0.23317E-02	0.10440E-01
0.70560E+03	0.75300E-02	0.30304E+00	0.22819E-02	0.10218E-01

0.70565E+03	0.73651E-02	0.30308E+00	0.22322E-02	0.99949E-02
0.70570E+03	0.72004E-02	0.30311E+00	0.21825E-02	0.97724E-02
0.70575E+03	0.70394E-02	0.30314E+00	0.21339E-02	0.95550E-02
0.70580E+03	0.68788E-02	0.30317E+00	0.20855E-02	0.93380E-02
0.70585E+03	0.67185E-02	0.30321E+00	0.20371E-02	0.91213E-02
0.70590E+03	0.65582E-02	0.30324E+00	0.19887E-02	0.89048E-02
0.70595E+03	0.63980E-02	0.30327E+00	0.19403E-02	0.86882E-02
0.70600E+03	0.62379E-02	0.30331E+00	0.18920E-02	0.84717E-02
0.70605E+03	0.60786E-02	0.30334E+00	0.18439E-02	0.82563E-02
0.70610E+03	0.59193E-02	0.30338E+00	0.17958E-02	0.80410E-02
0.70615E+03	0.57606E-02	0.30342E+00	0.17479E-02	0.78264E-02
0.70620E+03	0.56025E-02	0.30346E+00	0.17001E-02	0.76126E-02
0.70625E+03	0.54449E-02	0.30350E+00	0.16525E-02	0.73993E-02
0.70630E+03	0.52881E-02	0.30353E+00	0.16051E-02	0.71872E-02
0.70635E+03	0.51315E-02	0.30357E+00	0.15578E-02	0.69751E-02
0.70640E+03	0.49759E-02	0.30361E+00	0.15107E-02	0.67645E-02
0.70645E+03	0.48216E-02	0.30365E+00	0.14641E-02	0.65555E-02
0.70650E+03	0.46676E-02	0.30368E+00	0.14175E-02	0.63470E-02
0.70655E+03	0.45145E-02	0.30372E+00	0.13712E-02	0.61395E-02
0.70660E+03	0.43616E-02	0.30376E+00	0.13249E-02	0.59323E-02
0.70665E+03	0.42091E-02	0.30380E+00	0.12787E-02	0.57256E-02
0.70670E+03	0.40595E-02	0.30383E+00	0.12334E-02	0.55228E-02
0.70675E+03	0.39102E-02	0.30387E+00	0.11882E-02	0.53203E-02
0.70680E+03	0.37610E-02	0.30391E+00	0.11430E-02	0.51179E-02
0.70685E+03	0.36124E-02	0.30395E+00	0.10980E-02	0.49163E-02
0.70690E+03	0.34646E-02	0.30398E+00	0.10532E-02	0.47158E-02
0.70695E+03	0.33209E-02	0.30402E+00	0.10096E-02	0.45207E-02
0.70700E+03	0.31776E-02	0.30406E+00	0.96616E-03	0.43261E-02
0.70705E+03	0.30345E-02	0.30409E+00	0.92276E-03	0.41318E-02
0.70710E+03	0.28915E-02	0.30413E+00	0.87940E-03	0.39376E-02
0.70715E+03	0.27517E-02	0.30417E+00	0.83698E-03	0.37477E-02
0.70720E+03	0.26125E-02	0.30420E+00	0.79472E-03	0.35585E-02
0.70725E+03	0.24737E-02	0.30424E+00	0.75259E-03	0.33698E-02
0.70730E+03	0.23350E-02	0.30427E+00	0.71047E-03	0.31812E-02
0.70735E+03	0.21967E-02	0.30431E+00	0.66848E-03	0.29932E-02
0.70740E+03	0.20597E-02	0.30435E+00	0.62685E-03	0.28068E-02
0.70745E+03	0.19233E-02	0.30438E+00	0.58541E-03	0.26212E-02
0.70750E+03	0.17884E-02	0.30442E+00	0.54441E-03	0.24377E-02
0.70755E+03	0.16555E-02	0.30445E+00	0.50402E-03	0.22568E-02
0.70760E+03	0.15255E-02	0.30449E+00	0.46449E-03	0.20798E-02
0.70765E+03	0.13978E-02	0.30453E+00	0.42567E-03	0.19060E-02
0.70770E+03	0.12735E-02	0.30456E+00	0.38787E-03	0.17368E-02
0.70775E+03	0.11514E-02	0.30460E+00	0.35072E-03	0.15704E-02

0.70780E+03	0.10301E-02	0.30463E+00	0.31380E-03	0.14051E-02
0.70785E+03	0.91136E-03	0.30467E+00	0.27766E-03	0.12433E-02
0.70790E+03	0.79302E-03	0.30471E+00	0.24164E-03	0.10820E-02
0.70795E+03	0.67522E-03	0.30474E+00	0.20577E-03	0.92136E-03
0.70800E+03	0.56067E-03	0.30478E+00	0.17088E-03	0.76514E-03
0.70805E+03	0.44858E-03	0.30482E+00	0.13673E-03	0.61224E-03
0.70810E+03	0.33722E-03	0.30485E+00	0.10280E-03	0.46031E-03
0.70815E+03	0.22641E-03	0.30489E+00	0.69032E-04	0.30910E-03
0.70820E+03	0.11937E-03	0.30493E+00	0.36400E-04	0.16298E-03
0.70825E+03	0.12630E-04	0.30497E+00	0.38519E-05	0.17247E-04
0.70830E+03	0.00000E+00	0.30501E+00	0.00000E+00	0.00000E+00
Channel 4				
Wavenumber	HIRS Filter Transmittance	Optical Element Transmittance	Product of the HIRS Filter and Optical Element Transmittances	Normalized Value of Column 4
0.68430E+03	0.00000E+00	0.25943E+00	0.00000E+00	0.00000E+00
0.68440E+03	0.16033E-04	0.25978E+00	0.41650E-05	0.17817E-04
0.68450E+03	0.23506E-03	0.26013E+00	0.61147E-04	0.26157E-03
0.68460E+03	0.45481E-03	0.26049E+00	0.11847E-03	0.50679E-03
0.68470E+03	0.68004E-03	0.26084E+00	0.17738E-03	0.75879E-03
0.68480E+03	0.91018E-03	0.26119E+00	0.23773E-03	0.10169E-02
0.68490E+03	0.11417E-02	0.26153E+00	0.29858E-03	0.12773E-02
0.68500E+03	0.13779E-02	0.26187E+00	0.36084E-03	0.15436E-02
0.68510E+03	0.16151E-02	0.26221E+00	0.42350E-03	0.18116E-02
0.68520E+03	0.18586E-02	0.26255E+00	0.48799E-03	0.20875E-02
0.68530E+03	0.21092E-02	0.26288E+00	0.55446E-03	0.23718E-02
0.68540E+03	0.23613E-02	0.26321E+00	0.62150E-03	0.26586E-02
0.68550E+03	0.26151E-02	0.26354E+00	0.68918E-03	0.29481E-02
0.68560E+03	0.28695E-02	0.26387E+00	0.75716E-03	0.32389E-02
0.68570E+03	0.31306E-02	0.26420E+00	0.82711E-03	0.35381E-02
0.68580E+03	0.33964E-02	0.26453E+00	0.89843E-03	0.38432E-02
0.68590E+03	0.36685E-02	0.26486E+00	0.97165E-03	0.41564E-02
0.68600E+03	0.39412E-02	0.26519E+00	0.10452E-02	0.44709E-02
0.68610E+03	0.42162E-02	0.26554E+00	0.11196E-02	0.47892E-02
0.68620E+03	0.44934E-02	0.26589E+00	0.11947E-02	0.51108E-02
0.68630E+03	0.47837E-02	0.26624E+00	0.12736E-02	0.54480E-02
0.68640E+03	0.50807E-02	0.26659E+00	0.13544E-02	0.57939E-02
0.68650E+03	0.53787E-02	0.26694E+00	0.14358E-02	0.61418E-02
0.68660E+03	0.56864E-02	0.26729E+00	0.15199E-02	0.65017E-02
0.68670E+03	0.59958E-02	0.26764E+00	0.16047E-02	0.68645E-02
0.68680E+03	0.63075E-02	0.26798E+00	0.16903E-02	0.72306E-02
0.68690E+03	0.66200E-02	0.26833E+00	0.17763E-02	0.75986E-02

0.68700E+03	0.69400E-02	0.26867E+00	0.18646E-02	0.79761E-02
0.68710E+03	0.72858E-02	0.26901E+00	0.19600E-02	0.83843E-02
0.68720E+03	0.76333E-02	0.26936E+00	0.20561E-02	0.87954E-02
0.68730E+03	0.79842E-02	0.26970E+00	0.21533E-02	0.92114E-02
0.68740E+03	0.83434E-02	0.27005E+00	0.22531E-02	0.96381E-02
0.68750E+03	0.87106E-02	0.27039E+00	0.23553E-02	0.10075E-01
0.68760E+03	0.90787E-02	0.27073E+00	0.24579E-02	0.10514E-01
0.68770E+03	0.94492E-02	0.27108E+00	0.25615E-02	0.10957E-01
0.68780E+03	0.98393E-02	0.27142E+00	0.26706E-02	0.11424E-01
0.68790E+03	0.10231E-01	0.27177E+00	0.27804E-02	0.11894E-01
0.68800E+03	0.10626E-01	0.27211E+00	0.28914E-02	0.12369E-01
0.68810E+03	0.11026E-01	0.27243E+00	0.30040E-02	0.12850E-01
0.68820E+03	0.11464E-01	0.27275E+00	0.31270E-02	0.13376E-01
0.68830E+03	0.11987E-01	0.27307E+00	0.32732E-02	0.14002E-01
0.68840E+03	0.12614E-01	0.27339E+00	0.34485E-02	0.14752E-01
0.68850E+03	0.13303E-01	0.27371E+00	0.36412E-02	0.15576E-01
0.68860E+03	0.14019E-01	0.27403E+00	0.38417E-02	0.16434E-01
0.68870E+03	0.14762E-01	0.27433E+00	0.40497E-02	0.17324E-01
0.68880E+03	0.15506E-01	0.27463E+00	0.42584E-02	0.18216E-01
0.68890E+03	0.16320E-01	0.27493E+00	0.44867E-02	0.19193E-01
0.68900E+03	0.17284E-01	0.27523E+00	0.47571E-02	0.20350E-01
0.68910E+03	0.18374E-01	0.27553E+00	0.50626E-02	0.21656E-01
0.68920E+03	0.19480E-01	0.27583E+00	0.53732E-02	0.22985E-01
0.68930E+03	0.20607E-01	0.27612E+00	0.56902E-02	0.24341E-01
0.68940E+03	0.21745E-01	0.27642E+00	0.60109E-02	0.25713E-01
0.68950E+03	0.22908E-01	0.27672E+00	0.63390E-02	0.27116E-01
0.68960E+03	0.24089E-01	0.27702E+00	0.66730E-02	0.28545E-01
0.68970E+03	0.25297E-01	0.27732E+00	0.70153E-02	0.30009E-01
0.68980E+03	0.26507E-01	0.27761E+00	0.73587E-02	0.31479E-01
0.68990E+03	0.27750E-01	0.27791E+00	0.77121E-02	0.32990E-01
0.69000E+03	0.29075E-01	0.27821E+00	0.80889E-02	0.34602E-01
0.69010E+03	0.30505E-01	0.27847E+00	0.84946E-02	0.36338E-01
0.69020E+03	0.32015E-01	0.27873E+00	0.89235E-02	0.38172E-01
0.69030E+03	0.33597E-01	0.27899E+00	0.93735E-02	0.40097E-01
0.69040E+03	0.35268E-01	0.27925E+00	0.98486E-02	0.42130E-01
0.69050E+03	0.37035E-01	0.27951E+00	0.10352E-01	0.44283E-01
0.69060E+03	0.38916E-01	0.27977E+00	0.10888E-01	0.46574E-01
0.69070E+03	0.40867E-01	0.28003E+00	0.11444E-01	0.48954E-01
0.69080E+03	0.42916E-01	0.28028E+00	0.12029E-01	0.51455E-01
0.69090E+03	0.45068E-01	0.28054E+00	0.12643E-01	0.54084E-01
0.69100E+03	0.47380E-01	0.28079E+00	0.13304E-01	0.56911E-01
0.69110E+03	0.49849E-01	0.28105E+00	0.14010E-01	0.59931E-01
0.69120E+03	0.52536E-01	0.28130E+00	0.14778E-01	0.63218E-01

0.69130E+03	0.55391E-01	0.28155E+00	0.15596E-01	0.66714E-01
0.69140E+03	0.58432E-01	0.28181E+00	0.16467E-01	0.70440E-01
0.69150E+03	0.61618E-01	0.28206E+00	0.17380E-01	0.74347E-01
0.69160E+03	0.64932E-01	0.28232E+00	0.18331E-01	0.78416E-01
0.69170E+03	0.68403E-01	0.28257E+00	0.19329E-01	0.82682E-01
0.69180E+03	0.72154E-01	0.28282E+00	0.20407E-01	0.87295E-01
0.69190E+03	0.76170E-01	0.28308E+00	0.21562E-01	0.92237E-01
0.69200E+03	0.80495E-01	0.28333E+00	0.22807E-01	0.97561E-01
0.69210E+03	0.85080E-01	0.28356E+00	0.24125E-01	0.10320E+00
0.69220E+03	0.89967E-01	0.28379E+00	0.25532E-01	0.10922E+00
0.69230E+03	0.95134E-01	0.28403E+00	0.27021E-01	0.11559E+00
0.69240E+03	0.10063E+00	0.28426E+00	0.28604E-01	0.12236E+00
0.69250E+03	0.10640E+00	0.28449E+00	0.30270E-01	0.12949E+00
0.69260E+03	0.11249E+00	0.28473E+00	0.32029E-01	0.13701E+00
0.69270E+03	0.11887E+00	0.28497E+00	0.33876E-01	0.14491E+00
0.69280E+03	0.12557E+00	0.28521E+00	0.35812E-01	0.15319E+00
0.69290E+03	0.13260E+00	0.28545E+00	0.37850E-01	0.16191E+00
0.69300E+03	0.14009E+00	0.28569E+00	0.40023E-01	0.17121E+00
0.69310E+03	0.14802E+00	0.28593E+00	0.42323E-01	0.18104E+00
0.69320E+03	0.15643E+00	0.28617E+00	0.44765E-01	0.19149E+00
0.69330E+03	0.16530E+00	0.28641E+00	0.47342E-01	0.20252E+00
0.69340E+03	0.17461E+00	0.28665E+00	0.50051E-01	0.21410E+00
0.69350E+03	0.18436E+00	0.28688E+00	0.52891E-01	0.22625E+00
0.69360E+03	0.19457E+00	0.28712E+00	0.55864E-01	0.23897E+00
0.69370E+03	0.20522E+00	0.28736E+00	0.58971E-01	0.25226E+00
0.69380E+03	0.21633E+00	0.28760E+00	0.62218E-01	0.26615E+00
0.69390E+03	0.22796E+00	0.28784E+00	0.65618E-01	0.28069E+00
0.69400E+03	0.24014E+00	0.28808E+00	0.69181E-01	0.29594E+00
0.69410E+03	0.25283E+00	0.28829E+00	0.72890E-01	0.31180E+00
0.69420E+03	0.26603E+00	0.28851E+00	0.76750E-01	0.32832E+00
0.69430E+03	0.27971E+00	0.28872E+00	0.80759E-01	0.34546E+00
0.69440E+03	0.29386E+00	0.28893E+00	0.84908E-01	0.36321E+00
0.69450E+03	0.30841E+00	0.28915E+00	0.89175E-01	0.38147E+00
0.69460E+03	0.32331E+00	0.28936E+00	0.93553E-01	0.40019E+00
0.69470E+03	0.33853E+00	0.28957E+00	0.98030E-01	0.41934E+00
0.69480E+03	0.35406E+00	0.28979E+00	0.10260E+00	0.43890E+00
0.69490E+03	0.36983E+00	0.29000E+00	0.10725E+00	0.45879E+00
0.69500E+03	0.38582E+00	0.29021E+00	0.11197E+00	0.47898E+00
0.69510E+03	0.40196E+00	0.29043E+00	0.11674E+00	0.49939E+00
0.69520E+03	0.41822E+00	0.29064E+00	0.12155E+00	0.51996E+00
0.69530E+03	0.43448E+00	0.29085E+00	0.12637E+00	0.54057E+00
0.69540E+03	0.45069E+00	0.29106E+00	0.13118E+00	0.56114E+00
0.69550E+03	0.46675E+00	0.29127E+00	0.13595E+00	0.58156E+00

0.69560E+03	0.48261E+00	0.29148E+00	0.14067E+00	0.60175E+00
0.69570E+03	0.49825E+00	0.29170E+00	0.14534E+00	0.62171E+00
0.69580E+03	0.51367E+00	0.29191E+00	0.14994E+00	0.64141E+00
0.69590E+03	0.52876E+00	0.29212E+00	0.15446E+00	0.66074E+00
0.69600E+03	0.54356E+00	0.29233E+00	0.15890E+00	0.67972E+00
0.69610E+03	0.55799E+00	0.29248E+00	0.16320E+00	0.69813E+00
0.69620E+03	0.57207E+00	0.29263E+00	0.16740E+00	0.71611E+00
0.69630E+03	0.58571E+00	0.29278E+00	0.17148E+00	0.73356E+00
0.69640E+03	0.59894E+00	0.29293E+00	0.17545E+00	0.75050E+00
0.69650E+03	0.61164E+00	0.29308E+00	0.17926E+00	0.76682E+00
0.69660E+03	0.62375E+00	0.29323E+00	0.18290E+00	0.78240E+00
0.69670E+03	0.63519E+00	0.29338E+00	0.18635E+00	0.79715E+00
0.69680E+03	0.64593E+00	0.29352E+00	0.18960E+00	0.81104E+00
0.69690E+03	0.65600E+00	0.29367E+00	0.19265E+00	0.82410E+00
0.69700E+03	0.66543E+00	0.29382E+00	0.19552E+00	0.83637E+00
0.69710E+03	0.67421E+00	0.29397E+00	0.19820E+00	0.84783E+00
0.69720E+03	0.68242E+00	0.29411E+00	0.20071E+00	0.85857E+00
0.69730E+03	0.68999E+00	0.29426E+00	0.20304E+00	0.86854E+00
0.69740E+03	0.69695E+00	0.29441E+00	0.20519E+00	0.87772E+00
0.69750E+03	0.70326E+00	0.29455E+00	0.20715E+00	0.88611E+00
0.69760E+03	0.70894E+00	0.29470E+00	0.20892E+00	0.89372E+00
0.69770E+03	0.71402E+00	0.29484E+00	0.21053E+00	0.90057E+00
0.69780E+03	0.71852E+00	0.29499E+00	0.21195E+00	0.90668E+00
0.69790E+03	0.72245E+00	0.29514E+00	0.21322E+00	0.91209E+00
0.69800E+03	0.72586E+00	0.29528E+00	0.21433E+00	0.91686E+00
0.69810E+03	0.72881E+00	0.29541E+00	0.21530E+00	0.92099E+00
0.69820E+03	0.73141E+00	0.29554E+00	0.21616E+00	0.92468E+00
0.69830E+03	0.73368E+00	0.29567E+00	0.21693E+00	0.92796E+00
0.69840E+03	0.73565E+00	0.29581E+00	0.21761E+00	0.93088E+00
0.69850E+03	0.73738E+00	0.29594E+00	0.21822E+00	0.93348E+00
0.69860E+03	0.73887E+00	0.29607E+00	0.21876E+00	0.93578E+00
0.69870E+03	0.74016E+00	0.29620E+00	0.21924E+00	0.93784E+00
0.69880E+03	0.74129E+00	0.29633E+00	0.21967E+00	0.93968E+00
0.69890E+03	0.74229E+00	0.29647E+00	0.22006E+00	0.94137E+00
0.69900E+03	0.74322E+00	0.29660E+00	0.22044E+00	0.94297E+00
0.69910E+03	0.74409E+00	0.29673E+00	0.22079E+00	0.94449E+00
0.69920E+03	0.74492E+00	0.29686E+00	0.22114E+00	0.94596E+00
0.69930E+03	0.74572E+00	0.29699E+00	0.22147E+00	0.94738E+00
0.69940E+03	0.74645E+00	0.29712E+00	0.22178E+00	0.94872E+00
0.69950E+03	0.74714E+00	0.29725E+00	0.22209E+00	0.95002E+00
0.69960E+03	0.74778E+00	0.29737E+00	0.22237E+00	0.95124E+00
0.69970E+03	0.74837E+00	0.29750E+00	0.22264E+00	0.95241E+00
0.69980E+03	0.74890E+00	0.29763E+00	0.22290E+00	0.95349E+00

0.69990E+03	0.74944E+00	0.29776E+00	0.22315E+00	0.95459E+00
0.70000E+03	0.75003E+00	0.29789E+00	0.22343E+00	0.95575E+00
0.70010E+03	0.75068E+00	0.29801E+00	0.22371E+00	0.95696E+00
0.70020E+03	0.75146E+00	0.29812E+00	0.22403E+00	0.95833E+00
0.70030E+03	0.75237E+00	0.29824E+00	0.22439E+00	0.95987E+00
0.70040E+03	0.75338E+00	0.29836E+00	0.22478E+00	0.96154E+00
0.70050E+03	0.75442E+00	0.29848E+00	0.22518E+00	0.96325E+00
0.70060E+03	0.75541E+00	0.29860E+00	0.22556E+00	0.96489E+00
0.70070E+03	0.75637E+00	0.29871E+00	0.22594E+00	0.96650E+00
0.70080E+03	0.75726E+00	0.29883E+00	0.22629E+00	0.96801E+00
0.70090E+03	0.75810E+00	0.29895E+00	0.22663E+00	0.96948E+00
0.70100E+03	0.75891E+00	0.29907E+00	0.22696E+00	0.97089E+00
0.70110E+03	0.75974E+00	0.29918E+00	0.22730E+00	0.97233E+00
0.70120E+03	0.76068E+00	0.29929E+00	0.22767E+00	0.97390E+00
0.70130E+03	0.76172E+00	0.29941E+00	0.22806E+00	0.97559E+00
0.70140E+03	0.76286E+00	0.29952E+00	0.22849E+00	0.97743E+00
0.70150E+03	0.76408E+00	0.29963E+00	0.22895E+00	0.97936E+00
0.70160E+03	0.76532E+00	0.29975E+00	0.22940E+00	0.98131E+00
0.70170E+03	0.76652E+00	0.29986E+00	0.22985E+00	0.98322E+00
0.70180E+03	0.76767E+00	0.29997E+00	0.23028E+00	0.98506E+00
0.70190E+03	0.76877E+00	0.30008E+00	0.23069E+00	0.98684E+00
0.70200E+03	0.76982E+00	0.30019E+00	0.23109E+00	0.98856E+00
0.70210E+03	0.77084E+00	0.30029E+00	0.23148E+00	0.99019E+00
0.70220E+03	0.77180E+00	0.30038E+00	0.23183E+00	0.99172E+00
0.70230E+03	0.77267E+00	0.30047E+00	0.23217E+00	0.99314E+00
0.70240E+03	0.77345E+00	0.30056E+00	0.23247E+00	0.99443E+00
0.70250E+03	0.77413E+00	0.30064E+00	0.23274E+00	0.99558E+00
0.70260E+03	0.77468E+00	0.30073E+00	0.23297E+00	0.99658E+00
0.70270E+03	0.77513E+00	0.30082E+00	0.23317E+00	0.99744E+00
0.70280E+03	0.77552E+00	0.30090E+00	0.23336E+00	0.99823E+00
0.70290E+03	0.77585E+00	0.30099E+00	0.23352E+00	0.99893E+00
0.70300E+03	0.77606E+00	0.30107E+00	0.23365E+00	0.99950E+00
0.70310E+03	0.77614E+00	0.30116E+00	0.23374E+00	0.99986E+00
0.70320E+03	0.77603E+00	0.30124E+00	0.23377E+00	0.10000E+01
0.70330E+03	0.77573E+00	0.30132E+00	0.23374E+00	0.99989E+00
0.70340E+03	0.77526E+00	0.30140E+00	0.23366E+00	0.99955E+00
0.70350E+03	0.77458E+00	0.30148E+00	0.23352E+00	0.99895E+00
0.70360E+03	0.77367E+00	0.30157E+00	0.23331E+00	0.99804E+00
0.70370E+03	0.77250E+00	0.30165E+00	0.23302E+00	0.99680E+00
0.70380E+03	0.77105E+00	0.30173E+00	0.23265E+00	0.99521E+00
0.70390E+03	0.76935E+00	0.30181E+00	0.23220E+00	0.99328E+00
0.70400E+03	0.76741E+00	0.30189E+00	0.23168E+00	0.99105E+00
0.70410E+03	0.76528E+00	0.30197E+00	0.23109E+00	0.98854E+00

0.70420E+03	0.76300E+00	0.30204E+00	0.23046E+00	0.98584E+00
0.70430E+03	0.76058E+00	0.30212E+00	0.22978E+00	0.98295E+00
0.70440E+03	0.75798E+00	0.30219E+00	0.22906E+00	0.97984E+00
0.70450E+03	0.75522E+00	0.30227E+00	0.22828E+00	0.97652E+00
0.70460E+03	0.75226E+00	0.30234E+00	0.22744E+00	0.97293E+00
0.70470E+03	0.74911E+00	0.30242E+00	0.22654E+00	0.96908E+00
0.70480E+03	0.74574E+00	0.30249E+00	0.22558E+00	0.96496E+00
0.70490E+03	0.74219E+00	0.30257E+00	0.22456E+00	0.96060E+00
0.70500E+03	0.73844E+00	0.30264E+00	0.22348E+00	0.95599E+00
0.70510E+03	0.73455E+00	0.30271E+00	0.22235E+00	0.95116E+00
0.70520E+03	0.73054E+00	0.30277E+00	0.22119E+00	0.94619E+00
0.70530E+03	0.72644E+00	0.30284E+00	0.22000E+00	0.94108E+00
0.70540E+03	0.72219E+00	0.30291E+00	0.21876E+00	0.93579E+00
0.70550E+03	0.71780E+00	0.30298E+00	0.21747E+00	0.93029E+00
0.70560E+03	0.71323E+00	0.30304E+00	0.21614E+00	0.92458E+00
0.70570E+03	0.70854E+00	0.30311E+00	0.21476E+00	0.91870E+00
0.70580E+03	0.70372E+00	0.30317E+00	0.21335E+00	0.91265E+00
0.70590E+03	0.69877E+00	0.30324E+00	0.21189E+00	0.90642E+00
0.70600E+03	0.69367E+00	0.30331E+00	0.21039E+00	0.90001E+00
0.70610E+03	0.68841E+00	0.30338E+00	0.20885E+00	0.89341E+00
0.70620E+03	0.68295E+00	0.30346E+00	0.20725E+00	0.88655E+00
0.70630E+03	0.67732E+00	0.30353E+00	0.20559E+00	0.87946E+00
0.70640E+03	0.67153E+00	0.30361E+00	0.20388E+00	0.87216E+00
0.70650E+03	0.66560E+00	0.30368E+00	0.20213E+00	0.86467E+00
0.70660E+03	0.65953E+00	0.30376E+00	0.20034E+00	0.85699E+00
0.70670E+03	0.65332E+00	0.30383E+00	0.19850E+00	0.84913E+00
0.70680E+03	0.64695E+00	0.30391E+00	0.19661E+00	0.84106E+00
0.70690E+03	0.64038E+00	0.30398E+00	0.19466E+00	0.83271E+00
0.70700E+03	0.63356E+00	0.30406E+00	0.19264E+00	0.82405E+00
0.70710E+03	0.62654E+00	0.30413E+00	0.19055E+00	0.81512E+00
0.70720E+03	0.61933E+00	0.30420E+00	0.18840E+00	0.80593E+00
0.70730E+03	0.61199E+00	0.30427E+00	0.18621E+00	0.79656E+00
0.70740E+03	0.60453E+00	0.30435E+00	0.18399E+00	0.78704E+00
0.70750E+03	0.59694E+00	0.30442E+00	0.18172E+00	0.77735E+00
0.70760E+03	0.58924E+00	0.30449E+00	0.17942E+00	0.76750E+00
0.70770E+03	0.58143E+00	0.30456E+00	0.17708E+00	0.75750E+00
0.70780E+03	0.57351E+00	0.30463E+00	0.17471E+00	0.74736E+00
0.70790E+03	0.56547E+00	0.30471E+00	0.17230E+00	0.73706E+00
0.70800E+03	0.55730E+00	0.30478E+00	0.16985E+00	0.72657E+00
0.70810E+03	0.54897E+00	0.30485E+00	0.16736E+00	0.71590E+00
0.70820E+03	0.54048E+00	0.30493E+00	0.16481E+00	0.70500E+00
0.70830E+03	0.53184E+00	0.30501E+00	0.16222E+00	0.69392E+00
0.70840E+03	0.52305E+00	0.30509E+00	0.15957E+00	0.68262E+00

0.70850E+03	0.51413E+00	0.30516E+00	0.15689E+00	0.67114E+00
0.70860E+03	0.50508E+00	0.30524E+00	0.15417E+00	0.65949E+00
0.70870E+03	0.49593E+00	0.30532E+00	0.15142E+00	0.64772E+00
0.70880E+03	0.48667E+00	0.30539E+00	0.14863E+00	0.63578E+00
0.70890E+03	0.47730E+00	0.30547E+00	0.14580E+00	0.62370E+00
0.70900E+03	0.46780E+00	0.30555E+00	0.14294E+00	0.61144E+00
0.70910E+03	0.45820E+00	0.30562E+00	0.14004E+00	0.59903E+00
0.70920E+03	0.44844E+00	0.30570E+00	0.13709E+00	0.58642E+00
0.70930E+03	0.43855E+00	0.30577E+00	0.13410E+00	0.57363E+00
0.70940E+03	0.42853E+00	0.30585E+00	0.13107E+00	0.56067E+00
0.70950E+03	0.41847E+00	0.30593E+00	0.12802E+00	0.54764E+00
0.70960E+03	0.40840E+00	0.30600E+00	0.12497E+00	0.53459E+00
0.70970E+03	0.39834E+00	0.30608E+00	0.12192E+00	0.52155E+00
0.70980E+03	0.38829E+00	0.30615E+00	0.11888E+00	0.50852E+00
0.70990E+03	0.37828E+00	0.30622E+00	0.11584E+00	0.49553E+00
0.71000E+03	0.36824E+00	0.30629E+00	0.11279E+00	0.48249E+00
0.71010E+03	0.35820E+00	0.30637E+00	0.10974E+00	0.46945E+00
0.71020E+03	0.34817E+00	0.30645E+00	0.10670E+00	0.45642E+00
0.71030E+03	0.33821E+00	0.30653E+00	0.10367E+00	0.44347E+00
0.71040E+03	0.32831E+00	0.30660E+00	0.10066E+00	0.43061E+00
0.71050E+03	0.31852E+00	0.30668E+00	0.97683E-01	0.41786E+00
0.71060E+03	0.30883E+00	0.30676E+00	0.94738E-01	0.40526E+00
0.71070E+03	0.29926E+00	0.30684E+00	0.91824E-01	0.39279E+00
0.71080E+03	0.28976E+00	0.30691E+00	0.88931E-01	0.38042E+00
0.71090E+03	0.28036E+00	0.30699E+00	0.86067E-01	0.36817E+00
0.71100E+03	0.27104E+00	0.30707E+00	0.83228E-01	0.35602E+00
0.71110E+03	0.26182E+00	0.30714E+00	0.80417E-01	0.34400E+00
0.71120E+03	0.25268E+00	0.30722E+00	0.77628E-01	0.33207E+00
0.71130E+03	0.24364E+00	0.30729E+00	0.74869E-01	0.32027E+00
0.71140E+03	0.23474E+00	0.30737E+00	0.72151E-01	0.30864E+00
0.71150E+03	0.22603E+00	0.30744E+00	0.69490E-01	0.29726E+00
0.71160E+03	0.21754E+00	0.30752E+00	0.66897E-01	0.28617E+00
0.71170E+03	0.20930E+00	0.30759E+00	0.64379E-01	0.27539E+00
0.71180E+03	0.20132E+00	0.30767E+00	0.61939E-01	0.26496E+00
0.71190E+03	0.19359E+00	0.30774E+00	0.59573E-01	0.25484E+00
0.71200E+03	0.18603E+00	0.30781E+00	0.57261E-01	0.24495E+00
0.71210E+03	0.17866E+00	0.30789E+00	0.55006E-01	0.23530E+00
0.71220E+03	0.17149E+00	0.30796E+00	0.52814E-01	0.22592E+00
0.71230E+03	0.16457E+00	0.30804E+00	0.50696E-01	0.21686E+00
0.71240E+03	0.15789E+00	0.30812E+00	0.48650E-01	0.20811E+00
0.71250E+03	0.15146E+00	0.30820E+00	0.46681E-01	0.19969E+00
0.71260E+03	0.14531E+00	0.30828E+00	0.44796E-01	0.19163E+00
0.71270E+03	0.13943E+00	0.30836E+00	0.42993E-01	0.18391E+00

0.71280E+03	0.13378E+00	0.30843E+00	0.41261E-01	0.17650E+00
0.71290E+03	0.12834E+00	0.30851E+00	0.39594E-01	0.16937E+00
0.71300E+03	0.12308E+00	0.30859E+00	0.37981E-01	0.16247E+00
0.71310E+03	0.11796E+00	0.30867E+00	0.36410E-01	0.15575E+00
0.71320E+03	0.11293E+00	0.30875E+00	0.34868E-01	0.14915E+00
0.71330E+03	0.10803E+00	0.30882E+00	0.33362E-01	0.14271E+00
0.71340E+03	0.10328E+00	0.30890E+00	0.31905E-01	0.13648E+00
0.71350E+03	0.98707E-01	0.30898E+00	0.30498E-01	0.13046E+00
0.71360E+03	0.94326E-01	0.30905E+00	0.29152E-01	0.12470E+00
0.71370E+03	0.90145E-01	0.30913E+00	0.27867E-01	0.11921E+00
0.71380E+03	0.86179E-01	0.30921E+00	0.26648E-01	0.11399E+00
0.71390E+03	0.82379E-01	0.30929E+00	0.25479E-01	0.10899E+00
0.71400E+03	0.78712E-01	0.30937E+00	0.24351E-01	0.10417E+00
0.71410E+03	0.75180E-01	0.30945E+00	0.23264E-01	0.99518E-01
0.71420E+03	0.71781E-01	0.30954E+00	0.22219E-01	0.95045E-01
0.71430E+03	0.68500E-01	0.30962E+00	0.21209E-01	0.90726E-01
0.71440E+03	0.65330E-01	0.30970E+00	0.20233E-01	0.86551E-01
0.71450E+03	0.62274E-01	0.30979E+00	0.19292E-01	0.82525E-01
0.71460E+03	0.59358E-01	0.30987E+00	0.18393E-01	0.78682E-01
0.71470E+03	0.56569E-01	0.30996E+00	0.17534E-01	0.75005E-01
0.71480E+03	0.53896E-01	0.31004E+00	0.16710E-01	0.71481E-01
0.71490E+03	0.51321E-01	0.31012E+00	0.15916E-01	0.68083E-01
0.71500E+03	0.48819E-01	0.31021E+00	0.15144E-01	0.64782E-01
0.71510E+03	0.46389E-01	0.31029E+00	0.14394E-01	0.61574E-01
0.71520E+03	0.44048E-01	0.31037E+00	0.13671E-01	0.58482E-01
0.71530E+03	0.41832E-01	0.31045E+00	0.12987E-01	0.55554E-01
0.71540E+03	0.39773E-01	0.31054E+00	0.12351E-01	0.52834E-01
0.71550E+03	0.37868E-01	0.31062E+00	0.11762E-01	0.50316E-01
0.71560E+03	0.36156E-01	0.31070E+00	0.11234E-01	0.48054E-01
0.71570E+03	0.34621E-01	0.31078E+00	0.10760E-01	0.46027E-01
0.71580E+03	0.33275E-01	0.31086E+00	0.10344E-01	0.44247E-01
0.71590E+03	0.32054E-01	0.31094E+00	0.99669E-02	0.42636E-01
0.71600E+03	0.30866E-01	0.31102E+00	0.95999E-02	0.41066E-01
0.71610E+03	0.29709E-01	0.31110E+00	0.92424E-02	0.39536E-01
0.71620E+03	0.28581E-01	0.31118E+00	0.88938E-02	0.38045E-01
0.71630E+03	0.27464E-01	0.31126E+00	0.85485E-02	0.36568E-01
0.71640E+03	0.26363E-01	0.31134E+00	0.82080E-02	0.35112E-01
0.71650E+03	0.25301E-01	0.31142E+00	0.78793E-02	0.33706E-01
0.71660E+03	0.24329E-01	0.31151E+00	0.75786E-02	0.32419E-01
0.71670E+03	0.23434E-01	0.31159E+00	0.73016E-02	0.31234E-01
0.71680E+03	0.22598E-01	0.31167E+00	0.70431E-02	0.30128E-01
0.71690E+03	0.21766E-01	0.31175E+00	0.67856E-02	0.29027E-01
0.71700E+03	0.20943E-01	0.31183E+00	0.65306E-02	0.27936E-01

0.71710E+03	0.20123E-01	0.31191E+00	0.62765E-02	0.26849E-01
0.71720E+03	0.19312E-01	0.31199E+00	0.60253E-02	0.25774E-01
0.71730E+03	0.18513E-01	0.31207E+00	0.57775E-02	0.24715E-01
0.71740E+03	0.17716E-01	0.31215E+00	0.55302E-02	0.23656E-01
0.71750E+03	0.16939E-01	0.31223E+00	0.52890E-02	0.22625E-01
0.71760E+03	0.16183E-01	0.31232E+00	0.50543E-02	0.21621E-01
0.71770E+03	0.15428E-01	0.31241E+00	0.48200E-02	0.20618E-01
0.71780E+03	0.14684E-01	0.31251E+00	0.45888E-02	0.19630E-01
0.71790E+03	0.13946E-01	0.31261E+00	0.43595E-02	0.18649E-01
0.71800E+03	0.13211E-01	0.31270E+00	0.41313E-02	0.17672E-01
0.71810E+03	0.12498E-01	0.31280E+00	0.39094E-02	0.16723E-01
0.71820E+03	0.11827E-01	0.31290E+00	0.37008E-02	0.15831E-01
0.71830E+03	0.11199E-01	0.31300E+00	0.35053E-02	0.14994E-01
0.71840E+03	0.10612E-01	0.31310E+00	0.33227E-02	0.14213E-01
0.71850E+03	0.10068E-01	0.31319E+00	0.31531E-02	0.13488E-01
0.71860E+03	0.95723E-02	0.31329E+00	0.29989E-02	0.12828E-01
0.71870E+03	0.90807E-02	0.31339E+00	0.28458E-02	0.12173E-01
0.71880E+03	0.85893E-02	0.31349E+00	0.26926E-02	0.11518E-01
0.71890E+03	0.81232E-02	0.31358E+00	0.25473E-02	0.10897E-01
0.71900E+03	0.76623E-02	0.31368E+00	0.24035E-02	0.10282E-01
0.71910E+03	0.72057E-02	0.31378E+00	0.22610E-02	0.96719E-02
0.71920E+03	0.67506E-02	0.31387E+00	0.21188E-02	0.90638E-02
0.71930E+03	0.63361E-02	0.31397E+00	0.19894E-02	0.85099E-02
0.71940E+03	0.59810E-02	0.31407E+00	0.18785E-02	0.80355E-02
0.71950E+03	0.56925E-02	0.31417E+00	0.17884E-02	0.76503E-02
0.71960E+03	0.54110E-02	0.31429E+00	0.17006E-02	0.72747E-02
0.71970E+03	0.51335E-02	0.31441E+00	0.16140E-02	0.69043E-02
0.71980E+03	0.48628E-02	0.31453E+00	0.15295E-02	0.65427E-02
0.71990E+03	0.45985E-02	0.31465E+00	0.14469E-02	0.61895E-02
0.72000E+03	0.43528E-02	0.31477E+00	0.13701E-02	0.58611E-02
0.72010E+03	0.41097E-02	0.31489E+00	0.12941E-02	0.55358E-02
0.72020E+03	0.38807E-02	0.31501E+00	0.12225E-02	0.52293E-02
0.72030E+03	0.36556E-02	0.31512E+00	0.11520E-02	0.49277E-02
0.72040E+03	0.34582E-02	0.31524E+00	0.10902E-02	0.46634E-02
0.72050E+03	0.32732E-02	0.31536E+00	0.10322E-02	0.44155E-02
0.72060E+03	0.30907E-02	0.31547E+00	0.97503E-03	0.41709E-02
0.72070E+03	0.29136E-02	0.31559E+00	0.91949E-03	0.39333E-02
0.72080E+03	0.27490E-02	0.31571E+00	0.86789E-03	0.37126E-02
0.72090E+03	0.26027E-02	0.31582E+00	0.82198E-03	0.35162E-02
0.72100E+03	0.24623E-02	0.31594E+00	0.77795E-03	0.33278E-02
0.72110E+03	0.23349E-02	0.31606E+00	0.73796E-03	0.31568E-02
0.72120E+03	0.22077E-02	0.31618E+00	0.69801E-03	0.29859E-02
0.72130E+03	0.20816E-02	0.31629E+00	0.65838E-03	0.28164E-02

0.72140E+03	0.19609E-02	0.31641E+00	0.62043E-03	0.26540E-02
0.72150E+03	0.18409E-02	0.31654E+00	0.58270E-03	0.24926E-02
0.72160E+03	0.17260E-02	0.31666E+00	0.54655E-03	0.23380E-02
0.72170E+03	0.16123E-02	0.31679E+00	0.51076E-03	0.21849E-02
0.72180E+03	0.15011E-02	0.31692E+00	0.47574E-03	0.20351E-02
0.72190E+03	0.13953E-02	0.31705E+00	0.44239E-03	0.18924E-02
0.72200E+03	0.12960E-02	0.31718E+00	0.41106E-03	0.17584E-02
0.72210E+03	0.11986E-02	0.31731E+00	0.38033E-03	0.16269E-02
0.72220E+03	0.11020E-02	0.31745E+00	0.34984E-03	0.14965E-02
0.72230E+03	0.10076E-02	0.31758E+00	0.32001E-03	0.13689E-02
0.72240E+03	0.91341E-03	0.31771E+00	0.29020E-03	0.12414E-02
0.72250E+03	0.82434E-03	0.31785E+00	0.26202E-03	0.11208E-02
0.72260E+03	0.73710E-03	0.31798E+00	0.23438E-03	0.10026E-02
0.72270E+03	0.65187E-03	0.31811E+00	0.20737E-03	0.88707E-03
0.72280E+03	0.57136E-03	0.31825E+00	0.18183E-03	0.77783E-03
0.72290E+03	0.49261E-03	0.31838E+00	0.15684E-03	0.67090E-03
0.72300E+03	0.41626E-03	0.31851E+00	0.13258E-03	0.56716E-03
0.72310E+03	0.34478E-03	0.31865E+00	0.10986E-03	0.46996E-03
0.72320E+03	0.27558E-03	0.31878E+00	0.87849E-04	0.37579E-03
0.72330E+03	0.21423E-03	0.31891E+00	0.68321E-04	0.29226E-03
0.72340E+03	0.15373E-03	0.31905E+00	0.49048E-04	0.20981E-03
0.72350E+03	0.93794E-04	0.31919E+00	0.29938E-04	0.12807E-03
0.72360E+03	0.34417E-04	0.31933E+00	0.10990E-04	0.47013E-04
0.72370E+03	0.00000E+00	0.31947E+00	0.00000E+00	0.00000E+00
Channel 5				
Wavenumber	HIRS Filter Transmittance	Optical Element Transmittance	Product of the HIRS Filter and Optical Element Transmittances	Normalized Value of Column 4
0.69580E+03	0.00000E+00	0.29191E+00	0.00000E+00	0.00000E+00
0.69590E+03	0.55605E-04	0.29212E+00	0.16243E-04	0.72389E-04
0.69600E+03	0.15033E-03	0.29233E+00	0.43947E-04	0.19585E-03
0.69610E+03	0.26200E-03	0.29248E+00	0.76629E-04	0.34150E-03
0.69620E+03	0.38610E-03	0.29263E+00	0.11299E-03	0.50353E-03
0.69630E+03	0.52022E-03	0.29278E+00	0.15231E-03	0.67878E-03
0.69640E+03	0.66194E-03	0.29293E+00	0.19390E-03	0.86413E-03
0.69650E+03	0.80542E-03	0.29308E+00	0.23605E-03	0.10520E-02
0.69660E+03	0.95600E-03	0.29323E+00	0.28033E-03	0.12493E-02
0.69670E+03	0.11105E-02	0.29338E+00	0.32579E-03	0.14519E-02
0.69680E+03	0.12830E-02	0.29352E+00	0.37660E-03	0.16783E-02
0.69690E+03	0.14596E-02	0.29367E+00	0.42864E-03	0.19103E-02
0.69700E+03	0.16701E-02	0.29382E+00	0.49070E-03	0.21869E-02
0.69710E+03	0.18822E-02	0.29397E+00	0.55331E-03	0.24659E-02

0.69720E+03	0.21007E-02	0.29411E+00	0.61784E-03	0.27535E-02
0.69730E+03	0.23241E-02	0.29426E+00	0.68389E-03	0.30478E-02
0.69740E+03	0.25489E-02	0.29441E+00	0.75040E-03	0.33442E-02
0.69750E+03	0.27751E-02	0.29455E+00	0.81742E-03	0.36429E-02
0.69760E+03	0.30024E-02	0.29470E+00	0.88481E-03	0.39432E-02
0.69770E+03	0.32384E-02	0.29484E+00	0.95483E-03	0.42553E-02
0.69780E+03	0.34809E-02	0.29499E+00	0.10268E-02	0.45761E-02
0.69790E+03	0.37244E-02	0.29514E+00	0.10992E-02	0.48986E-02
0.69800E+03	0.39690E-02	0.29528E+00	0.11720E-02	0.52229E-02
0.69810E+03	0.42186E-02	0.29541E+00	0.12462E-02	0.55539E-02
0.69820E+03	0.44683E-02	0.29554E+00	0.13206E-02	0.58852E-02
0.69830E+03	0.47236E-02	0.29567E+00	0.13967E-02	0.62243E-02
0.69840E+03	0.49795E-02	0.29581E+00	0.14730E-02	0.65643E-02
0.69850E+03	0.52354E-02	0.29594E+00	0.15493E-02	0.69048E-02
0.69860E+03	0.54927E-02	0.29607E+00	0.16262E-02	0.72474E-02
0.69870E+03	0.57530E-02	0.29620E+00	0.17041E-02	0.75943E-02
0.69880E+03	0.60175E-02	0.29633E+00	0.17832E-02	0.79469E-02
0.69890E+03	0.62836E-02	0.29647E+00	0.18629E-02	0.83020E-02
0.69900E+03	0.65533E-02	0.29660E+00	0.19437E-02	0.86622E-02
0.69910E+03	0.68349E-02	0.29673E+00	0.20281E-02	0.90384E-02
0.69920E+03	0.71296E-02	0.29686E+00	0.21165E-02	0.94323E-02
0.69930E+03	0.74400E-02	0.29699E+00	0.22096E-02	0.98472E-02
0.69940E+03	0.77856E-02	0.29712E+00	0.23132E-02	0.10309E-01
0.69950E+03	0.81350E-02	0.29725E+00	0.24181E-02	0.10776E-01
0.69960E+03	0.84972E-02	0.29737E+00	0.25268E-02	0.11261E-01
0.69970E+03	0.88726E-02	0.29750E+00	0.26396E-02	0.11764E-01
0.69980E+03	0.92614E-02	0.29763E+00	0.27565E-02	0.12284E-01
0.69990E+03	0.96574E-02	0.29776E+00	0.28756E-02	0.12815E-01
0.70000E+03	0.10056E-01	0.29789E+00	0.29957E-02	0.13350E-01
0.70010E+03	0.10242E-01	0.29801E+00	0.30521E-02	0.13602E-01
0.70020E+03	0.10466E-01	0.29812E+00	0.31200E-02	0.13905E-01
0.70030E+03	0.10838E-01	0.29824E+00	0.32323E-02	0.14405E-01
0.70040E+03	0.11311E-01	0.29836E+00	0.33749E-02	0.15040E-01
0.70050E+03	0.11847E-01	0.29848E+00	0.35360E-02	0.15759E-01
0.70060E+03	0.12433E-01	0.29860E+00	0.37123E-02	0.16544E-01
0.70070E+03	0.13092E-01	0.29871E+00	0.39108E-02	0.17429E-01
0.70080E+03	0.13793E-01	0.29883E+00	0.41217E-02	0.18369E-01
0.70090E+03	0.14469E-01	0.29895E+00	0.43255E-02	0.19277E-01
0.70100E+03	0.15148E-01	0.29907E+00	0.45303E-02	0.20190E-01
0.70110E+03	0.15845E-01	0.29918E+00	0.47406E-02	0.21127E-01
0.70120E+03	0.16547E-01	0.29929E+00	0.49524E-02	0.22071E-01
0.70130E+03	0.17231E-01	0.29941E+00	0.51592E-02	0.22992E-01
0.70140E+03	0.17933E-01	0.29952E+00	0.53713E-02	0.23937E-01

0.70150E+03	0.18741E-01	0.29963E+00	0.56153E-02	0.25025E-01
0.70160E+03	0.19632E-01	0.29975E+00	0.58848E-02	0.26226E-01
0.70170E+03	0.20566E-01	0.29986E+00	0.61669E-02	0.27483E-01
0.70180E+03	0.21502E-01	0.29997E+00	0.64499E-02	0.28745E-01
0.70190E+03	0.22404E-01	0.30008E+00	0.67229E-02	0.29961E-01
0.70200E+03	0.23291E-01	0.30019E+00	0.69919E-02	0.31160E-01
0.70210E+03	0.24203E-01	0.30029E+00	0.72680E-02	0.32390E-01
0.70220E+03	0.25121E-01	0.30038E+00	0.75460E-02	0.33629E-01
0.70230E+03	0.25979E-01	0.30047E+00	0.78060E-02	0.34788E-01
0.70240E+03	0.26813E-01	0.30056E+00	0.80590E-02	0.35916E-01
0.70250E+03	0.27703E-01	0.30064E+00	0.83287E-02	0.37118E-01
0.70260E+03	0.28684E-01	0.30073E+00	0.86261E-02	0.38443E-01
0.70270E+03	0.29771E-01	0.30082E+00	0.89557E-02	0.39912E-01
0.70280E+03	0.30971E-01	0.30090E+00	0.93191E-02	0.41531E-01
0.70290E+03	0.32301E-01	0.30099E+00	0.97222E-02	0.43328E-01
0.70300E+03	0.33736E-01	0.30107E+00	0.10157E-01	0.45266E-01
0.70310E+03	0.35250E-01	0.30116E+00	0.10616E-01	0.47309E-01
0.70320E+03	0.36846E-01	0.30124E+00	0.11099E-01	0.49465E-01
0.70330E+03	0.38509E-01	0.30132E+00	0.11603E-01	0.51712E-01
0.70340E+03	0.40245E-01	0.30140E+00	0.12130E-01	0.54059E-01
0.70350E+03	0.42060E-01	0.30148E+00	0.12680E-01	0.56511E-01
0.70360E+03	0.43967E-01	0.30157E+00	0.13259E-01	0.59090E-01
0.70370E+03	0.45942E-01	0.30165E+00	0.13858E-01	0.61760E-01
0.70380E+03	0.47995E-01	0.30173E+00	0.14481E-01	0.64538E-01
0.70390E+03	0.50162E-01	0.30181E+00	0.15139E-01	0.67470E-01
0.70400E+03	0.52489E-01	0.30189E+00	0.15846E-01	0.70619E-01
0.70410E+03	0.55000E-01	0.30197E+00	0.16608E-01	0.74017E-01
0.70420E+03	0.57656E-01	0.30204E+00	0.17415E-01	0.77610E-01
0.70430E+03	0.60415E-01	0.30212E+00	0.18253E-01	0.81344E-01
0.70440E+03	0.63276E-01	0.30219E+00	0.19122E-01	0.85217E-01
0.70450E+03	0.66228E-01	0.30227E+00	0.20019E-01	0.89214E-01
0.70460E+03	0.69245E-01	0.30234E+00	0.20936E-01	0.93302E-01
0.70470E+03	0.72331E-01	0.30242E+00	0.21874E-01	0.97484E-01
0.70480E+03	0.75531E-01	0.30249E+00	0.22847E-01	0.10182E+00
0.70490E+03	0.78956E-01	0.30257E+00	0.23889E-01	0.10647E+00
0.70500E+03	0.82559E-01	0.30264E+00	0.24986E-01	0.11135E+00
0.70510E+03	0.86360E-01	0.30271E+00	0.26142E-01	0.11650E+00
0.70520E+03	0.90340E-01	0.30277E+00	0.27353E-01	0.12190E+00
0.70530E+03	0.94509E-01	0.30284E+00	0.28621E-01	0.12755E+00
0.70540E+03	0.98847E-01	0.30291E+00	0.29942E-01	0.13344E+00
0.70550E+03	0.10336E+00	0.30298E+00	0.31317E-01	0.13957E+00
0.70560E+03	0.10801E+00	0.30304E+00	0.32732E-01	0.14587E+00
0.70570E+03	0.11280E+00	0.30311E+00	0.34191E-01	0.15237E+00

0.70580E+03	0.11778E+00	0.30317E+00	0.35707E-01	0.15913E+00
0.70590E+03	0.12305E+00	0.30324E+00	0.37313E-01	0.16629E+00
0.70600E+03	0.12855E+00	0.30331E+00	0.38991E-01	0.17376E+00
0.70610E+03	0.13425E+00	0.30338E+00	0.40729E-01	0.18151E+00
0.70620E+03	0.14012E+00	0.30346E+00	0.42522E-01	0.18950E+00
0.70630E+03	0.14620E+00	0.30353E+00	0.44378E-01	0.19777E+00
0.70640E+03	0.15250E+00	0.30361E+00	0.46300E-01	0.20634E+00
0.70650E+03	0.15907E+00	0.30368E+00	0.48306E-01	0.21528E+00
0.70660E+03	0.16590E+00	0.30376E+00	0.50395E-01	0.22459E+00
0.70670E+03	0.17302E+00	0.30383E+00	0.52571E-01	0.23429E+00
0.70680E+03	0.18041E+00	0.30391E+00	0.54828E-01	0.24435E+00
0.70690E+03	0.18804E+00	0.30398E+00	0.57161E-01	0.25474E+00
0.70700E+03	0.19589E+00	0.30406E+00	0.59562E-01	0.26544E+00
0.70710E+03	0.20396E+00	0.30413E+00	0.62030E-01	0.27644E+00
0.70720E+03	0.21229E+00	0.30420E+00	0.64579E-01	0.28780E+00
0.70730E+03	0.22095E+00	0.30427E+00	0.67228E-01	0.29961E+00
0.70740E+03	0.22989E+00	0.30435E+00	0.69968E-01	0.31182E+00
0.70750E+03	0.23911E+00	0.30442E+00	0.72790E-01	0.32440E+00
0.70760E+03	0.24858E+00	0.30449E+00	0.75690E-01	0.33732E+00
0.70770E+03	0.25830E+00	0.30456E+00	0.78669E-01	0.35059E+00
0.70780E+03	0.26825E+00	0.30463E+00	0.81719E-01	0.36419E+00
0.70790E+03	0.27842E+00	0.30471E+00	0.84836E-01	0.37808E+00
0.70800E+03	0.28873E+00	0.30478E+00	0.87998E-01	0.39217E+00
0.70810E+03	0.29917E+00	0.30485E+00	0.91204E-01	0.40646E+00
0.70820E+03	0.30972E+00	0.30493E+00	0.94442E-01	0.42089E+00
0.70830E+03	0.32041E+00	0.30501E+00	0.97726E-01	0.43552E+00
0.70840E+03	0.33119E+00	0.30509E+00	0.10104E+00	0.45030E+00
0.70850E+03	0.34209E+00	0.30516E+00	0.10439E+00	0.46523E+00
0.70860E+03	0.35302E+00	0.30524E+00	0.10776E+00	0.48022E+00
0.70870E+03	0.36401E+00	0.30532E+00	0.11114E+00	0.49529E+00
0.70880E+03	0.37499E+00	0.30539E+00	0.11452E+00	0.51037E+00
0.70890E+03	0.38598E+00	0.30547E+00	0.11791E+00	0.52546E+00
0.70900E+03	0.39697E+00	0.30555E+00	0.12129E+00	0.54056E+00
0.70910E+03	0.40800E+00	0.30562E+00	0.12470E+00	0.55572E+00
0.70920E+03	0.41907E+00	0.30570E+00	0.12811E+00	0.57092E+00
0.70930E+03	0.43022E+00	0.30577E+00	0.13155E+00	0.58626E+00
0.70940E+03	0.44136E+00	0.30585E+00	0.13499E+00	0.60160E+00
0.70950E+03	0.45241E+00	0.30593E+00	0.13840E+00	0.61681E+00
0.70960E+03	0.46332E+00	0.30600E+00	0.14178E+00	0.63183E+00
0.70970E+03	0.47414E+00	0.30608E+00	0.14512E+00	0.64675E+00
0.70980E+03	0.48486E+00	0.30615E+00	0.14844E+00	0.66153E+00
0.70990E+03	0.49547E+00	0.30622E+00	0.15173E+00	0.67618E+00
0.71000E+03	0.50593E+00	0.30629E+00	0.15496E+00	0.69061E+00

0.71010E+03	0.51618E+00	0.30637E+00	0.15814E+00	0.70478E+00
0.71020E+03	0.52618E+00	0.30645E+00	0.16125E+00	0.71862E+00
0.71030E+03	0.53593E+00	0.30653E+00	0.16428E+00	0.73211E+00
0.71040E+03	0.54542E+00	0.30660E+00	0.16723E+00	0.74526E+00
0.71050E+03	0.55474E+00	0.30668E+00	0.17013E+00	0.75819E+00
0.71060E+03	0.56386E+00	0.30676E+00	0.17297E+00	0.77085E+00
0.71070E+03	0.57279E+00	0.30684E+00	0.17575E+00	0.78325E+00
0.71080E+03	0.58144E+00	0.30691E+00	0.17845E+00	0.79528E+00
0.71090E+03	0.58976E+00	0.30699E+00	0.18105E+00	0.80687E+00
0.71100E+03	0.59774E+00	0.30707E+00	0.18355E+00	0.81799E+00
0.71110E+03	0.60541E+00	0.30714E+00	0.18595E+00	0.82869E+00
0.71120E+03	0.61277E+00	0.30722E+00	0.18825E+00	0.83897E+00
0.71130E+03	0.61980E+00	0.30729E+00	0.19046E+00	0.84880E+00
0.71140E+03	0.62650E+00	0.30737E+00	0.19256E+00	0.85818E+00
0.71150E+03	0.63286E+00	0.30744E+00	0.19457E+00	0.86710E+00
0.71160E+03	0.63891E+00	0.30752E+00	0.19648E+00	0.87561E+00
0.71170E+03	0.64474E+00	0.30759E+00	0.19832E+00	0.88381E+00
0.71180E+03	0.65034E+00	0.30767E+00	0.20009E+00	0.89171E+00
0.71190E+03	0.65572E+00	0.30774E+00	0.20179E+00	0.89929E+00
0.71200E+03	0.66087E+00	0.30781E+00	0.20342E+00	0.90656E+00
0.71210E+03	0.66578E+00	0.30789E+00	0.20499E+00	0.91353E+00
0.71220E+03	0.67046E+00	0.30796E+00	0.20648E+00	0.92018E+00
0.71230E+03	0.67495E+00	0.30804E+00	0.20791E+00	0.92658E+00
0.71240E+03	0.67924E+00	0.30812E+00	0.20929E+00	0.93271E+00
0.71250E+03	0.68330E+00	0.30820E+00	0.21059E+00	0.93852E+00
0.71260E+03	0.68710E+00	0.30828E+00	0.21182E+00	0.94398E+00
0.71270E+03	0.69061E+00	0.30836E+00	0.21295E+00	0.94904E+00
0.71280E+03	0.69380E+00	0.30843E+00	0.21399E+00	0.95367E+00
0.71290E+03	0.69667E+00	0.30851E+00	0.21493E+00	0.95786E+00
0.71300E+03	0.69931E+00	0.30859E+00	0.21580E+00	0.96173E+00
0.71310E+03	0.70182E+00	0.30867E+00	0.21663E+00	0.96542E+00
0.71320E+03	0.70420E+00	0.30875E+00	0.21742E+00	0.96894E+00
0.71330E+03	0.70640E+00	0.30882E+00	0.21815E+00	0.97221E+00
0.71340E+03	0.70840E+00	0.30890E+00	0.21883E+00	0.97521E+00
0.71350E+03	0.71024E+00	0.30898E+00	0.21945E+00	0.97799E+00
0.71360E+03	0.71194E+00	0.30905E+00	0.22003E+00	0.98057E+00
0.71370E+03	0.71349E+00	0.30913E+00	0.22056E+00	0.98296E+00
0.71380E+03	0.71494E+00	0.30921E+00	0.22107E+00	0.98521E+00
0.71390E+03	0.71632E+00	0.30929E+00	0.22155E+00	0.98736E+00
0.71400E+03	0.71762E+00	0.30937E+00	0.22201E+00	0.98939E+00
0.71410E+03	0.71875E+00	0.30945E+00	0.22242E+00	0.99122E+00
0.71420E+03	0.71973E+00	0.30954E+00	0.22278E+00	0.99284E+00
0.71430E+03	0.72061E+00	0.30962E+00	0.22312E+00	0.99433E+00

0.71440E+03	0.72143E+00	0.30970E+00	0.22343E+00	0.99573E+00
0.71450E+03	0.72219E+00	0.30979E+00	0.22373E+00	0.99705E+00
0.71460E+03	0.72285E+00	0.30987E+00	0.22399E+00	0.99823E+00
0.71470E+03	0.72331E+00	0.30996E+00	0.22419E+00	0.99914E+00
0.71480E+03	0.72355E+00	0.31004E+00	0.22433E+00	0.99974E+00
0.71490E+03	0.72354E+00	0.31012E+00	0.22439E+00	0.10000E+01
0.71500E+03	0.72331E+00	0.31021E+00	0.22438E+00	0.99995E+00
0.71510E+03	0.72285E+00	0.31029E+00	0.22429E+00	0.99958E+00
0.71520E+03	0.72220E+00	0.31037E+00	0.22415E+00	0.99895E+00
0.71530E+03	0.72140E+00	0.31045E+00	0.22396E+00	0.99810E+00
0.71540E+03	0.72049E+00	0.31054E+00	0.22374E+00	0.99710E+00
0.71550E+03	0.71951E+00	0.31062E+00	0.22349E+00	0.99600E+00
0.71560E+03	0.71851E+00	0.31070E+00	0.22324E+00	0.99489E+00
0.71570E+03	0.71758E+00	0.31078E+00	0.22301E+00	0.99385E+00
0.71580E+03	0.71665E+00	0.31086E+00	0.22278E+00	0.99282E+00
0.71590E+03	0.71568E+00	0.31094E+00	0.22253E+00	0.99173E+00
0.71600E+03	0.71464E+00	0.31102E+00	0.22226E+00	0.99053E+00
0.71610E+03	0.71352E+00	0.31110E+00	0.22197E+00	0.98924E+00
0.71620E+03	0.71233E+00	0.31118E+00	0.22166E+00	0.98785E+00
0.71630E+03	0.71101E+00	0.31126E+00	0.22131E+00	0.98628E+00
0.71640E+03	0.70955E+00	0.31134E+00	0.22091E+00	0.98452E+00
0.71650E+03	0.70793E+00	0.31142E+00	0.22047E+00	0.98253E+00
0.71660E+03	0.70613E+00	0.31151E+00	0.21996E+00	0.98029E+00
0.71670E+03	0.70414E+00	0.31159E+00	0.21940E+00	0.97778E+00
0.71680E+03	0.70203E+00	0.31167E+00	0.21880E+00	0.97510E+00
0.71690E+03	0.69985E+00	0.31175E+00	0.21818E+00	0.97234E+00
0.71700E+03	0.69762E+00	0.31183E+00	0.21754E+00	0.96948E+00
0.71710E+03	0.69530E+00	0.31191E+00	0.21687E+00	0.96650E+00
0.71720E+03	0.69288E+00	0.31199E+00	0.21617E+00	0.96339E+00
0.71730E+03	0.69038E+00	0.31207E+00	0.21545E+00	0.96016E+00
0.71740E+03	0.68778E+00	0.31215E+00	0.21469E+00	0.95679E+00
0.71750E+03	0.68507E+00	0.31223E+00	0.21390E+00	0.95327E+00
0.71760E+03	0.68229E+00	0.31232E+00	0.21309E+00	0.94966E+00
0.71770E+03	0.67945E+00	0.31241E+00	0.21227E+00	0.94600E+00
0.71780E+03	0.67652E+00	0.31251E+00	0.21142E+00	0.94221E+00
0.71790E+03	0.67353E+00	0.31261E+00	0.21055E+00	0.93834E+00
0.71800E+03	0.67046E+00	0.31270E+00	0.20965E+00	0.93434E+00
0.71810E+03	0.66731E+00	0.31280E+00	0.20873E+00	0.93024E+00
0.71820E+03	0.66405E+00	0.31290E+00	0.20778E+00	0.92599E+00
0.71830E+03	0.66063E+00	0.31300E+00	0.20678E+00	0.92151E+00
0.71840E+03	0.65705E+00	0.31310E+00	0.20572E+00	0.91680E+00
0.71850E+03	0.65324E+00	0.31319E+00	0.20459E+00	0.91178E+00
0.71860E+03	0.64925E+00	0.31329E+00	0.20341E+00	0.90649E+00

0.71870E+03	0.64510E+00	0.31339E+00	0.20217E+00	0.90097E+00
0.71880E+03	0.64081E+00	0.31349E+00	0.20088E+00	0.89526E+00
0.71890E+03	0.63639E+00	0.31358E+00	0.19956E+00	0.88936E+00
0.71900E+03	0.63185E+00	0.31368E+00	0.19820E+00	0.88329E+00
0.71910E+03	0.62716E+00	0.31378E+00	0.19679E+00	0.87700E+00
0.71920E+03	0.62233E+00	0.31387E+00	0.19533E+00	0.87052E+00
0.71930E+03	0.61732E+00	0.31397E+00	0.19382E+00	0.86378E+00
0.71940E+03	0.61220E+00	0.31407E+00	0.19227E+00	0.85687E+00
0.71950E+03	0.60698E+00	0.31417E+00	0.19069E+00	0.84984E+00
0.71960E+03	0.60167E+00	0.31429E+00	0.18910E+00	0.84272E+00
0.71970E+03	0.59619E+00	0.31441E+00	0.18745E+00	0.83537E+00
0.71980E+03	0.59055E+00	0.31453E+00	0.18575E+00	0.82779E+00
0.71990E+03	0.58473E+00	0.31465E+00	0.18399E+00	0.81995E+00
0.72000E+03	0.57875E+00	0.31477E+00	0.18217E+00	0.81187E+00
0.72010E+03	0.57254E+00	0.31489E+00	0.18029E+00	0.80346E+00
0.72020E+03	0.56610E+00	0.31501E+00	0.17832E+00	0.79472E+00
0.72030E+03	0.55944E+00	0.31512E+00	0.17629E+00	0.78566E+00
0.72040E+03	0.55259E+00	0.31524E+00	0.17420E+00	0.77633E+00
0.72050E+03	0.54556E+00	0.31536E+00	0.17205E+00	0.76673E+00
0.72060E+03	0.53840E+00	0.31547E+00	0.16985E+00	0.75696E+00
0.72070E+03	0.53118E+00	0.31559E+00	0.16764E+00	0.74708E+00
0.72080E+03	0.52391E+00	0.31571E+00	0.16540E+00	0.73713E+00
0.72090E+03	0.51657E+00	0.31582E+00	0.16314E+00	0.72706E+00
0.72100E+03	0.50910E+00	0.31594E+00	0.16085E+00	0.71682E+00
0.72110E+03	0.50145E+00	0.31606E+00	0.15849E+00	0.70631E+00
0.72120E+03	0.49363E+00	0.31618E+00	0.15608E+00	0.69556E+00
0.72130E+03	0.48564E+00	0.31629E+00	0.15360E+00	0.68454E+00
0.72140E+03	0.47746E+00	0.31641E+00	0.15107E+00	0.67326E+00
0.72150E+03	0.46913E+00	0.31654E+00	0.14850E+00	0.66178E+00
0.72160E+03	0.46065E+00	0.31666E+00	0.14587E+00	0.65008E+00
0.72170E+03	0.45201E+00	0.31679E+00	0.14319E+00	0.63816E+00
0.72180E+03	0.44326E+00	0.31692E+00	0.14048E+00	0.62605E+00
0.72190E+03	0.43431E+00	0.31705E+00	0.13770E+00	0.61367E+00
0.72200E+03	0.42523E+00	0.31718E+00	0.13487E+00	0.60108E+00
0.72210E+03	0.41600E+00	0.31731E+00	0.13200E+00	0.58828E+00
0.72220E+03	0.40669E+00	0.31745E+00	0.12910E+00	0.57536E+00
0.72230E+03	0.39731E+00	0.31758E+00	0.12618E+00	0.56232E+00
0.72240E+03	0.38791E+00	0.31771E+00	0.12324E+00	0.54924E+00
0.72250E+03	0.37845E+00	0.31785E+00	0.12029E+00	0.53607E+00
0.72260E+03	0.36897E+00	0.31798E+00	0.11733E+00	0.52287E+00
0.72270E+03	0.35945E+00	0.31811E+00	0.11434E+00	0.50958E+00
0.72280E+03	0.34992E+00	0.31825E+00	0.11136E+00	0.49629E+00
0.72290E+03	0.34046E+00	0.31838E+00	0.10839E+00	0.48307E+00

0.72300E+03	0.33111E+00	0.31851E+00	0.10546E+00	0.47001E+00
0.72310E+03	0.32188E+00	0.31865E+00	0.10256E+00	0.45709E+00
0.72320E+03	0.31278E+00	0.31878E+00	0.99709E-01	0.44436E+00
0.72330E+03	0.30379E+00	0.31891E+00	0.96884E-01	0.43177E+00
0.72340E+03	0.29490E+00	0.31905E+00	0.94086E-01	0.41930E+00
0.72350E+03	0.28606E+00	0.31919E+00	0.91308E-01	0.40692E+00
0.72360E+03	0.27735E+00	0.31933E+00	0.88565E-01	0.39470E+00
0.72370E+03	0.26875E+00	0.31947E+00	0.85859E-01	0.38264E+00
0.72380E+03	0.26031E+00	0.31961E+00	0.83198E-01	0.37078E+00
0.72390E+03	0.25201E+00	0.31975E+00	0.80581E-01	0.35912E+00
0.72400E+03	0.24389E+00	0.31989E+00	0.78017E-01	0.34769E+00
0.72410E+03	0.23594E+00	0.32004E+00	0.75511E-01	0.33652E+00
0.72420E+03	0.22817E+00	0.32020E+00	0.73059E-01	0.32559E+00
0.72430E+03	0.22053E+00	0.32035E+00	0.70647E-01	0.31484E+00
0.72440E+03	0.21304E+00	0.32050E+00	0.68280E-01	0.30429E+00
0.72450E+03	0.20567E+00	0.32065E+00	0.65948E-01	0.29390E+00
0.72460E+03	0.19841E+00	0.32080E+00	0.63649E-01	0.28366E+00
0.72470E+03	0.19124E+00	0.32095E+00	0.61378E-01	0.27354E+00
0.72480E+03	0.18420E+00	0.32110E+00	0.59147E-01	0.26359E+00
0.72490E+03	0.17730E+00	0.32123E+00	0.56956E-01	0.25383E+00
0.72500E+03	0.17058E+00	0.32137E+00	0.54818E-01	0.24430E+00
0.72510E+03	0.16405E+00	0.32150E+00	0.52740E-01	0.23504E+00
0.72520E+03	0.15771E+00	0.32163E+00	0.50724E-01	0.22606E+00
0.72530E+03	0.15153E+00	0.32177E+00	0.48756E-01	0.21728E+00
0.72540E+03	0.14551E+00	0.32190E+00	0.46839E-01	0.20874E+00
0.72550E+03	0.13968E+00	0.32204E+00	0.44981E-01	0.20046E+00
0.72560E+03	0.13405E+00	0.32217E+00	0.43186E-01	0.19246E+00
0.72570E+03	0.12859E+00	0.32231E+00	0.41447E-01	0.18471E+00
0.72580E+03	0.12331E+00	0.32244E+00	0.39761E-01	0.17720E+00
0.72590E+03	0.11818E+00	0.32258E+00	0.38123E-01	0.16990E+00
0.72600E+03	0.11321E+00	0.32271E+00	0.36535E-01	0.16282E+00
0.72610E+03	0.10839E+00	0.32286E+00	0.34995E-01	0.15596E+00
0.72620E+03	0.10376E+00	0.32301E+00	0.33515E-01	0.14936E+00
0.72630E+03	0.99386E-01	0.32315E+00	0.32117E-01	0.14313E+00
0.72640E+03	0.95253E-01	0.32330E+00	0.30796E-01	0.13724E+00
0.72650E+03	0.91266E-01	0.32345E+00	0.29520E-01	0.13156E+00
0.72660E+03	0.87399E-01	0.32360E+00	0.28282E-01	0.12604E+00
0.72670E+03	0.83683E-01	0.32375E+00	0.27092E-01	0.12074E+00
0.72680E+03	0.80170E-01	0.32390E+00	0.25967E-01	0.11572E+00
0.72690E+03	0.76879E-01	0.32404E+00	0.24912E-01	0.11102E+00
0.72700E+03	0.73797E-01	0.32419E+00	0.23924E-01	0.10662E+00
0.72710E+03	0.70946E-01	0.32434E+00	0.23011E-01	0.10255E+00
0.72720E+03	0.68309E-01	0.32449E+00	0.22166E-01	0.98782E-01

0.72730E+03	0.65818E-01	0.32464E+00	0.21367E-01	0.95224E-01
0.72740E+03	0.63440E-01	0.32479E+00	0.20605E-01	0.91827E-01
0.72750E+03	0.61154E-01	0.32494E+00	0.19872E-01	0.88559E-01
0.72760E+03	0.58945E-01	0.32509E+00	0.19163E-01	0.85399E-01
0.72770E+03	0.56794E-01	0.32524E+00	0.18472E-01	0.82322E-01
0.72780E+03	0.54693E-01	0.32540E+00	0.17797E-01	0.79313E-01
0.72790E+03	0.52665E-01	0.32555E+00	0.17145E-01	0.76408E-01
0.72800E+03	0.50724E-01	0.32570E+00	0.16521E-01	0.73625E-01
0.72810E+03	0.48891E-01	0.32586E+00	0.15932E-01	0.71000E-01
0.72820E+03	0.47136E-01	0.32602E+00	0.15367E-01	0.68486E-01
0.72830E+03	0.45401E-01	0.32618E+00	0.14809E-01	0.65998E-01
0.72840E+03	0.43665E-01	0.32635E+00	0.14250E-01	0.63505E-01
0.72850E+03	0.41922E-01	0.32651E+00	0.13688E-01	0.61001E-01
0.72860E+03	0.40167E-01	0.32667E+00	0.13121E-01	0.58477E-01
0.72870E+03	0.38422E-01	0.32683E+00	0.12557E-01	0.55963E-01
0.72880E+03	0.36713E-01	0.32699E+00	0.12005E-01	0.53500E-01
0.72890E+03	0.35074E-01	0.32715E+00	0.11475E-01	0.51138E-01
0.72900E+03	0.33503E-01	0.32731E+00	0.10966E-01	0.48871E-01
0.72910E+03	0.31979E-01	0.32747E+00	0.10472E-01	0.46671E-01
0.72920E+03	0.30505E-01	0.32763E+00	0.99943E-02	0.44540E-01
0.72930E+03	0.29089E-01	0.32778E+00	0.95349E-02	0.42493E-01
0.72940E+03	0.27742E-01	0.32794E+00	0.90976E-02	0.40544E-01
0.72950E+03	0.26487E-01	0.32809E+00	0.86901E-02	0.38728E-01
0.72960E+03	0.25337E-01	0.32824E+00	0.83167E-02	0.37064E-01
0.72970E+03	0.24321E-01	0.32840E+00	0.79869E-02	0.35594E-01
0.72980E+03	0.23397E-01	0.32855E+00	0.76870E-02	0.34258E-01
0.72990E+03	0.22513E-01	0.32870E+00	0.74001E-02	0.32979E-01
0.73000E+03	0.21685E-01	0.32885E+00	0.71310E-02	0.31780E-01
0.73010E+03	0.20917E-01	0.32903E+00	0.68823E-02	0.30672E-01
0.73020E+03	0.20153E-01	0.32920E+00	0.66344E-02	0.29567E-01
0.73030E+03	0.19390E-01	0.32937E+00	0.63866E-02	0.28463E-01
0.73040E+03	0.18650E-01	0.32954E+00	0.61461E-02	0.27391E-01
0.73050E+03	0.17916E-01	0.32972E+00	0.59071E-02	0.26325E-01
0.73060E+03	0.17197E-01	0.32989E+00	0.56731E-02	0.25283E-01
0.73070E+03	0.16482E-01	0.33006E+00	0.54399E-02	0.24243E-01
0.73080E+03	0.15768E-01	0.33024E+00	0.52072E-02	0.23206E-01
0.73090E+03	0.15081E-01	0.33041E+00	0.49827E-02	0.22206E-01
0.73100E+03	0.14399E-01	0.33058E+00	0.47599E-02	0.21213E-01
0.73110E+03	0.13729E-01	0.33076E+00	0.45408E-02	0.20237E-01
0.73120E+03	0.13072E-01	0.33094E+00	0.43260E-02	0.19279E-01
0.73130E+03	0.12470E-01	0.33112E+00	0.41293E-02	0.18402E-01
0.73140E+03	0.11995E-01	0.33131E+00	0.39741E-02	0.17711E-01
0.73150E+03	0.11590E-01	0.33149E+00	0.38421E-02	0.17123E-01

0.73160E+03	0.11191E-01	0.33167E+00	0.37117E-02	0.16541E-01
0.73170E+03	0.10804E-01	0.33186E+00	0.35854E-02	0.15979E-01
0.73180E+03	0.10418E-01	0.33204E+00	0.34592E-02	0.15416E-01
0.73190E+03	0.10032E-01	0.33222E+00	0.33328E-02	0.14853E-01
0.73200E+03	0.96468E-02	0.33241E+00	0.32067E-02	0.14291E-01
0.73210E+03	0.92653E-02	0.33259E+00	0.30816E-02	0.13733E-01
0.73220E+03	0.89020E-02	0.33278E+00	0.29624E-02	0.13202E-01
0.73230E+03	0.85515E-02	0.33296E+00	0.28474E-02	0.12689E-01
0.73240E+03	0.82066E-02	0.33315E+00	0.27340E-02	0.12184E-01
0.73250E+03	0.78736E-02	0.33334E+00	0.26246E-02	0.11697E-01
0.73260E+03	0.75502E-02	0.33352E+00	0.25182E-02	0.11222E-01
0.73270E+03	0.72608E-02	0.33371E+00	0.24230E-02	0.10798E-01
0.73280E+03	0.69747E-02	0.33390E+00	0.23288E-02	0.10379E-01
0.73290E+03	0.66909E-02	0.33408E+00	0.22353E-02	0.99619E-02
0.73300E+03	0.64100E-02	0.33427E+00	0.21427E-02	0.95489E-02
0.73310E+03	0.61328E-02	0.33448E+00	0.20513E-02	0.91417E-02
0.73320E+03	0.58677E-02	0.33468E+00	0.19638E-02	0.87519E-02
0.73330E+03	0.56047E-02	0.33489E+00	0.18769E-02	0.83648E-02
0.73340E+03	0.53472E-02	0.33509E+00	0.17918E-02	0.79853E-02
0.73350E+03	0.50926E-02	0.33530E+00	0.17075E-02	0.76098E-02
0.73360E+03	0.48381E-02	0.33550E+00	0.16232E-02	0.72340E-02
0.73370E+03	0.45848E-02	0.33571E+00	0.15392E-02	0.68594E-02
0.73380E+03	0.43321E-02	0.33592E+00	0.14552E-02	0.64854E-02
0.73390E+03	0.40803E-02	0.33612E+00	0.13715E-02	0.61122E-02
0.73400E+03	0.38368E-02	0.33633E+00	0.12904E-02	0.57510E-02
0.73410E+03	0.35940E-02	0.33653E+00	0.12095E-02	0.53902E-02
0.73420E+03	0.33530E-02	0.33673E+00	0.11291E-02	0.50317E-02
0.73430E+03	0.31274E-02	0.33693E+00	0.10537E-02	0.46959E-02
0.73440E+03	0.29077E-02	0.33713E+00	0.98027E-03	0.43686E-02
0.73450E+03	0.26934E-02	0.33733E+00	0.90857E-03	0.40491E-02
0.73460E+03	0.24815E-02	0.33752E+00	0.83758E-03	0.37328E-02
0.73470E+03	0.22702E-02	0.33772E+00	0.76670E-03	0.34168E-02
0.73480E+03	0.20588E-02	0.33792E+00	0.69573E-03	0.31006E-02
0.73490E+03	0.18515E-02	0.33812E+00	0.62603E-03	0.27899E-02
0.73500E+03	0.16498E-02	0.33833E+00	0.55817E-03	0.24875E-02
0.73510E+03	0.14511E-02	0.33853E+00	0.49124E-03	0.21892E-02
0.73520E+03	0.12561E-02	0.33874E+00	0.42549E-03	0.18962E-02
0.73530E+03	0.10630E-02	0.33895E+00	0.36031E-03	0.16057E-02
0.73540E+03	0.88090E-03	0.33916E+00	0.29876E-03	0.13315E-02
0.73550E+03	0.72205E-03	0.33936E+00	0.24504E-03	0.10920E-02
0.73560E+03	0.56538E-03	0.33957E+00	0.19199E-03	0.85560E-03
0.73570E+03	0.41927E-03	0.33978E+00	0.14246E-03	0.63488E-03
0.73580E+03	0.27334E-03	0.33999E+00	0.92933E-04	0.41416E-03

0.73590E+03	0.14599E-03	0.34020E+00	0.49665E-04	0.22134E-03
0.73600E+03	0.40867E-04	0.34040E+00	0.13911E-04	0.61997E-04
0.73610E+03	0.00000E+00	0.34060E+00	0.00000E+00	0.00000E+00
Channel 6				
Wavenumber	HIRS Filter Transmittance	Optical Element Transmittance	Product of the HIRS Filter and Optical Element Transmittances	Normalized Value of Column 4
0.71350E+03	0.00000E+00	0.30898E+00	0.00000E+00	0.00000E+00
0.71360E+03	0.84668E-04	0.30905E+00	0.26167E-04	0.99643E-04
0.71370E+03	0.17625E-03	0.30913E+00	0.54485E-04	0.20747E-03
0.71380E+03	0.27749E-03	0.30921E+00	0.85804E-04	0.32673E-03
0.71390E+03	0.40216E-03	0.30929E+00	0.12438E-03	0.47365E-03
0.71400E+03	0.52946E-03	0.30937E+00	0.16380E-03	0.62373E-03
0.71410E+03	0.66370E-03	0.30945E+00	0.20538E-03	0.78208E-03
0.71420E+03	0.80284E-03	0.30954E+00	0.24851E-03	0.94629E-03
0.71430E+03	0.94471E-03	0.30962E+00	0.29250E-03	0.11138E-02
0.71440E+03	0.10876E-02	0.30970E+00	0.33683E-03	0.12826E-02
0.71450E+03	0.12373E-02	0.30979E+00	0.38330E-03	0.14596E-02
0.71460E+03	0.13922E-02	0.30987E+00	0.43141E-03	0.16428E-02
0.71470E+03	0.15549E-02	0.30996E+00	0.48193E-03	0.18352E-02
0.71480E+03	0.17249E-02	0.31004E+00	0.53480E-03	0.20365E-02
0.71490E+03	0.18986E-02	0.31012E+00	0.58880E-03	0.22421E-02
0.71500E+03	0.20728E-02	0.31021E+00	0.64301E-03	0.24485E-02
0.71510E+03	0.22475E-02	0.31029E+00	0.69737E-03	0.26555E-02
0.71520E+03	0.24233E-02	0.31037E+00	0.75213E-03	0.28641E-02
0.71530E+03	0.26020E-02	0.31045E+00	0.80780E-03	0.30760E-02
0.71540E+03	0.27841E-02	0.31054E+00	0.86456E-03	0.32922E-02
0.71550E+03	0.29696E-02	0.31062E+00	0.92240E-03	0.35124E-02
0.71560E+03	0.31561E-02	0.31070E+00	0.98060E-03	0.37341E-02
0.71570E+03	0.33663E-02	0.31078E+00	0.10462E-02	0.39837E-02
0.71580E+03	0.35792E-02	0.31086E+00	0.11126E-02	0.42367E-02
0.71590E+03	0.38255E-02	0.31094E+00	0.11895E-02	0.45294E-02
0.71600E+03	0.40754E-02	0.31102E+00	0.12675E-02	0.48265E-02
0.71610E+03	0.43256E-02	0.31110E+00	0.13457E-02	0.51242E-02
0.71620E+03	0.45805E-02	0.31118E+00	0.14254E-02	0.54277E-02
0.71630E+03	0.48431E-02	0.31126E+00	0.15075E-02	0.57403E-02
0.71640E+03	0.51153E-02	0.31134E+00	0.15926E-02	0.60646E-02
0.71650E+03	0.53884E-02	0.31142E+00	0.16781E-02	0.63899E-02
0.71660E+03	0.56641E-02	0.31151E+00	0.17644E-02	0.67187E-02
0.71670E+03	0.59435E-02	0.31159E+00	0.18519E-02	0.70519E-02
0.71680E+03	0.62426E-02	0.31167E+00	0.19456E-02	0.74088E-02
0.71690E+03	0.65455E-02	0.31175E+00	0.20406E-02	0.77703E-02

0.71700E+03	0.68754E-02	0.31183E+00	0.21440E-02	0.81641E-02
0.71710E+03	0.72176E-02	0.31191E+00	0.22513E-02	0.85727E-02
0.71720E+03	0.75666E-02	0.31199E+00	0.23607E-02	0.89895E-02
0.71730E+03	0.79189E-02	0.31207E+00	0.24713E-02	0.94104E-02
0.71740E+03	0.82761E-02	0.31215E+00	0.25834E-02	0.98374E-02
0.71750E+03	0.86536E-02	0.31223E+00	0.27019E-02	0.10289E-01
0.71760E+03	0.90409E-02	0.31232E+00	0.28236E-02	0.10752E-01
0.71770E+03	0.94423E-02	0.31241E+00	0.29499E-02	0.11233E-01
0.71780E+03	0.98465E-02	0.31251E+00	0.30772E-02	0.11718E-01
0.71790E+03	0.10280E-01	0.31261E+00	0.32135E-02	0.12237E-01
0.71800E+03	0.10717E-01	0.31270E+00	0.33513E-02	0.12761E-01
0.71810E+03	0.11156E-01	0.31280E+00	0.34895E-02	0.13288E-01
0.71820E+03	0.11608E-01	0.31290E+00	0.36321E-02	0.13831E-01
0.71830E+03	0.12090E-01	0.31300E+00	0.37841E-02	0.14410E-01
0.71840E+03	0.12683E-01	0.31310E+00	0.39710E-02	0.15121E-01
0.71850E+03	0.13483E-01	0.31319E+00	0.42228E-02	0.16080E-01
0.71860E+03	0.14326E-01	0.31329E+00	0.44883E-02	0.17091E-01
0.71870E+03	0.15173E-01	0.31339E+00	0.47551E-02	0.18107E-01
0.71880E+03	0.16034E-01	0.31349E+00	0.50263E-02	0.19140E-01
0.71890E+03	0.16910E-01	0.31358E+00	0.53026E-02	0.20192E-01
0.71900E+03	0.17786E-01	0.31368E+00	0.55793E-02	0.21245E-01
0.71910E+03	0.18663E-01	0.31378E+00	0.58562E-02	0.22300E-01
0.71920E+03	0.19564E-01	0.31387E+00	0.61407E-02	0.23383E-01
0.71930E+03	0.20531E-01	0.31397E+00	0.64463E-02	0.24547E-01
0.71940E+03	0.21510E-01	0.31407E+00	0.67556E-02	0.25725E-01
0.71950E+03	0.22505E-01	0.31417E+00	0.70702E-02	0.26923E-01
0.71960E+03	0.23527E-01	0.31429E+00	0.73942E-02	0.28157E-01
0.71970E+03	0.24648E-01	0.31441E+00	0.77495E-02	0.29510E-01
0.71980E+03	0.25826E-01	0.31453E+00	0.81229E-02	0.30932E-01
0.71990E+03	0.27082E-01	0.31465E+00	0.85213E-02	0.32449E-01
0.72000E+03	0.28493E-01	0.31477E+00	0.89688E-02	0.34152E-01
0.72010E+03	0.30103E-01	0.31489E+00	0.94791E-02	0.36095E-01
0.72020E+03	0.31867E-01	0.31501E+00	0.10038E-01	0.38225E-01
0.72030E+03	0.33779E-01	0.31512E+00	0.10644E-01	0.40533E-01
0.72040E+03	0.35788E-01	0.31524E+00	0.11282E-01	0.42960E-01
0.72050E+03	0.37905E-01	0.31536E+00	0.11953E-01	0.45518E-01
0.72060E+03	0.40195E-01	0.31547E+00	0.12681E-01	0.48286E-01
0.72070E+03	0.42687E-01	0.31559E+00	0.13472E-01	0.51299E-01
0.72080E+03	0.45354E-01	0.31571E+00	0.14319E-01	0.54524E-01
0.72090E+03	0.48195E-01	0.31582E+00	0.15221E-01	0.57961E-01
0.72100E+03	0.51250E-01	0.31594E+00	0.16192E-01	0.61657E-01
0.72110E+03	0.54507E-01	0.31606E+00	0.17227E-01	0.65601E-01
0.72120E+03	0.58012E-01	0.31618E+00	0.18342E-01	0.69845E-01

0.72130E+03	0.61888E-01	0.31629E+00	0.19575E-01	0.74539E-01
0.72140E+03	0.66029E-01	0.31641E+00	0.20892E-01	0.79556E-01
0.72150E+03	0.70326E-01	0.31654E+00	0.22261E-01	0.84767E-01
0.72160E+03	0.74831E-01	0.31666E+00	0.23696E-01	0.90234E-01
0.72170E+03	0.79559E-01	0.31679E+00	0.25204E-01	0.95975E-01
0.72180E+03	0.84571E-01	0.31692E+00	0.26803E-01	0.10206E+00
0.72190E+03	0.89919E-01	0.31705E+00	0.28509E-01	0.10856E+00
0.72200E+03	0.95671E-01	0.31718E+00	0.30345E-01	0.11555E+00
0.72210E+03	0.10189E+00	0.31731E+00	0.32331E-01	0.12311E+00
0.72220E+03	0.10849E+00	0.31745E+00	0.34439E-01	0.13114E+00
0.72230E+03	0.11540E+00	0.31758E+00	0.36648E-01	0.13955E+00
0.72240E+03	0.12270E+00	0.31771E+00	0.38983E-01	0.14845E+00
0.72250E+03	0.13044E+00	0.31785E+00	0.41461E-01	0.15788E+00
0.72260E+03	0.13865E+00	0.31798E+00	0.44087E-01	0.16788E+00
0.72270E+03	0.14727E+00	0.31811E+00	0.46848E-01	0.17839E+00
0.72280E+03	0.15635E+00	0.31825E+00	0.49757E-01	0.18947E+00
0.72290E+03	0.16584E+00	0.31838E+00	0.52801E-01	0.20106E+00
0.72300E+03	0.17580E+00	0.31851E+00	0.55993E-01	0.21322E+00
0.72310E+03	0.18617E+00	0.31865E+00	0.59321E-01	0.22589E+00
0.72320E+03	0.19705E+00	0.31878E+00	0.62815E-01	0.23919E+00
0.72330E+03	0.20847E+00	0.31891E+00	0.66484E-01	0.25317E+00
0.72340E+03	0.22043E+00	0.31905E+00	0.70329E-01	0.26781E+00
0.72350E+03	0.23289E+00	0.31919E+00	0.74336E-01	0.28306E+00
0.72360E+03	0.24579E+00	0.31933E+00	0.78487E-01	0.29887E+00
0.72370E+03	0.25893E+00	0.31947E+00	0.82719E-01	0.31499E+00
0.72380E+03	0.27239E+00	0.31961E+00	0.87059E-01	0.33151E+00
0.72390E+03	0.28625E+00	0.31975E+00	0.91530E-01	0.34854E+00
0.72400E+03	0.30052E+00	0.31989E+00	0.96135E-01	0.36607E+00
0.72410E+03	0.31504E+00	0.32004E+00	0.10083E+00	0.38395E+00
0.72420E+03	0.32981E+00	0.32020E+00	0.10560E+00	0.40213E+00
0.72430E+03	0.34473E+00	0.32035E+00	0.11043E+00	0.42052E+00
0.72440E+03	0.35980E+00	0.32050E+00	0.11532E+00	0.43911E+00
0.72450E+03	0.37492E+00	0.32065E+00	0.12022E+00	0.45778E+00
0.72460E+03	0.39008E+00	0.32080E+00	0.12514E+00	0.47651E+00
0.72470E+03	0.40522E+00	0.32095E+00	0.13005E+00	0.49524E+00
0.72480E+03	0.42038E+00	0.32110E+00	0.13498E+00	0.51401E+00
0.72490E+03	0.43545E+00	0.32123E+00	0.13988E+00	0.53266E+00
0.72500E+03	0.45037E+00	0.32137E+00	0.14473E+00	0.55114E+00
0.72510E+03	0.46509E+00	0.32150E+00	0.14953E+00	0.56938E+00
0.72520E+03	0.47962E+00	0.32163E+00	0.15426E+00	0.58742E+00
0.72530E+03	0.49387E+00	0.32177E+00	0.15891E+00	0.60511E+00
0.72540E+03	0.50781E+00	0.32190E+00	0.16346E+00	0.62246E+00
0.72550E+03	0.52134E+00	0.32204E+00	0.16789E+00	0.63931E+00

0.72560E+03	0.53446E+00	0.32217E+00	0.17219E+00	0.65568E+00
0.72570E+03	0.54709E+00	0.32231E+00	0.17633E+00	0.67145E+00
0.72580E+03	0.55929E+00	0.32244E+00	0.18034E+00	0.68671E+00
0.72590E+03	0.57107E+00	0.32258E+00	0.18421E+00	0.70147E+00
0.72600E+03	0.58252E+00	0.32271E+00	0.18799E+00	0.71584E+00
0.72610E+03	0.59362E+00	0.32286E+00	0.19165E+00	0.72981E+00
0.72620E+03	0.60433E+00	0.32301E+00	0.19520E+00	0.74331E+00
0.72630E+03	0.61458E+00	0.32315E+00	0.19860E+00	0.75626E+00
0.72640E+03	0.62439E+00	0.32330E+00	0.20187E+00	0.76870E+00
0.72650E+03	0.63371E+00	0.32345E+00	0.20497E+00	0.78052E+00
0.72660E+03	0.64258E+00	0.32360E+00	0.20794E+00	0.79182E+00
0.72670E+03	0.65098E+00	0.32375E+00	0.21075E+00	0.80253E+00
0.72680E+03	0.65896E+00	0.32390E+00	0.21343E+00	0.81274E+00
0.72690E+03	0.66652E+00	0.32404E+00	0.21598E+00	0.82245E+00
0.72700E+03	0.67367E+00	0.32419E+00	0.21840E+00	0.83164E+00
0.72710E+03	0.68021E+00	0.32434E+00	0.22062E+00	0.84010E+00
0.72720E+03	0.68624E+00	0.32449E+00	0.22268E+00	0.84794E+00
0.72730E+03	0.69179E+00	0.32464E+00	0.22458E+00	0.85520E+00
0.72740E+03	0.69707E+00	0.32479E+00	0.22640E+00	0.86213E+00
0.72750E+03	0.70211E+00	0.32494E+00	0.22815E+00	0.86876E+00
0.72760E+03	0.70682E+00	0.32509E+00	0.22978E+00	0.87500E+00
0.72770E+03	0.71104E+00	0.32524E+00	0.23126E+00	0.88063E+00
0.72780E+03	0.71494E+00	0.32540E+00	0.23264E+00	0.88586E+00
0.72790E+03	0.71852E+00	0.32555E+00	0.23391E+00	0.89072E+00
0.72800E+03	0.72190E+00	0.32570E+00	0.23512E+00	0.89532E+00
0.72810E+03	0.72512E+00	0.32586E+00	0.23629E+00	0.89977E+00
0.72820E+03	0.72826E+00	0.32602E+00	0.23743E+00	0.90411E+00
0.72830E+03	0.73134E+00	0.32618E+00	0.23855E+00	0.90839E+00
0.72840E+03	0.73433E+00	0.32635E+00	0.23965E+00	0.91255E+00
0.72850E+03	0.73704E+00	0.32651E+00	0.24065E+00	0.91638E+00
0.72860E+03	0.73964E+00	0.32667E+00	0.24162E+00	0.92007E+00
0.72870E+03	0.74217E+00	0.32683E+00	0.24256E+00	0.92366E+00
0.72880E+03	0.74461E+00	0.32699E+00	0.24348E+00	0.92716E+00
0.72890E+03	0.74691E+00	0.32715E+00	0.24435E+00	0.93048E+00
0.72900E+03	0.74910E+00	0.32731E+00	0.24519E+00	0.93367E+00
0.72910E+03	0.75113E+00	0.32747E+00	0.24598E+00	0.93666E+00
0.72920E+03	0.75308E+00	0.32763E+00	0.24673E+00	0.93954E+00
0.72930E+03	0.75494E+00	0.32778E+00	0.24746E+00	0.94229E+00
0.72940E+03	0.75680E+00	0.32794E+00	0.24818E+00	0.94506E+00
0.72950E+03	0.75871E+00	0.32809E+00	0.24893E+00	0.94789E+00
0.72960E+03	0.76063E+00	0.32824E+00	0.24967E+00	0.95073E+00
0.72970E+03	0.76257E+00	0.32840E+00	0.25042E+00	0.95360E+00
0.72980E+03	0.76449E+00	0.32855E+00	0.25117E+00	0.95644E+00

0.72990E+03	0.76625E+00	0.32870E+00	0.25187E+00	0.95909E+00
0.73000E+03	0.76790E+00	0.32885E+00	0.25253E+00	0.96160E+00
0.73010E+03	0.76944E+00	0.32903E+00	0.25317E+00	0.96404E+00
0.73020E+03	0.77092E+00	0.32920E+00	0.25379E+00	0.96640E+00
0.73030E+03	0.77233E+00	0.32937E+00	0.25439E+00	0.96868E+00
0.73040E+03	0.77371E+00	0.32954E+00	0.25497E+00	0.97091E+00
0.73050E+03	0.77504E+00	0.32972E+00	0.25554E+00	0.97309E+00
0.73060E+03	0.77627E+00	0.32989E+00	0.25608E+00	0.97515E+00
0.73070E+03	0.77738E+00	0.33006E+00	0.25658E+00	0.97705E+00
0.73080E+03	0.77846E+00	0.33024E+00	0.25707E+00	0.97892E+00
0.73090E+03	0.77952E+00	0.33041E+00	0.25756E+00	0.98077E+00
0.73100E+03	0.78047E+00	0.33058E+00	0.25801E+00	0.98248E+00
0.73110E+03	0.78126E+00	0.33076E+00	0.25841E+00	0.98400E+00
0.73120E+03	0.78183E+00	0.33094E+00	0.25874E+00	0.98526E+00
0.73130E+03	0.78205E+00	0.33112E+00	0.25895E+00	0.98608E+00
0.73140E+03	0.78207E+00	0.33131E+00	0.25911E+00	0.98666E+00
0.73150E+03	0.78212E+00	0.33149E+00	0.25926E+00	0.98726E+00
0.73160E+03	0.78218E+00	0.33167E+00	0.25943E+00	0.98788E+00
0.73170E+03	0.78215E+00	0.33186E+00	0.25956E+00	0.98839E+00
0.73180E+03	0.78207E+00	0.33204E+00	0.25968E+00	0.98883E+00
0.73190E+03	0.78203E+00	0.33222E+00	0.25981E+00	0.98933E+00
0.73200E+03	0.78199E+00	0.33241E+00	0.25994E+00	0.98982E+00
0.73210E+03	0.78190E+00	0.33259E+00	0.26005E+00	0.99026E+00
0.73220E+03	0.78183E+00	0.33278E+00	0.26018E+00	0.99073E+00
0.73230E+03	0.78177E+00	0.33296E+00	0.26030E+00	0.99121E+00
0.73240E+03	0.78168E+00	0.33315E+00	0.26042E+00	0.99166E+00
0.73250E+03	0.78149E+00	0.33334E+00	0.26050E+00	0.99197E+00
0.73260E+03	0.78124E+00	0.33352E+00	0.26056E+00	0.99220E+00
0.73270E+03	0.78096E+00	0.33371E+00	0.26062E+00	0.99241E+00
0.73280E+03	0.78071E+00	0.33390E+00	0.26068E+00	0.99264E+00
0.73290E+03	0.78052E+00	0.33408E+00	0.26076E+00	0.99294E+00
0.73300E+03	0.78038E+00	0.33427E+00	0.26086E+00	0.99333E+00
0.73310E+03	0.78032E+00	0.33448E+00	0.26100E+00	0.99386E+00
0.73320E+03	0.78031E+00	0.33468E+00	0.26115E+00	0.99445E+00
0.73330E+03	0.78030E+00	0.33489E+00	0.26131E+00	0.99506E+00
0.73340E+03	0.78022E+00	0.33509E+00	0.26145E+00	0.99557E+00
0.73350E+03	0.77996E+00	0.33530E+00	0.26152E+00	0.99584E+00
0.73360E+03	0.77964E+00	0.33550E+00	0.26157E+00	0.99605E+00
0.73370E+03	0.77938E+00	0.33571E+00	0.26165E+00	0.99633E+00
0.73380E+03	0.77913E+00	0.33592E+00	0.26172E+00	0.99662E+00
0.73390E+03	0.77882E+00	0.33612E+00	0.26178E+00	0.99683E+00
0.73400E+03	0.77844E+00	0.33633E+00	0.26181E+00	0.99696E+00
0.73410E+03	0.77793E+00	0.33653E+00	0.26180E+00	0.99690E+00

0.73420E+03	0.77737E+00	0.33673E+00	0.26176E+00	0.99677E+00
0.73430E+03	0.77695E+00	0.33693E+00	0.26177E+00	0.99682E+00
0.73440E+03	0.77659E+00	0.33713E+00	0.26181E+00	0.99695E+00
0.73450E+03	0.77625E+00	0.33733E+00	0.26185E+00	0.99710E+00
0.73460E+03	0.77589E+00	0.33752E+00	0.26188E+00	0.99723E+00
0.73470E+03	0.77548E+00	0.33772E+00	0.26190E+00	0.99729E+00
0.73480E+03	0.77500E+00	0.33792E+00	0.26189E+00	0.99726E+00
0.73490E+03	0.77438E+00	0.33812E+00	0.26183E+00	0.99704E+00
0.73500E+03	0.77378E+00	0.33833E+00	0.26179E+00	0.99687E+00
0.73510E+03	0.77337E+00	0.33853E+00	0.26181E+00	0.99695E+00
0.73520E+03	0.77296E+00	0.33874E+00	0.26183E+00	0.99704E+00
0.73530E+03	0.77235E+00	0.33895E+00	0.26179E+00	0.99686E+00
0.73540E+03	0.77172E+00	0.33916E+00	0.26174E+00	0.99667E+00
0.73550E+03	0.77126E+00	0.33936E+00	0.26174E+00	0.99668E+00
0.73560E+03	0.77093E+00	0.33957E+00	0.26178E+00	0.99686E+00
0.73570E+03	0.77066E+00	0.33978E+00	0.26186E+00	0.99713E+00
0.73580E+03	0.77045E+00	0.33999E+00	0.26194E+00	0.99746E+00
0.73590E+03	0.77028E+00	0.34020E+00	0.26205E+00	0.99785E+00
0.73600E+03	0.77011E+00	0.34040E+00	0.26215E+00	0.99824E+00
0.73610E+03	0.76983E+00	0.34060E+00	0.26220E+00	0.99845E+00
0.73620E+03	0.76953E+00	0.34080E+00	0.26225E+00	0.99863E+00
0.73630E+03	0.76932E+00	0.34099E+00	0.26233E+00	0.99893E+00
0.73640E+03	0.76916E+00	0.34119E+00	0.26243E+00	0.99930E+00
0.73650E+03	0.76893E+00	0.34138E+00	0.26250E+00	0.99958E+00
0.73660E+03	0.76865E+00	0.34158E+00	0.26256E+00	0.99980E+00
0.73670E+03	0.76832E+00	0.34178E+00	0.26259E+00	0.99994E+00
0.73680E+03	0.76792E+00	0.34197E+00	0.26261E+00	0.10000E+01
0.73690E+03	0.76743E+00	0.34217E+00	0.26259E+00	0.99994E+00
0.73700E+03	0.76688E+00	0.34237E+00	0.26256E+00	0.99980E+00
0.73710E+03	0.76619E+00	0.34257E+00	0.26248E+00	0.99949E+00
0.73720E+03	0.76549E+00	0.34277E+00	0.26239E+00	0.99916E+00
0.73730E+03	0.76486E+00	0.34297E+00	0.26233E+00	0.99892E+00
0.73740E+03	0.76419E+00	0.34317E+00	0.26225E+00	0.99863E+00
0.73750E+03	0.76335E+00	0.34337E+00	0.26212E+00	0.99812E+00
0.73760E+03	0.76239E+00	0.34357E+00	0.26194E+00	0.99743E+00
0.73770E+03	0.76123E+00	0.34378E+00	0.26169E+00	0.99650E+00
0.73780E+03	0.76003E+00	0.34398E+00	0.26143E+00	0.99552E+00
0.73790E+03	0.75881E+00	0.34418E+00	0.26117E+00	0.99450E+00
0.73800E+03	0.75747E+00	0.34438E+00	0.26086E+00	0.99333E+00
0.73810E+03	0.75595E+00	0.34457E+00	0.26048E+00	0.99187E+00
0.73820E+03	0.75421E+00	0.34475E+00	0.26002E+00	0.99012E+00
0.73830E+03	0.75204E+00	0.34494E+00	0.25941E+00	0.98781E+00
0.73840E+03	0.74947E+00	0.34513E+00	0.25866E+00	0.98498E+00

0.73850E+03	0.74642E+00	0.34532E+00	0.25775E+00	0.98150E+00
0.73860E+03	0.74302E+00	0.34550E+00	0.25671E+00	0.97755E+00
0.73870E+03	0.73928E+00	0.34569E+00	0.25556E+00	0.97317E+00
0.73880E+03	0.73516E+00	0.34588E+00	0.25428E+00	0.96827E+00
0.73890E+03	0.73052E+00	0.34607E+00	0.25281E+00	0.96269E+00
0.73900E+03	0.72549E+00	0.34626E+00	0.25121E+00	0.95659E+00
0.73910E+03	0.72005E+00	0.34646E+00	0.24947E+00	0.94995E+00
0.73920E+03	0.71414E+00	0.34665E+00	0.24755E+00	0.94267E+00
0.73930E+03	0.70769E+00	0.34684E+00	0.24546E+00	0.93468E+00
0.73940E+03	0.70075E+00	0.34703E+00	0.24318E+00	0.92603E+00
0.73950E+03	0.69320E+00	0.34723E+00	0.24070E+00	0.91656E+00
0.73960E+03	0.68505E+00	0.34742E+00	0.23800E+00	0.90628E+00
0.73970E+03	0.67620E+00	0.34761E+00	0.23506E+00	0.89508E+00
0.73980E+03	0.66679E+00	0.34781E+00	0.23191E+00	0.88311E+00
0.73990E+03	0.65677E+00	0.34800E+00	0.22856E+00	0.87032E+00
0.74000E+03	0.64611E+00	0.34819E+00	0.22497E+00	0.85667E+00
0.74010E+03	0.63472E+00	0.34837E+00	0.22112E+00	0.84200E+00
0.74020E+03	0.62277E+00	0.34855E+00	0.21707E+00	0.82657E+00
0.74030E+03	0.61023E+00	0.34873E+00	0.21280E+00	0.81034E+00
0.74040E+03	0.59724E+00	0.34890E+00	0.20838E+00	0.79349E+00
0.74050E+03	0.58387E+00	0.34908E+00	0.20382E+00	0.77613E+00
0.74060E+03	0.57017E+00	0.34926E+00	0.19914E+00	0.75830E+00
0.74070E+03	0.55614E+00	0.34944E+00	0.19434E+00	0.74001E+00
0.74080E+03	0.54182E+00	0.34962E+00	0.18943E+00	0.72134E+00
0.74090E+03	0.52718E+00	0.34980E+00	0.18441E+00	0.70221E+00
0.74100E+03	0.51221E+00	0.34999E+00	0.17927E+00	0.68264E+00
0.74110E+03	0.49688E+00	0.35017E+00	0.17399E+00	0.66255E+00
0.74120E+03	0.48130E+00	0.35036E+00	0.16863E+00	0.64212E+00
0.74130E+03	0.46558E+00	0.35054E+00	0.16321E+00	0.62148E+00
0.74140E+03	0.44978E+00	0.35073E+00	0.15775E+00	0.60071E+00
0.74150E+03	0.43385E+00	0.35092E+00	0.15225E+00	0.57974E+00
0.74160E+03	0.41788E+00	0.35110E+00	0.14672E+00	0.55870E+00
0.74170E+03	0.40183E+00	0.35129E+00	0.14116E+00	0.53752E+00
0.74180E+03	0.38576E+00	0.35147E+00	0.13559E+00	0.51630E+00
0.74190E+03	0.36975E+00	0.35166E+00	0.13003E+00	0.49513E+00
0.74200E+03	0.35393E+00	0.35185E+00	0.12453E+00	0.47420E+00
0.74210E+03	0.33836E+00	0.35202E+00	0.11911E+00	0.45356E+00
0.74220E+03	0.32311E+00	0.35220E+00	0.11380E+00	0.43334E+00
0.74230E+03	0.30810E+00	0.35237E+00	0.10857E+00	0.41342E+00
0.74240E+03	0.29341E+00	0.35255E+00	0.10344E+00	0.39390E+00
0.74250E+03	0.27904E+00	0.35273E+00	0.98424E-01	0.37479E+00
0.74260E+03	0.26509E+00	0.35290E+00	0.93549E-01	0.35623E+00
0.74270E+03	0.25154E+00	0.35308E+00	0.88812E-01	0.33819E+00

0.74280E+03	0.23855E+00	0.35325E+00	0.84267E-01	0.32088E+00
0.74290E+03	0.22620E+00	0.35342E+00	0.79943E-01	0.30442E+00
0.74300E+03	0.21446E+00	0.35359E+00	0.75832E-01	0.28876E+00
0.74310E+03	0.20325E+00	0.35376E+00	0.71902E-01	0.27380E+00
0.74320E+03	0.19258E+00	0.35394E+00	0.68161E-01	0.25955E+00
0.74330E+03	0.18241E+00	0.35411E+00	0.64595E-01	0.24597E+00
0.74340E+03	0.17271E+00	0.35428E+00	0.61188E-01	0.23300E+00
0.74350E+03	0.16334E+00	0.35446E+00	0.57896E-01	0.22046E+00
0.74360E+03	0.15432E+00	0.35463E+00	0.54727E-01	0.20839E+00
0.74370E+03	0.14560E+00	0.35480E+00	0.51661E-01	0.19672E+00
0.74380E+03	0.13720E+00	0.35498E+00	0.48704E-01	0.18546E+00
0.74390E+03	0.12907E+00	0.35515E+00	0.45841E-01	0.17456E+00
0.74400E+03	0.12133E+00	0.35532E+00	0.43111E-01	0.16416E+00
0.74410E+03	0.11398E+00	0.35549E+00	0.40517E-01	0.15429E+00
0.74420E+03	0.10704E+00	0.35566E+00	0.38070E-01	0.14497E+00
0.74430E+03	0.10061E+00	0.35582E+00	0.35798E-01	0.13632E+00
0.74440E+03	0.94610E-01	0.35599E+00	0.33680E-01	0.12825E+00
0.74450E+03	0.89034E-01	0.35615E+00	0.31710E-01	0.12075E+00
0.74460E+03	0.83846E-01	0.35632E+00	0.29876E-01	0.11377E+00
0.74470E+03	0.78950E-01	0.35650E+00	0.28146E-01	0.10718E+00
0.74480E+03	0.74400E-01	0.35668E+00	0.26537E-01	0.10105E+00
0.74490E+03	0.70176E-01	0.35686E+00	0.25043E-01	0.95364E-01
0.74500E+03	0.66228E-01	0.35705E+00	0.23646E-01	0.90043E-01
0.74510E+03	0.62500E-01	0.35723E+00	0.22327E-01	0.85018E-01
0.74520E+03	0.59014E-01	0.35741E+00	0.21092E-01	0.80317E-01
0.74530E+03	0.55865E-01	0.35759E+00	0.19977E-01	0.76070E-01
0.74540E+03	0.53070E-01	0.35777E+00	0.18987E-01	0.72301E-01
0.74550E+03	0.50569E-01	0.35796E+00	0.18101E-01	0.68929E-01
0.74560E+03	0.48272E-01	0.35814E+00	0.17288E-01	0.65831E-01
0.74570E+03	0.46117E-01	0.35832E+00	0.16525E-01	0.62926E-01
0.74580E+03	0.43964E-01	0.35850E+00	0.15761E-01	0.60018E-01
0.74590E+03	0.41850E-01	0.35869E+00	0.15011E-01	0.57161E-01
0.74600E+03	0.39744E-01	0.35887E+00	0.14263E-01	0.54312E-01
0.74610E+03	0.37740E-01	0.35905E+00	0.13550E-01	0.51599E-01
0.74620E+03	0.35839E-01	0.35923E+00	0.12874E-01	0.49024E-01
0.74630E+03	0.34036E-01	0.35941E+00	0.12233E-01	0.46582E-01
0.74640E+03	0.32357E-01	0.35959E+00	0.11635E-01	0.44306E-01
0.74650E+03	0.30852E-01	0.35977E+00	0.11099E-01	0.42266E-01
0.74660E+03	0.29434E-01	0.35995E+00	0.10595E-01	0.40344E-01
0.74670E+03	0.28025E-01	0.36013E+00	0.10093E-01	0.38432E-01
0.74680E+03	0.26657E-01	0.36031E+00	0.96049E-02	0.36575E-01
0.74690E+03	0.25411E-01	0.36050E+00	0.91607E-02	0.34883E-01
0.74700E+03	0.24232E-01	0.36068E+00	0.87399E-02	0.33281E-01

0.74710E+03	0.23054E-01	0.36087E+00	0.83192E-02	0.31679E-01
0.74720E+03	0.21901E-01	0.36105E+00	0.79074E-02	0.30111E-01
0.74730E+03	0.20786E-01	0.36123E+00	0.75086E-02	0.28592E-01
0.74740E+03	0.19710E-01	0.36142E+00	0.71236E-02	0.27126E-01
0.74750E+03	0.18719E-01	0.36160E+00	0.67689E-02	0.25775E-01
0.74760E+03	0.17765E-01	0.36179E+00	0.64271E-02	0.24474E-01
0.74770E+03	0.16821E-01	0.36197E+00	0.60886E-02	0.23185E-01
0.74780E+03	0.15926E-01	0.36215E+00	0.57675E-02	0.21962E-01
0.74790E+03	0.15152E-01	0.36234E+00	0.54901E-02	0.20906E-01
0.74800E+03	0.14471E-01	0.36252E+00	0.52460E-02	0.19976E-01
0.74810E+03	0.13836E-01	0.36270E+00	0.50182E-02	0.19109E-01
0.74820E+03	0.13208E-01	0.36288E+00	0.47931E-02	0.18252E-01
0.74830E+03	0.12583E-01	0.36306E+00	0.45683E-02	0.17396E-01
0.74840E+03	0.11959E-01	0.36325E+00	0.43440E-02	0.16542E-01
0.74850E+03	0.11342E-01	0.36343E+00	0.41220E-02	0.15696E-01
0.74860E+03	0.10727E-01	0.36361E+00	0.39006E-02	0.14853E-01
0.74870E+03	0.10122E-01	0.36380E+00	0.36824E-02	0.14022E-01
0.74880E+03	0.95332E-02	0.36398E+00	0.34699E-02	0.13213E-01
0.74890E+03	0.89453E-02	0.36417E+00	0.32576E-02	0.12405E-01
0.74900E+03	0.83650E-02	0.36435E+00	0.30478E-02	0.11606E-01
0.74910E+03	0.78199E-02	0.36454E+00	0.28506E-02	0.10855E-01
0.74920E+03	0.72754E-02	0.36472E+00	0.26535E-02	0.10104E-01
0.74930E+03	0.67400E-02	0.36491E+00	0.24595E-02	0.93655E-02
0.74940E+03	0.62082E-02	0.36509E+00	0.22665E-02	0.86308E-02
0.74950E+03	0.56797E-02	0.36527E+00	0.20747E-02	0.79002E-02
0.74960E+03	0.51797E-02	0.36546E+00	0.18930E-02	0.72083E-02
0.74970E+03	0.46913E-02	0.36564E+00	0.17153E-02	0.65319E-02
0.74980E+03	0.42038E-02	0.36583E+00	0.15379E-02	0.58560E-02
0.74990E+03	0.37313E-02	0.36601E+00	0.13657E-02	0.52004E-02
0.75000E+03	0.32634E-02	0.36620E+00	0.11950E-02	0.45506E-02
0.75010E+03	0.28028E-02	0.36638E+00	0.10269E-02	0.39103E-02
0.75020E+03	0.23522E-02	0.36656E+00	0.86223E-03	0.32833E-02
0.75030E+03	0.19051E-02	0.36674E+00	0.69868E-03	0.26605E-02
0.75040E+03	0.14673E-02	0.36692E+00	0.53838E-03	0.20501E-02
0.75050E+03	0.10416E-02	0.36710E+00	0.38236E-03	0.14560E-02
0.75060E+03	0.61758E-03	0.36728E+00	0.22683E-03	0.86374E-03
0.75070E+03	0.19795E-03	0.36746E+00	0.72738E-04	0.27698E-03
0.75080E+03	0.00000E+00	0.36764E+00	0.00000E+00	0.00000E+00
Channel 7				
Wavenumber	HIRS Filter Transmittance	Optical Element Transmittance	Product of the HIRS Filter and Optical Element Transmittances	Normalized Value of Column 4

0.72910E+03	0.00000E+00	0.32747E+00	0.00000E+00	0.00000E+00
0.72920E+03	0.75515E-04	0.32763E+00	0.24741E-04	0.80838E-04
0.72930E+03	0.21436E-03	0.32778E+00	0.70263E-04	0.22957E-03
0.72940E+03	0.35370E-03	0.32794E+00	0.11599E-03	0.37898E-03
0.72950E+03	0.49371E-03	0.32809E+00	0.16198E-03	0.52925E-03
0.72960E+03	0.63469E-03	0.32824E+00	0.20833E-03	0.68070E-03
0.72970E+03	0.77637E-03	0.32840E+00	0.25496E-03	0.83304E-03
0.72980E+03	0.92090E-03	0.32855E+00	0.30256E-03	0.98858E-03
0.72990E+03	0.10676E-02	0.32870E+00	0.35091E-03	0.11466E-02
0.73000E+03	0.12221E-02	0.32885E+00	0.40190E-03	0.13132E-02
0.73010E+03	0.13807E-02	0.32903E+00	0.45430E-03	0.14844E-02
0.73020E+03	0.15414E-02	0.32920E+00	0.50744E-03	0.16580E-02
0.73030E+03	0.17024E-02	0.32937E+00	0.56073E-03	0.18321E-02
0.73040E+03	0.18667E-02	0.32954E+00	0.61515E-03	0.20099E-02
0.73050E+03	0.20386E-02	0.32972E+00	0.67215E-03	0.21962E-02
0.73060E+03	0.22107E-02	0.32989E+00	0.72929E-03	0.23829E-02
0.73070E+03	0.23887E-02	0.33006E+00	0.78842E-03	0.25760E-02
0.73080E+03	0.25774E-02	0.33024E+00	0.85115E-03	0.27810E-02
0.73090E+03	0.27692E-02	0.33041E+00	0.91498E-03	0.29896E-02
0.73100E+03	0.29629E-02	0.33058E+00	0.97948E-03	0.32003E-02
0.73110E+03	0.31568E-02	0.33076E+00	0.10441E-02	0.34115E-02
0.73120E+03	0.33540E-02	0.33094E+00	0.11100E-02	0.36267E-02
0.73130E+03	0.35538E-02	0.33112E+00	0.11768E-02	0.38449E-02
0.73140E+03	0.37655E-02	0.33131E+00	0.12475E-02	0.40761E-02
0.73150E+03	0.39796E-02	0.33149E+00	0.13192E-02	0.43103E-02
0.73160E+03	0.41995E-02	0.33167E+00	0.13929E-02	0.45510E-02
0.73170E+03	0.44293E-02	0.33186E+00	0.14699E-02	0.48027E-02
0.73180E+03	0.46646E-02	0.33204E+00	0.15488E-02	0.50606E-02
0.73190E+03	0.49024E-02	0.33222E+00	0.16287E-02	0.53215E-02
0.73200E+03	0.51412E-02	0.33241E+00	0.17090E-02	0.55838E-02
0.73210E+03	0.53807E-02	0.33259E+00	0.17896E-02	0.58472E-02
0.73220E+03	0.56207E-02	0.33278E+00	0.18705E-02	0.61114E-02
0.73230E+03	0.58657E-02	0.33296E+00	0.19531E-02	0.63814E-02
0.73240E+03	0.61123E-02	0.33315E+00	0.20363E-02	0.66534E-02
0.73250E+03	0.63718E-02	0.33334E+00	0.21240E-02	0.69398E-02
0.73260E+03	0.66440E-02	0.33352E+00	0.22159E-02	0.72402E-02
0.73270E+03	0.69384E-02	0.33371E+00	0.23154E-02	0.75653E-02
0.73280E+03	0.72347E-02	0.33390E+00	0.24157E-02	0.78928E-02
0.73290E+03	0.75635E-02	0.33408E+00	0.25268E-02	0.82561E-02
0.73300E+03	0.79083E-02	0.33427E+00	0.26435E-02	0.86373E-02
0.73310E+03	0.82538E-02	0.33448E+00	0.27607E-02	0.90201E-02
0.73320E+03	0.86059E-02	0.33468E+00	0.28802E-02	0.94107E-02
0.73330E+03	0.89699E-02	0.33489E+00	0.30039E-02	0.98149E-02

0.73340E+03	0.93365E-02	0.33509E+00	0.31286E-02	0.10222E-01
0.73350E+03	0.97059E-02	0.33530E+00	0.32544E-02	0.10633E-01
0.73360E+03	0.10078E-01	0.33550E+00	0.33812E-02	0.11047E-01
0.73370E+03	0.10457E-01	0.33571E+00	0.35105E-02	0.11470E-01
0.73380E+03	0.10856E-01	0.33592E+00	0.36467E-02	0.11915E-01
0.73390E+03	0.11271E-01	0.33612E+00	0.37885E-02	0.12379E-01
0.73400E+03	0.11689E-01	0.33633E+00	0.39315E-02	0.12846E-01
0.73410E+03	0.12111E-01	0.33653E+00	0.40758E-02	0.13317E-01
0.73420E+03	0.12548E-01	0.33673E+00	0.42251E-02	0.13805E-01
0.73430E+03	0.12988E-01	0.33693E+00	0.43761E-02	0.14298E-01
0.73440E+03	0.13439E-01	0.33713E+00	0.45308E-02	0.14804E-01
0.73450E+03	0.13891E-01	0.33733E+00	0.46859E-02	0.15310E-01
0.73460E+03	0.14344E-01	0.33752E+00	0.48413E-02	0.15818E-01
0.73470E+03	0.14810E-01	0.33772E+00	0.50017E-02	0.16342E-01
0.73480E+03	0.15373E-01	0.33792E+00	0.51949E-02	0.16973E-01
0.73490E+03	0.16044E-01	0.33812E+00	0.54248E-02	0.17725E-01
0.73500E+03	0.16782E-01	0.33833E+00	0.56779E-02	0.18552E-01
0.73510E+03	0.17558E-01	0.33853E+00	0.59441E-02	0.19422E-01
0.73520E+03	0.18385E-01	0.33874E+00	0.62278E-02	0.20348E-01
0.73530E+03	0.19292E-01	0.33895E+00	0.65389E-02	0.21365E-01
0.73540E+03	0.20304E-01	0.33916E+00	0.68861E-02	0.22499E-01
0.73550E+03	0.21451E-01	0.33936E+00	0.72797E-02	0.23785E-01
0.73560E+03	0.22718E-01	0.33957E+00	0.77145E-02	0.25206E-01
0.73570E+03	0.24118E-01	0.33978E+00	0.81949E-02	0.26776E-01
0.73580E+03	0.25647E-01	0.33999E+00	0.87198E-02	0.28491E-01
0.73590E+03	0.27293E-01	0.34020E+00	0.92851E-02	0.30338E-01
0.73600E+03	0.28991E-01	0.34040E+00	0.98685E-02	0.32244E-01
0.73610E+03	0.30690E-01	0.34060E+00	0.10453E-01	0.34154E-01
0.73620E+03	0.32402E-01	0.34080E+00	0.11043E-01	0.36080E-01
0.73630E+03	0.34224E-01	0.34099E+00	0.11670E-01	0.38131E-01
0.73640E+03	0.36190E-01	0.34119E+00	0.12347E-01	0.40344E-01
0.73650E+03	0.38353E-01	0.34138E+00	0.13093E-01	0.42779E-01
0.73660E+03	0.40715E-01	0.34158E+00	0.13907E-01	0.45441E-01
0.73670E+03	0.43293E-01	0.34178E+00	0.14797E-01	0.48346E-01
0.73680E+03	0.46062E-01	0.34197E+00	0.15752E-01	0.51468E-01
0.73690E+03	0.49014E-01	0.34217E+00	0.16771E-01	0.54798E-01
0.73700E+03	0.52187E-01	0.34237E+00	0.17867E-01	0.58379E-01
0.73710E+03	0.55662E-01	0.34257E+00	0.19068E-01	0.62303E-01
0.73720E+03	0.59469E-01	0.34277E+00	0.20384E-01	0.66603E-01
0.73730E+03	0.63706E-01	0.34297E+00	0.21849E-01	0.71390E-01
0.73740E+03	0.68399E-01	0.34317E+00	0.23473E-01	0.76693E-01
0.73750E+03	0.73552E-01	0.34337E+00	0.25256E-01	0.82520E-01
0.73760E+03	0.79201E-01	0.34357E+00	0.27211E-01	0.88909E-01

0.73770E+03	0.85460E-01	0.34378E+00	0.29379E-01	0.95992E-01
0.73780E+03	0.92382E-01	0.34398E+00	0.31777E-01	0.10383E+00
0.73790E+03	0.99994E-01	0.34418E+00	0.34416E-01	0.11245E+00
0.73800E+03	0.10831E+00	0.34438E+00	0.37301E-01	0.12188E+00
0.73810E+03	0.11740E+00	0.34457E+00	0.40452E-01	0.13217E+00
0.73820E+03	0.12726E+00	0.34475E+00	0.43875E-01	0.14335E+00
0.73830E+03	0.13790E+00	0.34494E+00	0.47568E-01	0.15542E+00
0.73840E+03	0.14934E+00	0.34513E+00	0.51542E-01	0.16841E+00
0.73850E+03	0.16165E+00	0.34532E+00	0.55820E-01	0.18238E+00
0.73860E+03	0.17487E+00	0.34550E+00	0.60420E-01	0.19741E+00
0.73870E+03	0.18909E+00	0.34569E+00	0.65365E-01	0.21357E+00
0.73880E+03	0.20432E+00	0.34588E+00	0.70669E-01	0.23090E+00
0.73890E+03	0.22061E+00	0.34607E+00	0.76347E-01	0.24945E+00
0.73900E+03	0.23797E+00	0.34626E+00	0.82401E-01	0.26923E+00
0.73910E+03	0.25637E+00	0.34646E+00	0.88822E-01	0.29021E+00
0.73920E+03	0.27573E+00	0.34665E+00	0.95582E-01	0.31230E+00
0.73930E+03	0.29593E+00	0.34684E+00	0.10264E+00	0.33537E+00
0.73940E+03	0.31687E+00	0.34703E+00	0.10997E+00	0.35930E+00
0.73950E+03	0.33850E+00	0.34723E+00	0.11754E+00	0.38404E+00
0.73960E+03	0.36073E+00	0.34742E+00	0.12532E+00	0.40948E+00
0.73970E+03	0.38344E+00	0.34761E+00	0.13329E+00	0.43550E+00
0.73980E+03	0.40649E+00	0.34781E+00	0.14138E+00	0.46194E+00
0.73990E+03	0.42974E+00	0.34800E+00	0.14955E+00	0.48863E+00
0.74000E+03	0.45303E+00	0.34819E+00	0.15774E+00	0.51540E+00
0.74010E+03	0.47621E+00	0.34837E+00	0.16590E+00	0.54204E+00
0.74020E+03	0.49912E+00	0.34855E+00	0.17397E+00	0.56841E+00
0.74030E+03	0.52172E+00	0.34873E+00	0.18194E+00	0.59446E+00
0.74040E+03	0.54387E+00	0.34890E+00	0.18976E+00	0.62000E+00
0.74050E+03	0.56537E+00	0.34908E+00	0.19736E+00	0.64484E+00
0.74060E+03	0.58604E+00	0.34926E+00	0.20468E+00	0.66876E+00
0.74070E+03	0.60576E+00	0.34944E+00	0.21167E+00	0.69161E+00
0.74080E+03	0.62434E+00	0.34962E+00	0.21828E+00	0.71321E+00
0.74090E+03	0.64169E+00	0.34980E+00	0.22447E+00	0.73341E+00
0.74100E+03	0.65770E+00	0.34999E+00	0.23019E+00	0.75210E+00
0.74110E+03	0.67234E+00	0.35017E+00	0.23544E+00	0.76926E+00
0.74120E+03	0.68553E+00	0.35036E+00	0.24018E+00	0.78476E+00
0.74130E+03	0.69713E+00	0.35054E+00	0.24437E+00	0.79846E+00
0.74140E+03	0.70709E+00	0.35073E+00	0.24800E+00	0.81029E+00
0.74150E+03	0.71543E+00	0.35092E+00	0.25105E+00	0.82028E+00
0.74160E+03	0.72215E+00	0.35110E+00	0.25355E+00	0.82844E+00
0.74170E+03	0.72734E+00	0.35129E+00	0.25551E+00	0.83483E+00
0.74180E+03	0.73105E+00	0.35147E+00	0.25694E+00	0.83953E+00
0.74190E+03	0.73335E+00	0.35166E+00	0.25789E+00	0.84262E+00

0.74200E+03	0.73433E+00	0.35185E+00	0.25837E+00	0.84420E+00
0.74210E+03	0.73405E+00	0.35202E+00	0.25840E+00	0.84430E+00
0.74220E+03	0.73263E+00	0.35220E+00	0.25803E+00	0.84308E+00
0.74230E+03	0.73024E+00	0.35237E+00	0.25732E+00	0.84075E+00
0.74240E+03	0.72703E+00	0.35255E+00	0.25631E+00	0.83747E+00
0.74250E+03	0.72312E+00	0.35273E+00	0.25506E+00	0.83338E+00
0.74260E+03	0.71866E+00	0.35290E+00	0.25362E+00	0.82865E+00
0.74270E+03	0.71374E+00	0.35308E+00	0.25201E+00	0.82339E+00
0.74280E+03	0.70852E+00	0.35325E+00	0.25028E+00	0.81776E+00
0.74290E+03	0.70311E+00	0.35342E+00	0.24849E+00	0.81192E+00
0.74300E+03	0.69762E+00	0.35359E+00	0.24667E+00	0.80597E+00
0.74310E+03	0.69210E+00	0.35376E+00	0.24484E+00	0.79998E+00
0.74320E+03	0.68662E+00	0.35394E+00	0.24302E+00	0.79404E+00
0.74330E+03	0.68125E+00	0.35411E+00	0.24124E+00	0.78821E+00
0.74340E+03	0.67603E+00	0.35428E+00	0.23951E+00	0.78255E+00
0.74350E+03	0.67099E+00	0.35446E+00	0.23784E+00	0.77710E+00
0.74360E+03	0.66621E+00	0.35463E+00	0.23626E+00	0.77194E+00
0.74370E+03	0.66181E+00	0.35480E+00	0.23481E+00	0.76722E+00
0.74380E+03	0.65784E+00	0.35498E+00	0.23352E+00	0.76299E+00
0.74390E+03	0.65432E+00	0.35515E+00	0.23238E+00	0.75927E+00
0.74400E+03	0.65127E+00	0.35532E+00	0.23141E+00	0.75611E+00
0.74410E+03	0.64871E+00	0.35549E+00	0.23061E+00	0.75348E+00
0.74420E+03	0.64664E+00	0.35566E+00	0.22998E+00	0.75143E+00
0.74430E+03	0.64510E+00	0.35582E+00	0.22954E+00	0.74999E+00
0.74440E+03	0.64411E+00	0.35599E+00	0.22929E+00	0.74918E+00
0.74450E+03	0.64367E+00	0.35615E+00	0.22925E+00	0.74903E+00
0.74460E+03	0.64377E+00	0.35632E+00	0.22939E+00	0.74949E+00
0.74470E+03	0.64430E+00	0.35650E+00	0.22970E+00	0.75050E+00
0.74480E+03	0.64527E+00	0.35668E+00	0.23016E+00	0.75200E+00
0.74490E+03	0.64667E+00	0.35686E+00	0.23077E+00	0.75402E+00
0.74500E+03	0.64855E+00	0.35705E+00	0.23156E+00	0.75659E+00
0.74510E+03	0.65094E+00	0.35723E+00	0.23253E+00	0.75977E+00
0.74520E+03	0.65384E+00	0.35741E+00	0.23369E+00	0.76355E+00
0.74530E+03	0.65720E+00	0.35759E+00	0.23501E+00	0.76786E+00
0.74540E+03	0.66095E+00	0.35777E+00	0.23647E+00	0.77263E+00
0.74550E+03	0.66496E+00	0.35796E+00	0.23802E+00	0.77771E+00
0.74560E+03	0.66918E+00	0.35814E+00	0.23966E+00	0.78306E+00
0.74570E+03	0.67365E+00	0.35832E+00	0.24138E+00	0.78868E+00
0.74580E+03	0.67835E+00	0.35850E+00	0.24319E+00	0.79460E+00
0.74590E+03	0.68327E+00	0.35869E+00	0.24508E+00	0.80077E+00
0.74600E+03	0.68839E+00	0.35887E+00	0.24704E+00	0.80717E+00
0.74610E+03	0.69371E+00	0.35905E+00	0.24907E+00	0.81381E+00
0.74620E+03	0.69919E+00	0.35923E+00	0.25117E+00	0.82066E+00

0.74630E+03	0.70483E+00	0.35941E+00	0.25332E+00	0.82769E+00
0.74640E+03	0.71057E+00	0.35959E+00	0.25551E+00	0.83485E+00
0.74650E+03	0.71638E+00	0.35977E+00	0.25773E+00	0.84209E+00
0.74660E+03	0.72219E+00	0.35995E+00	0.25995E+00	0.84935E+00
0.74670E+03	0.72801E+00	0.36013E+00	0.26218E+00	0.85664E+00
0.74680E+03	0.73380E+00	0.36031E+00	0.26440E+00	0.86389E+00
0.74690E+03	0.73955E+00	0.36050E+00	0.26661E+00	0.87110E+00
0.74700E+03	0.74525E+00	0.36068E+00	0.26880E+00	0.87825E+00
0.74710E+03	0.75086E+00	0.36087E+00	0.27096E+00	0.88533E+00
0.74720E+03	0.75639E+00	0.36105E+00	0.27310E+00	0.89230E+00
0.74730E+03	0.76187E+00	0.36123E+00	0.27521E+00	0.89922E+00
0.74740E+03	0.76731E+00	0.36142E+00	0.27732E+00	0.90609E+00
0.74750E+03	0.77268E+00	0.36160E+00	0.27940E+00	0.91290E+00
0.74760E+03	0.77799E+00	0.36179E+00	0.28146E+00	0.91964E+00
0.74770E+03	0.78320E+00	0.36197E+00	0.28350E+00	0.92628E+00
0.74780E+03	0.78830E+00	0.36215E+00	0.28549E+00	0.93278E+00
0.74790E+03	0.79322E+00	0.36234E+00	0.28741E+00	0.93908E+00
0.74800E+03	0.79792E+00	0.36252E+00	0.28927E+00	0.94513E+00
0.74810E+03	0.80236E+00	0.36270E+00	0.29102E+00	0.95086E+00
0.74820E+03	0.80654E+00	0.36288E+00	0.29268E+00	0.95628E+00
0.74830E+03	0.81044E+00	0.36306E+00	0.29424E+00	0.96140E+00
0.74840E+03	0.81410E+00	0.36325E+00	0.29572E+00	0.96621E+00
0.74850E+03	0.81750E+00	0.36343E+00	0.29710E+00	0.97074E+00
0.74860E+03	0.82066E+00	0.36361E+00	0.29840E+00	0.97498E+00
0.74870E+03	0.82355E+00	0.36380E+00	0.29960E+00	0.97891E+00
0.74880E+03	0.82618E+00	0.36398E+00	0.30072E+00	0.98255E+00
0.74890E+03	0.82852E+00	0.36417E+00	0.30172E+00	0.98582E+00
0.74900E+03	0.83057E+00	0.36435E+00	0.30262E+00	0.98877E+00
0.74910E+03	0.83230E+00	0.36454E+00	0.30341E+00	0.99133E+00
0.74920E+03	0.83368E+00	0.36472E+00	0.30406E+00	0.99348E+00
0.74930E+03	0.83468E+00	0.36491E+00	0.30458E+00	0.99517E+00
0.74940E+03	0.83532E+00	0.36509E+00	0.30497E+00	0.99644E+00
0.74950E+03	0.83571E+00	0.36527E+00	0.30527E+00	0.99741E+00
0.74960E+03	0.83592E+00	0.36546E+00	0.30549E+00	0.99816E+00
0.74970E+03	0.83601E+00	0.36564E+00	0.30568E+00	0.99877E+00
0.74980E+03	0.83602E+00	0.36583E+00	0.30584E+00	0.99928E+00
0.74990E+03	0.83591E+00	0.36601E+00	0.30595E+00	0.99966E+00
0.75000E+03	0.83569E+00	0.36620E+00	0.30603E+00	0.99989E+00
0.75010E+03	0.83536E+00	0.36638E+00	0.30606E+00	0.10000E+01
0.75020E+03	0.83494E+00	0.36656E+00	0.30606E+00	0.99999E+00
0.75030E+03	0.83444E+00	0.36674E+00	0.30602E+00	0.99989E+00
0.75040E+03	0.83384E+00	0.36692E+00	0.30596E+00	0.99967E+00
0.75050E+03	0.83313E+00	0.36710E+00	0.30585E+00	0.99931E+00

0.75060E+03	0.83231E+00	0.36728E+00	0.30569E+00	0.99881E+00
0.75070E+03	0.83144E+00	0.36746E+00	0.30553E+00	0.99826E+00
0.75080E+03	0.83055E+00	0.36764E+00	0.30535E+00	0.99768E+00
0.75090E+03	0.82966E+00	0.36782E+00	0.30517E+00	0.99709E+00
0.75100E+03	0.82876E+00	0.36800E+00	0.30499E+00	0.99650E+00
0.75110E+03	0.82785E+00	0.36818E+00	0.30480E+00	0.99589E+00
0.75120E+03	0.82691E+00	0.36836E+00	0.30460E+00	0.99525E+00
0.75130E+03	0.82590E+00	0.36854E+00	0.30438E+00	0.99451E+00
0.75140E+03	0.82479E+00	0.36872E+00	0.30412E+00	0.99366E+00
0.75150E+03	0.82367E+00	0.36890E+00	0.30385E+00	0.99280E+00
0.75160E+03	0.82257E+00	0.36908E+00	0.30360E+00	0.99196E+00
0.75170E+03	0.82143E+00	0.36926E+00	0.30332E+00	0.99106E+00
0.75180E+03	0.82019E+00	0.36944E+00	0.30301E+00	0.99006E+00
0.75190E+03	0.81886E+00	0.36962E+00	0.30267E+00	0.98893E+00
0.75200E+03	0.81742E+00	0.36980E+00	0.30229E+00	0.98768E+00
0.75210E+03	0.81595E+00	0.36998E+00	0.30188E+00	0.98636E+00
0.75220E+03	0.81447E+00	0.37015E+00	0.30148E+00	0.98503E+00
0.75230E+03	0.81299E+00	0.37033E+00	0.30107E+00	0.98371E+00
0.75240E+03	0.81150E+00	0.37051E+00	0.30067E+00	0.98240E+00
0.75250E+03	0.80993E+00	0.37070E+00	0.30024E+00	0.98099E+00
0.75260E+03	0.80825E+00	0.37088E+00	0.29977E+00	0.97944E+00
0.75270E+03	0.80639E+00	0.37107E+00	0.29923E+00	0.97769E+00
0.75280E+03	0.80435E+00	0.37126E+00	0.29862E+00	0.97570E+00
0.75290E+03	0.80215E+00	0.37144E+00	0.29795E+00	0.97351E+00
0.75300E+03	0.79979E+00	0.37163E+00	0.29722E+00	0.97114E+00
0.75310E+03	0.79728E+00	0.37181E+00	0.29644E+00	0.96857E+00
0.75320E+03	0.79460E+00	0.37200E+00	0.29559E+00	0.96579E+00
0.75330E+03	0.79173E+00	0.37218E+00	0.29467E+00	0.96278E+00
0.75340E+03	0.78865E+00	0.37237E+00	0.29367E+00	0.95951E+00
0.75350E+03	0.78530E+00	0.37255E+00	0.29256E+00	0.95591E+00
0.75360E+03	0.78162E+00	0.37273E+00	0.29133E+00	0.95189E+00
0.75370E+03	0.77759E+00	0.37292E+00	0.28998E+00	0.94745E+00
0.75380E+03	0.77320E+00	0.37310E+00	0.28848E+00	0.94257E+00
0.75390E+03	0.76846E+00	0.37328E+00	0.28686E+00	0.93726E+00
0.75400E+03	0.76339E+00	0.37347E+00	0.28510E+00	0.93152E+00
0.75410E+03	0.75802E+00	0.37364E+00	0.28323E+00	0.92541E+00
0.75420E+03	0.75238E+00	0.37382E+00	0.28125E+00	0.91895E+00
0.75430E+03	0.74637E+00	0.37399E+00	0.27913E+00	0.91202E+00
0.75440E+03	0.73989E+00	0.37416E+00	0.27683E+00	0.90451E+00
0.75450E+03	0.73298E+00	0.37433E+00	0.27437E+00	0.89647E+00
0.75460E+03	0.72563E+00	0.37450E+00	0.27175E+00	0.88789E+00
0.75470E+03	0.71784E+00	0.37467E+00	0.26895E+00	0.87875E+00
0.75480E+03	0.70961E+00	0.37484E+00	0.26599E+00	0.86907E+00

0.75490E+03	0.70102E+00	0.37501E+00	0.26289E+00	0.85894E+00
0.75500E+03	0.69205E+00	0.37518E+00	0.25964E+00	0.84834E+00
0.75510E+03	0.68266E+00	0.37535E+00	0.25624E+00	0.83721E+00
0.75520E+03	0.67285E+00	0.37552E+00	0.25267E+00	0.82555E+00
0.75530E+03	0.66270E+00	0.37569E+00	0.24897E+00	0.81346E+00
0.75540E+03	0.65226E+00	0.37586E+00	0.24516E+00	0.80101E+00
0.75550E+03	0.64154E+00	0.37603E+00	0.24124E+00	0.78821E+00
0.75560E+03	0.63053E+00	0.37620E+00	0.23721E+00	0.77503E+00
0.75570E+03	0.61923E+00	0.37637E+00	0.23306E+00	0.76149E+00
0.75580E+03	0.60763E+00	0.37654E+00	0.22880E+00	0.74757E+00
0.75590E+03	0.59577E+00	0.37671E+00	0.22443E+00	0.73330E+00
0.75600E+03	0.58363E+00	0.37688E+00	0.21996E+00	0.71869E+00
0.75610E+03	0.57124E+00	0.37704E+00	0.21538E+00	0.70373E+00
0.75620E+03	0.55863E+00	0.37720E+00	0.21072E+00	0.68848E+00
0.75630E+03	0.54585E+00	0.37736E+00	0.20598E+00	0.67302E+00
0.75640E+03	0.53293E+00	0.37752E+00	0.20119E+00	0.65736E+00
0.75650E+03	0.51992E+00	0.37768E+00	0.19636E+00	0.64159E+00
0.75660E+03	0.50686E+00	0.37784E+00	0.19151E+00	0.62574E+00
0.75670E+03	0.49379E+00	0.37799E+00	0.18665E+00	0.60985E+00
0.75680E+03	0.48067E+00	0.37815E+00	0.18177E+00	0.59390E+00
0.75690E+03	0.46749E+00	0.37831E+00	0.17685E+00	0.57785E+00
0.75700E+03	0.45422E+00	0.37847E+00	0.17191E+00	0.56168E+00
0.75710E+03	0.44095E+00	0.37863E+00	0.16696E+00	0.54550E+00
0.75720E+03	0.42770E+00	0.37879E+00	0.16201E+00	0.52934E+00
0.75730E+03	0.41458E+00	0.37895E+00	0.15710E+00	0.51331E+00
0.75740E+03	0.40163E+00	0.37911E+00	0.15226E+00	0.49748E+00
0.75750E+03	0.38893E+00	0.37927E+00	0.14751E+00	0.48197E+00
0.75760E+03	0.37648E+00	0.37942E+00	0.14284E+00	0.46672E+00
0.75770E+03	0.36419E+00	0.37958E+00	0.13824E+00	0.45168E+00
0.75780E+03	0.35207E+00	0.37974E+00	0.13369E+00	0.43683E+00
0.75790E+03	0.34017E+00	0.37990E+00	0.12923E+00	0.42225E+00
0.75800E+03	0.32847E+00	0.38006E+00	0.12484E+00	0.40789E+00
0.75810E+03	0.31698E+00	0.38020E+00	0.12052E+00	0.39377E+00
0.75820E+03	0.30566E+00	0.38035E+00	0.11626E+00	0.37985E+00
0.75830E+03	0.29451E+00	0.38049E+00	0.11206E+00	0.36614E+00
0.75840E+03	0.28350E+00	0.38064E+00	0.10791E+00	0.35258E+00
0.75850E+03	0.27268E+00	0.38078E+00	0.10383E+00	0.33926E+00
0.75860E+03	0.26209E+00	0.38093E+00	0.99838E-01	0.32621E+00
0.75870E+03	0.25181E+00	0.38107E+00	0.95956E-01	0.31352E+00
0.75880E+03	0.24180E+00	0.38122E+00	0.92176E-01	0.30117E+00
0.75890E+03	0.23201E+00	0.38136E+00	0.88480E-01	0.28910E+00
0.75900E+03	0.22241E+00	0.38151E+00	0.84852E-01	0.27724E+00
0.75910E+03	0.21302E+00	0.38165E+00	0.81301E-01	0.26564E+00

0.75920E+03	0.20382E+00	0.38180E+00	0.77819E-01	0.25426E+00
0.75930E+03	0.19484E+00	0.38194E+00	0.74417E-01	0.24315E+00
0.75940E+03	0.18606E+00	0.38209E+00	0.71090E-01	0.23228E+00
0.75950E+03	0.17758E+00	0.38224E+00	0.67878E-01	0.22178E+00
0.75960E+03	0.16944E+00	0.38238E+00	0.64791E-01	0.21170E+00
0.75970E+03	0.16171E+00	0.38253E+00	0.61858E-01	0.20211E+00
0.75980E+03	0.15439E+00	0.38268E+00	0.59082E-01	0.19304E+00
0.75990E+03	0.14748E+00	0.38282E+00	0.56457E-01	0.18446E+00
0.76000E+03	0.14093E+00	0.38297E+00	0.53973E-01	0.17635E+00
0.76010E+03	0.13470E+00	0.38309E+00	0.51601E-01	0.16860E+00
0.76020E+03	0.12871E+00	0.38322E+00	0.49323E-01	0.16115E+00
0.76030E+03	0.12294E+00	0.38335E+00	0.47128E-01	0.15398E+00
0.76040E+03	0.11737E+00	0.38347E+00	0.45006E-01	0.14705E+00
0.76050E+03	0.11198E+00	0.38360E+00	0.42955E-01	0.14035E+00
0.76060E+03	0.10676E+00	0.38372E+00	0.40968E-01	0.13386E+00
0.76070E+03	0.10180E+00	0.38385E+00	0.39077E-01	0.12768E+00
0.76080E+03	0.97146E-01	0.38397E+00	0.37301E-01	0.12188E+00
0.76090E+03	0.92756E-01	0.38410E+00	0.35627E-01	0.11641E+00
0.76100E+03	0.88598E-01	0.38422E+00	0.34041E-01	0.11123E+00
0.76110E+03	0.84656E-01	0.38435E+00	0.32537E-01	0.10631E+00
0.76120E+03	0.80898E-01	0.38447E+00	0.31103E-01	0.10162E+00
0.76130E+03	0.77215E-01	0.38460E+00	0.29697E-01	0.97029E-01
0.76140E+03	0.73518E-01	0.38472E+00	0.28284E-01	0.92414E-01
0.76150E+03	0.69849E-01	0.38485E+00	0.26881E-01	0.87831E-01
0.76160E+03	0.66222E-01	0.38497E+00	0.25494E-01	0.83297E-01
0.76170E+03	0.62678E-01	0.38510E+00	0.24137E-01	0.78865E-01
0.76180E+03	0.59269E-01	0.38522E+00	0.22832E-01	0.74599E-01
0.76190E+03	0.56066E-01	0.38535E+00	0.21605E-01	0.70591E-01
0.76200E+03	0.53091E-01	0.38546E+00	0.20465E-01	0.66866E-01
0.76210E+03	0.50308E-01	0.38557E+00	0.19397E-01	0.63378E-01
0.76220E+03	0.47681E-01	0.38567E+00	0.18389E-01	0.60085E-01
0.76230E+03	0.45202E-01	0.38578E+00	0.17438E-01	0.56976E-01
0.76240E+03	0.42861E-01	0.38588E+00	0.16539E-01	0.54040E-01
0.76250E+03	0.40649E-01	0.38599E+00	0.15690E-01	0.51265E-01
0.76260E+03	0.38537E-01	0.38609E+00	0.14879E-01	0.48614E-01
0.76270E+03	0.36506E-01	0.38620E+00	0.14099E-01	0.46065E-01
0.76280E+03	0.34547E-01	0.38630E+00	0.13346E-01	0.43605E-01
0.76290E+03	0.32747E-01	0.38641E+00	0.12653E-01	0.41343E-01
0.76300E+03	0.31137E-01	0.38651E+00	0.12035E-01	0.39322E-01
0.76310E+03	0.29753E-01	0.38662E+00	0.11503E-01	0.37585E-01
0.76320E+03	0.28592E-01	0.38672E+00	0.11057E-01	0.36128E-01
0.76330E+03	0.27602E-01	0.38683E+00	0.10677E-01	0.34887E-01
0.76340E+03	0.26761E-01	0.38693E+00	0.10355E-01	0.33832E-01

0.76350E+03	0.25953E-01	0.38704E+00	0.10045E-01	0.32820E-01
0.76360E+03	0.25114E-01	0.38714E+00	0.97226E-02	0.31767E-01
0.76370E+03	0.24220E-01	0.38725E+00	0.93790E-02	0.30645E-01
0.76380E+03	0.23263E-01	0.38735E+00	0.90111E-02	0.29442E-01
0.76390E+03	0.22175E-01	0.38746E+00	0.85919E-02	0.28073E-01
0.76400E+03	0.20940E-01	0.38756E+00	0.81153E-02	0.26516E-01
0.76410E+03	0.19688E-01	0.38766E+00	0.76321E-02	0.24937E-01
0.76420E+03	0.18501E-01	0.38776E+00	0.71739E-02	0.23440E-01
0.76430E+03	0.17445E-01	0.38785E+00	0.67663E-02	0.22108E-01
0.76440E+03	0.16628E-01	0.38795E+00	0.64509E-02	0.21077E-01
0.76450E+03	0.16026E-01	0.38806E+00	0.62191E-02	0.20320E-01
0.76460E+03	0.15470E-01	0.38816E+00	0.60047E-02	0.19620E-01
0.76470E+03	0.14921E-01	0.38827E+00	0.57932E-02	0.18928E-01
0.76480E+03	0.14387E-01	0.38837E+00	0.55876E-02	0.18257E-01
0.76490E+03	0.13865E-01	0.38848E+00	0.53862E-02	0.17599E-01
0.76500E+03	0.13351E-01	0.38859E+00	0.51880E-02	0.16951E-01
0.76510E+03	0.12840E-01	0.38869E+00	0.49907E-02	0.16306E-01
0.76520E+03	0.12329E-01	0.38880E+00	0.47933E-02	0.15662E-01
0.76530E+03	0.11835E-01	0.38890E+00	0.46026E-02	0.15038E-01
0.76540E+03	0.11342E-01	0.38901E+00	0.44121E-02	0.14416E-01
0.76550E+03	0.10852E-01	0.38911E+00	0.42226E-02	0.13797E-01
0.76560E+03	0.10380E-01	0.38922E+00	0.40402E-02	0.13201E-01
0.76570E+03	0.99165E-02	0.38932E+00	0.38607E-02	0.12614E-01
0.76580E+03	0.94555E-02	0.38943E+00	0.36823E-02	0.12031E-01
0.76590E+03	0.89970E-02	0.38955E+00	0.35048E-02	0.11451E-01
0.76600E+03	0.85572E-02	0.38967E+00	0.33345E-02	0.10895E-01
0.76610E+03	0.81188E-02	0.38980E+00	0.31647E-02	0.10340E-01
0.76620E+03	0.76863E-02	0.38992E+00	0.29970E-02	0.97924E-02
0.76630E+03	0.72616E-02	0.39004E+00	0.28323E-02	0.92542E-02
0.76640E+03	0.68414E-02	0.39016E+00	0.26693E-02	0.87214E-02
0.76650E+03	0.64221E-02	0.39028E+00	0.25064E-02	0.81894E-02
0.76660E+03	0.60057E-02	0.39041E+00	0.23446E-02	0.76608E-02
0.76670E+03	0.55913E-02	0.39053E+00	0.21836E-02	0.71345E-02
0.76680E+03	0.51779E-02	0.39065E+00	0.20227E-02	0.66090E-02
0.76690E+03	0.47888E-02	0.39077E+00	0.18713E-02	0.61143E-02
0.76700E+03	0.44371E-02	0.39089E+00	0.17344E-02	0.56670E-02
0.76710E+03	0.40915E-02	0.39101E+00	0.15998E-02	0.52273E-02
0.76720E+03	0.37567E-02	0.39114E+00	0.14694E-02	0.48010E-02
0.76730E+03	0.34488E-02	0.39126E+00	0.13494E-02	0.44089E-02
0.76740E+03	0.31451E-02	0.39138E+00	0.12309E-02	0.40219E-02
0.76750E+03	0.28694E-02	0.39150E+00	0.11234E-02	0.36704E-02
0.76760E+03	0.26098E-02	0.39162E+00	0.10221E-02	0.33395E-02
0.76770E+03	0.23681E-02	0.39175E+00	0.92770E-03	0.30311E-02

0.76780E+03	0.21405E-02	0.39188E+00	0.83880E-03	0.27406E-02
0.76790E+03	0.19157E-02	0.39201E+00	0.75097E-03	0.24537E-02
0.76800E+03	0.17034E-02	0.39214E+00	0.66795E-03	0.21824E-02
0.76810E+03	0.14914E-02	0.39228E+00	0.58502E-03	0.19115E-02
0.76820E+03	0.12797E-02	0.39242E+00	0.50217E-03	0.16408E-02
0.76830E+03	0.10703E-02	0.39256E+00	0.42014E-03	0.13727E-02
0.76840E+03	0.87138E-03	0.39270E+00	0.34219E-03	0.11181E-02
0.76850E+03	0.68874E-03	0.39284E+00	0.27056E-03	0.88402E-03
0.76860E+03	0.50709E-03	0.39298E+00	0.19928E-03	0.65111E-03
0.76870E+03	0.33229E-03	0.39312E+00	0.13063E-03	0.42681E-03
0.76880E+03	0.15931E-03	0.39326E+00	0.62651E-04	0.20470E-03
0.76890E+03	0.00000E+00	0.39340E+00	0.00000E+00	0.00000E+00
Channel 8				
Wavenumber	HIRS Filter Transmittance	Optical Element Transmittance	Product of the HIRS Filter and Optical Element Transmittances	Normalized Value of Column 4
0.86768E+03	0.00000E+00	0.52016E+00	0.00000E+00	0.00000E+00
0.86778E+03	0.78031E-04	0.52034E+00	0.40603E-04	0.85263E-04
0.86788E+03	0.19961E-03	0.52052E+00	0.10390E-03	0.21818E-03
0.86798E+03	0.33195E-03	0.52070E+00	0.17285E-03	0.36297E-03
0.86808E+03	0.46699E-03	0.52087E+00	0.24324E-03	0.51079E-03
0.86818E+03	0.60845E-03	0.52104E+00	0.31702E-03	0.66573E-03
0.86828E+03	0.75123E-03	0.52121E+00	0.39155E-03	0.82222E-03
0.86838E+03	0.89474E-03	0.52137E+00	0.46649E-03	0.97960E-03
0.86848E+03	0.10472E-02	0.52154E+00	0.54618E-03	0.11469E-02
0.86858E+03	0.12125E-02	0.52171E+00	0.63257E-03	0.13283E-02
0.86868E+03	0.13826E-02	0.52188E+00	0.72153E-03	0.15152E-02
0.86878E+03	0.15547E-02	0.52205E+00	0.81161E-03	0.17043E-02
0.86888E+03	0.17292E-02	0.52222E+00	0.90305E-03	0.18963E-02
0.86898E+03	0.19057E-02	0.52239E+00	0.99552E-03	0.20905E-02
0.86908E+03	0.20835E-02	0.52257E+00	0.10888E-02	0.22864E-02
0.86918E+03	0.22635E-02	0.52274E+00	0.11832E-02	0.24846E-02
0.86928E+03	0.24500E-02	0.52292E+00	0.12811E-02	0.26903E-02
0.86938E+03	0.26453E-02	0.52309E+00	0.13837E-02	0.29057E-02
0.86948E+03	0.28433E-02	0.52327E+00	0.14878E-02	0.31243E-02
0.86958E+03	0.30473E-02	0.52345E+00	0.15951E-02	0.33496E-02
0.86968E+03	0.32538E-02	0.52363E+00	0.17038E-02	0.35778E-02
0.86978E+03	0.34632E-02	0.52381E+00	0.18140E-02	0.38093E-02
0.86988E+03	0.36735E-02	0.52399E+00	0.19249E-02	0.40421E-02
0.86998E+03	0.38849E-02	0.52416E+00	0.20363E-02	0.42760E-02
0.87008E+03	0.41042E-02	0.52430E+00	0.21518E-02	0.45187E-02
0.87018E+03	0.43239E-02	0.52444E+00	0.22676E-02	0.47619E-02

0.87028E+03	0.45443E-02	0.52459E+00	0.23839E-02	0.50060E-02
0.87038E+03	0.47673E-02	0.52473E+00	0.25016E-02	0.52531E-02
0.87048E+03	0.49933E-02	0.52488E+00	0.26208E-02	0.55035E-02
0.87058E+03	0.52229E-02	0.52502E+00	0.27421E-02	0.57583E-02
0.87068E+03	0.54539E-02	0.52517E+00	0.28642E-02	0.60146E-02
0.87078E+03	0.56893E-02	0.52531E+00	0.29886E-02	0.62759E-02
0.87088E+03	0.59295E-02	0.52546E+00	0.31157E-02	0.65428E-02
0.87098E+03	0.61734E-02	0.52561E+00	0.32448E-02	0.68138E-02
0.87108E+03	0.64187E-02	0.52575E+00	0.33747E-02	0.70865E-02
0.87118E+03	0.66649E-02	0.52590E+00	0.35051E-02	0.73604E-02
0.87128E+03	0.69146E-02	0.52605E+00	0.36375E-02	0.76384E-02
0.87138E+03	0.71684E-02	0.52620E+00	0.37720E-02	0.79209E-02
0.87148E+03	0.74230E-02	0.52635E+00	0.39071E-02	0.82046E-02
0.87158E+03	0.76865E-02	0.52650E+00	0.40469E-02	0.84982E-02
0.87168E+03	0.79512E-02	0.52665E+00	0.41875E-02	0.87934E-02
0.87178E+03	0.82160E-02	0.52680E+00	0.43282E-02	0.90889E-02
0.87188E+03	0.84809E-02	0.52695E+00	0.44690E-02	0.93846E-02
0.87198E+03	0.87468E-02	0.52710E+00	0.46104E-02	0.96815E-02
0.87208E+03	0.90197E-02	0.52723E+00	0.47555E-02	0.99861E-02
0.87218E+03	0.92927E-02	0.52737E+00	0.49007E-02	0.10291E-01
0.87228E+03	0.95679E-02	0.52750E+00	0.50471E-02	0.10599E-01
0.87238E+03	0.98575E-02	0.52764E+00	0.52012E-02	0.10922E-01
0.87248E+03	0.10170E-01	0.52777E+00	0.53677E-02	0.11272E-01
0.87258E+03	0.10517E-01	0.52791E+00	0.55521E-02	0.11659E-01
0.87268E+03	0.10880E-01	0.52805E+00	0.57451E-02	0.12064E-01
0.87278E+03	0.11247E-01	0.52819E+00	0.59403E-02	0.12474E-01
0.87288E+03	0.11630E-01	0.52832E+00	0.61444E-02	0.12903E-01
0.87298E+03	0.12039E-01	0.52846E+00	0.63622E-02	0.13360E-01
0.87308E+03	0.12463E-01	0.52860E+00	0.65878E-02	0.13834E-01
0.87318E+03	0.12918E-01	0.52874E+00	0.68304E-02	0.14343E-01
0.87328E+03	0.13376E-01	0.52888E+00	0.70745E-02	0.14856E-01
0.87338E+03	0.13844E-01	0.52903E+00	0.73239E-02	0.15380E-01
0.87348E+03	0.14338E-01	0.52917E+00	0.75871E-02	0.15932E-01
0.87358E+03	0.14849E-01	0.52931E+00	0.78596E-02	0.16505E-01
0.87368E+03	0.15413E-01	0.52945E+00	0.81605E-02	0.17136E-01
0.87378E+03	0.16034E-01	0.52960E+00	0.84918E-02	0.17832E-01
0.87388E+03	0.16680E-01	0.52975E+00	0.88365E-02	0.18556E-01
0.87398E+03	0.17337E-01	0.52991E+00	0.91871E-02	0.19292E-01
0.87408E+03	0.18016E-01	0.53007E+00	0.95495E-02	0.20053E-01
0.87418E+03	0.18727E-01	0.53022E+00	0.99292E-02	0.20851E-01
0.87428E+03	0.19504E-01	0.53037E+00	0.10344E-01	0.21722E-01
0.87438E+03	0.20378E-01	0.53052E+00	0.10811E-01	0.22702E-01
0.87448E+03	0.21345E-01	0.53067E+00	0.11327E-01	0.23787E-01

0.87458E+03	0.22391E-01	0.53083E+00	0.11886E-01	0.24959E-01
0.87468E+03	0.23511E-01	0.53098E+00	0.12484E-01	0.26215E-01
0.87478E+03	0.24707E-01	0.53114E+00	0.13123E-01	0.27556E-01
0.87488E+03	0.25929E-01	0.53129E+00	0.13776E-01	0.28928E-01
0.87498E+03	0.27168E-01	0.53145E+00	0.14439E-01	0.30320E-01
0.87508E+03	0.28414E-01	0.53160E+00	0.15105E-01	0.31719E-01
0.87518E+03	0.29637E-01	0.53176E+00	0.15760E-01	0.33094E-01
0.87528E+03	0.30848E-01	0.53192E+00	0.16409E-01	0.34457E-01
0.87538E+03	0.32033E-01	0.53208E+00	0.17044E-01	0.35791E-01
0.87548E+03	0.33201E-01	0.53224E+00	0.17671E-01	0.37107E-01
0.87558E+03	0.34381E-01	0.53240E+00	0.18304E-01	0.38438E-01
0.87568E+03	0.35558E-01	0.53256E+00	0.18937E-01	0.39766E-01
0.87578E+03	0.36723E-01	0.53272E+00	0.19563E-01	0.41081E-01
0.87588E+03	0.37915E-01	0.53287E+00	0.20204E-01	0.42427E-01
0.87598E+03	0.39179E-01	0.53303E+00	0.20884E-01	0.43854E-01
0.87608E+03	0.40555E-01	0.53317E+00	0.21623E-01	0.45406E-01
0.87618E+03	0.42034E-01	0.53331E+00	0.22417E-01	0.47074E-01
0.87628E+03	0.43588E-01	0.53346E+00	0.23252E-01	0.48828E-01
0.87638E+03	0.45189E-01	0.53360E+00	0.24113E-01	0.50635E-01
0.87648E+03	0.46780E-01	0.53374E+00	0.24969E-01	0.52432E-01
0.87658E+03	0.48342E-01	0.53388E+00	0.25809E-01	0.54196E-01
0.87668E+03	0.49886E-01	0.53403E+00	0.26641E-01	0.55943E-01
0.87678E+03	0.51479E-01	0.53417E+00	0.27498E-01	0.57744E-01
0.87688E+03	0.53181E-01	0.53431E+00	0.28415E-01	0.59670E-01
0.87698E+03	0.55010E-01	0.53446E+00	0.29400E-01	0.61738E-01
0.87708E+03	0.56976E-01	0.53460E+00	0.30459E-01	0.63962E-01
0.87718E+03	0.59098E-01	0.53474E+00	0.31602E-01	0.66362E-01
0.87728E+03	0.61372E-01	0.53489E+00	0.32827E-01	0.68934E-01
0.87738E+03	0.63762E-01	0.53503E+00	0.34115E-01	0.71638E-01
0.87748E+03	0.66269E-01	0.53517E+00	0.35465E-01	0.74474E-01
0.87758E+03	0.68906E-01	0.53531E+00	0.36886E-01	0.77459E-01
0.87768E+03	0.71652E-01	0.53545E+00	0.38366E-01	0.80566E-01
0.87778E+03	0.74522E-01	0.53559E+00	0.39913E-01	0.83814E-01
0.87788E+03	0.77569E-01	0.53572E+00	0.41555E-01	0.87263E-01
0.87798E+03	0.80832E-01	0.53585E+00	0.43314E-01	0.90956E-01
0.87808E+03	0.84305E-01	0.53597E+00	0.45185E-01	0.94885E-01
0.87818E+03	0.87970E-01	0.53609E+00	0.47160E-01	0.99031E-01
0.87828E+03	0.91839E-01	0.53620E+00	0.49244E-01	0.10341E+00
0.87838E+03	0.95900E-01	0.53632E+00	0.51433E-01	0.10801E+00
0.87848E+03	0.10011E+00	0.53643E+00	0.53701E-01	0.11277E+00
0.87858E+03	0.10447E+00	0.53655E+00	0.56053E-01	0.11771E+00
0.87868E+03	0.10903E+00	0.53666E+00	0.58513E-01	0.12287E+00
0.87878E+03	0.11380E+00	0.53678E+00	0.61087E-01	0.12828E+00

0.87888E+03	0.11876E+00	0.53690E+00	0.63762E-01	0.13390E+00
0.87898E+03	0.12389E+00	0.53701E+00	0.66529E-01	0.13971E+00
0.87908E+03	0.12920E+00	0.53713E+00	0.69396E-01	0.14573E+00
0.87918E+03	0.13469E+00	0.53724E+00	0.72361E-01	0.15195E+00
0.87928E+03	0.14031E+00	0.53736E+00	0.75395E-01	0.15832E+00
0.87938E+03	0.14608E+00	0.53747E+00	0.78512E-01	0.16487E+00
0.87948E+03	0.15205E+00	0.53759E+00	0.81743E-01	0.17165E+00
0.87958E+03	0.15823E+00	0.53771E+00	0.85081E-01	0.17866E+00
0.87968E+03	0.16460E+00	0.53781E+00	0.88523E-01	0.18589E+00
0.87978E+03	0.17122E+00	0.53791E+00	0.92100E-01	0.19340E+00
0.87988E+03	0.17813E+00	0.53801E+00	0.95837E-01	0.20125E+00
0.87998E+03	0.18533E+00	0.53811E+00	0.99730E-01	0.20942E+00
0.88008E+03	0.19279E+00	0.53820E+00	0.10376E+00	0.21789E+00
0.88018E+03	0.20050E+00	0.53829E+00	0.10792E+00	0.22663E+00
0.88028E+03	0.20841E+00	0.53837E+00	0.11220E+00	0.23562E+00
0.88038E+03	0.21652E+00	0.53846E+00	0.11658E+00	0.24482E+00
0.88048E+03	0.22479E+00	0.53854E+00	0.12106E+00	0.25422E+00
0.88058E+03	0.23327E+00	0.53863E+00	0.12565E+00	0.26385E+00
0.88068E+03	0.24198E+00	0.53871E+00	0.13036E+00	0.27374E+00
0.88078E+03	0.25090E+00	0.53880E+00	0.13518E+00	0.28388E+00
0.88088E+03	0.26001E+00	0.53888E+00	0.14011E+00	0.29423E+00
0.88098E+03	0.26931E+00	0.53897E+00	0.14515E+00	0.30480E+00
0.88108E+03	0.27886E+00	0.53905E+00	0.15032E+00	0.31566E+00
0.88118E+03	0.28868E+00	0.53913E+00	0.15564E+00	0.32683E+00
0.88128E+03	0.29877E+00	0.53922E+00	0.16110E+00	0.33831E+00
0.88138E+03	0.30910E+00	0.53930E+00	0.16670E+00	0.35005E+00
0.88148E+03	0.31964E+00	0.53938E+00	0.17241E+00	0.36204E+00
0.88158E+03	0.33038E+00	0.53946E+00	0.17823E+00	0.37427E+00
0.88168E+03	0.34130E+00	0.53955E+00	0.18414E+00	0.38669E+00
0.88178E+03	0.35233E+00	0.53963E+00	0.19013E+00	0.39925E+00
0.88188E+03	0.36348E+00	0.53971E+00	0.19617E+00	0.41195E+00
0.88198E+03	0.37477E+00	0.53979E+00	0.20230E+00	0.42480E+00
0.88208E+03	0.38621E+00	0.53986E+00	0.20850E+00	0.43783E+00
0.88218E+03	0.39780E+00	0.53992E+00	0.21478E+00	0.45102E+00
0.88228E+03	0.40948E+00	0.53998E+00	0.22111E+00	0.46431E+00
0.88238E+03	0.42124E+00	0.54004E+00	0.22749E+00	0.47771E+00
0.88248E+03	0.43308E+00	0.54010E+00	0.23391E+00	0.49120E+00
0.88258E+03	0.44498E+00	0.54017E+00	0.24036E+00	0.50475E+00
0.88268E+03	0.45691E+00	0.54023E+00	0.24683E+00	0.51833E+00
0.88278E+03	0.46889E+00	0.54029E+00	0.25333E+00	0.53198E+00
0.88288E+03	0.48092E+00	0.54035E+00	0.25986E+00	0.54569E+00
0.88298E+03	0.49297E+00	0.54041E+00	0.26641E+00	0.55943E+00
0.88308E+03	0.50502E+00	0.54047E+00	0.27295E+00	0.57317E+00

0.88318E+03	0.51706E+00	0.54053E+00	0.27949E+00	0.58690E+00
0.88328E+03	0.52906E+00	0.54059E+00	0.28600E+00	0.60059E+00
0.88338E+03	0.54101E+00	0.54065E+00	0.29250E+00	0.61423E+00
0.88348E+03	0.55288E+00	0.54071E+00	0.29895E+00	0.62777E+00
0.88358E+03	0.56467E+00	0.54075E+00	0.30534E+00	0.64119E+00
0.88368E+03	0.57635E+00	0.54078E+00	0.31168E+00	0.65450E+00
0.88378E+03	0.58789E+00	0.54082E+00	0.31794E+00	0.66765E+00
0.88388E+03	0.59930E+00	0.54086E+00	0.32413E+00	0.68066E+00
0.88398E+03	0.61058E+00	0.54089E+00	0.33026E+00	0.69351E+00
0.88408E+03	0.62169E+00	0.54091E+00	0.33628E+00	0.70616E+00
0.88418E+03	0.63261E+00	0.54093E+00	0.34220E+00	0.71859E+00
0.88428E+03	0.64327E+00	0.54094E+00	0.34797E+00	0.73071E+00
0.88438E+03	0.65364E+00	0.54096E+00	0.35359E+00	0.74251E+00
0.88448E+03	0.66375E+00	0.54098E+00	0.35907E+00	0.75403E+00
0.88458E+03	0.67360E+00	0.54099E+00	0.36441E+00	0.76523E+00
0.88468E+03	0.68319E+00	0.54100E+00	0.36961E+00	0.77615E+00
0.88478E+03	0.69257E+00	0.54102E+00	0.37469E+00	0.78682E+00
0.88488E+03	0.70174E+00	0.54103E+00	0.37967E+00	0.79727E+00
0.88498E+03	0.71070E+00	0.54105E+00	0.38452E+00	0.80747E+00
0.88508E+03	0.71940E+00	0.54106E+00	0.38924E+00	0.81737E+00
0.88518E+03	0.72783E+00	0.54107E+00	0.39381E+00	0.82697E+00
0.88528E+03	0.73601E+00	0.54109E+00	0.39824E+00	0.83628E+00
0.88538E+03	0.74390E+00	0.54110E+00	0.40252E+00	0.84527E+00
0.88548E+03	0.75150E+00	0.54110E+00	0.40664E+00	0.85391E+00
0.88558E+03	0.75883E+00	0.54111E+00	0.41061E+00	0.86225E+00
0.88568E+03	0.76590E+00	0.54111E+00	0.41444E+00	0.87029E+00
0.88578E+03	0.77271E+00	0.54112E+00	0.41813E+00	0.87804E+00
0.88588E+03	0.77924E+00	0.54112E+00	0.42166E+00	0.88546E+00
0.88598E+03	0.78548E+00	0.54113E+00	0.42504E+00	0.89256E+00
0.88608E+03	0.79145E+00	0.54111E+00	0.42826E+00	0.89932E+00
0.88618E+03	0.79713E+00	0.54109E+00	0.43132E+00	0.90574E+00
0.88628E+03	0.80251E+00	0.54107E+00	0.43421E+00	0.91182E+00
0.88638E+03	0.80762E+00	0.54105E+00	0.43696E+00	0.91759E+00
0.88648E+03	0.81251E+00	0.54103E+00	0.43959E+00	0.92311E+00
0.88658E+03	0.81723E+00	0.54101E+00	0.44213E+00	0.92843E+00
0.88668E+03	0.82177E+00	0.54099E+00	0.44456E+00	0.93355E+00
0.88678E+03	0.82610E+00	0.54096E+00	0.44689E+00	0.93843E+00
0.88688E+03	0.83022E+00	0.54094E+00	0.44910E+00	0.94308E+00
0.88698E+03	0.83414E+00	0.54092E+00	0.45120E+00	0.94748E+00
0.88708E+03	0.83783E+00	0.54089E+00	0.45318E+00	0.95164E+00
0.88718E+03	0.84130E+00	0.54087E+00	0.45504E+00	0.95554E+00
0.88728E+03	0.84456E+00	0.54085E+00	0.45678E+00	0.95920E+00
0.88738E+03	0.84765E+00	0.54082E+00	0.45843E+00	0.96267E+00

0.88748E+03	0.85057E+00	0.54080E+00	0.45999E+00	0.96594E+00
0.88758E+03	0.85332E+00	0.54078E+00	0.46146E+00	0.96903E+00
0.88768E+03	0.85590E+00	0.54076E+00	0.46283E+00	0.97191E+00
0.88778E+03	0.85829E+00	0.54074E+00	0.46411E+00	0.97459E+00
0.88788E+03	0.86050E+00	0.54071E+00	0.46528E+00	0.97705E+00
0.88798E+03	0.86254E+00	0.54069E+00	0.46637E+00	0.97934E+00
0.88808E+03	0.86447E+00	0.54064E+00	0.46737E+00	0.98144E+00
0.88818E+03	0.86629E+00	0.54059E+00	0.46831E+00	0.98341E+00
0.88828E+03	0.86798E+00	0.54054E+00	0.46918E+00	0.98524E+00
0.88838E+03	0.86954E+00	0.54049E+00	0.46998E+00	0.98692E+00
0.88848E+03	0.87098E+00	0.54044E+00	0.47071E+00	0.98846E+00
0.88858E+03	0.87228E+00	0.54039E+00	0.47137E+00	0.98984E+00
0.88868E+03	0.87343E+00	0.54034E+00	0.47195E+00	0.99105E+00
0.88878E+03	0.87446E+00	0.54029E+00	0.47246E+00	0.99213E+00
0.88888E+03	0.87541E+00	0.54023E+00	0.47292E+00	0.99310E+00
0.88898E+03	0.87628E+00	0.54018E+00	0.47335E+00	0.99399E+00
0.88908E+03	0.87708E+00	0.54013E+00	0.47374E+00	0.99481E+00
0.88918E+03	0.87784E+00	0.54008E+00	0.47410E+00	0.99558E+00
0.88928E+03	0.87852E+00	0.54003E+00	0.47442E+00	0.99625E+00
0.88938E+03	0.87910E+00	0.53999E+00	0.47470E+00	0.99684E+00
0.88948E+03	0.87962E+00	0.53994E+00	0.47494E+00	0.99734E+00
0.88958E+03	0.88008E+00	0.53990E+00	0.47516E+00	0.99779E+00
0.88968E+03	0.88051E+00	0.53986E+00	0.47535E+00	0.99819E+00
0.88978E+03	0.88090E+00	0.53981E+00	0.47552E+00	0.99855E+00
0.88988E+03	0.88124E+00	0.53977E+00	0.47567E+00	0.99886E+00
0.88998E+03	0.88156E+00	0.53973E+00	0.47580E+00	0.99915E+00
0.89008E+03	0.88183E+00	0.53964E+00	0.47587E+00	0.99930E+00
0.89018E+03	0.88203E+00	0.53955E+00	0.47590E+00	0.99936E+00
0.89028E+03	0.88219E+00	0.53946E+00	0.47591E+00	0.99937E+00
0.89038E+03	0.88232E+00	0.53937E+00	0.47589E+00	0.99934E+00
0.89048E+03	0.88244E+00	0.53928E+00	0.47588E+00	0.99931E+00
0.89058E+03	0.88260E+00	0.53919E+00	0.47589E+00	0.99932E+00
0.89068E+03	0.88279E+00	0.53909E+00	0.47591E+00	0.99937E+00
0.89078E+03	0.88302E+00	0.53900E+00	0.47595E+00	0.99946E+00
0.89088E+03	0.88330E+00	0.53891E+00	0.47602E+00	0.99960E+00
0.89098E+03	0.88359E+00	0.53882E+00	0.47609E+00	0.99975E+00
0.89108E+03	0.88385E+00	0.53872E+00	0.47615E+00	0.99988E+00
0.89118E+03	0.88408E+00	0.53863E+00	0.47619E+00	0.99997E+00
0.89128E+03	0.88423E+00	0.53856E+00	0.47621E+00	0.10000E+01
0.89138E+03	0.88433E+00	0.53848E+00	0.47620E+00	0.99997E+00
0.89148E+03	0.88441E+00	0.53841E+00	0.47617E+00	0.99992E+00
0.89158E+03	0.88448E+00	0.53833E+00	0.47615E+00	0.99987E+00
0.89168E+03	0.88459E+00	0.53826E+00	0.47614E+00	0.99985E+00

0.89178E+03	0.88472E+00	0.53818E+00	0.47614E+00	0.99986E+00
0.89188E+03	0.88482E+00	0.53811E+00	0.47613E+00	0.99984E+00
0.89198E+03	0.88489E+00	0.53803E+00	0.47610E+00	0.99977E+00
0.89208E+03	0.88490E+00	0.53793E+00	0.47601E+00	0.99958E+00
0.89218E+03	0.88484E+00	0.53781E+00	0.47588E+00	0.99931E+00
0.89228E+03	0.88472E+00	0.53770E+00	0.47572E+00	0.99897E+00
0.89238E+03	0.88457E+00	0.53759E+00	0.47553E+00	0.99858E+00
0.89248E+03	0.88439E+00	0.53748E+00	0.47534E+00	0.99817E+00
0.89258E+03	0.88419E+00	0.53737E+00	0.47513E+00	0.99774E+00
0.89268E+03	0.88395E+00	0.53725E+00	0.47491E+00	0.99727E+00
0.89278E+03	0.88365E+00	0.53714E+00	0.47465E+00	0.99672E+00
0.89288E+03	0.88329E+00	0.53703E+00	0.47435E+00	0.99610E+00
0.89298E+03	0.88288E+00	0.53692E+00	0.47403E+00	0.99543E+00
0.89308E+03	0.88244E+00	0.53681E+00	0.47370E+00	0.99473E+00
0.89318E+03	0.88202E+00	0.53672E+00	0.47340E+00	0.99410E+00
0.89328E+03	0.88160E+00	0.53665E+00	0.47311E+00	0.99349E+00
0.89338E+03	0.88116E+00	0.53657E+00	0.47281E+00	0.99286E+00
0.89348E+03	0.88072E+00	0.53650E+00	0.47251E+00	0.99223E+00
0.89358E+03	0.88026E+00	0.53642E+00	0.47219E+00	0.99156E+00
0.89368E+03	0.87975E+00	0.53635E+00	0.47186E+00	0.99086E+00
0.89378E+03	0.87924E+00	0.53628E+00	0.47151E+00	0.99014E+00
0.89388E+03	0.87872E+00	0.53620E+00	0.47117E+00	0.98942E+00
0.89398E+03	0.87820E+00	0.53613E+00	0.47083E+00	0.98870E+00
0.89408E+03	0.87768E+00	0.53602E+00	0.47045E+00	0.98792E+00
0.89418E+03	0.87718E+00	0.53590E+00	0.47008E+00	0.98714E+00
0.89428E+03	0.87670E+00	0.53579E+00	0.46972E+00	0.98638E+00
0.89438E+03	0.87620E+00	0.53567E+00	0.46936E+00	0.98561E+00
0.89448E+03	0.87568E+00	0.53555E+00	0.46897E+00	0.98481E+00
0.89458E+03	0.87513E+00	0.53544E+00	0.46858E+00	0.98398E+00
0.89468E+03	0.87456E+00	0.53532E+00	0.46817E+00	0.98312E+00
0.89478E+03	0.87398E+00	0.53520E+00	0.46776E+00	0.98225E+00
0.89488E+03	0.87340E+00	0.53509E+00	0.46735E+00	0.98139E+00
0.89498E+03	0.87286E+00	0.53497E+00	0.46696E+00	0.98057E+00
0.89508E+03	0.87231E+00	0.53487E+00	0.46657E+00	0.97976E+00
0.89518E+03	0.87169E+00	0.53477E+00	0.46616E+00	0.97889E+00
0.89528E+03	0.87100E+00	0.53468E+00	0.46571E+00	0.97795E+00
0.89538E+03	0.87025E+00	0.53458E+00	0.46522E+00	0.97692E+00
0.89548E+03	0.86947E+00	0.53449E+00	0.46472E+00	0.97588E+00
0.89558E+03	0.86871E+00	0.53439E+00	0.46424E+00	0.97486E+00
0.89568E+03	0.86799E+00	0.53430E+00	0.46377E+00	0.97388E+00
0.89578E+03	0.86733E+00	0.53421E+00	0.46333E+00	0.97296E+00
0.89588E+03	0.86666E+00	0.53411E+00	0.46289E+00	0.97204E+00
0.89598E+03	0.86596E+00	0.53402E+00	0.46244E+00	0.97109E+00

0.89608E+03	0.86530E+00	0.53389E+00	0.46198E+00	0.97011E+00
0.89618E+03	0.86471E+00	0.53375E+00	0.46154E+00	0.96920E+00
0.89628E+03	0.86413E+00	0.53361E+00	0.46111E+00	0.96830E+00
0.89638E+03	0.86356E+00	0.53348E+00	0.46069E+00	0.96741E+00
0.89648E+03	0.86297E+00	0.53334E+00	0.46025E+00	0.96650E+00
0.89658E+03	0.86233E+00	0.53320E+00	0.45980E+00	0.96554E+00
0.89668E+03	0.86167E+00	0.53306E+00	0.45932E+00	0.96454E+00
0.89678E+03	0.86098E+00	0.53293E+00	0.45884E+00	0.96352E+00
0.89688E+03	0.86030E+00	0.53279E+00	0.45836E+00	0.96251E+00
0.89698E+03	0.85965E+00	0.53265E+00	0.45789E+00	0.96154E+00
0.89708E+03	0.85898E+00	0.53253E+00	0.45743E+00	0.96058E+00
0.89718E+03	0.85831E+00	0.53241E+00	0.45697E+00	0.95961E+00
0.89728E+03	0.85764E+00	0.53230E+00	0.45652E+00	0.95865E+00
0.89738E+03	0.85695E+00	0.53218E+00	0.45605E+00	0.95767E+00
0.89748E+03	0.85631E+00	0.53206E+00	0.45560E+00	0.95673E+00
0.89758E+03	0.85570E+00	0.53194E+00	0.45518E+00	0.95584E+00
0.89768E+03	0.85508E+00	0.53182E+00	0.45475E+00	0.95494E+00
0.89778E+03	0.85444E+00	0.53170E+00	0.45430E+00	0.95400E+00
0.89788E+03	0.85376E+00	0.53158E+00	0.45384E+00	0.95303E+00
0.89798E+03	0.85307E+00	0.53146E+00	0.45337E+00	0.95205E+00
0.89808E+03	0.85239E+00	0.53131E+00	0.45288E+00	0.95102E+00
0.89818E+03	0.85172E+00	0.53115E+00	0.45239E+00	0.94998E+00
0.89828E+03	0.85108E+00	0.53099E+00	0.45191E+00	0.94897E+00
0.89838E+03	0.85049E+00	0.53083E+00	0.45146E+00	0.94803E+00
0.89848E+03	0.84995E+00	0.53067E+00	0.45104E+00	0.94715E+00
0.89858E+03	0.84946E+00	0.53051E+00	0.45064E+00	0.94631E+00
0.89868E+03	0.84899E+00	0.53035E+00	0.45026E+00	0.94551E+00
0.89878E+03	0.84855E+00	0.53019E+00	0.44989E+00	0.94474E+00
0.89888E+03	0.84810E+00	0.53003E+00	0.44952E+00	0.94395E+00
0.89898E+03	0.84764E+00	0.52989E+00	0.44915E+00	0.94319E+00
0.89908E+03	0.84718E+00	0.52975E+00	0.44879E+00	0.94243E+00
0.89918E+03	0.84674E+00	0.52961E+00	0.44844E+00	0.94169E+00
0.89928E+03	0.84634E+00	0.52947E+00	0.44811E+00	0.94100E+00
0.89938E+03	0.84600E+00	0.52933E+00	0.44781E+00	0.94037E+00
0.89948E+03	0.84569E+00	0.52919E+00	0.44753E+00	0.93977E+00
0.89958E+03	0.84536E+00	0.52905E+00	0.44723E+00	0.93916E+00
0.89968E+03	0.84502E+00	0.52891E+00	0.44694E+00	0.93854E+00
0.89978E+03	0.84471E+00	0.52877E+00	0.44666E+00	0.93794E+00
0.89988E+03	0.84445E+00	0.52863E+00	0.44640E+00	0.93740E+00
0.89998E+03	0.84422E+00	0.52849E+00	0.44616E+00	0.93690E+00
0.90008E+03	0.84404E+00	0.52831E+00	0.44592E+00	0.93640E+00
0.90018E+03	0.84389E+00	0.52813E+00	0.44569E+00	0.93591E+00
0.90028E+03	0.84373E+00	0.52795E+00	0.44545E+00	0.93541E+00

0.90038E+03	0.84356E+00	0.52777E+00	0.44521E+00	0.93491E+00
0.90048E+03	0.84342E+00	0.52759E+00	0.44498E+00	0.93443E+00
0.90058E+03	0.84332E+00	0.52741E+00	0.44477E+00	0.93399E+00
0.90068E+03	0.84326E+00	0.52723E+00	0.44459E+00	0.93360E+00
0.90078E+03	0.84322E+00	0.52705E+00	0.44441E+00	0.93323E+00
0.90088E+03	0.84320E+00	0.52686E+00	0.44425E+00	0.93288E+00
0.90098E+03	0.84320E+00	0.52668E+00	0.44409E+00	0.93256E+00
0.90108E+03	0.84322E+00	0.52649E+00	0.44395E+00	0.93226E+00
0.90118E+03	0.84327E+00	0.52630E+00	0.44381E+00	0.93198E+00
0.90128E+03	0.84330E+00	0.52612E+00	0.44367E+00	0.93168E+00
0.90138E+03	0.84333E+00	0.52593E+00	0.44353E+00	0.93138E+00
0.90148E+03	0.84338E+00	0.52574E+00	0.44340E+00	0.93110E+00
0.90158E+03	0.84347E+00	0.52556E+00	0.44329E+00	0.93087E+00
0.90168E+03	0.84359E+00	0.52537E+00	0.44319E+00	0.93067E+00
0.90178E+03	0.84373E+00	0.52518E+00	0.44311E+00	0.93049E+00
0.90188E+03	0.84389E+00	0.52499E+00	0.44303E+00	0.93034E+00
0.90198E+03	0.84404E+00	0.52480E+00	0.44295E+00	0.93017E+00
0.90208E+03	0.84413E+00	0.52458E+00	0.44282E+00	0.92988E+00
0.90218E+03	0.84418E+00	0.52436E+00	0.44266E+00	0.92954E+00
0.90228E+03	0.84424E+00	0.52414E+00	0.44250E+00	0.92922E+00
0.90238E+03	0.84435E+00	0.52392E+00	0.44237E+00	0.92895E+00
0.90248E+03	0.84452E+00	0.52370E+00	0.44227E+00	0.92874E+00
0.90258E+03	0.84470E+00	0.52348E+00	0.44218E+00	0.92855E+00
0.90268E+03	0.84488E+00	0.52325E+00	0.44209E+00	0.92835E+00
0.90278E+03	0.84504E+00	0.52302E+00	0.44198E+00	0.92811E+00
0.90288E+03	0.84517E+00	0.52277E+00	0.44183E+00	0.92780E+00
0.90298E+03	0.84530E+00	0.52252E+00	0.44169E+00	0.92751E+00
0.90308E+03	0.84554E+00	0.52225E+00	0.44158E+00	0.92728E+00
0.90318E+03	0.84585E+00	0.52197E+00	0.44151E+00	0.92713E+00
0.90328E+03	0.84615E+00	0.52168E+00	0.44142E+00	0.92695E+00
0.90338E+03	0.84638E+00	0.52140E+00	0.44131E+00	0.92671E+00
0.90348E+03	0.84656E+00	0.52112E+00	0.44116E+00	0.92640E+00
0.90358E+03	0.84671E+00	0.52084E+00	0.44100E+00	0.92607E+00
0.90368E+03	0.84688E+00	0.52056E+00	0.44085E+00	0.92575E+00
0.90378E+03	0.84707E+00	0.52028E+00	0.44071E+00	0.92545E+00
0.90388E+03	0.84730E+00	0.51999E+00	0.44059E+00	0.92521E+00
0.90398E+03	0.84759E+00	0.51971E+00	0.44050E+00	0.92502E+00
0.90408E+03	0.84786E+00	0.51941E+00	0.44039E+00	0.92479E+00
0.90418E+03	0.84812E+00	0.51911E+00	0.44026E+00	0.92452E+00
0.90428E+03	0.84833E+00	0.51880E+00	0.44012E+00	0.92421E+00
0.90438E+03	0.84852E+00	0.51850E+00	0.43996E+00	0.92388E+00
0.90448E+03	0.84873E+00	0.51819E+00	0.43981E+00	0.92356E+00
0.90458E+03	0.84894E+00	0.51789E+00	0.43965E+00	0.92324E+00

0.90468E+03	0.84911E+00	0.51758E+00	0.43948E+00	0.92288E+00
0.90478E+03	0.84927E+00	0.51726E+00	0.43929E+00	0.92248E+00
0.90488E+03	0.84941E+00	0.51694E+00	0.43909E+00	0.92206E+00
0.90498E+03	0.84952E+00	0.51662E+00	0.43888E+00	0.92161E+00
0.90508E+03	0.84959E+00	0.51630E+00	0.43864E+00	0.92111E+00
0.90518E+03	0.84960E+00	0.51598E+00	0.43837E+00	0.92055E+00
0.90528E+03	0.84959E+00	0.51565E+00	0.43810E+00	0.91997E+00
0.90538E+03	0.84957E+00	0.51533E+00	0.43781E+00	0.91936E+00
0.90548E+03	0.84953E+00	0.51501E+00	0.43752E+00	0.91875E+00
0.90558E+03	0.84951E+00	0.51469E+00	0.43723E+00	0.91815E+00
0.90568E+03	0.84947E+00	0.51437E+00	0.43694E+00	0.91754E+00
0.90578E+03	0.84939E+00	0.51404E+00	0.43663E+00	0.91688E+00
0.90588E+03	0.84926E+00	0.51372E+00	0.43628E+00	0.91616E+00
0.90598E+03	0.84909E+00	0.51340E+00	0.43592E+00	0.91540E+00
0.90608E+03	0.84892E+00	0.51307E+00	0.43556E+00	0.91463E+00
0.90618E+03	0.84879E+00	0.51274E+00	0.43521E+00	0.91391E+00
0.90628E+03	0.84871E+00	0.51241E+00	0.43489E+00	0.91323E+00
0.90638E+03	0.84863E+00	0.51208E+00	0.43457E+00	0.91256E+00
0.90648E+03	0.84854E+00	0.51175E+00	0.43424E+00	0.91187E+00
0.90658E+03	0.84842E+00	0.51142E+00	0.43390E+00	0.91116E+00
0.90668E+03	0.84832E+00	0.51110E+00	0.43357E+00	0.91047E+00
0.90678E+03	0.84825E+00	0.51077E+00	0.43326E+00	0.90981E+00
0.90688E+03	0.84818E+00	0.51044E+00	0.43295E+00	0.90916E+00
0.90698E+03	0.84812E+00	0.51012E+00	0.43264E+00	0.90851E+00
0.90708E+03	0.84806E+00	0.50979E+00	0.43233E+00	0.90786E+00
0.90718E+03	0.84795E+00	0.50946E+00	0.43200E+00	0.90716E+00
0.90728E+03	0.84780E+00	0.50913E+00	0.43164E+00	0.90642E+00
0.90738E+03	0.84762E+00	0.50880E+00	0.43127E+00	0.90564E+00
0.90748E+03	0.84744E+00	0.50848E+00	0.43090E+00	0.90486E+00
0.90758E+03	0.84728E+00	0.50815E+00	0.43054E+00	0.90411E+00
0.90768E+03	0.84712E+00	0.50782E+00	0.43019E+00	0.90336E+00
0.90778E+03	0.84698E+00	0.50749E+00	0.42984E+00	0.90262E+00
0.90788E+03	0.84686E+00	0.50716E+00	0.42950E+00	0.90191E+00
0.90798E+03	0.84676E+00	0.50683E+00	0.42917E+00	0.90122E+00
0.90808E+03	0.84664E+00	0.50651E+00	0.42883E+00	0.90052E+00
0.90818E+03	0.84648E+00	0.50619E+00	0.42848E+00	0.89977E+00
0.90828E+03	0.84628E+00	0.50587E+00	0.42811E+00	0.89899E+00
0.90838E+03	0.84606E+00	0.50555E+00	0.42773E+00	0.89819E+00
0.90848E+03	0.84583E+00	0.50523E+00	0.42734E+00	0.89737E+00
0.90858E+03	0.84556E+00	0.50489E+00	0.42692E+00	0.89649E+00
0.90868E+03	0.84525E+00	0.50455E+00	0.42647E+00	0.89556E+00
0.90878E+03	0.84492E+00	0.50420E+00	0.42601E+00	0.89459E+00
0.90888E+03	0.84457E+00	0.50386E+00	0.42554E+00	0.89361E+00

0.90898E+03	0.84421E+00	0.50351E+00	0.42507E+00	0.89262E+00
0.90908E+03	0.84387E+00	0.50317E+00	0.42461E+00	0.89165E+00
0.90918E+03	0.84358E+00	0.50282E+00	0.42417E+00	0.89072E+00
0.90928E+03	0.84331E+00	0.50248E+00	0.42374E+00	0.88983E+00
0.90938E+03	0.84304E+00	0.50213E+00	0.42332E+00	0.88894E+00
0.90948E+03	0.84275E+00	0.50179E+00	0.42288E+00	0.88802E+00
0.90958E+03	0.84244E+00	0.50144E+00	0.42243E+00	0.88708E+00
0.90968E+03	0.84215E+00	0.50110E+00	0.42200E+00	0.88616E+00
0.90978E+03	0.84192E+00	0.50075E+00	0.42159E+00	0.88531E+00
0.90988E+03	0.84175E+00	0.50041E+00	0.42122E+00	0.88453E+00
0.90998E+03	0.84165E+00	0.50006E+00	0.42088E+00	0.88381E+00
0.91008E+03	0.84162E+00	0.49973E+00	0.42058E+00	0.88318E+00
0.91018E+03	0.84163E+00	0.49939E+00	0.42031E+00	0.88261E+00
0.91028E+03	0.84164E+00	0.49906E+00	0.42003E+00	0.88203E+00
0.91038E+03	0.84163E+00	0.49873E+00	0.41974E+00	0.88143E+00
0.91048E+03	0.84160E+00	0.49839E+00	0.41945E+00	0.88081E+00
0.91058E+03	0.84154E+00	0.49804E+00	0.41912E+00	0.88012E+00
0.91068E+03	0.84146E+00	0.49769E+00	0.41878E+00	0.87941E+00
0.91078E+03	0.84138E+00	0.49734E+00	0.41845E+00	0.87871E+00
0.91088E+03	0.84135E+00	0.49699E+00	0.41814E+00	0.87806E+00
0.91098E+03	0.84138E+00	0.49664E+00	0.41786E+00	0.87748E+00
0.91108E+03	0.84144E+00	0.49629E+00	0.41760E+00	0.87692E+00
0.91118E+03	0.84149E+00	0.49594E+00	0.41733E+00	0.87636E+00
0.91128E+03	0.84155E+00	0.49559E+00	0.41706E+00	0.87580E+00
0.91138E+03	0.84162E+00	0.49524E+00	0.41680E+00	0.87525E+00
0.91148E+03	0.84171E+00	0.49489E+00	0.41655E+00	0.87472E+00
0.91158E+03	0.84182E+00	0.49454E+00	0.41631E+00	0.87422E+00
0.91168E+03	0.84197E+00	0.49419E+00	0.41609E+00	0.87376E+00
0.91178E+03	0.84214E+00	0.49384E+00	0.41588E+00	0.87331E+00
0.91188E+03	0.84227E+00	0.49349E+00	0.41565E+00	0.87283E+00
0.91198E+03	0.84232E+00	0.49314E+00	0.41538E+00	0.87227E+00
0.91208E+03	0.84230E+00	0.49281E+00	0.41509E+00	0.87166E+00
0.91218E+03	0.84221E+00	0.49248E+00	0.41477E+00	0.87099E+00
0.91228E+03	0.84207E+00	0.49215E+00	0.41442E+00	0.87026E+00
0.91238E+03	0.84185E+00	0.49182E+00	0.41404E+00	0.86946E+00
0.91248E+03	0.84156E+00	0.49149E+00	0.41362E+00	0.86857E+00
0.91258E+03	0.84114E+00	0.49116E+00	0.41314E+00	0.86755E+00
0.91268E+03	0.84056E+00	0.49083E+00	0.41257E+00	0.86637E+00
0.91278E+03	0.83981E+00	0.49050E+00	0.41192E+00	0.86500E+00
0.91288E+03	0.83887E+00	0.49017E+00	0.41119E+00	0.86346E+00
0.91298E+03	0.83775E+00	0.48983E+00	0.41036E+00	0.86171E+00
0.91308E+03	0.83644E+00	0.48950E+00	0.40944E+00	0.85979E+00
0.91318E+03	0.83494E+00	0.48917E+00	0.40843E+00	0.85767E+00

0.91328E+03	0.83320E+00	0.48884E+00	0.40730E+00	0.85529E+00
0.91338E+03	0.83120E+00	0.48851E+00	0.40604E+00	0.85266E+00
0.91348E+03	0.82894E+00	0.48817E+00	0.40467E+00	0.84977E+00
0.91358E+03	0.82642E+00	0.48784E+00	0.40316E+00	0.84661E+00
0.91368E+03	0.82359E+00	0.48751E+00	0.40151E+00	0.84313E+00
0.91378E+03	0.82039E+00	0.48717E+00	0.39967E+00	0.83928E+00
0.91388E+03	0.81679E+00	0.48684E+00	0.39765E+00	0.83503E+00
0.91398E+03	0.81276E+00	0.48651E+00	0.39542E+00	0.83034E+00
0.91408E+03	0.80831E+00	0.48619E+00	0.39300E+00	0.82526E+00
0.91418E+03	0.80348E+00	0.48589E+00	0.39040E+00	0.81981E+00
0.91428E+03	0.79830E+00	0.48558E+00	0.38764E+00	0.81401E+00
0.91438E+03	0.79281E+00	0.48527E+00	0.38473E+00	0.80790E+00
0.91448E+03	0.78696E+00	0.48497E+00	0.38165E+00	0.80143E+00
0.91458E+03	0.78072E+00	0.48466E+00	0.37838E+00	0.79457E+00
0.91468E+03	0.77407E+00	0.48435E+00	0.37492E+00	0.78731E+00
0.91478E+03	0.76701E+00	0.48405E+00	0.37127E+00	0.77963E+00
0.91488E+03	0.75954E+00	0.48374E+00	0.36742E+00	0.77155E+00
0.91498E+03	0.75168E+00	0.48343E+00	0.36338E+00	0.76308E+00
0.91508E+03	0.74339E+00	0.48312E+00	0.35915E+00	0.75418E+00
0.91518E+03	0.73467E+00	0.48282E+00	0.35471E+00	0.74487E+00
0.91528E+03	0.72553E+00	0.48251E+00	0.35008E+00	0.73513E+00
0.91538E+03	0.71594E+00	0.48220E+00	0.34523E+00	0.72495E+00
0.91548E+03	0.70590E+00	0.48189E+00	0.34017E+00	0.71432E+00
0.91558E+03	0.69543E+00	0.48159E+00	0.33491E+00	0.70328E+00
0.91568E+03	0.68457E+00	0.48128E+00	0.32947E+00	0.69186E+00
0.91578E+03	0.67335E+00	0.48097E+00	0.32386E+00	0.68009E+00
0.91588E+03	0.66180E+00	0.48066E+00	0.31810E+00	0.66799E+00
0.91598E+03	0.64995E+00	0.48035E+00	0.31221E+00	0.65561E+00
0.91608E+03	0.63780E+00	0.48006E+00	0.30619E+00	0.64297E+00
0.91618E+03	0.62536E+00	0.47978E+00	0.30004E+00	0.63005E+00
0.91628E+03	0.61262E+00	0.47949E+00	0.29375E+00	0.61685E+00
0.91638E+03	0.59961E+00	0.47920E+00	0.28733E+00	0.60337E+00
0.91648E+03	0.58635E+00	0.47890E+00	0.28080E+00	0.58967E+00
0.91658E+03	0.57290E+00	0.47860E+00	0.27419E+00	0.57578E+00
0.91668E+03	0.55930E+00	0.47831E+00	0.26752E+00	0.56177E+00
0.91678E+03	0.54560E+00	0.47801E+00	0.26080E+00	0.54767E+00
0.91688E+03	0.53181E+00	0.47771E+00	0.25405E+00	0.53349E+00
0.91698E+03	0.51793E+00	0.47741E+00	0.24727E+00	0.51925E+00
0.91708E+03	0.50401E+00	0.47712E+00	0.24047E+00	0.50498E+00
0.91718E+03	0.49007E+00	0.47682E+00	0.23367E+00	0.49070E+00
0.91728E+03	0.47606E+00	0.47652E+00	0.22685E+00	0.47637E+00
0.91738E+03	0.46196E+00	0.47622E+00	0.21999E+00	0.46197E+00
0.91748E+03	0.44785E+00	0.47592E+00	0.21314E+00	0.44758E+00

0.91758E+03	0.43382E+00	0.47562E+00	0.20634E+00	0.43329E+00
0.91768E+03	0.41990E+00	0.47533E+00	0.19959E+00	0.41912E+00
0.91778E+03	0.40609E+00	0.47503E+00	0.19290E+00	0.40508E+00
0.91788E+03	0.39239E+00	0.47473E+00	0.18628E+00	0.39117E+00
0.91798E+03	0.37879E+00	0.47443E+00	0.17971E+00	0.37738E+00
0.91808E+03	0.36527E+00	0.47414E+00	0.17319E+00	0.36369E+00
0.91818E+03	0.35187E+00	0.47387E+00	0.16674E+00	0.35014E+00
0.91828E+03	0.33867E+00	0.47359E+00	0.16039E+00	0.33681E+00
0.91838E+03	0.32574E+00	0.47332E+00	0.15418E+00	0.32376E+00
0.91848E+03	0.31308E+00	0.47305E+00	0.14810E+00	0.31100E+00
0.91858E+03	0.30070E+00	0.47277E+00	0.14216E+00	0.29853E+00
0.91868E+03	0.28858E+00	0.47250E+00	0.13635E+00	0.28633E+00
0.91878E+03	0.27672E+00	0.47222E+00	0.13067E+00	0.27441E+00
0.91888E+03	0.26514E+00	0.47195E+00	0.12513E+00	0.26277E+00
0.91898E+03	0.25390E+00	0.47167E+00	0.11976E+00	0.25148E+00
0.91908E+03	0.24302E+00	0.47139E+00	0.11456E+00	0.24056E+00
0.91918E+03	0.23252E+00	0.47112E+00	0.10954E+00	0.23004E+00
0.91928E+03	0.22237E+00	0.47084E+00	0.10470E+00	0.21986E+00
0.91938E+03	0.21255E+00	0.47057E+00	0.10002E+00	0.21004E+00
0.91948E+03	0.20309E+00	0.47029E+00	0.95510E-01	0.20056E+00
0.91958E+03	0.19398E+00	0.47002E+00	0.91175E-01	0.19146E+00
0.91968E+03	0.18524E+00	0.46974E+00	0.87015E-01	0.18272E+00
0.91978E+03	0.17685E+00	0.46946E+00	0.83023E-01	0.17434E+00
0.91988E+03	0.16878E+00	0.46919E+00	0.79187E-01	0.16629E+00
0.91998E+03	0.16102E+00	0.46891E+00	0.75503E-01	0.15855E+00
0.92008E+03	0.15359E+00	0.46866E+00	0.71980E-01	0.15115E+00
0.92018E+03	0.14649E+00	0.46843E+00	0.68622E-01	0.14410E+00
0.92028E+03	0.13971E+00	0.46821E+00	0.65414E-01	0.13736E+00
0.92038E+03	0.13322E+00	0.46799E+00	0.62346E-01	0.13092E+00
0.92048E+03	0.12701E+00	0.46777E+00	0.59413E-01	0.12476E+00
0.92058E+03	0.12107E+00	0.46755E+00	0.56608E-01	0.11887E+00
0.92068E+03	0.11535E+00	0.46733E+00	0.53908E-01	0.11320E+00
0.92078E+03	0.10986E+00	0.46711E+00	0.51317E-01	0.10776E+00
0.92088E+03	0.10464E+00	0.46689E+00	0.48856E-01	0.10259E+00
0.92098E+03	0.99719E-01	0.46667E+00	0.46535E-01	0.97721E-01
0.92108E+03	0.95105E-01	0.46645E+00	0.44361E-01	0.93155E-01
0.92118E+03	0.90784E-01	0.46623E+00	0.42326E-01	0.88881E-01
0.92128E+03	0.86696E-01	0.46600E+00	0.40401E-01	0.84839E-01
0.92138E+03	0.82785E-01	0.46578E+00	0.38560E-01	0.80973E-01
0.92148E+03	0.79013E-01	0.46556E+00	0.36786E-01	0.77247E-01
0.92158E+03	0.75401E-01	0.46534E+00	0.35087E-01	0.73680E-01
0.92168E+03	0.71968E-01	0.46512E+00	0.33474E-01	0.70293E-01
0.92178E+03	0.68715E-01	0.46490E+00	0.31946E-01	0.67084E-01

0.92188E+03	0.65646E-01	0.46468E+00	0.30504E-01	0.64057E-01
0.92198E+03	0.62742E-01	0.46446E+00	0.29141E-01	0.61194E-01
0.92208E+03	0.59972E-01	0.46427E+00	0.27843E-01	0.58469E-01
0.92218E+03	0.57336E-01	0.46408E+00	0.26609E-01	0.55876E-01
0.92228E+03	0.54805E-01	0.46390E+00	0.25424E-01	0.53388E-01
0.92238E+03	0.52384E-01	0.46371E+00	0.24291E-01	0.51009E-01
0.92248E+03	0.50091E-01	0.46352E+00	0.23218E-01	0.48757E-01
0.92258E+03	0.47928E-01	0.46334E+00	0.22207E-01	0.46632E-01
0.92268E+03	0.45886E-01	0.46315E+00	0.21252E-01	0.44628E-01
0.92278E+03	0.43954E-01	0.46296E+00	0.20349E-01	0.42731E-01
0.92288E+03	0.42116E-01	0.46279E+00	0.19491E-01	0.40929E-01
0.92298E+03	0.40370E-01	0.46262E+00	0.18676E-01	0.39218E-01
0.92308E+03	0.38690E-01	0.46245E+00	0.17892E-01	0.37573E-01
0.92318E+03	0.37067E-01	0.46228E+00	0.17135E-01	0.35983E-01
0.92328E+03	0.35489E-01	0.46211E+00	0.16400E-01	0.34438E-01
0.92338E+03	0.33944E-01	0.46195E+00	0.15680E-01	0.32927E-01
0.92348E+03	0.32448E-01	0.46178E+00	0.14984E-01	0.31464E-01
0.92358E+03	0.31025E-01	0.46161E+00	0.14321E-01	0.30073E-01
0.92368E+03	0.29692E-01	0.46144E+00	0.13701E-01	0.28771E-01
0.92378E+03	0.28457E-01	0.46127E+00	0.13126E-01	0.27564E-01
0.92388E+03	0.27295E-01	0.46110E+00	0.12586E-01	0.26429E-01
0.92398E+03	0.26199E-01	0.46093E+00	0.12076E-01	0.25358E-01
0.92408E+03	0.25158E-01	0.46080E+00	0.11593E-01	0.24344E-01
0.92418E+03	0.24145E-01	0.46067E+00	0.11123E-01	0.23357E-01
0.92428E+03	0.23147E-01	0.46054E+00	0.10660E-01	0.22386E-01
0.92438E+03	0.22210E-01	0.46041E+00	0.10226E-01	0.21474E-01
0.92448E+03	0.21390E-01	0.46029E+00	0.98457E-02	0.20675E-01
0.92458E+03	0.20666E-01	0.46016E+00	0.95095E-02	0.19969E-01
0.92468E+03	0.19973E-01	0.46003E+00	0.91883E-02	0.19295E-01
0.92478E+03	0.19313E-01	0.45990E+00	0.88819E-02	0.18651E-01
0.92488E+03	0.18657E-01	0.45978E+00	0.85783E-02	0.18014E-01
0.92498E+03	0.17986E-01	0.45965E+00	0.82672E-02	0.17360E-01
0.92508E+03	0.17315E-01	0.45952E+00	0.79566E-02	0.16708E-01
0.92518E+03	0.16652E-01	0.45939E+00	0.76498E-02	0.16064E-01
0.92528E+03	0.16033E-01	0.45927E+00	0.73634E-02	0.15463E-01
0.92538E+03	0.15463E-01	0.45914E+00	0.70999E-02	0.14909E-01
0.92548E+03	0.14909E-01	0.45902E+00	0.68435E-02	0.14371E-01
0.92558E+03	0.14372E-01	0.45889E+00	0.65953E-02	0.13850E-01
0.92568E+03	0.13837E-01	0.45876E+00	0.63480E-02	0.13330E-01
0.92578E+03	0.13306E-01	0.45864E+00	0.61027E-02	0.12815E-01
0.92588E+03	0.12820E-01	0.45851E+00	0.58783E-02	0.12344E-01
0.92598E+03	0.12379E-01	0.45839E+00	0.56742E-02	0.11915E-01
0.92608E+03	0.11941E-01	0.45829E+00	0.54726E-02	0.11492E-01

0.92618E+03	0.11508E-01	0.45820E+00	0.52730E-02	0.11073E-01
0.92628E+03	0.11077E-01	0.45812E+00	0.50747E-02	0.10656E-01
0.92638E+03	0.10652E-01	0.45803E+00	0.48789E-02	0.10245E-01
0.92648E+03	0.10238E-01	0.45794E+00	0.46884E-02	0.98452E-02
0.92658E+03	0.98366E-02	0.45786E+00	0.45038E-02	0.94576E-02
0.92668E+03	0.94477E-02	0.45777E+00	0.43249E-02	0.90819E-02
0.92678E+03	0.90627E-02	0.45769E+00	0.41479E-02	0.87102E-02
0.92688E+03	0.87017E-02	0.45760E+00	0.39819E-02	0.83617E-02
0.92698E+03	0.83538E-02	0.45751E+00	0.38220E-02	0.80259E-02
0.92708E+03	0.80380E-02	0.45743E+00	0.36768E-02	0.77210E-02
0.92718E+03	0.77545E-02	0.45734E+00	0.35465E-02	0.74473E-02
0.92728E+03	0.74716E-02	0.45726E+00	0.34164E-02	0.71743E-02
0.92738E+03	0.71911E-02	0.45718E+00	0.32876E-02	0.69036E-02
0.92748E+03	0.69557E-02	0.45709E+00	0.31794E-02	0.66765E-02
0.92758E+03	0.67313E-02	0.45701E+00	0.30763E-02	0.64599E-02
0.92768E+03	0.65079E-02	0.45692E+00	0.29736E-02	0.62443E-02
0.92778E+03	0.62852E-02	0.45684E+00	0.28713E-02	0.60295E-02
0.92788E+03	0.60631E-02	0.45676E+00	0.27693E-02	0.58154E-02
0.92798E+03	0.58567E-02	0.45668E+00	0.26746E-02	0.56165E-02
0.92808E+03	0.56505E-02	0.45663E+00	0.25802E-02	0.54182E-02
0.92818E+03	0.54463E-02	0.45659E+00	0.24867E-02	0.52219E-02
0.92828E+03	0.52448E-02	0.45655E+00	0.23945E-02	0.50283E-02
0.92838E+03	0.50434E-02	0.45652E+00	0.23024E-02	0.48348E-02
0.92848E+03	0.48423E-02	0.45648E+00	0.22104E-02	0.46417E-02
0.92858E+03	0.46425E-02	0.45644E+00	0.21190E-02	0.44498E-02
0.92868E+03	0.44547E-02	0.45640E+00	0.20331E-02	0.42694E-02
0.92878E+03	0.42685E-02	0.45636E+00	0.19480E-02	0.40906E-02
0.92888E+03	0.40843E-02	0.45632E+00	0.18638E-02	0.39138E-02
0.92898E+03	0.39059E-02	0.45628E+00	0.17822E-02	0.37424E-02
0.92908E+03	0.37321E-02	0.45624E+00	0.17027E-02	0.35756E-02
0.92918E+03	0.35599E-02	0.45620E+00	0.16240E-02	0.34104E-02
0.92928E+03	0.34032E-02	0.45617E+00	0.15524E-02	0.32599E-02
0.92938E+03	0.32513E-02	0.45613E+00	0.14830E-02	0.31141E-02
0.92948E+03	0.31040E-02	0.45609E+00	0.14157E-02	0.29728E-02
0.92958E+03	0.29678E-02	0.45605E+00	0.13535E-02	0.28422E-02
0.92968E+03	0.28326E-02	0.45601E+00	0.12917E-02	0.27125E-02
0.92978E+03	0.27013E-02	0.45596E+00	0.12317E-02	0.25865E-02
0.92988E+03	0.25715E-02	0.45590E+00	0.11723E-02	0.24618E-02
0.92998E+03	0.24434E-02	0.45584E+00	0.11138E-02	0.23389E-02
0.93008E+03	0.23156E-02	0.45582E+00	0.10555E-02	0.22164E-02
0.93018E+03	0.21965E-02	0.45580E+00	0.10012E-02	0.21023E-02
0.93028E+03	0.20780E-02	0.45578E+00	0.94712E-03	0.19889E-02
0.93038E+03	0.19604E-02	0.45577E+00	0.89347E-03	0.18762E-02

0.93048E+03	0.18427E-02	0.45575E+00	0.83983E-03	0.17636E-02
0.93058E+03	0.17261E-02	0.45573E+00	0.78664E-03	0.16519E-02
0.93068E+03	0.16104E-02	0.45572E+00	0.73388E-03	0.15411E-02
0.93078E+03	0.15051E-02	0.45570E+00	0.68587E-03	0.14403E-02
0.93088E+03	0.14043E-02	0.45568E+00	0.63991E-03	0.13438E-02
0.93098E+03	0.13043E-02	0.45566E+00	0.59435E-03	0.12481E-02
0.93108E+03	0.12079E-02	0.45565E+00	0.55039E-03	0.11558E-02
0.93118E+03	0.11171E-02	0.45563E+00	0.50898E-03	0.10688E-02
0.93128E+03	0.10275E-02	0.45561E+00	0.46816E-03	0.98310E-03
0.93138E+03	0.93800E-03	0.45560E+00	0.42735E-03	0.89741E-03
0.93148E+03	0.85271E-03	0.45558E+00	0.38848E-03	0.81577E-03
0.93158E+03	0.76812E-03	0.45556E+00	0.34993E-03	0.73482E-03
0.93168E+03	0.69159E-03	0.45555E+00	0.31505E-03	0.66158E-03
0.93178E+03	0.61665E-03	0.45553E+00	0.28090E-03	0.58987E-03
0.93188E+03	0.54684E-03	0.45551E+00	0.24909E-03	0.52307E-03
0.93198E+03	0.48101E-03	0.45549E+00	0.21909E-03	0.46007E-03
0.93208E+03	0.42344E-03	0.45549E+00	0.19287E-03	0.40502E-03
0.93218E+03	0.36666E-03	0.45550E+00	0.16702E-03	0.35072E-03
0.93228E+03	0.31132E-03	0.45551E+00	0.14181E-03	0.29778E-03
0.93238E+03	0.25731E-03	0.45552E+00	0.11721E-03	0.24614E-03
0.93248E+03	0.21212E-03	0.45553E+00	0.96627E-04	0.20291E-03
0.93258E+03	0.16848E-03	0.45554E+00	0.76749E-04	0.16117E-03
0.93268E+03	0.12846E-03	0.45555E+00	0.58518E-04	0.12288E-03
0.93278E+03	0.93439E-04	0.45556E+00	0.42567E-04	0.89387E-04
0.93288E+03	0.61745E-04	0.45557E+00	0.28129E-04	0.59069E-04
0.93298E+03	0.31210E-04	0.45558E+00	0.14218E-04	0.29858E-04
0.93308E+03	0.65434E-05	0.45559E+00	0.29811E-05	0.62600E-05
0.93318E+03	0.00000E+00	0.45560E+00	0.00000E+00	0.00000E+00
Channel 9				
Wavenumber	HIRS Filter Transmittance	Optical Element Transmittance	Product of the HIRS Filter and Optical Element Transmittances	Normalized Value of Column 4
0.99723E+03	0.00000E+00	0.42675E+00	0.00000E+00	0.00000E+00
0.99733E+03	0.24724E-04	0.42679E+00	0.10552E-04	0.28513E-04
0.99743E+03	0.64974E-04	0.42682E+00	0.27732E-04	0.74940E-04
0.99753E+03	0.10660E-03	0.42685E+00	0.45502E-04	0.12296E-03
0.99763E+03	0.15185E-03	0.42689E+00	0.64824E-04	0.17517E-03
0.99773E+03	0.19860E-03	0.42692E+00	0.84787E-04	0.22912E-03
0.99783E+03	0.25152E-03	0.42695E+00	0.10739E-03	0.29019E-03
0.99793E+03	0.30629E-03	0.42699E+00	0.13078E-03	0.35341E-03
0.99803E+03	0.36139E-03	0.42702E+00	0.15432E-03	0.41702E-03
0.99813E+03	0.41772E-03	0.42706E+00	0.17839E-03	0.48206E-03

0.99823E+03	0.47742E-03	0.42709E+00	0.20390E-03	0.55101E-03
0.99833E+03	0.53934E-03	0.42713E+00	0.23037E-03	0.62252E-03
0.99843E+03	0.60183E-03	0.42717E+00	0.25708E-03	0.69471E-03
0.99853E+03	0.66558E-03	0.42720E+00	0.28434E-03	0.76837E-03
0.99863E+03	0.73085E-03	0.42724E+00	0.31225E-03	0.84378E-03
0.99873E+03	0.80006E-03	0.42728E+00	0.34185E-03	0.92377E-03
0.99883E+03	0.87216E-03	0.42731E+00	0.37269E-03	0.10071E-02
0.99893E+03	0.95549E-03	0.42735E+00	0.40833E-03	0.11034E-02
0.99903E+03	0.10458E-02	0.42739E+00	0.44698E-03	0.12079E-02
0.99913E+03	0.11381E-02	0.42742E+00	0.48644E-03	0.13145E-02
0.99923E+03	0.12343E-02	0.42746E+00	0.52760E-03	0.14257E-02
0.99933E+03	0.13369E-02	0.42749E+00	0.57150E-03	0.15444E-02
0.99943E+03	0.14500E-02	0.42752E+00	0.61990E-03	0.16751E-02
0.99953E+03	0.15701E-02	0.42755E+00	0.67129E-03	0.18140E-02
0.99963E+03	0.16914E-02	0.42758E+00	0.72322E-03	0.19543E-02
0.99973E+03	0.18142E-02	0.42761E+00	0.77577E-03	0.20964E-02
0.99983E+03	0.19390E-02	0.42764E+00	0.82921E-03	0.22407E-02
0.99993E+03	0.20671E-02	0.42767E+00	0.88402E-03	0.23889E-02
0.10000E+04	0.22004E-02	0.42770E+00	0.94110E-03	0.25431E-02
0.10001E+04	0.23346E-02	0.42772E+00	0.99857E-03	0.26984E-02
0.10002E+04	0.24694E-02	0.42774E+00	0.10563E-02	0.28543E-02
0.10003E+04	0.26078E-02	0.42776E+00	0.11155E-02	0.30144E-02
0.10004E+04	0.27516E-02	0.42779E+00	0.11771E-02	0.31808E-02
0.10005E+04	0.28961E-02	0.42781E+00	0.12390E-02	0.33481E-02
0.10006E+04	0.30429E-02	0.42783E+00	0.13018E-02	0.35179E-02
0.10007E+04	0.31969E-02	0.42785E+00	0.13678E-02	0.36962E-02
0.10008E+04	0.33566E-02	0.42788E+00	0.14362E-02	0.38810E-02
0.10009E+04	0.35231E-02	0.42790E+00	0.15075E-02	0.40738E-02
0.10010E+04	0.37035E-02	0.42792E+00	0.15848E-02	0.42826E-02
0.10011E+04	0.38856E-02	0.42795E+00	0.16628E-02	0.44934E-02
0.10012E+04	0.40807E-02	0.42798E+00	0.17465E-02	0.47194E-02
0.10013E+04	0.42764E-02	0.42801E+00	0.18303E-02	0.49461E-02
0.10014E+04	0.44773E-02	0.42805E+00	0.19165E-02	0.51789E-02
0.10015E+04	0.46789E-02	0.42808E+00	0.20029E-02	0.54125E-02
0.10016E+04	0.48836E-02	0.42811E+00	0.20908E-02	0.56498E-02
0.10017E+04	0.50903E-02	0.42815E+00	0.21794E-02	0.58893E-02
0.10018E+04	0.53016E-02	0.42818E+00	0.22700E-02	0.61342E-02
0.10019E+04	0.55142E-02	0.42822E+00	0.23613E-02	0.63808E-02
0.10020E+04	0.57292E-02	0.42825E+00	0.24535E-02	0.66301E-02
0.10021E+04	0.59445E-02	0.42829E+00	0.25460E-02	0.68800E-02
0.10022E+04	0.61607E-02	0.42833E+00	0.26388E-02	0.71308E-02
0.10023E+04	0.63772E-02	0.42837E+00	0.27318E-02	0.73822E-02
0.10024E+04	0.65939E-02	0.42842E+00	0.28249E-02	0.76338E-02

0.10025E+04	0.68110E-02	0.42846E+00	0.29182E-02	0.78858E-02
0.10026E+04	0.70329E-02	0.42850E+00	0.30136E-02	0.81435E-02
0.10027E+04	0.72589E-02	0.42854E+00	0.31107E-02	0.84060E-02
0.10028E+04	0.74850E-02	0.42858E+00	0.32079E-02	0.86687E-02
0.10029E+04	0.77229E-02	0.42862E+00	0.33102E-02	0.89450E-02
0.10030E+04	0.79680E-02	0.42866E+00	0.34155E-02	0.92298E-02
0.10031E+04	0.82152E-02	0.42870E+00	0.35218E-02	0.95169E-02
0.10032E+04	0.84634E-02	0.42873E+00	0.36285E-02	0.98052E-02
0.10033E+04	0.87177E-02	0.42876E+00	0.37378E-02	0.10101E-01
0.10034E+04	0.89737E-02	0.42880E+00	0.38479E-02	0.10398E-01
0.10035E+04	0.92364E-02	0.42883E+00	0.39609E-02	0.10703E-01
0.10036E+04	0.95049E-02	0.42887E+00	0.40763E-02	0.11015E-01
0.10037E+04	0.97754E-02	0.42890E+00	0.41927E-02	0.11330E-01
0.10038E+04	0.10048E-01	0.42893E+00	0.43097E-02	0.11646E-01
0.10039E+04	0.10321E-01	0.42897E+00	0.44273E-02	0.11964E-01
0.10040E+04	0.10594E-01	0.42900E+00	0.45449E-02	0.12282E-01
0.10041E+04	0.10877E-01	0.42903E+00	0.46665E-02	0.12610E-01
0.10042E+04	0.11166E-01	0.42906E+00	0.47909E-02	0.12946E-01
0.10043E+04	0.11457E-01	0.42910E+00	0.49162E-02	0.13285E-01
0.10044E+04	0.11749E-01	0.42913E+00	0.50418E-02	0.13624E-01
0.10045E+04	0.12043E-01	0.42916E+00	0.51685E-02	0.13967E-01
0.10046E+04	0.12350E-01	0.42919E+00	0.53005E-02	0.14323E-01
0.10047E+04	0.12664E-01	0.42922E+00	0.54358E-02	0.14689E-01
0.10048E+04	0.12985E-01	0.42925E+00	0.55736E-02	0.15061E-01
0.10049E+04	0.13308E-01	0.42928E+00	0.57128E-02	0.15437E-01
0.10050E+04	0.13639E-01	0.42931E+00	0.58553E-02	0.15823E-01
0.10051E+04	0.13974E-01	0.42934E+00	0.59995E-02	0.16212E-01
0.10052E+04	0.14328E-01	0.42936E+00	0.61519E-02	0.16624E-01
0.10053E+04	0.14722E-01	0.42939E+00	0.63213E-02	0.17082E-01
0.10054E+04	0.15124E-01	0.42942E+00	0.64945E-02	0.17550E-01
0.10055E+04	0.15534E-01	0.42944E+00	0.66708E-02	0.18026E-01
0.10056E+04	0.16009E-01	0.42947E+00	0.68752E-02	0.18579E-01
0.10057E+04	0.16509E-01	0.42950E+00	0.70905E-02	0.19161E-01
0.10058E+04	0.17011E-01	0.42953E+00	0.73067E-02	0.19745E-01
0.10059E+04	0.17530E-01	0.42955E+00	0.75300E-02	0.20348E-01
0.10060E+04	0.18057E-01	0.42958E+00	0.77568E-02	0.20961E-01
0.10061E+04	0.18592E-01	0.42961E+00	0.79873E-02	0.21584E-01
0.10062E+04	0.19131E-01	0.42964E+00	0.82193E-02	0.22211E-01
0.10063E+04	0.19677E-01	0.42966E+00	0.84547E-02	0.22847E-01
0.10064E+04	0.20228E-01	0.42969E+00	0.86920E-02	0.23488E-01
0.10065E+04	0.20792E-01	0.42972E+00	0.89347E-02	0.24144E-01
0.10066E+04	0.21374E-01	0.42975E+00	0.91855E-02	0.24822E-01
0.10067E+04	0.21969E-01	0.42978E+00	0.94419E-02	0.25515E-01

0.10068E+04	0.22568E-01	0.42980E+00	0.97000E-02	0.26212E-01
0.10069E+04	0.23172E-01	0.42983E+00	0.99602E-02	0.26915E-01
0.10070E+04	0.23784E-01	0.42985E+00	0.10224E-01	0.27627E-01
0.10071E+04	0.24425E-01	0.42987E+00	0.10500E-01	0.28373E-01
0.10072E+04	0.25103E-01	0.42990E+00	0.10792E-01	0.29162E-01
0.10073E+04	0.25792E-01	0.42992E+00	0.11089E-01	0.29964E-01
0.10074E+04	0.26512E-01	0.42994E+00	0.11399E-01	0.30802E-01
0.10075E+04	0.27268E-01	0.42996E+00	0.11724E-01	0.31682E-01
0.10076E+04	0.28053E-01	0.42998E+00	0.12062E-01	0.32596E-01
0.10077E+04	0.28852E-01	0.43000E+00	0.12406E-01	0.33525E-01
0.10078E+04	0.29672E-01	0.43002E+00	0.12760E-01	0.34480E-01
0.10079E+04	0.30508E-01	0.43005E+00	0.13120E-01	0.35454E-01
0.10080E+04	0.31356E-01	0.43007E+00	0.13485E-01	0.36440E-01
0.10081E+04	0.32220E-01	0.43009E+00	0.13857E-01	0.37446E-01
0.10082E+04	0.33087E-01	0.43011E+00	0.14231E-01	0.38457E-01
0.10083E+04	0.33958E-01	0.43013E+00	0.14606E-01	0.39470E-01
0.10084E+04	0.34846E-01	0.43016E+00	0.14989E-01	0.40504E-01
0.10085E+04	0.35737E-01	0.43018E+00	0.15373E-01	0.41543E-01
0.10086E+04	0.36632E-01	0.43020E+00	0.15759E-01	0.42586E-01
0.10087E+04	0.37551E-01	0.43022E+00	0.16155E-01	0.43656E-01
0.10088E+04	0.38471E-01	0.43024E+00	0.16552E-01	0.44728E-01
0.10089E+04	0.39392E-01	0.43027E+00	0.16949E-01	0.45801E-01
0.10090E+04	0.40322E-01	0.43029E+00	0.17350E-01	0.46884E-01
0.10091E+04	0.41269E-01	0.43031E+00	0.17759E-01	0.47988E-01
0.10092E+04	0.42217E-01	0.43033E+00	0.18168E-01	0.49094E-01
0.10093E+04	0.43173E-01	0.43035E+00	0.18580E-01	0.50208E-01
0.10094E+04	0.44222E-01	0.43037E+00	0.19032E-01	0.51429E-01
0.10095E+04	0.45408E-01	0.43040E+00	0.19543E-01	0.52812E-01
0.10096E+04	0.46741E-01	0.43042E+00	0.20118E-01	0.54365E-01
0.10097E+04	0.48152E-01	0.43044E+00	0.20727E-01	0.56009E-01
0.10098E+04	0.49619E-01	0.43046E+00	0.21359E-01	0.57718E-01
0.10099E+04	0.51173E-01	0.43048E+00	0.22029E-01	0.59528E-01
0.10100E+04	0.52863E-01	0.43050E+00	0.22757E-01	0.61497E-01
0.10101E+04	0.54644E-01	0.43052E+00	0.23525E-01	0.63572E-01
0.10102E+04	0.56475E-01	0.43053E+00	0.24314E-01	0.65703E-01
0.10103E+04	0.58338E-01	0.43055E+00	0.25117E-01	0.67874E-01
0.10104E+04	0.60231E-01	0.43057E+00	0.25934E-01	0.70080E-01
0.10105E+04	0.62134E-01	0.43058E+00	0.26754E-01	0.72296E-01
0.10106E+04	0.64030E-01	0.43060E+00	0.27571E-01	0.74505E-01
0.10107E+04	0.65984E-01	0.43061E+00	0.28414E-01	0.76782E-01
0.10108E+04	0.68052E-01	0.43062E+00	0.29304E-01	0.79189E-01
0.10109E+04	0.70197E-01	0.43062E+00	0.30228E-01	0.81684E-01
0.10110E+04	0.72413E-01	0.43061E+00	0.31182E-01	0.84262E-01

0.10111E+04	0.74716E-01	0.43061E+00	0.32174E-01	0.86942E-01
0.10112E+04	0.77141E-01	0.43061E+00	0.33218E-01	0.89763E-01
0.10113E+04	0.79678E-01	0.43061E+00	0.34310E-01	0.92715E-01
0.10114E+04	0.82328E-01	0.43060E+00	0.35451E-01	0.95798E-01
0.10115E+04	0.85080E-01	0.43060E+00	0.36636E-01	0.99000E-01
0.10116E+04	0.87967E-01	0.43060E+00	0.37878E-01	0.10236E+00
0.10117E+04	0.90936E-01	0.43060E+00	0.39156E-01	0.10581E+00
0.10118E+04	0.93951E-01	0.43059E+00	0.40454E-01	0.10932E+00
0.10119E+04	0.97039E-01	0.43059E+00	0.41784E-01	0.11291E+00
0.10120E+04	0.10025E+00	0.43059E+00	0.43165E-01	0.11664E+00
0.10121E+04	0.10356E+00	0.43059E+00	0.44589E-01	0.12049E+00
0.10122E+04	0.10696E+00	0.43058E+00	0.46054E-01	0.12445E+00
0.10123E+04	0.11045E+00	0.43058E+00	0.47556E-01	0.12851E+00
0.10124E+04	0.11404E+00	0.43058E+00	0.49103E-01	0.13269E+00
0.10125E+04	0.11774E+00	0.43058E+00	0.50698E-01	0.13700E+00
0.10126E+04	0.12157E+00	0.43058E+00	0.52347E-01	0.14145E+00
0.10127E+04	0.12553E+00	0.43058E+00	0.54050E-01	0.14606E+00
0.10128E+04	0.12964E+00	0.43058E+00	0.55822E-01	0.15085E+00
0.10129E+04	0.13386E+00	0.43059E+00	0.57637E-01	0.15575E+00
0.10130E+04	0.13818E+00	0.43059E+00	0.59498E-01	0.16078E+00
0.10131E+04	0.14261E+00	0.43059E+00	0.61408E-01	0.16594E+00
0.10132E+04	0.14714E+00	0.43060E+00	0.63359E-01	0.17121E+00
0.10133E+04	0.15181E+00	0.43060E+00	0.65370E-01	0.17665E+00
0.10134E+04	0.15667E+00	0.43060E+00	0.67464E-01	0.18231E+00
0.10135E+04	0.16172E+00	0.43061E+00	0.69640E-01	0.18819E+00
0.10136E+04	0.16699E+00	0.43061E+00	0.71908E-01	0.19432E+00
0.10137E+04	0.17242E+00	0.43061E+00	0.74247E-01	0.20064E+00
0.10138E+04	0.17801E+00	0.43061E+00	0.76654E-01	0.20714E+00
0.10139E+04	0.18376E+00	0.43062E+00	0.79130E-01	0.21383E+00
0.10140E+04	0.18970E+00	0.43062E+00	0.81688E-01	0.22074E+00
0.10141E+04	0.19587E+00	0.43062E+00	0.84344E-01	0.22792E+00
0.10142E+04	0.20229E+00	0.43062E+00	0.87110E-01	0.23540E+00
0.10143E+04	0.20889E+00	0.43061E+00	0.89950E-01	0.24307E+00
0.10144E+04	0.21562E+00	0.43061E+00	0.92850E-01	0.25091E+00
0.10145E+04	0.22249E+00	0.43061E+00	0.95806E-01	0.25889E+00
0.10146E+04	0.22948E+00	0.43061E+00	0.98818E-01	0.26703E+00
0.10147E+04	0.23659E+00	0.43063E+00	0.10188E+00	0.27532E+00
0.10148E+04	0.24380E+00	0.43065E+00	0.10499E+00	0.28372E+00
0.10149E+04	0.25114E+00	0.43067E+00	0.10816E+00	0.29227E+00
0.10150E+04	0.25863E+00	0.43069E+00	0.11139E+00	0.30100E+00
0.10151E+04	0.26631E+00	0.43071E+00	0.11470E+00	0.30995E+00
0.10152E+04	0.27423E+00	0.43073E+00	0.11812E+00	0.31919E+00
0.10153E+04	0.28237E+00	0.43075E+00	0.12163E+00	0.32868E+00

0.10154E+04	0.29075E+00	0.43077E+00	0.12524E+00	0.33844E+00
0.10155E+04	0.29930E+00	0.43079E+00	0.12893E+00	0.34842E+00
0.10156E+04	0.30804E+00	0.43080E+00	0.13271E+00	0.35861E+00
0.10157E+04	0.31694E+00	0.43082E+00	0.13655E+00	0.36899E+00
0.10158E+04	0.32601E+00	0.43084E+00	0.14046E+00	0.37956E+00
0.10159E+04	0.33524E+00	0.43086E+00	0.14444E+00	0.39032E+00
0.10160E+04	0.34461E+00	0.43088E+00	0.14849E+00	0.40125E+00
0.10161E+04	0.35405E+00	0.43089E+00	0.15256E+00	0.41225E+00
0.10162E+04	0.36356E+00	0.43090E+00	0.15666E+00	0.42333E+00
0.10163E+04	0.37314E+00	0.43090E+00	0.16079E+00	0.43449E+00
0.10164E+04	0.38282E+00	0.43091E+00	0.16496E+00	0.44578E+00
0.10165E+04	0.39258E+00	0.43092E+00	0.16917E+00	0.45715E+00
0.10166E+04	0.40241E+00	0.43094E+00	0.17341E+00	0.46860E+00
0.10167E+04	0.41232E+00	0.43095E+00	0.17769E+00	0.48016E+00
0.10168E+04	0.42229E+00	0.43096E+00	0.18199E+00	0.49179E+00
0.10169E+04	0.43229E+00	0.43097E+00	0.18631E+00	0.50345E+00
0.10170E+04	0.44236E+00	0.43099E+00	0.19065E+00	0.51520E+00
0.10171E+04	0.45251E+00	0.43100E+00	0.19503E+00	0.52703E+00
0.10172E+04	0.46274E+00	0.43101E+00	0.19945E+00	0.53896E+00
0.10173E+04	0.47300E+00	0.43102E+00	0.20387E+00	0.55092E+00
0.10174E+04	0.48327E+00	0.43104E+00	0.20830E+00	0.56290E+00
0.10175E+04	0.49352E+00	0.43105E+00	0.21273E+00	0.57486E+00
0.10176E+04	0.50374E+00	0.43106E+00	0.21714E+00	0.58678E+00
0.10177E+04	0.51387E+00	0.43107E+00	0.22152E+00	0.59860E+00
0.10178E+04	0.52394E+00	0.43108E+00	0.22586E+00	0.61035E+00
0.10179E+04	0.53398E+00	0.43110E+00	0.23019E+00	0.62205E+00
0.10180E+04	0.54396E+00	0.43110E+00	0.23450E+00	0.63368E+00
0.10181E+04	0.55383E+00	0.43110E+00	0.23876E+00	0.64519E+00
0.10182E+04	0.56360E+00	0.43110E+00	0.24297E+00	0.65657E+00
0.10183E+04	0.57328E+00	0.43110E+00	0.24714E+00	0.66783E+00
0.10184E+04	0.58286E+00	0.43109E+00	0.25127E+00	0.67899E+00
0.10185E+04	0.59232E+00	0.43109E+00	0.25535E+00	0.69002E+00
0.10186E+04	0.60164E+00	0.43110E+00	0.25937E+00	0.70088E+00
0.10187E+04	0.61081E+00	0.43111E+00	0.26333E+00	0.71158E+00
0.10188E+04	0.61984E+00	0.43111E+00	0.26722E+00	0.72210E+00
0.10189E+04	0.62871E+00	0.43112E+00	0.27105E+00	0.73245E+00
0.10190E+04	0.63751E+00	0.43112E+00	0.27484E+00	0.74271E+00
0.10191E+04	0.64616E+00	0.43113E+00	0.27858E+00	0.75280E+00
0.10192E+04	0.65466E+00	0.43114E+00	0.28225E+00	0.76271E+00
0.10193E+04	0.66300E+00	0.43114E+00	0.28585E+00	0.77244E+00
0.10194E+04	0.67114E+00	0.43115E+00	0.28936E+00	0.78193E+00
0.10195E+04	0.67906E+00	0.43115E+00	0.29278E+00	0.79117E+00
0.10196E+04	0.68679E+00	0.43116E+00	0.29612E+00	0.80019E+00

0.10197E+04	0.69432E+00	0.43116E+00	0.29937E+00	0.80897E+00
0.10198E+04	0.70172E+00	0.43117E+00	0.30256E+00	0.81760E+00
0.10199E+04	0.70895E+00	0.43118E+00	0.30568E+00	0.82604E+00
0.10200E+04	0.71597E+00	0.43118E+00	0.30871E+00	0.83423E+00
0.10201E+04	0.72277E+00	0.43118E+00	0.31165E+00	0.84215E+00
0.10202E+04	0.72939E+00	0.43118E+00	0.31450E+00	0.84986E+00
0.10203E+04	0.73578E+00	0.43118E+00	0.31726E+00	0.85732E+00
0.10204E+04	0.74200E+00	0.43119E+00	0.31994E+00	0.86456E+00
0.10205E+04	0.74801E+00	0.43120E+00	0.32254E+00	0.87160E+00
0.10206E+04	0.75383E+00	0.43121E+00	0.32506E+00	0.87839E+00
0.10207E+04	0.75941E+00	0.43122E+00	0.32747E+00	0.88492E+00
0.10208E+04	0.76477E+00	0.43123E+00	0.32979E+00	0.89118E+00
0.10209E+04	0.76994E+00	0.43124E+00	0.33203E+00	0.89723E+00
0.10210E+04	0.77496E+00	0.43125E+00	0.33420E+00	0.90310E+00
0.10211E+04	0.77982E+00	0.43126E+00	0.33631E+00	0.90879E+00
0.10212E+04	0.78449E+00	0.43127E+00	0.33833E+00	0.91426E+00
0.10213E+04	0.78895E+00	0.43128E+00	0.34026E+00	0.91948E+00
0.10214E+04	0.79317E+00	0.43130E+00	0.34209E+00	0.92443E+00
0.10215E+04	0.79719E+00	0.43131E+00	0.34384E+00	0.92914E+00
0.10216E+04	0.80110E+00	0.43132E+00	0.34553E+00	0.93372E+00
0.10217E+04	0.80487E+00	0.43133E+00	0.34717E+00	0.93814E+00
0.10218E+04	0.80849E+00	0.43133E+00	0.34873E+00	0.94237E+00
0.10219E+04	0.81193E+00	0.43132E+00	0.35020E+00	0.94633E+00
0.10220E+04	0.81511E+00	0.43129E+00	0.35155E+00	0.94999E+00
0.10221E+04	0.81809E+00	0.43125E+00	0.35280E+00	0.95337E+00
0.10222E+04	0.82090E+00	0.43121E+00	0.35398E+00	0.95655E+00
0.10223E+04	0.82357E+00	0.43117E+00	0.35510E+00	0.95957E+00
0.10224E+04	0.82612E+00	0.43113E+00	0.35617E+00	0.96247E+00
0.10225E+04	0.82854E+00	0.43110E+00	0.35718E+00	0.96520E+00
0.10226E+04	0.83081E+00	0.43106E+00	0.35813E+00	0.96777E+00
0.10227E+04	0.83295E+00	0.43103E+00	0.35902E+00	0.97018E+00
0.10228E+04	0.83501E+00	0.43100E+00	0.35989E+00	0.97251E+00
0.10229E+04	0.83704E+00	0.43096E+00	0.36073E+00	0.97480E+00
0.10230E+04	0.83906E+00	0.43093E+00	0.36157E+00	0.97707E+00
0.10231E+04	0.84101E+00	0.43089E+00	0.36239E+00	0.97927E+00
0.10232E+04	0.84285E+00	0.43086E+00	0.36315E+00	0.98134E+00
0.10233E+04	0.84454E+00	0.43083E+00	0.36385E+00	0.98323E+00
0.10234E+04	0.84600E+00	0.43079E+00	0.36445E+00	0.98485E+00
0.10235E+04	0.84728E+00	0.43076E+00	0.36498E+00	0.98627E+00
0.10236E+04	0.84843E+00	0.43073E+00	0.36544E+00	0.98753E+00
0.10237E+04	0.84951E+00	0.43070E+00	0.36588E+00	0.98871E+00
0.10238E+04	0.85055E+00	0.43066E+00	0.36630E+00	0.98985E+00
0.10239E+04	0.85153E+00	0.43063E+00	0.36670E+00	0.99091E+00

0.10240E+04	0.85248E+00	0.43059E+00	0.36707E+00	0.99193E+00
0.10241E+04	0.85340E+00	0.43053E+00	0.36742E+00	0.99286E+00
0.10242E+04	0.85430E+00	0.43048E+00	0.36775E+00	0.99377E+00
0.10243E+04	0.85515E+00	0.43041E+00	0.36807E+00	0.99462E+00
0.10244E+04	0.85591E+00	0.43034E+00	0.36833E+00	0.99534E+00
0.10245E+04	0.85656E+00	0.43027E+00	0.36855E+00	0.99593E+00
0.10246E+04	0.85710E+00	0.43021E+00	0.36873E+00	0.99640E+00
0.10247E+04	0.85758E+00	0.43014E+00	0.36888E+00	0.99681E+00
0.10248E+04	0.85804E+00	0.43007E+00	0.36902E+00	0.99719E+00
0.10249E+04	0.85855E+00	0.43000E+00	0.36918E+00	0.99762E+00
0.10250E+04	0.85915E+00	0.42993E+00	0.36937E+00	0.99815E+00
0.10251E+04	0.85972E+00	0.42986E+00	0.36956E+00	0.99866E+00
0.10252E+04	0.86020E+00	0.42980E+00	0.36971E+00	0.99905E+00
0.10253E+04	0.86056E+00	0.42973E+00	0.36981E+00	0.99932E+00
0.10254E+04	0.86082E+00	0.42966E+00	0.36986E+00	0.99946E+00
0.10255E+04	0.86104E+00	0.42959E+00	0.36990E+00	0.99957E+00
0.10256E+04	0.86125E+00	0.42952E+00	0.36993E+00	0.99965E+00
0.10257E+04	0.86146E+00	0.42946E+00	0.36996E+00	0.99974E+00
0.10258E+04	0.86172E+00	0.42939E+00	0.37001E+00	0.99988E+00
0.10259E+04	0.86193E+00	0.42932E+00	0.37005E+00	0.99997E+00
0.10260E+04	0.86206E+00	0.42925E+00	0.37004E+00	0.99995E+00
0.10261E+04	0.86220E+00	0.42916E+00	0.37002E+00	0.99990E+00
0.10262E+04	0.86240E+00	0.42907E+00	0.37003E+00	0.99992E+00
0.10263E+04	0.86262E+00	0.42898E+00	0.37005E+00	0.99997E+00
0.10264E+04	0.86284E+00	0.42889E+00	0.37006E+00	0.10000E+01
0.10265E+04	0.86300E+00	0.42880E+00	0.37005E+00	0.99998E+00
0.10266E+04	0.86314E+00	0.42870E+00	0.37003E+00	0.99992E+00
0.10267E+04	0.86322E+00	0.42861E+00	0.36999E+00	0.99981E+00
0.10268E+04	0.86322E+00	0.42852E+00	0.36991E+00	0.99960E+00
0.10269E+04	0.86316E+00	0.42843E+00	0.36981E+00	0.99932E+00
0.10270E+04	0.86309E+00	0.42834E+00	0.36970E+00	0.99902E+00
0.10271E+04	0.86296E+00	0.42825E+00	0.36956E+00	0.99866E+00
0.10272E+04	0.86274E+00	0.42816E+00	0.36939E+00	0.99819E+00
0.10273E+04	0.86246E+00	0.42807E+00	0.36919E+00	0.99766E+00
0.10274E+04	0.86213E+00	0.42798E+00	0.36897E+00	0.99707E+00
0.10275E+04	0.86181E+00	0.42789E+00	0.36876E+00	0.99649E+00
0.10276E+04	0.86154E+00	0.42780E+00	0.36857E+00	0.99597E+00
0.10277E+04	0.86124E+00	0.42771E+00	0.36836E+00	0.99542E+00
0.10278E+04	0.86086E+00	0.42762E+00	0.36812E+00	0.99477E+00
0.10279E+04	0.86039E+00	0.42753E+00	0.36784E+00	0.99401E+00
0.10280E+04	0.85984E+00	0.42744E+00	0.36753E+00	0.99316E+00
0.10281E+04	0.85928E+00	0.42733E+00	0.36719E+00	0.99226E+00
0.10282E+04	0.85874E+00	0.42721E+00	0.36687E+00	0.99138E+00

0.10283E+04	0.85821E+00	0.42710E+00	0.36654E+00	0.99050E+00
0.10284E+04	0.85765E+00	0.42699E+00	0.36621E+00	0.98959E+00
0.10285E+04	0.85706E+00	0.42688E+00	0.36586E+00	0.98865E+00
0.10286E+04	0.85643E+00	0.42677E+00	0.36550E+00	0.98767E+00
0.10287E+04	0.85581E+00	0.42665E+00	0.36514E+00	0.98670E+00
0.10288E+04	0.85523E+00	0.42654E+00	0.36479E+00	0.98577E+00
0.10289E+04	0.85463E+00	0.42643E+00	0.36444E+00	0.98483E+00
0.10290E+04	0.85399E+00	0.42632E+00	0.36407E+00	0.98383E+00
0.10291E+04	0.85326E+00	0.42621E+00	0.36367E+00	0.98273E+00
0.10292E+04	0.85242E+00	0.42610E+00	0.36321E+00	0.98150E+00
0.10293E+04	0.85148E+00	0.42599E+00	0.36272E+00	0.98017E+00
0.10294E+04	0.85051E+00	0.42588E+00	0.36221E+00	0.97880E+00
0.10295E+04	0.84959E+00	0.42577E+00	0.36173E+00	0.97748E+00
0.10296E+04	0.84874E+00	0.42566E+00	0.36127E+00	0.97625E+00
0.10297E+04	0.84793E+00	0.42555E+00	0.36083E+00	0.97507E+00
0.10298E+04	0.84713E+00	0.42543E+00	0.36040E+00	0.97390E+00
0.10299E+04	0.84633E+00	0.42532E+00	0.35996E+00	0.97272E+00
0.10300E+04	0.84551E+00	0.42521E+00	0.35952E+00	0.97152E+00
0.10301E+04	0.84467E+00	0.42509E+00	0.35906E+00	0.97027E+00
0.10302E+04	0.84382E+00	0.42497E+00	0.35859E+00	0.96902E+00
0.10303E+04	0.84291E+00	0.42484E+00	0.35810E+00	0.96769E+00
0.10304E+04	0.84193E+00	0.42472E+00	0.35759E+00	0.96629E+00
0.10305E+04	0.84092E+00	0.42460E+00	0.35706E+00	0.96486E+00
0.10306E+04	0.83990E+00	0.42448E+00	0.35652E+00	0.96342E+00
0.10307E+04	0.83889E+00	0.42436E+00	0.35599E+00	0.96198E+00
0.10308E+04	0.83789E+00	0.42424E+00	0.35546E+00	0.96056E+00
0.10309E+04	0.83689E+00	0.42412E+00	0.35494E+00	0.95914E+00
0.10310E+04	0.83586E+00	0.42399E+00	0.35440E+00	0.95768E+00
0.10311E+04	0.83473E+00	0.42387E+00	0.35382E+00	0.95612E+00
0.10312E+04	0.83347E+00	0.42375E+00	0.35318E+00	0.95440E+00
0.10313E+04	0.83214E+00	0.42363E+00	0.35252E+00	0.95260E+00
0.10314E+04	0.83076E+00	0.42351E+00	0.35183E+00	0.95075E+00
0.10315E+04	0.82934E+00	0.42339E+00	0.35113E+00	0.94886E+00
0.10316E+04	0.82793E+00	0.42327E+00	0.35043E+00	0.94697E+00
0.10317E+04	0.82652E+00	0.42315E+00	0.34974E+00	0.94509E+00
0.10318E+04	0.82510E+00	0.42302E+00	0.34904E+00	0.94319E+00
0.10319E+04	0.82364E+00	0.42290E+00	0.34832E+00	0.94126E+00
0.10320E+04	0.82217E+00	0.42277E+00	0.34759E+00	0.93929E+00
0.10321E+04	0.82071E+00	0.42263E+00	0.34686E+00	0.93731E+00
0.10322E+04	0.81933E+00	0.42249E+00	0.34616E+00	0.93541E+00
0.10323E+04	0.81795E+00	0.42234E+00	0.34545E+00	0.93351E+00
0.10324E+04	0.81652E+00	0.42220E+00	0.34473E+00	0.93157E+00
0.10325E+04	0.81506E+00	0.42205E+00	0.34400E+00	0.92959E+00

0.10326E+04	0.81352E+00	0.42191E+00	0.34323E+00	0.92751E+00
0.10327E+04	0.81187E+00	0.42177E+00	0.34242E+00	0.92532E+00
0.10328E+04	0.81016E+00	0.42162E+00	0.34158E+00	0.92305E+00
0.10329E+04	0.80841E+00	0.42148E+00	0.34073E+00	0.92075E+00
0.10330E+04	0.80663E+00	0.42134E+00	0.33986E+00	0.91840E+00
0.10331E+04	0.80475E+00	0.42119E+00	0.33896E+00	0.91595E+00
0.10332E+04	0.80279E+00	0.42105E+00	0.33801E+00	0.91340E+00
0.10333E+04	0.80073E+00	0.42090E+00	0.33703E+00	0.91075E+00
0.10334E+04	0.79857E+00	0.42076E+00	0.33601E+00	0.90799E+00
0.10335E+04	0.79633E+00	0.42062E+00	0.33495E+00	0.90513E+00
0.10336E+04	0.79402E+00	0.42047E+00	0.33386E+00	0.90219E+00
0.10337E+04	0.79160E+00	0.42033E+00	0.33273E+00	0.89914E+00
0.10338E+04	0.78904E+00	0.42018E+00	0.33154E+00	0.89592E+00
0.10339E+04	0.78639E+00	0.42004E+00	0.33032E+00	0.89260E+00
0.10340E+04	0.78371E+00	0.41990E+00	0.32908E+00	0.88927E+00
0.10341E+04	0.78095E+00	0.41975E+00	0.32781E+00	0.88583E+00
0.10342E+04	0.77810E+00	0.41961E+00	0.32649E+00	0.88228E+00
0.10343E+04	0.77510E+00	0.41946E+00	0.32512E+00	0.87857E+00
0.10344E+04	0.77196E+00	0.41931E+00	0.32369E+00	0.87470E+00
0.10345E+04	0.76868E+00	0.41916E+00	0.32220E+00	0.87067E+00
0.10346E+04	0.76524E+00	0.41901E+00	0.32064E+00	0.86646E+00
0.10347E+04	0.76165E+00	0.41886E+00	0.31902E+00	0.86209E+00
0.10348E+04	0.75790E+00	0.41871E+00	0.31734E+00	0.85754E+00
0.10349E+04	0.75397E+00	0.41856E+00	0.31558E+00	0.85279E+00
0.10350E+04	0.74985E+00	0.41841E+00	0.31374E+00	0.84782E+00
0.10351E+04	0.74557E+00	0.41826E+00	0.31184E+00	0.84268E+00
0.10352E+04	0.74117E+00	0.41811E+00	0.30989E+00	0.83741E+00
0.10353E+04	0.73668E+00	0.41796E+00	0.30790E+00	0.83204E+00
0.10354E+04	0.73215E+00	0.41781E+00	0.30590E+00	0.82663E+00
0.10355E+04	0.72752E+00	0.41766E+00	0.30386E+00	0.82110E+00
0.10356E+04	0.72274E+00	0.41751E+00	0.30175E+00	0.81542E+00
0.10357E+04	0.71777E+00	0.41736E+00	0.29957E+00	0.80952E+00
0.10358E+04	0.71260E+00	0.41721E+00	0.29730E+00	0.80340E+00
0.10359E+04	0.70726E+00	0.41705E+00	0.29496E+00	0.79707E+00
0.10360E+04	0.70177E+00	0.41688E+00	0.29256E+00	0.79057E+00
0.10361E+04	0.69616E+00	0.41671E+00	0.29009E+00	0.78391E+00
0.10362E+04	0.69046E+00	0.41653E+00	0.28760E+00	0.77716E+00
0.10363E+04	0.68464E+00	0.41635E+00	0.28505E+00	0.77028E+00
0.10364E+04	0.67866E+00	0.41617E+00	0.28244E+00	0.76322E+00
0.10365E+04	0.67252E+00	0.41599E+00	0.27976E+00	0.75599E+00
0.10366E+04	0.66621E+00	0.41581E+00	0.27702E+00	0.74859E+00
0.10367E+04	0.65975E+00	0.41564E+00	0.27422E+00	0.74101E+00
0.10368E+04	0.65317E+00	0.41546E+00	0.27137E+00	0.73330E+00

0.10369E+04	0.64646E+00	0.41528E+00	0.26846E+00	0.72545E+00
0.10370E+04	0.63961E+00	0.41510E+00	0.26550E+00	0.71746E+00
0.10371E+04	0.63262E+00	0.41492E+00	0.26249E+00	0.70932E+00
0.10372E+04	0.62547E+00	0.41474E+00	0.25941E+00	0.70099E+00
0.10373E+04	0.61817E+00	0.41456E+00	0.25627E+00	0.69252E+00
0.10374E+04	0.61072E+00	0.41439E+00	0.25307E+00	0.68387E+00
0.10375E+04	0.60312E+00	0.41421E+00	0.24982E+00	0.67507E+00
0.10376E+04	0.59539E+00	0.41403E+00	0.24651E+00	0.66613E+00
0.10377E+04	0.58751E+00	0.41385E+00	0.24314E+00	0.65704E+00
0.10378E+04	0.57949E+00	0.41367E+00	0.23972E+00	0.64778E+00
0.10379E+04	0.57137E+00	0.41349E+00	0.23625E+00	0.63842E+00
0.10380E+04	0.56319E+00	0.41330E+00	0.23277E+00	0.62900E+00
0.10381E+04	0.55498E+00	0.41310E+00	0.22926E+00	0.61953E+00
0.10382E+04	0.54674E+00	0.41289E+00	0.22575E+00	0.61003E+00
0.10383E+04	0.53843E+00	0.41269E+00	0.22220E+00	0.60046E+00
0.10384E+04	0.53003E+00	0.41249E+00	0.21863E+00	0.59080E+00
0.10385E+04	0.52153E+00	0.41229E+00	0.21502E+00	0.58104E+00
0.10386E+04	0.51293E+00	0.41208E+00	0.21137E+00	0.57118E+00
0.10387E+04	0.50429E+00	0.41188E+00	0.20771E+00	0.56128E+00
0.10388E+04	0.49561E+00	0.41168E+00	0.20403E+00	0.55135E+00
0.10389E+04	0.48689E+00	0.41148E+00	0.20034E+00	0.54139E+00
0.10390E+04	0.47816E+00	0.41127E+00	0.19666E+00	0.53142E+00
0.10391E+04	0.46943E+00	0.41107E+00	0.19297E+00	0.52146E+00
0.10392E+04	0.46072E+00	0.41087E+00	0.18929E+00	0.51153E+00
0.10393E+04	0.45202E+00	0.41067E+00	0.18563E+00	0.50162E+00
0.10394E+04	0.44337E+00	0.41046E+00	0.18199E+00	0.49178E+00
0.10395E+04	0.43476E+00	0.41026E+00	0.17836E+00	0.48199E+00
0.10396E+04	0.42617E+00	0.41006E+00	0.17476E+00	0.47224E+00
0.10397E+04	0.41758E+00	0.40986E+00	0.17115E+00	0.46249E+00
0.10398E+04	0.40899E+00	0.40965E+00	0.16754E+00	0.45274E+00
0.10399E+04	0.40044E+00	0.40944E+00	0.16396E+00	0.44305E+00
0.10400E+04	0.39196E+00	0.40922E+00	0.16040E+00	0.43344E+00
0.10401E+04	0.38351E+00	0.40899E+00	0.15685E+00	0.42386E+00
0.10402E+04	0.37516E+00	0.40875E+00	0.15335E+00	0.41438E+00
0.10403E+04	0.36690E+00	0.40851E+00	0.14988E+00	0.40502E+00
0.10404E+04	0.35872E+00	0.40827E+00	0.14646E+00	0.39576E+00
0.10405E+04	0.35061E+00	0.40804E+00	0.14306E+00	0.38659E+00
0.10406E+04	0.34260E+00	0.40780E+00	0.13971E+00	0.37754E+00
0.10407E+04	0.33467E+00	0.40756E+00	0.13640E+00	0.36859E+00
0.10408E+04	0.32681E+00	0.40732E+00	0.13312E+00	0.35972E+00
0.10409E+04	0.31901E+00	0.40709E+00	0.12987E+00	0.35094E+00
0.10410E+04	0.31133E+00	0.40685E+00	0.12666E+00	0.34228E+00
0.10411E+04	0.30377E+00	0.40661E+00	0.12352E+00	0.33378E+00

0.10412E+04	0.29637E+00	0.40637E+00	0.12044E+00	0.32545E+00
0.10413E+04	0.28912E+00	0.40614E+00	0.11742E+00	0.31731E+00
0.10414E+04	0.28204E+00	0.40590E+00	0.11448E+00	0.30936E+00
0.10415E+04	0.27508E+00	0.40566E+00	0.11159E+00	0.30155E+00
0.10416E+04	0.26822E+00	0.40543E+00	0.10874E+00	0.29386E+00
0.10417E+04	0.26148E+00	0.40521E+00	0.10595E+00	0.28632E+00
0.10418E+04	0.25487E+00	0.40498E+00	0.10322E+00	0.27892E+00
0.10419E+04	0.24840E+00	0.40476E+00	0.10054E+00	0.27169E+00
0.10420E+04	0.24206E+00	0.40453E+00	0.97919E-01	0.26460E+00
0.10421E+04	0.23585E+00	0.40428E+00	0.95350E-01	0.25766E+00
0.10422E+04	0.22981E+00	0.40403E+00	0.92849E-01	0.25090E+00
0.10423E+04	0.22385E+00	0.40378E+00	0.90387E-01	0.24425E+00
0.10424E+04	0.21799E+00	0.40353E+00	0.87966E-01	0.23771E+00
0.10425E+04	0.21224E+00	0.40328E+00	0.85593E-01	0.23130E+00
0.10426E+04	0.20658E+00	0.40304E+00	0.83260E-01	0.22499E+00
0.10427E+04	0.20105E+00	0.40279E+00	0.80979E-01	0.21883E+00
0.10428E+04	0.19565E+00	0.40254E+00	0.78758E-01	0.21283E+00
0.10429E+04	0.19038E+00	0.40229E+00	0.76587E-01	0.20696E+00
0.10430E+04	0.18522E+00	0.40204E+00	0.74466E-01	0.20123E+00
0.10431E+04	0.18015E+00	0.40179E+00	0.72383E-01	0.19560E+00
0.10432E+04	0.17516E+00	0.40155E+00	0.70335E-01	0.19007E+00
0.10433E+04	0.17025E+00	0.40130E+00	0.68323E-01	0.18463E+00
0.10434E+04	0.16540E+00	0.40105E+00	0.66334E-01	0.17925E+00
0.10435E+04	0.16064E+00	0.40080E+00	0.64383E-01	0.17398E+00
0.10436E+04	0.15602E+00	0.40055E+00	0.62493E-01	0.16887E+00
0.10437E+04	0.15154E+00	0.40028E+00	0.60658E-01	0.16391E+00
0.10438E+04	0.14722E+00	0.40002E+00	0.58892E-01	0.15914E+00
0.10439E+04	0.14307E+00	0.39976E+00	0.57192E-01	0.15455E+00
0.10440E+04	0.13907E+00	0.39949E+00	0.55557E-01	0.15013E+00
0.10441E+04	0.13517E+00	0.39920E+00	0.53962E-01	0.14582E+00
0.10442E+04	0.13135E+00	0.39891E+00	0.52399E-01	0.14160E+00
0.10443E+04	0.12761E+00	0.39863E+00	0.50867E-01	0.13746E+00
0.10444E+04	0.12396E+00	0.39834E+00	0.49379E-01	0.13343E+00
0.10445E+04	0.12040E+00	0.39805E+00	0.47927E-01	0.12951E+00
0.10446E+04	0.11693E+00	0.39776E+00	0.46509E-01	0.12568E+00
0.10447E+04	0.11353E+00	0.39748E+00	0.45125E-01	0.12194E+00
0.10448E+04	0.11021E+00	0.39719E+00	0.43775E-01	0.11829E+00
0.10449E+04	0.10698E+00	0.39690E+00	0.42461E-01	0.11474E+00
0.10450E+04	0.10383E+00	0.39661E+00	0.41181E-01	0.11128E+00
0.10451E+04	0.10075E+00	0.39633E+00	0.39932E-01	0.10791E+00
0.10452E+04	0.97790E-01	0.39604E+00	0.38729E-01	0.10466E+00
0.10453E+04	0.94929E-01	0.39575E+00	0.37568E-01	0.10152E+00
0.10454E+04	0.92168E-01	0.39547E+00	0.36449E-01	0.98496E-01

0.10455E+04	0.89468E-01	0.39518E+00	0.35356E-01	0.95542E-01
0.10456E+04	0.86842E-01	0.39489E+00	0.34293E-01	0.92670E-01
0.10457E+04	0.84283E-01	0.39460E+00	0.33259E-01	0.89874E-01
0.10458E+04	0.81773E-01	0.39432E+00	0.32244E-01	0.87133E-01
0.10459E+04	0.79317E-01	0.39403E+00	0.31253E-01	0.84455E-01
0.10460E+04	0.76893E-01	0.39374E+00	0.30276E-01	0.81813E-01
0.10461E+04	0.74535E-01	0.39343E+00	0.29324E-01	0.79243E-01
0.10462E+04	0.72295E-01	0.39313E+00	0.28421E-01	0.76802E-01
0.10463E+04	0.70125E-01	0.39282E+00	0.27547E-01	0.74439E-01
0.10464E+04	0.68014E-01	0.39252E+00	0.26697E-01	0.72143E-01
0.10465E+04	0.65979E-01	0.39222E+00	0.25878E-01	0.69930E-01
0.10466E+04	0.64025E-01	0.39191E+00	0.25092E-01	0.67806E-01
0.10467E+04	0.62121E-01	0.39161E+00	0.24327E-01	0.65739E-01
0.10468E+04	0.60240E-01	0.39131E+00	0.23572E-01	0.63698E-01
0.10469E+04	0.58421E-01	0.39100E+00	0.22843E-01	0.61728E-01
0.10470E+04	0.56703E-01	0.39070E+00	0.22154E-01	0.59866E-01
0.10471E+04	0.55075E-01	0.39040E+00	0.21501E-01	0.58102E-01
0.10472E+04	0.53567E-01	0.39009E+00	0.20896E-01	0.56468E-01
0.10473E+04	0.52144E-01	0.38979E+00	0.20325E-01	0.54924E-01
0.10474E+04	0.50755E-01	0.38949E+00	0.19769E-01	0.53421E-01
0.10475E+04	0.49377E-01	0.38919E+00	0.19217E-01	0.51931E-01
0.10476E+04	0.47971E-01	0.38890E+00	0.18656E-01	0.50414E-01
0.10477E+04	0.46570E-01	0.38860E+00	0.18097E-01	0.48903E-01
0.10478E+04	0.45245E-01	0.38831E+00	0.17569E-01	0.47476E-01
0.10479E+04	0.43981E-01	0.38801E+00	0.17065E-01	0.46114E-01
0.10480E+04	0.42758E-01	0.38771E+00	0.16578E-01	0.44797E-01
0.10481E+04	0.41593E-01	0.38740E+00	0.16113E-01	0.43542E-01
0.10482E+04	0.40480E-01	0.38710E+00	0.15670E-01	0.42344E-01
0.10483E+04	0.39406E-01	0.38679E+00	0.15242E-01	0.41188E-01
0.10484E+04	0.38389E-01	0.38649E+00	0.14837E-01	0.40094E-01
0.10485E+04	0.37391E-01	0.38618E+00	0.14439E-01	0.39019E-01
0.10486E+04	0.36423E-01	0.38588E+00	0.14055E-01	0.37979E-01
0.10487E+04	0.35477E-01	0.38557E+00	0.13679E-01	0.36964E-01
0.10488E+04	0.34503E-01	0.38526E+00	0.13293E-01	0.35921E-01
0.10489E+04	0.33502E-01	0.38496E+00	0.12897E-01	0.34851E-01
0.10490E+04	0.32475E-01	0.38465E+00	0.12491E-01	0.33755E-01
0.10491E+04	0.31426E-01	0.38435E+00	0.12079E-01	0.32640E-01
0.10492E+04	0.30377E-01	0.38404E+00	0.11666E-01	0.31525E-01
0.10493E+04	0.29320E-01	0.38374E+00	0.11251E-01	0.30403E-01
0.10494E+04	0.28243E-01	0.38343E+00	0.10829E-01	0.29264E-01
0.10495E+04	0.27202E-01	0.38313E+00	0.10422E-01	0.28163E-01
0.10496E+04	0.26209E-01	0.38282E+00	0.10033E-01	0.27113E-01
0.10497E+04	0.25246E-01	0.38251E+00	0.96570E-02	0.26096E-01

0.10498E+04	0.24348E-01	0.38220E+00	0.93059E-02	0.25147E-01
0.10499E+04	0.23475E-01	0.38190E+00	0.89650E-02	0.24226E-01
0.10500E+04	0.22606E-01	0.38159E+00	0.86264E-02	0.23311E-01
0.10501E+04	0.21743E-01	0.38127E+00	0.82900E-02	0.22402E-01
0.10502E+04	0.20888E-01	0.38095E+00	0.79576E-02	0.21504E-01
0.10503E+04	0.20054E-01	0.38064E+00	0.76332E-02	0.20627E-01
0.10504E+04	0.19257E-01	0.38032E+00	0.73240E-02	0.19791E-01
0.10505E+04	0.18492E-01	0.38000E+00	0.70269E-02	0.18989E-01
0.10506E+04	0.17797E-01	0.37969E+00	0.67573E-02	0.18260E-01
0.10507E+04	0.17161E-01	0.37937E+00	0.65103E-02	0.17593E-01
0.10508E+04	0.16573E-01	0.37906E+00	0.62822E-02	0.16976E-01
0.10509E+04	0.16027E-01	0.37874E+00	0.60701E-02	0.16403E-01
0.10510E+04	0.15523E-01	0.37842E+00	0.58743E-02	0.15874E-01
0.10511E+04	0.15084E-01	0.37811E+00	0.57034E-02	0.15412E-01
0.10512E+04	0.14710E-01	0.37779E+00	0.55575E-02	0.15018E-01
0.10513E+04	0.14377E-01	0.37748E+00	0.54270E-02	0.14665E-01
0.10514E+04	0.14079E-01	0.37717E+00	0.53101E-02	0.14349E-01
0.10515E+04	0.13789E-01	0.37685E+00	0.51964E-02	0.14042E-01
0.10516E+04	0.13512E-01	0.37654E+00	0.50876E-02	0.13748E-01
0.10517E+04	0.13238E-01	0.37623E+00	0.49807E-02	0.13459E-01
0.10518E+04	0.12979E-01	0.37592E+00	0.48790E-02	0.13184E-01
0.10519E+04	0.12727E-01	0.37560E+00	0.47802E-02	0.12917E-01
0.10520E+04	0.12475E-01	0.37530E+00	0.46817E-02	0.12651E-01
0.10521E+04	0.12227E-01	0.37499E+00	0.45851E-02	0.12390E-01
0.10522E+04	0.11981E-01	0.37469E+00	0.44891E-02	0.12131E-01
0.10523E+04	0.11736E-01	0.37439E+00	0.43939E-02	0.11873E-01
0.10524E+04	0.11492E-01	0.37409E+00	0.42989E-02	0.11617E-01
0.10525E+04	0.11251E-01	0.37379E+00	0.42054E-02	0.11364E-01
0.10526E+04	0.11019E-01	0.37349E+00	0.41155E-02	0.11121E-01
0.10527E+04	0.10790E-01	0.37319E+00	0.40265E-02	0.10881E-01
0.10528E+04	0.10561E-01	0.37289E+00	0.39379E-02	0.10641E-01
0.10529E+04	0.10332E-01	0.37258E+00	0.38495E-02	0.10403E-01
0.10530E+04	0.10106E-01	0.37228E+00	0.37623E-02	0.10167E-01
0.10531E+04	0.98830E-02	0.37198E+00	0.36763E-02	0.99344E-02
0.10532E+04	0.96644E-02	0.37168E+00	0.35921E-02	0.97067E-02
0.10533E+04	0.94478E-02	0.37138E+00	0.35087E-02	0.94815E-02
0.10534E+04	0.92320E-02	0.37108E+00	0.34258E-02	0.92575E-02
0.10535E+04	0.90170E-02	0.37078E+00	0.33433E-02	0.90346E-02
0.10536E+04	0.88062E-02	0.37048E+00	0.32625E-02	0.88163E-02
0.10537E+04	0.85990E-02	0.37018E+00	0.31832E-02	0.86018E-02
0.10538E+04	0.83924E-02	0.36988E+00	0.31042E-02	0.83884E-02
0.10539E+04	0.81860E-02	0.36958E+00	0.30254E-02	0.81755E-02
0.10540E+04	0.79846E-02	0.36929E+00	0.29486E-02	0.79679E-02

0.10541E+04	0.77874E-02	0.36901E+00	0.28736E-02	0.77653E-02
0.10542E+04	0.75929E-02	0.36873E+00	0.27997E-02	0.75656E-02
0.10543E+04	0.74003E-02	0.36845E+00	0.27266E-02	0.73681E-02
0.10544E+04	0.72132E-02	0.36817E+00	0.26557E-02	0.71764E-02
0.10545E+04	0.70267E-02	0.36789E+00	0.25851E-02	0.69856E-02
0.10546E+04	0.68448E-02	0.36761E+00	0.25163E-02	0.67996E-02
0.10547E+04	0.66647E-02	0.36734E+00	0.24482E-02	0.66157E-02
0.10548E+04	0.64862E-02	0.36706E+00	0.23808E-02	0.64336E-02
0.10549E+04	0.63173E-02	0.36678E+00	0.23170E-02	0.62613E-02
0.10550E+04	0.61484E-02	0.36650E+00	0.22534E-02	0.60893E-02
0.10551E+04	0.59814E-02	0.36622E+00	0.21905E-02	0.59194E-02
0.10552E+04	0.58167E-02	0.36595E+00	0.21286E-02	0.57522E-02
0.10553E+04	0.56527E-02	0.36568E+00	0.20671E-02	0.55858E-02
0.10554E+04	0.55032E-02	0.36541E+00	0.20109E-02	0.54340E-02
0.10555E+04	0.53538E-02	0.36514E+00	0.19548E-02	0.52825E-02
0.10556E+04	0.52115E-02	0.36486E+00	0.19015E-02	0.51383E-02
0.10557E+04	0.50695E-02	0.36459E+00	0.18483E-02	0.49946E-02
0.10558E+04	0.49294E-02	0.36432E+00	0.17959E-02	0.48530E-02
0.10559E+04	0.47893E-02	0.36405E+00	0.17435E-02	0.47115E-02
0.10560E+04	0.46529E-02	0.36379E+00	0.16927E-02	0.45740E-02
0.10561E+04	0.45172E-02	0.36354E+00	0.16422E-02	0.44377E-02
0.10562E+04	0.43833E-02	0.36329E+00	0.15924E-02	0.43032E-02
0.10563E+04	0.42498E-02	0.36305E+00	0.15429E-02	0.41693E-02
0.10564E+04	0.41171E-02	0.36280E+00	0.14937E-02	0.40364E-02
0.10565E+04	0.39848E-02	0.36256E+00	0.14447E-02	0.39040E-02
0.10566E+04	0.38574E-02	0.36231E+00	0.13976E-02	0.37767E-02
0.10567E+04	0.37313E-02	0.36207E+00	0.13510E-02	0.36508E-02
0.10568E+04	0.36058E-02	0.36182E+00	0.13047E-02	0.35256E-02
0.10569E+04	0.34832E-02	0.36158E+00	0.12594E-02	0.34033E-02
0.10570E+04	0.33624E-02	0.36133E+00	0.12149E-02	0.32831E-02
0.10571E+04	0.32417E-02	0.36108E+00	0.11705E-02	0.31631E-02
0.10572E+04	0.31235E-02	0.36083E+00	0.11270E-02	0.30455E-02
0.10573E+04	0.30055E-02	0.36057E+00	0.10837E-02	0.29284E-02
0.10574E+04	0.28880E-02	0.36032E+00	0.10406E-02	0.28120E-02
0.10575E+04	0.27740E-02	0.36006E+00	0.99881E-03	0.26991E-02
0.10576E+04	0.26661E-02	0.35981E+00	0.95927E-03	0.25922E-02
0.10577E+04	0.25583E-02	0.35955E+00	0.91985E-03	0.24857E-02
0.10578E+04	0.24513E-02	0.35930E+00	0.88076E-03	0.23801E-02
0.10579E+04	0.23460E-02	0.35904E+00	0.84232E-03	0.22762E-02
0.10580E+04	0.22416E-02	0.35879E+00	0.80425E-03	0.21733E-02
0.10581E+04	0.21382E-02	0.35857E+00	0.76670E-03	0.20718E-02
0.10582E+04	0.20358E-02	0.35834E+00	0.72951E-03	0.19713E-02
0.10583E+04	0.19352E-02	0.35811E+00	0.69303E-03	0.18728E-02

0.10584E+04	0.18390E-02	0.35788E+00	0.65814E-03	0.17785E-02
0.10585E+04	0.17442E-02	0.35765E+00	0.62381E-03	0.16857E-02
0.10586E+04	0.16512E-02	0.35743E+00	0.59017E-03	0.15948E-02
0.10587E+04	0.15613E-02	0.35720E+00	0.55771E-03	0.15071E-02
0.10588E+04	0.14734E-02	0.35697E+00	0.52596E-03	0.14213E-02
0.10589E+04	0.13856E-02	0.35674E+00	0.49430E-03	0.13357E-02
0.10590E+04	0.13049E-02	0.35652E+00	0.46521E-03	0.12571E-02
0.10591E+04	0.12250E-02	0.35629E+00	0.43647E-03	0.11795E-02
0.10592E+04	0.11460E-02	0.35606E+00	0.40805E-03	0.11027E-02
0.10593E+04	0.10722E-02	0.35583E+00	0.38153E-03	0.10310E-02
0.10594E+04	0.99953E-03	0.35561E+00	0.35544E-03	0.96049E-03
0.10595E+04	0.92845E-03	0.35538E+00	0.32995E-03	0.89163E-03
0.10596E+04	0.85765E-03	0.35515E+00	0.30460E-03	0.82310E-03
0.10597E+04	0.78769E-03	0.35493E+00	0.27957E-03	0.75549E-03
0.10598E+04	0.72212E-03	0.35470E+00	0.25614E-03	0.69215E-03
0.10599E+04	0.66123E-03	0.35447E+00	0.23439E-03	0.63338E-03
0.10600E+04	0.60137E-03	0.35426E+00	0.21304E-03	0.57569E-03
0.10601E+04	0.54213E-03	0.35406E+00	0.19195E-03	0.51869E-03
0.10602E+04	0.48418E-03	0.35386E+00	0.17133E-03	0.46299E-03
0.10603E+04	0.43295E-03	0.35367E+00	0.15312E-03	0.41377E-03
0.10604E+04	0.38433E-03	0.35347E+00	0.13585E-03	0.36711E-03
0.10605E+04	0.33607E-03	0.35327E+00	0.11872E-03	0.32082E-03
0.10606E+04	0.28994E-03	0.35308E+00	0.10237E-03	0.27663E-03
0.10607E+04	0.24852E-03	0.35288E+00	0.87699E-04	0.23699E-03
0.10608E+04	0.20723E-03	0.35269E+00	0.73087E-04	0.19750E-03
0.10609E+04	0.16753E-03	0.35249E+00	0.59052E-04	0.15957E-03
0.10610E+04	0.12794E-03	0.35231E+00	0.45076E-04	0.12181E-03
0.10611E+04	0.89282E-04	0.35213E+00	0.31439E-04	0.84956E-04
0.10612E+04	0.52197E-04	0.35195E+00	0.18371E-04	0.49642E-04
0.10613E+04	0.15387E-04	0.35176E+00	0.54127E-05	0.14627E-04
0.10614E+04	0.00000E+00	0.35158E+00	0.00000E+00	0.00000E+00
Channel 10				
Wavenumber	HIRS Filter Transmittance	Optical Element Transmittance	Product of the HIRS Filter and Optical Element Transmittances	Normalized Value of Column 4
0.78492E+03	0.00000E+00	0.41577E+00	0.00000E+00	0.00000E+00
0.78502E+03	0.41781E-04	0.41588E+00	0.17376E-04	0.47009E-04
0.78512E+03	0.37083E-03	0.41598E+00	0.15426E-03	0.41734E-03
0.78522E+03	0.70624E-03	0.41608E+00	0.29385E-03	0.79499E-03
0.78532E+03	0.10447E-02	0.41617E+00	0.43480E-03	0.11763E-02
0.78542E+03	0.13949E-02	0.41627E+00	0.58065E-03	0.15709E-02
0.78552E+03	0.17484E-02	0.41636E+00	0.72796E-03	0.19695E-02

0.78562E+03	0.21191E-02	0.41646E+00	0.88252E-03	0.23876E-02
0.78572E+03	0.24919E-02	0.41655E+00	0.10380E-02	0.28083E-02
0.78582E+03	0.28671E-02	0.41665E+00	0.11946E-02	0.32319E-02
0.78592E+03	0.32445E-02	0.41674E+00	0.13521E-02	0.36581E-02
0.78602E+03	0.36256E-02	0.41684E+00	0.15113E-02	0.40887E-02
0.78612E+03	0.40249E-02	0.41696E+00	0.16782E-02	0.45403E-02
0.78622E+03	0.44309E-02	0.41708E+00	0.18480E-02	0.49997E-02
0.78632E+03	0.48444E-02	0.41720E+00	0.20211E-02	0.54679E-02
0.78642E+03	0.52591E-02	0.41731E+00	0.21947E-02	0.59376E-02
0.78652E+03	0.56766E-02	0.41743E+00	0.23696E-02	0.64108E-02
0.78662E+03	0.61030E-02	0.41755E+00	0.25483E-02	0.68943E-02
0.78672E+03	0.65341E-02	0.41767E+00	0.27291E-02	0.73834E-02
0.78682E+03	0.69819E-02	0.41779E+00	0.29169E-02	0.78916E-02
0.78692E+03	0.74361E-02	0.41791E+00	0.31076E-02	0.84074E-02
0.78702E+03	0.78917E-02	0.41802E+00	0.32989E-02	0.89250E-02
0.78712E+03	0.83648E-02	0.41812E+00	0.34975E-02	0.94623E-02
0.78722E+03	0.88933E-02	0.41822E+00	0.37194E-02	0.10063E-01
0.78732E+03	0.94420E-02	0.41832E+00	0.39498E-02	0.10686E-01
0.78742E+03	0.10014E-01	0.41842E+00	0.41902E-02	0.11336E-01
0.78752E+03	0.10615E-01	0.41852E+00	0.44428E-02	0.12020E-01
0.78762E+03	0.11228E-01	0.41862E+00	0.47001E-02	0.12716E-01
0.78772E+03	0.11882E-01	0.41872E+00	0.49754E-02	0.13460E-01
0.78782E+03	0.12556E-01	0.41882E+00	0.52586E-02	0.14227E-01
0.78792E+03	0.13244E-01	0.41892E+00	0.55481E-02	0.15010E-01
0.78802E+03	0.13953E-01	0.41903E+00	0.58465E-02	0.15817E-01
0.78812E+03	0.14669E-01	0.41915E+00	0.61485E-02	0.16634E-01
0.78822E+03	0.15397E-01	0.41928E+00	0.64557E-02	0.17466E-01
0.78832E+03	0.16132E-01	0.41940E+00	0.67659E-02	0.18305E-01
0.78842E+03	0.16887E-01	0.41953E+00	0.70846E-02	0.19167E-01
0.78852E+03	0.17667E-01	0.41965E+00	0.74139E-02	0.20058E-01
0.78862E+03	0.18467E-01	0.41978E+00	0.77523E-02	0.20973E-01
0.78872E+03	0.19298E-01	0.41991E+00	0.81035E-02	0.21924E-01
0.78882E+03	0.20132E-01	0.42003E+00	0.84561E-02	0.22877E-01
0.78892E+03	0.21130E-01	0.42016E+00	0.88779E-02	0.24019E-01
0.78902E+03	0.22353E-01	0.42026E+00	0.93938E-02	0.25414E-01
0.78912E+03	0.23790E-01	0.42035E+00	0.10000E-01	0.27055E-01
0.78922E+03	0.25232E-01	0.42045E+00	0.10609E-01	0.28701E-01
0.78932E+03	0.26701E-01	0.42054E+00	0.11229E-01	0.30379E-01
0.78942E+03	0.28242E-01	0.42064E+00	0.11880E-01	0.32139E-01
0.78952E+03	0.29826E-01	0.42073E+00	0.12549E-01	0.33949E-01
0.78962E+03	0.31514E-01	0.42083E+00	0.13262E-01	0.35879E-01
0.78972E+03	0.33241E-01	0.42092E+00	0.13992E-01	0.37854E-01
0.78982E+03	0.35039E-01	0.42102E+00	0.14752E-01	0.39911E-01

0.78992E+03	0.36860E-01	0.42111E+00	0.15522E-01	0.41995E-01
0.79002E+03	0.38760E-01	0.42121E+00	0.16326E-01	0.44169E-01
0.79012E+03	0.40785E-01	0.42134E+00	0.17184E-01	0.46491E-01
0.79022E+03	0.42864E-01	0.42146E+00	0.18066E-01	0.48875E-01
0.79032E+03	0.45032E-01	0.42159E+00	0.18985E-01	0.51363E-01
0.79042E+03	0.47309E-01	0.42171E+00	0.19951E-01	0.53976E-01
0.79052E+03	0.49715E-01	0.42183E+00	0.20972E-01	0.56737E-01
0.79062E+03	0.52346E-01	0.42196E+00	0.22088E-01	0.59758E-01
0.79072E+03	0.55066E-01	0.42208E+00	0.23242E-01	0.62881E-01
0.79082E+03	0.57818E-01	0.42221E+00	0.24411E-01	0.66043E-01
0.79092E+03	0.60671E-01	0.42233E+00	0.25623E-01	0.69322E-01
0.79102E+03	0.63638E-01	0.42245E+00	0.26884E-01	0.72733E-01
0.79112E+03	0.66803E-01	0.42257E+00	0.28229E-01	0.76372E-01
0.79122E+03	0.70286E-01	0.42269E+00	0.29710E-01	0.80377E-01
0.79132E+03	0.74041E-01	0.42282E+00	0.31306E-01	0.84695E-01
0.79142E+03	0.78125E-01	0.42294E+00	0.33042E-01	0.89393E-01
0.79152E+03	0.82540E-01	0.42306E+00	0.34919E-01	0.94472E-01
0.79162E+03	0.87276E-01	0.42318E+00	0.36934E-01	0.99922E-01
0.79172E+03	0.92244E-01	0.42330E+00	0.39047E-01	0.10564E+00
0.79182E+03	0.97456E-01	0.42342E+00	0.41265E-01	0.11164E+00
0.79192E+03	0.10285E+00	0.42354E+00	0.43562E-01	0.11785E+00
0.79202E+03	0.10842E+00	0.42367E+00	0.45936E-01	0.12428E+00
0.79212E+03	0.11426E+00	0.42382E+00	0.48425E-01	0.13101E+00
0.79222E+03	0.12046E+00	0.42396E+00	0.51072E-01	0.13817E+00
0.79232E+03	0.12706E+00	0.42411E+00	0.53886E-01	0.14578E+00
0.79242E+03	0.13413E+00	0.42425E+00	0.56906E-01	0.15395E+00
0.79252E+03	0.14168E+00	0.42440E+00	0.60131E-01	0.16268E+00
0.79262E+03	0.14975E+00	0.42454E+00	0.63575E-01	0.17200E+00
0.79272E+03	0.15825E+00	0.42469E+00	0.67208E-01	0.18183E+00
0.79282E+03	0.16717E+00	0.42484E+00	0.71020E-01	0.19214E+00
0.79292E+03	0.17651E+00	0.42500E+00	0.75019E-01	0.20296E+00
0.79302E+03	0.18635E+00	0.42516E+00	0.79229E-01	0.21435E+00
0.79312E+03	0.19667E+00	0.42533E+00	0.83649E-01	0.22631E+00
0.79322E+03	0.20748E+00	0.42549E+00	0.88279E-01	0.23883E+00
0.79332E+03	0.21883E+00	0.42565E+00	0.93147E-01	0.25200E+00
0.79342E+03	0.23075E+00	0.42581E+00	0.98254E-01	0.26582E+00
0.79352E+03	0.24314E+00	0.42597E+00	0.10357E+00	0.28021E+00
0.79362E+03	0.25608E+00	0.42614E+00	0.10912E+00	0.29523E+00
0.79372E+03	0.26957E+00	0.42630E+00	0.11492E+00	0.31091E+00
0.79382E+03	0.28365E+00	0.42646E+00	0.12096E+00	0.32726E+00
0.79392E+03	0.29835E+00	0.42662E+00	0.12728E+00	0.34435E+00
0.79402E+03	0.31371E+00	0.42678E+00	0.13388E+00	0.36222E+00
0.79412E+03	0.32948E+00	0.42696E+00	0.14068E+00	0.38059E+00

0.79422E+03	0.34552E+00	0.42714E+00	0.14759E+00	0.39928E+00
0.79432E+03	0.36174E+00	0.42732E+00	0.15458E+00	0.41820E+00
0.79442E+03	0.37802E+00	0.42750E+00	0.16160E+00	0.43721E+00
0.79452E+03	0.39451E+00	0.42768E+00	0.16872E+00	0.45647E+00
0.79462E+03	0.41127E+00	0.42786E+00	0.17597E+00	0.47607E+00
0.79472E+03	0.42833E+00	0.42804E+00	0.18334E+00	0.49602E+00
0.79482E+03	0.44573E+00	0.42823E+00	0.19088E+00	0.51641E+00
0.79492E+03	0.46333E+00	0.42842E+00	0.19850E+00	0.53703E+00
0.79502E+03	0.48100E+00	0.42861E+00	0.20616E+00	0.55775E+00
0.79512E+03	0.49871E+00	0.42879E+00	0.21384E+00	0.57854E+00
0.79522E+03	0.51644E+00	0.42898E+00	0.22154E+00	0.59936E+00
0.79532E+03	0.53406E+00	0.42916E+00	0.22920E+00	0.62009E+00
0.79542E+03	0.55150E+00	0.42935E+00	0.23679E+00	0.64061E+00
0.79552E+03	0.56871E+00	0.42953E+00	0.24428E+00	0.66088E+00
0.79562E+03	0.58560E+00	0.42972E+00	0.25165E+00	0.68081E+00
0.79572E+03	0.60210E+00	0.42991E+00	0.25885E+00	0.70029E+00
0.79582E+03	0.61806E+00	0.43009E+00	0.26582E+00	0.71917E+00
0.79592E+03	0.63352E+00	0.43028E+00	0.27259E+00	0.73747E+00
0.79602E+03	0.64853E+00	0.43047E+00	0.27917E+00	0.75527E+00
0.79612E+03	0.66301E+00	0.43066E+00	0.28553E+00	0.77249E+00
0.79622E+03	0.67690E+00	0.43086E+00	0.29165E+00	0.78904E+00
0.79632E+03	0.69024E+00	0.43106E+00	0.29753E+00	0.80495E+00
0.79642E+03	0.70302E+00	0.43125E+00	0.30318E+00	0.82023E+00
0.79652E+03	0.71509E+00	0.43145E+00	0.30853E+00	0.83470E+00
0.79662E+03	0.72639E+00	0.43165E+00	0.31354E+00	0.84827E+00
0.79672E+03	0.73681E+00	0.43185E+00	0.31819E+00	0.86085E+00
0.79682E+03	0.74631E+00	0.43206E+00	0.32245E+00	0.87237E+00
0.79692E+03	0.75495E+00	0.43227E+00	0.32634E+00	0.88289E+00
0.79702E+03	0.76269E+00	0.43247E+00	0.32984E+00	0.89236E+00
0.79712E+03	0.76966E+00	0.43268E+00	0.33301E+00	0.90095E+00
0.79722E+03	0.77601E+00	0.43288E+00	0.33592E+00	0.90881E+00
0.79732E+03	0.78184E+00	0.43309E+00	0.33860E+00	0.91607E+00
0.79742E+03	0.78727E+00	0.43329E+00	0.34112E+00	0.92287E+00
0.79752E+03	0.79218E+00	0.43349E+00	0.34341E+00	0.92906E+00
0.79762E+03	0.79648E+00	0.43370E+00	0.34543E+00	0.93455E+00
0.79772E+03	0.80024E+00	0.43390E+00	0.34723E+00	0.93940E+00
0.79782E+03	0.80349E+00	0.43411E+00	0.34880E+00	0.94366E+00
0.79792E+03	0.80634E+00	0.43431E+00	0.35021E+00	0.94746E+00
0.79802E+03	0.80879E+00	0.43452E+00	0.35143E+00	0.95078E+00
0.79812E+03	0.81097E+00	0.43472E+00	0.35255E+00	0.95379E+00
0.79822E+03	0.81295E+00	0.43492E+00	0.35357E+00	0.95657E+00
0.79832E+03	0.81477E+00	0.43513E+00	0.35453E+00	0.95916E+00
0.79842E+03	0.81651E+00	0.43533E+00	0.35545E+00	0.96165E+00

0.79852E+03	0.81821E+00	0.43553E+00	0.35636E+00	0.96411E+00
0.79862E+03	0.81983E+00	0.43574E+00	0.35723E+00	0.96647E+00
0.79872E+03	0.82135E+00	0.43595E+00	0.35807E+00	0.96874E+00
0.79882E+03	0.82279E+00	0.43617E+00	0.35887E+00	0.97091E+00
0.79892E+03	0.82404E+00	0.43638E+00	0.35959E+00	0.97285E+00
0.79902E+03	0.82497E+00	0.43659E+00	0.36017E+00	0.97443E+00
0.79912E+03	0.82552E+00	0.43680E+00	0.36059E+00	0.97555E+00
0.79922E+03	0.82557E+00	0.43701E+00	0.36079E+00	0.97608E+00
0.79932E+03	0.82544E+00	0.43723E+00	0.36090E+00	0.97640E+00
0.79942E+03	0.82528E+00	0.43744E+00	0.36101E+00	0.97668E+00
0.79952E+03	0.82516E+00	0.43765E+00	0.36113E+00	0.97701E+00
0.79962E+03	0.82521E+00	0.43786E+00	0.36133E+00	0.97755E+00
0.79972E+03	0.82541E+00	0.43808E+00	0.36159E+00	0.97827E+00
0.79982E+03	0.82573E+00	0.43829E+00	0.36191E+00	0.97911E+00
0.79992E+03	0.82613E+00	0.43850E+00	0.36226E+00	0.98007E+00
0.80002E+03	0.82658E+00	0.43871E+00	0.36263E+00	0.98107E+00
0.80012E+03	0.82706E+00	0.43891E+00	0.36301E+00	0.98209E+00
0.80022E+03	0.82750E+00	0.43912E+00	0.36337E+00	0.98307E+00
0.80032E+03	0.82789E+00	0.43932E+00	0.36370E+00	0.98398E+00
0.80042E+03	0.82816E+00	0.43952E+00	0.36399E+00	0.98476E+00
0.80052E+03	0.82854E+00	0.43972E+00	0.36433E+00	0.98566E+00
0.80062E+03	0.82914E+00	0.43993E+00	0.36476E+00	0.98683E+00
0.80072E+03	0.82988E+00	0.44013E+00	0.36525E+00	0.98817E+00
0.80082E+03	0.83071E+00	0.44033E+00	0.36579E+00	0.98962E+00
0.80092E+03	0.83144E+00	0.44054E+00	0.36628E+00	0.99096E+00
0.80102E+03	0.83195E+00	0.44074E+00	0.36668E+00	0.99202E+00
0.80112E+03	0.83231E+00	0.44095E+00	0.36700E+00	0.99291E+00
0.80122E+03	0.83254E+00	0.44115E+00	0.36728E+00	0.99364E+00
0.80132E+03	0.83257E+00	0.44136E+00	0.36746E+00	0.99415E+00
0.80142E+03	0.83240E+00	0.44156E+00	0.36756E+00	0.99440E+00
0.80152E+03	0.83207E+00	0.44177E+00	0.36758E+00	0.99446E+00
0.80162E+03	0.83155E+00	0.44197E+00	0.36752E+00	0.99431E+00
0.80172E+03	0.83105E+00	0.44218E+00	0.36747E+00	0.99418E+00
0.80182E+03	0.83077E+00	0.44239E+00	0.36752E+00	0.99431E+00
0.80192E+03	0.83056E+00	0.44259E+00	0.36760E+00	0.99451E+00
0.80202E+03	0.83036E+00	0.44280E+00	0.36768E+00	0.99474E+00
0.80212E+03	0.83017E+00	0.44300E+00	0.36776E+00	0.99496E+00
0.80222E+03	0.82990E+00	0.44320E+00	0.36781E+00	0.99509E+00
0.80232E+03	0.82956E+00	0.44340E+00	0.36783E+00	0.99514E+00
0.80242E+03	0.82919E+00	0.44360E+00	0.36783E+00	0.99514E+00
0.80252E+03	0.82872E+00	0.44379E+00	0.36778E+00	0.99500E+00
0.80262E+03	0.82813E+00	0.44398E+00	0.36767E+00	0.99471E+00
0.80272E+03	0.82756E+00	0.44416E+00	0.36757E+00	0.99444E+00

0.80282E+03	0.82702E+00	0.44435E+00	0.36749E+00	0.99421E+00
0.80292E+03	0.82665E+00	0.44454E+00	0.36748E+00	0.99418E+00
0.80302E+03	0.82654E+00	0.44472E+00	0.36758E+00	0.99447E+00
0.80312E+03	0.82652E+00	0.44491E+00	0.36773E+00	0.99486E+00
0.80322E+03	0.82651E+00	0.44509E+00	0.36787E+00	0.99526E+00
0.80332E+03	0.82649E+00	0.44528E+00	0.36802E+00	0.99565E+00
0.80342E+03	0.82646E+00	0.44547E+00	0.36816E+00	0.99603E+00
0.80352E+03	0.82638E+00	0.44565E+00	0.36828E+00	0.99635E+00
0.80362E+03	0.82623E+00	0.44584E+00	0.36837E+00	0.99659E+00
0.80372E+03	0.82600E+00	0.44603E+00	0.36842E+00	0.99673E+00
0.80382E+03	0.82564E+00	0.44621E+00	0.36841E+00	0.99671E+00
0.80392E+03	0.82529E+00	0.44640E+00	0.36841E+00	0.99670E+00
0.80402E+03	0.82500E+00	0.44659E+00	0.36843E+00	0.99677E+00
0.80412E+03	0.82471E+00	0.44676E+00	0.36845E+00	0.99681E+00
0.80422E+03	0.82440E+00	0.44693E+00	0.36845E+00	0.99682E+00
0.80432E+03	0.82401E+00	0.44711E+00	0.36842E+00	0.99674E+00
0.80442E+03	0.82348E+00	0.44728E+00	0.36833E+00	0.99648E+00
0.80452E+03	0.82292E+00	0.44745E+00	0.36821E+00	0.99617E+00
0.80462E+03	0.82231E+00	0.44762E+00	0.36808E+00	0.99581E+00
0.80472E+03	0.82172E+00	0.44779E+00	0.36796E+00	0.99548E+00
0.80482E+03	0.82123E+00	0.44796E+00	0.36788E+00	0.99526E+00
0.80492E+03	0.82081E+00	0.44813E+00	0.36783E+00	0.99513E+00
0.80502E+03	0.82049E+00	0.44830E+00	0.36783E+00	0.99513E+00
0.80512E+03	0.82041E+00	0.44847E+00	0.36793E+00	0.99541E+00
0.80522E+03	0.82056E+00	0.44864E+00	0.36814E+00	0.99597E+00
0.80532E+03	0.82081E+00	0.44881E+00	0.36839E+00	0.99665E+00
0.80542E+03	0.82110E+00	0.44899E+00	0.36866E+00	0.99739E+00
0.80552E+03	0.82135E+00	0.44916E+00	0.36892E+00	0.99808E+00
0.80562E+03	0.82149E+00	0.44933E+00	0.36912E+00	0.99863E+00
0.80572E+03	0.82162E+00	0.44950E+00	0.36932E+00	0.99917E+00
0.80582E+03	0.82174E+00	0.44967E+00	0.36951E+00	0.99969E+00
0.80592E+03	0.82167E+00	0.44985E+00	0.36963E+00	0.10000E+01
0.80602E+03	0.82127E+00	0.45002E+00	0.36959E+00	0.99989E+00
0.80612E+03	0.82049E+00	0.45018E+00	0.36936E+00	0.99929E+00
0.80622E+03	0.81925E+00	0.45033E+00	0.36894E+00	0.99814E+00
0.80632E+03	0.81769E+00	0.45050E+00	0.36837E+00	0.99659E+00
0.80642E+03	0.81589E+00	0.45067E+00	0.36770E+00	0.99478E+00
0.80652E+03	0.81368E+00	0.45085E+00	0.36684E+00	0.99247E+00
0.80662E+03	0.81096E+00	0.45102E+00	0.36576E+00	0.98954E+00
0.80672E+03	0.80775E+00	0.45120E+00	0.36446E+00	0.98601E+00
0.80682E+03	0.80403E+00	0.45138E+00	0.36292E+00	0.98185E+00
0.80692E+03	0.79975E+00	0.45155E+00	0.36113E+00	0.97701E+00
0.80702E+03	0.79489E+00	0.45173E+00	0.35907E+00	0.97145E+00

0.80712E+03	0.78936E+00	0.45190E+00	0.35671E+00	0.96507E+00
0.80722E+03	0.78315E+00	0.45208E+00	0.35405E+00	0.95785E+00
0.80732E+03	0.77624E+00	0.45226E+00	0.35106E+00	0.94977E+00
0.80742E+03	0.76856E+00	0.45243E+00	0.34772E+00	0.94074E+00
0.80752E+03	0.76016E+00	0.45261E+00	0.34406E+00	0.93083E+00
0.80762E+03	0.75111E+00	0.45279E+00	0.34009E+00	0.92010E+00
0.80772E+03	0.74134E+00	0.45296E+00	0.33580E+00	0.90849E+00
0.80782E+03	0.73085E+00	0.45314E+00	0.33118E+00	0.89598E+00
0.80792E+03	0.71959E+00	0.45332E+00	0.32620E+00	0.88252E+00
0.80802E+03	0.70760E+00	0.45349E+00	0.32089E+00	0.86815E+00
0.80812E+03	0.69487E+00	0.45366E+00	0.31523E+00	0.85284E+00
0.80822E+03	0.68139E+00	0.45382E+00	0.30923E+00	0.83661E+00
0.80832E+03	0.66719E+00	0.45400E+00	0.30290E+00	0.81948E+00
0.80842E+03	0.65232E+00	0.45417E+00	0.29626E+00	0.80152E+00
0.80852E+03	0.63678E+00	0.45434E+00	0.28931E+00	0.78272E+00
0.80862E+03	0.62062E+00	0.45451E+00	0.28208E+00	0.76315E+00
0.80872E+03	0.60399E+00	0.45468E+00	0.27462E+00	0.74298E+00
0.80882E+03	0.58705E+00	0.45485E+00	0.26702E+00	0.72241E+00
0.80892E+03	0.56981E+00	0.45502E+00	0.25928E+00	0.70145E+00
0.80902E+03	0.55234E+00	0.45520E+00	0.25142E+00	0.68020E+00
0.80912E+03	0.53466E+00	0.45537E+00	0.24347E+00	0.65869E+00
0.80922E+03	0.51681E+00	0.45554E+00	0.23543E+00	0.63693E+00
0.80932E+03	0.49876E+00	0.45571E+00	0.22729E+00	0.61493E+00
0.80942E+03	0.48061E+00	0.45589E+00	0.21911E+00	0.59278E+00
0.80952E+03	0.46244E+00	0.45606E+00	0.21090E+00	0.57058E+00
0.80962E+03	0.44435E+00	0.45624E+00	0.20273E+00	0.54847E+00
0.80972E+03	0.42643E+00	0.45641E+00	0.19463E+00	0.52655E+00
0.80982E+03	0.40875E+00	0.45659E+00	0.18663E+00	0.50491E+00
0.80992E+03	0.39124E+00	0.45676E+00	0.17871E+00	0.48348E+00
0.81002E+03	0.37398E+00	0.45694E+00	0.17088E+00	0.46232E+00
0.81012E+03	0.35698E+00	0.45711E+00	0.16318E+00	0.44147E+00
0.81022E+03	0.34030E+00	0.45729E+00	0.15562E+00	0.42101E+00
0.81032E+03	0.32396E+00	0.45747E+00	0.14820E+00	0.40095E+00
0.81042E+03	0.30801E+00	0.45764E+00	0.14096E+00	0.38136E+00
0.81052E+03	0.29250E+00	0.45782E+00	0.13391E+00	0.36229E+00
0.81062E+03	0.27751E+00	0.45800E+00	0.12710E+00	0.34386E+00
0.81072E+03	0.26298E+00	0.45817E+00	0.12049E+00	0.32598E+00
0.81082E+03	0.24899E+00	0.45835E+00	0.11413E+00	0.30876E+00
0.81092E+03	0.23557E+00	0.45853E+00	0.10802E+00	0.29223E+00
0.81102E+03	0.22277E+00	0.45871E+00	0.10219E+00	0.27646E+00
0.81112E+03	0.21052E+00	0.45889E+00	0.96605E-01	0.26136E+00
0.81122E+03	0.19885E+00	0.45907E+00	0.91284E-01	0.24696E+00
0.81132E+03	0.18773E+00	0.45925E+00	0.86215E-01	0.23325E+00

0.81142E+03	0.17719E+00	0.45942E+00	0.81408E-01	0.22024E+00
0.81152E+03	0.16716E+00	0.45960E+00	0.76827E-01	0.20785E+00
0.81162E+03	0.15763E+00	0.45978E+00	0.72477E-01	0.19608E+00
0.81172E+03	0.14863E+00	0.45996E+00	0.68364E-01	0.18496E+00
0.81182E+03	0.14020E+00	0.46014E+00	0.64512E-01	0.17453E+00
0.81192E+03	0.13228E+00	0.46032E+00	0.60889E-01	0.16473E+00
0.81202E+03	0.12490E+00	0.46049E+00	0.57514E-01	0.15560E+00
0.81212E+03	0.11800E+00	0.46066E+00	0.54358E-01	0.14706E+00
0.81222E+03	0.11159E+00	0.46083E+00	0.51422E-01	0.13912E+00
0.81232E+03	0.10551E+00	0.46099E+00	0.48640E-01	0.13159E+00
0.81242E+03	0.99767E-01	0.46116E+00	0.46008E-01	0.12447E+00
0.81252E+03	0.94253E-01	0.46132E+00	0.43481E-01	0.11763E+00
0.81262E+03	0.88967E-01	0.46148E+00	0.41057E-01	0.11108E+00
0.81272E+03	0.83951E-01	0.46165E+00	0.38756E-01	0.10485E+00
0.81282E+03	0.79270E-01	0.46181E+00	0.36608E-01	0.99040E-01
0.81292E+03	0.74882E-01	0.46198E+00	0.34594E-01	0.93592E-01
0.81302E+03	0.70869E-01	0.46214E+00	0.32752E-01	0.88607E-01
0.81312E+03	0.67064E-01	0.46231E+00	0.31004E-01	0.83879E-01
0.81322E+03	0.63400E-01	0.46247E+00	0.29321E-01	0.79326E-01
0.81332E+03	0.59893E-01	0.46264E+00	0.27709E-01	0.74964E-01
0.81342E+03	0.56589E-01	0.46281E+00	0.26190E-01	0.70854E-01
0.81352E+03	0.53451E-01	0.46297E+00	0.24746E-01	0.66950E-01
0.81362E+03	0.50517E-01	0.46314E+00	0.23396E-01	0.63297E-01
0.81372E+03	0.47741E-01	0.46330E+00	0.22118E-01	0.59840E-01
0.81382E+03	0.45142E-01	0.46347E+00	0.20922E-01	0.56603E-01
0.81392E+03	0.42715E-01	0.46363E+00	0.19804E-01	0.53578E-01
0.81402E+03	0.40466E-01	0.46379E+00	0.18768E-01	0.50775E-01
0.81412E+03	0.38438E-01	0.46394E+00	0.17833E-01	0.48246E-01
0.81422E+03	0.36711E-01	0.46409E+00	0.17037E-01	0.46093E-01
0.81432E+03	0.35210E-01	0.46424E+00	0.16346E-01	0.44222E-01
0.81442E+03	0.33919E-01	0.46439E+00	0.15751E-01	0.42614E-01
0.81452E+03	0.32671E-01	0.46454E+00	0.15177E-01	0.41060E-01
0.81462E+03	0.31446E-01	0.46469E+00	0.14612E-01	0.39533E-01
0.81472E+03	0.30262E-01	0.46484E+00	0.14067E-01	0.38057E-01
0.81482E+03	0.29121E-01	0.46499E+00	0.13541E-01	0.36634E-01
0.81492E+03	0.28004E-01	0.46513E+00	0.13026E-01	0.35240E-01
0.81502E+03	0.26933E-01	0.46528E+00	0.12531E-01	0.33903E-01
0.81512E+03	0.25905E-01	0.46543E+00	0.12057E-01	0.32620E-01
0.81522E+03	0.24881E-01	0.46559E+00	0.11584E-01	0.31341E-01
0.81532E+03	0.23892E-01	0.46574E+00	0.11128E-01	0.30105E-01
0.81542E+03	0.22922E-01	0.46589E+00	0.10679E-01	0.28892E-01
0.81552E+03	0.21986E-01	0.46604E+00	0.10246E-01	0.27721E-01
0.81562E+03	0.21059E-01	0.46619E+00	0.98177E-02	0.26561E-01

0.81572E+03	0.20134E-01	0.46634E+00	0.93891E-02	0.25402E-01
0.81582E+03	0.19310E-01	0.46649E+00	0.90081E-02	0.24371E-01
0.81592E+03	0.18504E-01	0.46664E+00	0.86349E-02	0.23361E-01
0.81602E+03	0.17709E-01	0.46678E+00	0.82660E-02	0.22363E-01
0.81612E+03	0.16940E-01	0.46690E+00	0.79093E-02	0.21398E-01
0.81622E+03	0.16173E-01	0.46702E+00	0.75530E-02	0.20434E-01
0.81632E+03	0.15503E-01	0.46715E+00	0.72420E-02	0.19593E-01
0.81642E+03	0.14896E-01	0.46727E+00	0.69603E-02	0.18831E-01
0.81652E+03	0.14296E-01	0.46739E+00	0.66818E-02	0.18077E-01
0.81662E+03	0.13711E-01	0.46751E+00	0.64099E-02	0.17342E-01
0.81672E+03	0.13128E-01	0.46763E+00	0.61389E-02	0.16608E-01
0.81682E+03	0.12552E-01	0.46775E+00	0.58713E-02	0.15884E-01
0.81692E+03	0.11988E-01	0.46787E+00	0.56088E-02	0.15174E-01
0.81702E+03	0.11437E-01	0.46799E+00	0.53526E-02	0.14481E-01
0.81712E+03	0.10932E-01	0.46811E+00	0.51176E-02	0.13845E-01
0.81722E+03	0.10430E-01	0.46822E+00	0.48837E-02	0.13213E-01
0.81732E+03	0.99455E-02	0.46834E+00	0.46579E-02	0.12602E-01
0.81742E+03	0.94800E-02	0.46846E+00	0.44410E-02	0.12015E-01
0.81752E+03	0.90491E-02	0.46858E+00	0.42402E-02	0.11471E-01
0.81762E+03	0.86308E-02	0.46869E+00	0.40452E-02	0.10944E-01
0.81772E+03	0.82320E-02	0.46881E+00	0.38592E-02	0.10441E-01
0.81782E+03	0.78352E-02	0.46892E+00	0.36741E-02	0.99401E-02
0.81792E+03	0.74449E-02	0.46905E+00	0.34920E-02	0.94474E-02
0.81802E+03	0.70605E-02	0.46917E+00	0.33126E-02	0.89619E-02
0.81812E+03	0.66854E-02	0.46926E+00	0.31372E-02	0.84875E-02
0.81822E+03	0.63178E-02	0.46936E+00	0.29653E-02	0.80224E-02
0.81832E+03	0.59599E-02	0.46945E+00	0.27979E-02	0.75695E-02
0.81842E+03	0.56096E-02	0.46955E+00	0.26340E-02	0.71260E-02
0.81852E+03	0.52739E-02	0.46964E+00	0.24768E-02	0.67009E-02
0.81862E+03	0.49522E-02	0.46973E+00	0.23262E-02	0.62934E-02
0.81872E+03	0.46554E-02	0.46983E+00	0.21872E-02	0.59175E-02
0.81882E+03	0.43608E-02	0.46992E+00	0.20492E-02	0.55441E-02
0.81892E+03	0.40710E-02	0.47001E+00	0.19134E-02	0.51767E-02
0.81902E+03	0.37898E-02	0.47011E+00	0.17816E-02	0.48200E-02
0.81912E+03	0.35110E-02	0.47020E+00	0.16509E-02	0.44663E-02
0.81922E+03	0.32328E-02	0.47029E+00	0.15203E-02	0.41131E-02
0.81932E+03	0.29589E-02	0.47038E+00	0.13918E-02	0.37654E-02
0.81942E+03	0.26894E-02	0.47047E+00	0.12653E-02	0.34231E-02
0.81952E+03	0.24236E-02	0.47056E+00	0.11404E-02	0.30853E-02
0.81962E+03	0.21623E-02	0.47065E+00	0.10177E-02	0.27533E-02
0.81972E+03	0.19031E-02	0.47074E+00	0.89585E-03	0.24237E-02
0.81982E+03	0.16445E-02	0.47084E+00	0.77431E-03	0.20948E-02
0.81992E+03	0.13868E-02	0.47096E+00	0.65313E-03	0.17670E-02

0.82002E+03	0.11383E-02	0.47108E+00	0.53624E-03	0.14508E-02
0.82012E+03	0.91204E-03	0.47117E+00	0.42973E-03	0.11626E-02
0.82022E+03	0.69475E-03	0.47127E+00	0.32741E-03	0.88580E-03
0.82032E+03	0.48336E-03	0.47136E+00	0.22784E-03	0.61640E-03
0.82042E+03	0.27851E-03	0.47146E+00	0.13131E-03	0.35524E-03
0.82052E+03	0.82590E-04	0.47155E+00	0.38945E-04	0.10536E-03
0.82062E+03	0.00000E+00	0.47165E+00	0.00000E+00	0.00000E+00
Channel 11				
Wavenumber	HIRS Filter Transmittance	Optical Element Transmittance	Product of the HIRS Filter and Optical Element Transmittances	Normalized Value of Column 4
0.13243E+04	0.00000E+00	0.30632E+00	0.00000E+00	0.00000E+00
0.13244E+04	0.42639E-04	0.30632E+00	0.13061E-04	0.53525E-04
0.13245E+04	0.96851E-04	0.30633E+00	0.29669E-04	0.12158E-03
0.13246E+04	0.15248E-03	0.30634E+00	0.46711E-04	0.19142E-03
0.13247E+04	0.20850E-03	0.30635E+00	0.63873E-04	0.26175E-03
0.13248E+04	0.26516E-03	0.30636E+00	0.81236E-04	0.33290E-03
0.13249E+04	0.32208E-03	0.30637E+00	0.98675E-04	0.40437E-03
0.13250E+04	0.38007E-03	0.30638E+00	0.11644E-03	0.47718E-03
0.13251E+04	0.43819E-03	0.30639E+00	0.13425E-03	0.55016E-03
0.13252E+04	0.49895E-03	0.30639E+00	0.15287E-03	0.62647E-03
0.13253E+04	0.56049E-03	0.30639E+00	0.17173E-03	0.70374E-03
0.13254E+04	0.62295E-03	0.30639E+00	0.19087E-03	0.78216E-03
0.13255E+04	0.68595E-03	0.30639E+00	0.21017E-03	0.86125E-03
0.13256E+04	0.74896E-03	0.30638E+00	0.22947E-03	0.94036E-03
0.13257E+04	0.81197E-03	0.30638E+00	0.24877E-03	0.10195E-02
0.13258E+04	0.87509E-03	0.30638E+00	0.26811E-03	0.10987E-02
0.13259E+04	0.93846E-03	0.30638E+00	0.28752E-03	0.11783E-02
0.13260E+04	0.10020E-02	0.30638E+00	0.30699E-03	0.12580E-02
0.13261E+04	0.10659E-02	0.30642E+00	0.32662E-03	0.13385E-02
0.13262E+04	0.11324E-02	0.30646E+00	0.34703E-03	0.14221E-02
0.13263E+04	0.11991E-02	0.30650E+00	0.36753E-03	0.15061E-02
0.13264E+04	0.12680E-02	0.30655E+00	0.38870E-03	0.15929E-02
0.13265E+04	0.13369E-02	0.30659E+00	0.40990E-03	0.16797E-02
0.13266E+04	0.14065E-02	0.30663E+00	0.43129E-03	0.17674E-02
0.13267E+04	0.14761E-02	0.30668E+00	0.45270E-03	0.18551E-02
0.13268E+04	0.15460E-02	0.30672E+00	0.47419E-03	0.19432E-02
0.13269E+04	0.16167E-02	0.30676E+00	0.49593E-03	0.20323E-02
0.13270E+04	0.16880E-02	0.30680E+00	0.51788E-03	0.21222E-02
0.13271E+04	0.17593E-02	0.30685E+00	0.53984E-03	0.22122E-02
0.13272E+04	0.18319E-02	0.30689E+00	0.56218E-03	0.23038E-02
0.13273E+04	0.19047E-02	0.30693E+00	0.58459E-03	0.23956E-02

0.13274E+04	0.19784E-02	0.30697E+00	0.60731E-03	0.24887E-02
0.13275E+04	0.20530E-02	0.30701E+00	0.63029E-03	0.25829E-02
0.13276E+04	0.21291E-02	0.30705E+00	0.65373E-03	0.26790E-02
0.13277E+04	0.22052E-02	0.30709E+00	0.67719E-03	0.27751E-02
0.13278E+04	0.22816E-02	0.30713E+00	0.70076E-03	0.28717E-02
0.13279E+04	0.23608E-02	0.30717E+00	0.72517E-03	0.29717E-02
0.13280E+04	0.24403E-02	0.30721E+00	0.74969E-03	0.30722E-02
0.13281E+04	0.25212E-02	0.30729E+00	0.77474E-03	0.31748E-02
0.13282E+04	0.26022E-02	0.30737E+00	0.79984E-03	0.32777E-02
0.13283E+04	0.26834E-02	0.30745E+00	0.82499E-03	0.33808E-02
0.13284E+04	0.27646E-02	0.30752E+00	0.85019E-03	0.34840E-02
0.13285E+04	0.28460E-02	0.30760E+00	0.87542E-03	0.35874E-02
0.13286E+04	0.29289E-02	0.30768E+00	0.90118E-03	0.36930E-02
0.13287E+04	0.30136E-02	0.30776E+00	0.92746E-03	0.38007E-02
0.13288E+04	0.30985E-02	0.30784E+00	0.95383E-03	0.39088E-02
0.13289E+04	0.31837E-02	0.30792E+00	0.98033E-03	0.40173E-02
0.13290E+04	0.32693E-02	0.30799E+00	0.10069E-02	0.41263E-02
0.13291E+04	0.33550E-02	0.30807E+00	0.10336E-02	0.42356E-02
0.13292E+04	0.34419E-02	0.30815E+00	0.10606E-02	0.43463E-02
0.13293E+04	0.35298E-02	0.30823E+00	0.10880E-02	0.44586E-02
0.13294E+04	0.36178E-02	0.30831E+00	0.11154E-02	0.45708E-02
0.13295E+04	0.37061E-02	0.30839E+00	0.11429E-02	0.46835E-02
0.13296E+04	0.37970E-02	0.30846E+00	0.11712E-02	0.47997E-02
0.13297E+04	0.38884E-02	0.30854E+00	0.11997E-02	0.49165E-02
0.13298E+04	0.39827E-02	0.30862E+00	0.12291E-02	0.50370E-02
0.13299E+04	0.40793E-02	0.30870E+00	0.12593E-02	0.51605E-02
0.13300E+04	0.41775E-02	0.30878E+00	0.12899E-02	0.52860E-02
0.13301E+04	0.42765E-02	0.30888E+00	0.13209E-02	0.54132E-02
0.13302E+04	0.43759E-02	0.30899E+00	0.13521E-02	0.55408E-02
0.13303E+04	0.44762E-02	0.30909E+00	0.13836E-02	0.56698E-02
0.13304E+04	0.45783E-02	0.30920E+00	0.14156E-02	0.58011E-02
0.13305E+04	0.46816E-02	0.30930E+00	0.14480E-02	0.59340E-02
0.13306E+04	0.47857E-02	0.30941E+00	0.14807E-02	0.60680E-02
0.13307E+04	0.48946E-02	0.30951E+00	0.15149E-02	0.62080E-02
0.13308E+04	0.50035E-02	0.30962E+00	0.15492E-02	0.63484E-02
0.13309E+04	0.51125E-02	0.30972E+00	0.15835E-02	0.64889E-02
0.13310E+04	0.52219E-02	0.30982E+00	0.16179E-02	0.66299E-02
0.13311E+04	0.53326E-02	0.30992E+00	0.16527E-02	0.67725E-02
0.13312E+04	0.54443E-02	0.31001E+00	0.16878E-02	0.69165E-02
0.13313E+04	0.55565E-02	0.31011E+00	0.17231E-02	0.70612E-02
0.13314E+04	0.56716E-02	0.31020E+00	0.17593E-02	0.72097E-02
0.13315E+04	0.57868E-02	0.31030E+00	0.17956E-02	0.73584E-02
0.13316E+04	0.59021E-02	0.31039E+00	0.18320E-02	0.75074E-02

0.13317E+04	0.60198E-02	0.31049E+00	0.18691E-02	0.76594E-02
0.13318E+04	0.61379E-02	0.31058E+00	0.19063E-02	0.78120E-02
0.13319E+04	0.62578E-02	0.31068E+00	0.19442E-02	0.79670E-02
0.13320E+04	0.63800E-02	0.31077E+00	0.19827E-02	0.81252E-02
0.13321E+04	0.65045E-02	0.31089E+00	0.20222E-02	0.82868E-02
0.13322E+04	0.66555E-02	0.31100E+00	0.20699E-02	0.84823E-02
0.13323E+04	0.68240E-02	0.31112E+00	0.21231E-02	0.87002E-02
0.13324E+04	0.69990E-02	0.31123E+00	0.21783E-02	0.89267E-02
0.13325E+04	0.71765E-02	0.31135E+00	0.22344E-02	0.91564E-02
0.13326E+04	0.73556E-02	0.31146E+00	0.22910E-02	0.93883E-02
0.13327E+04	0.75737E-02	0.31158E+00	0.23598E-02	0.96703E-02
0.13328E+04	0.78312E-02	0.31169E+00	0.24409E-02	0.10003E-01
0.13329E+04	0.81145E-02	0.31180E+00	0.25301E-02	0.10368E-01
0.13330E+04	0.84121E-02	0.31191E+00	0.26238E-02	0.10752E-01
0.13331E+04	0.87271E-02	0.31202E+00	0.27230E-02	0.11159E-01
0.13332E+04	0.90423E-02	0.31213E+00	0.28224E-02	0.11566E-01
0.13333E+04	0.93631E-02	0.31223E+00	0.29235E-02	0.11980E-01
0.13334E+04	0.96955E-02	0.31234E+00	0.30283E-02	0.12410E-01
0.13335E+04	0.10040E-01	0.31245E+00	0.31370E-02	0.12855E-01
0.13336E+04	0.10398E-01	0.31256E+00	0.32500E-02	0.13318E-01
0.13337E+04	0.10760E-01	0.31266E+00	0.33642E-02	0.13786E-01
0.13338E+04	0.11122E-01	0.31277E+00	0.34787E-02	0.14256E-01
0.13339E+04	0.11509E-01	0.31288E+00	0.36009E-02	0.14756E-01
0.13340E+04	0.11922E-01	0.31298E+00	0.37313E-02	0.15291E-01
0.13341E+04	0.12345E-01	0.31309E+00	0.38652E-02	0.15840E-01
0.13342E+04	0.12772E-01	0.31320E+00	0.40002E-02	0.16393E-01
0.13343E+04	0.13201E-01	0.31331E+00	0.41359E-02	0.16949E-01
0.13344E+04	0.13641E-01	0.31342E+00	0.42752E-02	0.17520E-01
0.13345E+04	0.14113E-01	0.31353E+00	0.44249E-02	0.18133E-01
0.13346E+04	0.14659E-01	0.31364E+00	0.45977E-02	0.18841E-01
0.13347E+04	0.15220E-01	0.31375E+00	0.47753E-02	0.19569E-01
0.13348E+04	0.15783E-01	0.31386E+00	0.49537E-02	0.20300E-01
0.13349E+04	0.16362E-01	0.31397E+00	0.51371E-02	0.21052E-01
0.13350E+04	0.16942E-01	0.31409E+00	0.53211E-02	0.21806E-01
0.13351E+04	0.17532E-01	0.31420E+00	0.55086E-02	0.22574E-01
0.13352E+04	0.18131E-01	0.31432E+00	0.56988E-02	0.23353E-01
0.13353E+04	0.18749E-01	0.31443E+00	0.58952E-02	0.24158E-01
0.13354E+04	0.19367E-01	0.31455E+00	0.60919E-02	0.24964E-01
0.13355E+04	0.19993E-01	0.31466E+00	0.62910E-02	0.25780E-01
0.13356E+04	0.20645E-01	0.31478E+00	0.64986E-02	0.26631E-01
0.13357E+04	0.21345E-01	0.31489E+00	0.67212E-02	0.27543E-01
0.13358E+04	0.22080E-01	0.31500E+00	0.69553E-02	0.28502E-01
0.13359E+04	0.22851E-01	0.31512E+00	0.72008E-02	0.29508E-01

0.13360E+04	0.23655E-01	0.31523E+00	0.74569E-02	0.30558E-01
0.13361E+04	0.24462E-01	0.31534E+00	0.77140E-02	0.31611E-01
0.13362E+04	0.25270E-01	0.31545E+00	0.79714E-02	0.32666E-01
0.13363E+04	0.26084E-01	0.31555E+00	0.82310E-02	0.33730E-01
0.13364E+04	0.26959E-01	0.31566E+00	0.85099E-02	0.34873E-01
0.13365E+04	0.27912E-01	0.31576E+00	0.88136E-02	0.36118E-01
0.13366E+04	0.28962E-01	0.31587E+00	0.91481E-02	0.37489E-01
0.13367E+04	0.30102E-01	0.31598E+00	0.95116E-02	0.38978E-01
0.13368E+04	0.31268E-01	0.31609E+00	0.98836E-02	0.40502E-01
0.13369E+04	0.32512E-01	0.31621E+00	0.10280E-01	0.42129E-01
0.13370E+04	0.33773E-01	0.31632E+00	0.10683E-01	0.43779E-01
0.13371E+04	0.35081E-01	0.31644E+00	0.11101E-01	0.45492E-01
0.13372E+04	0.36424E-01	0.31656E+00	0.11530E-01	0.47251E-01
0.13373E+04	0.37844E-01	0.31668E+00	0.11984E-01	0.49112E-01
0.13374E+04	0.39336E-01	0.31680E+00	0.12462E-01	0.51067E-01
0.13375E+04	0.40877E-01	0.31692E+00	0.12954E-01	0.53087E-01
0.13376E+04	0.42476E-01	0.31703E+00	0.13466E-01	0.55184E-01
0.13377E+04	0.44095E-01	0.31715E+00	0.13985E-01	0.57309E-01
0.13378E+04	0.45793E-01	0.31727E+00	0.14529E-01	0.59538E-01
0.13379E+04	0.47567E-01	0.31739E+00	0.15097E-01	0.61867E-01
0.13380E+04	0.49467E-01	0.31751E+00	0.15706E-01	0.64363E-01
0.13381E+04	0.51466E-01	0.31760E+00	0.16346E-01	0.66984E-01
0.13382E+04	0.53613E-01	0.31770E+00	0.17033E-01	0.69799E-01
0.13383E+04	0.55872E-01	0.31780E+00	0.17756E-01	0.72763E-01
0.13384E+04	0.58231E-01	0.31789E+00	0.18511E-01	0.75857E-01
0.13385E+04	0.60740E-01	0.31799E+00	0.19314E-01	0.79149E-01
0.13386E+04	0.63349E-01	0.31808E+00	0.20150E-01	0.82574E-01
0.13387E+04	0.66144E-01	0.31820E+00	0.21047E-01	0.86250E-01
0.13388E+04	0.69091E-01	0.31832E+00	0.21993E-01	0.90128E-01
0.13389E+04	0.72219E-01	0.31845E+00	0.22998E-01	0.94244E-01
0.13390E+04	0.75532E-01	0.31857E+00	0.24062E-01	0.98605E-01
0.13391E+04	0.79041E-01	0.31869E+00	0.25190E-01	0.10323E+00
0.13392E+04	0.82675E-01	0.31881E+00	0.26358E-01	0.10801E+00
0.13393E+04	0.86484E-01	0.31893E+00	0.27583E-01	0.11303E+00
0.13394E+04	0.90426E-01	0.31906E+00	0.28851E-01	0.11823E+00
0.13395E+04	0.94540E-01	0.31918E+00	0.30175E-01	0.12366E+00
0.13396E+04	0.98870E-01	0.31930E+00	0.31570E-01	0.12937E+00
0.13397E+04	0.10335E+00	0.31942E+00	0.33014E-01	0.13529E+00
0.13398E+04	0.10809E+00	0.31955E+00	0.34541E-01	0.14155E+00
0.13399E+04	0.11303E+00	0.31967E+00	0.36131E-01	0.14806E+00
0.13400E+04	0.11821E+00	0.31979E+00	0.37804E-01	0.15492E+00
0.13401E+04	0.12361E+00	0.31988E+00	0.39540E-01	0.16203E+00
0.13402E+04	0.12923E+00	0.31996E+00	0.41348E-01	0.16944E+00

0.13403E+04	0.13507E+00	0.32005E+00	0.43228E-01	0.17714E+00
0.13404E+04	0.14118E+00	0.32013E+00	0.45194E-01	0.18520E+00
0.13405E+04	0.14751E+00	0.32021E+00	0.47236E-01	0.19357E+00
0.13406E+04	0.15414E+00	0.32030E+00	0.49370E-01	0.20231E+00
0.13407E+04	0.16101E+00	0.32039E+00	0.51587E-01	0.21140E+00
0.13408E+04	0.16812E+00	0.32048E+00	0.53880E-01	0.22080E+00
0.13409E+04	0.17549E+00	0.32058E+00	0.56257E-01	0.23054E+00
0.13410E+04	0.18308E+00	0.32067E+00	0.58707E-01	0.24058E+00
0.13411E+04	0.19094E+00	0.32076E+00	0.61247E-01	0.25099E+00
0.13412E+04	0.19906E+00	0.32086E+00	0.63870E-01	0.26174E+00
0.13413E+04	0.20750E+00	0.32095E+00	0.66598E-01	0.27292E+00
0.13414E+04	0.21617E+00	0.32105E+00	0.69402E-01	0.28440E+00
0.13415E+04	0.22511E+00	0.32114E+00	0.72291E-01	0.29624E+00
0.13416E+04	0.23425E+00	0.32124E+00	0.75251E-01	0.30837E+00
0.13417E+04	0.24365E+00	0.32133E+00	0.78292E-01	0.32083E+00
0.13418E+04	0.25326E+00	0.32143E+00	0.81403E-01	0.33358E+00
0.13419E+04	0.26307E+00	0.32152E+00	0.84583E-01	0.34662E+00
0.13420E+04	0.27311E+00	0.32161E+00	0.87834E-01	0.35994E+00
0.13421E+04	0.28340E+00	0.32166E+00	0.91157E-01	0.37356E+00
0.13422E+04	0.29392E+00	0.32171E+00	0.94555E-01	0.38748E+00
0.13423E+04	0.30469E+00	0.32175E+00	0.98036E-01	0.40175E+00
0.13424E+04	0.31569E+00	0.32180E+00	0.10159E+00	0.41631E+00
0.13425E+04	0.32689E+00	0.32185E+00	0.10521E+00	0.43115E+00
0.13426E+04	0.33826E+00	0.32191E+00	0.10889E+00	0.44622E+00
0.13427E+04	0.34974E+00	0.32197E+00	0.11261E+00	0.46146E+00
0.13428E+04	0.36130E+00	0.32204E+00	0.11635E+00	0.47680E+00
0.13429E+04	0.37290E+00	0.32210E+00	0.12011E+00	0.49220E+00
0.13430E+04	0.38452E+00	0.32216E+00	0.12388E+00	0.50765E+00
0.13431E+04	0.39616E+00	0.32223E+00	0.12765E+00	0.52312E+00
0.13432E+04	0.40782E+00	0.32229E+00	0.13144E+00	0.53863E+00
0.13433E+04	0.41953E+00	0.32236E+00	0.13524E+00	0.55420E+00
0.13434E+04	0.43125E+00	0.32242E+00	0.13904E+00	0.56979E+00
0.13435E+04	0.44299E+00	0.32249E+00	0.14286E+00	0.58542E+00
0.13436E+04	0.45469E+00	0.32255E+00	0.14666E+00	0.60100E+00
0.13437E+04	0.46634E+00	0.32261E+00	0.15045E+00	0.61652E+00
0.13438E+04	0.47792E+00	0.32268E+00	0.15421E+00	0.63196E+00
0.13439E+04	0.48942E+00	0.32274E+00	0.15796E+00	0.64730E+00
0.13440E+04	0.50081E+00	0.32281E+00	0.16167E+00	0.66250E+00
0.13441E+04	0.51207E+00	0.32282E+00	0.16531E+00	0.67742E+00
0.13442E+04	0.52324E+00	0.32283E+00	0.16892E+00	0.69222E+00
0.13443E+04	0.53432E+00	0.32284E+00	0.17250E+00	0.70690E+00
0.13444E+04	0.54534E+00	0.32285E+00	0.17607E+00	0.72151E+00
0.13445E+04	0.55625E+00	0.32286E+00	0.17959E+00	0.73596E+00

0.13446E+04	0.56700E+00	0.32287E+00	0.18307E+00	0.75019E+00
0.13447E+04	0.57754E+00	0.32288E+00	0.18647E+00	0.76416E+00
0.13448E+04	0.58782E+00	0.32288E+00	0.18980E+00	0.77778E+00
0.13449E+04	0.59786E+00	0.32289E+00	0.19304E+00	0.79107E+00
0.13450E+04	0.60762E+00	0.32289E+00	0.19620E+00	0.80400E+00
0.13451E+04	0.61716E+00	0.32290E+00	0.19928E+00	0.81663E+00
0.13452E+04	0.62641E+00	0.32290E+00	0.20227E+00	0.82889E+00
0.13453E+04	0.63537E+00	0.32291E+00	0.20517E+00	0.84076E+00
0.13454E+04	0.64399E+00	0.32292E+00	0.20795E+00	0.85218E+00
0.13455E+04	0.65227E+00	0.32292E+00	0.21063E+00	0.86315E+00
0.13456E+04	0.66023E+00	0.32293E+00	0.21321E+00	0.87371E+00
0.13457E+04	0.66786E+00	0.32293E+00	0.21567E+00	0.88382E+00
0.13458E+04	0.67520E+00	0.32294E+00	0.21805E+00	0.89355E+00
0.13459E+04	0.68218E+00	0.32294E+00	0.22031E+00	0.90281E+00
0.13460E+04	0.68886E+00	0.32295E+00	0.22247E+00	0.91166E+00
0.13461E+04	0.69521E+00	0.32290E+00	0.22448E+00	0.91992E+00
0.13462E+04	0.70127E+00	0.32285E+00	0.22641E+00	0.92780E+00
0.13463E+04	0.70699E+00	0.32280E+00	0.22822E+00	0.93523E+00
0.13464E+04	0.71236E+00	0.32276E+00	0.22992E+00	0.94219E+00
0.13465E+04	0.71737E+00	0.32269E+00	0.23149E+00	0.94863E+00
0.13466E+04	0.72200E+00	0.32263E+00	0.23294E+00	0.95456E+00
0.13467E+04	0.72631E+00	0.32256E+00	0.23428E+00	0.96007E+00
0.13468E+04	0.73028E+00	0.32250E+00	0.23552E+00	0.96513E+00
0.13469E+04	0.73398E+00	0.32244E+00	0.23666E+00	0.96983E+00
0.13470E+04	0.73739E+00	0.32237E+00	0.23771E+00	0.97413E+00
0.13471E+04	0.74051E+00	0.32231E+00	0.23867E+00	0.97807E+00
0.13472E+04	0.74335E+00	0.32224E+00	0.23954E+00	0.98162E+00
0.13473E+04	0.74595E+00	0.32218E+00	0.24033E+00	0.98486E+00
0.13474E+04	0.74828E+00	0.32211E+00	0.24103E+00	0.98774E+00
0.13475E+04	0.75037E+00	0.32205E+00	0.24166E+00	0.99030E+00
0.13476E+04	0.75225E+00	0.32199E+00	0.24221E+00	0.99257E+00
0.13477E+04	0.75388E+00	0.32192E+00	0.24269E+00	0.99454E+00
0.13478E+04	0.75534E+00	0.32186E+00	0.24311E+00	0.99626E+00
0.13479E+04	0.75653E+00	0.32179E+00	0.24345E+00	0.99764E+00
0.13480E+04	0.75755E+00	0.32173E+00	0.24373E+00	0.99878E+00
0.13481E+04	0.75834E+00	0.32161E+00	0.24389E+00	0.99945E+00
0.13482E+04	0.75892E+00	0.32150E+00	0.24399E+00	0.99986E+00
0.13483E+04	0.75931E+00	0.32138E+00	0.24402E+00	0.10000E+01
0.13484E+04	0.75950E+00	0.32125E+00	0.24399E+00	0.99987E+00
0.13485E+04	0.75951E+00	0.32113E+00	0.24390E+00	0.99949E+00
0.13486E+04	0.75938E+00	0.32100E+00	0.24376E+00	0.99893E+00
0.13487E+04	0.75909E+00	0.32087E+00	0.24357E+00	0.99814E+00
0.13488E+04	0.75864E+00	0.32075E+00	0.24333E+00	0.99716E+00

0.13489E+04	0.75809E+00	0.32062E+00	0.24306E+00	0.99604E+00
0.13490E+04	0.75742E+00	0.32049E+00	0.24275E+00	0.99478E+00
0.13491E+04	0.75672E+00	0.32037E+00	0.24243E+00	0.99346E+00
0.13492E+04	0.75596E+00	0.32024E+00	0.24209E+00	0.99206E+00
0.13493E+04	0.75515E+00	0.32011E+00	0.24173E+00	0.99060E+00
0.13494E+04	0.75423E+00	0.31998E+00	0.24134E+00	0.98900E+00
0.13495E+04	0.75328E+00	0.31985E+00	0.24094E+00	0.98737E+00
0.13496E+04	0.75224E+00	0.31973E+00	0.24051E+00	0.98560E+00
0.13497E+04	0.75114E+00	0.31960E+00	0.24006E+00	0.98377E+00
0.13498E+04	0.74999E+00	0.31947E+00	0.23960E+00	0.98187E+00
0.13499E+04	0.74885E+00	0.31934E+00	0.23914E+00	0.97998E+00
0.13500E+04	0.74773E+00	0.31921E+00	0.23869E+00	0.97813E+00
0.13501E+04	0.74663E+00	0.31904E+00	0.23820E+00	0.97614E+00
0.13502E+04	0.74550E+00	0.31886E+00	0.23771E+00	0.97413E+00
0.13503E+04	0.74435E+00	0.31869E+00	0.23721E+00	0.97209E+00
0.13504E+04	0.74318E+00	0.31851E+00	0.23671E+00	0.97001E+00
0.13505E+04	0.74202E+00	0.31832E+00	0.23620E+00	0.96794E+00
0.13506E+04	0.74083E+00	0.31814E+00	0.23569E+00	0.96585E+00
0.13507E+04	0.73965E+00	0.31796E+00	0.23518E+00	0.96376E+00
0.13508E+04	0.73845E+00	0.31778E+00	0.23467E+00	0.96165E+00
0.13509E+04	0.73726E+00	0.31760E+00	0.23415E+00	0.95954E+00
0.13510E+04	0.73605E+00	0.31742E+00	0.23363E+00	0.95742E+00
0.13511E+04	0.73485E+00	0.31723E+00	0.23312E+00	0.95531E+00
0.13512E+04	0.73367E+00	0.31705E+00	0.23261E+00	0.95322E+00
0.13513E+04	0.73252E+00	0.31687E+00	0.23211E+00	0.95117E+00
0.13514E+04	0.73137E+00	0.31668E+00	0.23161E+00	0.94913E+00
0.13515E+04	0.73023E+00	0.31650E+00	0.23112E+00	0.94710E+00
0.13516E+04	0.72906E+00	0.31631E+00	0.23061E+00	0.94504E+00
0.13517E+04	0.72787E+00	0.31613E+00	0.23010E+00	0.94294E+00
0.13518E+04	0.72665E+00	0.31595E+00	0.22958E+00	0.94081E+00
0.13519E+04	0.72539E+00	0.31576E+00	0.22905E+00	0.93864E+00
0.13520E+04	0.72408E+00	0.31558E+00	0.22850E+00	0.93640E+00
0.13521E+04	0.72275E+00	0.31535E+00	0.22792E+00	0.93401E+00
0.13522E+04	0.72143E+00	0.31513E+00	0.22734E+00	0.93163E+00
0.13523E+04	0.72012E+00	0.31489E+00	0.22676E+00	0.92923E+00
0.13524E+04	0.71881E+00	0.31465E+00	0.22617E+00	0.92684E+00
0.13525E+04	0.71747E+00	0.31441E+00	0.22558E+00	0.92440E+00
0.13526E+04	0.71608E+00	0.31417E+00	0.22497E+00	0.92190E+00
0.13527E+04	0.71466E+00	0.31393E+00	0.22435E+00	0.91938E+00
0.13528E+04	0.71324E+00	0.31369E+00	0.22373E+00	0.91685E+00
0.13529E+04	0.71183E+00	0.31345E+00	0.22312E+00	0.91434E+00
0.13530E+04	0.71046E+00	0.31321E+00	0.22252E+00	0.91188E+00
0.13531E+04	0.70909E+00	0.31296E+00	0.22192E+00	0.90942E+00

0.13532E+04	0.70766E+00	0.31272E+00	0.22130E+00	0.90688E+00
0.13533E+04	0.70617E+00	0.31248E+00	0.22066E+00	0.90426E+00
0.13534E+04	0.70467E+00	0.31223E+00	0.22002E+00	0.90163E+00
0.13535E+04	0.70317E+00	0.31199E+00	0.21938E+00	0.89902E+00
0.13536E+04	0.70175E+00	0.31175E+00	0.21877E+00	0.89650E+00
0.13537E+04	0.70039E+00	0.31150E+00	0.21817E+00	0.89406E+00
0.13538E+04	0.69905E+00	0.31126E+00	0.21759E+00	0.89165E+00
0.13539E+04	0.69774E+00	0.31101E+00	0.21701E+00	0.88928E+00
0.13540E+04	0.69645E+00	0.31077E+00	0.21644E+00	0.88694E+00
0.13541E+04	0.69517E+00	0.31050E+00	0.21585E+00	0.88454E+00
0.13542E+04	0.69387E+00	0.31021E+00	0.21525E+00	0.88208E+00
0.13543E+04	0.69255E+00	0.30993E+00	0.21464E+00	0.87958E+00
0.13544E+04	0.69121E+00	0.30964E+00	0.21403E+00	0.87707E+00
0.13545E+04	0.68989E+00	0.30935E+00	0.21342E+00	0.87459E+00
0.13546E+04	0.68858E+00	0.30907E+00	0.21282E+00	0.87212E+00
0.13547E+04	0.68729E+00	0.30878E+00	0.21222E+00	0.86967E+00
0.13548E+04	0.68601E+00	0.30849E+00	0.21163E+00	0.86725E+00
0.13549E+04	0.68475E+00	0.30821E+00	0.21104E+00	0.86485E+00
0.13550E+04	0.68348E+00	0.30792E+00	0.21046E+00	0.86245E+00
0.13551E+04	0.68226E+00	0.30763E+00	0.20989E+00	0.86010E+00
0.13552E+04	0.68110E+00	0.30735E+00	0.20933E+00	0.85784E+00
0.13553E+04	0.67999E+00	0.30706E+00	0.20880E+00	0.85564E+00
0.13554E+04	0.67893E+00	0.30677E+00	0.20828E+00	0.85351E+00
0.13555E+04	0.67791E+00	0.30648E+00	0.20777E+00	0.85143E+00
0.13556E+04	0.67695E+00	0.30620E+00	0.20728E+00	0.84942E+00
0.13557E+04	0.67602E+00	0.30591E+00	0.20680E+00	0.84746E+00
0.13558E+04	0.67511E+00	0.30562E+00	0.20633E+00	0.84553E+00
0.13559E+04	0.67424E+00	0.30534E+00	0.20587E+00	0.84364E+00
0.13560E+04	0.67341E+00	0.30505E+00	0.20542E+00	0.84181E+00
0.13561E+04	0.67259E+00	0.30474E+00	0.20497E+00	0.83995E+00
0.13562E+04	0.67176E+00	0.30444E+00	0.20451E+00	0.83807E+00
0.13563E+04	0.67093E+00	0.30413E+00	0.20405E+00	0.83620E+00
0.13564E+04	0.67011E+00	0.30383E+00	0.20360E+00	0.83434E+00
0.13565E+04	0.66932E+00	0.30352E+00	0.20316E+00	0.83252E+00
0.13566E+04	0.66856E+00	0.30322E+00	0.20272E+00	0.83075E+00
0.13567E+04	0.66784E+00	0.30292E+00	0.20230E+00	0.82901E+00
0.13568E+04	0.66714E+00	0.30261E+00	0.20188E+00	0.82731E+00
0.13569E+04	0.66648E+00	0.30231E+00	0.20148E+00	0.82566E+00
0.13570E+04	0.66585E+00	0.30200E+00	0.20109E+00	0.82406E+00
0.13571E+04	0.66527E+00	0.30170E+00	0.20071E+00	0.82251E+00
0.13572E+04	0.66472E+00	0.30140E+00	0.20034E+00	0.82100E+00
0.13573E+04	0.66419E+00	0.30109E+00	0.19998E+00	0.81951E+00
0.13574E+04	0.66366E+00	0.30079E+00	0.19962E+00	0.81803E+00

0.13575E+04	0.66311E+00	0.30049E+00	0.19925E+00	0.81653E+00
0.13576E+04	0.66253E+00	0.30018E+00	0.19888E+00	0.81500E+00
0.13577E+04	0.66194E+00	0.29988E+00	0.19850E+00	0.81346E+00
0.13578E+04	0.66138E+00	0.29958E+00	0.19813E+00	0.81194E+00
0.13579E+04	0.66083E+00	0.29928E+00	0.19777E+00	0.81045E+00
0.13580E+04	0.66028E+00	0.29898E+00	0.19741E+00	0.80897E+00
0.13581E+04	0.65975E+00	0.29868E+00	0.19705E+00	0.80752E+00
0.13582E+04	0.65921E+00	0.29839E+00	0.19670E+00	0.80607E+00
0.13583E+04	0.65869E+00	0.29810E+00	0.19635E+00	0.80465E+00
0.13584E+04	0.65822E+00	0.29780E+00	0.19602E+00	0.80327E+00
0.13585E+04	0.65776E+00	0.29749E+00	0.19567E+00	0.80186E+00
0.13586E+04	0.65732E+00	0.29717E+00	0.19534E+00	0.80047E+00
0.13587E+04	0.65689E+00	0.29686E+00	0.19500E+00	0.79911E+00
0.13588E+04	0.65648E+00	0.29654E+00	0.19467E+00	0.79776E+00
0.13589E+04	0.65610E+00	0.29623E+00	0.19436E+00	0.79646E+00
0.13590E+04	0.65575E+00	0.29591E+00	0.19405E+00	0.79519E+00
0.13591E+04	0.65545E+00	0.29560E+00	0.19375E+00	0.79398E+00
0.13592E+04	0.65519E+00	0.29529E+00	0.19347E+00	0.79283E+00
0.13593E+04	0.65496E+00	0.29498E+00	0.19320E+00	0.79173E+00
0.13594E+04	0.65477E+00	0.29467E+00	0.19294E+00	0.79066E+00
0.13595E+04	0.65458E+00	0.29436E+00	0.19268E+00	0.78960E+00
0.13596E+04	0.65438E+00	0.29405E+00	0.19242E+00	0.78853E+00
0.13597E+04	0.65417E+00	0.29374E+00	0.19216E+00	0.78745E+00
0.13598E+04	0.65395E+00	0.29343E+00	0.19189E+00	0.78635E+00
0.13599E+04	0.65372E+00	0.29312E+00	0.19162E+00	0.78525E+00
0.13600E+04	0.65348E+00	0.29283E+00	0.19136E+00	0.78418E+00
0.13601E+04	0.65324E+00	0.29255E+00	0.19110E+00	0.78314E+00
0.13602E+04	0.65302E+00	0.29227E+00	0.19086E+00	0.78213E+00
0.13603E+04	0.65281E+00	0.29199E+00	0.19062E+00	0.78113E+00
0.13604E+04	0.65261E+00	0.29171E+00	0.19037E+00	0.78014E+00
0.13605E+04	0.65241E+00	0.29143E+00	0.19013E+00	0.77915E+00
0.13606E+04	0.65218E+00	0.29115E+00	0.18989E+00	0.77814E+00
0.13607E+04	0.65194E+00	0.29088E+00	0.18963E+00	0.77711E+00
0.13608E+04	0.65169E+00	0.29060E+00	0.18938E+00	0.77607E+00
0.13609E+04	0.65145E+00	0.29032E+00	0.18913E+00	0.77504E+00
0.13610E+04	0.65121E+00	0.29004E+00	0.18888E+00	0.77402E+00
0.13611E+04	0.65096E+00	0.28977E+00	0.18863E+00	0.77299E+00
0.13612E+04	0.65068E+00	0.28950E+00	0.18837E+00	0.77193E+00
0.13613E+04	0.65040E+00	0.28923E+00	0.18811E+00	0.77088E+00
0.13614E+04	0.65015E+00	0.28896E+00	0.18787E+00	0.76986E+00
0.13615E+04	0.64991E+00	0.28869E+00	0.18762E+00	0.76886E+00
0.13616E+04	0.64969E+00	0.28841E+00	0.18738E+00	0.76788E+00
0.13617E+04	0.64947E+00	0.28814E+00	0.18714E+00	0.76690E+00

0.13618E+04	0.64923E+00	0.28787E+00	0.18690E+00	0.76589E+00
0.13619E+04	0.64898E+00	0.28762E+00	0.18666E+00	0.76491E+00
0.13620E+04	0.64874E+00	0.28737E+00	0.18643E+00	0.76396E+00
0.13621E+04	0.64852E+00	0.28714E+00	0.18622E+00	0.76311E+00
0.13622E+04	0.64830E+00	0.28692E+00	0.18601E+00	0.76226E+00
0.13623E+04	0.64810E+00	0.28670E+00	0.18581E+00	0.76143E+00
0.13624E+04	0.64787E+00	0.28647E+00	0.18560E+00	0.76056E+00
0.13625E+04	0.64758E+00	0.28625E+00	0.18537E+00	0.75963E+00
0.13626E+04	0.64724E+00	0.28603E+00	0.18513E+00	0.75865E+00
0.13627E+04	0.64689E+00	0.28580E+00	0.18488E+00	0.75765E+00
0.13628E+04	0.64656E+00	0.28558E+00	0.18464E+00	0.75667E+00
0.13629E+04	0.64624E+00	0.28536E+00	0.18441E+00	0.75571E+00
0.13630E+04	0.64595E+00	0.28514E+00	0.18418E+00	0.75477E+00
0.13631E+04	0.64566E+00	0.28492E+00	0.18396E+00	0.75386E+00
0.13632E+04	0.64539E+00	0.28470E+00	0.18374E+00	0.75297E+00
0.13633E+04	0.64512E+00	0.28448E+00	0.18353E+00	0.75208E+00
0.13634E+04	0.64486E+00	0.28427E+00	0.18331E+00	0.75121E+00
0.13635E+04	0.64464E+00	0.28405E+00	0.18311E+00	0.75037E+00
0.13636E+04	0.64443E+00	0.28383E+00	0.18291E+00	0.74956E+00
0.13637E+04	0.64422E+00	0.28361E+00	0.18271E+00	0.74873E+00
0.13638E+04	0.64398E+00	0.28340E+00	0.18251E+00	0.74790E+00
0.13639E+04	0.64374E+00	0.28320E+00	0.18231E+00	0.74708E+00
0.13640E+04	0.64347E+00	0.28300E+00	0.18210E+00	0.74624E+00
0.13641E+04	0.64319E+00	0.28283E+00	0.18192E+00	0.74548E+00
0.13642E+04	0.64289E+00	0.28267E+00	0.18173E+00	0.74470E+00
0.13643E+04	0.64259E+00	0.28250E+00	0.18154E+00	0.74392E+00
0.13644E+04	0.64226E+00	0.28234E+00	0.18134E+00	0.74310E+00
0.13645E+04	0.64189E+00	0.28218E+00	0.18113E+00	0.74225E+00
0.13646E+04	0.64154E+00	0.28201E+00	0.18092E+00	0.74141E+00
0.13647E+04	0.64120E+00	0.28185E+00	0.18072E+00	0.74060E+00
0.13648E+04	0.64086E+00	0.28169E+00	0.18052E+00	0.73976E+00
0.13649E+04	0.64049E+00	0.28152E+00	0.18031E+00	0.73891E+00
0.13650E+04	0.64012E+00	0.28136E+00	0.18010E+00	0.73806E+00
0.13651E+04	0.63976E+00	0.28120E+00	0.17990E+00	0.73722E+00
0.13652E+04	0.63939E+00	0.28104E+00	0.17969E+00	0.73638E+00
0.13653E+04	0.63901E+00	0.28088E+00	0.17949E+00	0.73552E+00
0.13654E+04	0.63859E+00	0.28072E+00	0.17927E+00	0.73462E+00
0.13655E+04	0.63811E+00	0.28056E+00	0.17903E+00	0.73366E+00
0.13656E+04	0.63760E+00	0.28040E+00	0.17878E+00	0.73265E+00
0.13657E+04	0.63704E+00	0.28024E+00	0.17853E+00	0.73159E+00
0.13658E+04	0.63645E+00	0.28008E+00	0.17826E+00	0.73049E+00
0.13659E+04	0.63585E+00	0.27992E+00	0.17799E+00	0.72937E+00
0.13660E+04	0.63522E+00	0.27976E+00	0.17771E+00	0.72823E+00

0.13661E+04	0.63455E+00	0.27964E+00	0.17744E+00	0.72715E+00
0.13662E+04	0.63384E+00	0.27952E+00	0.17717E+00	0.72604E+00
0.13663E+04	0.63307E+00	0.27941E+00	0.17689E+00	0.72487E+00
0.13664E+04	0.63227E+00	0.27929E+00	0.17659E+00	0.72366E+00
0.13665E+04	0.63145E+00	0.27918E+00	0.17629E+00	0.72241E+00
0.13666E+04	0.63061E+00	0.27906E+00	0.17598E+00	0.72116E+00
0.13667E+04	0.62976E+00	0.27895E+00	0.17567E+00	0.71989E+00
0.13668E+04	0.62890E+00	0.27884E+00	0.17536E+00	0.71862E+00
0.13669E+04	0.62805E+00	0.27872E+00	0.17505E+00	0.71735E+00
0.13670E+04	0.62724E+00	0.27861E+00	0.17475E+00	0.71612E+00
0.13671E+04	0.62648E+00	0.27850E+00	0.17447E+00	0.71498E+00
0.13672E+04	0.62578E+00	0.27839E+00	0.17421E+00	0.71389E+00
0.13673E+04	0.62512E+00	0.27827E+00	0.17396E+00	0.71286E+00
0.13674E+04	0.62449E+00	0.27816E+00	0.17371E+00	0.71186E+00
0.13675E+04	0.62388E+00	0.27805E+00	0.17347E+00	0.71088E+00
0.13676E+04	0.62330E+00	0.27794E+00	0.17324E+00	0.70994E+00
0.13677E+04	0.62274E+00	0.27783E+00	0.17302E+00	0.70901E+00
0.13678E+04	0.62221E+00	0.27771E+00	0.17280E+00	0.70811E+00
0.13679E+04	0.62172E+00	0.27760E+00	0.17259E+00	0.70726E+00
0.13680E+04	0.62128E+00	0.27748E+00	0.17239E+00	0.70646E+00
0.13681E+04	0.62089E+00	0.27742E+00	0.17225E+00	0.70585E+00
0.13682E+04	0.62057E+00	0.27735E+00	0.17212E+00	0.70533E+00
0.13683E+04	0.62030E+00	0.27729E+00	0.17200E+00	0.70486E+00
0.13684E+04	0.62011E+00	0.27723E+00	0.17191E+00	0.70448E+00
0.13685E+04	0.61998E+00	0.27716E+00	0.17184E+00	0.70418E+00
0.13686E+04	0.61991E+00	0.27710E+00	0.17178E+00	0.70394E+00
0.13687E+04	0.61992E+00	0.27704E+00	0.17174E+00	0.70379E+00
0.13688E+04	0.62002E+00	0.27698E+00	0.17173E+00	0.70375E+00
0.13689E+04	0.62019E+00	0.27692E+00	0.17174E+00	0.70378E+00
0.13690E+04	0.62043E+00	0.27685E+00	0.17177E+00	0.70390E+00
0.13691E+04	0.62076E+00	0.27679E+00	0.17182E+00	0.70411E+00
0.13692E+04	0.62117E+00	0.27673E+00	0.17190E+00	0.70442E+00
0.13693E+04	0.62167E+00	0.27667E+00	0.17199E+00	0.70482E+00
0.13694E+04	0.62224E+00	0.27660E+00	0.17212E+00	0.70532E+00
0.13695E+04	0.62291E+00	0.27654E+00	0.17226E+00	0.70592E+00
0.13696E+04	0.62367E+00	0.27648E+00	0.17243E+00	0.70661E+00
0.13697E+04	0.62451E+00	0.27641E+00	0.17262E+00	0.70740E+00
0.13698E+04	0.62543E+00	0.27635E+00	0.17284E+00	0.70828E+00
0.13699E+04	0.62644E+00	0.27628E+00	0.17307E+00	0.70925E+00
0.13700E+04	0.62753E+00	0.27622E+00	0.17334E+00	0.71034E+00
0.13701E+04	0.62869E+00	0.27621E+00	0.17365E+00	0.71162E+00
0.13702E+04	0.62989E+00	0.27620E+00	0.17398E+00	0.71295E+00
0.13703E+04	0.63113E+00	0.27619E+00	0.17431E+00	0.71432E+00

0.13704E+04	0.63241E+00	0.27618E+00	0.17466E+00	0.71573E+00
0.13705E+04	0.63376E+00	0.27617E+00	0.17502E+00	0.71723E+00
0.13706E+04	0.63521E+00	0.27615E+00	0.17542E+00	0.71885E+00
0.13707E+04	0.63674E+00	0.27614E+00	0.17583E+00	0.72055E+00
0.13708E+04	0.63835E+00	0.27613E+00	0.17627E+00	0.72233E+00
0.13709E+04	0.64002E+00	0.27612E+00	0.17672E+00	0.72420E+00
0.13710E+04	0.64175E+00	0.27611E+00	0.17719E+00	0.72612E+00
0.13711E+04	0.64356E+00	0.27609E+00	0.17768E+00	0.72813E+00
0.13712E+04	0.64538E+00	0.27608E+00	0.17818E+00	0.73015E+00
0.13713E+04	0.64721E+00	0.27606E+00	0.17867E+00	0.73219E+00
0.13714E+04	0.64908E+00	0.27605E+00	0.17918E+00	0.73427E+00
0.13715E+04	0.65097E+00	0.27604E+00	0.17969E+00	0.73636E+00
0.13716E+04	0.65290E+00	0.27602E+00	0.18021E+00	0.73850E+00
0.13717E+04	0.65488E+00	0.27600E+00	0.18075E+00	0.74070E+00
0.13718E+04	0.65694E+00	0.27599E+00	0.18131E+00	0.74298E+00
0.13719E+04	0.65905E+00	0.27597E+00	0.18188E+00	0.74533E+00
0.13720E+04	0.66117E+00	0.27595E+00	0.18245E+00	0.74768E+00
0.13721E+04	0.66332E+00	0.27598E+00	0.18306E+00	0.75019E+00
0.13722E+04	0.66545E+00	0.27602E+00	0.18368E+00	0.75270E+00
0.13723E+04	0.66758E+00	0.27606E+00	0.18429E+00	0.75521E+00
0.13724E+04	0.66971E+00	0.27609E+00	0.18490E+00	0.75772E+00
0.13725E+04	0.67190E+00	0.27613E+00	0.18553E+00	0.76030E+00
0.13726E+04	0.67419E+00	0.27617E+00	0.18619E+00	0.76299E+00
0.13727E+04	0.67655E+00	0.27620E+00	0.18687E+00	0.76576E+00
0.13728E+04	0.67896E+00	0.27624E+00	0.18755E+00	0.76859E+00
0.13729E+04	0.68142E+00	0.27628E+00	0.18826E+00	0.77148E+00
0.13730E+04	0.68389E+00	0.27631E+00	0.18897E+00	0.77438E+00
0.13731E+04	0.68638E+00	0.27635E+00	0.18968E+00	0.77730E+00
0.13732E+04	0.68890E+00	0.27638E+00	0.19040E+00	0.78024E+00
0.13733E+04	0.69145E+00	0.27641E+00	0.19113E+00	0.78322E+00
0.13734E+04	0.69401E+00	0.27645E+00	0.19186E+00	0.78622E+00
0.13735E+04	0.69662E+00	0.27649E+00	0.19261E+00	0.78929E+00
0.13736E+04	0.69930E+00	0.27653E+00	0.19338E+00	0.79244E+00
0.13737E+04	0.70204E+00	0.27657E+00	0.19416E+00	0.79567E+00
0.13738E+04	0.70485E+00	0.27661E+00	0.19497E+00	0.79898E+00
0.13739E+04	0.70773E+00	0.27665E+00	0.19580E+00	0.80236E+00
0.13740E+04	0.71061E+00	0.27669E+00	0.19662E+00	0.80574E+00
0.13741E+04	0.71348E+00	0.27679E+00	0.19748E+00	0.80927E+00
0.13742E+04	0.71637E+00	0.27688E+00	0.19835E+00	0.81281E+00
0.13743E+04	0.71926E+00	0.27697E+00	0.19921E+00	0.81637E+00
0.13744E+04	0.72216E+00	0.27706E+00	0.20008E+00	0.81993E+00
0.13745E+04	0.72508E+00	0.27715E+00	0.20096E+00	0.82352E+00
0.13746E+04	0.72801E+00	0.27725E+00	0.20184E+00	0.82712E+00

0.13747E+04	0.73093E+00	0.27734E+00	0.20271E+00	0.83071E+00
0.13748E+04	0.73381E+00	0.27743E+00	0.20358E+00	0.83427E+00
0.13749E+04	0.73668E+00	0.27752E+00	0.20445E+00	0.83781E+00
0.13750E+04	0.73958E+00	0.27761E+00	0.20532E+00	0.84138E+00
0.13751E+04	0.74242E+00	0.27770E+00	0.20617E+00	0.84489E+00
0.13752E+04	0.74518E+00	0.27779E+00	0.20701E+00	0.84830E+00
0.13753E+04	0.74785E+00	0.27788E+00	0.20781E+00	0.85161E+00
0.13754E+04	0.75043E+00	0.27798E+00	0.20861E+00	0.85485E+00
0.13755E+04	0.75292E+00	0.27808E+00	0.20937E+00	0.85799E+00
0.13756E+04	0.75531E+00	0.27818E+00	0.21011E+00	0.86104E+00
0.13757E+04	0.75763E+00	0.27828E+00	0.21083E+00	0.86399E+00
0.13758E+04	0.75986E+00	0.27838E+00	0.21153E+00	0.86685E+00
0.13759E+04	0.76196E+00	0.27848E+00	0.21219E+00	0.86956E+00
0.13760E+04	0.76392E+00	0.27859E+00	0.21282E+00	0.87212E+00
0.13761E+04	0.76575E+00	0.27873E+00	0.21344E+00	0.87466E+00
0.13762E+04	0.76745E+00	0.27888E+00	0.21403E+00	0.87708E+00
0.13763E+04	0.76899E+00	0.27903E+00	0.21457E+00	0.87930E+00
0.13764E+04	0.77033E+00	0.27918E+00	0.21506E+00	0.88131E+00
0.13765E+04	0.77146E+00	0.27933E+00	0.21549E+00	0.88308E+00
0.13766E+04	0.77239E+00	0.27948E+00	0.21587E+00	0.88463E+00
0.13767E+04	0.77310E+00	0.27963E+00	0.21618E+00	0.88590E+00
0.13768E+04	0.77354E+00	0.27978E+00	0.21642E+00	0.88689E+00
0.13769E+04	0.77374E+00	0.27993E+00	0.21660E+00	0.88760E+00
0.13770E+04	0.77375E+00	0.28008E+00	0.21671E+00	0.88809E+00
0.13771E+04	0.77352E+00	0.28023E+00	0.21677E+00	0.88830E+00
0.13772E+04	0.77303E+00	0.28039E+00	0.21675E+00	0.88822E+00
0.13773E+04	0.77229E+00	0.28054E+00	0.21666E+00	0.88785E+00
0.13774E+04	0.77132E+00	0.28069E+00	0.21650E+00	0.88721E+00
0.13775E+04	0.77004E+00	0.28084E+00	0.21626E+00	0.88622E+00
0.13776E+04	0.76847E+00	0.28099E+00	0.21593E+00	0.88488E+00
0.13777E+04	0.76662E+00	0.28114E+00	0.21553E+00	0.88322E+00
0.13778E+04	0.76453E+00	0.28129E+00	0.21506E+00	0.88129E+00
0.13779E+04	0.76215E+00	0.28144E+00	0.21450E+00	0.87902E+00
0.13780E+04	0.75949E+00	0.28160E+00	0.21387E+00	0.87642E+00
0.13781E+04	0.75652E+00	0.28179E+00	0.21318E+00	0.87359E+00
0.13782E+04	0.75330E+00	0.28198E+00	0.21242E+00	0.87048E+00
0.13783E+04	0.74976E+00	0.28216E+00	0.21155E+00	0.86692E+00
0.13784E+04	0.74598E+00	0.28233E+00	0.21061E+00	0.86307E+00
0.13785E+04	0.74192E+00	0.28250E+00	0.20959E+00	0.85890E+00
0.13786E+04	0.73759E+00	0.28267E+00	0.20850E+00	0.85441E+00
0.13787E+04	0.73296E+00	0.28285E+00	0.20731E+00	0.84956E+00
0.13788E+04	0.72802E+00	0.28302E+00	0.20604E+00	0.84435E+00
0.13789E+04	0.72280E+00	0.28319E+00	0.20469E+00	0.83880E+00

0.13790E+04	0.71732E+00	0.28336E+00	0.20326E+00	0.83296E+00
0.13791E+04	0.71162E+00	0.28354E+00	0.20177E+00	0.82686E+00
0.13792E+04	0.70560E+00	0.28372E+00	0.20019E+00	0.82038E+00
0.13793E+04	0.69933E+00	0.28388E+00	0.19852E+00	0.81354E+00
0.13794E+04	0.69280E+00	0.28403E+00	0.19678E+00	0.80638E+00
0.13795E+04	0.68603E+00	0.28419E+00	0.19496E+00	0.79895E+00
0.13796E+04	0.67904E+00	0.28434E+00	0.19308E+00	0.79124E+00
0.13797E+04	0.67179E+00	0.28450E+00	0.19113E+00	0.78322E+00
0.13798E+04	0.66430E+00	0.28466E+00	0.18910E+00	0.77491E+00
0.13799E+04	0.65652E+00	0.28481E+00	0.18698E+00	0.76625E+00
0.13800E+04	0.64847E+00	0.28497E+00	0.18479E+00	0.75727E+00
0.13801E+04	0.64013E+00	0.28516E+00	0.18254E+00	0.74803E+00
0.13802E+04	0.63153E+00	0.28534E+00	0.18020E+00	0.73847E+00
0.13803E+04	0.62271E+00	0.28553E+00	0.17780E+00	0.72863E+00
0.13804E+04	0.61371E+00	0.28572E+00	0.17535E+00	0.71858E+00
0.13805E+04	0.60452E+00	0.28591E+00	0.17284E+00	0.70828E+00
0.13806E+04	0.59514E+00	0.28610E+00	0.17027E+00	0.69775E+00
0.13807E+04	0.58554E+00	0.28629E+00	0.16763E+00	0.68695E+00
0.13808E+04	0.57572E+00	0.28647E+00	0.16493E+00	0.67587E+00
0.13809E+04	0.56572E+00	0.28666E+00	0.16217E+00	0.66456E+00
0.13810E+04	0.55552E+00	0.28685E+00	0.15935E+00	0.65301E+00
0.13811E+04	0.54521E+00	0.28704E+00	0.15650E+00	0.64131E+00
0.13812E+04	0.53481E+00	0.28721E+00	0.15360E+00	0.62945E+00
0.13813E+04	0.52433E+00	0.28737E+00	0.15068E+00	0.61747E+00
0.13814E+04	0.51383E+00	0.28753E+00	0.14774E+00	0.60544E+00
0.13815E+04	0.50329E+00	0.28770E+00	0.14479E+00	0.59336E+00
0.13816E+04	0.49273E+00	0.28786E+00	0.14184E+00	0.58124E+00
0.13817E+04	0.48216E+00	0.28803E+00	0.13887E+00	0.56910E+00
0.13818E+04	0.47157E+00	0.28819E+00	0.13590E+00	0.55691E+00
0.13819E+04	0.46093E+00	0.28835E+00	0.13291E+00	0.54466E+00
0.13820E+04	0.45028E+00	0.28851E+00	0.12991E+00	0.53237E+00
0.13821E+04	0.43965E+00	0.28869E+00	0.12692E+00	0.52011E+00
0.13822E+04	0.42906E+00	0.28886E+00	0.12394E+00	0.50789E+00
0.13823E+04	0.41851E+00	0.28903E+00	0.12096E+00	0.49570E+00
0.13824E+04	0.40800E+00	0.28920E+00	0.11799E+00	0.48353E+00
0.13825E+04	0.39754E+00	0.28937E+00	0.11504E+00	0.47141E+00
0.13826E+04	0.38714E+00	0.28954E+00	0.11209E+00	0.45935E+00
0.13827E+04	0.37680E+00	0.28971E+00	0.10916E+00	0.44734E+00
0.13828E+04	0.36656E+00	0.28988E+00	0.10626E+00	0.43545E+00
0.13829E+04	0.35644E+00	0.29005E+00	0.10339E+00	0.42367E+00
0.13830E+04	0.34643E+00	0.29022E+00	0.10054E+00	0.41201E+00
0.13831E+04	0.33650E+00	0.29039E+00	0.97717E-01	0.40044E+00
0.13832E+04	0.32668E+00	0.29056E+00	0.94920E-01	0.38898E+00

0.13833E+04	0.31701E+00	0.29073E+00	0.92164E-01	0.37768E+00
0.13834E+04	0.30751E+00	0.29091E+00	0.89456E-01	0.36659E+00
0.13835E+04	0.29816E+00	0.29108E+00	0.86789E-01	0.35566E+00
0.13836E+04	0.28901E+00	0.29125E+00	0.84175E-01	0.34494E+00
0.13837E+04	0.28004E+00	0.29142E+00	0.81610E-01	0.33443E+00
0.13838E+04	0.27125E+00	0.29159E+00	0.79095E-01	0.32413E+00
0.13839E+04	0.26263E+00	0.29176E+00	0.76625E-01	0.31401E+00
0.13840E+04	0.25420E+00	0.29193E+00	0.74210E-01	0.30411E+00
0.13841E+04	0.24599E+00	0.29210E+00	0.71853E-01	0.29445E+00
0.13842E+04	0.23796E+00	0.29226E+00	0.69546E-01	0.28500E+00
0.13843E+04	0.23006E+00	0.29243E+00	0.67277E-01	0.27570E+00
0.13844E+04	0.22235E+00	0.29259E+00	0.65058E-01	0.26660E+00
0.13845E+04	0.21482E+00	0.29276E+00	0.62889E-01	0.25772E+00
0.13846E+04	0.20750E+00	0.29293E+00	0.60783E-01	0.24908E+00
0.13847E+04	0.20037E+00	0.29309E+00	0.58725E-01	0.24065E+00
0.13848E+04	0.19342E+00	0.29326E+00	0.56723E-01	0.23245E+00
0.13849E+04	0.18670E+00	0.29342E+00	0.54782E-01	0.22449E+00
0.13850E+04	0.18016E+00	0.29359E+00	0.52892E-01	0.21675E+00
0.13851E+04	0.17375E+00	0.29374E+00	0.51037E-01	0.20915E+00
0.13852E+04	0.16749E+00	0.29390E+00	0.49227E-01	0.20173E+00
0.13853E+04	0.16140E+00	0.29406E+00	0.47462E-01	0.19450E+00
0.13854E+04	0.15549E+00	0.29422E+00	0.45747E-01	0.18747E+00
0.13855E+04	0.14972E+00	0.29438E+00	0.44074E-01	0.18061E+00
0.13856E+04	0.14413E+00	0.29454E+00	0.42452E-01	0.17397E+00
0.13857E+04	0.13873E+00	0.29470E+00	0.40883E-01	0.16754E+00
0.13858E+04	0.13351E+00	0.29486E+00	0.39366E-01	0.16132E+00
0.13859E+04	0.12842E+00	0.29501E+00	0.37885E-01	0.15525E+00
0.13860E+04	0.12349E+00	0.29517E+00	0.36450E-01	0.14937E+00
0.13861E+04	0.11871E+00	0.29530E+00	0.35055E-01	0.14365E+00
0.13862E+04	0.11411E+00	0.29544E+00	0.33712E-01	0.13815E+00
0.13863E+04	0.10964E+00	0.29557E+00	0.32405E-01	0.13279E+00
0.13864E+04	0.10537E+00	0.29570E+00	0.31157E-01	0.12768E+00
0.13865E+04	0.10124E+00	0.29583E+00	0.29950E-01	0.12273E+00
0.13866E+04	0.97285E-01	0.29596E+00	0.28793E-01	0.11799E+00
0.13867E+04	0.93481E-01	0.29609E+00	0.27679E-01	0.11343E+00
0.13868E+04	0.89823E-01	0.29622E+00	0.26608E-01	0.10904E+00
0.13869E+04	0.86333E-01	0.29636E+00	0.25585E-01	0.10485E+00
0.13870E+04	0.83049E-01	0.29648E+00	0.24623E-01	0.10090E+00
0.13871E+04	0.79915E-01	0.29661E+00	0.23703E-01	0.97134E-01
0.13872E+04	0.76860E-01	0.29673E+00	0.22807E-01	0.93460E-01
0.13873E+04	0.73892E-01	0.29685E+00	0.21935E-01	0.89888E-01
0.13874E+04	0.71021E-01	0.29697E+00	0.21091E-01	0.86432E-01
0.13875E+04	0.68275E-01	0.29710E+00	0.20284E-01	0.83124E-01

0.13876E+04	0.65631E-01	0.29722E+00	0.19507E-01	0.79938E-01
0.13877E+04	0.63101E-01	0.29734E+00	0.18763E-01	0.76888E-01
0.13878E+04	0.60685E-01	0.29747E+00	0.18052E-01	0.73975E-01
0.13879E+04	0.58381E-01	0.29759E+00	0.17373E-01	0.71195E-01
0.13880E+04	0.56136E-01	0.29771E+00	0.16712E-01	0.68486E-01
0.13881E+04	0.53914E-01	0.29779E+00	0.16055E-01	0.65793E-01
0.13882E+04	0.51801E-01	0.29787E+00	0.15430E-01	0.63230E-01
0.13883E+04	0.49760E-01	0.29795E+00	0.14826E-01	0.60756E-01
0.13884E+04	0.47825E-01	0.29802E+00	0.14253E-01	0.58408E-01
0.13885E+04	0.45942E-01	0.29810E+00	0.13696E-01	0.56124E-01
0.13886E+04	0.44124E-01	0.29818E+00	0.13157E-01	0.53916E-01
0.13887E+04	0.42353E-01	0.29826E+00	0.12632E-01	0.51766E-01
0.13888E+04	0.40646E-01	0.29834E+00	0.12126E-01	0.49692E-01
0.13889E+04	0.39008E-01	0.29841E+00	0.11640E-01	0.47702E-01
0.13890E+04	0.37438E-01	0.29848E+00	0.11175E-01	0.45793E-01
0.13891E+04	0.35953E-01	0.29856E+00	0.10734E-01	0.43988E-01
0.13892E+04	0.34544E-01	0.29863E+00	0.10316E-01	0.42273E-01
0.13893E+04	0.33215E-01	0.29870E+00	0.99213E-02	0.40657E-01
0.13894E+04	0.31971E-01	0.29877E+00	0.95518E-02	0.39143E-01
0.13895E+04	0.30752E-01	0.29884E+00	0.91899E-02	0.37660E-01
0.13896E+04	0.29594E-01	0.29891E+00	0.88459E-02	0.36250E-01
0.13897E+04	0.28473E-01	0.29898E+00	0.85129E-02	0.34886E-01
0.13898E+04	0.27377E-01	0.29905E+00	0.81871E-02	0.33550E-01
0.13899E+04	0.26307E-01	0.29912E+00	0.78690E-02	0.32247E-01
0.13900E+04	0.25288E-01	0.29919E+00	0.75660E-02	0.31005E-01
0.13901E+04	0.24311E-01	0.29921E+00	0.72740E-02	0.29809E-01
0.13902E+04	0.23398E-01	0.29922E+00	0.70011E-02	0.28690E-01
0.13903E+04	0.22546E-01	0.29923E+00	0.67465E-02	0.27647E-01
0.13904E+04	0.21719E-01	0.29924E+00	0.64992E-02	0.26633E-01
0.13905E+04	0.20935E-01	0.29925E+00	0.62650E-02	0.25674E-01
0.13906E+04	0.20213E-01	0.29926E+00	0.60489E-02	0.24788E-01
0.13907E+04	0.19540E-01	0.29928E+00	0.58479E-02	0.23964E-01
0.13908E+04	0.18902E-01	0.29929E+00	0.56572E-02	0.23183E-01
0.13909E+04	0.18264E-01	0.29931E+00	0.54667E-02	0.22402E-01
0.13910E+04	0.17629E-01	0.29934E+00	0.52769E-02	0.21624E-01
0.13911E+04	0.16997E-01	0.29936E+00	0.50882E-02	0.20851E-01
0.13912E+04	0.16391E-01	0.29938E+00	0.49071E-02	0.20109E-01
0.13913E+04	0.15828E-01	0.29940E+00	0.47389E-02	0.19420E-01
0.13914E+04	0.15313E-01	0.29942E+00	0.45851E-02	0.18789E-01
0.13915E+04	0.14831E-01	0.29944E+00	0.44410E-02	0.18199E-01
0.13916E+04	0.14364E-01	0.29947E+00	0.43015E-02	0.17627E-01
0.13917E+04	0.13900E-01	0.29949E+00	0.41629E-02	0.17060E-01
0.13918E+04	0.13437E-01	0.29951E+00	0.40246E-02	0.16493E-01

0.13919E+04	0.12980E-01	0.29953E+00	0.38877E-02	0.15932E-01
0.13920E+04	0.12524E-01	0.29955E+00	0.37514E-02	0.15373E-01
0.13921E+04	0.12070E-01	0.29950E+00	0.36149E-02	0.14813E-01
0.13922E+04	0.11640E-01	0.29944E+00	0.34856E-02	0.14284E-01
0.13923E+04	0.11261E-01	0.29939E+00	0.33714E-02	0.13816E-01
0.13924E+04	0.10923E-01	0.29934E+00	0.32696E-02	0.13399E-01
0.13925E+04	0.10619E-01	0.29929E+00	0.31781E-02	0.13024E-01
0.13926E+04	0.10345E-01	0.29924E+00	0.30957E-02	0.12686E-01
0.13927E+04	0.10083E-01	0.29919E+00	0.30166E-02	0.12362E-01
0.13928E+04	0.98251E-02	0.29914E+00	0.29390E-02	0.12044E-01
0.13929E+04	0.95693E-02	0.29909E+00	0.28621E-02	0.11729E-01
0.13930E+04	0.93196E-02	0.29904E+00	0.27869E-02	0.11421E-01
0.13931E+04	0.90773E-02	0.29899E+00	0.27140E-02	0.11122E-01
0.13932E+04	0.88391E-02	0.29894E+00	0.26424E-02	0.10828E-01
0.13933E+04	0.86068E-02	0.29889E+00	0.25725E-02	0.10542E-01
0.13934E+04	0.83776E-02	0.29884E+00	0.25036E-02	0.10260E-01
0.13935E+04	0.81489E-02	0.29879E+00	0.24348E-02	0.99779E-02
0.13936E+04	0.79253E-02	0.29874E+00	0.23676E-02	0.97024E-02
0.13937E+04	0.77159E-02	0.29870E+00	0.23047E-02	0.94445E-02
0.13938E+04	0.75181E-02	0.29865E+00	0.22453E-02	0.92009E-02
0.13939E+04	0.73204E-02	0.29860E+00	0.21858E-02	0.89575E-02
0.13940E+04	0.71248E-02	0.29855E+00	0.21271E-02	0.87167E-02
0.13941E+04	0.69295E-02	0.29842E+00	0.20679E-02	0.84741E-02
0.13942E+04	0.67343E-02	0.29829E+00	0.20087E-02	0.82317E-02
0.13943E+04	0.65414E-02	0.29815E+00	0.19503E-02	0.79924E-02
0.13944E+04	0.63511E-02	0.29802E+00	0.18928E-02	0.77565E-02
0.13945E+04	0.61668E-02	0.29789E+00	0.18370E-02	0.75281E-02
0.13946E+04	0.59865E-02	0.29776E+00	0.17825E-02	0.73048E-02
0.13947E+04	0.58179E-02	0.29765E+00	0.17317E-02	0.70963E-02
0.13948E+04	0.56496E-02	0.29754E+00	0.16810E-02	0.68885E-02
0.13949E+04	0.54867E-02	0.29743E+00	0.16319E-02	0.66874E-02
0.13950E+04	0.53283E-02	0.29732E+00	0.15842E-02	0.64919E-02
0.13951E+04	0.51716E-02	0.29721E+00	0.15370E-02	0.62987E-02
0.13952E+04	0.50151E-02	0.29710E+00	0.14900E-02	0.61059E-02
0.13953E+04	0.48605E-02	0.29699E+00	0.14435E-02	0.59155E-02
0.13954E+04	0.47091E-02	0.29688E+00	0.13980E-02	0.57291E-02
0.13955E+04	0.45602E-02	0.29677E+00	0.13533E-02	0.55460E-02
0.13956E+04	0.44134E-02	0.29666E+00	0.13093E-02	0.53654E-02
0.13957E+04	0.42755E-02	0.29656E+00	0.12679E-02	0.51958E-02
0.13958E+04	0.41397E-02	0.29645E+00	0.12272E-02	0.50290E-02
0.13959E+04	0.40094E-02	0.29634E+00	0.11881E-02	0.48689E-02
0.13960E+04	0.38839E-02	0.29623E+00	0.11505E-02	0.47148E-02
0.13961E+04	0.37618E-02	0.29605E+00	0.11137E-02	0.45638E-02

0.13962E+04	0.36409E-02	0.29585E+00	0.10772E-02	0.44142E-02
0.13963E+04	0.35214E-02	0.29566E+00	0.10411E-02	0.42666E-02
0.13964E+04	0.34119E-02	0.29547E+00	0.10081E-02	0.41312E-02
0.13965E+04	0.33045E-02	0.29528E+00	0.97575E-03	0.39986E-02
0.13966E+04	0.32000E-02	0.29510E+00	0.94430E-03	0.38697E-02
0.13967E+04	0.30964E-02	0.29493E+00	0.91321E-03	0.37423E-02
0.13968E+04	0.29967E-02	0.29476E+00	0.88332E-03	0.36198E-02
0.13969E+04	0.28993E-02	0.29459E+00	0.85413E-03	0.35002E-02
0.13970E+04	0.28025E-02	0.29443E+00	0.82513E-03	0.33813E-02
0.13971E+04	0.27058E-02	0.29426E+00	0.79621E-03	0.32628E-02
0.13972E+04	0.26107E-02	0.29409E+00	0.76780E-03	0.31464E-02
0.13973E+04	0.25167E-02	0.29393E+00	0.73973E-03	0.30314E-02
0.13974E+04	0.24228E-02	0.29376E+00	0.71171E-03	0.29165E-02
0.13975E+04	0.23308E-02	0.29359E+00	0.68430E-03	0.28042E-02
0.13976E+04	0.22389E-02	0.29343E+00	0.65694E-03	0.26921E-02
0.13977E+04	0.21476E-02	0.29326E+00	0.62979E-03	0.25809E-02
0.13978E+04	0.20573E-02	0.29309E+00	0.60297E-03	0.24709E-02
0.13979E+04	0.19672E-02	0.29293E+00	0.57625E-03	0.23615E-02
0.13980E+04	0.18776E-02	0.29275E+00	0.54967E-03	0.22525E-02
0.13981E+04	0.17881E-02	0.29254E+00	0.52310E-03	0.21437E-02
0.13982E+04	0.16999E-02	0.29233E+00	0.49695E-03	0.20365E-02
0.13983E+04	0.16121E-02	0.29212E+00	0.47095E-03	0.19299E-02
0.13984E+04	0.15250E-02	0.29192E+00	0.44517E-03	0.18243E-02
0.13985E+04	0.14450E-02	0.29171E+00	0.42154E-03	0.17274E-02
0.13986E+04	0.13655E-02	0.29153E+00	0.39808E-03	0.16313E-02
0.13987E+04	0.12862E-02	0.29135E+00	0.37473E-03	0.15356E-02
0.13988E+04	0.12077E-02	0.29117E+00	0.35163E-03	0.14410E-02
0.13989E+04	0.11299E-02	0.29099E+00	0.32878E-03	0.13473E-02
0.13990E+04	0.10531E-02	0.29080E+00	0.30623E-03	0.12549E-02
0.13991E+04	0.97752E-03	0.29062E+00	0.28409E-03	0.11642E-02
0.13992E+04	0.90483E-03	0.29044E+00	0.26280E-03	0.10769E-02
0.13993E+04	0.83270E-03	0.29026E+00	0.24170E-03	0.99048E-03
0.13994E+04	0.76406E-03	0.29008E+00	0.22164E-03	0.90827E-03
0.13995E+04	0.69702E-03	0.28990E+00	0.20207E-03	0.82806E-03
0.13996E+04	0.63047E-03	0.28972E+00	0.18266E-03	0.74853E-03
0.13997E+04	0.56717E-03	0.28954E+00	0.16422E-03	0.67295E-03
0.13998E+04	0.50813E-03	0.28936E+00	0.14703E-03	0.60253E-03
0.13999E+04	0.45094E-03	0.28918E+00	0.13040E-03	0.53438E-03
0.14000E+04	0.39728E-03	0.28899E+00	0.11481E-03	0.47049E-03
0.14001E+04	0.34435E-03	0.28874E+00	0.99428E-04	0.40745E-03
0.14002E+04	0.29677E-03	0.28850E+00	0.85615E-04	0.35085E-03
0.14003E+04	0.25051E-03	0.28825E+00	0.72210E-04	0.29591E-03
0.14004E+04	0.20647E-03	0.28800E+00	0.59463E-04	0.24367E-03

0.14005E+04	0.16879E-03	0.28776E+00	0.48571E-04	0.19904E-03
0.14006E+04	0.13209E-03	0.28751E+00	0.37978E-04	0.15563E-03
0.14007E+04	0.96662E-04	0.28727E+00	0.27768E-04	0.11379E-03
0.14008E+04	0.62133E-04	0.28702E+00	0.17834E-04	0.73082E-04
0.14009E+04	0.32459E-04	0.28678E+00	0.93087E-05	0.38146E-04
0.14010E+04	0.37839E-05	0.28654E+00	0.10842E-05	0.44431E-05
0.14011E+04	0.00000E+00	0.28629E+00	0.00000E+00	0.00000E+00
Channel 12				
Wavenumber	HIRS Filter Transmittance	Optical Element Transmittance	Product of the HIRS Filter and Optical Element Transmittances	Normalized Value of Column 4
0.14887E+04	0.00000E+00	0.24194E+00	0.00000E+00	0.00000E+00
0.14888E+04	0.20100E-04	0.24195E+00	0.48632E-05	0.30719E-04
0.14889E+04	0.85200E-04	0.24195E+00	0.20615E-04	0.13021E-03
0.14890E+04	0.14057E-03	0.24196E+00	0.34014E-04	0.21485E-03
0.14891E+04	0.18867E-03	0.24197E+00	0.45653E-04	0.28837E-03
0.14892E+04	0.23379E-03	0.24197E+00	0.56571E-04	0.35733E-03
0.14893E+04	0.27758E-03	0.24197E+00	0.67168E-04	0.42427E-03
0.14894E+04	0.33291E-03	0.24198E+00	0.80558E-04	0.50885E-03
0.14895E+04	0.39834E-03	0.24198E+00	0.96389E-04	0.60885E-03
0.14896E+04	0.48217E-03	0.24198E+00	0.11668E-03	0.73699E-03
0.14897E+04	0.58004E-03	0.24198E+00	0.14036E-03	0.88659E-03
0.14898E+04	0.65753E-03	0.24198E+00	0.15911E-03	0.10050E-02
0.14899E+04	0.71909E-03	0.24199E+00	0.17401E-03	0.10991E-02
0.14900E+04	0.77579E-03	0.24199E+00	0.18773E-03	0.11858E-02
0.14901E+04	0.82964E-03	0.24193E+00	0.20072E-03	0.12678E-02
0.14902E+04	0.88506E-03	0.24188E+00	0.21408E-03	0.13522E-02
0.14903E+04	0.94302E-03	0.24182E+00	0.22804E-03	0.14404E-02
0.14904E+04	0.10069E-02	0.24177E+00	0.24344E-03	0.15377E-02
0.14905E+04	0.10771E-02	0.24171E+00	0.26034E-03	0.16445E-02
0.14906E+04	0.11624E-02	0.24165E+00	0.28090E-03	0.17743E-02
0.14907E+04	0.12609E-02	0.24160E+00	0.30464E-03	0.19243E-02
0.14908E+04	0.13792E-02	0.24154E+00	0.33313E-03	0.21042E-02
0.14909E+04	0.15130E-02	0.24149E+00	0.36536E-03	0.23078E-02
0.14910E+04	0.16473E-02	0.24143E+00	0.39771E-03	0.25122E-02
0.14911E+04	0.17816E-02	0.24138E+00	0.43003E-03	0.27163E-02
0.14912E+04	0.19098E-02	0.24133E+00	0.46089E-03	0.29112E-02
0.14913E+04	0.20329E-02	0.24129E+00	0.49051E-03	0.30983E-02
0.14914E+04	0.21578E-02	0.24124E+00	0.52055E-03	0.32881E-02
0.14915E+04	0.22839E-02	0.24120E+00	0.55087E-03	0.34796E-02
0.14916E+04	0.24143E-02	0.24115E+00	0.58223E-03	0.36777E-02
0.14917E+04	0.25477E-02	0.24111E+00	0.61428E-03	0.38801E-02

0.14918E+04	0.26833E-02	0.24106E+00	0.64685E-03	0.40859E-02
0.14919E+04	0.28198E-02	0.24102E+00	0.67962E-03	0.42929E-02
0.14920E+04	0.29570E-02	0.24097E+00	0.71257E-03	0.45010E-02
0.14921E+04	0.30936E-02	0.24087E+00	0.74515E-03	0.47068E-02
0.14922E+04	0.32152E-02	0.24077E+00	0.77412E-03	0.48898E-02
0.14923E+04	0.33244E-02	0.24066E+00	0.80006E-03	0.50537E-02
0.14924E+04	0.34335E-02	0.24056E+00	0.82597E-03	0.52173E-02
0.14925E+04	0.35420E-02	0.24046E+00	0.85170E-03	0.53798E-02
0.14926E+04	0.36487E-02	0.24035E+00	0.87697E-03	0.55395E-02
0.14927E+04	0.37535E-02	0.24025E+00	0.90180E-03	0.56963E-02
0.14928E+04	0.38738E-02	0.24015E+00	0.93030E-03	0.58763E-02
0.14929E+04	0.40049E-02	0.24005E+00	0.96137E-03	0.60725E-02
0.14930E+04	0.41200E-02	0.23994E+00	0.98857E-03	0.62444E-02
0.14931E+04	0.42214E-02	0.23987E+00	0.10126E-02	0.63960E-02
0.14932E+04	0.43129E-02	0.23979E+00	0.10342E-02	0.65326E-02
0.14933E+04	0.43962E-02	0.23972E+00	0.10539E-02	0.66568E-02
0.14934E+04	0.44747E-02	0.23964E+00	0.10723E-02	0.67735E-02
0.14935E+04	0.45498E-02	0.23957E+00	0.10900E-02	0.68849E-02
0.14936E+04	0.46457E-02	0.23949E+00	0.11126E-02	0.70279E-02
0.14937E+04	0.47579E-02	0.23942E+00	0.11391E-02	0.71954E-02
0.14938E+04	0.48702E-02	0.23934E+00	0.11657E-02	0.73630E-02
0.14939E+04	0.49822E-02	0.23927E+00	0.11921E-02	0.75299E-02
0.14940E+04	0.50913E-02	0.23919E+00	0.12178E-02	0.76923E-02
0.14941E+04	0.51979E-02	0.23907E+00	0.12426E-02	0.78493E-02
0.14942E+04	0.53119E-02	0.23893E+00	0.12692E-02	0.80169E-02
0.14943E+04	0.54316E-02	0.23880E+00	0.12971E-02	0.81930E-02
0.14944E+04	0.55550E-02	0.23867E+00	0.13258E-02	0.83746E-02
0.14945E+04	0.56815E-02	0.23854E+00	0.13552E-02	0.85605E-02
0.14946E+04	0.57934E-02	0.23840E+00	0.13812E-02	0.87242E-02
0.14947E+04	0.58949E-02	0.23827E+00	0.14046E-02	0.88722E-02
0.14948E+04	0.59931E-02	0.23814E+00	0.14272E-02	0.90151E-02
0.14949E+04	0.60914E-02	0.23801E+00	0.14498E-02	0.91578E-02
0.14950E+04	0.62333E-02	0.23789E+00	0.14828E-02	0.93665E-02
0.14951E+04	0.64116E-02	0.23778E+00	0.15246E-02	0.96300E-02
0.14952E+04	0.66148E-02	0.23767E+00	0.15722E-02	0.99307E-02
0.14953E+04	0.68388E-02	0.23756E+00	0.16246E-02	0.10262E-01
0.14954E+04	0.70753E-02	0.23745E+00	0.16800E-02	0.10612E-01
0.14955E+04	0.73228E-02	0.23734E+00	0.17380E-02	0.10978E-01
0.14956E+04	0.75707E-02	0.23723E+00	0.17960E-02	0.11345E-01
0.14957E+04	0.78212E-02	0.23712E+00	0.18546E-02	0.11715E-01
0.14958E+04	0.80896E-02	0.23701E+00	0.19173E-02	0.12111E-01
0.14959E+04	0.83750E-02	0.23690E+00	0.19841E-02	0.12533E-01
0.14960E+04	0.86653E-02	0.23679E+00	0.20519E-02	0.12961E-01

0.14961E+04	0.89638E-02	0.23663E+00	0.21211E-02	0.13398E-01
0.14962E+04	0.93014E-02	0.23647E+00	0.21995E-02	0.13893E-01
0.14963E+04	0.96740E-02	0.23631E+00	0.22860E-02	0.14440E-01
0.14964E+04	0.10062E-01	0.23614E+00	0.23760E-02	0.15008E-01
0.14965E+04	0.10470E-01	0.23598E+00	0.24707E-02	0.15606E-01
0.14966E+04	0.10890E-01	0.23582E+00	0.25681E-02	0.16221E-01
0.14967E+04	0.11308E-01	0.23565E+00	0.26649E-02	0.16833E-01
0.14968E+04	0.11734E-01	0.23549E+00	0.27632E-02	0.17454E-01
0.14969E+04	0.12180E-01	0.23531E+00	0.28660E-02	0.18104E-01
0.14970E+04	0.12652E-01	0.23512E+00	0.29748E-02	0.18791E-01
0.14971E+04	0.13149E-01	0.23491E+00	0.30888E-02	0.19511E-01
0.14972E+04	0.13677E-01	0.23470E+00	0.32099E-02	0.20275E-01
0.14973E+04	0.14232E-01	0.23448E+00	0.33372E-02	0.21080E-01
0.14974E+04	0.14812E-01	0.23427E+00	0.34701E-02	0.21919E-01
0.14975E+04	0.15419E-01	0.23406E+00	0.36091E-02	0.22797E-01
0.14976E+04	0.16065E-01	0.23385E+00	0.37569E-02	0.23731E-01
0.14977E+04	0.16736E-01	0.23364E+00	0.39102E-02	0.24699E-01
0.14978E+04	0.17422E-01	0.23343E+00	0.40669E-02	0.25689E-01
0.14979E+04	0.18123E-01	0.23322E+00	0.42266E-02	0.26698E-01
0.14980E+04	0.18846E-01	0.23301E+00	0.43913E-02	0.27738E-01
0.14981E+04	0.19597E-01	0.23276E+00	0.45614E-02	0.28812E-01
0.14982E+04	0.20383E-01	0.23251E+00	0.47393E-02	0.29936E-01
0.14983E+04	0.21191E-01	0.23226E+00	0.49217E-02	0.31089E-01
0.14984E+04	0.22033E-01	0.23201E+00	0.51119E-02	0.32290E-01
0.14985E+04	0.22923E-01	0.23176E+00	0.53126E-02	0.33558E-01
0.14986E+04	0.23860E-01	0.23151E+00	0.55237E-02	0.34891E-01
0.14987E+04	0.24856E-01	0.23126E+00	0.57480E-02	0.36308E-01
0.14988E+04	0.25919E-01	0.23099E+00	0.59870E-02	0.37818E-01
0.14989E+04	0.27027E-01	0.23068E+00	0.62345E-02	0.39381E-01
0.14990E+04	0.28183E-01	0.23037E+00	0.64924E-02	0.41010E-01
0.14991E+04	0.29381E-01	0.23006E+00	0.67594E-02	0.42696E-01
0.14992E+04	0.30613E-01	0.22975E+00	0.70334E-02	0.44427E-01
0.14993E+04	0.31887E-01	0.22944E+00	0.73161E-02	0.46213E-01
0.14994E+04	0.33206E-01	0.22913E+00	0.76085E-02	0.48060E-01
0.14995E+04	0.34584E-01	0.22882E+00	0.79136E-02	0.49987E-01
0.14996E+04	0.36020E-01	0.22851E+00	0.82309E-02	0.51991E-01
0.14997E+04	0.37523E-01	0.22820E+00	0.85628E-02	0.54088E-01
0.14998E+04	0.39106E-01	0.22790E+00	0.89121E-02	0.56294E-01
0.14999E+04	0.40770E-01	0.22759E+00	0.92788E-02	0.58610E-01
0.15000E+04	0.42523E-01	0.22728E+00	0.96644E-02	0.61046E-01
0.15001E+04	0.44351E-01	0.22694E+00	0.10065E-01	0.63577E-01
0.15002E+04	0.46289E-01	0.22661E+00	0.10489E-01	0.66257E-01
0.15003E+04	0.48357E-01	0.22627E+00	0.10942E-01	0.69115E-01

0.15004E+04	0.50549E-01	0.22593E+00	0.11421E-01	0.72139E-01
0.15005E+04	0.52864E-01	0.22560E+00	0.11926E-01	0.75333E-01
0.15006E+04	0.55289E-01	0.22527E+00	0.12455E-01	0.78671E-01
0.15007E+04	0.57816E-01	0.22493E+00	0.13005E-01	0.82145E-01
0.15008E+04	0.60449E-01	0.22458E+00	0.13576E-01	0.85751E-01
0.15009E+04	0.63180E-01	0.22422E+00	0.14166E-01	0.89484E-01
0.15010E+04	0.66015E-01	0.22387E+00	0.14779E-01	0.93350E-01
0.15011E+04	0.68995E-01	0.22351E+00	0.15421E-01	0.97410E-01
0.15012E+04	0.72114E-01	0.22316E+00	0.16093E-01	0.10165E+00
0.15013E+04	0.75379E-01	0.22281E+00	0.16795E-01	0.10609E+00
0.15014E+04	0.78810E-01	0.22246E+00	0.17532E-01	0.11074E+00
0.15015E+04	0.82415E-01	0.22211E+00	0.18305E-01	0.11562E+00
0.15016E+04	0.86184E-01	0.22176E+00	0.19112E-01	0.12072E+00
0.15017E+04	0.90130E-01	0.22141E+00	0.19955E-01	0.12605E+00
0.15018E+04	0.94239E-01	0.22105E+00	0.20832E-01	0.13159E+00
0.15019E+04	0.98517E-01	0.22071E+00	0.21743E-01	0.13734E+00
0.15020E+04	0.10296E+00	0.22036E+00	0.22688E-01	0.14331E+00
0.15021E+04	0.10757E+00	0.21999E+00	0.23664E-01	0.14948E+00
0.15022E+04	0.11239E+00	0.21963E+00	0.24684E-01	0.15592E+00
0.15023E+04	0.11743E+00	0.21927E+00	0.25749E-01	0.16265E+00
0.15024E+04	0.12270E+00	0.21891E+00	0.26859E-01	0.16966E+00
0.15025E+04	0.12819E+00	0.21854E+00	0.28015E-01	0.17696E+00
0.15026E+04	0.13390E+00	0.21818E+00	0.29214E-01	0.18453E+00
0.15027E+04	0.13982E+00	0.21783E+00	0.30457E-01	0.19239E+00
0.15028E+04	0.14595E+00	0.21749E+00	0.31743E-01	0.20050E+00
0.15029E+04	0.15228E+00	0.21715E+00	0.33069E-01	0.20888E+00
0.15030E+04	0.15879E+00	0.21681E+00	0.34428E-01	0.21747E+00
0.15031E+04	0.16549E+00	0.21648E+00	0.35824E-01	0.22628E+00
0.15032E+04	0.17235E+00	0.21614E+00	0.37250E-01	0.23530E+00
0.15033E+04	0.17938E+00	0.21580E+00	0.38711E-01	0.24452E+00
0.15034E+04	0.18662E+00	0.21546E+00	0.40210E-01	0.25399E+00
0.15035E+04	0.19408E+00	0.21513E+00	0.41751E-01	0.26372E+00
0.15036E+04	0.20176E+00	0.21479E+00	0.43336E-01	0.27373E+00
0.15037E+04	0.20965E+00	0.21446E+00	0.44962E-01	0.28400E+00
0.15038E+04	0.21774E+00	0.21412E+00	0.46622E-01	0.29449E+00
0.15039E+04	0.22601E+00	0.21379E+00	0.48319E-01	0.30521E+00
0.15040E+04	0.23448E+00	0.21345E+00	0.50049E-01	0.31614E+00
0.15041E+04	0.24310E+00	0.21311E+00	0.51808E-01	0.32725E+00
0.15042E+04	0.25188E+00	0.21277E+00	0.53594E-01	0.33853E+00
0.15043E+04	0.26083E+00	0.21244E+00	0.55411E-01	0.35000E+00
0.15044E+04	0.26994E+00	0.21210E+00	0.57254E-01	0.36165E+00
0.15045E+04	0.27920E+00	0.21176E+00	0.59124E-01	0.37346E+00
0.15046E+04	0.28861E+00	0.21143E+00	0.61022E-01	0.38545E+00

0.15047E+04	0.29816E+00	0.21113E+00	0.62952E-01	0.39764E+00
0.15048E+04	0.30787E+00	0.21084E+00	0.64910E-01	0.41001E+00
0.15049E+04	0.31770E+00	0.21054E+00	0.66888E-01	0.42250E+00
0.15050E+04	0.32764E+00	0.21024E+00	0.68883E-01	0.43511E+00
0.15051E+04	0.33770E+00	0.20994E+00	0.70897E-01	0.44783E+00
0.15052E+04	0.34783E+00	0.20965E+00	0.72922E-01	0.46061E+00
0.15053E+04	0.35804E+00	0.20935E+00	0.74955E-01	0.47346E+00
0.15054E+04	0.36830E+00	0.20905E+00	0.76995E-01	0.48634E+00
0.15055E+04	0.37861E+00	0.20876E+00	0.79036E-01	0.49924E+00
0.15056E+04	0.38892E+00	0.20846E+00	0.81075E-01	0.51212E+00
0.15057E+04	0.39925E+00	0.20817E+00	0.83110E-01	0.52497E+00
0.15058E+04	0.40958E+00	0.20787E+00	0.85139E-01	0.53779E+00
0.15059E+04	0.41992E+00	0.20758E+00	0.87166E-01	0.55059E+00
0.15060E+04	0.43028E+00	0.20728E+00	0.89189E-01	0.56337E+00
0.15061E+04	0.44064E+00	0.20699E+00	0.91208E-01	0.57612E+00
0.15062E+04	0.45098E+00	0.20670E+00	0.93219E-01	0.58882E+00
0.15063E+04	0.46124E+00	0.20642E+00	0.95207E-01	0.60138E+00
0.15064E+04	0.47140E+00	0.20613E+00	0.97170E-01	0.61378E+00
0.15065E+04	0.48147E+00	0.20584E+00	0.99107E-01	0.62602E+00
0.15066E+04	0.49141E+00	0.20561E+00	0.10104E+00	0.63822E+00
0.15067E+04	0.50120E+00	0.20538E+00	0.10294E+00	0.65021E+00
0.15068E+04	0.51085E+00	0.20515E+00	0.10480E+00	0.66198E+00
0.15069E+04	0.52036E+00	0.20492E+00	0.10663E+00	0.67354E+00
0.15070E+04	0.52972E+00	0.20469E+00	0.10843E+00	0.68489E+00
0.15071E+04	0.53892E+00	0.20446E+00	0.11019E+00	0.69600E+00
0.15072E+04	0.54797E+00	0.20423E+00	0.11191E+00	0.70689E+00
0.15073E+04	0.55688E+00	0.20400E+00	0.11360E+00	0.71757E+00
0.15074E+04	0.56563E+00	0.20377E+00	0.11526E+00	0.72802E+00
0.15075E+04	0.57418E+00	0.20354E+00	0.11687E+00	0.73820E+00
0.15076E+04	0.58253E+00	0.20331E+00	0.11843E+00	0.74809E+00
0.15077E+04	0.59066E+00	0.20308E+00	0.11995E+00	0.75767E+00
0.15078E+04	0.59856E+00	0.20285E+00	0.12142E+00	0.76694E+00
0.15079E+04	0.60624E+00	0.20262E+00	0.12284E+00	0.77591E+00
0.15080E+04	0.61369E+00	0.20239E+00	0.12420E+00	0.78455E+00
0.15081E+04	0.62088E+00	0.20218E+00	0.12553E+00	0.79290E+00
0.15082E+04	0.62782E+00	0.20196E+00	0.12679E+00	0.80091E+00
0.15083E+04	0.63449E+00	0.20175E+00	0.12801E+00	0.80856E+00
0.15084E+04	0.64091E+00	0.20153E+00	0.12916E+00	0.81587E+00
0.15085E+04	0.64707E+00	0.20136E+00	0.13030E+00	0.82303E+00
0.15086E+04	0.65297E+00	0.20122E+00	0.13139E+00	0.82993E+00
0.15087E+04	0.65863E+00	0.20107E+00	0.13243E+00	0.83650E+00
0.15088E+04	0.66402E+00	0.20092E+00	0.13342E+00	0.84273E+00
0.15089E+04	0.66914E+00	0.20078E+00	0.13435E+00	0.84861E+00

0.15090E+04	0.67398E+00	0.20063E+00	0.13522E+00	0.85413E+00
0.15091E+04	0.67857E+00	0.20048E+00	0.13604E+00	0.85930E+00
0.15092E+04	0.68290E+00	0.20033E+00	0.13681E+00	0.86416E+00
0.15093E+04	0.68700E+00	0.20019E+00	0.13753E+00	0.86870E+00
0.15094E+04	0.69085E+00	0.20004E+00	0.13820E+00	0.87293E+00
0.15095E+04	0.69448E+00	0.19989E+00	0.13882E+00	0.87687E+00
0.15096E+04	0.69790E+00	0.19974E+00	0.13940E+00	0.88054E+00
0.15097E+04	0.70110E+00	0.19960E+00	0.13994E+00	0.88392E+00
0.15098E+04	0.70409E+00	0.19945E+00	0.14043E+00	0.88703E+00
0.15099E+04	0.70687E+00	0.19930E+00	0.14088E+00	0.88987E+00
0.15100E+04	0.70944E+00	0.19915E+00	0.14129E+00	0.89245E+00
0.15101E+04	0.71182E+00	0.19902E+00	0.14167E+00	0.89486E+00
0.15102E+04	0.71401E+00	0.19889E+00	0.14201E+00	0.89703E+00
0.15103E+04	0.71601E+00	0.19876E+00	0.14232E+00	0.89895E+00
0.15104E+04	0.71783E+00	0.19864E+00	0.14259E+00	0.90069E+00
0.15105E+04	0.71949E+00	0.19853E+00	0.14284E+00	0.90226E+00
0.15106E+04	0.72098E+00	0.19842E+00	0.14306E+00	0.90363E+00
0.15107E+04	0.72231E+00	0.19831E+00	0.14324E+00	0.90480E+00
0.15108E+04	0.72350E+00	0.19820E+00	0.14340E+00	0.90578E+00
0.15109E+04	0.72456E+00	0.19809E+00	0.14353E+00	0.90661E+00
0.15110E+04	0.72552E+00	0.19798E+00	0.14364E+00	0.90731E+00
0.15111E+04	0.72639E+00	0.19787E+00	0.14373E+00	0.90789E+00
0.15112E+04	0.72719E+00	0.19776E+00	0.14381E+00	0.90838E+00
0.15113E+04	0.72792E+00	0.19765E+00	0.14387E+00	0.90878E+00
0.15114E+04	0.72861E+00	0.19754E+00	0.14393E+00	0.90913E+00
0.15115E+04	0.72922E+00	0.19743E+00	0.14397E+00	0.90938E+00
0.15116E+04	0.72975E+00	0.19731E+00	0.14399E+00	0.90953E+00
0.15117E+04	0.73021E+00	0.19720E+00	0.14400E+00	0.90958E+00
0.15118E+04	0.73061E+00	0.19709E+00	0.14400E+00	0.90956E+00
0.15119E+04	0.73098E+00	0.19698E+00	0.14399E+00	0.90951E+00
0.15120E+04	0.73133E+00	0.19687E+00	0.14398E+00	0.90944E+00
0.15121E+04	0.73167E+00	0.19679E+00	0.14398E+00	0.90947E+00
0.15122E+04	0.73200E+00	0.19670E+00	0.14399E+00	0.90950E+00
0.15123E+04	0.73233E+00	0.19661E+00	0.14398E+00	0.90949E+00
0.15124E+04	0.73264E+00	0.19647E+00	0.14394E+00	0.90922E+00
0.15125E+04	0.73296E+00	0.19633E+00	0.14390E+00	0.90897E+00
0.15126E+04	0.73330E+00	0.19619E+00	0.14386E+00	0.90873E+00
0.15127E+04	0.73363E+00	0.19605E+00	0.14383E+00	0.90849E+00
0.15128E+04	0.73395E+00	0.19591E+00	0.14379E+00	0.90823E+00
0.15129E+04	0.73428E+00	0.19577E+00	0.14375E+00	0.90799E+00
0.15130E+04	0.73462E+00	0.19562E+00	0.14371E+00	0.90775E+00
0.15131E+04	0.73500E+00	0.19548E+00	0.14368E+00	0.90757E+00
0.15132E+04	0.73545E+00	0.19534E+00	0.14366E+00	0.90747E+00

0.15133E+04	0.73597E+00	0.19520E+00	0.14366E+00	0.90746E+00
0.15134E+04	0.73656E+00	0.19506E+00	0.14368E+00	0.90753E+00
0.15135E+04	0.73718E+00	0.19492E+00	0.14369E+00	0.90765E+00
0.15136E+04	0.73780E+00	0.19478E+00	0.14371E+00	0.90776E+00
0.15137E+04	0.73843E+00	0.19464E+00	0.14373E+00	0.90788E+00
0.15138E+04	0.73905E+00	0.19450E+00	0.14375E+00	0.90798E+00
0.15139E+04	0.73967E+00	0.19436E+00	0.14376E+00	0.90809E+00
0.15140E+04	0.74030E+00	0.19422E+00	0.14378E+00	0.90820E+00
0.15141E+04	0.74092E+00	0.19411E+00	0.14382E+00	0.90846E+00
0.15142E+04	0.74154E+00	0.19401E+00	0.14386E+00	0.90872E+00
0.15143E+04	0.74217E+00	0.19384E+00	0.14386E+00	0.90871E+00
0.15144E+04	0.74281E+00	0.19365E+00	0.14385E+00	0.90863E+00
0.15145E+04	0.74348E+00	0.19347E+00	0.14384E+00	0.90858E+00
0.15146E+04	0.74418E+00	0.19329E+00	0.14384E+00	0.90857E+00
0.15147E+04	0.74489E+00	0.19310E+00	0.14384E+00	0.90859E+00
0.15148E+04	0.74566E+00	0.19292E+00	0.14385E+00	0.90865E+00
0.15149E+04	0.74644E+00	0.19274E+00	0.14387E+00	0.90875E+00
0.15150E+04	0.74724E+00	0.19256E+00	0.14389E+00	0.90886E+00
0.15151E+04	0.74807E+00	0.19238E+00	0.14391E+00	0.90902E+00
0.15152E+04	0.74891E+00	0.19220E+00	0.14394E+00	0.90919E+00
0.15153E+04	0.74976E+00	0.19202E+00	0.14397E+00	0.90937E+00
0.15154E+04	0.75060E+00	0.19184E+00	0.14399E+00	0.90955E+00
0.15155E+04	0.75145E+00	0.19166E+00	0.14402E+00	0.90972E+00
0.15156E+04	0.75232E+00	0.19148E+00	0.14405E+00	0.90992E+00
0.15157E+04	0.75323E+00	0.19130E+00	0.14409E+00	0.91017E+00
0.15158E+04	0.75416E+00	0.19112E+00	0.14413E+00	0.91044E+00
0.15159E+04	0.75512E+00	0.19094E+00	0.14418E+00	0.91074E+00
0.15160E+04	0.75612E+00	0.19076E+00	0.14424E+00	0.91109E+00
0.15161E+04	0.75714E+00	0.19063E+00	0.14433E+00	0.91168E+00
0.15162E+04	0.75818E+00	0.19048E+00	0.14442E+00	0.91222E+00
0.15163E+04	0.75921E+00	0.19032E+00	0.14449E+00	0.91268E+00
0.15164E+04	0.76024E+00	0.19015E+00	0.14456E+00	0.91314E+00
0.15165E+04	0.76127E+00	0.18999E+00	0.14464E+00	0.91361E+00
0.15166E+04	0.76231E+00	0.18983E+00	0.14471E+00	0.91407E+00
0.15167E+04	0.76335E+00	0.18967E+00	0.14478E+00	0.91454E+00
0.15168E+04	0.76437E+00	0.18951E+00	0.14485E+00	0.91497E+00
0.15169E+04	0.76537E+00	0.18934E+00	0.14491E+00	0.91535E+00
0.15170E+04	0.76635E+00	0.18916E+00	0.14497E+00	0.91569E+00
0.15171E+04	0.76730E+00	0.18900E+00	0.14502E+00	0.91601E+00
0.15172E+04	0.76822E+00	0.18883E+00	0.14506E+00	0.91630E+00
0.15173E+04	0.76912E+00	0.18866E+00	0.14510E+00	0.91656E+00
0.15174E+04	0.76998E+00	0.18850E+00	0.14514E+00	0.91677E+00
0.15175E+04	0.77080E+00	0.18833E+00	0.14516E+00	0.91694E+00

0.15176E+04	0.77158E+00	0.18816E+00	0.14518E+00	0.91705E+00
0.15177E+04	0.77230E+00	0.18800E+00	0.14519E+00	0.91710E+00
0.15178E+04	0.77298E+00	0.18783E+00	0.14519E+00	0.91709E+00
0.15179E+04	0.77363E+00	0.18766E+00	0.14518E+00	0.91705E+00
0.15180E+04	0.77428E+00	0.18750E+00	0.14518E+00	0.91701E+00
0.15181E+04	0.77493E+00	0.18739E+00	0.14521E+00	0.91725E+00
0.15182E+04	0.77557E+00	0.18730E+00	0.14526E+00	0.91756E+00
0.15183E+04	0.77618E+00	0.18721E+00	0.14531E+00	0.91785E+00
0.15184E+04	0.77678E+00	0.18712E+00	0.14535E+00	0.91811E+00
0.15185E+04	0.77734E+00	0.18703E+00	0.14538E+00	0.91833E+00
0.15186E+04	0.77787E+00	0.18694E+00	0.14541E+00	0.91852E+00
0.15187E+04	0.77838E+00	0.18685E+00	0.14544E+00	0.91867E+00
0.15188E+04	0.77885E+00	0.18676E+00	0.14545E+00	0.91878E+00
0.15189E+04	0.77927E+00	0.18667E+00	0.14546E+00	0.91883E+00
0.15190E+04	0.77964E+00	0.18658E+00	0.14546E+00	0.91883E+00
0.15191E+04	0.77996E+00	0.18649E+00	0.14546E+00	0.91879E+00
0.15192E+04	0.78026E+00	0.18641E+00	0.14545E+00	0.91872E+00
0.15193E+04	0.78053E+00	0.18632E+00	0.14543E+00	0.91862E+00
0.15194E+04	0.78077E+00	0.18624E+00	0.14541E+00	0.91849E+00
0.15195E+04	0.78100E+00	0.18615E+00	0.14539E+00	0.91834E+00
0.15196E+04	0.78119E+00	0.18607E+00	0.14536E+00	0.91815E+00
0.15197E+04	0.78136E+00	0.18599E+00	0.14532E+00	0.91794E+00
0.15198E+04	0.78151E+00	0.18590E+00	0.14528E+00	0.91769E+00
0.15199E+04	0.78162E+00	0.18582E+00	0.14524E+00	0.91741E+00
0.15200E+04	0.78168E+00	0.18573E+00	0.14518E+00	0.91707E+00
0.15201E+04	0.78172E+00	0.18575E+00	0.14520E+00	0.91717E+00
0.15202E+04	0.78175E+00	0.18576E+00	0.14522E+00	0.91729E+00
0.15203E+04	0.78180E+00	0.18578E+00	0.14524E+00	0.91743E+00
0.15204E+04	0.78188E+00	0.18580E+00	0.14527E+00	0.91762E+00
0.15205E+04	0.78199E+00	0.18582E+00	0.14531E+00	0.91784E+00
0.15206E+04	0.78213E+00	0.18583E+00	0.14535E+00	0.91809E+00
0.15207E+04	0.78229E+00	0.18585E+00	0.14539E+00	0.91836E+00
0.15208E+04	0.78244E+00	0.18587E+00	0.14543E+00	0.91863E+00
0.15209E+04	0.78257E+00	0.18589E+00	0.14547E+00	0.91888E+00
0.15210E+04	0.78269E+00	0.18591E+00	0.14551E+00	0.91911E+00
0.15211E+04	0.78281E+00	0.18593E+00	0.14555E+00	0.91937E+00
0.15212E+04	0.78290E+00	0.18595E+00	0.14558E+00	0.91959E+00
0.15213E+04	0.78297E+00	0.18598E+00	0.14562E+00	0.91980E+00
0.15214E+04	0.78300E+00	0.18600E+00	0.14564E+00	0.91995E+00
0.15215E+04	0.78300E+00	0.18603E+00	0.14566E+00	0.92007E+00
0.15216E+04	0.78296E+00	0.18605E+00	0.14567E+00	0.92015E+00
0.15217E+04	0.78288E+00	0.18608E+00	0.14568E+00	0.92018E+00
0.15218E+04	0.78279E+00	0.18610E+00	0.14568E+00	0.92020E+00

0.15219E+04	0.78269E+00	0.18613E+00	0.14568E+00	0.92021E+00
0.15220E+04	0.78258E+00	0.18619E+00	0.14570E+00	0.92035E+00
0.15221E+04	0.78246E+00	0.18631E+00	0.14578E+00	0.92081E+00
0.15222E+04	0.78234E+00	0.18643E+00	0.14585E+00	0.92127E+00
0.15223E+04	0.78220E+00	0.18655E+00	0.14592E+00	0.92171E+00
0.15224E+04	0.78209E+00	0.18667E+00	0.14599E+00	0.92217E+00
0.15225E+04	0.78198E+00	0.18679E+00	0.14607E+00	0.92265E+00
0.15226E+04	0.78188E+00	0.18691E+00	0.14614E+00	0.92313E+00
0.15227E+04	0.78177E+00	0.18704E+00	0.14622E+00	0.92360E+00
0.15228E+04	0.78166E+00	0.18716E+00	0.14629E+00	0.92407E+00
0.15229E+04	0.78156E+00	0.18728E+00	0.14637E+00	0.92456E+00
0.15230E+04	0.78148E+00	0.18740E+00	0.14645E+00	0.92506E+00
0.15231E+04	0.78140E+00	0.18753E+00	0.14654E+00	0.92561E+00
0.15232E+04	0.78134E+00	0.18766E+00	0.14662E+00	0.92617E+00
0.15233E+04	0.78129E+00	0.18779E+00	0.14671E+00	0.92673E+00
0.15234E+04	0.78123E+00	0.18791E+00	0.14681E+00	0.92730E+00
0.15235E+04	0.78118E+00	0.18804E+00	0.14689E+00	0.92787E+00
0.15236E+04	0.78113E+00	0.18817E+00	0.14699E+00	0.92844E+00
0.15237E+04	0.78110E+00	0.18830E+00	0.14708E+00	0.92904E+00
0.15238E+04	0.78106E+00	0.18843E+00	0.14717E+00	0.92963E+00
0.15239E+04	0.78101E+00	0.18857E+00	0.14727E+00	0.93026E+00
0.15240E+04	0.78097E+00	0.18873E+00	0.14739E+00	0.93100E+00
0.15241E+04	0.78094E+00	0.18892E+00	0.14754E+00	0.93193E+00
0.15242E+04	0.78092E+00	0.18912E+00	0.14769E+00	0.93289E+00
0.15243E+04	0.78092E+00	0.18932E+00	0.14784E+00	0.93386E+00
0.15244E+04	0.78092E+00	0.18952E+00	0.14800E+00	0.93484E+00
0.15245E+04	0.78090E+00	0.18972E+00	0.14815E+00	0.93579E+00
0.15246E+04	0.78084E+00	0.18991E+00	0.14829E+00	0.93669E+00
0.15247E+04	0.78074E+00	0.19011E+00	0.14843E+00	0.93755E+00
0.15248E+04	0.78064E+00	0.19031E+00	0.14856E+00	0.93840E+00
0.15249E+04	0.78054E+00	0.19051E+00	0.14870E+00	0.93926E+00
0.15250E+04	0.78045E+00	0.19070E+00	0.14884E+00	0.94013E+00
0.15251E+04	0.78037E+00	0.19091E+00	0.14898E+00	0.94102E+00
0.15252E+04	0.78027E+00	0.19111E+00	0.14911E+00	0.94189E+00
0.15253E+04	0.78014E+00	0.19131E+00	0.14925E+00	0.94272E+00
0.15254E+04	0.77999E+00	0.19151E+00	0.14937E+00	0.94354E+00
0.15255E+04	0.77983E+00	0.19171E+00	0.14950E+00	0.94433E+00
0.15256E+04	0.77966E+00	0.19191E+00	0.14963E+00	0.94512E+00
0.15257E+04	0.77951E+00	0.19211E+00	0.14975E+00	0.94592E+00
0.15258E+04	0.77937E+00	0.19231E+00	0.14988E+00	0.94674E+00
0.15259E+04	0.77925E+00	0.19250E+00	0.15001E+00	0.94754E+00
0.15260E+04	0.77915E+00	0.19270E+00	0.15014E+00	0.94837E+00
0.15261E+04	0.77904E+00	0.19291E+00	0.15029E+00	0.94931E+00

0.15262E+04	0.77893E+00	0.19313E+00	0.15044E+00	0.95024E+00
0.15263E+04	0.77881E+00	0.19335E+00	0.15058E+00	0.95116E+00
0.15264E+04	0.77869E+00	0.19356E+00	0.15073E+00	0.95208E+00
0.15265E+04	0.77858E+00	0.19378E+00	0.15087E+00	0.95300E+00
0.15266E+04	0.77848E+00	0.19400E+00	0.15102E+00	0.95395E+00
0.15267E+04	0.77842E+00	0.19421E+00	0.15118E+00	0.95494E+00
0.15268E+04	0.77839E+00	0.19443E+00	0.15134E+00	0.95596E+00
0.15269E+04	0.77835E+00	0.19464E+00	0.15150E+00	0.95697E+00
0.15270E+04	0.77830E+00	0.19486E+00	0.15166E+00	0.95797E+00
0.15271E+04	0.77826E+00	0.19508E+00	0.15182E+00	0.95900E+00
0.15272E+04	0.77827E+00	0.19529E+00	0.15199E+00	0.96006E+00
0.15273E+04	0.77830E+00	0.19551E+00	0.15217E+00	0.96117E+00
0.15274E+04	0.77836E+00	0.19573E+00	0.15235E+00	0.96231E+00
0.15275E+04	0.77846E+00	0.19594E+00	0.15253E+00	0.96349E+00
0.15276E+04	0.77857E+00	0.19616E+00	0.15272E+00	0.96469E+00
0.15277E+04	0.77870E+00	0.19637E+00	0.15292E+00	0.96591E+00
0.15278E+04	0.77885E+00	0.19657E+00	0.15309E+00	0.96703E+00
0.15279E+04	0.77901E+00	0.19675E+00	0.15327E+00	0.96814E+00
0.15280E+04	0.77915E+00	0.19693E+00	0.15344E+00	0.96922E+00
0.15281E+04	0.77927E+00	0.19713E+00	0.15361E+00	0.97032E+00
0.15282E+04	0.77940E+00	0.19732E+00	0.15379E+00	0.97141E+00
0.15283E+04	0.77955E+00	0.19751E+00	0.15397E+00	0.97254E+00
0.15284E+04	0.77975E+00	0.19770E+00	0.15415E+00	0.97372E+00
0.15285E+04	0.77997E+00	0.19789E+00	0.15435E+00	0.97494E+00
0.15286E+04	0.78024E+00	0.19808E+00	0.15455E+00	0.97621E+00
0.15287E+04	0.78055E+00	0.19827E+00	0.15476E+00	0.97753E+00
0.15288E+04	0.78084E+00	0.19845E+00	0.15496E+00	0.97882E+00
0.15289E+04	0.78111E+00	0.19864E+00	0.15516E+00	0.98010E+00
0.15290E+04	0.78140E+00	0.19883E+00	0.15537E+00	0.98138E+00
0.15291E+04	0.78169E+00	0.19902E+00	0.15557E+00	0.98267E+00
0.15292E+04	0.78199E+00	0.19921E+00	0.15578E+00	0.98397E+00
0.15293E+04	0.78227E+00	0.19939E+00	0.15598E+00	0.98525E+00
0.15294E+04	0.78251E+00	0.19958E+00	0.15617E+00	0.98647E+00
0.15295E+04	0.78272E+00	0.19977E+00	0.15636E+00	0.98766E+00
0.15296E+04	0.78289E+00	0.19995E+00	0.15654E+00	0.98879E+00
0.15297E+04	0.78303E+00	0.20011E+00	0.15669E+00	0.98976E+00
0.15298E+04	0.78318E+00	0.20024E+00	0.15683E+00	0.99061E+00
0.15299E+04	0.78330E+00	0.20038E+00	0.15696E+00	0.99143E+00
0.15300E+04	0.78340E+00	0.20051E+00	0.15708E+00	0.99220E+00
0.15301E+04	0.78347E+00	0.20063E+00	0.15719E+00	0.99289E+00
0.15302E+04	0.78351E+00	0.20075E+00	0.15729E+00	0.99353E+00
0.15303E+04	0.78354E+00	0.20087E+00	0.15739E+00	0.99414E+00
0.15304E+04	0.78355E+00	0.20098E+00	0.15748E+00	0.99474E+00

0.15305E+04	0.78354E+00	0.20110E+00	0.15757E+00	0.99531E+00
0.15306E+04	0.78349E+00	0.20122E+00	0.15765E+00	0.99582E+00
0.15307E+04	0.78342E+00	0.20133E+00	0.15773E+00	0.99629E+00
0.15308E+04	0.78330E+00	0.20145E+00	0.15779E+00	0.99672E+00
0.15309E+04	0.78317E+00	0.20156E+00	0.15786E+00	0.99712E+00
0.15310E+04	0.78302E+00	0.20168E+00	0.15792E+00	0.99750E+00
0.15311E+04	0.78287E+00	0.20179E+00	0.15798E+00	0.99787E+00
0.15312E+04	0.78273E+00	0.20191E+00	0.15804E+00	0.99826E+00
0.15313E+04	0.78263E+00	0.20202E+00	0.15811E+00	0.99868E+00
0.15314E+04	0.78253E+00	0.20213E+00	0.15817E+00	0.99912E+00
0.15315E+04	0.78244E+00	0.20224E+00	0.15824E+00	0.99955E+00
0.15316E+04	0.78235E+00	0.20234E+00	0.15830E+00	0.99992E+00
0.15317E+04	0.78224E+00	0.20238E+00	0.15831E+00	0.99997E+00
0.15318E+04	0.78211E+00	0.20242E+00	0.15831E+00	0.10000E+01
0.15319E+04	0.78197E+00	0.20245E+00	0.15831E+00	0.10000E+01
0.15320E+04	0.78180E+00	0.20249E+00	0.15831E+00	0.99996E+00
0.15321E+04	0.78163E+00	0.20249E+00	0.15827E+00	0.99974E+00
0.15322E+04	0.78145E+00	0.20249E+00	0.15823E+00	0.99950E+00
0.15323E+04	0.78126E+00	0.20249E+00	0.15819E+00	0.99924E+00
0.15324E+04	0.78106E+00	0.20248E+00	0.15815E+00	0.99898E+00
0.15325E+04	0.78088E+00	0.20248E+00	0.15811E+00	0.99873E+00
0.15326E+04	0.78068E+00	0.20248E+00	0.15807E+00	0.99846E+00
0.15327E+04	0.78048E+00	0.20247E+00	0.15803E+00	0.99818E+00
0.15328E+04	0.78027E+00	0.20247E+00	0.15798E+00	0.99790E+00
0.15329E+04	0.78006E+00	0.20246E+00	0.15793E+00	0.99760E+00
0.15330E+04	0.77987E+00	0.20246E+00	0.15789E+00	0.99733E+00
0.15331E+04	0.77968E+00	0.20245E+00	0.15785E+00	0.99707E+00
0.15332E+04	0.77949E+00	0.20245E+00	0.15781E+00	0.99681E+00
0.15333E+04	0.77931E+00	0.20245E+00	0.15777E+00	0.99656E+00
0.15334E+04	0.77913E+00	0.20244E+00	0.15773E+00	0.99631E+00
0.15335E+04	0.77897E+00	0.20244E+00	0.15769E+00	0.99607E+00
0.15336E+04	0.77885E+00	0.20238E+00	0.15762E+00	0.99563E+00
0.15337E+04	0.77876E+00	0.20231E+00	0.15755E+00	0.99520E+00
0.15338E+04	0.77872E+00	0.20225E+00	0.15750E+00	0.99483E+00
0.15339E+04	0.77874E+00	0.20218E+00	0.15745E+00	0.99454E+00
0.15340E+04	0.77878E+00	0.20212E+00	0.15741E+00	0.99427E+00
0.15341E+04	0.77885E+00	0.20200E+00	0.15733E+00	0.99377E+00
0.15342E+04	0.77893E+00	0.20188E+00	0.15725E+00	0.99328E+00
0.15343E+04	0.77901E+00	0.20176E+00	0.15717E+00	0.99279E+00
0.15344E+04	0.77910E+00	0.20164E+00	0.15710E+00	0.99233E+00
0.15345E+04	0.77921E+00	0.20152E+00	0.15703E+00	0.99187E+00
0.15346E+04	0.77930E+00	0.20140E+00	0.15695E+00	0.99141E+00
0.15347E+04	0.77940E+00	0.20128E+00	0.15688E+00	0.99093E+00

0.15348E+04	0.77947E+00	0.20116E+00	0.15680E+00	0.99044E+00
0.15349E+04	0.77951E+00	0.20104E+00	0.15671E+00	0.98989E+00
0.15350E+04	0.77951E+00	0.20092E+00	0.15662E+00	0.98930E+00
0.15351E+04	0.77949E+00	0.20080E+00	0.15652E+00	0.98869E+00
0.15352E+04	0.77946E+00	0.20069E+00	0.15643E+00	0.98807E+00
0.15353E+04	0.77941E+00	0.20057E+00	0.15632E+00	0.98743E+00
0.15354E+04	0.77933E+00	0.20045E+00	0.15622E+00	0.98675E+00
0.15355E+04	0.77922E+00	0.20034E+00	0.15611E+00	0.98607E+00
0.15356E+04	0.77908E+00	0.20023E+00	0.15600E+00	0.98536E+00
0.15357E+04	0.77892E+00	0.20012E+00	0.15588E+00	0.98463E+00
0.15358E+04	0.77873E+00	0.20002E+00	0.15576E+00	0.98386E+00
0.15359E+04	0.77853E+00	0.19991E+00	0.15563E+00	0.98308E+00
0.15360E+04	0.77830E+00	0.19980E+00	0.15551E+00	0.98226E+00
0.15361E+04	0.77803E+00	0.19963E+00	0.15532E+00	0.98107E+00
0.15362E+04	0.77771E+00	0.19946E+00	0.15512E+00	0.97982E+00
0.15363E+04	0.77733E+00	0.19928E+00	0.15491E+00	0.97851E+00
0.15364E+04	0.77692E+00	0.19911E+00	0.15469E+00	0.97714E+00
0.15365E+04	0.77649E+00	0.19894E+00	0.15448E+00	0.97576E+00
0.15366E+04	0.77605E+00	0.19877E+00	0.15426E+00	0.97438E+00
0.15367E+04	0.77562E+00	0.19860E+00	0.15404E+00	0.97298E+00
0.15368E+04	0.77517E+00	0.19842E+00	0.15381E+00	0.97156E+00
0.15369E+04	0.77470E+00	0.19825E+00	0.15358E+00	0.97013E+00
0.15370E+04	0.77421E+00	0.19808E+00	0.15335E+00	0.96867E+00
0.15371E+04	0.77371E+00	0.19791E+00	0.15312E+00	0.96722E+00
0.15372E+04	0.77321E+00	0.19774E+00	0.15289E+00	0.96576E+00
0.15373E+04	0.77270E+00	0.19757E+00	0.15266E+00	0.96431E+00
0.15374E+04	0.77223E+00	0.19743E+00	0.15246E+00	0.96303E+00
0.15375E+04	0.77177E+00	0.19733E+00	0.15229E+00	0.96198E+00
0.15376E+04	0.77132E+00	0.19723E+00	0.15213E+00	0.96093E+00
0.15377E+04	0.77086E+00	0.19714E+00	0.15196E+00	0.95989E+00
0.15378E+04	0.77037E+00	0.19704E+00	0.15179E+00	0.95880E+00
0.15379E+04	0.76984E+00	0.19694E+00	0.15161E+00	0.95767E+00
0.15380E+04	0.76925E+00	0.19684E+00	0.15142E+00	0.95643E+00
0.15381E+04	0.76861E+00	0.19667E+00	0.15117E+00	0.95485E+00
0.15382E+04	0.76798E+00	0.19651E+00	0.15092E+00	0.95327E+00
0.15383E+04	0.76734E+00	0.19635E+00	0.15067E+00	0.95169E+00
0.15384E+04	0.76671E+00	0.19619E+00	0.15042E+00	0.95012E+00
0.15385E+04	0.76608E+00	0.19602E+00	0.15017E+00	0.94856E+00
0.15386E+04	0.76545E+00	0.19586E+00	0.14992E+00	0.94700E+00
0.15387E+04	0.76481E+00	0.19570E+00	0.14968E+00	0.94543E+00
0.15388E+04	0.76415E+00	0.19554E+00	0.14942E+00	0.94384E+00
0.15389E+04	0.76349E+00	0.19538E+00	0.14917E+00	0.94225E+00
0.15390E+04	0.76281E+00	0.19522E+00	0.14892E+00	0.94064E+00

0.15391E+04	0.76211E+00	0.19506E+00	0.14866E+00	0.93903E+00
0.15392E+04	0.76142E+00	0.19491E+00	0.14841E+00	0.93742E+00
0.15393E+04	0.76077E+00	0.19476E+00	0.14817E+00	0.93590E+00
0.15394E+04	0.76019E+00	0.19468E+00	0.14800E+00	0.93483E+00
0.15395E+04	0.75968E+00	0.19461E+00	0.14784E+00	0.93385E+00
0.15396E+04	0.75926E+00	0.19453E+00	0.14770E+00	0.93297E+00
0.15397E+04	0.75890E+00	0.19446E+00	0.14758E+00	0.93217E+00
0.15398E+04	0.75857E+00	0.19439E+00	0.14746E+00	0.93141E+00
0.15399E+04	0.75824E+00	0.19431E+00	0.14733E+00	0.93065E+00
0.15400E+04	0.75788E+00	0.19424E+00	0.14721E+00	0.92985E+00
0.15401E+04	0.75753E+00	0.19410E+00	0.14703E+00	0.92875E+00
0.15402E+04	0.75725E+00	0.19395E+00	0.14687E+00	0.92772E+00
0.15403E+04	0.75701E+00	0.19381E+00	0.14672E+00	0.92674E+00
0.15404E+04	0.75681E+00	0.19367E+00	0.14657E+00	0.92582E+00
0.15405E+04	0.75663E+00	0.19353E+00	0.14643E+00	0.92492E+00
0.15406E+04	0.75647E+00	0.19338E+00	0.14629E+00	0.92405E+00
0.15407E+04	0.75634E+00	0.19324E+00	0.14616E+00	0.92322E+00
0.15408E+04	0.75625E+00	0.19310E+00	0.14603E+00	0.92242E+00
0.15409E+04	0.75620E+00	0.19296E+00	0.14592E+00	0.92168E+00
0.15410E+04	0.75620E+00	0.19282E+00	0.14581E+00	0.92102E+00
0.15411E+04	0.75624E+00	0.19268E+00	0.14571E+00	0.92039E+00
0.15412E+04	0.75628E+00	0.19254E+00	0.14561E+00	0.91977E+00
0.15413E+04	0.75635E+00	0.19246E+00	0.14557E+00	0.91950E+00
0.15414E+04	0.75643E+00	0.19240E+00	0.14554E+00	0.91932E+00
0.15415E+04	0.75655E+00	0.19235E+00	0.14552E+00	0.91918E+00
0.15416E+04	0.75668E+00	0.19229E+00	0.14550E+00	0.91906E+00
0.15417E+04	0.75681E+00	0.19223E+00	0.14548E+00	0.91893E+00
0.15418E+04	0.75693E+00	0.19217E+00	0.14546E+00	0.91881E+00
0.15419E+04	0.75707E+00	0.19211E+00	0.14544E+00	0.91869E+00
0.15420E+04	0.75720E+00	0.19205E+00	0.14542E+00	0.91858E+00
0.15421E+04	0.75734E+00	0.19193E+00	0.14536E+00	0.91816E+00
0.15422E+04	0.75749E+00	0.19181E+00	0.14529E+00	0.91775E+00
0.15423E+04	0.75763E+00	0.19168E+00	0.14523E+00	0.91733E+00
0.15424E+04	0.75775E+00	0.19156E+00	0.14515E+00	0.91688E+00
0.15425E+04	0.75783E+00	0.19144E+00	0.14508E+00	0.91639E+00
0.15426E+04	0.75789E+00	0.19131E+00	0.14499E+00	0.91586E+00
0.15427E+04	0.75793E+00	0.19119E+00	0.14491E+00	0.91532E+00
0.15428E+04	0.75798E+00	0.19106E+00	0.14482E+00	0.91479E+00
0.15429E+04	0.75803E+00	0.19094E+00	0.14474E+00	0.91425E+00
0.15430E+04	0.75807E+00	0.19081E+00	0.14465E+00	0.91370E+00
0.15431E+04	0.75808E+00	0.19069E+00	0.14456E+00	0.91310E+00
0.15432E+04	0.75807E+00	0.19059E+00	0.14448E+00	0.91261E+00
0.15433E+04	0.75804E+00	0.19051E+00	0.14441E+00	0.91220E+00

0.15434E+04	0.75799E+00	0.19043E+00	0.14435E+00	0.91178E+00
0.15435E+04	0.75794E+00	0.19036E+00	0.14428E+00	0.91135E+00
0.15436E+04	0.75787E+00	0.19028E+00	0.14421E+00	0.91090E+00
0.15437E+04	0.75775E+00	0.19020E+00	0.14413E+00	0.91039E+00
0.15438E+04	0.75756E+00	0.19013E+00	0.14403E+00	0.90979E+00
0.15439E+04	0.75733E+00	0.19005E+00	0.14393E+00	0.90913E+00
0.15440E+04	0.75705E+00	0.18997E+00	0.14382E+00	0.90843E+00
0.15441E+04	0.75675E+00	0.18983E+00	0.14366E+00	0.90741E+00
0.15442E+04	0.75644E+00	0.18970E+00	0.14349E+00	0.90639E+00
0.15443E+04	0.75612E+00	0.18956E+00	0.14333E+00	0.90535E+00
0.15444E+04	0.75578E+00	0.18942E+00	0.14316E+00	0.90429E+00
0.15445E+04	0.75543E+00	0.18928E+00	0.14299E+00	0.90320E+00
0.15446E+04	0.75507E+00	0.18914E+00	0.14282E+00	0.90211E+00
0.15447E+04	0.75473E+00	0.18900E+00	0.14265E+00	0.90104E+00
0.15448E+04	0.75445E+00	0.18886E+00	0.14249E+00	0.90004E+00
0.15449E+04	0.75421E+00	0.18872E+00	0.14234E+00	0.89908E+00
0.15450E+04	0.75402E+00	0.18858E+00	0.14219E+00	0.89818E+00
0.15451E+04	0.75382E+00	0.18843E+00	0.14204E+00	0.89723E+00
0.15452E+04	0.75359E+00	0.18827E+00	0.14188E+00	0.89621E+00
0.15453E+04	0.75336E+00	0.18811E+00	0.14172E+00	0.89517E+00
0.15454E+04	0.75312E+00	0.18795E+00	0.14155E+00	0.89411E+00
0.15455E+04	0.75285E+00	0.18779E+00	0.14138E+00	0.89303E+00
0.15456E+04	0.75258E+00	0.18763E+00	0.14121E+00	0.89194E+00
0.15457E+04	0.75229E+00	0.18747E+00	0.14103E+00	0.89082E+00
0.15458E+04	0.75196E+00	0.18730E+00	0.14084E+00	0.88966E+00
0.15459E+04	0.75161E+00	0.18714E+00	0.14065E+00	0.88846E+00
0.15460E+04	0.75122E+00	0.18697E+00	0.14046E+00	0.88722E+00
0.15461E+04	0.75081E+00	0.18677E+00	0.14023E+00	0.88576E+00
0.15462E+04	0.75039E+00	0.18657E+00	0.14000E+00	0.88430E+00
0.15463E+04	0.74996E+00	0.18636E+00	0.13976E+00	0.88283E+00
0.15464E+04	0.74954E+00	0.18616E+00	0.13953E+00	0.88135E+00
0.15465E+04	0.74909E+00	0.18595E+00	0.13929E+00	0.87985E+00
0.15466E+04	0.74859E+00	0.18574E+00	0.13904E+00	0.87829E+00
0.15467E+04	0.74805E+00	0.18553E+00	0.13879E+00	0.87666E+00
0.15468E+04	0.74746E+00	0.18533E+00	0.13852E+00	0.87500E+00
0.15469E+04	0.74683E+00	0.18512E+00	0.13825E+00	0.87327E+00
0.15470E+04	0.74615E+00	0.18491E+00	0.13797E+00	0.87148E+00
0.15471E+04	0.74543E+00	0.18463E+00	0.13763E+00	0.86934E+00
0.15472E+04	0.74466E+00	0.18434E+00	0.13727E+00	0.86710E+00
0.15473E+04	0.74387E+00	0.18406E+00	0.13691E+00	0.86483E+00
0.15474E+04	0.74305E+00	0.18377E+00	0.13655E+00	0.86253E+00
0.15475E+04	0.74220E+00	0.18349E+00	0.13618E+00	0.86021E+00
0.15476E+04	0.74135E+00	0.18320E+00	0.13581E+00	0.85788E+00

0.15477E+04	0.74049E+00	0.18291E+00	0.13544E+00	0.85554E+00
0.15478E+04	0.73962E+00	0.18262E+00	0.13507E+00	0.85319E+00
0.15479E+04	0.73873E+00	0.18234E+00	0.13470E+00	0.85083E+00
0.15480E+04	0.73783E+00	0.18205E+00	0.13432E+00	0.84844E+00
0.15481E+04	0.73693E+00	0.18174E+00	0.13393E+00	0.84595E+00
0.15482E+04	0.73604E+00	0.18142E+00	0.13353E+00	0.84347E+00
0.15483E+04	0.73517E+00	0.18111E+00	0.13314E+00	0.84101E+00
0.15484E+04	0.73433E+00	0.18079E+00	0.13276E+00	0.83859E+00
0.15485E+04	0.73353E+00	0.18048E+00	0.13238E+00	0.83621E+00
0.15486E+04	0.73274E+00	0.18016E+00	0.13201E+00	0.83385E+00
0.15487E+04	0.73193E+00	0.17984E+00	0.13163E+00	0.83146E+00
0.15488E+04	0.73109E+00	0.17953E+00	0.13125E+00	0.82905E+00
0.15489E+04	0.73024E+00	0.17921E+00	0.13087E+00	0.82662E+00
0.15490E+04	0.72936E+00	0.17883E+00	0.13043E+00	0.82389E+00
0.15491E+04	0.72847E+00	0.17842E+00	0.12997E+00	0.82098E+00
0.15492E+04	0.72760E+00	0.17800E+00	0.12952E+00	0.81809E+00
0.15493E+04	0.72678E+00	0.17759E+00	0.12907E+00	0.81526E+00
0.15494E+04	0.72599E+00	0.17717E+00	0.12863E+00	0.81247E+00
0.15495E+04	0.72521E+00	0.17676E+00	0.12819E+00	0.80970E+00
0.15496E+04	0.72444E+00	0.17634E+00	0.12775E+00	0.80695E+00
0.15497E+04	0.72368E+00	0.17593E+00	0.12732E+00	0.80421E+00
0.15498E+04	0.72292E+00	0.17551E+00	0.12688E+00	0.80146E+00
0.15499E+04	0.72214E+00	0.17510E+00	0.12645E+00	0.79871E+00
0.15500E+04	0.72134E+00	0.17469E+00	0.12601E+00	0.79594E+00
0.15501E+04	0.72054E+00	0.17427E+00	0.12557E+00	0.79314E+00
0.15502E+04	0.71971E+00	0.17385E+00	0.12512E+00	0.79032E+00
0.15503E+04	0.71889E+00	0.17342E+00	0.12467E+00	0.78751E+00
0.15504E+04	0.71810E+00	0.17300E+00	0.12423E+00	0.78473E+00
0.15505E+04	0.71732E+00	0.17258E+00	0.12380E+00	0.78197E+00
0.15506E+04	0.71657E+00	0.17216E+00	0.12337E+00	0.77926E+00
0.15507E+04	0.71584E+00	0.17174E+00	0.12294E+00	0.77657E+00
0.15508E+04	0.71513E+00	0.17132E+00	0.12252E+00	0.77390E+00
0.15509E+04	0.71444E+00	0.17088E+00	0.12208E+00	0.77115E+00
0.15510E+04	0.71374E+00	0.17038E+00	0.12161E+00	0.76813E+00
0.15511E+04	0.71305E+00	0.16988E+00	0.12113E+00	0.76514E+00
0.15512E+04	0.71236E+00	0.16938E+00	0.12066E+00	0.76215E+00
0.15513E+04	0.71169E+00	0.16888E+00	0.12019E+00	0.75919E+00
0.15514E+04	0.71107E+00	0.16838E+00	0.11973E+00	0.75628E+00
0.15515E+04	0.71047E+00	0.16788E+00	0.11928E+00	0.75341E+00
0.15516E+04	0.70988E+00	0.16739E+00	0.11882E+00	0.75056E+00
0.15517E+04	0.70931E+00	0.16689E+00	0.11838E+00	0.74773E+00
0.15518E+04	0.70874E+00	0.16639E+00	0.11793E+00	0.74491E+00
0.15519E+04	0.70818E+00	0.16590E+00	0.11749E+00	0.74211E+00

0.15520E+04	0.70763E+00	0.16540E+00	0.11704E+00	0.73931E+00
0.15521E+04	0.70708E+00	0.16492E+00	0.11661E+00	0.73657E+00
0.15522E+04	0.70654E+00	0.16443E+00	0.11618E+00	0.73385E+00
0.15523E+04	0.70600E+00	0.16395E+00	0.11575E+00	0.73113E+00
0.15524E+04	0.70547E+00	0.16346E+00	0.11532E+00	0.72842E+00
0.15525E+04	0.70493E+00	0.16298E+00	0.11489E+00	0.72572E+00
0.15526E+04	0.70440E+00	0.16250E+00	0.11447E+00	0.72303E+00
0.15527E+04	0.70385E+00	0.16202E+00	0.11404E+00	0.72032E+00
0.15528E+04	0.70330E+00	0.16153E+00	0.11361E+00	0.71760E+00
0.15529E+04	0.70274E+00	0.16102E+00	0.11316E+00	0.71476E+00
0.15530E+04	0.70214E+00	0.16051E+00	0.11270E+00	0.71190E+00
0.15531E+04	0.70151E+00	0.16000E+00	0.11224E+00	0.70900E+00
0.15532E+04	0.70083E+00	0.15950E+00	0.11178E+00	0.70606E+00
0.15533E+04	0.70008E+00	0.15899E+00	0.11130E+00	0.70306E+00
0.15534E+04	0.69929E+00	0.15848E+00	0.11082E+00	0.70003E+00
0.15535E+04	0.69844E+00	0.15798E+00	0.11034E+00	0.69695E+00
0.15536E+04	0.69754E+00	0.15747E+00	0.10984E+00	0.69383E+00
0.15537E+04	0.69659E+00	0.15697E+00	0.10934E+00	0.69066E+00
0.15538E+04	0.69558E+00	0.15646E+00	0.10883E+00	0.68744E+00
0.15539E+04	0.69448E+00	0.15596E+00	0.10831E+00	0.68416E+00
0.15540E+04	0.69328E+00	0.15546E+00	0.10778E+00	0.68078E+00
0.15541E+04	0.69196E+00	0.15498E+00	0.10724E+00	0.67739E+00
0.15542E+04	0.69051E+00	0.15450E+00	0.10669E+00	0.67389E+00
0.15543E+04	0.68893E+00	0.15403E+00	0.10611E+00	0.67027E+00
0.15544E+04	0.68720E+00	0.15355E+00	0.10552E+00	0.66654E+00
0.15545E+04	0.68533E+00	0.15308E+00	0.10491E+00	0.66266E+00
0.15546E+04	0.68328E+00	0.15261E+00	0.10427E+00	0.65864E+00
0.15547E+04	0.68104E+00	0.15213E+00	0.10361E+00	0.65445E+00
0.15548E+04	0.67858E+00	0.15169E+00	0.10294E+00	0.65021E+00
0.15549E+04	0.67592E+00	0.15126E+00	0.10224E+00	0.64582E+00
0.15550E+04	0.67305E+00	0.15083E+00	0.10152E+00	0.64125E+00
0.15551E+04	0.66998E+00	0.15041E+00	0.10077E+00	0.63651E+00
0.15552E+04	0.66672E+00	0.14998E+00	0.99993E-01	0.63161E+00
0.15553E+04	0.66327E+00	0.14955E+00	0.99191E-01	0.62655E+00
0.15554E+04	0.65964E+00	0.14912E+00	0.98366E-01	0.62133E+00
0.15555E+04	0.65579E+00	0.14869E+00	0.97513E-01	0.61595E+00
0.15556E+04	0.65173E+00	0.14827E+00	0.96631E-01	0.61038E+00
0.15557E+04	0.64745E+00	0.14784E+00	0.95720E-01	0.60462E+00
0.15558E+04	0.64295E+00	0.14742E+00	0.94782E-01	0.59869E+00
0.15559E+04	0.63824E+00	0.14699E+00	0.93816E-01	0.59260E+00
0.15560E+04	0.63331E+00	0.14657E+00	0.92823E-01	0.58632E+00
0.15561E+04	0.62814E+00	0.14617E+00	0.91816E-01	0.57996E+00
0.15562E+04	0.62273E+00	0.14578E+00	0.90783E-01	0.57344E+00

0.15563E+04	0.61709E+00	0.14539E+00	0.89719E-01	0.56671E+00
0.15564E+04	0.61119E+00	0.14500E+00	0.88623E-01	0.55979E+00
0.15565E+04	0.60504E+00	0.14459E+00	0.87484E-01	0.55260E+00
0.15566E+04	0.59865E+00	0.14418E+00	0.86316E-01	0.54522E+00
0.15567E+04	0.59204E+00	0.14382E+00	0.85146E-01	0.53783E+00
0.15568E+04	0.58520E+00	0.14349E+00	0.83972E-01	0.53041E+00
0.15569E+04	0.57812E+00	0.14317E+00	0.82768E-01	0.52281E+00
0.15570E+04	0.57081E+00	0.14284E+00	0.81537E-01	0.51503E+00
0.15571E+04	0.56328E+00	0.14252E+00	0.80277E-01	0.50708E+00
0.15572E+04	0.55553E+00	0.14219E+00	0.78992E-01	0.49896E+00
0.15573E+04	0.54757E+00	0.14187E+00	0.77682E-01	0.49068E+00
0.15574E+04	0.53943E+00	0.14154E+00	0.76353E-01	0.48229E+00
0.15575E+04	0.53111E+00	0.14122E+00	0.75003E-01	0.47376E+00
0.15576E+04	0.52262E+00	0.14089E+00	0.73633E-01	0.46511E+00
0.15577E+04	0.51393E+00	0.14057E+00	0.72243E-01	0.45633E+00
0.15578E+04	0.50506E+00	0.14024E+00	0.70831E-01	0.44741E+00
0.15579E+04	0.49602E+00	0.13992E+00	0.69404E-01	0.43839E+00
0.15580E+04	0.48685E+00	0.13960E+00	0.67963E-01	0.42929E+00
0.15581E+04	0.47755E+00	0.13932E+00	0.66531E-01	0.42024E+00
0.15582E+04	0.46812E+00	0.13904E+00	0.65087E-01	0.41113E+00
0.15583E+04	0.45858E+00	0.13876E+00	0.63632E-01	0.40194E+00
0.15584E+04	0.44893E+00	0.13848E+00	0.62168E-01	0.39269E+00
0.15585E+04	0.43918E+00	0.13820E+00	0.60696E-01	0.38339E+00
0.15586E+04	0.42937E+00	0.13794E+00	0.59226E-01	0.37411E+00
0.15587E+04	0.41949E+00	0.13774E+00	0.57778E-01	0.36496E+00
0.15588E+04	0.40957E+00	0.13753E+00	0.56329E-01	0.35581E+00
0.15589E+04	0.39962E+00	0.13733E+00	0.54879E-01	0.34665E+00
0.15590E+04	0.38964E+00	0.13712E+00	0.53429E-01	0.33749E+00
0.15591E+04	0.37966E+00	0.13692E+00	0.51982E-01	0.32835E+00
0.15592E+04	0.36969E+00	0.13671E+00	0.50541E-01	0.31925E+00
0.15593E+04	0.35975E+00	0.13651E+00	0.49108E-01	0.31019E+00
0.15594E+04	0.34986E+00	0.13630E+00	0.47686E-01	0.30121E+00
0.15595E+04	0.34002E+00	0.13610E+00	0.46275E-01	0.29230E+00
0.15596E+04	0.33025E+00	0.13589E+00	0.44878E-01	0.28347E+00
0.15597E+04	0.32055E+00	0.13568E+00	0.43493E-01	0.27473E+00
0.15598E+04	0.31093E+00	0.13548E+00	0.42124E-01	0.26608E+00
0.15599E+04	0.30143E+00	0.13527E+00	0.40775E-01	0.25756E+00
0.15600E+04	0.29207E+00	0.13507E+00	0.39450E-01	0.24919E+00
0.15601E+04	0.28286E+00	0.13492E+00	0.38162E-01	0.24105E+00
0.15602E+04	0.27379E+00	0.13477E+00	0.36897E-01	0.23306E+00
0.15603E+04	0.26489E+00	0.13461E+00	0.35657E-01	0.22523E+00
0.15604E+04	0.25618E+00	0.13446E+00	0.34446E-01	0.21758E+00
0.15605E+04	0.24763E+00	0.13431E+00	0.33258E-01	0.21008E+00

0.15606E+04	0.23924E+00	0.13419E+00	0.32103E-01	0.20278E+00
0.15607E+04	0.23101E+00	0.13408E+00	0.30973E-01	0.19564E+00
0.15608E+04	0.22295E+00	0.13396E+00	0.29867E-01	0.18866E+00
0.15609E+04	0.21505E+00	0.13385E+00	0.28784E-01	0.18182E+00
0.15610E+04	0.20730E+00	0.13374E+00	0.27724E-01	0.17512E+00
0.15611E+04	0.19972E+00	0.13362E+00	0.26687E-01	0.16857E+00
0.15612E+04	0.19231E+00	0.13351E+00	0.25674E-01	0.16217E+00
0.15613E+04	0.18508E+00	0.13339E+00	0.24689E-01	0.15595E+00
0.15614E+04	0.17805E+00	0.13328E+00	0.23730E-01	0.14989E+00
0.15615E+04	0.17123E+00	0.13316E+00	0.22802E-01	0.14403E+00
0.15616E+04	0.16464E+00	0.13305E+00	0.21905E-01	0.13837E+00
0.15617E+04	0.15827E+00	0.13293E+00	0.21039E-01	0.13290E+00
0.15618E+04	0.15212E+00	0.13281E+00	0.20204E-01	0.12762E+00
0.15619E+04	0.14618E+00	0.13270E+00	0.19398E-01	0.12253E+00
0.15620E+04	0.14042E+00	0.13258E+00	0.18617E-01	0.11760E+00
0.15621E+04	0.13484E+00	0.13251E+00	0.17868E-01	0.11286E+00
0.15622E+04	0.12943E+00	0.13245E+00	0.17143E-01	0.10829E+00
0.15623E+04	0.12419E+00	0.13239E+00	0.16442E-01	0.10386E+00
0.15624E+04	0.11912E+00	0.13233E+00	0.15763E-01	0.99570E-01
0.15625E+04	0.11424E+00	0.13228E+00	0.15111E-01	0.95451E-01
0.15626E+04	0.10955E+00	0.13223E+00	0.14485E-01	0.91498E-01
0.15627E+04	0.10503E+00	0.13218E+00	0.13882E-01	0.87687E-01
0.15628E+04	0.10067E+00	0.13212E+00	0.13302E-01	0.84020E-01
0.15629E+04	0.96487E-01	0.13207E+00	0.12743E-01	0.80495E-01
0.15630E+04	0.92448E-01	0.13202E+00	0.12205E-01	0.77096E-01
0.15631E+04	0.88560E-01	0.13197E+00	0.11687E-01	0.73823E-01
0.15632E+04	0.84817E-01	0.13192E+00	0.11189E-01	0.70674E-01
0.15633E+04	0.81215E-01	0.13186E+00	0.10709E-01	0.67644E-01
0.15634E+04	0.77757E-01	0.13181E+00	0.10249E-01	0.64737E-01
0.15635E+04	0.74443E-01	0.13175E+00	0.98079E-02	0.61952E-01
0.15636E+04	0.71286E-01	0.13170E+00	0.93881E-02	0.59301E-01
0.15637E+04	0.68279E-01	0.13164E+00	0.89883E-02	0.56775E-01
0.15638E+04	0.65406E-01	0.13159E+00	0.86064E-02	0.54363E-01
0.15639E+04	0.62657E-01	0.13153E+00	0.82413E-02	0.52057E-01
0.15640E+04	0.60037E-01	0.13148E+00	0.78937E-02	0.49861E-01
0.15641E+04	0.57522E-01	0.13149E+00	0.75635E-02	0.47775E-01
0.15642E+04	0.55105E-01	0.13149E+00	0.72460E-02	0.45770E-01
0.15643E+04	0.52791E-01	0.13150E+00	0.69420E-02	0.43850E-01
0.15644E+04	0.50591E-01	0.13150E+00	0.66527E-02	0.42022E-01
0.15645E+04	0.48507E-01	0.13148E+00	0.63779E-02	0.40286E-01
0.15646E+04	0.46539E-01	0.13147E+00	0.61183E-02	0.38647E-01
0.15647E+04	0.44660E-01	0.13145E+00	0.58706E-02	0.37082E-01
0.15648E+04	0.42888E-01	0.13143E+00	0.56369E-02	0.35606E-01

0.15649E+04	0.41198E-01	0.13142E+00	0.54141E-02	0.34199E-01
0.15650E+04	0.39587E-01	0.13140E+00	0.52018E-02	0.32857E-01
0.15651E+04	0.38042E-01	0.13138E+00	0.49979E-02	0.31570E-01
0.15652E+04	0.36562E-01	0.13136E+00	0.48028E-02	0.30337E-01
0.15653E+04	0.35148E-01	0.13134E+00	0.46163E-02	0.29159E-01
0.15654E+04	0.33790E-01	0.13132E+00	0.44372E-02	0.28028E-01
0.15655E+04	0.32465E-01	0.13130E+00	0.42625E-02	0.26925E-01
0.15656E+04	0.31180E-01	0.13128E+00	0.40932E-02	0.25855E-01
0.15657E+04	0.29930E-01	0.13126E+00	0.39286E-02	0.24815E-01
0.15658E+04	0.28728E-01	0.13124E+00	0.37701E-02	0.23814E-01
0.15659E+04	0.27575E-01	0.13122E+00	0.36183E-02	0.22855E-01
0.15660E+04	0.26475E-01	0.13120E+00	0.34734E-02	0.21940E-01
0.15661E+04	0.25428E-01	0.13124E+00	0.33372E-02	0.21079E-01
0.15662E+04	0.24453E-01	0.13128E+00	0.32102E-02	0.20277E-01
0.15663E+04	0.23535E-01	0.13132E+00	0.30907E-02	0.19523E-01
0.15664E+04	0.22689E-01	0.13130E+00	0.29791E-02	0.18818E-01
0.15665E+04	0.21890E-01	0.13129E+00	0.28739E-02	0.18153E-01
0.15666E+04	0.21132E-01	0.13127E+00	0.27740E-02	0.17522E-01
0.15667E+04	0.20389E-01	0.13125E+00	0.26760E-02	0.16903E-01
0.15668E+04	0.19668E-01	0.13123E+00	0.25811E-02	0.16304E-01
0.15669E+04	0.18974E-01	0.13121E+00	0.24896E-02	0.15726E-01
0.15670E+04	0.18306E-01	0.13119E+00	0.24017E-02	0.15170E-01
0.15671E+04	0.17651E-01	0.13117E+00	0.23154E-02	0.14625E-01
0.15672E+04	0.17009E-01	0.13115E+00	0.22308E-02	0.14091E-01
0.15673E+04	0.16385E-01	0.13113E+00	0.21486E-02	0.13572E-01
0.15674E+04	0.15796E-01	0.13111E+00	0.20711E-02	0.13082E-01
0.15675E+04	0.15223E-01	0.13109E+00	0.19955E-02	0.12605E-01
0.15676E+04	0.14678E-01	0.13107E+00	0.19237E-02	0.12151E-01
0.15677E+04	0.14165E-01	0.13105E+00	0.18563E-02	0.11725E-01
0.15678E+04	0.13680E-01	0.13103E+00	0.17924E-02	0.11322E-01
0.15679E+04	0.13199E-01	0.13100E+00	0.17291E-02	0.10922E-01
0.15680E+04	0.12724E-01	0.13099E+00	0.16667E-02	0.10528E-01
0.15681E+04	0.12257E-01	0.13103E+00	0.16061E-02	0.10145E-01
0.15682E+04	0.11806E-01	0.13107E+00	0.15473E-02	0.97739E-02
0.15683E+04	0.11368E-01	0.13107E+00	0.14901E-02	0.94120E-02
0.15684E+04	0.10956E-01	0.13106E+00	0.14358E-02	0.90692E-02
0.15685E+04	0.10566E-01	0.13104E+00	0.13846E-02	0.87461E-02
0.15686E+04	0.10199E-01	0.13103E+00	0.13363E-02	0.84409E-02
0.15687E+04	0.98305E-02	0.13101E+00	0.12879E-02	0.81353E-02
0.15688E+04	0.94697E-02	0.13100E+00	0.12405E-02	0.78359E-02
0.15689E+04	0.91115E-02	0.13099E+00	0.11935E-02	0.75387E-02
0.15690E+04	0.87534E-02	0.13097E+00	0.11465E-02	0.72417E-02
0.15691E+04	0.84004E-02	0.13096E+00	0.11001E-02	0.69487E-02

0.15692E+04	0.80612E-02	0.13094E+00	0.10555E-02	0.66674E-02
0.15693E+04	0.77319E-02	0.13092E+00	0.10123E-02	0.63942E-02
0.15694E+04	0.74274E-02	0.13091E+00	0.97230E-03	0.61416E-02
0.15695E+04	0.71452E-02	0.13089E+00	0.93525E-03	0.59076E-02
0.15696E+04	0.68785E-02	0.13088E+00	0.90023E-03	0.56864E-02
0.15697E+04	0.66217E-02	0.13086E+00	0.86651E-03	0.54734E-02
0.15698E+04	0.63819E-02	0.13084E+00	0.83502E-03	0.52745E-02
0.15699E+04	0.61524E-02	0.13083E+00	0.80489E-03	0.50842E-02
0.15700E+04	0.59328E-02	0.13081E+00	0.77607E-03	0.49021E-02
0.15701E+04	0.57233E-02	0.13084E+00	0.74885E-03	0.47302E-02
0.15702E+04	0.55252E-02	0.13088E+00	0.72313E-03	0.45677E-02
0.15703E+04	0.53399E-02	0.13091E+00	0.69905E-03	0.44156E-02
0.15704E+04	0.51708E-02	0.13094E+00	0.67707E-03	0.42768E-02
0.15705E+04	0.50103E-02	0.13097E+00	0.65621E-03	0.41450E-02
0.15706E+04	0.48590E-02	0.13100E+00	0.63654E-03	0.40208E-02
0.15707E+04	0.47156E-02	0.13103E+00	0.61789E-03	0.39029E-02
0.15708E+04	0.45781E-02	0.13106E+00	0.60001E-03	0.37900E-02
0.15709E+04	0.44566E-02	0.13109E+00	0.58422E-03	0.36903E-02
0.15710E+04	0.43543E-02	0.13112E+00	0.57093E-03	0.36063E-02
0.15711E+04	0.42583E-02	0.13115E+00	0.55846E-03	0.35275E-02
0.15712E+04	0.41637E-02	0.13117E+00	0.54616E-03	0.34499E-02
0.15713E+04	0.40683E-02	0.13120E+00	0.53376E-03	0.33715E-02
0.15714E+04	0.39696E-02	0.13123E+00	0.52093E-03	0.32905E-02
0.15715E+04	0.38688E-02	0.13126E+00	0.50780E-03	0.32076E-02
0.15716E+04	0.37645E-02	0.13128E+00	0.49420E-03	0.31217E-02
0.15717E+04	0.36536E-02	0.13131E+00	0.47974E-03	0.30303E-02
0.15718E+04	0.35334E-02	0.13133E+00	0.46404E-03	0.29312E-02
0.15719E+04	0.34082E-02	0.13136E+00	0.44770E-03	0.28279E-02
0.15720E+04	0.32783E-02	0.13138E+00	0.43071E-03	0.27206E-02
0.15721E+04	0.31478E-02	0.13146E+00	0.41381E-03	0.26138E-02
0.15722E+04	0.30174E-02	0.13156E+00	0.39699E-03	0.25076E-02
0.15723E+04	0.29006E-02	0.13167E+00	0.38191E-03	0.24124E-02
0.15724E+04	0.28026E-02	0.13177E+00	0.36930E-03	0.23327E-02
0.15725E+04	0.27176E-02	0.13187E+00	0.35839E-03	0.22638E-02
0.15726E+04	0.26448E-02	0.13198E+00	0.34905E-03	0.22048E-02
0.15727E+04	0.25779E-02	0.13208E+00	0.34049E-03	0.21507E-02
0.15728E+04	0.25149E-02	0.13218E+00	0.33243E-03	0.20998E-02
0.15729E+04	0.24467E-02	0.13228E+00	0.32367E-03	0.20445E-02
0.15730E+04	0.23692E-02	0.13239E+00	0.31364E-03	0.19811E-02
0.15731E+04	0.22808E-02	0.13249E+00	0.30218E-03	0.19087E-02
0.15732E+04	0.21796E-02	0.13258E+00	0.28899E-03	0.18254E-02
0.15733E+04	0.20802E-02	0.13268E+00	0.27600E-03	0.17434E-02
0.15734E+04	0.19870E-02	0.13278E+00	0.26384E-03	0.16665E-02

0.15735E+04	0.18974E-02	0.13288E+00	0.25213E-03	0.15926E-02
0.15736E+04	0.18108E-02	0.13298E+00	0.24079E-03	0.15210E-02
0.15737E+04	0.17275E-02	0.13307E+00	0.22988E-03	0.14521E-02
0.15738E+04	0.16477E-02	0.13317E+00	0.21943E-03	0.13861E-02
0.15739E+04	0.15730E-02	0.13327E+00	0.20963E-03	0.13242E-02
0.15740E+04	0.15039E-02	0.13337E+00	0.20058E-03	0.12670E-02
0.15741E+04	0.14288E-02	0.13352E+00	0.19078E-03	0.12051E-02
0.15742E+04	0.13429E-02	0.13369E+00	0.17954E-03	0.11341E-02
0.15743E+04	0.12564E-02	0.13385E+00	0.16818E-03	0.10623E-02
0.15744E+04	0.11722E-02	0.13402E+00	0.15710E-03	0.99233E-03
0.15745E+04	0.10969E-02	0.13418E+00	0.14719E-03	0.92971E-03
0.15746E+04	0.10335E-02	0.13435E+00	0.13884E-03	0.87702E-03
0.15747E+04	0.97970E-03	0.13451E+00	0.13178E-03	0.83239E-03
0.15748E+04	0.93573E-03	0.13467E+00	0.12602E-03	0.79599E-03
0.15749E+04	0.88587E-03	0.13483E+00	0.11944E-03	0.75448E-03
0.15750E+04	0.82394E-03	0.13500E+00	0.11123E-03	0.70259E-03
0.15751E+04	0.76029E-03	0.13516E+00	0.10276E-03	0.64908E-03
0.15752E+04	0.69757E-03	0.13532E+00	0.94393E-04	0.59624E-03
0.15753E+04	0.63400E-03	0.13548E+00	0.85891E-04	0.54254E-03
0.15754E+04	0.56870E-03	0.13563E+00	0.77136E-04	0.48723E-03
0.15755E+04	0.50723E-03	0.13579E+00	0.68878E-04	0.43507E-03
0.15756E+04	0.45159E-03	0.13595E+00	0.61394E-04	0.38780E-03
0.15757E+04	0.39698E-03	0.13611E+00	0.54033E-04	0.34130E-03
0.15758E+04	0.34178E-03	0.13627E+00	0.46574E-04	0.29419E-03
0.15759E+04	0.29717E-03	0.13642E+00	0.40541E-04	0.25608E-03
0.15760E+04	0.26774E-03	0.13659E+00	0.36572E-04	0.23101E-03
0.15761E+04	0.24073E-03	0.13680E+00	0.32932E-04	0.20802E-03
0.15762E+04	0.21200E-03	0.13701E+00	0.29045E-04	0.18347E-03
0.15763E+04	0.18045E-03	0.13721E+00	0.24760E-04	0.15640E-03
0.15764E+04	0.14492E-03	0.13740E+00	0.19913E-04	0.12578E-03
0.15765E+04	0.10225E-03	0.13760E+00	0.14070E-04	0.88876E-04
0.15766E+04	0.50300E-04	0.13780E+00	0.69312E-05	0.43782E-04
0.15767E+04	0.45700E-05	0.13799E+00	0.63063E-06	0.39834E-05
0.15768E+04	0.00000E+00	0.13819E+00	0.00000E+00	0.00000E+00
Channel 13				
Wavenumber	HIRS Filter Transmittance	Optical Element Transmittance	Product of the HIRS Filter and Optical Element Transmittances	Normalized Value of Column 4
0.21584E+04	0.00000E+00	0.27612E+00	0.00000E+00	0.00000E+00
0.21585E+04	0.44959E-04	0.27618E+00	0.12417E-04	0.69349E-04
0.21586E+04	0.10424E-03	0.27623E+00	0.28794E-04	0.16082E-03
0.21587E+04	0.16871E-03	0.27629E+00	0.46613E-04	0.26034E-03

0.21588E+04	0.23522E-03	0.27635E+00	0.65003E-04	0.36306E-03
0.21589E+04	0.30409E-03	0.27640E+00	0.84050E-04	0.46944E-03
0.21590E+04	0.37448E-03	0.27646E+00	0.10353E-03	0.57822E-03
0.21591E+04	0.44652E-03	0.27652E+00	0.12347E-03	0.68961E-03
0.21592E+04	0.52599E-03	0.27657E+00	0.14547E-03	0.81250E-03
0.21593E+04	0.60792E-03	0.27663E+00	0.16817E-03	0.93925E-03
0.21594E+04	0.69246E-03	0.27669E+00	0.19159E-03	0.10701E-02
0.21595E+04	0.77827E-03	0.27674E+00	0.21538E-03	0.12030E-02
0.21596E+04	0.86668E-03	0.27680E+00	0.23990E-03	0.13399E-02
0.21597E+04	0.95661E-03	0.27686E+00	0.26485E-03	0.14793E-02
0.21598E+04	0.10478E-02	0.27692E+00	0.29017E-03	0.16207E-02
0.21599E+04	0.11426E-02	0.27698E+00	0.31649E-03	0.17677E-02
0.21600E+04	0.12392E-02	0.27704E+00	0.34332E-03	0.19175E-02
0.21601E+04	0.13361E-02	0.27709E+00	0.37021E-03	0.20677E-02
0.21602E+04	0.14331E-02	0.27714E+00	0.39716E-03	0.22182E-02
0.21603E+04	0.15301E-02	0.27718E+00	0.42413E-03	0.23689E-02
0.21604E+04	0.16278E-02	0.27723E+00	0.45127E-03	0.25205E-02
0.21605E+04	0.17280E-02	0.27728E+00	0.47912E-03	0.26760E-02
0.21606E+04	0.18295E-02	0.27732E+00	0.50737E-03	0.28337E-02
0.21607E+04	0.19322E-02	0.27737E+00	0.53594E-03	0.29933E-02
0.21608E+04	0.20354E-02	0.27742E+00	0.56465E-03	0.31537E-02
0.21609E+04	0.21427E-02	0.27746E+00	0.59452E-03	0.33205E-02
0.21610E+04	0.22506E-02	0.27751E+00	0.62457E-03	0.34884E-02
0.21611E+04	0.23589E-02	0.27756E+00	0.65473E-03	0.36568E-02
0.21612E+04	0.24685E-02	0.27761E+00	0.68528E-03	0.38274E-02
0.21613E+04	0.25788E-02	0.27765E+00	0.71602E-03	0.39991E-02
0.21614E+04	0.26919E-02	0.27770E+00	0.74754E-03	0.41752E-02
0.21615E+04	0.28125E-02	0.27775E+00	0.78117E-03	0.43630E-02
0.21616E+04	0.29345E-02	0.27779E+00	0.81519E-03	0.45530E-02
0.21617E+04	0.30568E-02	0.27784E+00	0.84929E-03	0.47435E-02
0.21618E+04	0.31815E-02	0.27788E+00	0.88409E-03	0.49378E-02
0.21619E+04	0.33065E-02	0.27793E+00	0.91897E-03	0.51326E-02
0.21620E+04	0.34367E-02	0.27797E+00	0.95531E-03	0.53356E-02
0.21621E+04	0.35759E-02	0.27801E+00	0.99414E-03	0.55525E-02
0.21622E+04	0.37159E-02	0.27804E+00	0.10332E-02	0.57706E-02
0.21623E+04	0.38615E-02	0.27808E+00	0.10738E-02	0.59974E-02
0.21624E+04	0.40203E-02	0.27811E+00	0.11181E-02	0.62448E-02
0.21625E+04	0.41836E-02	0.27814E+00	0.11636E-02	0.64992E-02
0.21626E+04	0.43508E-02	0.27817E+00	0.12103E-02	0.67597E-02
0.21627E+04	0.45298E-02	0.27821E+00	0.12602E-02	0.70386E-02
0.21628E+04	0.47174E-02	0.27824E+00	0.13125E-02	0.73308E-02
0.21629E+04	0.49183E-02	0.27827E+00	0.13686E-02	0.76440E-02
0.21630E+04	0.51580E-02	0.27830E+00	0.14355E-02	0.80174E-02

0.21631E+04	0.54001E-02	0.27833E+00	0.15030E-02	0.83946E-02
0.21632E+04	0.56442E-02	0.27836E+00	0.15711E-02	0.87752E-02
0.21633E+04	0.58930E-02	0.27840E+00	0.16406E-02	0.91629E-02
0.21634E+04	0.61439E-02	0.27843E+00	0.17106E-02	0.95542E-02
0.21635E+04	0.64161E-02	0.27846E+00	0.17866E-02	0.99787E-02
0.21636E+04	0.66907E-02	0.27849E+00	0.18633E-02	0.10407E-01
0.21637E+04	0.69668E-02	0.27853E+00	0.19404E-02	0.10838E-01
0.21638E+04	0.72653E-02	0.27856E+00	0.20238E-02	0.11303E-01
0.21639E+04	0.75686E-02	0.27859E+00	0.21086E-02	0.11777E-01
0.21640E+04	0.78723E-02	0.27863E+00	0.21935E-02	0.12251E-01
0.21641E+04	0.82110E-02	0.27868E+00	0.22882E-02	0.12780E-01
0.21642E+04	0.85609E-02	0.27872E+00	0.23861E-02	0.13327E-01
0.21643E+04	0.89279E-02	0.27877E+00	0.24888E-02	0.13901E-01
0.21644E+04	0.92994E-02	0.27882E+00	0.25928E-02	0.14482E-01
0.21645E+04	0.96764E-02	0.27886E+00	0.26984E-02	0.15071E-01
0.21646E+04	0.10055E-01	0.27892E+00	0.28044E-02	0.15663E-01
0.21647E+04	0.10438E-01	0.27897E+00	0.29120E-02	0.16264E-01
0.21648E+04	0.10824E-01	0.27902E+00	0.30200E-02	0.16867E-01
0.21649E+04	0.11217E-01	0.27907E+00	0.31305E-02	0.17484E-01
0.21650E+04	0.11617E-01	0.27912E+00	0.32426E-02	0.18110E-01
0.21651E+04	0.12017E-01	0.27919E+00	0.33550E-02	0.18738E-01
0.21652E+04	0.12424E-01	0.27925E+00	0.34695E-02	0.19378E-01
0.21653E+04	0.12841E-01	0.27932E+00	0.35866E-02	0.20032E-01
0.21654E+04	0.13264E-01	0.27938E+00	0.37059E-02	0.20698E-01
0.21655E+04	0.13691E-01	0.27945E+00	0.38260E-02	0.21369E-01
0.21656E+04	0.14122E-01	0.27951E+00	0.39472E-02	0.22046E-01
0.21657E+04	0.14553E-01	0.27957E+00	0.40685E-02	0.22723E-01
0.21658E+04	0.15031E-01	0.27963E+00	0.42033E-02	0.23476E-01
0.21659E+04	0.15575E-01	0.27970E+00	0.43563E-02	0.24331E-01
0.21660E+04	0.16169E-01	0.27976E+00	0.45234E-02	0.25264E-01
0.21661E+04	0.16753E-01	0.27982E+00	0.46877E-02	0.26182E-01
0.21662E+04	0.17327E-01	0.27988E+00	0.48495E-02	0.27085E-01
0.21663E+04	0.17898E-01	0.27995E+00	0.50106E-02	0.27985E-01
0.21664E+04	0.18430E-01	0.28001E+00	0.51606E-02	0.28823E-01
0.21665E+04	0.18948E-01	0.28007E+00	0.53069E-02	0.29640E-01
0.21666E+04	0.19484E-01	0.28013E+00	0.54582E-02	0.30485E-01
0.21667E+04	0.20070E-01	0.28019E+00	0.56236E-02	0.31409E-01
0.21668E+04	0.20669E-01	0.28025E+00	0.57925E-02	0.32352E-01
0.21669E+04	0.21279E-01	0.28032E+00	0.59648E-02	0.33314E-01
0.21670E+04	0.21962E-01	0.28038E+00	0.61578E-02	0.34392E-01
0.21671E+04	0.22672E-01	0.28043E+00	0.63580E-02	0.35511E-01
0.21672E+04	0.23393E-01	0.28049E+00	0.65616E-02	0.36648E-01
0.21673E+04	0.24143E-01	0.28055E+00	0.67734E-02	0.37831E-01

0.21674E+04	0.24917E-01	0.28061E+00	0.69921E-02	0.39052E-01
0.21675E+04	0.25779E-01	0.28067E+00	0.72352E-02	0.40410E-01
0.21676E+04	0.26736E-01	0.28072E+00	0.75054E-02	0.41919E-01
0.21677E+04	0.27782E-01	0.28078E+00	0.78007E-02	0.43568E-01
0.21678E+04	0.28925E-01	0.28084E+00	0.81232E-02	0.45370E-01
0.21679E+04	0.30110E-01	0.28089E+00	0.84578E-02	0.47238E-01
0.21680E+04	0.31334E-01	0.28095E+00	0.88032E-02	0.49168E-01
0.21681E+04	0.32608E-01	0.28101E+00	0.91633E-02	0.51179E-01
0.21682E+04	0.33947E-01	0.28107E+00	0.95415E-02	0.53291E-01
0.21683E+04	0.35372E-01	0.28113E+00	0.99443E-02	0.55541E-01
0.21684E+04	0.36892E-01	0.28119E+00	0.10374E-01	0.57940E-01
0.21685E+04	0.38504E-01	0.28125E+00	0.10829E-01	0.60483E-01
0.21686E+04	0.40171E-01	0.28131E+00	0.11301E-01	0.63116E-01
0.21687E+04	0.41901E-01	0.28138E+00	0.11790E-01	0.65849E-01
0.21688E+04	0.43698E-01	0.28144E+00	0.12298E-01	0.68688E-01
0.21689E+04	0.45551E-01	0.28150E+00	0.12823E-01	0.71617E-01
0.21690E+04	0.47452E-01	0.28156E+00	0.13361E-01	0.74623E-01
0.21691E+04	0.49400E-01	0.28163E+00	0.13913E-01	0.77705E-01
0.21692E+04	0.51422E-01	0.28170E+00	0.14485E-01	0.80904E-01
0.21693E+04	0.53571E-01	0.28176E+00	0.15094E-01	0.84305E-01
0.21694E+04	0.55844E-01	0.28183E+00	0.15738E-01	0.87903E-01
0.21695E+04	0.58210E-01	0.28189E+00	0.16409E-01	0.91649E-01
0.21696E+04	0.60652E-01	0.28197E+00	0.17102E-01	0.95517E-01
0.21697E+04	0.63160E-01	0.28204E+00	0.17813E-01	0.99491E-01
0.21698E+04	0.65732E-01	0.28211E+00	0.18543E-01	0.10357E+00
0.21699E+04	0.68407E-01	0.28218E+00	0.19303E-01	0.10781E+00
0.21700E+04	0.71193E-01	0.28225E+00	0.20094E-01	0.11223E+00
0.21701E+04	0.74096E-01	0.28232E+00	0.20919E-01	0.11684E+00
0.21702E+04	0.77106E-01	0.28239E+00	0.21774E-01	0.12161E+00
0.21703E+04	0.80215E-01	0.28246E+00	0.22658E-01	0.12655E+00
0.21704E+04	0.83417E-01	0.28254E+00	0.23568E-01	0.13163E+00
0.21705E+04	0.86706E-01	0.28261E+00	0.24504E-01	0.13686E+00
0.21706E+04	0.90068E-01	0.28268E+00	0.25461E-01	0.14220E+00
0.21707E+04	0.93542E-01	0.28276E+00	0.26450E-01	0.14773E+00
0.21708E+04	0.97116E-01	0.28283E+00	0.27468E-01	0.15341E+00
0.21709E+04	0.10080E+00	0.28291E+00	0.28517E-01	0.15927E+00
0.21710E+04	0.10462E+00	0.28298E+00	0.29606E-01	0.16535E+00
0.21711E+04	0.10859E+00	0.28306E+00	0.30738E-01	0.17168E+00
0.21712E+04	0.11270E+00	0.28314E+00	0.31910E-01	0.17822E+00
0.21713E+04	0.11691E+00	0.28321E+00	0.33110E-01	0.18493E+00
0.21714E+04	0.12117E+00	0.28329E+00	0.34325E-01	0.19171E+00
0.21715E+04	0.12552E+00	0.28337E+00	0.35569E-01	0.19866E+00
0.21716E+04	0.12999E+00	0.28344E+00	0.36845E-01	0.20579E+00

0.21717E+04	0.13462E+00	0.28352E+00	0.38167E-01	0.21317E+00
0.21718E+04	0.13943E+00	0.28360E+00	0.39543E-01	0.22086E+00
0.21719E+04	0.14442E+00	0.28367E+00	0.40967E-01	0.22881E+00
0.21720E+04	0.14954E+00	0.28375E+00	0.42431E-01	0.23699E+00
0.21721E+04	0.15482E+00	0.28382E+00	0.43941E-01	0.24542E+00
0.21722E+04	0.16024E+00	0.28389E+00	0.45492E-01	0.25408E+00
0.21723E+04	0.16579E+00	0.28397E+00	0.47080E-01	0.26295E+00
0.21724E+04	0.17147E+00	0.28404E+00	0.48703E-01	0.27202E+00
0.21725E+04	0.17726E+00	0.28411E+00	0.50361E-01	0.28128E+00
0.21726E+04	0.18317E+00	0.28419E+00	0.52054E-01	0.29073E+00
0.21727E+04	0.18915E+00	0.28426E+00	0.53766E-01	0.30030E+00
0.21728E+04	0.19517E+00	0.28433E+00	0.55492E-01	0.30993E+00
0.21729E+04	0.20124E+00	0.28440E+00	0.57234E-01	0.31966E+00
0.21730E+04	0.20735E+00	0.28447E+00	0.58985E-01	0.32944E+00
0.21731E+04	0.21346E+00	0.28455E+00	0.60738E-01	0.33924E+00
0.21732E+04	0.21958E+00	0.28462E+00	0.62497E-01	0.34906E+00
0.21733E+04	0.22578E+00	0.28469E+00	0.64279E-01	0.35901E+00
0.21734E+04	0.23208E+00	0.28477E+00	0.66088E-01	0.36912E+00
0.21735E+04	0.23840E+00	0.28484E+00	0.67907E-01	0.37927E+00
0.21736E+04	0.24474E+00	0.28491E+00	0.69731E-01	0.38946E+00
0.21737E+04	0.25109E+00	0.28499E+00	0.71559E-01	0.39967E+00
0.21738E+04	0.25746E+00	0.28506E+00	0.73392E-01	0.40991E+00
0.21739E+04	0.26382E+00	0.28514E+00	0.75226E-01	0.42015E+00
0.21740E+04	0.27019E+00	0.28521E+00	0.77061E-01	0.43040E+00
0.21741E+04	0.27655E+00	0.28529E+00	0.78898E-01	0.44066E+00
0.21742E+04	0.28291E+00	0.28537E+00	0.80733E-01	0.45091E+00
0.21743E+04	0.28925E+00	0.28545E+00	0.82565E-01	0.46115E+00
0.21744E+04	0.29559E+00	0.28553E+00	0.84398E-01	0.47138E+00
0.21745E+04	0.30192E+00	0.28561E+00	0.86231E-01	0.48162E+00
0.21746E+04	0.30826E+00	0.28569E+00	0.88066E-01	0.49187E+00
0.21747E+04	0.31458E+00	0.28577E+00	0.89896E-01	0.50209E+00
0.21748E+04	0.32084E+00	0.28585E+00	0.91713E-01	0.51223E+00
0.21749E+04	0.32704E+00	0.28593E+00	0.93510E-01	0.52227E+00
0.21750E+04	0.33316E+00	0.28601E+00	0.95287E-01	0.53220E+00
0.21751E+04	0.33924E+00	0.28609E+00	0.97054E-01	0.54207E+00
0.21752E+04	0.34531E+00	0.28617E+00	0.98817E-01	0.55191E+00
0.21753E+04	0.35133E+00	0.28625E+00	0.10057E+00	0.56170E+00
0.21754E+04	0.35730E+00	0.28633E+00	0.10231E+00	0.57140E+00
0.21755E+04	0.36322E+00	0.28641E+00	0.10403E+00	0.58102E+00
0.21756E+04	0.36907E+00	0.28648E+00	0.10573E+00	0.59054E+00
0.21757E+04	0.37484E+00	0.28656E+00	0.10741E+00	0.59993E+00
0.21758E+04	0.38050E+00	0.28664E+00	0.10907E+00	0.60916E+00
0.21759E+04	0.38607E+00	0.28671E+00	0.11069E+00	0.61824E+00

0.21760E+04	0.39157E+00	0.28679E+00	0.11230E+00	0.62721E+00
0.21761E+04	0.39700E+00	0.28688E+00	0.11389E+00	0.63612E+00
0.21762E+04	0.40236E+00	0.28698E+00	0.11547E+00	0.64491E+00
0.21763E+04	0.40765E+00	0.28707E+00	0.11702E+00	0.65360E+00
0.21764E+04	0.41286E+00	0.28716E+00	0.11856E+00	0.66217E+00
0.21765E+04	0.41799E+00	0.28725E+00	0.12007E+00	0.67060E+00
0.21766E+04	0.42301E+00	0.28734E+00	0.12154E+00	0.67885E+00
0.21767E+04	0.42793E+00	0.28742E+00	0.12300E+00	0.68696E+00
0.21768E+04	0.43277E+00	0.28751E+00	0.12442E+00	0.69494E+00
0.21769E+04	0.43753E+00	0.28759E+00	0.12583E+00	0.70279E+00
0.21770E+04	0.44221E+00	0.28768E+00	0.12721E+00	0.71050E+00
0.21771E+04	0.44679E+00	0.28775E+00	0.12857E+00	0.71807E+00
0.21772E+04	0.45128E+00	0.28783E+00	0.12989E+00	0.72547E+00
0.21773E+04	0.45568E+00	0.28791E+00	0.13119E+00	0.73275E+00
0.21774E+04	0.45999E+00	0.28799E+00	0.13247E+00	0.73989E+00
0.21775E+04	0.46418E+00	0.28807E+00	0.13372E+00	0.74683E+00
0.21776E+04	0.46823E+00	0.28814E+00	0.13491E+00	0.75352E+00
0.21777E+04	0.47212E+00	0.28821E+00	0.13607E+00	0.75998E+00
0.21778E+04	0.47587E+00	0.28828E+00	0.13719E+00	0.76621E+00
0.21779E+04	0.47953E+00	0.28836E+00	0.13828E+00	0.77230E+00
0.21780E+04	0.48311E+00	0.28843E+00	0.13934E+00	0.77825E+00
0.21781E+04	0.48660E+00	0.28849E+00	0.14038E+00	0.78405E+00
0.21782E+04	0.48999E+00	0.28855E+00	0.14139E+00	0.78967E+00
0.21783E+04	0.49326E+00	0.28861E+00	0.14236E+00	0.79509E+00
0.21784E+04	0.49639E+00	0.28866E+00	0.14329E+00	0.80030E+00
0.21785E+04	0.49942E+00	0.28872E+00	0.14419E+00	0.80536E+00
0.21786E+04	0.50236E+00	0.28878E+00	0.14507E+00	0.81026E+00
0.21787E+04	0.50523E+00	0.28884E+00	0.14593E+00	0.81505E+00
0.21788E+04	0.50802E+00	0.28890E+00	0.14677E+00	0.81972E+00
0.21789E+04	0.51073E+00	0.28895E+00	0.14758E+00	0.82425E+00
0.21790E+04	0.51338E+00	0.28901E+00	0.14837E+00	0.82869E+00
0.21791E+04	0.51594E+00	0.28907E+00	0.14914E+00	0.83300E+00
0.21792E+04	0.51844E+00	0.28913E+00	0.14989E+00	0.83719E+00
0.21793E+04	0.52085E+00	0.28919E+00	0.15062E+00	0.84125E+00
0.21794E+04	0.52315E+00	0.28924E+00	0.15132E+00	0.84514E+00
0.21795E+04	0.52538E+00	0.28930E+00	0.15199E+00	0.84890E+00
0.21796E+04	0.52753E+00	0.28936E+00	0.15265E+00	0.85256E+00
0.21797E+04	0.52962E+00	0.28942E+00	0.15328E+00	0.85610E+00
0.21798E+04	0.53168E+00	0.28948E+00	0.15391E+00	0.85961E+00
0.21799E+04	0.53370E+00	0.28953E+00	0.15452E+00	0.86305E+00
0.21800E+04	0.53568E+00	0.28959E+00	0.15513E+00	0.86641E+00
0.21801E+04	0.53764E+00	0.28962E+00	0.15571E+00	0.86968E+00
0.21802E+04	0.53960E+00	0.28965E+00	0.15630E+00	0.87295E+00

0.21803E+04	0.54153E+00	0.28969E+00	0.15687E+00	0.87618E+00
0.21804E+04	0.54345E+00	0.28972E+00	0.15745E+00	0.87938E+00
0.21805E+04	0.54533E+00	0.28975E+00	0.15801E+00	0.88252E+00
0.21806E+04	0.54714E+00	0.28979E+00	0.15856E+00	0.88556E+00
0.21807E+04	0.54891E+00	0.28982E+00	0.15909E+00	0.88853E+00
0.21808E+04	0.55065E+00	0.28985E+00	0.15961E+00	0.89144E+00
0.21809E+04	0.55236E+00	0.28989E+00	0.16012E+00	0.89431E+00
0.21810E+04	0.55407E+00	0.28992E+00	0.16064E+00	0.89719E+00
0.21811E+04	0.55578E+00	0.28995E+00	0.16115E+00	0.90005E+00
0.21812E+04	0.55747E+00	0.28999E+00	0.16166E+00	0.90290E+00
0.21813E+04	0.55919E+00	0.29002E+00	0.16217E+00	0.90578E+00
0.21814E+04	0.56094E+00	0.29005E+00	0.16270E+00	0.90872E+00
0.21815E+04	0.56272E+00	0.29008E+00	0.16324E+00	0.91171E+00
0.21816E+04	0.56450E+00	0.29011E+00	0.16377E+00	0.91469E+00
0.21817E+04	0.56625E+00	0.29015E+00	0.16429E+00	0.91761E+00
0.21818E+04	0.56794E+00	0.29018E+00	0.16480E+00	0.92045E+00
0.21819E+04	0.56960E+00	0.29021E+00	0.16530E+00	0.92325E+00
0.21820E+04	0.57126E+00	0.29024E+00	0.16580E+00	0.92605E+00
0.21821E+04	0.57291E+00	0.29029E+00	0.16631E+00	0.92888E+00
0.21822E+04	0.57452E+00	0.29035E+00	0.16681E+00	0.93166E+00
0.21823E+04	0.57612E+00	0.29040E+00	0.16730E+00	0.93442E+00
0.21824E+04	0.57769E+00	0.29045E+00	0.16779E+00	0.93714E+00
0.21825E+04	0.57923E+00	0.29050E+00	0.16827E+00	0.93980E+00
0.21826E+04	0.58077E+00	0.29055E+00	0.16874E+00	0.94247E+00
0.21827E+04	0.58231E+00	0.29060E+00	0.16922E+00	0.94513E+00
0.21828E+04	0.58381E+00	0.29066E+00	0.16969E+00	0.94773E+00
0.21829E+04	0.58527E+00	0.29071E+00	0.17014E+00	0.95028E+00
0.21830E+04	0.58671E+00	0.29076E+00	0.17059E+00	0.95279E+00
0.21831E+04	0.58816E+00	0.29081E+00	0.17105E+00	0.95532E+00
0.21832E+04	0.58965E+00	0.29087E+00	0.17151E+00	0.95792E+00
0.21833E+04	0.59114E+00	0.29092E+00	0.17198E+00	0.96052E+00
0.21834E+04	0.59259E+00	0.29098E+00	0.17243E+00	0.96306E+00
0.21835E+04	0.59399E+00	0.29103E+00	0.17287E+00	0.96552E+00
0.21836E+04	0.59531E+00	0.29109E+00	0.17329E+00	0.96786E+00
0.21837E+04	0.59657E+00	0.29115E+00	0.17369E+00	0.97010E+00
0.21838E+04	0.59781E+00	0.29121E+00	0.17409E+00	0.97232E+00
0.21839E+04	0.59903E+00	0.29127E+00	0.17448E+00	0.97449E+00
0.21840E+04	0.60021E+00	0.29132E+00	0.17485E+00	0.97659E+00
0.21841E+04	0.60136E+00	0.29137E+00	0.17522E+00	0.97861E+00
0.21842E+04	0.60249E+00	0.29141E+00	0.17557E+00	0.98061E+00
0.21843E+04	0.60359E+00	0.29146E+00	0.17592E+00	0.98256E+00
0.21844E+04	0.60466E+00	0.29150E+00	0.17626E+00	0.98445E+00
0.21845E+04	0.60565E+00	0.29155E+00	0.17658E+00	0.98622E+00

0.21846E+04	0.60655E+00	0.29160E+00	0.17687E+00	0.98786E+00
0.21847E+04	0.60738E+00	0.29165E+00	0.17714E+00	0.98938E+00
0.21848E+04	0.60814E+00	0.29170E+00	0.17739E+00	0.99078E+00
0.21849E+04	0.60884E+00	0.29175E+00	0.17763E+00	0.99208E+00
0.21850E+04	0.60947E+00	0.29180E+00	0.17784E+00	0.99328E+00
0.21851E+04	0.61004E+00	0.29183E+00	0.17803E+00	0.99433E+00
0.21852E+04	0.61058E+00	0.29186E+00	0.17821E+00	0.99533E+00
0.21853E+04	0.61110E+00	0.29190E+00	0.17838E+00	0.99629E+00
0.21854E+04	0.61159E+00	0.29193E+00	0.17855E+00	0.99721E+00
0.21855E+04	0.61203E+00	0.29197E+00	0.17869E+00	0.99804E+00
0.21856E+04	0.61239E+00	0.29200E+00	0.17882E+00	0.99875E+00
0.21857E+04	0.61266E+00	0.29204E+00	0.17892E+00	0.99930E+00
0.21858E+04	0.61280E+00	0.29207E+00	0.17898E+00	0.99965E+00
0.21859E+04	0.61286E+00	0.29210E+00	0.17902E+00	0.99986E+00
0.21860E+04	0.61286E+00	0.29214E+00	0.17904E+00	0.99997E+00
0.21861E+04	0.61282E+00	0.29217E+00	0.17904E+00	0.10000E+01
0.21862E+04	0.61272E+00	0.29219E+00	0.17903E+00	0.99993E+00
0.21863E+04	0.61253E+00	0.29223E+00	0.17900E+00	0.99977E+00
0.21864E+04	0.61230E+00	0.29229E+00	0.17897E+00	0.99958E+00
0.21865E+04	0.61202E+00	0.29234E+00	0.17892E+00	0.99931E+00
0.21866E+04	0.61170E+00	0.29239E+00	0.17886E+00	0.99895E+00
0.21867E+04	0.61129E+00	0.29244E+00	0.17877E+00	0.99846E+00
0.21868E+04	0.61078E+00	0.29249E+00	0.17865E+00	0.99779E+00
0.21869E+04	0.61015E+00	0.29254E+00	0.17850E+00	0.99693E+00
0.21870E+04	0.60944E+00	0.29259E+00	0.17832E+00	0.99593E+00
0.21871E+04	0.60865E+00	0.29264E+00	0.17812E+00	0.99481E+00
0.21872E+04	0.60783E+00	0.29268E+00	0.17790E+00	0.99362E+00
0.21873E+04	0.60696E+00	0.29273E+00	0.17767E+00	0.99235E+00
0.21874E+04	0.60600E+00	0.29277E+00	0.17742E+00	0.99094E+00
0.21875E+04	0.60496E+00	0.29282E+00	0.17715E+00	0.98939E+00
0.21876E+04	0.60387E+00	0.29286E+00	0.17685E+00	0.98775E+00
0.21877E+04	0.60273E+00	0.29291E+00	0.17654E+00	0.98603E+00
0.21878E+04	0.60156E+00	0.29295E+00	0.17623E+00	0.98428E+00
0.21879E+04	0.60034E+00	0.29300E+00	0.17590E+00	0.98242E+00
0.21880E+04	0.59903E+00	0.29304E+00	0.17554E+00	0.98043E+00
0.21881E+04	0.59766E+00	0.29308E+00	0.17516E+00	0.97832E+00
0.21882E+04	0.59623E+00	0.29312E+00	0.17477E+00	0.97611E+00
0.21883E+04	0.59472E+00	0.29316E+00	0.17435E+00	0.97378E+00
0.21884E+04	0.59313E+00	0.29320E+00	0.17391E+00	0.97131E+00
0.21885E+04	0.59140E+00	0.29324E+00	0.17342E+00	0.96861E+00
0.21886E+04	0.58952E+00	0.29329E+00	0.17290E+00	0.96568E+00
0.21887E+04	0.58753E+00	0.29333E+00	0.17234E+00	0.96255E+00
0.21888E+04	0.58546E+00	0.29337E+00	0.17176E+00	0.95931E+00

0.21889E+04	0.58335E+00	0.29342E+00	0.17117E+00	0.95600E+00
0.21890E+04	0.58123E+00	0.29346E+00	0.17057E+00	0.95267E+00
0.21891E+04	0.57905E+00	0.29351E+00	0.16996E+00	0.94925E+00
0.21892E+04	0.57681E+00	0.29356E+00	0.16933E+00	0.94573E+00
0.21893E+04	0.57452E+00	0.29361E+00	0.16868E+00	0.94213E+00
0.21894E+04	0.57217E+00	0.29365E+00	0.16802E+00	0.93842E+00
0.21895E+04	0.56974E+00	0.29370E+00	0.16733E+00	0.93459E+00
0.21896E+04	0.56720E+00	0.29375E+00	0.16662E+00	0.93058E+00
0.21897E+04	0.56451E+00	0.29380E+00	0.16585E+00	0.92633E+00
0.21898E+04	0.56169E+00	0.29385E+00	0.16505E+00	0.92186E+00
0.21899E+04	0.55876E+00	0.29390E+00	0.16422E+00	0.91721E+00
0.21900E+04	0.55576E+00	0.29395E+00	0.16337E+00	0.91244E+00
0.21901E+04	0.55271E+00	0.29401E+00	0.16250E+00	0.90759E+00
0.21902E+04	0.54958E+00	0.29406E+00	0.16161E+00	0.90262E+00
0.21903E+04	0.54635E+00	0.29411E+00	0.16069E+00	0.89747E+00
0.21904E+04	0.54300E+00	0.29416E+00	0.15973E+00	0.89212E+00
0.21905E+04	0.53954E+00	0.29421E+00	0.15874E+00	0.88660E+00
0.21906E+04	0.53602E+00	0.29426E+00	0.15773E+00	0.88095E+00
0.21907E+04	0.53240E+00	0.29431E+00	0.15669E+00	0.87515E+00
0.21908E+04	0.52872E+00	0.29435E+00	0.15563E+00	0.86923E+00
0.21909E+04	0.52494E+00	0.29440E+00	0.15454E+00	0.86315E+00
0.21910E+04	0.52107E+00	0.29445E+00	0.15343E+00	0.85693E+00
0.21911E+04	0.51709E+00	0.29449E+00	0.15228E+00	0.85050E+00
0.21912E+04	0.51298E+00	0.29453E+00	0.15109E+00	0.84385E+00
0.21913E+04	0.50873E+00	0.29457E+00	0.14986E+00	0.83697E+00
0.21914E+04	0.50432E+00	0.29461E+00	0.14858E+00	0.82983E+00
0.21915E+04	0.49981E+00	0.29464E+00	0.14727E+00	0.82251E+00
0.21916E+04	0.49523E+00	0.29467E+00	0.14593E+00	0.81506E+00
0.21917E+04	0.49058E+00	0.29470E+00	0.14457E+00	0.80748E+00
0.21918E+04	0.48588E+00	0.29473E+00	0.14320E+00	0.79981E+00
0.21919E+04	0.48111E+00	0.29476E+00	0.14181E+00	0.79205E+00
0.21920E+04	0.47626E+00	0.29479E+00	0.14040E+00	0.78414E+00
0.21921E+04	0.47131E+00	0.29482E+00	0.13895E+00	0.77609E+00
0.21922E+04	0.46629E+00	0.29486E+00	0.13749E+00	0.76791E+00
0.21923E+04	0.46121E+00	0.29489E+00	0.13601E+00	0.75964E+00
0.21924E+04	0.45608E+00	0.29492E+00	0.13451E+00	0.75125E+00
0.21925E+04	0.45087E+00	0.29495E+00	0.13298E+00	0.74274E+00
0.21926E+04	0.44558E+00	0.29497E+00	0.13143E+00	0.73407E+00
0.21927E+04	0.44025E+00	0.29499E+00	0.12987E+00	0.72534E+00
0.21928E+04	0.43490E+00	0.29501E+00	0.12830E+00	0.71658E+00
0.21929E+04	0.42949E+00	0.29503E+00	0.12671E+00	0.70772E+00
0.21930E+04	0.42400E+00	0.29505E+00	0.12510E+00	0.69872E+00
0.21931E+04	0.41841E+00	0.29507E+00	0.12346E+00	0.68955E+00

0.21932E+04	0.41270E+00	0.29509E+00	0.12178E+00	0.68018E+00
0.21933E+04	0.40692E+00	0.29511E+00	0.12008E+00	0.67069E+00
0.21934E+04	0.40108E+00	0.29512E+00	0.11837E+00	0.66110E+00
0.21935E+04	0.39518E+00	0.29514E+00	0.11663E+00	0.65142E+00
0.21936E+04	0.38921E+00	0.29516E+00	0.11488E+00	0.64163E+00
0.21937E+04	0.38316E+00	0.29518E+00	0.11310E+00	0.63170E+00
0.21938E+04	0.37702E+00	0.29520E+00	0.11130E+00	0.62163E+00
0.21939E+04	0.37087E+00	0.29523E+00	0.10949E+00	0.61153E+00
0.21940E+04	0.36473E+00	0.29525E+00	0.10769E+00	0.60145E+00
0.21941E+04	0.35862E+00	0.29527E+00	0.10589E+00	0.59142E+00
0.21942E+04	0.35253E+00	0.29530E+00	0.10410E+00	0.58144E+00
0.21943E+04	0.34645E+00	0.29533E+00	0.10232E+00	0.57145E+00
0.21944E+04	0.34034E+00	0.29536E+00	0.10052E+00	0.56144E+00
0.21945E+04	0.33424E+00	0.29538E+00	0.98730E-01	0.55143E+00
0.21946E+04	0.32815E+00	0.29542E+00	0.96943E-01	0.54144E+00
0.21947E+04	0.32204E+00	0.29546E+00	0.95151E-01	0.53144E+00
0.21948E+04	0.31592E+00	0.29550E+00	0.93354E-01	0.52140E+00
0.21949E+04	0.30979E+00	0.29553E+00	0.91555E-01	0.51135E+00
0.21950E+04	0.30367E+00	0.29557E+00	0.89758E-01	0.50132E+00
0.21951E+04	0.29761E+00	0.29563E+00	0.87980E-01	0.49139E+00
0.21952E+04	0.29160E+00	0.29568E+00	0.86222E-01	0.48157E+00
0.21953E+04	0.28564E+00	0.29574E+00	0.84474E-01	0.47181E+00
0.21954E+04	0.27970E+00	0.29579E+00	0.82733E-01	0.46208E+00
0.21955E+04	0.27377E+00	0.29585E+00	0.80995E-01	0.45237E+00
0.21956E+04	0.26786E+00	0.29591E+00	0.79262E-01	0.44269E+00
0.21957E+04	0.26195E+00	0.29597E+00	0.77530E-01	0.43302E+00
0.21958E+04	0.25605E+00	0.29604E+00	0.75800E-01	0.42336E+00
0.21959E+04	0.25015E+00	0.29610E+00	0.74069E-01	0.41369E+00
0.21960E+04	0.24425E+00	0.29616E+00	0.72337E-01	0.40402E+00
0.21961E+04	0.23840E+00	0.29622E+00	0.70618E-01	0.39441E+00
0.21962E+04	0.23262E+00	0.29627E+00	0.68919E-01	0.38493E+00
0.21963E+04	0.22693E+00	0.29632E+00	0.67246E-01	0.37558E+00
0.21964E+04	0.22135E+00	0.29638E+00	0.65604E-01	0.36641E+00
0.21965E+04	0.21583E+00	0.29643E+00	0.63978E-01	0.35733E+00
0.21966E+04	0.21035E+00	0.29649E+00	0.62365E-01	0.34832E+00
0.21967E+04	0.20492E+00	0.29654E+00	0.60767E-01	0.33939E+00
0.21968E+04	0.19953E+00	0.29660E+00	0.59181E-01	0.33054E+00
0.21969E+04	0.19422E+00	0.29665E+00	0.57615E-01	0.32179E+00
0.21970E+04	0.18898E+00	0.29670E+00	0.56071E-01	0.31317E+00
0.21971E+04	0.18382E+00	0.29676E+00	0.54551E-01	0.30468E+00
0.21972E+04	0.17877E+00	0.29681E+00	0.53061E-01	0.29636E+00
0.21973E+04	0.17380E+00	0.29686E+00	0.51594E-01	0.28816E+00
0.21974E+04	0.16891E+00	0.29691E+00	0.50151E-01	0.28010E+00

0.21975E+04	0.16405E+00	0.29697E+00	0.48718E-01	0.27210E+00
0.21976E+04	0.15921E+00	0.29702E+00	0.47286E-01	0.26410E+00
0.21977E+04	0.15437E+00	0.29706E+00	0.45858E-01	0.25613E+00
0.21978E+04	0.14956E+00	0.29711E+00	0.44437E-01	0.24819E+00
0.21979E+04	0.14485E+00	0.29716E+00	0.43045E-01	0.24041E+00
0.21980E+04	0.14029E+00	0.29721E+00	0.41696E-01	0.23288E+00
0.21981E+04	0.13584E+00	0.29726E+00	0.40380E-01	0.22553E+00
0.21982E+04	0.13152E+00	0.29730E+00	0.39101E-01	0.21838E+00
0.21983E+04	0.12728E+00	0.29734E+00	0.37846E-01	0.21138E+00
0.21984E+04	0.12311E+00	0.29739E+00	0.36611E-01	0.20448E+00
0.21985E+04	0.11903E+00	0.29743E+00	0.35405E-01	0.19774E+00
0.21986E+04	0.11509E+00	0.29747E+00	0.34237E-01	0.19122E+00
0.21987E+04	0.11127E+00	0.29752E+00	0.33105E-01	0.18490E+00
0.21988E+04	0.10756E+00	0.29756E+00	0.32006E-01	0.17876E+00
0.21989E+04	0.10398E+00	0.29761E+00	0.30944E-01	0.17283E+00
0.21990E+04	0.10053E+00	0.29765E+00	0.29924E-01	0.16713E+00
0.21991E+04	0.97239E-01	0.29770E+00	0.28948E-01	0.16168E+00
0.21992E+04	0.94074E-01	0.29774E+00	0.28010E-01	0.15644E+00
0.21993E+04	0.91013E-01	0.29779E+00	0.27103E-01	0.15137E+00
0.21994E+04	0.88054E-01	0.29783E+00	0.26225E-01	0.14647E+00
0.21995E+04	0.85169E-01	0.29788E+00	0.25370E-01	0.14170E+00
0.21996E+04	0.82326E-01	0.29793E+00	0.24527E-01	0.13699E+00
0.21997E+04	0.79548E-01	0.29798E+00	0.23704E-01	0.13239E+00
0.21998E+04	0.76817E-01	0.29803E+00	0.22894E-01	0.12787E+00
0.21999E+04	0.74119E-01	0.29808E+00	0.22093E-01	0.12339E+00
0.22000E+04	0.71427E-01	0.29813E+00	0.21295E-01	0.11893E+00
0.22001E+04	0.68777E-01	0.29823E+00	0.20511E-01	0.11456E+00
0.22002E+04	0.66196E-01	0.29833E+00	0.19748E-01	0.11030E+00
0.22003E+04	0.63714E-01	0.29843E+00	0.19014E-01	0.10620E+00
0.22004E+04	0.61335E-01	0.29853E+00	0.18310E-01	0.10227E+00
0.22005E+04	0.59038E-01	0.29862E+00	0.17630E-01	0.98468E-01
0.22006E+04	0.56796E-01	0.29872E+00	0.16966E-01	0.94761E-01
0.22007E+04	0.54617E-01	0.29882E+00	0.16321E-01	0.91155E-01
0.22008E+04	0.52521E-01	0.29892E+00	0.15700E-01	0.87686E-01
0.22009E+04	0.50527E-01	0.29902E+00	0.15109E-01	0.84384E-01
0.22010E+04	0.48620E-01	0.29912E+00	0.14543E-01	0.81228E-01
0.22011E+04	0.46791E-01	0.29922E+00	0.14001E-01	0.78197E-01
0.22012E+04	0.45031E-01	0.29932E+00	0.13479E-01	0.75282E-01
0.22013E+04	0.43344E-01	0.29942E+00	0.12978E-01	0.72485E-01
0.22014E+04	0.41733E-01	0.29951E+00	0.12500E-01	0.69813E-01
0.22015E+04	0.40190E-01	0.29961E+00	0.12041E-01	0.67254E-01
0.22016E+04	0.38699E-01	0.29971E+00	0.11598E-01	0.64780E-01
0.22017E+04	0.37242E-01	0.29980E+00	0.11165E-01	0.62360E-01

0.22018E+04	0.35810E-01	0.29990E+00	0.10739E-01	0.59982E-01
0.22019E+04	0.34425E-01	0.29999E+00	0.10327E-01	0.57680E-01
0.22020E+04	0.33084E-01	0.30009E+00	0.99281E-02	0.55450E-01
0.22021E+04	0.31790E-01	0.30017E+00	0.95425E-02	0.53297E-01
0.22022E+04	0.30545E-01	0.30025E+00	0.91710E-02	0.51222E-01
0.22023E+04	0.29337E-01	0.30032E+00	0.88106E-02	0.49209E-01
0.22024E+04	0.28161E-01	0.30040E+00	0.84595E-02	0.47248E-01
0.22025E+04	0.27060E-01	0.30047E+00	0.81307E-02	0.45412E-01
0.22026E+04	0.26063E-01	0.30055E+00	0.78333E-02	0.43751E-01
0.22027E+04	0.25163E-01	0.30062E+00	0.75646E-02	0.42250E-01
0.22028E+04	0.24342E-01	0.30069E+00	0.73195E-02	0.40881E-01
0.22029E+04	0.23565E-01	0.30077E+00	0.70876E-02	0.39586E-01
0.22030E+04	0.22811E-01	0.30084E+00	0.68624E-02	0.38328E-01
0.22031E+04	0.22070E-01	0.30091E+00	0.66410E-02	0.37091E-01
0.22032E+04	0.21341E-01	0.30098E+00	0.64231E-02	0.35874E-01
0.22033E+04	0.20640E-01	0.30105E+00	0.62138E-02	0.34705E-01
0.22034E+04	0.19977E-01	0.30112E+00	0.60155E-02	0.33598E-01
0.22035E+04	0.19362E-01	0.30119E+00	0.58318E-02	0.32572E-01
0.22036E+04	0.18793E-01	0.30127E+00	0.56616E-02	0.31621E-01
0.22037E+04	0.18248E-01	0.30134E+00	0.54988E-02	0.30712E-01
0.22038E+04	0.17708E-01	0.30141E+00	0.53375E-02	0.29811E-01
0.22039E+04	0.17153E-01	0.30148E+00	0.51712E-02	0.28882E-01
0.22040E+04	0.16580E-01	0.30155E+00	0.49998E-02	0.27925E-01
0.22041E+04	0.16012E-01	0.30163E+00	0.48297E-02	0.26975E-01
0.22042E+04	0.15460E-01	0.30170E+00	0.46643E-02	0.26051E-01
0.22043E+04	0.14915E-01	0.30173E+00	0.45003E-02	0.25135E-01
0.22044E+04	0.14380E-01	0.30177E+00	0.43393E-02	0.24236E-01
0.22045E+04	0.13861E-01	0.30180E+00	0.41832E-02	0.23364E-01
0.22046E+04	0.13344E-01	0.30184E+00	0.40278E-02	0.22496E-01
0.22047E+04	0.12848E-01	0.30188E+00	0.38786E-02	0.21663E-01
0.22048E+04	0.12363E-01	0.30192E+00	0.37326E-02	0.20847E-01
0.22049E+04	0.11894E-01	0.30196E+00	0.35915E-02	0.20059E-01
0.22050E+04	0.11487E-01	0.30200E+00	0.34690E-02	0.19375E-01
0.22051E+04	0.11117E-01	0.30205E+00	0.33580E-02	0.18755E-01
0.22052E+04	0.10777E-01	0.30210E+00	0.32556E-02	0.18183E-01
0.22053E+04	0.10442E-01	0.30215E+00	0.31551E-02	0.17622E-01
0.22054E+04	0.10122E-01	0.30220E+00	0.30590E-02	0.17085E-01
0.22055E+04	0.98158E-02	0.30225E+00	0.29668E-02	0.16570E-01
0.22056E+04	0.95231E-02	0.30230E+00	0.28788E-02	0.16079E-01
0.22057E+04	0.92314E-02	0.30235E+00	0.27911E-02	0.15589E-01
0.22058E+04	0.89448E-02	0.30240E+00	0.27049E-02	0.15107E-01
0.22059E+04	0.86720E-02	0.30245E+00	0.26229E-02	0.14649E-01
0.22060E+04	0.84129E-02	0.30250E+00	0.25449E-02	0.14214E-01

0.22061E+04	0.81590E-02	0.30256E+00	0.24686E-02	0.13788E-01
0.22062E+04	0.79085E-02	0.30262E+00	0.23933E-02	0.13367E-01
0.22063E+04	0.76607E-02	0.30268E+00	0.23188E-02	0.12951E-01
0.22064E+04	0.74188E-02	0.30274E+00	0.22460E-02	0.12544E-01
0.22065E+04	0.71807E-02	0.30281E+00	0.21744E-02	0.12144E-01
0.22066E+04	0.69523E-02	0.30286E+00	0.21056E-02	0.11760E-01
0.22067E+04	0.67270E-02	0.30292E+00	0.20377E-02	0.11381E-01
0.22068E+04	0.65028E-02	0.30298E+00	0.19702E-02	0.11004E-01
0.22069E+04	0.62838E-02	0.30303E+00	0.19042E-02	0.10635E-01
0.22070E+04	0.60653E-02	0.30309E+00	0.18383E-02	0.10267E-01
0.22071E+04	0.58484E-02	0.30314E+00	0.17729E-02	0.99020E-02
0.22072E+04	0.56326E-02	0.30319E+00	0.17077E-02	0.95381E-02
0.22073E+04	0.54173E-02	0.30324E+00	0.16428E-02	0.91752E-02
0.22074E+04	0.52037E-02	0.30329E+00	0.15783E-02	0.88149E-02
0.22075E+04	0.49909E-02	0.30334E+00	0.15140E-02	0.84557E-02
0.22076E+04	0.47811E-02	0.30339E+00	0.14505E-02	0.81015E-02
0.22077E+04	0.45714E-02	0.30343E+00	0.13871E-02	0.77474E-02
0.22078E+04	0.43720E-02	0.30348E+00	0.13268E-02	0.74105E-02
0.22079E+04	0.41768E-02	0.30352E+00	0.12678E-02	0.70807E-02
0.22080E+04	0.39851E-02	0.30357E+00	0.12097E-02	0.67566E-02
0.22081E+04	0.38038E-02	0.30360E+00	0.11548E-02	0.64500E-02
0.22082E+04	0.36228E-02	0.30363E+00	0.11000E-02	0.61438E-02
0.22083E+04	0.34426E-02	0.30367E+00	0.10454E-02	0.58387E-02
0.22084E+04	0.32684E-02	0.30370E+00	0.99260E-03	0.55439E-02
0.22085E+04	0.30999E-02	0.30373E+00	0.94153E-03	0.52586E-02
0.22086E+04	0.29330E-02	0.30376E+00	0.89094E-03	0.49761E-02
0.22087E+04	0.27687E-02	0.30379E+00	0.84111E-03	0.46978E-02
0.22088E+04	0.26090E-02	0.30383E+00	0.79267E-03	0.44272E-02
0.22089E+04	0.24526E-02	0.30386E+00	0.74525E-03	0.41624E-02
0.22090E+04	0.23049E-02	0.30389E+00	0.70045E-03	0.39121E-02
0.22091E+04	0.21606E-02	0.30392E+00	0.65667E-03	0.36676E-02
0.22092E+04	0.20266E-02	0.30396E+00	0.61601E-03	0.34405E-02
0.22093E+04	0.18959E-02	0.30399E+00	0.57634E-03	0.32190E-02
0.22094E+04	0.17672E-02	0.30403E+00	0.53726E-03	0.30007E-02
0.22095E+04	0.16421E-02	0.30406E+00	0.49929E-03	0.27886E-02
0.22096E+04	0.15209E-02	0.30410E+00	0.46249E-03	0.25831E-02
0.22097E+04	0.13996E-02	0.30414E+00	0.42569E-03	0.23775E-02
0.22098E+04	0.12821E-02	0.30418E+00	0.38999E-03	0.21782E-02
0.22099E+04	0.11654E-02	0.30422E+00	0.35453E-03	0.19801E-02
0.22100E+04	0.10489E-02	0.30426E+00	0.31912E-03	0.17824E-02
0.22101E+04	0.93332E-03	0.30429E+00	0.28400E-03	0.15862E-02
0.22102E+04	0.83178E-03	0.30432E+00	0.25313E-03	0.14138E-02
0.22103E+04	0.73104E-03	0.30435E+00	0.22249E-03	0.12427E-02

0.22104E+04	0.63174E-03	0.30438E+00	0.19229E-03	0.10740E-02
0.22105E+04	0.53302E-03	0.30441E+00	0.16226E-03	0.90624E-03
0.22106E+04	0.43698E-03	0.30445E+00	0.13304E-03	0.74305E-03
0.22107E+04	0.34874E-03	0.30448E+00	0.10619E-03	0.59307E-03
0.22108E+04	0.26830E-03	0.30452E+00	0.81703E-04	0.45633E-03
0.22109E+04	0.19245E-03	0.30456E+00	0.58614E-04	0.32737E-03
0.22110E+04	0.12230E-03	0.30460E+00	0.37251E-04	0.20805E-03
0.22111E+04	0.60206E-04	0.30464E+00	0.18341E-04	0.10244E-03
0.22112E+04	0.00000E+00	0.30468E+00	0.00000E+00	0.00000E+00
Channel 14				
Wavenumber	HIRS Filter Transmittance	Optical Element Transmittance	Product of the HIRS Filter and Optical Element Transmittances	Normalized Value of Column 4
0.21875E+04	0.00000E+00	0.29282E+00	0.00000E+00	0.00000E+00
0.21876E+04	0.12397E-04	0.29286E+00	0.36308E-05	0.16645E-04
0.21877E+04	0.17412E-03	0.29291E+00	0.51002E-04	0.23381E-03
0.21878E+04	0.33692E-03	0.29295E+00	0.98701E-04	0.45248E-03
0.21879E+04	0.49972E-03	0.29300E+00	0.14642E-03	0.67123E-03
0.21880E+04	0.66298E-03	0.29304E+00	0.19428E-03	0.89065E-03
0.21881E+04	0.82946E-03	0.29308E+00	0.24310E-03	0.11145E-02
0.21882E+04	0.99652E-03	0.29312E+00	0.29210E-03	0.13391E-02
0.21883E+04	0.11659E-02	0.29316E+00	0.34181E-03	0.15670E-02
0.21884E+04	0.13356E-02	0.29320E+00	0.39160E-03	0.17952E-02
0.21885E+04	0.15057E-02	0.29324E+00	0.44154E-03	0.20242E-02
0.21886E+04	0.16759E-02	0.29329E+00	0.49152E-03	0.22533E-02
0.21887E+04	0.18472E-02	0.29333E+00	0.54184E-03	0.24840E-02
0.21888E+04	0.20189E-02	0.29337E+00	0.59230E-03	0.27153E-02
0.21889E+04	0.21941E-02	0.29342E+00	0.64379E-03	0.29514E-02
0.21890E+04	0.23705E-02	0.29346E+00	0.69566E-03	0.31892E-02
0.21891E+04	0.25477E-02	0.29351E+00	0.74778E-03	0.34281E-02
0.21892E+04	0.27252E-02	0.29356E+00	0.80000E-03	0.36675E-02
0.21893E+04	0.29031E-02	0.29361E+00	0.85236E-03	0.39075E-02
0.21894E+04	0.30810E-02	0.29365E+00	0.90476E-03	0.41477E-02
0.21895E+04	0.32613E-02	0.29370E+00	0.95785E-03	0.43912E-02
0.21896E+04	0.34430E-02	0.29375E+00	0.10114E-02	0.46366E-02
0.21897E+04	0.36252E-02	0.29380E+00	0.10651E-02	0.48828E-02
0.21898E+04	0.38087E-02	0.29385E+00	0.11192E-02	0.51308E-02
0.21899E+04	0.39988E-02	0.29390E+00	0.11753E-02	0.53878E-02
0.21900E+04	0.41906E-02	0.29395E+00	0.12318E-02	0.56472E-02
0.21901E+04	0.43830E-02	0.29401E+00	0.12886E-02	0.59075E-02
0.21902E+04	0.45756E-02	0.29406E+00	0.13455E-02	0.61682E-02
0.21903E+04	0.47686E-02	0.29411E+00	0.14025E-02	0.64296E-02

0.21904E+04	0.49621E-02	0.29416E+00	0.14597E-02	0.66916E-02
0.21905E+04	0.51556E-02	0.29421E+00	0.15168E-02	0.69538E-02
0.21906E+04	0.53494E-02	0.29426E+00	0.15741E-02	0.72163E-02
0.21907E+04	0.55431E-02	0.29431E+00	0.16314E-02	0.74789E-02
0.21908E+04	0.57380E-02	0.29435E+00	0.16890E-02	0.77430E-02
0.21909E+04	0.59346E-02	0.29440E+00	0.17471E-02	0.80096E-02
0.21910E+04	0.61322E-02	0.29445E+00	0.18056E-02	0.82777E-02
0.21911E+04	0.63301E-02	0.29449E+00	0.18642E-02	0.85460E-02
0.21912E+04	0.65285E-02	0.29453E+00	0.19228E-02	0.88150E-02
0.21913E+04	0.67270E-02	0.29457E+00	0.19815E-02	0.90841E-02
0.21914E+04	0.69257E-02	0.29461E+00	0.20404E-02	0.93537E-02
0.21915E+04	0.71298E-02	0.29464E+00	0.21007E-02	0.96306E-02
0.21916E+04	0.73341E-02	0.29467E+00	0.21612E-02	0.99076E-02
0.21917E+04	0.75386E-02	0.29470E+00	0.22216E-02	0.10185E-01
0.21918E+04	0.77455E-02	0.29473E+00	0.22828E-02	0.10465E-01
0.21919E+04	0.79538E-02	0.29476E+00	0.23444E-02	0.10748E-01
0.21920E+04	0.81625E-02	0.29479E+00	0.24062E-02	0.11031E-01
0.21921E+04	0.83719E-02	0.29482E+00	0.24682E-02	0.11315E-01
0.21922E+04	0.85814E-02	0.29486E+00	0.25303E-02	0.11600E-01
0.21923E+04	0.87911E-02	0.29489E+00	0.25924E-02	0.11885E-01
0.21924E+04	0.90025E-02	0.29492E+00	0.26550E-02	0.12172E-01
0.21925E+04	0.92177E-02	0.29495E+00	0.27188E-02	0.12464E-01
0.21926E+04	0.94341E-02	0.29497E+00	0.27828E-02	0.12757E-01
0.21927E+04	0.96535E-02	0.29499E+00	0.28477E-02	0.13055E-01
0.21928E+04	0.98779E-02	0.29501E+00	0.29141E-02	0.13359E-01
0.21929E+04	0.10104E-01	0.29503E+00	0.29809E-02	0.13666E-01
0.21930E+04	0.10334E-01	0.29505E+00	0.30489E-02	0.13977E-01
0.21931E+04	0.10563E-01	0.29507E+00	0.31169E-02	0.14289E-01
0.21932E+04	0.10802E-01	0.29509E+00	0.31874E-02	0.14612E-01
0.21933E+04	0.11041E-01	0.29511E+00	0.32581E-02	0.14936E-01
0.21934E+04	0.11296E-01	0.29512E+00	0.33338E-02	0.15284E-01
0.21935E+04	0.11557E-01	0.29514E+00	0.34110E-02	0.15637E-01
0.21936E+04	0.11819E-01	0.29516E+00	0.34886E-02	0.15993E-01
0.21937E+04	0.12090E-01	0.29518E+00	0.35689E-02	0.16361E-01
0.21938E+04	0.12368E-01	0.29520E+00	0.36511E-02	0.16738E-01
0.21939E+04	0.12665E-01	0.29523E+00	0.37391E-02	0.17141E-01
0.21940E+04	0.12999E-01	0.29525E+00	0.38380E-02	0.17595E-01
0.21941E+04	0.13367E-01	0.29527E+00	0.39469E-02	0.18094E-01
0.21942E+04	0.13769E-01	0.29530E+00	0.40660E-02	0.18640E-01
0.21943E+04	0.14202E-01	0.29533E+00	0.41943E-02	0.19228E-01
0.21944E+04	0.14636E-01	0.29536E+00	0.43228E-02	0.19817E-01
0.21945E+04	0.15080E-01	0.29538E+00	0.44545E-02	0.20421E-01
0.21946E+04	0.15535E-01	0.29542E+00	0.45895E-02	0.21040E-01

0.21947E+04	0.16006E-01	0.29546E+00	0.47292E-02	0.21680E-01
0.21948E+04	0.16513E-01	0.29550E+00	0.48795E-02	0.22370E-01
0.21949E+04	0.17065E-01	0.29553E+00	0.50433E-02	0.23120E-01
0.21950E+04	0.17671E-01	0.29557E+00	0.52232E-02	0.23945E-01
0.21951E+04	0.18321E-01	0.29563E+00	0.54161E-02	0.24829E-01
0.21952E+04	0.18982E-01	0.29568E+00	0.56125E-02	0.25730E-01
0.21953E+04	0.19658E-01	0.29574E+00	0.58136E-02	0.26652E-01
0.21954E+04	0.20361E-01	0.29579E+00	0.60226E-02	0.27610E-01
0.21955E+04	0.21099E-01	0.29585E+00	0.62420E-02	0.28616E-01
0.21956E+04	0.21901E-01	0.29591E+00	0.64807E-02	0.29710E-01
0.21957E+04	0.22791E-01	0.29597E+00	0.67455E-02	0.30924E-01
0.21958E+04	0.23740E-01	0.29604E+00	0.70279E-02	0.32219E-01
0.21959E+04	0.24739E-01	0.29610E+00	0.73252E-02	0.33581E-01
0.21960E+04	0.25774E-01	0.29616E+00	0.76334E-02	0.34994E-01
0.21961E+04	0.26860E-01	0.29622E+00	0.79563E-02	0.36475E-01
0.21962E+04	0.28009E-01	0.29627E+00	0.82982E-02	0.38042E-01
0.21963E+04	0.29227E-01	0.29632E+00	0.86608E-02	0.39704E-01
0.21964E+04	0.30515E-01	0.29638E+00	0.90441E-02	0.41462E-01
0.21965E+04	0.31880E-01	0.29643E+00	0.94502E-02	0.43323E-01
0.21966E+04	0.33279E-01	0.29649E+00	0.98667E-02	0.45233E-01
0.21967E+04	0.34720E-01	0.29654E+00	0.10296E-01	0.47201E-01
0.21968E+04	0.36207E-01	0.29660E+00	0.10739E-01	0.49230E-01
0.21969E+04	0.37735E-01	0.29665E+00	0.11194E-01	0.51318E-01
0.21970E+04	0.39314E-01	0.29670E+00	0.11665E-01	0.53475E-01
0.21971E+04	0.40965E-01	0.29676E+00	0.12157E-01	0.55731E-01
0.21972E+04	0.42695E-01	0.29681E+00	0.12672E-01	0.58095E-01
0.21973E+04	0.44512E-01	0.29686E+00	0.13214E-01	0.60577E-01
0.21974E+04	0.46375E-01	0.29691E+00	0.13769E-01	0.63124E-01
0.21975E+04	0.48280E-01	0.29697E+00	0.14337E-01	0.65728E-01
0.21976E+04	0.50203E-01	0.29702E+00	0.14911E-01	0.68358E-01
0.21977E+04	0.52171E-01	0.29706E+00	0.15498E-01	0.71049E-01
0.21978E+04	0.54192E-01	0.29711E+00	0.16101E-01	0.73814E-01
0.21979E+04	0.56271E-01	0.29716E+00	0.16722E-01	0.76658E-01
0.21980E+04	0.58418E-01	0.29721E+00	0.17362E-01	0.79596E-01
0.21981E+04	0.60647E-01	0.29726E+00	0.18028E-01	0.82645E-01
0.21982E+04	0.62977E-01	0.29730E+00	0.18723E-01	0.85833E-01
0.21983E+04	0.65447E-01	0.29734E+00	0.19460E-01	0.89213E-01
0.21984E+04	0.68068E-01	0.29739E+00	0.20243E-01	0.92800E-01
0.21985E+04	0.70887E-01	0.29743E+00	0.21084E-01	0.96657E-01
0.21986E+04	0.73859E-01	0.29747E+00	0.21971E-01	0.10072E+00
0.21987E+04	0.76985E-01	0.29752E+00	0.22904E-01	0.10500E+00
0.21988E+04	0.80296E-01	0.29756E+00	0.23893E-01	0.10954E+00
0.21989E+04	0.83803E-01	0.29761E+00	0.24940E-01	0.11434E+00

0.21990E+04	0.87481E-01	0.29765E+00	0.26039E-01	0.11937E+00
0.21991E+04	0.91349E-01	0.29770E+00	0.27194E-01	0.12467E+00
0.21992E+04	0.95408E-01	0.29774E+00	0.28407E-01	0.13023E+00
0.21993E+04	0.99676E-01	0.29779E+00	0.29682E-01	0.13608E+00
0.21994E+04	0.10413E+00	0.29783E+00	0.31012E-01	0.14217E+00
0.21995E+04	0.10878E+00	0.29788E+00	0.32403E-01	0.14855E+00
0.21996E+04	0.11367E+00	0.29793E+00	0.33866E-01	0.15525E+00
0.21997E+04	0.11881E+00	0.29798E+00	0.35402E-01	0.16230E+00
0.21998E+04	0.12414E+00	0.29803E+00	0.36998E-01	0.16961E+00
0.21999E+04	0.12966E+00	0.29808E+00	0.38649E-01	0.17718E+00
0.22000E+04	0.13537E+00	0.29813E+00	0.40358E-01	0.18502E+00
0.22001E+04	0.14131E+00	0.29823E+00	0.42142E-01	0.19320E+00
0.22002E+04	0.14747E+00	0.29833E+00	0.43995E-01	0.20169E+00
0.22003E+04	0.15385E+00	0.29843E+00	0.45914E-01	0.21049E+00
0.22004E+04	0.16041E+00	0.29853E+00	0.47888E-01	0.21954E+00
0.22005E+04	0.16713E+00	0.29862E+00	0.49908E-01	0.22880E+00
0.22006E+04	0.17400E+00	0.29872E+00	0.51978E-01	0.23829E+00
0.22007E+04	0.18104E+00	0.29882E+00	0.54100E-01	0.24802E+00
0.22008E+04	0.18824E+00	0.29892E+00	0.56269E-01	0.25796E+00
0.22009E+04	0.19558E+00	0.29902E+00	0.58484E-01	0.26811E+00
0.22010E+04	0.20309E+00	0.29912E+00	0.60750E-01	0.27850E+00
0.22011E+04	0.21078E+00	0.29922E+00	0.63069E-01	0.28913E+00
0.22012E+04	0.21861E+00	0.29932E+00	0.65435E-01	0.29998E+00
0.22013E+04	0.22661E+00	0.29942E+00	0.67852E-01	0.31106E+00
0.22014E+04	0.23476E+00	0.29951E+00	0.70315E-01	0.32235E+00
0.22015E+04	0.24305E+00	0.29961E+00	0.72822E-01	0.33384E+00
0.22016E+04	0.25146E+00	0.29971E+00	0.75364E-01	0.34550E+00
0.22017E+04	0.25994E+00	0.29980E+00	0.77931E-01	0.35726E+00
0.22018E+04	0.26850E+00	0.29990E+00	0.80522E-01	0.36915E+00
0.22019E+04	0.27717E+00	0.29999E+00	0.83149E-01	0.38118E+00
0.22020E+04	0.28591E+00	0.30009E+00	0.85800E-01	0.39334E+00
0.22021E+04	0.29471E+00	0.30017E+00	0.88464E-01	0.40555E+00
0.22022E+04	0.30354E+00	0.30025E+00	0.91135E-01	0.41780E+00
0.22023E+04	0.31238E+00	0.30032E+00	0.93814E-01	0.43008E+00
0.22024E+04	0.32123E+00	0.30040E+00	0.96495E-01	0.44237E+00
0.22025E+04	0.33008E+00	0.30047E+00	0.99181E-01	0.45468E+00
0.22026E+04	0.33895E+00	0.30055E+00	0.10187E+00	0.46701E+00
0.22027E+04	0.34782E+00	0.30062E+00	0.10456E+00	0.47935E+00
0.22028E+04	0.35664E+00	0.30069E+00	0.10724E+00	0.49163E+00
0.22029E+04	0.36539E+00	0.30077E+00	0.10990E+00	0.50381E+00
0.22030E+04	0.37407E+00	0.30084E+00	0.11254E+00	0.51591E+00
0.22031E+04	0.38269E+00	0.30091E+00	0.11515E+00	0.52791E+00
0.22032E+04	0.39123E+00	0.30098E+00	0.11775E+00	0.53983E+00

0.22033E+04	0.39972E+00	0.30105E+00	0.12034E+00	0.55166E+00
0.22034E+04	0.40812E+00	0.30112E+00	0.12290E+00	0.56340E+00
0.22035E+04	0.41644E+00	0.30119E+00	0.12543E+00	0.57502E+00
0.22036E+04	0.42463E+00	0.30127E+00	0.12793E+00	0.58647E+00
0.22037E+04	0.43270E+00	0.30134E+00	0.13039E+00	0.59775E+00
0.22038E+04	0.44065E+00	0.30141E+00	0.13282E+00	0.60888E+00
0.22039E+04	0.44846E+00	0.30148E+00	0.13520E+00	0.61982E+00
0.22040E+04	0.45614E+00	0.30155E+00	0.13755E+00	0.63059E+00
0.22041E+04	0.46371E+00	0.30163E+00	0.13987E+00	0.64121E+00
0.22042E+04	0.47116E+00	0.30170E+00	0.14215E+00	0.65166E+00
0.22043E+04	0.47848E+00	0.30173E+00	0.14438E+00	0.66187E+00
0.22044E+04	0.48567E+00	0.30177E+00	0.14656E+00	0.67188E+00
0.22045E+04	0.49270E+00	0.30180E+00	0.14870E+00	0.68169E+00
0.22046E+04	0.49958E+00	0.30184E+00	0.15080E+00	0.69130E+00
0.22047E+04	0.50630E+00	0.30188E+00	0.15284E+00	0.70070E+00
0.22048E+04	0.51287E+00	0.30192E+00	0.15485E+00	0.70988E+00
0.22049E+04	0.51931E+00	0.30196E+00	0.15681E+00	0.71888E+00
0.22050E+04	0.52562E+00	0.30200E+00	0.15874E+00	0.72772E+00
0.22051E+04	0.53179E+00	0.30205E+00	0.16063E+00	0.73637E+00
0.22052E+04	0.53777E+00	0.30210E+00	0.16246E+00	0.74477E+00
0.22053E+04	0.54356E+00	0.30215E+00	0.16424E+00	0.75292E+00
0.22054E+04	0.54914E+00	0.30220E+00	0.16595E+00	0.76077E+00
0.22055E+04	0.55450E+00	0.30225E+00	0.16760E+00	0.76833E+00
0.22056E+04	0.55967E+00	0.30230E+00	0.16919E+00	0.77562E+00
0.22057E+04	0.56462E+00	0.30235E+00	0.17071E+00	0.78261E+00
0.22058E+04	0.56937E+00	0.30240E+00	0.17218E+00	0.78932E+00
0.22059E+04	0.57392E+00	0.30245E+00	0.17358E+00	0.79577E+00
0.22060E+04	0.57830E+00	0.30250E+00	0.17494E+00	0.80198E+00
0.22061E+04	0.58251E+00	0.30256E+00	0.17625E+00	0.80798E+00
0.22062E+04	0.58654E+00	0.30262E+00	0.17750E+00	0.81373E+00
0.22063E+04	0.59035E+00	0.30268E+00	0.17869E+00	0.81918E+00
0.22064E+04	0.59392E+00	0.30274E+00	0.17981E+00	0.82430E+00
0.22065E+04	0.59725E+00	0.30281E+00	0.18085E+00	0.82910E+00
0.22066E+04	0.60035E+00	0.30286E+00	0.18182E+00	0.83355E+00
0.22067E+04	0.60322E+00	0.30292E+00	0.18273E+00	0.83769E+00
0.22068E+04	0.60594E+00	0.30298E+00	0.18358E+00	0.84162E+00
0.22069E+04	0.60851E+00	0.30303E+00	0.18440E+00	0.84535E+00
0.22070E+04	0.61089E+00	0.30309E+00	0.18515E+00	0.84881E+00
0.22071E+04	0.61306E+00	0.30314E+00	0.18584E+00	0.85198E+00
0.22072E+04	0.61505E+00	0.30319E+00	0.18648E+00	0.85488E+00
0.22073E+04	0.61684E+00	0.30324E+00	0.18705E+00	0.85751E+00
0.22074E+04	0.61844E+00	0.30329E+00	0.18757E+00	0.85989E+00
0.22075E+04	0.61985E+00	0.30334E+00	0.18803E+00	0.86200E+00

0.22076E+04	0.62113E+00	0.30339E+00	0.18844E+00	0.86389E+00
0.22077E+04	0.62231E+00	0.30343E+00	0.18883E+00	0.86567E+00
0.22078E+04	0.62340E+00	0.30348E+00	0.18919E+00	0.86731E+00
0.22079E+04	0.62439E+00	0.30352E+00	0.18952E+00	0.86881E+00
0.22080E+04	0.62527E+00	0.30357E+00	0.18981E+00	0.87017E+00
0.22081E+04	0.62603E+00	0.30360E+00	0.19006E+00	0.87132E+00
0.22082E+04	0.62667E+00	0.30363E+00	0.19028E+00	0.87231E+00
0.22083E+04	0.62723E+00	0.30367E+00	0.19047E+00	0.87317E+00
0.22084E+04	0.62770E+00	0.30370E+00	0.19063E+00	0.87393E+00
0.22085E+04	0.62811E+00	0.30373E+00	0.19078E+00	0.87460E+00
0.22086E+04	0.62847E+00	0.30376E+00	0.19091E+00	0.87519E+00
0.22087E+04	0.62876E+00	0.30379E+00	0.19101E+00	0.87568E+00
0.22088E+04	0.62899E+00	0.30383E+00	0.19110E+00	0.87609E+00
0.22089E+04	0.62916E+00	0.30386E+00	0.19118E+00	0.87642E+00
0.22090E+04	0.62932E+00	0.30389E+00	0.19124E+00	0.87673E+00
0.22091E+04	0.62945E+00	0.30392E+00	0.19131E+00	0.87702E+00
0.22092E+04	0.62956E+00	0.30396E+00	0.19136E+00	0.87727E+00
0.22093E+04	0.62964E+00	0.30399E+00	0.19141E+00	0.87747E+00
0.22094E+04	0.62971E+00	0.30403E+00	0.19145E+00	0.87768E+00
0.22095E+04	0.62980E+00	0.30406E+00	0.19150E+00	0.87790E+00
0.22096E+04	0.62995E+00	0.30410E+00	0.19157E+00	0.87821E+00
0.22097E+04	0.63016E+00	0.30414E+00	0.19165E+00	0.87862E+00
0.22098E+04	0.63044E+00	0.30418E+00	0.19177E+00	0.87914E+00
0.22099E+04	0.63081E+00	0.30422E+00	0.19190E+00	0.87976E+00
0.22100E+04	0.63122E+00	0.30426E+00	0.19205E+00	0.88045E+00
0.22101E+04	0.63168E+00	0.30429E+00	0.19221E+00	0.88117E+00
0.22102E+04	0.63220E+00	0.30432E+00	0.19239E+00	0.88198E+00
0.22103E+04	0.63277E+00	0.30435E+00	0.19258E+00	0.88288E+00
0.22104E+04	0.63340E+00	0.30438E+00	0.19279E+00	0.88384E+00
0.22105E+04	0.63406E+00	0.30441E+00	0.19302E+00	0.88486E+00
0.22106E+04	0.63479E+00	0.30445E+00	0.19326E+00	0.88598E+00
0.22107E+04	0.63562E+00	0.30448E+00	0.19354E+00	0.88724E+00
0.22108E+04	0.63657E+00	0.30452E+00	0.19385E+00	0.88868E+00
0.22109E+04	0.63763E+00	0.30456E+00	0.19420E+00	0.89027E+00
0.22110E+04	0.63882E+00	0.30460E+00	0.19458E+00	0.89204E+00
0.22111E+04	0.64013E+00	0.30464E+00	0.19501E+00	0.89400E+00
0.22112E+04	0.64151E+00	0.30468E+00	0.19545E+00	0.89604E+00
0.22113E+04	0.64288E+00	0.30472E+00	0.19590E+00	0.89808E+00
0.22114E+04	0.64426E+00	0.30477E+00	0.19635E+00	0.90013E+00
0.22115E+04	0.64560E+00	0.30481E+00	0.19678E+00	0.90213E+00
0.22116E+04	0.64697E+00	0.30485E+00	0.19723E+00	0.90417E+00
0.22117E+04	0.64838E+00	0.30490E+00	0.19769E+00	0.90627E+00
0.22118E+04	0.64986E+00	0.30494E+00	0.19817E+00	0.90848E+00

0.22119E+04	0.65145E+00	0.30498E+00	0.19868E+00	0.91083E+00
0.22120E+04	0.65310E+00	0.30503E+00	0.19922E+00	0.91328E+00
0.22121E+04	0.65482E+00	0.30508E+00	0.19977E+00	0.91584E+00
0.22122E+04	0.65657E+00	0.30513E+00	0.20034E+00	0.91842E+00
0.22123E+04	0.65829E+00	0.30518E+00	0.20090E+00	0.92099E+00
0.22124E+04	0.66000E+00	0.30523E+00	0.20145E+00	0.92354E+00
0.22125E+04	0.66173E+00	0.30528E+00	0.20202E+00	0.92612E+00
0.22126E+04	0.66350E+00	0.30533E+00	0.20259E+00	0.92874E+00
0.22127E+04	0.66529E+00	0.30538E+00	0.20317E+00	0.93139E+00
0.22128E+04	0.66710E+00	0.30543E+00	0.20375E+00	0.93406E+00
0.22129E+04	0.66895E+00	0.30548E+00	0.20435E+00	0.93681E+00
0.22130E+04	0.67081E+00	0.30552E+00	0.20495E+00	0.93955E+00
0.22131E+04	0.67264E+00	0.30557E+00	0.20554E+00	0.94225E+00
0.22132E+04	0.67449E+00	0.30561E+00	0.20613E+00	0.94498E+00
0.22133E+04	0.67636E+00	0.30566E+00	0.20674E+00	0.94777E+00
0.22134E+04	0.67825E+00	0.30572E+00	0.20735E+00	0.95059E+00
0.22135E+04	0.68015E+00	0.30577E+00	0.20797E+00	0.95342E+00
0.22136E+04	0.68203E+00	0.30582E+00	0.20858E+00	0.95620E+00
0.22137E+04	0.68385E+00	0.30587E+00	0.20917E+00	0.95893E+00
0.22138E+04	0.68566E+00	0.30592E+00	0.20976E+00	0.96162E+00
0.22139E+04	0.68744E+00	0.30597E+00	0.21034E+00	0.96428E+00
0.22140E+04	0.68919E+00	0.30603E+00	0.21091E+00	0.96689E+00
0.22141E+04	0.69088E+00	0.30608E+00	0.21146E+00	0.96943E+00
0.22142E+04	0.69249E+00	0.30613E+00	0.21200E+00	0.97187E+00
0.22143E+04	0.69402E+00	0.30619E+00	0.21250E+00	0.97418E+00
0.22144E+04	0.69547E+00	0.30625E+00	0.21298E+00	0.97640E+00
0.22145E+04	0.69685E+00	0.30630E+00	0.21344E+00	0.97851E+00
0.22146E+04	0.69816E+00	0.30635E+00	0.21388E+00	0.98052E+00
0.22147E+04	0.69939E+00	0.30641E+00	0.21430E+00	0.98243E+00
0.22148E+04	0.70056E+00	0.30646E+00	0.21469E+00	0.98424E+00
0.22149E+04	0.70165E+00	0.30651E+00	0.21507E+00	0.98594E+00
0.22150E+04	0.70268E+00	0.30657E+00	0.21542E+00	0.98756E+00
0.22151E+04	0.70365E+00	0.30662E+00	0.21576E+00	0.98911E+00
0.22152E+04	0.70455E+00	0.30668E+00	0.21607E+00	0.99055E+00
0.22153E+04	0.70535E+00	0.30674E+00	0.21636E+00	0.99186E+00
0.22154E+04	0.70605E+00	0.30679E+00	0.21661E+00	0.99302E+00
0.22155E+04	0.70663E+00	0.30685E+00	0.21683E+00	0.99403E+00
0.22156E+04	0.70717E+00	0.30690E+00	0.21703E+00	0.99497E+00
0.22157E+04	0.70767E+00	0.30696E+00	0.21723E+00	0.99585E+00
0.22158E+04	0.70815E+00	0.30702E+00	0.21741E+00	0.99670E+00
0.22159E+04	0.70862E+00	0.30707E+00	0.21760E+00	0.99754E+00
0.22160E+04	0.70906E+00	0.30713E+00	0.21777E+00	0.99835E+00
0.22161E+04	0.70942E+00	0.30719E+00	0.21793E+00	0.99907E+00

0.22162E+04	0.70965E+00	0.30725E+00	0.21804E+00	0.99960E+00
0.22163E+04	0.70973E+00	0.30732E+00	0.21811E+00	0.99991E+00
0.22164E+04	0.70964E+00	0.30738E+00	0.21813E+00	0.10000E+01
0.22165E+04	0.70938E+00	0.30745E+00	0.21810E+00	0.99984E+00
0.22166E+04	0.70900E+00	0.30751E+00	0.21803E+00	0.99952E+00
0.22167E+04	0.70851E+00	0.30758E+00	0.21792E+00	0.99904E+00
0.22168E+04	0.70795E+00	0.30764E+00	0.21779E+00	0.99845E+00
0.22169E+04	0.70733E+00	0.30770E+00	0.21765E+00	0.99778E+00
0.22170E+04	0.70662E+00	0.30777E+00	0.21747E+00	0.99699E+00
0.22171E+04	0.70581E+00	0.30783E+00	0.21727E+00	0.99604E+00
0.22172E+04	0.70485E+00	0.30789E+00	0.21702E+00	0.99489E+00
0.22173E+04	0.70375E+00	0.30796E+00	0.21672E+00	0.99354E+00
0.22174E+04	0.70252E+00	0.30802E+00	0.21639E+00	0.99201E+00
0.22175E+04	0.70112E+00	0.30808E+00	0.21600E+00	0.99024E+00
0.22176E+04	0.69954E+00	0.30814E+00	0.21556E+00	0.98820E+00
0.22177E+04	0.69781E+00	0.30820E+00	0.21507E+00	0.98595E+00
0.22178E+04	0.69596E+00	0.30827E+00	0.21454E+00	0.98354E+00
0.22179E+04	0.69399E+00	0.30833E+00	0.21398E+00	0.98094E+00
0.22180E+04	0.69184E+00	0.30839E+00	0.21336E+00	0.97810E+00
0.22181E+04	0.68953E+00	0.30844E+00	0.21268E+00	0.97502E+00
0.22182E+04	0.68708E+00	0.30850E+00	0.21197E+00	0.97174E+00
0.22183E+04	0.68449E+00	0.30856E+00	0.21121E+00	0.96825E+00
0.22184E+04	0.68181E+00	0.30862E+00	0.21042E+00	0.96463E+00
0.22185E+04	0.67905E+00	0.30867E+00	0.20960E+00	0.96090E+00
0.22186E+04	0.67619E+00	0.30873E+00	0.20876E+00	0.95704E+00
0.22187E+04	0.67325E+00	0.30879E+00	0.20789E+00	0.95304E+00
0.22188E+04	0.67020E+00	0.30884E+00	0.20699E+00	0.94890E+00
0.22189E+04	0.66701E+00	0.30890E+00	0.20604E+00	0.94456E+00
0.22190E+04	0.66367E+00	0.30896E+00	0.20505E+00	0.94000E+00
0.22191E+04	0.66016E+00	0.30901E+00	0.20400E+00	0.93521E+00
0.22192E+04	0.65649E+00	0.30907E+00	0.20290E+00	0.93018E+00
0.22193E+04	0.65266E+00	0.30913E+00	0.20175E+00	0.92492E+00
0.22194E+04	0.64867E+00	0.30918E+00	0.20056E+00	0.91943E+00
0.22195E+04	0.64451E+00	0.30924E+00	0.19931E+00	0.91370E+00
0.22196E+04	0.64020E+00	0.30930E+00	0.19801E+00	0.90777E+00
0.22197E+04	0.63575E+00	0.30936E+00	0.19668E+00	0.90164E+00
0.22198E+04	0.63119E+00	0.30942E+00	0.19530E+00	0.89534E+00
0.22199E+04	0.62652E+00	0.30948E+00	0.19389E+00	0.88888E+00
0.22200E+04	0.62177E+00	0.30954E+00	0.19246E+00	0.88231E+00
0.22201E+04	0.61694E+00	0.30959E+00	0.19100E+00	0.87563E+00
0.22202E+04	0.61202E+00	0.30965E+00	0.18951E+00	0.86880E+00
0.22203E+04	0.60700E+00	0.30971E+00	0.18799E+00	0.86184E+00
0.22204E+04	0.60186E+00	0.30976E+00	0.18643E+00	0.85468E+00

0.22205E+04	0.59656E+00	0.30982E+00	0.18483E+00	0.84731E+00
0.22206E+04	0.59114E+00	0.30988E+00	0.18318E+00	0.83978E+00
0.22207E+04	0.58562E+00	0.30994E+00	0.18151E+00	0.83210E+00
0.22208E+04	0.58003E+00	0.31000E+00	0.17981E+00	0.82432E+00
0.22209E+04	0.57438E+00	0.31006E+00	0.17809E+00	0.81644E+00
0.22210E+04	0.56862E+00	0.31012E+00	0.17634E+00	0.80841E+00
0.22211E+04	0.56278E+00	0.31018E+00	0.17456E+00	0.80027E+00
0.22212E+04	0.55689E+00	0.31025E+00	0.17277E+00	0.79205E+00
0.22213E+04	0.55093E+00	0.31031E+00	0.17096E+00	0.78374E+00
0.22214E+04	0.54490E+00	0.31037E+00	0.16912E+00	0.77532E+00
0.22215E+04	0.53880E+00	0.31044E+00	0.16726E+00	0.76679E+00
0.22216E+04	0.53261E+00	0.31050E+00	0.16538E+00	0.75815E+00
0.22217E+04	0.52633E+00	0.31057E+00	0.16346E+00	0.74937E+00
0.22218E+04	0.51999E+00	0.31064E+00	0.16153E+00	0.74051E+00
0.22219E+04	0.51363E+00	0.31070E+00	0.15958E+00	0.73160E+00
0.22220E+04	0.50721E+00	0.31077E+00	0.15763E+00	0.72261E+00
0.22221E+04	0.50075E+00	0.31084E+00	0.15565E+00	0.71358E+00
0.22222E+04	0.49425E+00	0.31091E+00	0.15367E+00	0.70448E+00
0.22223E+04	0.48770E+00	0.31099E+00	0.15167E+00	0.69530E+00
0.22224E+04	0.48107E+00	0.31106E+00	0.14964E+00	0.68602E+00
0.22225E+04	0.47437E+00	0.31113E+00	0.14759E+00	0.67661E+00
0.22226E+04	0.46763E+00	0.31120E+00	0.14553E+00	0.66715E+00
0.22227E+04	0.46085E+00	0.31128E+00	0.14345E+00	0.65764E+00
0.22228E+04	0.45401E+00	0.31135E+00	0.14136E+00	0.64804E+00
0.22229E+04	0.44711E+00	0.31143E+00	0.13924E+00	0.63834E+00
0.22230E+04	0.44017E+00	0.31150E+00	0.13711E+00	0.62858E+00
0.22231E+04	0.43319E+00	0.31158E+00	0.13497E+00	0.61877E+00
0.22232E+04	0.42620E+00	0.31165E+00	0.13283E+00	0.60893E+00
0.22233E+04	0.41920E+00	0.31173E+00	0.13068E+00	0.59908E+00
0.22234E+04	0.41226E+00	0.31181E+00	0.12854E+00	0.58930E+00
0.22235E+04	0.40537E+00	0.31188E+00	0.12643E+00	0.57959E+00
0.22236E+04	0.39851E+00	0.31196E+00	0.12432E+00	0.56992E+00
0.22237E+04	0.39165E+00	0.31203E+00	0.12221E+00	0.56025E+00
0.22238E+04	0.38477E+00	0.31211E+00	0.12009E+00	0.55053E+00
0.22239E+04	0.37786E+00	0.31218E+00	0.11796E+00	0.54078E+00
0.22240E+04	0.37094E+00	0.31226E+00	0.11583E+00	0.53100E+00
0.22241E+04	0.36400E+00	0.31234E+00	0.11369E+00	0.52120E+00
0.22242E+04	0.35704E+00	0.31243E+00	0.11155E+00	0.51138E+00
0.22243E+04	0.35007E+00	0.31251E+00	0.10940E+00	0.50154E+00
0.22244E+04	0.34308E+00	0.31260E+00	0.10725E+00	0.49166E+00
0.22245E+04	0.33609E+00	0.31268E+00	0.10509E+00	0.48176E+00
0.22246E+04	0.32913E+00	0.31276E+00	0.10294E+00	0.47191E+00
0.22247E+04	0.32224E+00	0.31284E+00	0.10081E+00	0.46214E+00

0.22248E+04	0.31542E+00	0.31292E+00	0.98700E-01	0.45248E+00
0.22249E+04	0.30868E+00	0.31300E+00	0.96617E-01	0.44293E+00
0.22250E+04	0.30202E+00	0.31308E+00	0.94556E-01	0.43348E+00
0.22251E+04	0.29543E+00	0.31315E+00	0.92512E-01	0.42411E+00
0.22252E+04	0.28890E+00	0.31322E+00	0.90488E-01	0.41483E+00
0.22253E+04	0.28242E+00	0.31329E+00	0.88478E-01	0.40561E+00
0.22254E+04	0.27596E+00	0.31336E+00	0.86474E-01	0.39643E+00
0.22255E+04	0.26955E+00	0.31343E+00	0.84483E-01	0.38730E+00
0.22256E+04	0.26321E+00	0.31349E+00	0.82514E-01	0.37828E+00
0.22257E+04	0.25699E+00	0.31355E+00	0.80578E-01	0.36940E+00
0.22258E+04	0.25085E+00	0.31361E+00	0.78671E-01	0.36066E+00
0.22259E+04	0.24480E+00	0.31368E+00	0.76788E-01	0.35203E+00
0.22260E+04	0.23882E+00	0.31374E+00	0.74929E-01	0.34350E+00
0.22261E+04	0.23292E+00	0.31380E+00	0.73092E-01	0.33508E+00
0.22262E+04	0.22711E+00	0.31386E+00	0.71282E-01	0.32678E+00
0.22263E+04	0.22140E+00	0.31392E+00	0.69504E-01	0.31863E+00
0.22264E+04	0.21579E+00	0.31399E+00	0.67754E-01	0.31061E+00
0.22265E+04	0.21024E+00	0.31405E+00	0.66027E-01	0.30269E+00
0.22266E+04	0.20473E+00	0.31410E+00	0.64306E-01	0.29480E+00
0.22267E+04	0.19923E+00	0.31416E+00	0.62590E-01	0.28694E+00
0.22268E+04	0.19379E+00	0.31422E+00	0.60893E-01	0.27916E+00
0.22269E+04	0.18844E+00	0.31427E+00	0.59222E-01	0.27150E+00
0.22270E+04	0.18316E+00	0.31433E+00	0.57574E-01	0.26394E+00
0.22271E+04	0.17796E+00	0.31438E+00	0.55948E-01	0.25649E+00
0.22272E+04	0.17282E+00	0.31444E+00	0.54342E-01	0.24913E+00
0.22273E+04	0.16775E+00	0.31448E+00	0.52755E-01	0.24185E+00
0.22274E+04	0.16275E+00	0.31452E+00	0.51189E-01	0.23467E+00
0.22275E+04	0.15782E+00	0.31456E+00	0.49646E-01	0.22760E+00
0.22276E+04	0.15299E+00	0.31461E+00	0.48132E-01	0.22066E+00
0.22277E+04	0.14827E+00	0.31465E+00	0.46651E-01	0.21387E+00
0.22278E+04	0.14361E+00	0.31469E+00	0.45193E-01	0.20718E+00
0.22279E+04	0.13905E+00	0.31473E+00	0.43762E-01	0.20062E+00
0.22280E+04	0.13460E+00	0.31478E+00	0.42370E-01	0.19424E+00
0.22281E+04	0.13031E+00	0.31482E+00	0.41026E-01	0.18808E+00
0.22282E+04	0.12615E+00	0.31487E+00	0.39720E-01	0.18209E+00
0.22283E+04	0.12211E+00	0.31492E+00	0.38454E-01	0.17629E+00
0.22284E+04	0.11817E+00	0.31497E+00	0.37221E-01	0.17063E+00
0.22285E+04	0.11433E+00	0.31502E+00	0.36017E-01	0.16511E+00
0.22286E+04	0.11055E+00	0.31508E+00	0.34833E-01	0.15969E+00
0.22287E+04	0.10683E+00	0.31513E+00	0.33667E-01	0.15434E+00
0.22288E+04	0.10321E+00	0.31519E+00	0.32529E-01	0.14913E+00
0.22289E+04	0.99687E-01	0.31525E+00	0.31426E-01	0.14407E+00
0.22290E+04	0.96286E-01	0.31530E+00	0.30359E-01	0.13918E+00

0.22291E+04	0.93016E-01	0.31536E+00	0.29334E-01	0.13448E+00
0.22292E+04	0.89840E-01	0.31543E+00	0.28338E-01	0.12991E+00
0.22293E+04	0.86740E-01	0.31549E+00	0.27366E-01	0.12545E+00
0.22294E+04	0.83722E-01	0.31555E+00	0.26418E-01	0.12111E+00
0.22295E+04	0.80807E-01	0.31561E+00	0.25504E-01	0.11692E+00
0.22296E+04	0.78036E-01	0.31568E+00	0.24634E-01	0.11293E+00
0.22297E+04	0.75430E-01	0.31575E+00	0.23817E-01	0.10919E+00
0.22298E+04	0.72961E-01	0.31581E+00	0.23042E-01	0.10563E+00
0.22299E+04	0.70614E-01	0.31588E+00	0.22306E-01	0.10226E+00
0.22300E+04	0.68343E-01	0.31595E+00	0.21593E-01	0.98989E-01
0.22301E+04	0.66132E-01	0.31599E+00	0.20897E-01	0.95800E-01
0.22302E+04	0.63980E-01	0.31603E+00	0.20220E-01	0.92696E-01
0.22303E+04	0.61900E-01	0.31608E+00	0.19565E-01	0.89695E-01
0.22304E+04	0.59897E-01	0.31612E+00	0.18935E-01	0.86804E-01
0.22305E+04	0.57975E-01	0.31617E+00	0.18330E-01	0.84031E-01
0.22306E+04	0.56118E-01	0.31621E+00	0.17745E-01	0.81350E-01
0.22307E+04	0.54306E-01	0.31625E+00	0.17174E-01	0.78734E-01
0.22308E+04	0.52538E-01	0.31630E+00	0.16617E-01	0.76181E-01
0.22309E+04	0.50853E-01	0.31634E+00	0.16087E-01	0.73748E-01
0.22310E+04	0.49261E-01	0.31638E+00	0.15585E-01	0.71448E-01
0.22311E+04	0.47779E-01	0.31642E+00	0.15118E-01	0.69308E-01
0.22312E+04	0.46402E-01	0.31646E+00	0.14684E-01	0.67319E-01
0.22313E+04	0.45107E-01	0.31650E+00	0.14276E-01	0.65447E-01
0.22314E+04	0.43843E-01	0.31653E+00	0.13878E-01	0.63621E-01
0.22315E+04	0.42584E-01	0.31657E+00	0.13481E-01	0.61802E-01
0.22316E+04	0.41300E-01	0.31661E+00	0.13076E-01	0.59945E-01
0.22317E+04	0.39998E-01	0.31664E+00	0.12665E-01	0.58061E-01
0.22318E+04	0.38731E-01	0.31668E+00	0.12265E-01	0.56228E-01
0.22319E+04	0.37519E-01	0.31671E+00	0.11883E-01	0.54474E-01
0.22320E+04	0.36345E-01	0.31674E+00	0.11512E-01	0.52775E-01
0.22321E+04	0.35207E-01	0.31676E+00	0.11152E-01	0.51125E-01
0.22322E+04	0.34072E-01	0.31677E+00	0.10793E-01	0.49479E-01
0.22323E+04	0.32941E-01	0.31679E+00	0.10435E-01	0.47839E-01
0.22324E+04	0.31812E-01	0.31680E+00	0.10078E-01	0.46201E-01
0.22325E+04	0.30682E-01	0.31682E+00	0.97207E-02	0.44563E-01
0.22326E+04	0.29593E-01	0.31683E+00	0.93760E-02	0.42983E-01
0.22327E+04	0.28566E-01	0.31684E+00	0.90509E-02	0.41493E-01
0.22328E+04	0.27553E-01	0.31686E+00	0.87304E-02	0.40023E-01
0.22329E+04	0.26549E-01	0.31687E+00	0.84125E-02	0.38566E-01
0.22330E+04	0.25586E-01	0.31688E+00	0.81077E-02	0.37169E-01
0.22331E+04	0.24671E-01	0.31690E+00	0.78183E-02	0.35842E-01
0.22332E+04	0.23790E-01	0.31691E+00	0.75392E-02	0.34563E-01
0.22333E+04	0.22941E-01	0.31692E+00	0.72706E-02	0.33331E-01

0.22334E+04	0.22139E-01	0.31694E+00	0.70168E-02	0.32168E-01
0.22335E+04	0.21370E-01	0.31695E+00	0.67733E-02	0.31052E-01
0.22336E+04	0.20624E-01	0.31697E+00	0.65372E-02	0.29969E-01
0.22337E+04	0.19880E-01	0.31698E+00	0.63016E-02	0.28889E-01
0.22338E+04	0.19141E-01	0.31700E+00	0.60677E-02	0.27817E-01
0.22339E+04	0.18460E-01	0.31702E+00	0.58520E-02	0.26828E-01
0.22340E+04	0.17847E-01	0.31704E+00	0.56582E-02	0.25939E-01
0.22341E+04	0.17298E-01	0.31709E+00	0.54850E-02	0.25145E-01
0.22342E+04	0.16780E-01	0.31714E+00	0.53217E-02	0.24397E-01
0.22343E+04	0.16273E-01	0.31719E+00	0.51618E-02	0.23663E-01
0.22344E+04	0.15785E-01	0.31724E+00	0.50078E-02	0.22957E-01
0.22345E+04	0.15307E-01	0.31730E+00	0.48568E-02	0.22265E-01
0.22346E+04	0.14830E-01	0.31735E+00	0.47063E-02	0.21575E-01
0.22347E+04	0.14370E-01	0.31740E+00	0.45611E-02	0.20910E-01
0.22348E+04	0.13923E-01	0.31746E+00	0.44198E-02	0.20262E-01
0.22349E+04	0.13481E-01	0.31751E+00	0.42805E-02	0.19624E-01
0.22350E+04	0.13056E-01	0.31757E+00	0.41462E-02	0.19008E-01
0.22351E+04	0.12633E-01	0.31763E+00	0.40126E-02	0.18395E-01
0.22352E+04	0.12212E-01	0.31770E+00	0.38797E-02	0.17786E-01
0.22353E+04	0.11811E-01	0.31776E+00	0.37531E-02	0.17206E-01
0.22354E+04	0.11429E-01	0.31782E+00	0.36324E-02	0.16652E-01
0.22355E+04	0.11070E-01	0.31789E+00	0.35190E-02	0.16132E-01
0.22356E+04	0.10717E-01	0.31795E+00	0.34076E-02	0.15622E-01
0.22357E+04	0.10373E-01	0.31801E+00	0.32987E-02	0.15123E-01
0.22358E+04	0.10063E-01	0.31807E+00	0.32008E-02	0.14674E-01
0.22359E+04	0.97538E-02	0.31814E+00	0.31030E-02	0.14225E-01
0.22360E+04	0.94766E-02	0.31819E+00	0.30154E-02	0.13824E-01
0.22361E+04	0.92052E-02	0.31823E+00	0.29294E-02	0.13429E-01
0.22362E+04	0.89404E-02	0.31827E+00	0.28454E-02	0.13045E-01
0.22363E+04	0.86852E-02	0.31830E+00	0.27645E-02	0.12674E-01
0.22364E+04	0.84300E-02	0.31834E+00	0.26836E-02	0.12303E-01
0.22365E+04	0.81764E-02	0.31838E+00	0.26032E-02	0.11934E-01
0.22366E+04	0.79295E-02	0.31841E+00	0.25248E-02	0.11575E-01
0.22367E+04	0.76836E-02	0.31844E+00	0.24467E-02	0.11217E-01
0.22368E+04	0.74433E-02	0.31846E+00	0.23704E-02	0.10867E-01
0.22369E+04	0.72053E-02	0.31849E+00	0.22948E-02	0.10520E-01
0.22370E+04	0.69681E-02	0.31851E+00	0.22195E-02	0.10175E-01
0.22371E+04	0.67367E-02	0.31854E+00	0.21459E-02	0.98376E-02
0.22372E+04	0.65145E-02	0.31856E+00	0.20753E-02	0.95138E-02
0.22373E+04	0.62952E-02	0.31858E+00	0.20055E-02	0.91942E-02
0.22374E+04	0.60775E-02	0.31861E+00	0.19363E-02	0.88769E-02
0.22375E+04	0.58638E-02	0.31863E+00	0.18684E-02	0.85654E-02
0.22376E+04	0.56505E-02	0.31865E+00	0.18005E-02	0.82544E-02

0.22377E+04	0.54402E-02	0.31867E+00	0.17337E-02	0.79478E-02
0.22378E+04	0.52300E-02	0.31870E+00	0.16668E-02	0.76412E-02
0.22379E+04	0.50208E-02	0.31872E+00	0.16002E-02	0.73360E-02
0.22380E+04	0.48127E-02	0.31874E+00	0.15340E-02	0.70324E-02
0.22381E+04	0.46050E-02	0.31876E+00	0.14679E-02	0.67292E-02
0.22382E+04	0.44015E-02	0.31878E+00	0.14031E-02	0.64323E-02
0.22383E+04	0.41990E-02	0.31879E+00	0.13386E-02	0.61367E-02
0.22384E+04	0.39973E-02	0.31881E+00	0.12744E-02	0.58423E-02
0.22385E+04	0.37990E-02	0.31883E+00	0.12112E-02	0.55527E-02
0.22386E+04	0.36017E-02	0.31885E+00	0.11484E-02	0.52647E-02
0.22387E+04	0.34070E-02	0.31887E+00	0.10864E-02	0.49805E-02
0.22388E+04	0.32140E-02	0.31890E+00	0.10249E-02	0.46987E-02
0.22389E+04	0.30218E-02	0.31892E+00	0.96370E-03	0.44180E-02
0.22390E+04	0.28324E-02	0.31894E+00	0.90336E-03	0.41414E-02
0.22391E+04	0.26466E-02	0.31897E+00	0.84418E-03	0.38700E-02
0.22392E+04	0.24638E-02	0.31900E+00	0.78596E-03	0.36032E-02
0.22393E+04	0.22856E-02	0.31903E+00	0.72919E-03	0.33429E-02
0.22394E+04	0.21133E-02	0.31906E+00	0.67429E-03	0.30912E-02
0.22395E+04	0.19428E-02	0.31909E+00	0.61992E-03	0.28420E-02
0.22396E+04	0.17727E-02	0.31913E+00	0.56573E-03	0.25935E-02
0.22397E+04	0.16043E-02	0.31916E+00	0.51204E-03	0.23474E-02
0.22398E+04	0.14399E-02	0.31920E+00	0.45960E-03	0.21070E-02
0.22399E+04	0.12824E-02	0.31924E+00	0.40938E-03	0.18767E-02
0.22400E+04	0.11293E-02	0.31928E+00	0.36055E-03	0.16529E-02
0.22401E+04	0.97688E-03	0.31934E+00	0.31196E-03	0.14301E-02
0.22402E+04	0.82502E-03	0.31941E+00	0.26352E-03	0.12081E-02
0.22403E+04	0.67722E-03	0.31948E+00	0.21636E-03	0.99186E-03
0.22404E+04	0.53154E-03	0.31954E+00	0.16985E-03	0.77866E-03
0.22405E+04	0.38626E-03	0.31961E+00	0.12345E-03	0.56595E-03
0.22406E+04	0.24357E-03	0.31968E+00	0.77864E-04	0.35696E-03
0.22407E+04	0.10613E-03	0.31974E+00	0.33936E-04	0.15558E-03
0.22408E+04	0.00000E+00	0.31981E+00	0.00000E+00	0.00000E+00
Channel 15				
Wavenumber	HIRS Filter Transmittance	Optical Element Transmittance	Product of the HIRS Filter and Optical Element Transmittances	Normalized Value of Column 4
0.22035E+04	0.00000E+00	0.30119E+00	0.00000E+00	0.00000E+00
0.22036E+04	0.34861E-04	0.30127E+00	0.10502E-04	0.48268E-04
0.22037E+04	0.74082E-04	0.30134E+00	0.22324E-04	0.10260E-03
0.22038E+04	0.11397E-03	0.30141E+00	0.34351E-04	0.15787E-03
0.22039E+04	0.15727E-03	0.30148E+00	0.47414E-04	0.21791E-03
0.22040E+04	0.20447E-03	0.30155E+00	0.61659E-04	0.28338E-03

0.22041E+04	0.26543E-03	0.30163E+00	0.80061E-04	0.36795E-03
0.22042E+04	0.33043E-03	0.30170E+00	0.99688E-04	0.45816E-03
0.22043E+04	0.39841E-03	0.30173E+00	0.12021E-03	0.55249E-03
0.22044E+04	0.46641E-03	0.30177E+00	0.14075E-03	0.64686E-03
0.22045E+04	0.53594E-03	0.30180E+00	0.16175E-03	0.74338E-03
0.22046E+04	0.60601E-03	0.30184E+00	0.18292E-03	0.84069E-03
0.22047E+04	0.67871E-03	0.30188E+00	0.20489E-03	0.94167E-03
0.22048E+04	0.75454E-03	0.30192E+00	0.22781E-03	0.10470E-02
0.22049E+04	0.83221E-03	0.30196E+00	0.25130E-03	0.11549E-02
0.22050E+04	0.91334E-03	0.30200E+00	0.27583E-03	0.12677E-02
0.22051E+04	0.99459E-03	0.30205E+00	0.30042E-03	0.13807E-02
0.22052E+04	0.10762E-02	0.30210E+00	0.32513E-03	0.14942E-02
0.22053E+04	0.11595E-02	0.30215E+00	0.35035E-03	0.16102E-02
0.22054E+04	0.12443E-02	0.30220E+00	0.37602E-03	0.17282E-02
0.22055E+04	0.13303E-02	0.30225E+00	0.40207E-03	0.18479E-02
0.22056E+04	0.14165E-02	0.30230E+00	0.42821E-03	0.19680E-02
0.22057E+04	0.15033E-02	0.30235E+00	0.45453E-03	0.20890E-02
0.22058E+04	0.15918E-02	0.30240E+00	0.48135E-03	0.22122E-02
0.22059E+04	0.16807E-02	0.30245E+00	0.50832E-03	0.23362E-02
0.22060E+04	0.17703E-02	0.30250E+00	0.53553E-03	0.24612E-02
0.22061E+04	0.18605E-02	0.30256E+00	0.56292E-03	0.25871E-02
0.22062E+04	0.19521E-02	0.30262E+00	0.59076E-03	0.27151E-02
0.22063E+04	0.20447E-02	0.30268E+00	0.61891E-03	0.28445E-02
0.22064E+04	0.21375E-02	0.30274E+00	0.64710E-03	0.29740E-02
0.22065E+04	0.22312E-02	0.30281E+00	0.67562E-03	0.31051E-02
0.22066E+04	0.23258E-02	0.30286E+00	0.70441E-03	0.32374E-02
0.22067E+04	0.24208E-02	0.30292E+00	0.73332E-03	0.33702E-02
0.22068E+04	0.25162E-02	0.30298E+00	0.76233E-03	0.35036E-02
0.22069E+04	0.26118E-02	0.30303E+00	0.79146E-03	0.36375E-02
0.22070E+04	0.27075E-02	0.30309E+00	0.82061E-03	0.37714E-02
0.22071E+04	0.28035E-02	0.30314E+00	0.84984E-03	0.39058E-02
0.22072E+04	0.28995E-02	0.30319E+00	0.87911E-03	0.40403E-02
0.22073E+04	0.29980E-02	0.30324E+00	0.90911E-03	0.41782E-02
0.22074E+04	0.30981E-02	0.30329E+00	0.93963E-03	0.43184E-02
0.22075E+04	0.31992E-02	0.30334E+00	0.97045E-03	0.44601E-02
0.22076E+04	0.33010E-02	0.30339E+00	0.10015E-02	0.46027E-02
0.22077E+04	0.34029E-02	0.30343E+00	0.10326E-02	0.47456E-02
0.22078E+04	0.35050E-02	0.30348E+00	0.10637E-02	0.48885E-02
0.22079E+04	0.36071E-02	0.30352E+00	0.10948E-02	0.50318E-02
0.22080E+04	0.37094E-02	0.30357E+00	0.11260E-02	0.51752E-02
0.22081E+04	0.38121E-02	0.30360E+00	0.11574E-02	0.53191E-02
0.22082E+04	0.39156E-02	0.30363E+00	0.11889E-02	0.54641E-02
0.22083E+04	0.40200E-02	0.30367E+00	0.12207E-02	0.56104E-02

0.22084E+04	0.41273E-02	0.30370E+00	0.12534E-02	0.57607E-02
0.22085E+04	0.42386E-02	0.30373E+00	0.12874E-02	0.59167E-02
0.22086E+04	0.43511E-02	0.30376E+00	0.13217E-02	0.60744E-02
0.22087E+04	0.44659E-02	0.30379E+00	0.13567E-02	0.62353E-02
0.22088E+04	0.45810E-02	0.30383E+00	0.13918E-02	0.63967E-02
0.22089E+04	0.46983E-02	0.30386E+00	0.14276E-02	0.65612E-02
0.22090E+04	0.48192E-02	0.30389E+00	0.14645E-02	0.67308E-02
0.22091E+04	0.49441E-02	0.30392E+00	0.15026E-02	0.69059E-02
0.22092E+04	0.50705E-02	0.30396E+00	0.15412E-02	0.70833E-02
0.22093E+04	0.51972E-02	0.30399E+00	0.15799E-02	0.72612E-02
0.22094E+04	0.53344E-02	0.30403E+00	0.16218E-02	0.74537E-02
0.22095E+04	0.54821E-02	0.30406E+00	0.16669E-02	0.76608E-02
0.22096E+04	0.56299E-02	0.30410E+00	0.17121E-02	0.78685E-02
0.22097E+04	0.57924E-02	0.30414E+00	0.17617E-02	0.80966E-02
0.22098E+04	0.59644E-02	0.30418E+00	0.18142E-02	0.83380E-02
0.22099E+04	0.61431E-02	0.30422E+00	0.18689E-02	0.85891E-02
0.22100E+04	0.63355E-02	0.30426E+00	0.19276E-02	0.88591E-02
0.22101E+04	0.65366E-02	0.30429E+00	0.19890E-02	0.91412E-02
0.22102E+04	0.67380E-02	0.30432E+00	0.20505E-02	0.94239E-02
0.22103E+04	0.69437E-02	0.30435E+00	0.21133E-02	0.97125E-02
0.22104E+04	0.71557E-02	0.30438E+00	0.21780E-02	0.10010E-01
0.22105E+04	0.73746E-02	0.30441E+00	0.22449E-02	0.10317E-01
0.22106E+04	0.75986E-02	0.30445E+00	0.23134E-02	0.10632E-01
0.22107E+04	0.78268E-02	0.30448E+00	0.23831E-02	0.10953E-01
0.22108E+04	0.80553E-02	0.30452E+00	0.24530E-02	0.11274E-01
0.22109E+04	0.82865E-02	0.30456E+00	0.25237E-02	0.11599E-01
0.22110E+04	0.85227E-02	0.30460E+00	0.25960E-02	0.11931E-01
0.22111E+04	0.87594E-02	0.30464E+00	0.26685E-02	0.12264E-01
0.22112E+04	0.89976E-02	0.30468E+00	0.27414E-02	0.12599E-01
0.22113E+04	0.92389E-02	0.30472E+00	0.28153E-02	0.12939E-01
0.22114E+04	0.94844E-02	0.30477E+00	0.28905E-02	0.13285E-01
0.22115E+04	0.97299E-02	0.30481E+00	0.29658E-02	0.13630E-01
0.22116E+04	0.99760E-02	0.30485E+00	0.30412E-02	0.13977E-01
0.22117E+04	0.10222E-01	0.30490E+00	0.31167E-02	0.14324E-01
0.22118E+04	0.10476E-01	0.30494E+00	0.31945E-02	0.14681E-01
0.22119E+04	0.10731E-01	0.30498E+00	0.32727E-02	0.15041E-01
0.22120E+04	0.10988E-01	0.30503E+00	0.33516E-02	0.15403E-01
0.22121E+04	0.11249E-01	0.30508E+00	0.34319E-02	0.15773E-01
0.22122E+04	0.11511E-01	0.30513E+00	0.35123E-02	0.16142E-01
0.22123E+04	0.11775E-01	0.30518E+00	0.35936E-02	0.16516E-01
0.22124E+04	0.12046E-01	0.30523E+00	0.36768E-02	0.16898E-01
0.22125E+04	0.12322E-01	0.30528E+00	0.37616E-02	0.17288E-01
0.22126E+04	0.12610E-01	0.30533E+00	0.38503E-02	0.17696E-01

0.22127E+04	0.12899E-01	0.30538E+00	0.39392E-02	0.18104E-01
0.22128E+04	0.13191E-01	0.30543E+00	0.40289E-02	0.18517E-01
0.22129E+04	0.13494E-01	0.30548E+00	0.41221E-02	0.18945E-01
0.22130E+04	0.13799E-01	0.30552E+00	0.42159E-02	0.19376E-01
0.22131E+04	0.14105E-01	0.30557E+00	0.43102E-02	0.19809E-01
0.22132E+04	0.14455E-01	0.30561E+00	0.44177E-02	0.20303E-01
0.22133E+04	0.14890E-01	0.30566E+00	0.45513E-02	0.20917E-01
0.22134E+04	0.15395E-01	0.30572E+00	0.47064E-02	0.21630E-01
0.22135E+04	0.15961E-01	0.30577E+00	0.48804E-02	0.22430E-01
0.22136E+04	0.16569E-01	0.30582E+00	0.50673E-02	0.23289E-01
0.22137E+04	0.17217E-01	0.30587E+00	0.52663E-02	0.24203E-01
0.22138E+04	0.17893E-01	0.30592E+00	0.54740E-02	0.25158E-01
0.22139E+04	0.18601E-01	0.30597E+00	0.56915E-02	0.26158E-01
0.22140E+04	0.19344E-01	0.30603E+00	0.59196E-02	0.27206E-01
0.22141E+04	0.20117E-01	0.30608E+00	0.61575E-02	0.28299E-01
0.22142E+04	0.20900E-01	0.30613E+00	0.63983E-02	0.29406E-01
0.22143E+04	0.21688E-01	0.30619E+00	0.66407E-02	0.30520E-01
0.22144E+04	0.22478E-01	0.30625E+00	0.68837E-02	0.31637E-01
0.22145E+04	0.23279E-01	0.30630E+00	0.71303E-02	0.32770E-01
0.22146E+04	0.24089E-01	0.30635E+00	0.73797E-02	0.33916E-01
0.22147E+04	0.24899E-01	0.30641E+00	0.76291E-02	0.35063E-01
0.22148E+04	0.25727E-01	0.30646E+00	0.78843E-02	0.36235E-01
0.22149E+04	0.26594E-01	0.30651E+00	0.81515E-02	0.37463E-01
0.22150E+04	0.27517E-01	0.30657E+00	0.84358E-02	0.38770E-01
0.22151E+04	0.28513E-01	0.30662E+00	0.87426E-02	0.40180E-01
0.22152E+04	0.29555E-01	0.30668E+00	0.90638E-02	0.41656E-01
0.22153E+04	0.30637E-01	0.30674E+00	0.93974E-02	0.43190E-01
0.22154E+04	0.31763E-01	0.30679E+00	0.97447E-02	0.44786E-01
0.22155E+04	0.32938E-01	0.30685E+00	0.10107E-01	0.46451E-01
0.22156E+04	0.34165E-01	0.30690E+00	0.10485E-01	0.48190E-01
0.22157E+04	0.35452E-01	0.30696E+00	0.10882E-01	0.50014E-01
0.22158E+04	0.36789E-01	0.30702E+00	0.11295E-01	0.51910E-01
0.22159E+04	0.38185E-01	0.30707E+00	0.11726E-01	0.53889E-01
0.22160E+04	0.39639E-01	0.30713E+00	0.12174E-01	0.55952E-01
0.22161E+04	0.41164E-01	0.30719E+00	0.12645E-01	0.58116E-01
0.22162E+04	0.42798E-01	0.30725E+00	0.13150E-01	0.60435E-01
0.22163E+04	0.44574E-01	0.30732E+00	0.13699E-01	0.62958E-01
0.22164E+04	0.46475E-01	0.30738E+00	0.14286E-01	0.65655E-01
0.22165E+04	0.48486E-01	0.30745E+00	0.14907E-01	0.68511E-01
0.22166E+04	0.50593E-01	0.30751E+00	0.15558E-01	0.71503E-01
0.22167E+04	0.52802E-01	0.30758E+00	0.16240E-01	0.74640E-01
0.22168E+04	0.55099E-01	0.30764E+00	0.16951E-01	0.77903E-01
0.22169E+04	0.57490E-01	0.30770E+00	0.17690E-01	0.81301E-01

0.22170E+04	0.59978E-01	0.30777E+00	0.18459E-01	0.84837E-01
0.22171E+04	0.62558E-01	0.30783E+00	0.19257E-01	0.88504E-01
0.22172E+04	0.65237E-01	0.30789E+00	0.20086E-01	0.92314E-01
0.22173E+04	0.68026E-01	0.30796E+00	0.20949E-01	0.96279E-01
0.22174E+04	0.70920E-01	0.30802E+00	0.21845E-01	0.10040E+00
0.22175E+04	0.73924E-01	0.30808E+00	0.22775E-01	0.10467E+00
0.22176E+04	0.77036E-01	0.30814E+00	0.23738E-01	0.10910E+00
0.22177E+04	0.80267E-01	0.30820E+00	0.24739E-01	0.11370E+00
0.22178E+04	0.83631E-01	0.30827E+00	0.25781E-01	0.11849E+00
0.22179E+04	0.87146E-01	0.30833E+00	0.26870E-01	0.12349E+00
0.22180E+04	0.90826E-01	0.30839E+00	0.28010E-01	0.12873E+00
0.22181E+04	0.94687E-01	0.30844E+00	0.29206E-01	0.13423E+00
0.22182E+04	0.98696E-01	0.30850E+00	0.30448E-01	0.13994E+00
0.22183E+04	0.10283E+00	0.30856E+00	0.31728E-01	0.14582E+00
0.22184E+04	0.10709E+00	0.30862E+00	0.33050E-01	0.15190E+00
0.22185E+04	0.11152E+00	0.30867E+00	0.34422E-01	0.15820E+00
0.22186E+04	0.11611E+00	0.30873E+00	0.35847E-01	0.16475E+00
0.22187E+04	0.12089E+00	0.30879E+00	0.37328E-01	0.17156E+00
0.22188E+04	0.12585E+00	0.30884E+00	0.38867E-01	0.17863E+00
0.22189E+04	0.13099E+00	0.30890E+00	0.40463E-01	0.18597E+00
0.22190E+04	0.13632E+00	0.30896E+00	0.42117E-01	0.19356E+00
0.22191E+04	0.14182E+00	0.30901E+00	0.43824E-01	0.20141E+00
0.22192E+04	0.14746E+00	0.30907E+00	0.45574E-01	0.20945E+00
0.22193E+04	0.15322E+00	0.30913E+00	0.47363E-01	0.21768E+00
0.22194E+04	0.15910E+00	0.30918E+00	0.49191E-01	0.22608E+00
0.22195E+04	0.16511E+00	0.30924E+00	0.51059E-01	0.23466E+00
0.22196E+04	0.17130E+00	0.30930E+00	0.52982E-01	0.24350E+00
0.22197E+04	0.17768E+00	0.30936E+00	0.54966E-01	0.25262E+00
0.22198E+04	0.18425E+00	0.30942E+00	0.57009E-01	0.26201E+00
0.22199E+04	0.19100E+00	0.30948E+00	0.59110E-01	0.27166E+00
0.22200E+04	0.19790E+00	0.30954E+00	0.61257E-01	0.28153E+00
0.22201E+04	0.20493E+00	0.30959E+00	0.63445E-01	0.29158E+00
0.22202E+04	0.21212E+00	0.30965E+00	0.65682E-01	0.30187E+00
0.22203E+04	0.21948E+00	0.30971E+00	0.67973E-01	0.31240E+00
0.22204E+04	0.22697E+00	0.30976E+00	0.70307E-01	0.32312E+00
0.22205E+04	0.23459E+00	0.30982E+00	0.72680E-01	0.33403E+00
0.22206E+04	0.24233E+00	0.30988E+00	0.75093E-01	0.34512E+00
0.22207E+04	0.25019E+00	0.30994E+00	0.77543E-01	0.35638E+00
0.22208E+04	0.25817E+00	0.31000E+00	0.80031E-01	0.36782E+00
0.22209E+04	0.26625E+00	0.31006E+00	0.82553E-01	0.37941E+00
0.22210E+04	0.27443E+00	0.31012E+00	0.85105E-01	0.39114E+00
0.22211E+04	0.28268E+00	0.31018E+00	0.87683E-01	0.40298E+00
0.22212E+04	0.29096E+00	0.31025E+00	0.90268E-01	0.41486E+00

0.22213E+04	0.29924E+00	0.31031E+00	0.92857E-01	0.42676E+00
0.22214E+04	0.30754E+00	0.31037E+00	0.95452E-01	0.43869E+00
0.22215E+04	0.31586E+00	0.31044E+00	0.98054E-01	0.45065E+00
0.22216E+04	0.32418E+00	0.31050E+00	0.10066E+00	0.46261E+00
0.22217E+04	0.33246E+00	0.31057E+00	0.10325E+00	0.47454E+00
0.22218E+04	0.34073E+00	0.31064E+00	0.10584E+00	0.48644E+00
0.22219E+04	0.34897E+00	0.31070E+00	0.10843E+00	0.49832E+00
0.22220E+04	0.35720E+00	0.31077E+00	0.11101E+00	0.51018E+00
0.22221E+04	0.36543E+00	0.31084E+00	0.11359E+00	0.52205E+00
0.22222E+04	0.37359E+00	0.31091E+00	0.11616E+00	0.53384E+00
0.22223E+04	0.38168E+00	0.31099E+00	0.11870E+00	0.54552E+00
0.22224E+04	0.38968E+00	0.31106E+00	0.12121E+00	0.55709E+00
0.22225E+04	0.39759E+00	0.31113E+00	0.12370E+00	0.56852E+00
0.22226E+04	0.40539E+00	0.31120E+00	0.12616E+00	0.57982E+00
0.22227E+04	0.41309E+00	0.31128E+00	0.12859E+00	0.59097E+00
0.22228E+04	0.42069E+00	0.31135E+00	0.13098E+00	0.60198E+00
0.22229E+04	0.42819E+00	0.31143E+00	0.13335E+00	0.61286E+00
0.22230E+04	0.43560E+00	0.31150E+00	0.13569E+00	0.62362E+00
0.22231E+04	0.44294E+00	0.31158E+00	0.13801E+00	0.63429E+00
0.22232E+04	0.45023E+00	0.31165E+00	0.14031E+00	0.64487E+00
0.22233E+04	0.45744E+00	0.31173E+00	0.14260E+00	0.65536E+00
0.22234E+04	0.46453E+00	0.31181E+00	0.14484E+00	0.66568E+00
0.22235E+04	0.47150E+00	0.31188E+00	0.14705E+00	0.67584E+00
0.22236E+04	0.47836E+00	0.31196E+00	0.14923E+00	0.68584E+00
0.22237E+04	0.48512E+00	0.31203E+00	0.15137E+00	0.69569E+00
0.22238E+04	0.49176E+00	0.31211E+00	0.15348E+00	0.70539E+00
0.22239E+04	0.49830E+00	0.31218E+00	0.15556E+00	0.71494E+00
0.22240E+04	0.50468E+00	0.31226E+00	0.15759E+00	0.72427E+00
0.22241E+04	0.51088E+00	0.31234E+00	0.15957E+00	0.73336E+00
0.22242E+04	0.51691E+00	0.31243E+00	0.16149E+00	0.74221E+00
0.22243E+04	0.52278E+00	0.31251E+00	0.16337E+00	0.75085E+00
0.22244E+04	0.52850E+00	0.31260E+00	0.16521E+00	0.75928E+00
0.22245E+04	0.53409E+00	0.31268E+00	0.16700E+00	0.76751E+00
0.22246E+04	0.53954E+00	0.31276E+00	0.16875E+00	0.77554E+00
0.22247E+04	0.54487E+00	0.31284E+00	0.17046E+00	0.78340E+00
0.22248E+04	0.55007E+00	0.31292E+00	0.17213E+00	0.79109E+00
0.22249E+04	0.55516E+00	0.31300E+00	0.17376E+00	0.79860E+00
0.22250E+04	0.56011E+00	0.31308E+00	0.17536E+00	0.80593E+00
0.22251E+04	0.56492E+00	0.31315E+00	0.17690E+00	0.81303E+00
0.22252E+04	0.56954E+00	0.31322E+00	0.17839E+00	0.81986E+00
0.22253E+04	0.57396E+00	0.31329E+00	0.17982E+00	0.82641E+00
0.22254E+04	0.57823E+00	0.31336E+00	0.18119E+00	0.83274E+00
0.22255E+04	0.58234E+00	0.31343E+00	0.18252E+00	0.83885E+00

0.22256E+04	0.58629E+00	0.31349E+00	0.18379E+00	0.84470E+00
0.22257E+04	0.59006E+00	0.31355E+00	0.18501E+00	0.85031E+00
0.22258E+04	0.59365E+00	0.31361E+00	0.18618E+00	0.85566E+00
0.22259E+04	0.59707E+00	0.31368E+00	0.18729E+00	0.86076E+00
0.22260E+04	0.60034E+00	0.31374E+00	0.18835E+00	0.86564E+00
0.22261E+04	0.60348E+00	0.31380E+00	0.18937E+00	0.87035E+00
0.22262E+04	0.60650E+00	0.31386E+00	0.19036E+00	0.87487E+00
0.22263E+04	0.60940E+00	0.31392E+00	0.19131E+00	0.87923E+00
0.22264E+04	0.61219E+00	0.31399E+00	0.19222E+00	0.88342E+00
0.22265E+04	0.61486E+00	0.31405E+00	0.19310E+00	0.88745E+00
0.22266E+04	0.61744E+00	0.31410E+00	0.19394E+00	0.89133E+00
0.22267E+04	0.61990E+00	0.31416E+00	0.19475E+00	0.89504E+00
0.22268E+04	0.62221E+00	0.31422E+00	0.19551E+00	0.89854E+00
0.22269E+04	0.62437E+00	0.31427E+00	0.19622E+00	0.90182E+00
0.22270E+04	0.62639E+00	0.31433E+00	0.19689E+00	0.90490E+00
0.22271E+04	0.62829E+00	0.31438E+00	0.19752E+00	0.90780E+00
0.22272E+04	0.63012E+00	0.31444E+00	0.19813E+00	0.91060E+00
0.22273E+04	0.63189E+00	0.31448E+00	0.19872E+00	0.91328E+00
0.22274E+04	0.63357E+00	0.31452E+00	0.19927E+00	0.91583E+00
0.22275E+04	0.63516E+00	0.31456E+00	0.19980E+00	0.91825E+00
0.22276E+04	0.63667E+00	0.31461E+00	0.20030E+00	0.92056E+00
0.22277E+04	0.63810E+00	0.31465E+00	0.20078E+00	0.92275E+00
0.22278E+04	0.63947E+00	0.31469E+00	0.20123E+00	0.92486E+00
0.22279E+04	0.64081E+00	0.31473E+00	0.20168E+00	0.92692E+00
0.22280E+04	0.64210E+00	0.31478E+00	0.20212E+00	0.92891E+00
0.22281E+04	0.64331E+00	0.31482E+00	0.20253E+00	0.93081E+00
0.22282E+04	0.64445E+00	0.31487E+00	0.20292E+00	0.93260E+00
0.22283E+04	0.64554E+00	0.31492E+00	0.20329E+00	0.93432E+00
0.22284E+04	0.64658E+00	0.31497E+00	0.20366E+00	0.93598E+00
0.22285E+04	0.64758E+00	0.31502E+00	0.20400E+00	0.93758E+00
0.22286E+04	0.64852E+00	0.31508E+00	0.20433E+00	0.93910E+00
0.22287E+04	0.64938E+00	0.31513E+00	0.20464E+00	0.94052E+00
0.22288E+04	0.65021E+00	0.31519E+00	0.20494E+00	0.94188E+00
0.22289E+04	0.65100E+00	0.31525E+00	0.20523E+00	0.94320E+00
0.22290E+04	0.65180E+00	0.31530E+00	0.20551E+00	0.94452E+00
0.22291E+04	0.65260E+00	0.31536E+00	0.20581E+00	0.94587E+00
0.22292E+04	0.65337E+00	0.31543E+00	0.20609E+00	0.94717E+00
0.22293E+04	0.65410E+00	0.31549E+00	0.20636E+00	0.94841E+00
0.22294E+04	0.65479E+00	0.31555E+00	0.20662E+00	0.94960E+00
0.22295E+04	0.65547E+00	0.31561E+00	0.20688E+00	0.95078E+00
0.22296E+04	0.65615E+00	0.31568E+00	0.20713E+00	0.95197E+00
0.22297E+04	0.65685E+00	0.31575E+00	0.20740E+00	0.95318E+00
0.22298E+04	0.65754E+00	0.31581E+00	0.20766E+00	0.95438E+00

0.22299E+04	0.65819E+00	0.31588E+00	0.20791E+00	0.95553E+00
0.22300E+04	0.65883E+00	0.31595E+00	0.20815E+00	0.95666E+00
0.22301E+04	0.65943E+00	0.31599E+00	0.20837E+00	0.95767E+00
0.22302E+04	0.66001E+00	0.31603E+00	0.20858E+00	0.95864E+00
0.22303E+04	0.66056E+00	0.31608E+00	0.20879E+00	0.95957E+00
0.22304E+04	0.66108E+00	0.31612E+00	0.20898E+00	0.96046E+00
0.22305E+04	0.66158E+00	0.31617E+00	0.20917E+00	0.96132E+00
0.22306E+04	0.66211E+00	0.31621E+00	0.20937E+00	0.96223E+00
0.22307E+04	0.66270E+00	0.31625E+00	0.20958E+00	0.96321E+00
0.22308E+04	0.66333E+00	0.31630E+00	0.20981E+00	0.96425E+00
0.22309E+04	0.66398E+00	0.31634E+00	0.21004E+00	0.96533E+00
0.22310E+04	0.66460E+00	0.31638E+00	0.21027E+00	0.96636E+00
0.22311E+04	0.66519E+00	0.31642E+00	0.21048E+00	0.96734E+00
0.22312E+04	0.66579E+00	0.31646E+00	0.21070E+00	0.96833E+00
0.22313E+04	0.66641E+00	0.31650E+00	0.21092E+00	0.96935E+00
0.22314E+04	0.66705E+00	0.31653E+00	0.21115E+00	0.97040E+00
0.22315E+04	0.66773E+00	0.31657E+00	0.21139E+00	0.97151E+00
0.22316E+04	0.66844E+00	0.31661E+00	0.21163E+00	0.97264E+00
0.22317E+04	0.66917E+00	0.31664E+00	0.21189E+00	0.97381E+00
0.22318E+04	0.66993E+00	0.31668E+00	0.21215E+00	0.97502E+00
0.22319E+04	0.67073E+00	0.31671E+00	0.21243E+00	0.97630E+00
0.22320E+04	0.67157E+00	0.31674E+00	0.21271E+00	0.97761E+00
0.22321E+04	0.67242E+00	0.31676E+00	0.21299E+00	0.97890E+00
0.22322E+04	0.67324E+00	0.31677E+00	0.21326E+00	0.98013E+00
0.22323E+04	0.67400E+00	0.31679E+00	0.21351E+00	0.98129E+00
0.22324E+04	0.67472E+00	0.31680E+00	0.21375E+00	0.98239E+00
0.22325E+04	0.67540E+00	0.31682E+00	0.21398E+00	0.98342E+00
0.22326E+04	0.67604E+00	0.31683E+00	0.21419E+00	0.98440E+00
0.22327E+04	0.67666E+00	0.31684E+00	0.21439E+00	0.98533E+00
0.22328E+04	0.67728E+00	0.31686E+00	0.21460E+00	0.98628E+00
0.22329E+04	0.67793E+00	0.31687E+00	0.21481E+00	0.98727E+00
0.22330E+04	0.67865E+00	0.31688E+00	0.21505E+00	0.98837E+00
0.22331E+04	0.67945E+00	0.31690E+00	0.21532E+00	0.98958E+00
0.22332E+04	0.68027E+00	0.31691E+00	0.21558E+00	0.99081E+00
0.22333E+04	0.68106E+00	0.31692E+00	0.21584E+00	0.99200E+00
0.22334E+04	0.68178E+00	0.31694E+00	0.21608E+00	0.99309E+00
0.22335E+04	0.68242E+00	0.31695E+00	0.21629E+00	0.99406E+00
0.22336E+04	0.68296E+00	0.31697E+00	0.21648E+00	0.99491E+00
0.22337E+04	0.68343E+00	0.31698E+00	0.21664E+00	0.99564E+00
0.22338E+04	0.68382E+00	0.31700E+00	0.21677E+00	0.99626E+00
0.22339E+04	0.68414E+00	0.31702E+00	0.21689E+00	0.99678E+00
0.22340E+04	0.68444E+00	0.31704E+00	0.21699E+00	0.99728E+00
0.22341E+04	0.68472E+00	0.31709E+00	0.21712E+00	0.99785E+00

0.22342E+04	0.68498E+00	0.31714E+00	0.21724E+00	0.99840E+00
0.22343E+04	0.68522E+00	0.31719E+00	0.21735E+00	0.99890E+00
0.22344E+04	0.68539E+00	0.31724E+00	0.21744E+00	0.99931E+00
0.22345E+04	0.68548E+00	0.31730E+00	0.21750E+00	0.99960E+00
0.22346E+04	0.68550E+00	0.31735E+00	0.21754E+00	0.99980E+00
0.22347E+04	0.68545E+00	0.31740E+00	0.21757E+00	0.99991E+00
0.22348E+04	0.68538E+00	0.31746E+00	0.21758E+00	0.99997E+00
0.22349E+04	0.68528E+00	0.31751E+00	0.21759E+00	0.10000E+01
0.22350E+04	0.68510E+00	0.31757E+00	0.21757E+00	0.99991E+00
0.22351E+04	0.68483E+00	0.31763E+00	0.21753E+00	0.99973E+00
0.22352E+04	0.68452E+00	0.31770E+00	0.21747E+00	0.99946E+00
0.22353E+04	0.68414E+00	0.31776E+00	0.21739E+00	0.99911E+00
0.22354E+04	0.68370E+00	0.31782E+00	0.21730E+00	0.99867E+00
0.22355E+04	0.68319E+00	0.31789E+00	0.21718E+00	0.99813E+00
0.22356E+04	0.68259E+00	0.31795E+00	0.21703E+00	0.99744E+00
0.22357E+04	0.68190E+00	0.31801E+00	0.21685E+00	0.99663E+00
0.22358E+04	0.68114E+00	0.31807E+00	0.21665E+00	0.99571E+00
0.22359E+04	0.68032E+00	0.31814E+00	0.21643E+00	0.99470E+00
0.22360E+04	0.67944E+00	0.31819E+00	0.21620E+00	0.99361E+00
0.22361E+04	0.67852E+00	0.31823E+00	0.21592E+00	0.99237E+00
0.22362E+04	0.67751E+00	0.31827E+00	0.21563E+00	0.99101E+00
0.22363E+04	0.67643E+00	0.31830E+00	0.21531E+00	0.98955E+00
0.22364E+04	0.67531E+00	0.31834E+00	0.21498E+00	0.98801E+00
0.22365E+04	0.67413E+00	0.31838E+00	0.21463E+00	0.98640E+00
0.22366E+04	0.67288E+00	0.31841E+00	0.21425E+00	0.98466E+00
0.22367E+04	0.67151E+00	0.31844E+00	0.21384E+00	0.98276E+00
0.22368E+04	0.66998E+00	0.31846E+00	0.21336E+00	0.98060E+00
0.22369E+04	0.66826E+00	0.31849E+00	0.21284E+00	0.97817E+00
0.22370E+04	0.66640E+00	0.31851E+00	0.21226E+00	0.97552E+00
0.22371E+04	0.66440E+00	0.31854E+00	0.21164E+00	0.97266E+00
0.22372E+04	0.66229E+00	0.31856E+00	0.21098E+00	0.96965E+00
0.22373E+04	0.66009E+00	0.31858E+00	0.21029E+00	0.96649E+00
0.22374E+04	0.65777E+00	0.31861E+00	0.20957E+00	0.96317E+00
0.22375E+04	0.65535E+00	0.31863E+00	0.20881E+00	0.95969E+00
0.22376E+04	0.65285E+00	0.31865E+00	0.20803E+00	0.95610E+00
0.22377E+04	0.65027E+00	0.31867E+00	0.20722E+00	0.95238E+00
0.22378E+04	0.64755E+00	0.31870E+00	0.20637E+00	0.94847E+00
0.22379E+04	0.64468E+00	0.31872E+00	0.20547E+00	0.94433E+00
0.22380E+04	0.64167E+00	0.31874E+00	0.20453E+00	0.93998E+00
0.22381E+04	0.63852E+00	0.31876E+00	0.20353E+00	0.93542E+00
0.22382E+04	0.63525E+00	0.31878E+00	0.20250E+00	0.93069E+00
0.22383E+04	0.63187E+00	0.31879E+00	0.20144E+00	0.92578E+00
0.22384E+04	0.62838E+00	0.31881E+00	0.20033E+00	0.92071E+00

0.22385E+04	0.62476E+00	0.31883E+00	0.19919E+00	0.91547E+00
0.22386E+04	0.62103E+00	0.31885E+00	0.19802E+00	0.91006E+00
0.22387E+04	0.61717E+00	0.31887E+00	0.19680E+00	0.90447E+00
0.22388E+04	0.61320E+00	0.31890E+00	0.19555E+00	0.89871E+00
0.22389E+04	0.60910E+00	0.31892E+00	0.19425E+00	0.89277E+00
0.22390E+04	0.60484E+00	0.31894E+00	0.19291E+00	0.88658E+00
0.22391E+04	0.60038E+00	0.31897E+00	0.19151E+00	0.88014E+00
0.22392E+04	0.59574E+00	0.31900E+00	0.19004E+00	0.87341E+00
0.22393E+04	0.59091E+00	0.31903E+00	0.18852E+00	0.86641E+00
0.22394E+04	0.58593E+00	0.31906E+00	0.18695E+00	0.85920E+00
0.22395E+04	0.58083E+00	0.31909E+00	0.18534E+00	0.85180E+00
0.22396E+04	0.57561E+00	0.31913E+00	0.18369E+00	0.84424E+00
0.22397E+04	0.57029E+00	0.31916E+00	0.18202E+00	0.83653E+00
0.22398E+04	0.56490E+00	0.31920E+00	0.18032E+00	0.82871E+00
0.22399E+04	0.55946E+00	0.31924E+00	0.17860E+00	0.82083E+00
0.22400E+04	0.55395E+00	0.31928E+00	0.17686E+00	0.81285E+00
0.22401E+04	0.54836E+00	0.31934E+00	0.17512E+00	0.80481E+00
0.22402E+04	0.54262E+00	0.31941E+00	0.17332E+00	0.79656E+00
0.22403E+04	0.53673E+00	0.31948E+00	0.17147E+00	0.78808E+00
0.22404E+04	0.53069E+00	0.31954E+00	0.16958E+00	0.77937E+00
0.22405E+04	0.52450E+00	0.31961E+00	0.16764E+00	0.77044E+00
0.22406E+04	0.51821E+00	0.31968E+00	0.16566E+00	0.76135E+00
0.22407E+04	0.51183E+00	0.31974E+00	0.16365E+00	0.75214E+00
0.22408E+04	0.50537E+00	0.31981E+00	0.16162E+00	0.74280E+00
0.22409E+04	0.49881E+00	0.31988E+00	0.15956E+00	0.73332E+00
0.22410E+04	0.49218E+00	0.31994E+00	0.15747E+00	0.72372E+00
0.22411E+04	0.48547E+00	0.32001E+00	0.15536E+00	0.71400E+00
0.22412E+04	0.47868E+00	0.32007E+00	0.15321E+00	0.70415E+00
0.22413E+04	0.47180E+00	0.32013E+00	0.15104E+00	0.69415E+00
0.22414E+04	0.46481E+00	0.32020E+00	0.14883E+00	0.68401E+00
0.22415E+04	0.45773E+00	0.32026E+00	0.14659E+00	0.67373E+00
0.22416E+04	0.45059E+00	0.32032E+00	0.14433E+00	0.66333E+00
0.22417E+04	0.44338E+00	0.32037E+00	0.14205E+00	0.65283E+00
0.22418E+04	0.43612E+00	0.32043E+00	0.13975E+00	0.64226E+00
0.22419E+04	0.42880E+00	0.32049E+00	0.13742E+00	0.63158E+00
0.22420E+04	0.42136E+00	0.32054E+00	0.13506E+00	0.62074E+00
0.22421E+04	0.41383E+00	0.32058E+00	0.13266E+00	0.60971E+00
0.22422E+04	0.40623E+00	0.32061E+00	0.13024E+00	0.59859E+00
0.22423E+04	0.39860E+00	0.32065E+00	0.12781E+00	0.58741E+00
0.22424E+04	0.39094E+00	0.32069E+00	0.12537E+00	0.57618E+00
0.22425E+04	0.38325E+00	0.32072E+00	0.12292E+00	0.56491E+00
0.22426E+04	0.37558E+00	0.32075E+00	0.12047E+00	0.55365E+00
0.22427E+04	0.36794E+00	0.32078E+00	0.11803E+00	0.54244E+00

0.22428E+04	0.36035E+00	0.32081E+00	0.11561E+00	0.53131E+00
0.22429E+04	0.35283E+00	0.32084E+00	0.11320E+00	0.52027E+00
0.22430E+04	0.34536E+00	0.32087E+00	0.11082E+00	0.50931E+00
0.22431E+04	0.33794E+00	0.32090E+00	0.10844E+00	0.49840E+00
0.22432E+04	0.33053E+00	0.32093E+00	0.10608E+00	0.48751E+00
0.22433E+04	0.32313E+00	0.32095E+00	0.10371E+00	0.47664E+00
0.22434E+04	0.31578E+00	0.32098E+00	0.10136E+00	0.46583E+00
0.22435E+04	0.30847E+00	0.32100E+00	0.99020E-01	0.45509E+00
0.22436E+04	0.30119E+00	0.32103E+00	0.96693E-01	0.44439E+00
0.22437E+04	0.29395E+00	0.32106E+00	0.94374E-01	0.43373E+00
0.22438E+04	0.28672E+00	0.32109E+00	0.92063E-01	0.42311E+00
0.22439E+04	0.27955E+00	0.32111E+00	0.89767E-01	0.41256E+00
0.22440E+04	0.27246E+00	0.32114E+00	0.87496E-01	0.40212E+00
0.22441E+04	0.26544E+00	0.32117E+00	0.85253E-01	0.39181E+00
0.22442E+04	0.25852E+00	0.32120E+00	0.83036E-01	0.38162E+00
0.22443E+04	0.25166E+00	0.32123E+00	0.80840E-01	0.37153E+00
0.22444E+04	0.24487E+00	0.32126E+00	0.78669E-01	0.36155E+00
0.22445E+04	0.23820E+00	0.32129E+00	0.76530E-01	0.35173E+00
0.22446E+04	0.23163E+00	0.32133E+00	0.74430E-01	0.34207E+00
0.22447E+04	0.22517E+00	0.32136E+00	0.72362E-01	0.33257E+00
0.22448E+04	0.21880E+00	0.32140E+00	0.70321E-01	0.32319E+00
0.22449E+04	0.21251E+00	0.32143E+00	0.68308E-01	0.31394E+00
0.22450E+04	0.20632E+00	0.32146E+00	0.66326E-01	0.30483E+00
0.22451E+04	0.20021E+00	0.32149E+00	0.64367E-01	0.29583E+00
0.22452E+04	0.19420E+00	0.32152E+00	0.62440E-01	0.28697E+00
0.22453E+04	0.18831E+00	0.32155E+00	0.60551E-01	0.27829E+00
0.22454E+04	0.18253E+00	0.32157E+00	0.58696E-01	0.26976E+00
0.22455E+04	0.17685E+00	0.32160E+00	0.56876E-01	0.26140E+00
0.22456E+04	0.17129E+00	0.32163E+00	0.55093E-01	0.25320E+00
0.22457E+04	0.16585E+00	0.32166E+00	0.53347E-01	0.24518E+00
0.22458E+04	0.16052E+00	0.32169E+00	0.51638E-01	0.23732E+00
0.22459E+04	0.15530E+00	0.32172E+00	0.49964E-01	0.22963E+00
0.22460E+04	0.15017E+00	0.32175E+00	0.48317E-01	0.22206E+00
0.22461E+04	0.14512E+00	0.32179E+00	0.46700E-01	0.21463E+00
0.22462E+04	0.14018E+00	0.32184E+00	0.45117E-01	0.20735E+00
0.22463E+04	0.13536E+00	0.32189E+00	0.43571E-01	0.20025E+00
0.22464E+04	0.13065E+00	0.32193E+00	0.42060E-01	0.19330E+00
0.22465E+04	0.12605E+00	0.32198E+00	0.40585E-01	0.18652E+00
0.22466E+04	0.12155E+00	0.32202E+00	0.39142E-01	0.17989E+00
0.22467E+04	0.11717E+00	0.32207E+00	0.37738E-01	0.17344E+00
0.22468E+04	0.11295E+00	0.32211E+00	0.36382E-01	0.16721E+00
0.22469E+04	0.10887E+00	0.32215E+00	0.35072E-01	0.16119E+00
0.22470E+04	0.10491E+00	0.32220E+00	0.33801E-01	0.15534E+00

0.22471E+04	0.10106E+00	0.32224E+00	0.32564E-01	0.14966E+00
0.22472E+04	0.97303E-01	0.32228E+00	0.31359E-01	0.14412E+00
0.22473E+04	0.93651E-01	0.32232E+00	0.30186E-01	0.13873E+00
0.22474E+04	0.90115E-01	0.32236E+00	0.29049E-01	0.13351E+00
0.22475E+04	0.86712E-01	0.32240E+00	0.27956E-01	0.12848E+00
0.22476E+04	0.83468E-01	0.32244E+00	0.26913E-01	0.12369E+00
0.22477E+04	0.80372E-01	0.32248E+00	0.25918E-01	0.11912E+00
0.22478E+04	0.77376E-01	0.32252E+00	0.24955E-01	0.11469E+00
0.22479E+04	0.74478E-01	0.32256E+00	0.24023E-01	0.11041E+00
0.22480E+04	0.71687E-01	0.32259E+00	0.23126E-01	0.10628E+00
0.22481E+04	0.68999E-01	0.32264E+00	0.22262E-01	0.10231E+00
0.22482E+04	0.66412E-01	0.32269E+00	0.21430E-01	0.98492E-01
0.22483E+04	0.63933E-01	0.32273E+00	0.20633E-01	0.94829E-01
0.22484E+04	0.61559E-01	0.32278E+00	0.19870E-01	0.91321E-01
0.22485E+04	0.59290E-01	0.32283E+00	0.19140E-01	0.87967E-01
0.22486E+04	0.57108E-01	0.32288E+00	0.18439E-01	0.84743E-01
0.22487E+04	0.55004E-01	0.32293E+00	0.17762E-01	0.81634E-01
0.22488E+04	0.52963E-01	0.32298E+00	0.17106E-01	0.78616E-01
0.22489E+04	0.50979E-01	0.32303E+00	0.16467E-01	0.75683E-01
0.22490E+04	0.49053E-01	0.32307E+00	0.15848E-01	0.72834E-01
0.22491E+04	0.47202E-01	0.32313E+00	0.15252E-01	0.70098E-01
0.22492E+04	0.45442E-01	0.32318E+00	0.14686E-01	0.67496E-01
0.22493E+04	0.43766E-01	0.32324E+00	0.14147E-01	0.65019E-01
0.22494E+04	0.42154E-01	0.32330E+00	0.13628E-01	0.62634E-01
0.22495E+04	0.40611E-01	0.32335E+00	0.13132E-01	0.60351E-01
0.22496E+04	0.39150E-01	0.32341E+00	0.12662E-01	0.58191E-01
0.22497E+04	0.37762E-01	0.32347E+00	0.12215E-01	0.56139E-01
0.22498E+04	0.36423E-01	0.32354E+00	0.11784E-01	0.54159E-01
0.22499E+04	0.35122E-01	0.32360E+00	0.11366E-01	0.52235E-01
0.22500E+04	0.33856E-01	0.32366E+00	0.10958E-01	0.50361E-01
0.22501E+04	0.32627E-01	0.32373E+00	0.10563E-01	0.48545E-01
0.22502E+04	0.31432E-01	0.32381E+00	0.10178E-01	0.46778E-01
0.22503E+04	0.30295E-01	0.32389E+00	0.98122E-02	0.45096E-01
0.22504E+04	0.29251E-01	0.32397E+00	0.94762E-02	0.43552E-01
0.22505E+04	0.28291E-01	0.32404E+00	0.91675E-02	0.42133E-01
0.22506E+04	0.27363E-01	0.32412E+00	0.88690E-02	0.40761E-01
0.22507E+04	0.26453E-01	0.32421E+00	0.85761E-02	0.39415E-01
0.22508E+04	0.25564E-01	0.32429E+00	0.82902E-02	0.38101E-01
0.22509E+04	0.24701E-01	0.32437E+00	0.80121E-02	0.36823E-01
0.22510E+04	0.23876E-01	0.32445E+00	0.77466E-02	0.35603E-01
0.22511E+04	0.23098E-01	0.32453E+00	0.74962E-02	0.34452E-01
0.22512E+04	0.22380E-01	0.32462E+00	0.72650E-02	0.33389E-01
0.22513E+04	0.21740E-01	0.32470E+00	0.70591E-02	0.32443E-01

0.22514E+04	0.21156E-01	0.32478E+00	0.68710E-02	0.31579E-01
0.22515E+04	0.20598E-01	0.32487E+00	0.66915E-02	0.30753E-01
0.22516E+04	0.20061E-01	0.32495E+00	0.65189E-02	0.29960E-01
0.22517E+04	0.19545E-01	0.32504E+00	0.63530E-02	0.29198E-01
0.22518E+04	0.19030E-01	0.32512E+00	0.61870E-02	0.28435E-01
0.22519E+04	0.18505E-01	0.32520E+00	0.60179E-02	0.27658E-01
0.22520E+04	0.17972E-01	0.32529E+00	0.58463E-02	0.26869E-01
0.22521E+04	0.17452E-01	0.32535E+00	0.56779E-02	0.26095E-01
0.22522E+04	0.16963E-01	0.32541E+00	0.55200E-02	0.25369E-01
0.22523E+04	0.16487E-01	0.32547E+00	0.53660E-02	0.24662E-01
0.22524E+04	0.16013E-01	0.32554E+00	0.52128E-02	0.23957E-01
0.22525E+04	0.15545E-01	0.32560E+00	0.50613E-02	0.23261E-01
0.22526E+04	0.15078E-01	0.32566E+00	0.49104E-02	0.22568E-01
0.22527E+04	0.14612E-01	0.32572E+00	0.47596E-02	0.21874E-01
0.22528E+04	0.14149E-01	0.32578E+00	0.46096E-02	0.21185E-01
0.22529E+04	0.13687E-01	0.32584E+00	0.44597E-02	0.20496E-01
0.22530E+04	0.13226E-01	0.32590E+00	0.43103E-02	0.19810E-01
0.22531E+04	0.12767E-01	0.32596E+00	0.41614E-02	0.19125E-01
0.22532E+04	0.12308E-01	0.32602E+00	0.40127E-02	0.18442E-01
0.22533E+04	0.11853E-01	0.32608E+00	0.38649E-02	0.17763E-01
0.22534E+04	0.11404E-01	0.32614E+00	0.37194E-02	0.17094E-01
0.22535E+04	0.10959E-01	0.32620E+00	0.35749E-02	0.16430E-01
0.22536E+04	0.10517E-01	0.32627E+00	0.34313E-02	0.15770E-01
0.22537E+04	0.10081E-01	0.32633E+00	0.32898E-02	0.15120E-01
0.22538E+04	0.96714E-02	0.32639E+00	0.31566E-02	0.14508E-01
0.22539E+04	0.93031E-02	0.32645E+00	0.30370E-02	0.13958E-01
0.22540E+04	0.89564E-02	0.32650E+00	0.29243E-02	0.13440E-01
0.22541E+04	0.86301E-02	0.32653E+00	0.28180E-02	0.12951E-01
0.22542E+04	0.83343E-02	0.32655E+00	0.27216E-02	0.12508E-01
0.22543E+04	0.80777E-02	0.32658E+00	0.26380E-02	0.12124E-01
0.22544E+04	0.78505E-02	0.32660E+00	0.25640E-02	0.11784E-01
0.22545E+04	0.76422E-02	0.32663E+00	0.24961E-02	0.11472E-01
0.22546E+04	0.74419E-02	0.32665E+00	0.24309E-02	0.11172E-01
0.22547E+04	0.72453E-02	0.32667E+00	0.23669E-02	0.10878E-01
0.22548E+04	0.70549E-02	0.32670E+00	0.23048E-02	0.10593E-01
0.22549E+04	0.68688E-02	0.32672E+00	0.22442E-02	0.10314E-01
0.22550E+04	0.66856E-02	0.32675E+00	0.21845E-02	0.10040E-01
0.22551E+04	0.65064E-02	0.32677E+00	0.21261E-02	0.97714E-02
0.22552E+04	0.63273E-02	0.32680E+00	0.20678E-02	0.95032E-02
0.22553E+04	0.61495E-02	0.32682E+00	0.20098E-02	0.92368E-02
0.22554E+04	0.59733E-02	0.32685E+00	0.19524E-02	0.89730E-02
0.22555E+04	0.58051E-02	0.32688E+00	0.18976E-02	0.87210E-02
0.22556E+04	0.56373E-02	0.32690E+00	0.18428E-02	0.84694E-02

0.22557E+04	0.54711E-02	0.32692E+00	0.17886E-02	0.82202E-02
0.22558E+04	0.53094E-02	0.32694E+00	0.17358E-02	0.79777E-02
0.22559E+04	0.51515E-02	0.32696E+00	0.16843E-02	0.77410E-02
0.22560E+04	0.49957E-02	0.32698E+00	0.16335E-02	0.75073E-02
0.22561E+04	0.48408E-02	0.32701E+00	0.15830E-02	0.72753E-02
0.22562E+04	0.46860E-02	0.32705E+00	0.15326E-02	0.70435E-02
0.22563E+04	0.45373E-02	0.32709E+00	0.14841E-02	0.68207E-02
0.22564E+04	0.43957E-02	0.32713E+00	0.14379E-02	0.66086E-02
0.22565E+04	0.42547E-02	0.32717E+00	0.13920E-02	0.63974E-02
0.22566E+04	0.41137E-02	0.32719E+00	0.13460E-02	0.61860E-02
0.22567E+04	0.39748E-02	0.32722E+00	0.13007E-02	0.59777E-02
0.22568E+04	0.38361E-02	0.32725E+00	0.12554E-02	0.57696E-02
0.22569E+04	0.36976E-02	0.32728E+00	0.12102E-02	0.55618E-02
0.22570E+04	0.35596E-02	0.32731E+00	0.11651E-02	0.53547E-02
0.22571E+04	0.34221E-02	0.32733E+00	0.11202E-02	0.51482E-02
0.22572E+04	0.32864E-02	0.32736E+00	0.10758E-02	0.49444E-02
0.22573E+04	0.31523E-02	0.32738E+00	0.10320E-02	0.47430E-02
0.22574E+04	0.30197E-02	0.32740E+00	0.98866E-03	0.45438E-02
0.22575E+04	0.28920E-02	0.32742E+00	0.94691E-03	0.43519E-02
0.22576E+04	0.27644E-02	0.32744E+00	0.90519E-03	0.41602E-02
0.22577E+04	0.26397E-02	0.32746E+00	0.86438E-03	0.39726E-02
0.22578E+04	0.25155E-02	0.32747E+00	0.82376E-03	0.37859E-02
0.22579E+04	0.23918E-02	0.32749E+00	0.78327E-03	0.35998E-02
0.22580E+04	0.22680E-02	0.32750E+00	0.74278E-03	0.34138E-02
0.22581E+04	0.21460E-02	0.32753E+00	0.70287E-03	0.32303E-02
0.22582E+04	0.20245E-02	0.32756E+00	0.66312E-03	0.30476E-02
0.22583E+04	0.19045E-02	0.32758E+00	0.62390E-03	0.28674E-02
0.22584E+04	0.17902E-02	0.32761E+00	0.58650E-03	0.26955E-02
0.22585E+04	0.16764E-02	0.32764E+00	0.54926E-03	0.25244E-02
0.22586E+04	0.15631E-02	0.32766E+00	0.51216E-03	0.23538E-02
0.22587E+04	0.14501E-02	0.32769E+00	0.47517E-03	0.21838E-02
0.22588E+04	0.13377E-02	0.32772E+00	0.43839E-03	0.20148E-02
0.22589E+04	0.12272E-02	0.32774E+00	0.40221E-03	0.18485E-02
0.22590E+04	0.11173E-02	0.32777E+00	0.36623E-03	0.16832E-02
0.22591E+04	0.10075E-02	0.32780E+00	0.33025E-03	0.15178E-02
0.22592E+04	0.89871E-03	0.32783E+00	0.29463E-03	0.13541E-02
0.22593E+04	0.79369E-03	0.32786E+00	0.26022E-03	0.11959E-02
0.22594E+04	0.68932E-03	0.32789E+00	0.22603E-03	0.10388E-02
0.22595E+04	0.58525E-03	0.32792E+00	0.19192E-03	0.88204E-03
0.22596E+04	0.48164E-03	0.32796E+00	0.15796E-03	0.72596E-03
0.22597E+04	0.37870E-03	0.32799E+00	0.12421E-03	0.57087E-03
0.22598E+04	0.27667E-03	0.32803E+00	0.90755E-04	0.41710E-03
0.22599E+04	0.17704E-03	0.32806E+00	0.58080E-04	0.26693E-03

0.22600E+04	0.79982E-04	0.32810E+00	0.26242E-04	0.12061E-03
0.22601E+04	0.00000E+00	0.32812E+00	0.00000E+00	0.00000E+00
Channel 16				
Wavenumber	HIRS Filter Transmittance	Optical Element Transmittance	Product of the HIRS Filter and Optical Element Transmittances	Normalized Value of Column 4
0.22188E+04	0.00000E+00	0.30884E+00	0.00000E+00	0.00000E+00
0.22189E+04	0.12079E-04	0.30890E+00	0.37313E-05	0.14688E-04
0.22190E+04	0.58625E-04	0.30896E+00	0.18112E-04	0.71299E-04
0.22191E+04	0.10663E-03	0.30901E+00	0.32949E-04	0.12970E-03
0.22192E+04	0.16236E-03	0.30907E+00	0.50180E-04	0.19753E-03
0.22193E+04	0.22191E-03	0.30913E+00	0.68598E-04	0.27004E-03
0.22194E+04	0.28403E-03	0.30918E+00	0.87817E-04	0.34569E-03
0.22195E+04	0.35402E-03	0.30924E+00	0.10948E-03	0.43096E-03
0.22196E+04	0.42468E-03	0.30930E+00	0.13135E-03	0.51707E-03
0.22197E+04	0.49609E-03	0.30936E+00	0.15347E-03	0.60413E-03
0.22198E+04	0.56833E-03	0.30942E+00	0.17585E-03	0.69224E-03
0.22199E+04	0.65073E-03	0.30948E+00	0.20139E-03	0.79275E-03
0.22200E+04	0.73641E-03	0.30954E+00	0.22794E-03	0.89730E-03
0.22201E+04	0.83042E-03	0.30959E+00	0.25709E-03	0.10120E-02
0.22202E+04	0.92532E-03	0.30965E+00	0.28653E-03	0.11279E-02
0.22203E+04	0.10223E-02	0.30971E+00	0.31661E-03	0.12463E-02
0.22204E+04	0.11210E-02	0.30976E+00	0.34723E-03	0.13669E-02
0.22205E+04	0.12213E-02	0.30982E+00	0.37837E-03	0.14895E-02
0.22206E+04	0.13226E-02	0.30988E+00	0.40986E-03	0.16134E-02
0.22207E+04	0.14255E-02	0.30994E+00	0.44181E-03	0.17392E-02
0.22208E+04	0.15288E-02	0.31000E+00	0.47393E-03	0.18656E-02
0.22209E+04	0.16322E-02	0.31006E+00	0.50607E-03	0.19921E-02
0.22210E+04	0.17396E-02	0.31012E+00	0.53949E-03	0.21237E-02
0.22211E+04	0.18495E-02	0.31018E+00	0.57370E-03	0.22583E-02
0.22212E+04	0.19627E-02	0.31025E+00	0.60890E-03	0.23969E-02
0.22213E+04	0.20791E-02	0.31031E+00	0.64517E-03	0.25397E-02
0.22214E+04	0.21959E-02	0.31037E+00	0.68155E-03	0.26829E-02
0.22215E+04	0.23153E-02	0.31044E+00	0.71875E-03	0.28293E-02
0.22216E+04	0.24347E-02	0.31050E+00	0.75598E-03	0.29759E-02
0.22217E+04	0.25546E-02	0.31057E+00	0.79339E-03	0.31232E-02
0.22218E+04	0.26758E-02	0.31064E+00	0.83119E-03	0.32720E-02
0.22219E+04	0.27984E-02	0.31070E+00	0.86947E-03	0.34226E-02
0.22220E+04	0.29274E-02	0.31077E+00	0.90974E-03	0.35812E-02
0.22221E+04	0.30598E-02	0.31084E+00	0.95112E-03	0.37441E-02
0.22222E+04	0.32052E-02	0.31091E+00	0.99653E-03	0.39228E-02
0.22223E+04	0.33511E-02	0.31099E+00	0.10422E-02	0.41024E-02

0.22224E+04	0.34985E-02	0.31106E+00	0.10882E-02	0.42838E-02
0.22225E+04	0.36465E-02	0.31113E+00	0.11345E-02	0.44661E-02
0.22226E+04	0.37978E-02	0.31120E+00	0.11819E-02	0.46525E-02
0.22227E+04	0.39499E-02	0.31128E+00	0.12295E-02	0.48400E-02
0.22228E+04	0.41038E-02	0.31135E+00	0.12777E-02	0.50297E-02
0.22229E+04	0.42579E-02	0.31143E+00	0.13260E-02	0.52199E-02
0.22230E+04	0.44156E-02	0.31150E+00	0.13755E-02	0.54146E-02
0.22231E+04	0.45744E-02	0.31158E+00	0.14253E-02	0.56106E-02
0.22232E+04	0.47334E-02	0.31165E+00	0.14752E-02	0.58071E-02
0.22233E+04	0.48930E-02	0.31173E+00	0.15253E-02	0.60043E-02
0.22234E+04	0.50536E-02	0.31181E+00	0.15758E-02	0.62029E-02
0.22235E+04	0.52204E-02	0.31188E+00	0.16281E-02	0.64092E-02
0.22236E+04	0.53909E-02	0.31196E+00	0.16817E-02	0.66201E-02
0.22237E+04	0.55634E-02	0.31203E+00	0.17360E-02	0.68336E-02
0.22238E+04	0.57365E-02	0.31211E+00	0.17904E-02	0.70479E-02
0.22239E+04	0.59158E-02	0.31218E+00	0.18468E-02	0.72699E-02
0.22240E+04	0.60978E-02	0.31226E+00	0.19041E-02	0.74954E-02
0.22241E+04	0.62814E-02	0.31234E+00	0.19619E-02	0.77232E-02
0.22242E+04	0.64653E-02	0.31243E+00	0.20199E-02	0.79515E-02
0.22243E+04	0.66521E-02	0.31251E+00	0.20789E-02	0.81834E-02
0.22244E+04	0.68470E-02	0.31260E+00	0.21403E-02	0.84254E-02
0.22245E+04	0.70457E-02	0.31268E+00	0.22030E-02	0.86722E-02
0.22246E+04	0.72478E-02	0.31276E+00	0.22668E-02	0.89232E-02
0.22247E+04	0.74509E-02	0.31284E+00	0.23309E-02	0.91756E-02
0.22248E+04	0.76683E-02	0.31292E+00	0.23996E-02	0.94458E-02
0.22249E+04	0.78904E-02	0.31300E+00	0.24697E-02	0.97219E-02
0.22250E+04	0.81218E-02	0.31308E+00	0.25428E-02	0.10009E-01
0.22251E+04	0.83538E-02	0.31315E+00	0.26160E-02	0.10298E-01
0.22252E+04	0.85948E-02	0.31322E+00	0.26920E-02	0.10597E-01
0.22253E+04	0.88487E-02	0.31329E+00	0.27722E-02	0.10913E-01
0.22254E+04	0.91062E-02	0.31336E+00	0.28535E-02	0.11233E-01
0.22255E+04	0.93655E-02	0.31343E+00	0.29354E-02	0.11555E-01
0.22256E+04	0.96272E-02	0.31349E+00	0.30180E-02	0.11880E-01
0.22257E+04	0.98984E-02	0.31355E+00	0.31037E-02	0.12218E-01
0.22258E+04	0.10191E-01	0.31361E+00	0.31960E-02	0.12581E-01
0.22259E+04	0.10484E-01	0.31368E+00	0.32887E-02	0.12946E-01
0.22260E+04	0.10788E-01	0.31374E+00	0.33845E-02	0.13323E-01
0.22261E+04	0.11111E-01	0.31380E+00	0.34867E-02	0.13725E-01
0.22262E+04	0.11470E-01	0.31386E+00	0.35999E-02	0.14171E-01
0.22263E+04	0.11867E-01	0.31392E+00	0.37255E-02	0.14665E-01
0.22264E+04	0.12293E-01	0.31399E+00	0.38600E-02	0.15195E-01
0.22265E+04	0.12738E-01	0.31405E+00	0.40005E-02	0.15748E-01
0.22266E+04	0.13186E-01	0.31410E+00	0.41417E-02	0.16304E-01

0.22267E+04	0.13633E-01	0.31416E+00	0.42829E-02	0.16859E-01
0.22268E+04	0.14095E-01	0.31422E+00	0.44288E-02	0.17434E-01
0.22269E+04	0.14560E-01	0.31427E+00	0.45757E-02	0.18012E-01
0.22270E+04	0.15037E-01	0.31433E+00	0.47265E-02	0.18606E-01
0.22271E+04	0.15568E-01	0.31438E+00	0.48944E-02	0.19267E-01
0.22272E+04	0.16154E-01	0.31444E+00	0.50795E-02	0.19995E-01
0.22273E+04	0.16770E-01	0.31448E+00	0.52737E-02	0.20760E-01
0.22274E+04	0.17403E-01	0.31452E+00	0.54736E-02	0.21547E-01
0.22275E+04	0.18058E-01	0.31456E+00	0.56803E-02	0.22361E-01
0.22276E+04	0.18735E-01	0.31461E+00	0.58943E-02	0.23203E-01
0.22277E+04	0.19439E-01	0.31465E+00	0.61163E-02	0.24077E-01
0.22278E+04	0.20178E-01	0.31469E+00	0.63497E-02	0.24996E-01
0.22279E+04	0.20943E-01	0.31473E+00	0.65915E-02	0.25947E-01
0.22280E+04	0.21740E-01	0.31478E+00	0.68432E-02	0.26938E-01
0.22281E+04	0.22538E-01	0.31482E+00	0.70956E-02	0.27931E-01
0.22282E+04	0.23351E-01	0.31487E+00	0.73526E-02	0.28943E-01
0.22283E+04	0.24168E-01	0.31492E+00	0.76110E-02	0.29961E-01
0.22284E+04	0.24988E-01	0.31497E+00	0.78705E-02	0.30982E-01
0.22285E+04	0.25814E-01	0.31502E+00	0.81319E-02	0.32011E-01
0.22286E+04	0.26640E-01	0.31508E+00	0.83937E-02	0.33042E-01
0.22287E+04	0.27492E-01	0.31513E+00	0.86636E-02	0.34104E-01
0.22288E+04	0.28421E-01	0.31519E+00	0.89578E-02	0.35262E-01
0.22289E+04	0.29420E-01	0.31525E+00	0.92744E-02	0.36508E-01
0.22290E+04	0.30455E-01	0.31530E+00	0.96026E-02	0.37800E-01
0.22291E+04	0.31518E-01	0.31536E+00	0.99397E-02	0.39127E-01
0.22292E+04	0.32645E-01	0.31543E+00	0.10297E-01	0.40535E-01
0.22293E+04	0.33866E-01	0.31549E+00	0.10684E-01	0.42059E-01
0.22294E+04	0.35212E-01	0.31555E+00	0.11111E-01	0.43739E-01
0.22295E+04	0.36670E-01	0.31561E+00	0.11574E-01	0.45559E-01
0.22296E+04	0.38214E-01	0.31568E+00	0.12063E-01	0.47487E-01
0.22297E+04	0.39804E-01	0.31575E+00	0.12568E-01	0.49473E-01
0.22298E+04	0.41421E-01	0.31581E+00	0.13081E-01	0.51494E-01
0.22299E+04	0.43062E-01	0.31588E+00	0.13603E-01	0.53546E-01
0.22300E+04	0.44774E-01	0.31595E+00	0.14146E-01	0.55686E-01
0.22301E+04	0.46577E-01	0.31599E+00	0.14718E-01	0.57937E-01
0.22302E+04	0.48492E-01	0.31603E+00	0.15325E-01	0.60328E-01
0.22303E+04	0.50533E-01	0.31608E+00	0.15972E-01	0.62875E-01
0.22304E+04	0.52667E-01	0.31612E+00	0.16649E-01	0.65540E-01
0.22305E+04	0.54909E-01	0.31617E+00	0.17360E-01	0.68339E-01
0.22306E+04	0.57242E-01	0.31621E+00	0.18100E-01	0.71252E-01
0.22307E+04	0.59663E-01	0.31625E+00	0.18868E-01	0.74275E-01
0.22308E+04	0.62170E-01	0.31630E+00	0.19664E-01	0.77407E-01
0.22309E+04	0.64801E-01	0.31634E+00	0.20499E-01	0.80694E-01

0.22310E+04	0.67583E-01	0.31638E+00	0.21382E-01	0.84169E-01
0.22311E+04	0.70544E-01	0.31642E+00	0.22321E-01	0.87868E-01
0.22312E+04	0.73650E-01	0.31646E+00	0.23307E-01	0.91748E-01
0.22313E+04	0.76890E-01	0.31650E+00	0.24336E-01	0.95796E-01
0.22314E+04	0.80244E-01	0.31653E+00	0.25400E-01	0.99987E-01
0.22315E+04	0.83732E-01	0.31657E+00	0.26507E-01	0.10435E+00
0.22316E+04	0.87377E-01	0.31661E+00	0.27664E-01	0.10890E+00
0.22317E+04	0.91192E-01	0.31664E+00	0.28875E-01	0.11367E+00
0.22318E+04	0.95147E-01	0.31668E+00	0.30131E-01	0.11861E+00
0.22319E+04	0.99251E-01	0.31671E+00	0.31434E-01	0.12374E+00
0.22320E+04	0.10350E+00	0.31674E+00	0.32782E-01	0.12904E+00
0.22321E+04	0.10789E+00	0.31676E+00	0.34176E-01	0.13453E+00
0.22322E+04	0.11244E+00	0.31677E+00	0.35618E-01	0.14021E+00
0.22323E+04	0.11718E+00	0.31679E+00	0.37122E-01	0.14613E+00
0.22324E+04	0.12212E+00	0.31680E+00	0.38688E-01	0.15230E+00
0.22325E+04	0.12726E+00	0.31682E+00	0.40317E-01	0.15871E+00
0.22326E+04	0.13257E+00	0.31683E+00	0.42001E-01	0.16534E+00
0.22327E+04	0.13807E+00	0.31684E+00	0.43746E-01	0.17220E+00
0.22328E+04	0.14378E+00	0.31686E+00	0.45559E-01	0.17934E+00
0.22329E+04	0.14974E+00	0.31687E+00	0.47448E-01	0.18678E+00
0.22330E+04	0.15591E+00	0.31688E+00	0.49405E-01	0.19448E+00
0.22331E+04	0.16231E+00	0.31690E+00	0.51436E-01	0.20247E+00
0.22332E+04	0.16891E+00	0.31691E+00	0.53531E-01	0.21072E+00
0.22333E+04	0.17571E+00	0.31692E+00	0.55687E-01	0.21921E+00
0.22334E+04	0.18266E+00	0.31694E+00	0.57892E-01	0.22789E+00
0.22335E+04	0.18975E+00	0.31695E+00	0.60141E-01	0.23674E+00
0.22336E+04	0.19700E+00	0.31697E+00	0.62442E-01	0.24580E+00
0.22337E+04	0.20444E+00	0.31698E+00	0.64805E-01	0.25510E+00
0.22338E+04	0.21211E+00	0.31700E+00	0.67240E-01	0.26469E+00
0.22339E+04	0.22003E+00	0.31702E+00	0.69752E-01	0.27458E+00
0.22340E+04	0.22817E+00	0.31704E+00	0.72338E-01	0.28476E+00
0.22341E+04	0.23652E+00	0.31709E+00	0.74997E-01	0.29522E+00
0.22342E+04	0.24502E+00	0.31714E+00	0.77707E-01	0.30589E+00
0.22343E+04	0.25369E+00	0.31719E+00	0.80467E-01	0.31676E+00
0.22344E+04	0.26251E+00	0.31724E+00	0.83279E-01	0.32783E+00
0.22345E+04	0.27148E+00	0.31730E+00	0.86140E-01	0.33909E+00
0.22346E+04	0.28059E+00	0.31735E+00	0.89046E-01	0.35053E+00
0.22347E+04	0.28982E+00	0.31740E+00	0.91991E-01	0.36212E+00
0.22348E+04	0.29917E+00	0.31746E+00	0.94974E-01	0.37386E+00
0.22349E+04	0.30862E+00	0.31751E+00	0.97991E-01	0.38574E+00
0.22350E+04	0.31817E+00	0.31757E+00	0.10104E+00	0.39775E+00
0.22351E+04	0.32780E+00	0.31763E+00	0.10412E+00	0.40987E+00
0.22352E+04	0.33748E+00	0.31770E+00	0.10722E+00	0.42206E+00

0.22353E+04	0.34719E+00	0.31776E+00	0.11032E+00	0.43429E+00
0.22354E+04	0.35693E+00	0.31782E+00	0.11344E+00	0.44656E+00
0.22355E+04	0.36671E+00	0.31789E+00	0.11657E+00	0.45888E+00
0.22356E+04	0.37652E+00	0.31795E+00	0.11972E+00	0.47126E+00
0.22357E+04	0.38636E+00	0.31801E+00	0.12287E+00	0.48366E+00
0.22358E+04	0.39620E+00	0.31807E+00	0.12602E+00	0.49608E+00
0.22359E+04	0.40602E+00	0.31814E+00	0.12917E+00	0.50847E+00
0.22360E+04	0.41579E+00	0.31819E+00	0.13230E+00	0.52081E+00
0.22361E+04	0.42552E+00	0.31823E+00	0.13541E+00	0.53305E+00
0.22362E+04	0.43521E+00	0.31827E+00	0.13851E+00	0.54526E+00
0.22363E+04	0.44485E+00	0.31830E+00	0.14160E+00	0.55739E+00
0.22364E+04	0.45441E+00	0.31834E+00	0.14466E+00	0.56944E+00
0.22365E+04	0.46390E+00	0.31838E+00	0.14769E+00	0.58139E+00
0.22366E+04	0.47331E+00	0.31841E+00	0.15070E+00	0.59324E+00
0.22367E+04	0.48265E+00	0.31844E+00	0.15370E+00	0.60502E+00
0.22368E+04	0.49194E+00	0.31846E+00	0.15667E+00	0.61671E+00
0.22369E+04	0.50114E+00	0.31849E+00	0.15961E+00	0.62830E+00
0.22370E+04	0.51027E+00	0.31851E+00	0.16253E+00	0.63978E+00
0.22371E+04	0.51927E+00	0.31854E+00	0.16541E+00	0.65112E+00
0.22372E+04	0.52814E+00	0.31856E+00	0.16824E+00	0.66229E+00
0.22373E+04	0.53685E+00	0.31858E+00	0.17103E+00	0.67326E+00
0.22374E+04	0.54537E+00	0.31861E+00	0.17376E+00	0.68400E+00
0.22375E+04	0.55371E+00	0.31863E+00	0.17643E+00	0.69450E+00
0.22376E+04	0.56186E+00	0.31865E+00	0.17904E+00	0.70477E+00
0.22377E+04	0.56985E+00	0.31867E+00	0.18160E+00	0.71485E+00
0.22378E+04	0.57770E+00	0.31870E+00	0.18411E+00	0.72474E+00
0.22379E+04	0.58542E+00	0.31872E+00	0.18658E+00	0.73448E+00
0.22380E+04	0.59299E+00	0.31874E+00	0.18901E+00	0.74403E+00
0.22381E+04	0.60039E+00	0.31876E+00	0.19138E+00	0.75336E+00
0.22382E+04	0.60755E+00	0.31878E+00	0.19367E+00	0.76239E+00
0.22383E+04	0.61448E+00	0.31879E+00	0.19589E+00	0.77112E+00
0.22384E+04	0.62117E+00	0.31881E+00	0.19804E+00	0.77956E+00
0.22385E+04	0.62766E+00	0.31883E+00	0.20011E+00	0.78774E+00
0.22386E+04	0.63392E+00	0.31885E+00	0.20213E+00	0.79567E+00
0.22387E+04	0.63998E+00	0.31887E+00	0.20407E+00	0.80332E+00
0.22388E+04	0.64581E+00	0.31890E+00	0.20595E+00	0.81070E+00
0.22389E+04	0.65144E+00	0.31892E+00	0.20776E+00	0.81783E+00
0.22390E+04	0.65685E+00	0.31894E+00	0.20950E+00	0.82468E+00
0.22391E+04	0.66203E+00	0.31897E+00	0.21117E+00	0.83126E+00
0.22392E+04	0.66699E+00	0.31900E+00	0.21277E+00	0.83757E+00
0.22393E+04	0.67174E+00	0.31903E+00	0.21431E+00	0.84361E+00
0.22394E+04	0.67623E+00	0.31906E+00	0.21576E+00	0.84934E+00
0.22395E+04	0.68049E+00	0.31909E+00	0.21714E+00	0.85476E+00

0.22396E+04	0.68450E+00	0.31913E+00	0.21844E+00	0.85989E+00
0.22397E+04	0.68829E+00	0.31916E+00	0.21968E+00	0.86475E+00
0.22398E+04	0.69186E+00	0.31920E+00	0.22084E+00	0.86934E+00
0.22399E+04	0.69521E+00	0.31924E+00	0.22194E+00	0.87366E+00
0.22400E+04	0.69835E+00	0.31928E+00	0.22297E+00	0.87770E+00
0.22401E+04	0.70126E+00	0.31934E+00	0.22394E+00	0.88154E+00
0.22402E+04	0.70395E+00	0.31941E+00	0.22485E+00	0.88511E+00
0.22403E+04	0.70644E+00	0.31948E+00	0.22569E+00	0.88843E+00
0.22404E+04	0.70874E+00	0.31954E+00	0.22647E+00	0.89151E+00
0.22405E+04	0.71090E+00	0.31961E+00	0.22721E+00	0.89441E+00
0.22406E+04	0.71293E+00	0.31968E+00	0.22791E+00	0.89715E+00
0.22407E+04	0.71484E+00	0.31974E+00	0.22857E+00	0.89975E+00
0.22408E+04	0.71662E+00	0.31981E+00	0.22918E+00	0.90217E+00
0.22409E+04	0.71825E+00	0.31988E+00	0.22975E+00	0.90441E+00
0.22410E+04	0.71972E+00	0.31994E+00	0.23027E+00	0.90645E+00
0.22411E+04	0.72105E+00	0.32001E+00	0.23074E+00	0.90830E+00
0.22412E+04	0.72225E+00	0.32007E+00	0.23117E+00	0.90999E+00
0.22413E+04	0.72335E+00	0.32013E+00	0.23157E+00	0.91156E+00
0.22414E+04	0.72437E+00	0.32020E+00	0.23194E+00	0.91303E+00
0.22415E+04	0.72535E+00	0.32026E+00	0.23230E+00	0.91444E+00
0.22416E+04	0.72625E+00	0.32032E+00	0.23263E+00	0.91574E+00
0.22417E+04	0.72707E+00	0.32037E+00	0.23293E+00	0.91694E+00
0.22418E+04	0.72782E+00	0.32043E+00	0.23321E+00	0.91804E+00
0.22419E+04	0.72848E+00	0.32049E+00	0.23347E+00	0.91904E+00
0.22420E+04	0.72906E+00	0.32054E+00	0.23370E+00	0.91994E+00
0.22421E+04	0.72956E+00	0.32058E+00	0.23388E+00	0.92066E+00
0.22422E+04	0.73000E+00	0.32061E+00	0.23405E+00	0.92132E+00
0.22423E+04	0.73041E+00	0.32065E+00	0.23421E+00	0.92195E+00
0.22424E+04	0.73082E+00	0.32069E+00	0.23436E+00	0.92257E+00
0.22425E+04	0.73120E+00	0.32072E+00	0.23451E+00	0.92315E+00
0.22426E+04	0.73156E+00	0.32075E+00	0.23465E+00	0.92369E+00
0.22427E+04	0.73192E+00	0.32078E+00	0.23479E+00	0.92423E+00
0.22428E+04	0.73227E+00	0.32081E+00	0.23492E+00	0.92476E+00
0.22429E+04	0.73262E+00	0.32084E+00	0.23506E+00	0.92529E+00
0.22430E+04	0.73297E+00	0.32087E+00	0.23519E+00	0.92581E+00
0.22431E+04	0.73330E+00	0.32090E+00	0.23532E+00	0.92631E+00
0.22432E+04	0.73363E+00	0.32093E+00	0.23544E+00	0.92680E+00
0.22433E+04	0.73395E+00	0.32095E+00	0.23556E+00	0.92729E+00
0.22434E+04	0.73429E+00	0.32098E+00	0.23569E+00	0.92779E+00
0.22435E+04	0.73466E+00	0.32100E+00	0.23583E+00	0.92834E+00
0.22436E+04	0.73508E+00	0.32103E+00	0.23598E+00	0.92894E+00
0.22437E+04	0.73554E+00	0.32106E+00	0.23615E+00	0.92960E+00
0.22438E+04	0.73603E+00	0.32109E+00	0.23633E+00	0.93030E+00

0.22439E+04	0.73655E+00	0.32111E+00	0.23651E+00	0.93103E+00
0.22440E+04	0.73710E+00	0.32114E+00	0.23671E+00	0.93181E+00
0.22441E+04	0.73769E+00	0.32117E+00	0.23692E+00	0.93265E+00
0.22442E+04	0.73830E+00	0.32120E+00	0.23714E+00	0.93351E+00
0.22443E+04	0.73893E+00	0.32123E+00	0.23737E+00	0.93439E+00
0.22444E+04	0.73957E+00	0.32126E+00	0.23759E+00	0.93528E+00
0.22445E+04	0.74023E+00	0.32129E+00	0.23783E+00	0.93621E+00
0.22446E+04	0.74095E+00	0.32133E+00	0.23809E+00	0.93722E+00
0.22447E+04	0.74174E+00	0.32136E+00	0.23837E+00	0.93833E+00
0.22448E+04	0.74259E+00	0.32140E+00	0.23867E+00	0.93950E+00
0.22449E+04	0.74349E+00	0.32143E+00	0.23898E+00	0.94074E+00
0.22450E+04	0.74443E+00	0.32146E+00	0.23931E+00	0.94203E+00
0.22451E+04	0.74540E+00	0.32149E+00	0.23964E+00	0.94334E+00
0.22452E+04	0.74639E+00	0.32152E+00	0.23998E+00	0.94468E+00
0.22453E+04	0.74743E+00	0.32155E+00	0.24033E+00	0.94606E+00
0.22454E+04	0.74852E+00	0.32157E+00	0.24070E+00	0.94752E+00
0.22455E+04	0.74965E+00	0.32160E+00	0.24109E+00	0.94904E+00
0.22456E+04	0.75081E+00	0.32163E+00	0.24148E+00	0.95059E+00
0.22457E+04	0.75199E+00	0.32166E+00	0.24188E+00	0.95216E+00
0.22458E+04	0.75321E+00	0.32169E+00	0.24230E+00	0.95380E+00
0.22459E+04	0.75448E+00	0.32172E+00	0.24273E+00	0.95550E+00
0.22460E+04	0.75576E+00	0.32175E+00	0.24316E+00	0.95721E+00
0.22461E+04	0.75704E+00	0.32179E+00	0.24361E+00	0.95897E+00
0.22462E+04	0.75834E+00	0.32184E+00	0.24406E+00	0.96076E+00
0.22463E+04	0.75965E+00	0.32189E+00	0.24452E+00	0.96255E+00
0.22464E+04	0.76092E+00	0.32193E+00	0.24497E+00	0.96431E+00
0.22465E+04	0.76215E+00	0.32198E+00	0.24540E+00	0.96600E+00
0.22466E+04	0.76335E+00	0.32202E+00	0.24582E+00	0.96765E+00
0.22467E+04	0.76452E+00	0.32207E+00	0.24623E+00	0.96926E+00
0.22468E+04	0.76567E+00	0.32211E+00	0.24663E+00	0.97085E+00
0.22469E+04	0.76679E+00	0.32215E+00	0.24702E+00	0.97240E+00
0.22470E+04	0.76791E+00	0.32220E+00	0.24742E+00	0.97396E+00
0.22471E+04	0.76905E+00	0.32224E+00	0.24782E+00	0.97552E+00
0.22472E+04	0.77020E+00	0.32228E+00	0.24822E+00	0.97710E+00
0.22473E+04	0.77135E+00	0.32232E+00	0.24862E+00	0.97868E+00
0.22474E+04	0.77248E+00	0.32236E+00	0.24902E+00	0.98024E+00
0.22475E+04	0.77357E+00	0.32240E+00	0.24940E+00	0.98176E+00
0.22476E+04	0.77462E+00	0.32244E+00	0.24977E+00	0.98320E+00
0.22477E+04	0.77560E+00	0.32248E+00	0.25012E+00	0.98457E+00
0.22478E+04	0.77654E+00	0.32252E+00	0.25045E+00	0.98588E+00
0.22479E+04	0.77744E+00	0.32256E+00	0.25077E+00	0.98714E+00
0.22480E+04	0.77833E+00	0.32259E+00	0.25109E+00	0.98839E+00
0.22481E+04	0.77922E+00	0.32264E+00	0.25141E+00	0.98966E+00

0.22482E+04	0.78009E+00	0.32269E+00	0.25173E+00	0.99092E+00
0.22483E+04	0.78096E+00	0.32273E+00	0.25204E+00	0.99216E+00
0.22484E+04	0.78178E+00	0.32278E+00	0.25234E+00	0.99334E+00
0.22485E+04	0.78253E+00	0.32283E+00	0.25262E+00	0.99444E+00
0.22486E+04	0.78319E+00	0.32288E+00	0.25287E+00	0.99544E+00
0.22487E+04	0.78377E+00	0.32293E+00	0.25310E+00	0.99632E+00
0.22488E+04	0.78425E+00	0.32298E+00	0.25329E+00	0.99708E+00
0.22489E+04	0.78463E+00	0.32303E+00	0.25345E+00	0.99772E+00
0.22490E+04	0.78491E+00	0.32307E+00	0.25358E+00	0.99823E+00
0.22491E+04	0.78511E+00	0.32313E+00	0.25369E+00	0.99866E+00
0.22492E+04	0.78525E+00	0.32318E+00	0.25378E+00	0.99900E+00
0.22493E+04	0.78532E+00	0.32324E+00	0.25385E+00	0.99927E+00
0.22494E+04	0.78533E+00	0.32330E+00	0.25389E+00	0.99945E+00
0.22495E+04	0.78531E+00	0.32335E+00	0.25393E+00	0.99959E+00
0.22496E+04	0.78528E+00	0.32341E+00	0.25397E+00	0.99974E+00
0.22497E+04	0.78524E+00	0.32347E+00	0.25401E+00	0.99989E+00
0.22498E+04	0.78516E+00	0.32354E+00	0.25403E+00	0.99998E+00
0.22499E+04	0.78503E+00	0.32360E+00	0.25403E+00	0.10000E+01
0.22500E+04	0.78482E+00	0.32366E+00	0.25401E+00	0.99992E+00
0.22501E+04	0.78451E+00	0.32373E+00	0.25397E+00	0.99976E+00
0.22502E+04	0.78412E+00	0.32381E+00	0.25391E+00	0.99949E+00
0.22503E+04	0.78362E+00	0.32389E+00	0.25381E+00	0.99910E+00
0.22504E+04	0.78303E+00	0.32397E+00	0.25367E+00	0.99858E+00
0.22505E+04	0.78233E+00	0.32404E+00	0.25351E+00	0.99793E+00
0.22506E+04	0.78154E+00	0.32412E+00	0.25332E+00	0.99717E+00
0.22507E+04	0.78065E+00	0.32421E+00	0.25309E+00	0.99628E+00
0.22508E+04	0.77968E+00	0.32429E+00	0.25284E+00	0.99530E+00
0.22509E+04	0.77866E+00	0.32437E+00	0.25257E+00	0.99424E+00
0.22510E+04	0.77756E+00	0.32445E+00	0.25228E+00	0.99309E+00
0.22511E+04	0.77636E+00	0.32453E+00	0.25196E+00	0.99182E+00
0.22512E+04	0.77504E+00	0.32462E+00	0.25159E+00	0.99039E+00
0.22513E+04	0.77360E+00	0.32470E+00	0.25119E+00	0.98879E+00
0.22514E+04	0.77202E+00	0.32478E+00	0.25074E+00	0.98704E+00
0.22515E+04	0.77032E+00	0.32487E+00	0.25025E+00	0.98511E+00
0.22516E+04	0.76849E+00	0.32495E+00	0.24972E+00	0.98302E+00
0.22517E+04	0.76649E+00	0.32504E+00	0.24914E+00	0.98073E+00
0.22518E+04	0.76435E+00	0.32512E+00	0.24851E+00	0.97824E+00
0.22519E+04	0.76207E+00	0.32520E+00	0.24783E+00	0.97557E+00
0.22520E+04	0.75966E+00	0.32529E+00	0.24711E+00	0.97274E+00
0.22521E+04	0.75713E+00	0.32535E+00	0.24633E+00	0.96968E+00
0.22522E+04	0.75446E+00	0.32541E+00	0.24551E+00	0.96645E+00
0.22523E+04	0.75164E+00	0.32547E+00	0.24464E+00	0.96302E+00
0.22524E+04	0.74864E+00	0.32554E+00	0.24371E+00	0.95936E+00

0.22525E+04	0.74544E+00	0.32560E+00	0.24272E+00	0.95544E+00
0.22526E+04	0.74204E+00	0.32566E+00	0.24165E+00	0.95126E+00
0.22527E+04	0.73844E+00	0.32572E+00	0.24053E+00	0.94682E+00
0.22528E+04	0.73467E+00	0.32578E+00	0.23934E+00	0.94216E+00
0.22529E+04	0.73070E+00	0.32584E+00	0.23809E+00	0.93725E+00
0.22530E+04	0.72655E+00	0.32590E+00	0.23678E+00	0.93210E+00
0.22531E+04	0.72221E+00	0.32596E+00	0.23541E+00	0.92670E+00
0.22532E+04	0.71771E+00	0.32602E+00	0.23399E+00	0.92110E+00
0.22533E+04	0.71306E+00	0.32608E+00	0.23252E+00	0.91529E+00
0.22534E+04	0.70822E+00	0.32614E+00	0.23098E+00	0.90926E+00
0.22535E+04	0.70322E+00	0.32620E+00	0.22939E+00	0.90300E+00
0.22536E+04	0.69804E+00	0.32627E+00	0.22775E+00	0.89652E+00
0.22537E+04	0.69270E+00	0.32633E+00	0.22605E+00	0.88982E+00
0.22538E+04	0.68716E+00	0.32639E+00	0.22428E+00	0.88288E+00
0.22539E+04	0.68144E+00	0.32645E+00	0.22245E+00	0.87569E+00
0.22540E+04	0.67554E+00	0.32650E+00	0.22057E+00	0.86826E+00
0.22541E+04	0.66946E+00	0.32653E+00	0.21860E+00	0.86050E+00
0.22542E+04	0.66321E+00	0.32655E+00	0.21657E+00	0.85254E+00
0.22543E+04	0.65681E+00	0.32658E+00	0.21450E+00	0.84437E+00
0.22544E+04	0.65024E+00	0.32660E+00	0.21237E+00	0.83599E+00
0.22545E+04	0.64351E+00	0.32663E+00	0.21019E+00	0.82740E+00
0.22546E+04	0.63664E+00	0.32665E+00	0.20796E+00	0.81863E+00
0.22547E+04	0.62964E+00	0.32667E+00	0.20569E+00	0.80968E+00
0.22548E+04	0.62252E+00	0.32670E+00	0.20338E+00	0.80059E+00
0.22549E+04	0.61529E+00	0.32672E+00	0.20103E+00	0.79135E+00
0.22550E+04	0.60795E+00	0.32675E+00	0.19865E+00	0.78197E+00
0.22551E+04	0.60050E+00	0.32677E+00	0.19623E+00	0.77244E+00
0.22552E+04	0.59293E+00	0.32680E+00	0.19377E+00	0.76277E+00
0.22553E+04	0.58524E+00	0.32682E+00	0.19127E+00	0.75293E+00
0.22554E+04	0.57743E+00	0.32685E+00	0.18873E+00	0.74294E+00
0.22555E+04	0.56950E+00	0.32688E+00	0.18616E+00	0.73280E+00
0.22556E+04	0.56147E+00	0.32690E+00	0.18354E+00	0.72251E+00
0.22557E+04	0.55331E+00	0.32692E+00	0.18089E+00	0.71205E+00
0.22558E+04	0.54503E+00	0.32694E+00	0.17819E+00	0.70144E+00
0.22559E+04	0.53664E+00	0.32696E+00	0.17546E+00	0.69069E+00
0.22560E+04	0.52814E+00	0.32698E+00	0.17269E+00	0.67979E+00
0.22561E+04	0.51955E+00	0.32701E+00	0.16990E+00	0.66880E+00
0.22562E+04	0.51087E+00	0.32705E+00	0.16708E+00	0.65771E+00
0.22563E+04	0.50213E+00	0.32709E+00	0.16424E+00	0.64653E+00
0.22564E+04	0.49334E+00	0.32713E+00	0.16138E+00	0.63528E+00
0.22565E+04	0.48451E+00	0.32717E+00	0.15851E+00	0.62399E+00
0.22566E+04	0.47565E+00	0.32719E+00	0.15563E+00	0.61264E+00
0.22567E+04	0.46677E+00	0.32722E+00	0.15274E+00	0.60125E+00

0.22568E+04	0.45786E+00	0.32725E+00	0.14984E+00	0.58983E+00
0.22569E+04	0.44892E+00	0.32728E+00	0.14693E+00	0.57837E+00
0.22570E+04	0.43997E+00	0.32731E+00	0.14401E+00	0.56689E+00
0.22571E+04	0.43102E+00	0.32733E+00	0.14109E+00	0.55539E+00
0.22572E+04	0.42204E+00	0.32736E+00	0.13816E+00	0.54385E+00
0.22573E+04	0.41299E+00	0.32738E+00	0.13520E+00	0.53222E+00
0.22574E+04	0.40390E+00	0.32740E+00	0.13224E+00	0.52054E+00
0.22575E+04	0.39478E+00	0.32742E+00	0.12926E+00	0.50883E+00
0.22576E+04	0.38567E+00	0.32744E+00	0.12628E+00	0.49712E+00
0.22577E+04	0.37660E+00	0.32746E+00	0.12332E+00	0.48544E+00
0.22578E+04	0.36758E+00	0.32747E+00	0.12037E+00	0.47384E+00
0.22579E+04	0.35861E+00	0.32749E+00	0.11744E+00	0.46230E+00
0.22580E+04	0.34967E+00	0.32750E+00	0.11452E+00	0.45081E+00
0.22581E+04	0.34078E+00	0.32753E+00	0.11162E+00	0.43938E+00
0.22582E+04	0.33196E+00	0.32756E+00	0.10874E+00	0.42804E+00
0.22583E+04	0.32322E+00	0.32758E+00	0.10588E+00	0.41680E+00
0.22584E+04	0.31456E+00	0.32761E+00	0.10305E+00	0.40566E+00
0.22585E+04	0.30597E+00	0.32764E+00	0.10025E+00	0.39462E+00
0.22586E+04	0.29748E+00	0.32766E+00	0.97475E-01	0.38371E+00
0.22587E+04	0.28913E+00	0.32769E+00	0.94745E-01	0.37296E+00
0.22588E+04	0.28093E+00	0.32772E+00	0.92066E-01	0.36242E+00
0.22589E+04	0.27288E+00	0.32774E+00	0.89434E-01	0.35206E+00
0.22590E+04	0.26496E+00	0.32777E+00	0.86845E-01	0.34186E+00
0.22591E+04	0.25714E+00	0.32780E+00	0.84290E-01	0.33181E+00
0.22592E+04	0.24942E+00	0.32783E+00	0.81767E-01	0.32187E+00
0.22593E+04	0.24179E+00	0.32786E+00	0.79273E-01	0.31206E+00
0.22594E+04	0.23428E+00	0.32789E+00	0.76818E-01	0.30239E+00
0.22595E+04	0.22690E+00	0.32792E+00	0.74404E-01	0.29289E+00
0.22596E+04	0.21962E+00	0.32796E+00	0.72027E-01	0.28353E+00
0.22597E+04	0.21245E+00	0.32799E+00	0.69681E-01	0.27430E+00
0.22598E+04	0.20540E+00	0.32803E+00	0.67377E-01	0.26523E+00
0.22599E+04	0.19851E+00	0.32806E+00	0.65123E-01	0.25635E+00
0.22600E+04	0.19183E+00	0.32810E+00	0.62938E-01	0.24775E+00
0.22601E+04	0.18536E+00	0.32812E+00	0.60820E-01	0.23942E+00
0.22602E+04	0.17910E+00	0.32814E+00	0.58768E-01	0.23134E+00
0.22603E+04	0.17300E+00	0.32816E+00	0.56773E-01	0.22348E+00
0.22604E+04	0.16707E+00	0.32819E+00	0.54829E-01	0.21583E+00
0.22605E+04	0.16128E+00	0.32821E+00	0.52933E-01	0.20837E+00
0.22606E+04	0.15565E+00	0.32823E+00	0.51091E-01	0.20112E+00
0.22607E+04	0.15019E+00	0.32826E+00	0.49302E-01	0.19408E+00
0.22608E+04	0.14489E+00	0.32828E+00	0.47564E-01	0.18723E+00
0.22609E+04	0.13972E+00	0.32830E+00	0.45872E-01	0.18058E+00
0.22610E+04	0.13471E+00	0.32833E+00	0.44228E-01	0.17410E+00

0.22611E+04	0.12983E+00	0.32835E+00	0.42630E-01	0.16781E+00
0.22612E+04	0.12511E+00	0.32838E+00	0.41082E-01	0.16172E+00
0.22613E+04	0.12052E+00	0.32840E+00	0.39577E-01	0.15580E+00
0.22614E+04	0.11605E+00	0.32842E+00	0.38114E-01	0.15004E+00
0.22615E+04	0.11173E+00	0.32845E+00	0.36696E-01	0.14445E+00
0.22616E+04	0.10753E+00	0.32847E+00	0.35321E-01	0.13904E+00
0.22617E+04	0.10346E+00	0.32849E+00	0.33986E-01	0.13379E+00
0.22618E+04	0.99536E-01	0.32851E+00	0.32699E-01	0.12872E+00
0.22619E+04	0.95751E-01	0.32853E+00	0.31457E-01	0.12383E+00
0.22620E+04	0.92088E-01	0.32856E+00	0.30256E-01	0.11910E+00
0.22621E+04	0.88535E-01	0.32859E+00	0.29092E-01	0.11452E+00
0.22622E+04	0.85137E-01	0.32863E+00	0.27978E-01	0.11014E+00
0.22623E+04	0.81897E-01	0.32866E+00	0.26917E-01	0.10596E+00
0.22624E+04	0.78802E-01	0.32870E+00	0.25902E-01	0.10196E+00
0.22625E+04	0.75830E-01	0.32873E+00	0.24928E-01	0.98127E-01
0.22626E+04	0.72977E-01	0.32877E+00	0.23993E-01	0.94447E-01
0.22627E+04	0.70239E-01	0.32880E+00	0.23095E-01	0.90913E-01
0.22628E+04	0.67612E-01	0.32884E+00	0.22233E-01	0.87521E-01
0.22629E+04	0.65076E-01	0.32888E+00	0.21402E-01	0.84248E-01
0.22630E+04	0.62625E-01	0.32891E+00	0.20598E-01	0.81084E-01
0.22631E+04	0.60252E-01	0.32895E+00	0.19820E-01	0.78020E-01
0.22632E+04	0.57956E-01	0.32899E+00	0.19067E-01	0.75056E-01
0.22633E+04	0.55732E-01	0.32902E+00	0.18337E-01	0.72185E-01
0.22634E+04	0.53590E-01	0.32906E+00	0.17634E-01	0.69418E-01
0.22635E+04	0.51539E-01	0.32910E+00	0.16962E-01	0.66769E-01
0.22636E+04	0.49594E-01	0.32914E+00	0.16324E-01	0.64258E-01
0.22637E+04	0.47745E-01	0.32919E+00	0.15717E-01	0.61871E-01
0.22638E+04	0.45990E-01	0.32923E+00	0.15141E-01	0.59604E-01
0.22639E+04	0.44319E-01	0.32928E+00	0.14593E-01	0.57446E-01
0.22640E+04	0.42738E-01	0.32932E+00	0.14075E-01	0.55404E-01
0.22641E+04	0.41222E-01	0.32937E+00	0.13577E-01	0.53446E-01
0.22642E+04	0.39750E-01	0.32942E+00	0.13094E-01	0.51546E-01
0.22643E+04	0.38342E-01	0.32946E+00	0.12632E-01	0.49727E-01
0.22644E+04	0.37002E-01	0.32951E+00	0.12192E-01	0.47995E-01
0.22645E+04	0.35713E-01	0.32956E+00	0.11770E-01	0.46331E-01
0.22646E+04	0.34463E-01	0.32961E+00	0.11359E-01	0.44716E-01
0.22647E+04	0.33235E-01	0.32967E+00	0.10956E-01	0.43130E-01
0.22648E+04	0.32000E-01	0.32972E+00	0.10551E-01	0.41534E-01
0.22649E+04	0.30762E-01	0.32978E+00	0.10145E-01	0.39934E-01
0.22650E+04	0.29580E-01	0.32983E+00	0.97563E-02	0.38406E-01
0.22651E+04	0.28484E-01	0.32988E+00	0.93966E-02	0.36989E-01
0.22652E+04	0.27490E-01	0.32994E+00	0.90698E-02	0.35703E-01
0.22653E+04	0.26579E-01	0.33000E+00	0.87710E-02	0.34527E-01

0.22654E+04	0.25708E-01	0.33006E+00	0.84850E-02	0.33401E-01
0.22655E+04	0.24866E-01	0.33012E+00	0.82087E-02	0.32313E-01
0.22656E+04	0.24061E-01	0.33018E+00	0.79444E-02	0.31273E-01
0.22657E+04	0.23277E-01	0.33024E+00	0.76870E-02	0.30260E-01
0.22658E+04	0.22526E-01	0.33031E+00	0.74405E-02	0.29289E-01
0.22659E+04	0.21807E-01	0.33037E+00	0.72043E-02	0.28360E-01
0.22660E+04	0.21084E-01	0.33043E+00	0.69669E-02	0.27425E-01
0.22661E+04	0.20358E-01	0.33050E+00	0.67281E-02	0.26485E-01
0.22662E+04	0.19637E-01	0.33056E+00	0.64911E-02	0.25552E-01
0.22663E+04	0.18932E-01	0.33062E+00	0.62594E-02	0.24640E-01
0.22664E+04	0.18258E-01	0.33069E+00	0.60378E-02	0.23768E-01
0.22665E+04	0.17596E-01	0.33075E+00	0.58199E-02	0.22910E-01
0.22666E+04	0.16935E-01	0.33081E+00	0.56024E-02	0.22054E-01
0.22667E+04	0.16300E-01	0.33087E+00	0.53931E-02	0.21230E-01
0.22668E+04	0.15710E-01	0.33092E+00	0.51988E-02	0.20465E-01
0.22669E+04	0.15163E-01	0.33098E+00	0.50186E-02	0.19756E-01
0.22670E+04	0.14667E-01	0.33104E+00	0.48554E-02	0.19113E-01
0.22671E+04	0.14207E-01	0.33109E+00	0.47039E-02	0.18517E-01
0.22672E+04	0.13761E-01	0.33114E+00	0.45567E-02	0.17937E-01
0.22673E+04	0.13336E-01	0.33119E+00	0.44166E-02	0.17386E-01
0.22674E+04	0.12944E-01	0.33124E+00	0.42878E-02	0.16879E-01
0.22675E+04	0.12593E-01	0.33129E+00	0.41720E-02	0.16423E-01
0.22676E+04	0.12278E-01	0.33134E+00	0.40683E-02	0.16015E-01
0.22677E+04	0.11976E-01	0.33138E+00	0.39687E-02	0.15623E-01
0.22678E+04	0.11677E-01	0.33142E+00	0.38699E-02	0.15234E-01
0.22679E+04	0.11390E-01	0.33147E+00	0.37756E-02	0.14862E-01
0.22680E+04	0.11106E-01	0.33151E+00	0.36818E-02	0.14493E-01
0.22681E+04	0.10824E-01	0.33158E+00	0.35891E-02	0.14128E-01
0.22682E+04	0.10552E-01	0.33165E+00	0.34996E-02	0.13776E-01
0.22683E+04	0.10280E-01	0.33172E+00	0.34100E-02	0.13423E-01
0.22684E+04	0.10010E-01	0.33178E+00	0.33211E-02	0.13073E-01
0.22685E+04	0.97396E-02	0.33185E+00	0.32321E-02	0.12723E-01
0.22686E+04	0.94712E-02	0.33192E+00	0.31437E-02	0.12375E-01
0.22687E+04	0.92132E-02	0.33199E+00	0.30587E-02	0.12040E-01
0.22688E+04	0.89563E-02	0.33206E+00	0.29740E-02	0.11707E-01
0.22689E+04	0.87107E-02	0.33212E+00	0.28930E-02	0.11388E-01
0.22690E+04	0.84680E-02	0.33219E+00	0.28130E-02	0.11073E-01
0.22691E+04	0.82366E-02	0.33226E+00	0.27367E-02	0.10773E-01
0.22692E+04	0.80076E-02	0.33234E+00	0.26612E-02	0.10476E-01
0.22693E+04	0.77788E-02	0.33241E+00	0.25857E-02	0.10179E-01
0.22694E+04	0.75513E-02	0.33248E+00	0.25107E-02	0.98832E-02
0.22695E+04	0.73259E-02	0.33255E+00	0.24362E-02	0.95902E-02
0.22696E+04	0.71021E-02	0.33263E+00	0.23624E-02	0.92994E-02

0.22697E+04	0.68793E-02	0.33271E+00	0.22888E-02	0.90097E-02
0.22698E+04	0.66594E-02	0.33278E+00	0.22161E-02	0.87237E-02
0.22699E+04	0.64403E-02	0.33286E+00	0.21437E-02	0.84387E-02
0.22700E+04	0.62232E-02	0.33300E+00	0.20723E-02	0.81577E-02
0.22701E+04	0.60141E-02	0.33338E+00	0.20049E-02	0.78924E-02
0.22702E+04	0.58058E-02	0.33375E+00	0.19377E-02	0.76277E-02
0.22703E+04	0.56003E-02	0.33413E+00	0.18712E-02	0.73661E-02
0.22704E+04	0.54058E-02	0.33451E+00	0.18083E-02	0.71182E-02
0.22705E+04	0.52112E-02	0.33482E+00	0.17448E-02	0.68685E-02
0.22706E+04	0.50237E-02	0.33487E+00	0.16823E-02	0.66223E-02
0.22707E+04	0.48374E-02	0.33491E+00	0.16201E-02	0.63775E-02
0.22708E+04	0.46538E-02	0.33496E+00	0.15588E-02	0.61364E-02
0.22709E+04	0.44848E-02	0.33501E+00	0.15025E-02	0.59144E-02
0.22710E+04	0.43167E-02	0.33505E+00	0.14463E-02	0.56934E-02
0.22711E+04	0.41531E-02	0.33510E+00	0.13917E-02	0.54783E-02
0.22712E+04	0.39895E-02	0.33514E+00	0.13371E-02	0.52633E-02
0.22713E+04	0.38262E-02	0.33519E+00	0.12825E-02	0.50486E-02
0.22714E+04	0.36635E-02	0.33524E+00	0.12281E-02	0.48345E-02
0.22715E+04	0.35032E-02	0.33528E+00	0.11746E-02	0.46237E-02
0.22716E+04	0.33449E-02	0.33532E+00	0.11216E-02	0.44152E-02
0.22717E+04	0.31911E-02	0.33537E+00	0.10702E-02	0.42128E-02
0.22718E+04	0.30390E-02	0.33541E+00	0.10193E-02	0.40125E-02
0.22719E+04	0.28902E-02	0.33545E+00	0.96953E-03	0.38165E-02
0.22720E+04	0.27433E-02	0.33549E+00	0.92036E-03	0.36230E-02
0.22721E+04	0.26056E-02	0.33555E+00	0.87432E-03	0.34417E-02
0.22722E+04	0.24741E-02	0.33561E+00	0.83036E-03	0.32687E-02
0.22723E+04	0.23473E-02	0.33568E+00	0.78791E-03	0.31016E-02
0.22724E+04	0.22248E-02	0.33574E+00	0.74694E-03	0.29403E-02
0.22725E+04	0.21063E-02	0.33580E+00	0.70728E-03	0.27842E-02
0.22726E+04	0.19881E-02	0.33585E+00	0.66771E-03	0.26284E-02
0.22727E+04	0.18705E-02	0.33591E+00	0.62833E-03	0.24734E-02
0.22728E+04	0.17540E-02	0.33597E+00	0.58927E-03	0.23196E-02
0.22729E+04	0.16399E-02	0.33602E+00	0.55104E-03	0.21691E-02
0.22730E+04	0.15335E-02	0.33608E+00	0.51539E-03	0.20288E-02
0.22731E+04	0.14304E-02	0.33613E+00	0.48081E-03	0.18927E-02
0.22732E+04	0.13274E-02	0.33619E+00	0.44626E-03	0.17567E-02
0.22733E+04	0.12250E-02	0.33624E+00	0.41191E-03	0.16215E-02
0.22734E+04	0.11245E-02	0.33630E+00	0.37817E-03	0.14886E-02
0.22735E+04	0.10242E-02	0.33635E+00	0.34448E-03	0.13561E-02
0.22736E+04	0.92962E-03	0.33641E+00	0.31273E-03	0.12311E-02
0.22737E+04	0.83948E-03	0.33646E+00	0.28246E-03	0.11119E-02
0.22738E+04	0.75126E-03	0.33652E+00	0.25281E-03	0.99520E-03
0.22739E+04	0.66347E-03	0.33658E+00	0.22331E-03	0.87905E-03

0.22740E+04	0.57689E-03	0.33663E+00	0.19420E-03	0.76446E-03
0.22741E+04	0.49384E-03	0.33672E+00	0.16629E-03	0.65458E-03
0.22742E+04	0.41107E-03	0.33681E+00	0.13845E-03	0.54501E-03
0.22743E+04	0.32980E-03	0.33690E+00	0.11111E-03	0.43737E-03
0.22744E+04	0.25195E-03	0.33699E+00	0.84906E-04	0.33423E-03
0.22745E+04	0.17642E-03	0.33708E+00	0.59467E-04	0.23409E-03
0.22746E+04	0.10189E-03	0.33718E+00	0.34354E-04	0.13524E-03
0.22747E+04	0.31034E-04	0.33728E+00	0.10467E-04	0.41203E-04
0.22748E+04	0.00000E+00	0.33737E+00	0.00000E+00	0.00000E+00
Channel 17				
Wavenumber	HIRS Filter Transmittance	Optical Element Transmittance	Product of the HIRS Filter and Optical Element Transmittances	Normalized Value of Column 4
0.23817E+04	0.00000E+00	0.38660E+00	0.00000E+00	0.00000E+00
0.23818E+04	0.65845E-04	0.38666E+00	0.25460E-04	0.91671E-04
0.23819E+04	0.15571E-03	0.38672E+00	0.60216E-04	0.21682E-03
0.23820E+04	0.24621E-03	0.38677E+00	0.95225E-04	0.34287E-03
0.23821E+04	0.33710E-03	0.38682E+00	0.13040E-03	0.46951E-03
0.23822E+04	0.42887E-03	0.38686E+00	0.16591E-03	0.59739E-03
0.23823E+04	0.52137E-03	0.38691E+00	0.20172E-03	0.72632E-03
0.23824E+04	0.61387E-03	0.38695E+00	0.23754E-03	0.85529E-03
0.23825E+04	0.70670E-03	0.38700E+00	0.27349E-03	0.98474E-03
0.23826E+04	0.80029E-03	0.38703E+00	0.30973E-03	0.11152E-02
0.23827E+04	0.89393E-03	0.38706E+00	0.34601E-03	0.12459E-02
0.23828E+04	0.98811E-03	0.38710E+00	0.38249E-03	0.13772E-02
0.23829E+04	0.10823E-02	0.38713E+00	0.41900E-03	0.15087E-02
0.23830E+04	0.11767E-02	0.38716E+00	0.45557E-03	0.16404E-02
0.23831E+04	0.12721E-02	0.38719E+00	0.49253E-03	0.17734E-02
0.23832E+04	0.13684E-02	0.38721E+00	0.52984E-03	0.19078E-02
0.23833E+04	0.14680E-02	0.38724E+00	0.56848E-03	0.20469E-02
0.23834E+04	0.15701E-02	0.38726E+00	0.60802E-03	0.21893E-02
0.23835E+04	0.16727E-02	0.38728E+00	0.64781E-03	0.23325E-02
0.23836E+04	0.17760E-02	0.38730E+00	0.68787E-03	0.24768E-02
0.23837E+04	0.18813E-02	0.38732E+00	0.72866E-03	0.26237E-02
0.23838E+04	0.19866E-02	0.38734E+00	0.76948E-03	0.27706E-02
0.23839E+04	0.20939E-02	0.38736E+00	0.81109E-03	0.29205E-02
0.23840E+04	0.22015E-02	0.38737E+00	0.85279E-03	0.30706E-02
0.23841E+04	0.23112E-02	0.38736E+00	0.89525E-03	0.32235E-02
0.23842E+04	0.24225E-02	0.38734E+00	0.93834E-03	0.33786E-02
0.23843E+04	0.25341E-02	0.38733E+00	0.98152E-03	0.35341E-02
0.23844E+04	0.26460E-02	0.38731E+00	0.10248E-02	0.36900E-02
0.23845E+04	0.27592E-02	0.38730E+00	0.10687E-02	0.38478E-02

0.23846E+04	0.28733E-02	0.38729E+00	0.11128E-02	0.40068E-02
0.23847E+04	0.29879E-02	0.38729E+00	0.11572E-02	0.41666E-02
0.23848E+04	0.31034E-02	0.38728E+00	0.12019E-02	0.43276E-02
0.23849E+04	0.32190E-02	0.38727E+00	0.12466E-02	0.44887E-02
0.23850E+04	0.33350E-02	0.38726E+00	0.12915E-02	0.46503E-02
0.23851E+04	0.34517E-02	0.38727E+00	0.13367E-02	0.48131E-02
0.23852E+04	0.35740E-02	0.38727E+00	0.13841E-02	0.49837E-02
0.23853E+04	0.37039E-02	0.38728E+00	0.14344E-02	0.51648E-02
0.23854E+04	0.38374E-02	0.38728E+00	0.14861E-02	0.53511E-02
0.23855E+04	0.39755E-02	0.38728E+00	0.15397E-02	0.55438E-02
0.23856E+04	0.41180E-02	0.38730E+00	0.15949E-02	0.57427E-02
0.23857E+04	0.42706E-02	0.38731E+00	0.16540E-02	0.59556E-02
0.23858E+04	0.44251E-02	0.38732E+00	0.17139E-02	0.61712E-02
0.23859E+04	0.45796E-02	0.38733E+00	0.17738E-02	0.63869E-02
0.23860E+04	0.47449E-02	0.38735E+00	0.18379E-02	0.66176E-02
0.23861E+04	0.49105E-02	0.38737E+00	0.19022E-02	0.68491E-02
0.23862E+04	0.50819E-02	0.38740E+00	0.19687E-02	0.70887E-02
0.23863E+04	0.52542E-02	0.38743E+00	0.20356E-02	0.73295E-02
0.23864E+04	0.54269E-02	0.38745E+00	0.21027E-02	0.75709E-02
0.23865E+04	0.56013E-02	0.38748E+00	0.21704E-02	0.78148E-02
0.23866E+04	0.57763E-02	0.38751E+00	0.22384E-02	0.80596E-02
0.23867E+04	0.59520E-02	0.38754E+00	0.23066E-02	0.83054E-02
0.23868E+04	0.61282E-02	0.38757E+00	0.23751E-02	0.85519E-02
0.23869E+04	0.63045E-02	0.38760E+00	0.24436E-02	0.87987E-02
0.23870E+04	0.64840E-02	0.38763E+00	0.25134E-02	0.90499E-02
0.23871E+04	0.66660E-02	0.38767E+00	0.25842E-02	0.93048E-02
0.23872E+04	0.68504E-02	0.38770E+00	0.26559E-02	0.95630E-02
0.23873E+04	0.70359E-02	0.38773E+00	0.27280E-02	0.98226E-02
0.23874E+04	0.72215E-02	0.38776E+00	0.28002E-02	0.10083E-01
0.23875E+04	0.74118E-02	0.38780E+00	0.28743E-02	0.10349E-01
0.23876E+04	0.76035E-02	0.38783E+00	0.29489E-02	0.10618E-01
0.23877E+04	0.77961E-02	0.38786E+00	0.30238E-02	0.10888E-01
0.23878E+04	0.79891E-02	0.38789E+00	0.30989E-02	0.11158E-01
0.23879E+04	0.81823E-02	0.38793E+00	0.31741E-02	0.11429E-01
0.23880E+04	0.83796E-02	0.38796E+00	0.32509E-02	0.11705E-01
0.23881E+04	0.85781E-02	0.38801E+00	0.33284E-02	0.11985E-01
0.23882E+04	0.87789E-02	0.38807E+00	0.34068E-02	0.12267E-01
0.23883E+04	0.89800E-02	0.38813E+00	0.34854E-02	0.12550E-01
0.23884E+04	0.91813E-02	0.38818E+00	0.35640E-02	0.12833E-01
0.23885E+04	0.93834E-02	0.38824E+00	0.36430E-02	0.13117E-01
0.23886E+04	0.95869E-02	0.38829E+00	0.37225E-02	0.13404E-01
0.23887E+04	0.97907E-02	0.38835E+00	0.38022E-02	0.13690E-01
0.23888E+04	0.10000E-01	0.38840E+00	0.38841E-02	0.13985E-01

0.23889E+04	0.10211E-01	0.38846E+00	0.39664E-02	0.14282E-01
0.23890E+04	0.10425E-01	0.38851E+00	0.40503E-02	0.14584E-01
0.23891E+04	0.10644E-01	0.38856E+00	0.41358E-02	0.14892E-01
0.23892E+04	0.10870E-01	0.38862E+00	0.42244E-02	0.15211E-01
0.23893E+04	0.11098E-01	0.38867E+00	0.43135E-02	0.15532E-01
0.23894E+04	0.11328E-01	0.38872E+00	0.44036E-02	0.15856E-01
0.23895E+04	0.11565E-01	0.38878E+00	0.44964E-02	0.16190E-01
0.23896E+04	0.11806E-01	0.38883E+00	0.45906E-02	0.16529E-01
0.23897E+04	0.12052E-01	0.38888E+00	0.46869E-02	0.16876E-01
0.23898E+04	0.12300E-01	0.38894E+00	0.47840E-02	0.17226E-01
0.23899E+04	0.12554E-01	0.38899E+00	0.48833E-02	0.17583E-01
0.23900E+04	0.12808E-01	0.38904E+00	0.49829E-02	0.17942E-01
0.23901E+04	0.13071E-01	0.38910E+00	0.50858E-02	0.18312E-01
0.23902E+04	0.13335E-01	0.38917E+00	0.51895E-02	0.18686E-01
0.23903E+04	0.13604E-01	0.38923E+00	0.52949E-02	0.19065E-01
0.23904E+04	0.13873E-01	0.38929E+00	0.54007E-02	0.19446E-01
0.23905E+04	0.14147E-01	0.38936E+00	0.55081E-02	0.19833E-01
0.23906E+04	0.14423E-01	0.38942E+00	0.56164E-02	0.20223E-01
0.23907E+04	0.14703E-01	0.38948E+00	0.57266E-02	0.20620E-01
0.23908E+04	0.14985E-01	0.38954E+00	0.58372E-02	0.21018E-01
0.23909E+04	0.15271E-01	0.38960E+00	0.59495E-02	0.21422E-01
0.23910E+04	0.15557E-01	0.38966E+00	0.60619E-02	0.21827E-01
0.23911E+04	0.15846E-01	0.38972E+00	0.61755E-02	0.22236E-01
0.23912E+04	0.16135E-01	0.38978E+00	0.62892E-02	0.22645E-01
0.23913E+04	0.16426E-01	0.38984E+00	0.64035E-02	0.23057E-01
0.23914E+04	0.16717E-01	0.38990E+00	0.65180E-02	0.23469E-01
0.23915E+04	0.17009E-01	0.38996E+00	0.66327E-02	0.23882E-01
0.23916E+04	0.17326E-01	0.39001E+00	0.67572E-02	0.24330E-01
0.23917E+04	0.17669E-01	0.39007E+00	0.68922E-02	0.24816E-01
0.23918E+04	0.18041E-01	0.39012E+00	0.70383E-02	0.25343E-01
0.23919E+04	0.18443E-01	0.39018E+00	0.71959E-02	0.25910E-01
0.23920E+04	0.18874E-01	0.39023E+00	0.73653E-02	0.26520E-01
0.23921E+04	0.19335E-01	0.39026E+00	0.75458E-02	0.27170E-01
0.23922E+04	0.19826E-01	0.39028E+00	0.77378E-02	0.27861E-01
0.23923E+04	0.20345E-01	0.39031E+00	0.79410E-02	0.28593E-01
0.23924E+04	0.20892E-01	0.39033E+00	0.81550E-02	0.29363E-01
0.23925E+04	0.21465E-01	0.39036E+00	0.83789E-02	0.30169E-01
0.23926E+04	0.22060E-01	0.39038E+00	0.86119E-02	0.31009E-01
0.23927E+04	0.22676E-01	0.39041E+00	0.88530E-02	0.31877E-01
0.23928E+04	0.23311E-01	0.39043E+00	0.91011E-02	0.32770E-01
0.23929E+04	0.23959E-01	0.39045E+00	0.93549E-02	0.33684E-01
0.23930E+04	0.24619E-01	0.39048E+00	0.96133E-02	0.34614E-01
0.23931E+04	0.25288E-01	0.39050E+00	0.98749E-02	0.35556E-01

0.23932E+04	0.25963E-01	0.39052E+00	0.10139E-01	0.36507E-01
0.23933E+04	0.26637E-01	0.39054E+00	0.10403E-01	0.37457E-01
0.23934E+04	0.27312E-01	0.39057E+00	0.10667E-01	0.38408E-01
0.23935E+04	0.27987E-01	0.39059E+00	0.10931E-01	0.39360E-01
0.23936E+04	0.28663E-01	0.39061E+00	0.11196E-01	0.40314E-01
0.23937E+04	0.29341E-01	0.39064E+00	0.11461E-01	0.41269E-01
0.23938E+04	0.30019E-01	0.39066E+00	0.11727E-01	0.42225E-01
0.23939E+04	0.30697E-01	0.39068E+00	0.11993E-01	0.43182E-01
0.23940E+04	0.31377E-01	0.39071E+00	0.12259E-01	0.44141E-01
0.23941E+04	0.32056E-01	0.39077E+00	0.12527E-01	0.45104E-01
0.23942E+04	0.32737E-01	0.39083E+00	0.12794E-01	0.46068E-01
0.23943E+04	0.33425E-01	0.39088E+00	0.13065E-01	0.47043E-01
0.23944E+04	0.34123E-01	0.39094E+00	0.13340E-01	0.48033E-01
0.23945E+04	0.34835E-01	0.39100E+00	0.13621E-01	0.49043E-01
0.23946E+04	0.35566E-01	0.39106E+00	0.13909E-01	0.50080E-01
0.23947E+04	0.36319E-01	0.39112E+00	0.14205E-01	0.51148E-01
0.23948E+04	0.37098E-01	0.39119E+00	0.14512E-01	0.52253E-01
0.23949E+04	0.37905E-01	0.39126E+00	0.14831E-01	0.53400E-01
0.23950E+04	0.38745E-01	0.39134E+00	0.15162E-01	0.54594E-01
0.23951E+04	0.39619E-01	0.39140E+00	0.15507E-01	0.55834E-01
0.23952E+04	0.40529E-01	0.39147E+00	0.15866E-01	0.57127E-01
0.23953E+04	0.41478E-01	0.39153E+00	0.16240E-01	0.58474E-01
0.23954E+04	0.42466E-01	0.39159E+00	0.16629E-01	0.59877E-01
0.23955E+04	0.43493E-01	0.39166E+00	0.17034E-01	0.61335E-01
0.23956E+04	0.44559E-01	0.39172E+00	0.17455E-01	0.62849E-01
0.23957E+04	0.45664E-01	0.39179E+00	0.17891E-01	0.64417E-01
0.23958E+04	0.46805E-01	0.39185E+00	0.18341E-01	0.66038E-01
0.23959E+04	0.47981E-01	0.39192E+00	0.18805E-01	0.67709E-01
0.23960E+04	0.49190E-01	0.39198E+00	0.19281E-01	0.69426E-01
0.23961E+04	0.50428E-01	0.39203E+00	0.19769E-01	0.71183E-01
0.23962E+04	0.51693E-01	0.39209E+00	0.20268E-01	0.72979E-01
0.23963E+04	0.52983E-01	0.39214E+00	0.20777E-01	0.74810E-01
0.23964E+04	0.54294E-01	0.39220E+00	0.21294E-01	0.76672E-01
0.23965E+04	0.55625E-01	0.39225E+00	0.21819E-01	0.78562E-01
0.23966E+04	0.56973E-01	0.39230E+00	0.22350E-01	0.80476E-01
0.23967E+04	0.58337E-01	0.39235E+00	0.22888E-01	0.82413E-01
0.23968E+04	0.59715E-01	0.39240E+00	0.23432E-01	0.84371E-01
0.23969E+04	0.61107E-01	0.39245E+00	0.23981E-01	0.86348E-01
0.23970E+04	0.62513E-01	0.39249E+00	0.24536E-01	0.88346E-01
0.23971E+04	0.63933E-01	0.39254E+00	0.25096E-01	0.90363E-01
0.23972E+04	0.65369E-01	0.39258E+00	0.25663E-01	0.92402E-01
0.23973E+04	0.66823E-01	0.39263E+00	0.26236E-01	0.94468E-01
0.23974E+04	0.68298E-01	0.39267E+00	0.26819E-01	0.96565E-01

0.23975E+04	0.69799E-01	0.39272E+00	0.27411E-01	0.98698E-01
0.23976E+04	0.71330E-01	0.39275E+00	0.28015E-01	0.10087E+00
0.23977E+04	0.72896E-01	0.39279E+00	0.28633E-01	0.10310E+00
0.23978E+04	0.74503E-01	0.39283E+00	0.29267E-01	0.10538E+00
0.23979E+04	0.76158E-01	0.39287E+00	0.29920E-01	0.10773E+00
0.23980E+04	0.77866E-01	0.39291E+00	0.30594E-01	0.11016E+00
0.23981E+04	0.79634E-01	0.39296E+00	0.31293E-01	0.11267E+00
0.23982E+04	0.81469E-01	0.39301E+00	0.32018E-01	0.11529E+00
0.23983E+04	0.83379E-01	0.39307E+00	0.32773E-01	0.11801E+00
0.23984E+04	0.85369E-01	0.39312E+00	0.33560E-01	0.12084E+00
0.23985E+04	0.87445E-01	0.39317E+00	0.34381E-01	0.12379E+00
0.23986E+04	0.89613E-01	0.39323E+00	0.35238E-01	0.12688E+00
0.23987E+04	0.91874E-01	0.39328E+00	0.36132E-01	0.13010E+00
0.23988E+04	0.94233E-01	0.39333E+00	0.37065E-01	0.13346E+00
0.23989E+04	0.96689E-01	0.39339E+00	0.38036E-01	0.13695E+00
0.23990E+04	0.99242E-01	0.39344E+00	0.39046E-01	0.14059E+00
0.23991E+04	0.10189E+00	0.39350E+00	0.40093E-01	0.14436E+00
0.23992E+04	0.10463E+00	0.39355E+00	0.41177E-01	0.14827E+00
0.23993E+04	0.10746E+00	0.39361E+00	0.42296E-01	0.15229E+00
0.23994E+04	0.11037E+00	0.39367E+00	0.43448E-01	0.15644E+00
0.23995E+04	0.11336E+00	0.39372E+00	0.44630E-01	0.16070E+00
0.23996E+04	0.11641E+00	0.39377E+00	0.45839E-01	0.16505E+00
0.23997E+04	0.11952E+00	0.39382E+00	0.47071E-01	0.16949E+00
0.23998E+04	0.12269E+00	0.39387E+00	0.48323E-01	0.17400E+00
0.23999E+04	0.12589E+00	0.39392E+00	0.49593E-01	0.17857E+00
0.24000E+04	0.12913E+00	0.39397E+00	0.50874E-01	0.18318E+00
0.24001E+04	0.13240E+00	0.39398E+00	0.52162E-01	0.18782E+00
0.24002E+04	0.13567E+00	0.39400E+00	0.53454E-01	0.19247E+00
0.24003E+04	0.13895E+00	0.39401E+00	0.54749E-01	0.19713E+00
0.24004E+04	0.14223E+00	0.39403E+00	0.56044E-01	0.20179E+00
0.24005E+04	0.14550E+00	0.39404E+00	0.57335E-01	0.20644E+00
0.24006E+04	0.14876E+00	0.39406E+00	0.58622E-01	0.21108E+00
0.24007E+04	0.15200E+00	0.39408E+00	0.59901E-01	0.21568E+00
0.24008E+04	0.15522E+00	0.39410E+00	0.61173E-01	0.22026E+00
0.24009E+04	0.15842E+00	0.39412E+00	0.62437E-01	0.22481E+00
0.24010E+04	0.16160E+00	0.39414E+00	0.63692E-01	0.22933E+00
0.24011E+04	0.16476E+00	0.39416E+00	0.64940E-01	0.23383E+00
0.24012E+04	0.16790E+00	0.39417E+00	0.66181E-01	0.23829E+00
0.24013E+04	0.17103E+00	0.39419E+00	0.67418E-01	0.24275E+00
0.24014E+04	0.17415E+00	0.39421E+00	0.68652E-01	0.24719E+00
0.24015E+04	0.17727E+00	0.39423E+00	0.69886E-01	0.25163E+00
0.24016E+04	0.18040E+00	0.39424E+00	0.71122E-01	0.25609E+00
0.24017E+04	0.18355E+00	0.39426E+00	0.72365E-01	0.26056E+00

0.24018E+04	0.18671E+00	0.39428E+00	0.73616E-01	0.26507E+00
0.24019E+04	0.18991E+00	0.39429E+00	0.74880E-01	0.26962E+00
0.24020E+04	0.19315E+00	0.39431E+00	0.76159E-01	0.27422E+00
0.24021E+04	0.19643E+00	0.39427E+00	0.77447E-01	0.27886E+00
0.24022E+04	0.19977E+00	0.39424E+00	0.78757E-01	0.28358E+00
0.24023E+04	0.20318E+00	0.39420E+00	0.80092E-01	0.28838E+00
0.24024E+04	0.20665E+00	0.39416E+00	0.81455E-01	0.29329E+00
0.24025E+04	0.21021E+00	0.39413E+00	0.82849E-01	0.29831E+00
0.24026E+04	0.21385E+00	0.39409E+00	0.84275E-01	0.30344E+00
0.24027E+04	0.21758E+00	0.39405E+00	0.85735E-01	0.30870E+00
0.24028E+04	0.22140E+00	0.39401E+00	0.87232E-01	0.31409E+00
0.24029E+04	0.22531E+00	0.39397E+00	0.88765E-01	0.31961E+00
0.24030E+04	0.22932E+00	0.39393E+00	0.90336E-01	0.32527E+00
0.24031E+04	0.23343E+00	0.39388E+00	0.91944E-01	0.33106E+00
0.24032E+04	0.23763E+00	0.39384E+00	0.93589E-01	0.33698E+00
0.24033E+04	0.24193E+00	0.39380E+00	0.95269E-01	0.34303E+00
0.24034E+04	0.24631E+00	0.39375E+00	0.96985E-01	0.34921E+00
0.24035E+04	0.25078E+00	0.39371E+00	0.98734E-01	0.35551E+00
0.24036E+04	0.25533E+00	0.39366E+00	0.10051E+00	0.36191E+00
0.24037E+04	0.25995E+00	0.39362E+00	0.10232E+00	0.36842E+00
0.24038E+04	0.26464E+00	0.39357E+00	0.10416E+00	0.37503E+00
0.24039E+04	0.26939E+00	0.39353E+00	0.10601E+00	0.38172E+00
0.24040E+04	0.27420E+00	0.39348E+00	0.10789E+00	0.38848E+00
0.24041E+04	0.27905E+00	0.39347E+00	0.10980E+00	0.39534E+00
0.24042E+04	0.28394E+00	0.39345E+00	0.11172E+00	0.40225E+00
0.24043E+04	0.28886E+00	0.39344E+00	0.11365E+00	0.40922E+00
0.24044E+04	0.29382E+00	0.39343E+00	0.11560E+00	0.41622E+00
0.24045E+04	0.29879E+00	0.39342E+00	0.11755E+00	0.42326E+00
0.24046E+04	0.30378E+00	0.39341E+00	0.11951E+00	0.43032E+00
0.24047E+04	0.30878E+00	0.39340E+00	0.12148E+00	0.43740E+00
0.24048E+04	0.31379E+00	0.39340E+00	0.12344E+00	0.44448E+00
0.24049E+04	0.31880E+00	0.39339E+00	0.12541E+00	0.45156E+00
0.24050E+04	0.32380E+00	0.39338E+00	0.12738E+00	0.45864E+00
0.24051E+04	0.32880E+00	0.39339E+00	0.12935E+00	0.46573E+00
0.24052E+04	0.33378E+00	0.39340E+00	0.13131E+00	0.47280E+00
0.24053E+04	0.33875E+00	0.39341E+00	0.13327E+00	0.47985E+00
0.24054E+04	0.34370E+00	0.39342E+00	0.13522E+00	0.48687E+00
0.24055E+04	0.34863E+00	0.39343E+00	0.13716E+00	0.49386E+00
0.24056E+04	0.35353E+00	0.39344E+00	0.13909E+00	0.50083E+00
0.24057E+04	0.35840E+00	0.39345E+00	0.14102E+00	0.50775E+00
0.24058E+04	0.36325E+00	0.39347E+00	0.14293E+00	0.51463E+00
0.24059E+04	0.36807E+00	0.39348E+00	0.14483E+00	0.52147E+00
0.24060E+04	0.37285E+00	0.39349E+00	0.14671E+00	0.52826E+00

0.24061E+04	0.37759E+00	0.39352E+00	0.14859E+00	0.53502E+00
0.24062E+04	0.38229E+00	0.39355E+00	0.15045E+00	0.54172E+00
0.24063E+04	0.38695E+00	0.39358E+00	0.15230E+00	0.54836E+00
0.24064E+04	0.39156E+00	0.39361E+00	0.15412E+00	0.55494E+00
0.24065E+04	0.39611E+00	0.39364E+00	0.15593E+00	0.56143E+00
0.24066E+04	0.40061E+00	0.39367E+00	0.15771E+00	0.56785E+00
0.24067E+04	0.40505E+00	0.39370E+00	0.15947E+00	0.57419E+00
0.24068E+04	0.40942E+00	0.39373E+00	0.16120E+00	0.58043E+00
0.24069E+04	0.41371E+00	0.39376E+00	0.16290E+00	0.58656E+00
0.24070E+04	0.41793E+00	0.39379E+00	0.16458E+00	0.59259E+00
0.24071E+04	0.42207E+00	0.39382E+00	0.16622E+00	0.59851E+00
0.24072E+04	0.42613E+00	0.39386E+00	0.16783E+00	0.60431E+00
0.24073E+04	0.43010E+00	0.39389E+00	0.16941E+00	0.60999E+00
0.24074E+04	0.43399E+00	0.39392E+00	0.17096E+00	0.61556E+00
0.24075E+04	0.43780E+00	0.39395E+00	0.17247E+00	0.62102E+00
0.24076E+04	0.44154E+00	0.39399E+00	0.17396E+00	0.62637E+00
0.24077E+04	0.44521E+00	0.39402E+00	0.17542E+00	0.63163E+00
0.24078E+04	0.44883E+00	0.39405E+00	0.17686E+00	0.63682E+00
0.24079E+04	0.45241E+00	0.39408E+00	0.17829E+00	0.64194E+00
0.24080E+04	0.45595E+00	0.39412E+00	0.17970E+00	0.64703E+00
0.24081E+04	0.45948E+00	0.39419E+00	0.18112E+00	0.65215E+00
0.24082E+04	0.46300E+00	0.39426E+00	0.18254E+00	0.65728E+00
0.24083E+04	0.46653E+00	0.39433E+00	0.18397E+00	0.66241E+00
0.24084E+04	0.47008E+00	0.39441E+00	0.18540E+00	0.66757E+00
0.24085E+04	0.47364E+00	0.39448E+00	0.18684E+00	0.67275E+00
0.24086E+04	0.47722E+00	0.39455E+00	0.18829E+00	0.67797E+00
0.24087E+04	0.48083E+00	0.39463E+00	0.18975E+00	0.68322E+00
0.24088E+04	0.48445E+00	0.39470E+00	0.19121E+00	0.68849E+00
0.24089E+04	0.48809E+00	0.39478E+00	0.19269E+00	0.69380E+00
0.24090E+04	0.49174E+00	0.39485E+00	0.19417E+00	0.69913E+00
0.24091E+04	0.49542E+00	0.39493E+00	0.19566E+00	0.70449E+00
0.24092E+04	0.49911E+00	0.39501E+00	0.19715E+00	0.70988E+00
0.24093E+04	0.50282E+00	0.39508E+00	0.19866E+00	0.71529E+00
0.24094E+04	0.50656E+00	0.39516E+00	0.20017E+00	0.72075E+00
0.24095E+04	0.51032E+00	0.39524E+00	0.20170E+00	0.72625E+00
0.24096E+04	0.51412E+00	0.39532E+00	0.20324E+00	0.73179E+00
0.24097E+04	0.51794E+00	0.39539E+00	0.20479E+00	0.73738E+00
0.24098E+04	0.52180E+00	0.39547E+00	0.20636E+00	0.74302E+00
0.24099E+04	0.52570E+00	0.39555E+00	0.20794E+00	0.74872E+00
0.24100E+04	0.52963E+00	0.39563E+00	0.20954E+00	0.75446E+00
0.24101E+04	0.53359E+00	0.39572E+00	0.21115E+00	0.76028E+00
0.24102E+04	0.53758E+00	0.39581E+00	0.21278E+00	0.76614E+00
0.24103E+04	0.54159E+00	0.39590E+00	0.21442E+00	0.77203E+00

0.24104E+04	0.54561E+00	0.39599E+00	0.21606E+00	0.77795E+00
0.24105E+04	0.54964E+00	0.39609E+00	0.21770E+00	0.78388E+00
0.24106E+04	0.55367E+00	0.39617E+00	0.21935E+00	0.78980E+00
0.24107E+04	0.55768E+00	0.39626E+00	0.22099E+00	0.79570E+00
0.24108E+04	0.56167E+00	0.39635E+00	0.22262E+00	0.80157E+00
0.24109E+04	0.56562E+00	0.39644E+00	0.22423E+00	0.80739E+00
0.24110E+04	0.56952E+00	0.39653E+00	0.22583E+00	0.81313E+00
0.24111E+04	0.57336E+00	0.39661E+00	0.22740E+00	0.81878E+00
0.24112E+04	0.57712E+00	0.39669E+00	0.22894E+00	0.82433E+00
0.24113E+04	0.58081E+00	0.39678E+00	0.23045E+00	0.82977E+00
0.24114E+04	0.58441E+00	0.39686E+00	0.23193E+00	0.83509E+00
0.24115E+04	0.58791E+00	0.39694E+00	0.23337E+00	0.84027E+00
0.24116E+04	0.59132E+00	0.39702E+00	0.23476E+00	0.84530E+00
0.24117E+04	0.59463E+00	0.39709E+00	0.23612E+00	0.85019E+00
0.24118E+04	0.59783E+00	0.39717E+00	0.23744E+00	0.85494E+00
0.24119E+04	0.60094E+00	0.39724E+00	0.23872E+00	0.85954E+00
0.24120E+04	0.60394E+00	0.39732E+00	0.23996E+00	0.86401E+00
0.24121E+04	0.60685E+00	0.39736E+00	0.24114E+00	0.86826E+00
0.24122E+04	0.60966E+00	0.39740E+00	0.24228E+00	0.87236E+00
0.24123E+04	0.61238E+00	0.39744E+00	0.24338E+00	0.87633E+00
0.24124E+04	0.61500E+00	0.39747E+00	0.24445E+00	0.88017E+00
0.24125E+04	0.61753E+00	0.39751E+00	0.24548E+00	0.88387E+00
0.24126E+04	0.61997E+00	0.39755E+00	0.24647E+00	0.88744E+00
0.24127E+04	0.62231E+00	0.39758E+00	0.24742E+00	0.89087E+00
0.24128E+04	0.62457E+00	0.39761E+00	0.24834E+00	0.89417E+00
0.24129E+04	0.62672E+00	0.39765E+00	0.24922E+00	0.89734E+00
0.24130E+04	0.62878E+00	0.39768E+00	0.25006E+00	0.90037E+00
0.24131E+04	0.63074E+00	0.39772E+00	0.25086E+00	0.90325E+00
0.24132E+04	0.63261E+00	0.39775E+00	0.25162E+00	0.90600E+00
0.24133E+04	0.63437E+00	0.39779E+00	0.25235E+00	0.90861E+00
0.24134E+04	0.63604E+00	0.39782E+00	0.25303E+00	0.91108E+00
0.24135E+04	0.63762E+00	0.39786E+00	0.25368E+00	0.91342E+00
0.24136E+04	0.63911E+00	0.39790E+00	0.25430E+00	0.91565E+00
0.24137E+04	0.64054E+00	0.39794E+00	0.25489E+00	0.91778E+00
0.24138E+04	0.64190E+00	0.39798E+00	0.25546E+00	0.91982E+00
0.24139E+04	0.64321E+00	0.39802E+00	0.25601E+00	0.92181E+00
0.24140E+04	0.64448E+00	0.39807E+00	0.25655E+00	0.92374E+00
0.24141E+04	0.64573E+00	0.39813E+00	0.25708E+00	0.92567E+00
0.24142E+04	0.64697E+00	0.39819E+00	0.25762E+00	0.92759E+00
0.24143E+04	0.64821E+00	0.39824E+00	0.25815E+00	0.92949E+00
0.24144E+04	0.64945E+00	0.39830E+00	0.25868E+00	0.93140E+00
0.24145E+04	0.65069E+00	0.39836E+00	0.25921E+00	0.93332E+00
0.24146E+04	0.65193E+00	0.39843E+00	0.25975E+00	0.93526E+00

0.24147E+04	0.65318E+00	0.39849E+00	0.26029E+00	0.93721E+00
0.24148E+04	0.65443E+00	0.39856E+00	0.26083E+00	0.93915E+00
0.24149E+04	0.65568E+00	0.39863E+00	0.26137E+00	0.94110E+00
0.24150E+04	0.65693E+00	0.39869E+00	0.26191E+00	0.94305E+00
0.24151E+04	0.65817E+00	0.39875E+00	0.26245E+00	0.94498E+00
0.24152E+04	0.65941E+00	0.39881E+00	0.26298E+00	0.94690E+00
0.24153E+04	0.66064E+00	0.39887E+00	0.26351E+00	0.94882E+00
0.24154E+04	0.66187E+00	0.39894E+00	0.26405E+00	0.95073E+00
0.24155E+04	0.66310E+00	0.39900E+00	0.26458E+00	0.95264E+00
0.24156E+04	0.66432E+00	0.39906E+00	0.26511E+00	0.95455E+00
0.24157E+04	0.66554E+00	0.39912E+00	0.26563E+00	0.95645E+00
0.24158E+04	0.66675E+00	0.39919E+00	0.26616E+00	0.95835E+00
0.24159E+04	0.66796E+00	0.39925E+00	0.26668E+00	0.96023E+00
0.24160E+04	0.66916E+00	0.39932E+00	0.26721E+00	0.96212E+00
0.24161E+04	0.67035E+00	0.39941E+00	0.26775E+00	0.96406E+00
0.24162E+04	0.67153E+00	0.39951E+00	0.26828E+00	0.96599E+00
0.24163E+04	0.67271E+00	0.39960E+00	0.26882E+00	0.96791E+00
0.24164E+04	0.67388E+00	0.39970E+00	0.26935E+00	0.96982E+00
0.24165E+04	0.67504E+00	0.39979E+00	0.26987E+00	0.97172E+00
0.24166E+04	0.67619E+00	0.39988E+00	0.27039E+00	0.97359E+00
0.24167E+04	0.67733E+00	0.39996E+00	0.27091E+00	0.97544E+00
0.24168E+04	0.67845E+00	0.40005E+00	0.27141E+00	0.97727E+00
0.24169E+04	0.67956E+00	0.40014E+00	0.27191E+00	0.97907E+00
0.24170E+04	0.68064E+00	0.40022E+00	0.27241E+00	0.98085E+00
0.24171E+04	0.68170E+00	0.40030E+00	0.27289E+00	0.98257E+00
0.24172E+04	0.68274E+00	0.40038E+00	0.27335E+00	0.98425E+00
0.24173E+04	0.68374E+00	0.40046E+00	0.27381E+00	0.98589E+00
0.24174E+04	0.68471E+00	0.40054E+00	0.27425E+00	0.98749E+00
0.24175E+04	0.68564E+00	0.40061E+00	0.27468E+00	0.98902E+00
0.24176E+04	0.68653E+00	0.40068E+00	0.27508E+00	0.99047E+00
0.24177E+04	0.68737E+00	0.40075E+00	0.27546E+00	0.99185E+00
0.24178E+04	0.68815E+00	0.40082E+00	0.27583E+00	0.99316E+00
0.24179E+04	0.68889E+00	0.40089E+00	0.27617E+00	0.99438E+00
0.24180E+04	0.68956E+00	0.40096E+00	0.27648E+00	0.99552E+00
0.24181E+04	0.69017E+00	0.40098E+00	0.27675E+00	0.99647E+00
0.24182E+04	0.69072E+00	0.40099E+00	0.27697E+00	0.99729E+00
0.24183E+04	0.69120E+00	0.40100E+00	0.27717E+00	0.99800E+00
0.24184E+04	0.69161E+00	0.40101E+00	0.27734E+00	0.99862E+00
0.24185E+04	0.69195E+00	0.40102E+00	0.27749E+00	0.99913E+00
0.24186E+04	0.69221E+00	0.40103E+00	0.27760E+00	0.99952E+00
0.24187E+04	0.69239E+00	0.40104E+00	0.27767E+00	0.99981E+00
0.24188E+04	0.69249E+00	0.40104E+00	0.27772E+00	0.99997E+00
0.24189E+04	0.69250E+00	0.40105E+00	0.27773E+00	0.10000E+01

0.24190E+04	0.69242E+00	0.40106E+00	0.27770E+00	0.99990E+00
0.24191E+04	0.69225E+00	0.40106E+00	0.27763E+00	0.99967E+00
0.24192E+04	0.69197E+00	0.40107E+00	0.27753E+00	0.99929E+00
0.24193E+04	0.69159E+00	0.40108E+00	0.27738E+00	0.99877E+00
0.24194E+04	0.69111E+00	0.40109E+00	0.27720E+00	0.99810E+00
0.24195E+04	0.69054E+00	0.40110E+00	0.27697E+00	0.99728E+00
0.24196E+04	0.68986E+00	0.40111E+00	0.27671E+00	0.99634E+00
0.24197E+04	0.68909E+00	0.40113E+00	0.27641E+00	0.99526E+00
0.24198E+04	0.68823E+00	0.40114E+00	0.27608E+00	0.99405E+00
0.24199E+04	0.68729E+00	0.40115E+00	0.27571E+00	0.99273E+00
0.24200E+04	0.68628E+00	0.40117E+00	0.27531E+00	0.99130E+00
0.24201E+04	0.68521E+00	0.40121E+00	0.27491E+00	0.98987E+00
0.24202E+04	0.68409E+00	0.40126E+00	0.27450E+00	0.98836E+00
0.24203E+04	0.68294E+00	0.40130E+00	0.27406E+00	0.98681E+00
0.24204E+04	0.68177E+00	0.40134E+00	0.27362E+00	0.98522E+00
0.24205E+04	0.68059E+00	0.40139E+00	0.27318E+00	0.98363E+00
0.24206E+04	0.67942E+00	0.40144E+00	0.27274E+00	0.98205E+00
0.24207E+04	0.67826E+00	0.40149E+00	0.27231E+00	0.98050E+00
0.24208E+04	0.67714E+00	0.40154E+00	0.27189E+00	0.97900E+00
0.24209E+04	0.67605E+00	0.40158E+00	0.27149E+00	0.97754E+00
0.24210E+04	0.67501E+00	0.40163E+00	0.27111E+00	0.97616E+00
0.24211E+04	0.67403E+00	0.40169E+00	0.27075E+00	0.97487E+00
0.24212E+04	0.67311E+00	0.40174E+00	0.27041E+00	0.97367E+00
0.24213E+04	0.67226E+00	0.40179E+00	0.27011E+00	0.97257E+00
0.24214E+04	0.67148E+00	0.40185E+00	0.26983E+00	0.97156E+00
0.24215E+04	0.67077E+00	0.40190E+00	0.26958E+00	0.97067E+00
0.24216E+04	0.67014E+00	0.40195E+00	0.26936E+00	0.96988E+00
0.24217E+04	0.66957E+00	0.40200E+00	0.26917E+00	0.96919E+00
0.24218E+04	0.66907E+00	0.40206E+00	0.26901E+00	0.96859E+00
0.24219E+04	0.66864E+00	0.40211E+00	0.26886E+00	0.96809E+00
0.24220E+04	0.66825E+00	0.40216E+00	0.26875E+00	0.96767E+00
0.24221E+04	0.66793E+00	0.40221E+00	0.26865E+00	0.96731E+00
0.24222E+04	0.66764E+00	0.40227E+00	0.26857E+00	0.96703E+00
0.24223E+04	0.66740E+00	0.40232E+00	0.26851E+00	0.96681E+00
0.24224E+04	0.66718E+00	0.40238E+00	0.26846E+00	0.96663E+00
0.24225E+04	0.66700E+00	0.40243E+00	0.26842E+00	0.96649E+00
0.24226E+04	0.66684E+00	0.40248E+00	0.26839E+00	0.96637E+00
0.24227E+04	0.66669E+00	0.40253E+00	0.26836E+00	0.96628E+00
0.24228E+04	0.66655E+00	0.40258E+00	0.26834E+00	0.96620E+00
0.24229E+04	0.66641E+00	0.40263E+00	0.26832E+00	0.96611E+00
0.24230E+04	0.66627E+00	0.40268E+00	0.26829E+00	0.96602E+00
0.24231E+04	0.66612E+00	0.40272E+00	0.26826E+00	0.96591E+00
0.24232E+04	0.66597E+00	0.40276E+00	0.26822E+00	0.96578E+00

0.24233E+04	0.66580E+00	0.40280E+00	0.26818E+00	0.96564E+00
0.24234E+04	0.66561E+00	0.40284E+00	0.26814E+00	0.96546E+00
0.24235E+04	0.66540E+00	0.40288E+00	0.26808E+00	0.96526E+00
0.24236E+04	0.66518E+00	0.40293E+00	0.26802E+00	0.96503E+00
0.24237E+04	0.66493E+00	0.40297E+00	0.26795E+00	0.96478E+00
0.24238E+04	0.66467E+00	0.40301E+00	0.26787E+00	0.96450E+00
0.24239E+04	0.66440E+00	0.40305E+00	0.26779E+00	0.96420E+00
0.24240E+04	0.66412E+00	0.40309E+00	0.26770E+00	0.96390E+00
0.24241E+04	0.66384E+00	0.40312E+00	0.26761E+00	0.96357E+00
0.24242E+04	0.66356E+00	0.40316E+00	0.26752E+00	0.96324E+00
0.24243E+04	0.66329E+00	0.40319E+00	0.26743E+00	0.96292E+00
0.24244E+04	0.66303E+00	0.40322E+00	0.26735E+00	0.96262E+00
0.24245E+04	0.66279E+00	0.40325E+00	0.26727E+00	0.96234E+00
0.24246E+04	0.66256E+00	0.40329E+00	0.26720E+00	0.96211E+00
0.24247E+04	0.66236E+00	0.40333E+00	0.26715E+00	0.96191E+00
0.24248E+04	0.66219E+00	0.40336E+00	0.26710E+00	0.96174E+00
0.24249E+04	0.66203E+00	0.40340E+00	0.26706E+00	0.96161E+00
0.24250E+04	0.66191E+00	0.40344E+00	0.26704E+00	0.96151E+00
0.24251E+04	0.66180E+00	0.40348E+00	0.26703E+00	0.96147E+00
0.24252E+04	0.66172E+00	0.40353E+00	0.26702E+00	0.96146E+00
0.24253E+04	0.66165E+00	0.40358E+00	0.26703E+00	0.96148E+00
0.24254E+04	0.66161E+00	0.40363E+00	0.26704E+00	0.96153E+00
0.24255E+04	0.66158E+00	0.40368E+00	0.26706E+00	0.96160E+00
0.24256E+04	0.66156E+00	0.40373E+00	0.26709E+00	0.96171E+00
0.24257E+04	0.66156E+00	0.40378E+00	0.26713E+00	0.96183E+00
0.24258E+04	0.66157E+00	0.40384E+00	0.26716E+00	0.96197E+00
0.24259E+04	0.66158E+00	0.40389E+00	0.26721E+00	0.96212E+00
0.24260E+04	0.66161E+00	0.40394E+00	0.26725E+00	0.96228E+00
0.24261E+04	0.66164E+00	0.40400E+00	0.26730E+00	0.96247E+00
0.24262E+04	0.66168E+00	0.40406E+00	0.26736E+00	0.96266E+00
0.24263E+04	0.66173E+00	0.40411E+00	0.26741E+00	0.96286E+00
0.24264E+04	0.66179E+00	0.40417E+00	0.26747E+00	0.96308E+00
0.24265E+04	0.66186E+00	0.40422E+00	0.26754E+00	0.96331E+00
0.24266E+04	0.66195E+00	0.40428E+00	0.26761E+00	0.96358E+00
0.24267E+04	0.66207E+00	0.40433E+00	0.26770E+00	0.96388E+00
0.24268E+04	0.66222E+00	0.40439E+00	0.26779E+00	0.96423E+00
0.24269E+04	0.66241E+00	0.40444E+00	0.26791E+00	0.96464E+00
0.24270E+04	0.66264E+00	0.40450E+00	0.26804E+00	0.96512E+00
0.24271E+04	0.66293E+00	0.40455E+00	0.26819E+00	0.96567E+00
0.24272E+04	0.66328E+00	0.40461E+00	0.26837E+00	0.96630E+00
0.24273E+04	0.66367E+00	0.40466E+00	0.26856E+00	0.96700E+00
0.24274E+04	0.66412E+00	0.40472E+00	0.26878E+00	0.96778E+00
0.24275E+04	0.66461E+00	0.40477E+00	0.26902E+00	0.96863E+00

0.24276E+04	0.66515E+00	0.40482E+00	0.26927E+00	0.96954E+00
0.24277E+04	0.66573E+00	0.40487E+00	0.26953E+00	0.97050E+00
0.24278E+04	0.66634E+00	0.40492E+00	0.26981E+00	0.97151E+00
0.24279E+04	0.66698E+00	0.40497E+00	0.27011E+00	0.97256E+00
0.24280E+04	0.66765E+00	0.40502E+00	0.27041E+00	0.97365E+00
0.24281E+04	0.66834E+00	0.40501E+00	0.27068E+00	0.97464E+00
0.24282E+04	0.66904E+00	0.40500E+00	0.27096E+00	0.97564E+00
0.24283E+04	0.66976E+00	0.40499E+00	0.27125E+00	0.97666E+00
0.24284E+04	0.67049E+00	0.40498E+00	0.27154E+00	0.97771E+00
0.24285E+04	0.67123E+00	0.40497E+00	0.27183E+00	0.97876E+00
0.24286E+04	0.67198E+00	0.40495E+00	0.27212E+00	0.97982E+00
0.24287E+04	0.67273E+00	0.40494E+00	0.27241E+00	0.98087E+00
0.24288E+04	0.67347E+00	0.40493E+00	0.27270E+00	0.98191E+00
0.24289E+04	0.67418E+00	0.40491E+00	0.27298E+00	0.98291E+00
0.24290E+04	0.67485E+00	0.40490E+00	0.27324E+00	0.98385E+00
0.24291E+04	0.67546E+00	0.40488E+00	0.27348E+00	0.98470E+00
0.24292E+04	0.67599E+00	0.40486E+00	0.27368E+00	0.98544E+00
0.24293E+04	0.67643E+00	0.40485E+00	0.27385E+00	0.98604E+00
0.24294E+04	0.67676E+00	0.40483E+00	0.27397E+00	0.98648E+00
0.24295E+04	0.67696E+00	0.40482E+00	0.27404E+00	0.98673E+00
0.24296E+04	0.67701E+00	0.40480E+00	0.27406E+00	0.98678E+00
0.24297E+04	0.67692E+00	0.40479E+00	0.27401E+00	0.98660E+00
0.24298E+04	0.67665E+00	0.40477E+00	0.27389E+00	0.98618E+00
0.24299E+04	0.67622E+00	0.40475E+00	0.27370E+00	0.98550E+00
0.24300E+04	0.67560E+00	0.40474E+00	0.27344E+00	0.98457E+00
0.24301E+04	0.67481E+00	0.40475E+00	0.27313E+00	0.98345E+00
0.24302E+04	0.67383E+00	0.40477E+00	0.27275E+00	0.98207E+00
0.24303E+04	0.67267E+00	0.40479E+00	0.27229E+00	0.98044E+00
0.24304E+04	0.67134E+00	0.40481E+00	0.27177E+00	0.97854E+00
0.24305E+04	0.66983E+00	0.40484E+00	0.27117E+00	0.97639E+00
0.24306E+04	0.66815E+00	0.40486E+00	0.27051E+00	0.97400E+00
0.24307E+04	0.66633E+00	0.40488E+00	0.26978E+00	0.97139E+00
0.24308E+04	0.66436E+00	0.40490E+00	0.26900E+00	0.96857E+00
0.24309E+04	0.66227E+00	0.40492E+00	0.26817E+00	0.96557E+00
0.24310E+04	0.66006E+00	0.40494E+00	0.26729E+00	0.96242E+00
0.24311E+04	0.65776E+00	0.40496E+00	0.26637E+00	0.95911E+00
0.24312E+04	0.65538E+00	0.40498E+00	0.26542E+00	0.95568E+00
0.24313E+04	0.65291E+00	0.40500E+00	0.26443E+00	0.95213E+00
0.24314E+04	0.65037E+00	0.40502E+00	0.26342E+00	0.94847E+00
0.24315E+04	0.64774E+00	0.40505E+00	0.26237E+00	0.94469E+00
0.24316E+04	0.64502E+00	0.40506E+00	0.26127E+00	0.94076E+00
0.24317E+04	0.64219E+00	0.40508E+00	0.26014E+00	0.93667E+00
0.24318E+04	0.63924E+00	0.40510E+00	0.25895E+00	0.93240E+00

0.24319E+04	0.63613E+00	0.40511E+00	0.25770E+00	0.92790E+00
0.24320E+04	0.63285E+00	0.40513E+00	0.25639E+00	0.92317E+00
0.24321E+04	0.62940E+00	0.40517E+00	0.25501E+00	0.91820E+00
0.24322E+04	0.62574E+00	0.40521E+00	0.25355E+00	0.91296E+00
0.24323E+04	0.62187E+00	0.40525E+00	0.25201E+00	0.90740E+00
0.24324E+04	0.61778E+00	0.40529E+00	0.25038E+00	0.90153E+00
0.24325E+04	0.61347E+00	0.40533E+00	0.24866E+00	0.89533E+00
0.24326E+04	0.60896E+00	0.40537E+00	0.24685E+00	0.88883E+00
0.24327E+04	0.60425E+00	0.40540E+00	0.24496E+00	0.88203E+00
0.24328E+04	0.59937E+00	0.40544E+00	0.24301E+00	0.87498E+00
0.24329E+04	0.59432E+00	0.40547E+00	0.24098E+00	0.86769E+00
0.24330E+04	0.58913E+00	0.40551E+00	0.23890E+00	0.86018E+00
0.24331E+04	0.58381E+00	0.40554E+00	0.23675E+00	0.85247E+00
0.24332E+04	0.57835E+00	0.40557E+00	0.23456E+00	0.84457E+00
0.24333E+04	0.57278E+00	0.40560E+00	0.23232E+00	0.83650E+00
0.24334E+04	0.56709E+00	0.40563E+00	0.23002E+00	0.82824E+00
0.24335E+04	0.56126E+00	0.40566E+00	0.22768E+00	0.81980E+00
0.24336E+04	0.55531E+00	0.40568E+00	0.22528E+00	0.81115E+00
0.24337E+04	0.54921E+00	0.40571E+00	0.22282E+00	0.80230E+00
0.24338E+04	0.54296E+00	0.40574E+00	0.22030E+00	0.79323E+00
0.24339E+04	0.53656E+00	0.40576E+00	0.21772E+00	0.78393E+00
0.24340E+04	0.53000E+00	0.40580E+00	0.21507E+00	0.77440E+00
0.24341E+04	0.52328E+00	0.40585E+00	0.21237E+00	0.76468E+00
0.24342E+04	0.51641E+00	0.40590E+00	0.20961E+00	0.75473E+00
0.24343E+04	0.50939E+00	0.40595E+00	0.20679E+00	0.74456E+00
0.24344E+04	0.50222E+00	0.40600E+00	0.20390E+00	0.73418E+00
0.24345E+04	0.49493E+00	0.40605E+00	0.20097E+00	0.72361E+00
0.24346E+04	0.48751E+00	0.40611E+00	0.19798E+00	0.71287E+00
0.24347E+04	0.47999E+00	0.40616E+00	0.19495E+00	0.70196E+00
0.24348E+04	0.47236E+00	0.40622E+00	0.19188E+00	0.69090E+00
0.24349E+04	0.46464E+00	0.40627E+00	0.18877E+00	0.67970E+00
0.24350E+04	0.45683E+00	0.40633E+00	0.18562E+00	0.66837E+00
0.24351E+04	0.44895E+00	0.40641E+00	0.18246E+00	0.65697E+00
0.24352E+04	0.44099E+00	0.40649E+00	0.17926E+00	0.64546E+00
0.24353E+04	0.43298E+00	0.40658E+00	0.17604E+00	0.63385E+00
0.24354E+04	0.42491E+00	0.40666E+00	0.17279E+00	0.62217E+00
0.24355E+04	0.41680E+00	0.40674E+00	0.16953E+00	0.61042E+00
0.24356E+04	0.40865E+00	0.40683E+00	0.16625E+00	0.59862E+00
0.24357E+04	0.40048E+00	0.40692E+00	0.16296E+00	0.58677E+00
0.24358E+04	0.39228E+00	0.40701E+00	0.15966E+00	0.57489E+00
0.24359E+04	0.38408E+00	0.40710E+00	0.15636E+00	0.56299E+00
0.24360E+04	0.37588E+00	0.40719E+00	0.15305E+00	0.55108E+00
0.24361E+04	0.36768E+00	0.40728E+00	0.14975E+00	0.53919E+00

0.24362E+04	0.35950E+00	0.40737E+00	0.14645E+00	0.52732E+00
0.24363E+04	0.35135E+00	0.40747E+00	0.14317E+00	0.51549E+00
0.24364E+04	0.34325E+00	0.40756E+00	0.13990E+00	0.50372E+00
0.24365E+04	0.33521E+00	0.40766E+00	0.13665E+00	0.49203E+00
0.24366E+04	0.32724E+00	0.40775E+00	0.13344E+00	0.48045E+00
0.24367E+04	0.31939E+00	0.40785E+00	0.13026E+00	0.46903E+00
0.24368E+04	0.31166E+00	0.40795E+00	0.12714E+00	0.45779E+00
0.24369E+04	0.30408E+00	0.40805E+00	0.12408E+00	0.44677E+00
0.24370E+04	0.29669E+00	0.40814E+00	0.12109E+00	0.43601E+00
0.24371E+04	0.28949E+00	0.40824E+00	0.11818E+00	0.42553E+00
0.24372E+04	0.28250E+00	0.40834E+00	0.11536E+00	0.41537E+00
0.24373E+04	0.27574E+00	0.40844E+00	0.11263E+00	0.40552E+00
0.24374E+04	0.26921E+00	0.40854E+00	0.10998E+00	0.39601E+00
0.24375E+04	0.26289E+00	0.40864E+00	0.10743E+00	0.38682E+00
0.24376E+04	0.25679E+00	0.40874E+00	0.10496E+00	0.37793E+00
0.24377E+04	0.25088E+00	0.40884E+00	0.10257E+00	0.36932E+00
0.24378E+04	0.24515E+00	0.40893E+00	0.10025E+00	0.36097E+00
0.24379E+04	0.23957E+00	0.40903E+00	0.97992E-01	0.35284E+00
0.24380E+04	0.23412E+00	0.40913E+00	0.95787E-01	0.34490E+00
0.24381E+04	0.22878E+00	0.40921E+00	0.93618E-01	0.33709E+00
0.24382E+04	0.22352E+00	0.40928E+00	0.91482E-01	0.32939E+00
0.24383E+04	0.21832E+00	0.40936E+00	0.89370E-01	0.32179E+00
0.24384E+04	0.21316E+00	0.40944E+00	0.87274E-01	0.31424E+00
0.24385E+04	0.20803E+00	0.40951E+00	0.85192E-01	0.30675E+00
0.24386E+04	0.20294E+00	0.40959E+00	0.83121E-01	0.29929E+00
0.24387E+04	0.19787E+00	0.40966E+00	0.81061E-01	0.29187E+00
0.24388E+04	0.19284E+00	0.40974E+00	0.79014E-01	0.28450E+00
0.24389E+04	0.18784E+00	0.40982E+00	0.76981E-01	0.27718E+00
0.24390E+04	0.18289E+00	0.40989E+00	0.74965E-01	0.26992E+00
0.24391E+04	0.17799E+00	0.40996E+00	0.72969E-01	0.26274E+00
0.24392E+04	0.17315E+00	0.41004E+00	0.70998E-01	0.25564E+00
0.24393E+04	0.16838E+00	0.41011E+00	0.69053E-01	0.24864E+00
0.24394E+04	0.16367E+00	0.41019E+00	0.67137E-01	0.24174E+00
0.24395E+04	0.15905E+00	0.41026E+00	0.65252E-01	0.23495E+00
0.24396E+04	0.15451E+00	0.41034E+00	0.63402E-01	0.22829E+00
0.24397E+04	0.15006E+00	0.41041E+00	0.61587E-01	0.22175E+00
0.24398E+04	0.14571E+00	0.41049E+00	0.59811E-01	0.21536E+00
0.24399E+04	0.14145E+00	0.41056E+00	0.58076E-01	0.20911E+00
0.24400E+04	0.13731E+00	0.41063E+00	0.56384E-01	0.20302E+00
0.24401E+04	0.13328E+00	0.41070E+00	0.54735E-01	0.19708E+00
0.24402E+04	0.12935E+00	0.41076E+00	0.53133E-01	0.19131E+00
0.24403E+04	0.12555E+00	0.41082E+00	0.51580E-01	0.18572E+00
0.24404E+04	0.12187E+00	0.41088E+00	0.50075E-01	0.18030E+00

0.24405E+04	0.11831E+00	0.41094E+00	0.48620E-01	0.17506E+00
0.24406E+04	0.11488E+00	0.41100E+00	0.47214E-01	0.17000E+00
0.24407E+04	0.11156E+00	0.41106E+00	0.45859E-01	0.16512E+00
0.24408E+04	0.10837E+00	0.41112E+00	0.44552E-01	0.16042E+00
0.24409E+04	0.10529E+00	0.41118E+00	0.43294E-01	0.15589E+00
0.24410E+04	0.10233E+00	0.41124E+00	0.42081E-01	0.15152E+00
0.24411E+04	0.99473E-01	0.41130E+00	0.40913E-01	0.14732E+00
0.24412E+04	0.96723E-01	0.41136E+00	0.39788E-01	0.14326E+00
0.24413E+04	0.94071E-01	0.41142E+00	0.38702E-01	0.13935E+00
0.24414E+04	0.91511E-01	0.41148E+00	0.37655E-01	0.13558E+00
0.24415E+04	0.89037E-01	0.41154E+00	0.36642E-01	0.13194E+00
0.24416E+04	0.86644E-01	0.41159E+00	0.35662E-01	0.12841E+00
0.24417E+04	0.84325E-01	0.41165E+00	0.34712E-01	0.12499E+00
0.24418E+04	0.82076E-01	0.41170E+00	0.33791E-01	0.12167E+00
0.24419E+04	0.79892E-01	0.41176E+00	0.32896E-01	0.11845E+00
0.24420E+04	0.77769E-01	0.41182E+00	0.32027E-01	0.11532E+00
0.24421E+04	0.75704E-01	0.41188E+00	0.31181E-01	0.11227E+00
0.24422E+04	0.73693E-01	0.41194E+00	0.30357E-01	0.10930E+00
0.24423E+04	0.71734E-01	0.41200E+00	0.29554E-01	0.10641E+00
0.24424E+04	0.69823E-01	0.41206E+00	0.28771E-01	0.10359E+00
0.24425E+04	0.67959E-01	0.41212E+00	0.28007E-01	0.10084E+00
0.24426E+04	0.66140E-01	0.41217E+00	0.27261E-01	0.98157E-01
0.24427E+04	0.64364E-01	0.41223E+00	0.26532E-01	0.95534E-01
0.24428E+04	0.62629E-01	0.41228E+00	0.25821E-01	0.92972E-01
0.24429E+04	0.60936E-01	0.41234E+00	0.25126E-01	0.90471E-01
0.24430E+04	0.59283E-01	0.41239E+00	0.24448E-01	0.88028E-01
0.24431E+04	0.57670E-01	0.41244E+00	0.23785E-01	0.85643E-01
0.24432E+04	0.56096E-01	0.41249E+00	0.23139E-01	0.83316E-01
0.24433E+04	0.54561E-01	0.41254E+00	0.22509E-01	0.81046E-01
0.24434E+04	0.53065E-01	0.41259E+00	0.21894E-01	0.78833E-01
0.24435E+04	0.51608E-01	0.41264E+00	0.21296E-01	0.76678E-01
0.24436E+04	0.50189E-01	0.41269E+00	0.20712E-01	0.74577E-01
0.24437E+04	0.48806E-01	0.41273E+00	0.20144E-01	0.72531E-01
0.24438E+04	0.47459E-01	0.41278E+00	0.19590E-01	0.70537E-01
0.24439E+04	0.46145E-01	0.41282E+00	0.19050E-01	0.68592E-01
0.24440E+04	0.44864E-01	0.41287E+00	0.18523E-01	0.66695E-01
0.24441E+04	0.43614E-01	0.41292E+00	0.18009E-01	0.64843E-01
0.24442E+04	0.42392E-01	0.41296E+00	0.17506E-01	0.63035E-01
0.24443E+04	0.41199E-01	0.41301E+00	0.17015E-01	0.61267E-01
0.24444E+04	0.40031E-01	0.41306E+00	0.16535E-01	0.59537E-01
0.24445E+04	0.38887E-01	0.41310E+00	0.16065E-01	0.57843E-01
0.24446E+04	0.37767E-01	0.41315E+00	0.15603E-01	0.56183E-01
0.24447E+04	0.36668E-01	0.41320E+00	0.15151E-01	0.54555E-01

0.24448E+04	0.35590E-01	0.41325E+00	0.14707E-01	0.52956E-01
0.24449E+04	0.34530E-01	0.41330E+00	0.14271E-01	0.51386E-01
0.24450E+04	0.33489E-01	0.41334E+00	0.13843E-01	0.49842E-01
0.24451E+04	0.30419E-01	0.41335E+00	0.12574E-01	0.45273E-01
0.24452E+04	0.29395E-01	0.41336E+00	0.12151E-01	0.43751E-01
0.24453E+04	0.28389E-01	0.41338E+00	0.11735E-01	0.42254E-01
0.24454E+04	0.27400E-01	0.41339E+00	0.11327E-01	0.40783E-01
0.24455E+04	0.26429E-01	0.41340E+00	0.10925E-01	0.39339E-01
0.24456E+04	0.25476E-01	0.41341E+00	0.10532E-01	0.37922E-01
0.24457E+04	0.24544E-01	0.41342E+00	0.10147E-01	0.36536E-01
0.24458E+04	0.23633E-01	0.41344E+00	0.97708E-02	0.35181E-01
0.24459E+04	0.22746E-01	0.41345E+00	0.94044E-02	0.33862E-01
0.24460E+04	0.21885E-01	0.41347E+00	0.90485E-02	0.32581E-01
0.24461E+04	0.21051E-01	0.41344E+00	0.87032E-02	0.31337E-01
0.24462E+04	0.20247E-01	0.41341E+00	0.83704E-02	0.30139E-01
0.24463E+04	0.19476E-01	0.41338E+00	0.80509E-02	0.28988E-01
0.24464E+04	0.18739E-01	0.41335E+00	0.77458E-02	0.27890E-01
0.24465E+04	0.18039E-01	0.41332E+00	0.74559E-02	0.26846E-01
0.24466E+04	0.17378E-01	0.41329E+00	0.71820E-02	0.25860E-01
0.24467E+04	0.16756E-01	0.41326E+00	0.69247E-02	0.24933E-01
0.24468E+04	0.16176E-01	0.41323E+00	0.66844E-02	0.24068E-01
0.24469E+04	0.15637E-01	0.41320E+00	0.64611E-02	0.23264E-01
0.24470E+04	0.15127E-01	0.41317E+00	0.62499E-02	0.22504E-01
0.24471E+04	0.14618E-01	0.41314E+00	0.60392E-02	0.21745E-01
0.24472E+04	0.14112E-01	0.41311E+00	0.58297E-02	0.20991E-01
0.24473E+04	0.13608E-01	0.41309E+00	0.56213E-02	0.20240E-01
0.24474E+04	0.13110E-01	0.41306E+00	0.54152E-02	0.19498E-01
0.24475E+04	0.12612E-01	0.41303E+00	0.52092E-02	0.18757E-01
0.24476E+04	0.12119E-01	0.41300E+00	0.50053E-02	0.18022E-01
0.24477E+04	0.11634E-01	0.41297E+00	0.48045E-02	0.17299E-01
0.24478E+04	0.11157E-01	0.41294E+00	0.46070E-02	0.16588E-01
0.24479E+04	0.10688E-01	0.41291E+00	0.44131E-02	0.15890E-01
0.24480E+04	0.10230E-01	0.41288E+00	0.42239E-02	0.15209E-01
0.24481E+04	0.97731E-02	0.41286E+00	0.40349E-02	0.14528E-01
0.24482E+04	0.93241E-02	0.41283E+00	0.38493E-02	0.13860E-01
0.24483E+04	0.88912E-02	0.41281E+00	0.36704E-02	0.13216E-01
0.24484E+04	0.84651E-02	0.41279E+00	0.34943E-02	0.12582E-01
0.24485E+04	0.80475E-02	0.41276E+00	0.33217E-02	0.11960E-01
0.24486E+04	0.76433E-02	0.41274E+00	0.31547E-02	0.11359E-01
0.24487E+04	0.72425E-02	0.41272E+00	0.29891E-02	0.10763E-01
0.24488E+04	0.68631E-02	0.41270E+00	0.28324E-02	0.10198E-01
0.24489E+04	0.64896E-02	0.41267E+00	0.26781E-02	0.96428E-02
0.24490E+04	0.61178E-02	0.41265E+00	0.25245E-02	0.90898E-02

0.24491E+04	0.57729E-02	0.41263E+00	0.23821E-02	0.85770E-02
0.24492E+04	0.54300E-02	0.41261E+00	0.22405E-02	0.80672E-02
0.24493E+04	0.50937E-02	0.41259E+00	0.21016E-02	0.75671E-02
0.24494E+04	0.47782E-02	0.41257E+00	0.19713E-02	0.70981E-02
0.24495E+04	0.44699E-02	0.41255E+00	0.18441E-02	0.66399E-02
0.24496E+04	0.41717E-02	0.41254E+00	0.17210E-02	0.61967E-02
0.24497E+04	0.38857E-02	0.41252E+00	0.16029E-02	0.57716E-02
0.24498E+04	0.36101E-02	0.41251E+00	0.14892E-02	0.53620E-02
0.24499E+04	0.33520E-02	0.41249E+00	0.13827E-02	0.49786E-02
0.24500E+04	0.30950E-02	0.41248E+00	0.12766E-02	0.45966E-02
0.24501E+04	0.28496E-02	0.41250E+00	0.11755E-02	0.42324E-02
0.24502E+04	0.26204E-02	0.41253E+00	0.10810E-02	0.38923E-02
0.24503E+04	0.24029E-02	0.41256E+00	0.99135E-03	0.35695E-02
0.24504E+04	0.21864E-02	0.41259E+00	0.90210E-03	0.32482E-02
0.24505E+04	0.19836E-02	0.41262E+00	0.81847E-03	0.29470E-02
0.24506E+04	0.17913E-02	0.41266E+00	0.73921E-03	0.26617E-02
0.24507E+04	0.16079E-02	0.41269E+00	0.66359E-03	0.23894E-02
0.24508E+04	0.14259E-02	0.41273E+00	0.58852E-03	0.21191E-02
0.24509E+04	0.12458E-02	0.41277E+00	0.51424E-03	0.18516E-02
0.24510E+04	0.10672E-02	0.41280E+00	0.44053E-03	0.15862E-02
0.24511E+04	0.89076E-03	0.41284E+00	0.36774E-03	0.13241E-02
0.24512E+04	0.71653E-03	0.41288E+00	0.29584E-03	0.10652E-02
0.24513E+04	0.54467E-03	0.41292E+00	0.22490E-03	0.80980E-03
0.24514E+04	0.37501E-03	0.41296E+00	0.15487E-03	0.55762E-03
0.24515E+04	0.20798E-03	0.41300E+00	0.85897E-04	0.30928E-03
0.24516E+04	0.49217E-04	0.41304E+00	0.20328E-04	0.73196E-04
0.24517E+04	0.00000E+00	0.41308E+00	0.00000E+00	0.00000E+00
Channel 18				
Wavenumber	HIRS Filter Transmittance	Optical Element Transmittance	Product of the HIRS Filter and Optical Element Transmittances	Normalized Value of Column 4
0.24674E+04	0.00000E+00	0.41791E+00	0.00000E+00	0.00000E+00
0.24675E+04	0.54029E-04	0.41794E+00	0.22581E-04	0.70161E-04
0.24676E+04	0.12084E-03	0.41797E+00	0.50506E-04	0.15693E-03
0.24677E+04	0.18774E-03	0.41800E+00	0.78475E-04	0.24383E-03
0.24678E+04	0.25523E-03	0.41804E+00	0.10670E-03	0.33152E-03
0.24679E+04	0.32329E-03	0.41807E+00	0.13516E-03	0.41995E-03
0.24680E+04	0.39158E-03	0.41809E+00	0.16372E-03	0.50868E-03
0.24681E+04	0.45988E-03	0.41811E+00	0.19228E-03	0.59744E-03
0.24682E+04	0.53083E-03	0.41812E+00	0.22195E-03	0.68963E-03
0.24683E+04	0.60219E-03	0.41813E+00	0.25180E-03	0.78236E-03
0.24684E+04	0.67453E-03	0.41815E+00	0.28205E-03	0.87636E-03

0.24685E+04	0.74783E-03	0.41816E+00	0.31271E-03	0.97163E-03
0.24686E+04	0.82146E-03	0.41817E+00	0.34351E-03	0.10673E-02
0.24687E+04	0.89531E-03	0.41818E+00	0.37440E-03	0.11633E-02
0.24688E+04	0.96952E-03	0.41819E+00	0.40544E-03	0.12597E-02
0.24689E+04	0.10437E-02	0.41820E+00	0.43649E-03	0.13562E-02
0.24690E+04	0.11181E-02	0.41821E+00	0.46760E-03	0.14529E-02
0.24691E+04	0.11940E-02	0.41822E+00	0.49935E-03	0.15515E-02
0.24692E+04	0.12701E-02	0.41822E+00	0.53120E-03	0.16505E-02
0.24693E+04	0.13472E-02	0.41823E+00	0.56345E-03	0.17507E-02
0.24694E+04	0.14247E-02	0.41823E+00	0.59587E-03	0.18514E-02
0.24695E+04	0.15038E-02	0.41824E+00	0.62895E-03	0.19542E-02
0.24696E+04	0.15837E-02	0.41824E+00	0.66237E-03	0.20581E-02
0.24697E+04	0.16642E-02	0.41824E+00	0.69603E-03	0.21626E-02
0.24698E+04	0.17447E-02	0.41824E+00	0.72970E-03	0.22672E-02
0.24699E+04	0.18255E-02	0.41824E+00	0.76351E-03	0.23723E-02
0.24700E+04	0.19067E-02	0.41824E+00	0.79748E-03	0.24778E-02
0.24701E+04	0.19884E-02	0.41824E+00	0.83161E-03	0.25839E-02
0.24702E+04	0.20702E-02	0.41823E+00	0.86580E-03	0.26901E-02
0.24703E+04	0.21522E-02	0.41822E+00	0.90010E-03	0.27967E-02
0.24704E+04	0.22343E-02	0.41821E+00	0.93443E-03	0.29034E-02
0.24705E+04	0.23169E-02	0.41821E+00	0.96894E-03	0.30106E-02
0.24706E+04	0.24000E-02	0.41820E+00	0.10037E-02	0.31186E-02
0.24707E+04	0.24837E-02	0.41820E+00	0.10387E-02	0.32273E-02
0.24708E+04	0.25674E-02	0.41819E+00	0.10737E-02	0.33360E-02
0.24709E+04	0.26520E-02	0.41819E+00	0.11090E-02	0.34458E-02
0.24710E+04	0.27377E-02	0.41818E+00	0.11448E-02	0.35571E-02
0.24711E+04	0.28235E-02	0.41818E+00	0.11807E-02	0.36687E-02
0.24712E+04	0.29094E-02	0.41818E+00	0.12167E-02	0.37803E-02
0.24713E+04	0.29955E-02	0.41819E+00	0.12527E-02	0.38922E-02
0.24714E+04	0.30820E-02	0.41819E+00	0.12889E-02	0.40046E-02
0.24715E+04	0.31686E-02	0.41819E+00	0.13250E-02	0.41171E-02
0.24716E+04	0.32561E-02	0.41819E+00	0.13617E-02	0.42309E-02
0.24717E+04	0.33439E-02	0.41820E+00	0.13984E-02	0.43450E-02
0.24718E+04	0.34319E-02	0.41821E+00	0.14353E-02	0.44595E-02
0.24719E+04	0.35203E-02	0.41822E+00	0.14722E-02	0.45744E-02
0.24720E+04	0.36089E-02	0.41822E+00	0.15093E-02	0.46897E-02
0.24721E+04	0.36976E-02	0.41826E+00	0.15466E-02	0.48054E-02
0.24722E+04	0.37869E-02	0.41830E+00	0.15841E-02	0.49219E-02
0.24723E+04	0.38771E-02	0.41834E+00	0.16220E-02	0.50396E-02
0.24724E+04	0.39674E-02	0.41838E+00	0.16599E-02	0.51574E-02
0.24725E+04	0.40579E-02	0.41843E+00	0.16979E-02	0.52757E-02
0.24726E+04	0.41497E-02	0.41847E+00	0.17365E-02	0.53955E-02
0.24727E+04	0.42424E-02	0.41851E+00	0.17755E-02	0.55166E-02

0.24728E+04	0.43364E-02	0.41856E+00	0.18150E-02	0.56395E-02
0.24729E+04	0.44314E-02	0.41860E+00	0.18550E-02	0.57636E-02
0.24730E+04	0.45281E-02	0.41865E+00	0.18957E-02	0.58900E-02
0.24731E+04	0.46249E-02	0.41869E+00	0.19364E-02	0.60167E-02
0.24732E+04	0.47235E-02	0.41874E+00	0.19779E-02	0.61455E-02
0.24733E+04	0.48242E-02	0.41879E+00	0.20203E-02	0.62772E-02
0.24734E+04	0.49248E-02	0.41883E+00	0.20627E-02	0.64090E-02
0.24735E+04	0.50256E-02	0.41888E+00	0.21051E-02	0.65408E-02
0.24736E+04	0.51265E-02	0.41893E+00	0.21476E-02	0.66729E-02
0.24737E+04	0.52275E-02	0.41897E+00	0.21902E-02	0.68051E-02
0.24738E+04	0.53288E-02	0.41902E+00	0.22328E-02	0.69376E-02
0.24739E+04	0.54315E-02	0.41906E+00	0.22761E-02	0.70721E-02
0.24740E+04	0.55345E-02	0.41911E+00	0.23195E-02	0.72070E-02
0.24741E+04	0.56382E-02	0.41913E+00	0.23632E-02	0.73426E-02
0.24742E+04	0.57420E-02	0.41915E+00	0.24068E-02	0.74781E-02
0.24743E+04	0.58463E-02	0.41918E+00	0.24506E-02	0.76144E-02
0.24744E+04	0.59508E-02	0.41920E+00	0.24946E-02	0.77509E-02
0.24745E+04	0.60567E-02	0.41922E+00	0.25391E-02	0.78892E-02
0.24746E+04	0.61638E-02	0.41923E+00	0.25841E-02	0.80290E-02
0.24747E+04	0.62712E-02	0.41925E+00	0.26292E-02	0.81691E-02
0.24748E+04	0.63788E-02	0.41927E+00	0.26744E-02	0.83096E-02
0.24749E+04	0.64880E-02	0.41928E+00	0.27203E-02	0.84523E-02
0.24750E+04	0.65975E-02	0.41930E+00	0.27663E-02	0.85953E-02
0.24751E+04	0.67071E-02	0.41934E+00	0.28125E-02	0.87388E-02
0.24752E+04	0.68170E-02	0.41937E+00	0.28589E-02	0.88827E-02
0.24753E+04	0.69272E-02	0.41941E+00	0.29054E-02	0.90273E-02
0.24754E+04	0.70380E-02	0.41945E+00	0.29521E-02	0.91724E-02
0.24755E+04	0.71492E-02	0.41949E+00	0.29990E-02	0.93181E-02
0.24756E+04	0.72624E-02	0.41952E+00	0.30467E-02	0.94665E-02
0.24757E+04	0.73756E-02	0.41956E+00	0.30945E-02	0.96148E-02
0.24758E+04	0.74915E-02	0.41959E+00	0.31434E-02	0.97668E-02
0.24759E+04	0.76090E-02	0.41963E+00	0.31929E-02	0.99207E-02
0.24760E+04	0.77276E-02	0.41966E+00	0.32430E-02	0.10076E-01
0.24761E+04	0.78474E-02	0.41968E+00	0.32934E-02	0.10233E-01
0.24762E+04	0.79683E-02	0.41971E+00	0.33443E-02	0.10391E-01
0.24763E+04	0.80904E-02	0.41973E+00	0.33958E-02	0.10551E-01
0.24764E+04	0.82129E-02	0.41975E+00	0.34474E-02	0.10711E-01
0.24765E+04	0.83367E-02	0.41978E+00	0.34996E-02	0.10873E-01
0.24766E+04	0.84625E-02	0.41980E+00	0.35526E-02	0.11038E-01
0.24767E+04	0.85898E-02	0.41983E+00	0.36062E-02	0.11205E-01
0.24768E+04	0.87182E-02	0.41985E+00	0.36603E-02	0.11373E-01
0.24769E+04	0.88469E-02	0.41987E+00	0.37146E-02	0.11541E-01
0.24770E+04	0.89759E-02	0.41990E+00	0.37689E-02	0.11710E-01

0.24771E+04	0.91051E-02	0.41992E+00	0.38234E-02	0.11880E-01
0.24772E+04	0.92352E-02	0.41994E+00	0.38783E-02	0.12050E-01
0.24773E+04	0.93673E-02	0.41997E+00	0.39340E-02	0.12223E-01
0.24774E+04	0.95004E-02	0.41999E+00	0.39901E-02	0.12398E-01
0.24775E+04	0.96369E-02	0.42001E+00	0.40476E-02	0.12576E-01
0.24776E+04	0.97745E-02	0.42004E+00	0.41057E-02	0.12757E-01
0.24777E+04	0.99133E-02	0.42006E+00	0.41642E-02	0.12939E-01
0.24778E+04	0.10053E-01	0.42009E+00	0.42234E-02	0.13122E-01
0.24779E+04	0.10194E-01	0.42011E+00	0.42828E-02	0.13307E-01
0.24780E+04	0.10336E-01	0.42014E+00	0.43428E-02	0.13493E-01
0.24781E+04	0.10480E-01	0.42017E+00	0.44033E-02	0.13681E-01
0.24782E+04	0.10628E-01	0.42021E+00	0.44661E-02	0.13877E-01
0.24783E+04	0.10777E-01	0.42024E+00	0.45291E-02	0.14072E-01
0.24784E+04	0.10927E-01	0.42028E+00	0.45923E-02	0.14269E-01
0.24785E+04	0.11077E-01	0.42031E+00	0.46557E-02	0.14466E-01
0.24786E+04	0.11227E-01	0.42035E+00	0.47195E-02	0.14664E-01
0.24787E+04	0.11379E-01	0.42038E+00	0.47837E-02	0.14863E-01
0.24788E+04	0.11532E-01	0.42042E+00	0.48481E-02	0.15064E-01
0.24789E+04	0.11689E-01	0.42045E+00	0.49148E-02	0.15271E-01
0.24790E+04	0.11852E-01	0.42049E+00	0.49837E-02	0.15485E-01
0.24791E+04	0.12015E-01	0.42052E+00	0.50526E-02	0.15699E-01
0.24792E+04	0.12178E-01	0.42055E+00	0.51215E-02	0.15913E-01
0.24793E+04	0.12342E-01	0.42059E+00	0.51908E-02	0.16128E-01
0.24794E+04	0.12506E-01	0.42062E+00	0.52601E-02	0.16344E-01
0.24795E+04	0.12672E-01	0.42065E+00	0.53305E-02	0.16562E-01
0.24796E+04	0.12840E-01	0.42068E+00	0.54016E-02	0.16783E-01
0.24797E+04	0.13009E-01	0.42071E+00	0.54730E-02	0.17005E-01
0.24798E+04	0.13179E-01	0.42074E+00	0.55448E-02	0.17228E-01
0.24799E+04	0.13351E-01	0.42077E+00	0.56178E-02	0.17455E-01
0.24800E+04	0.13524E-01	0.42081E+00	0.56910E-02	0.17683E-01
0.24801E+04	0.13698E-01	0.42086E+00	0.57651E-02	0.17913E-01
0.24802E+04	0.13874E-01	0.42091E+00	0.58397E-02	0.18144E-01
0.24803E+04	0.14049E-01	0.42097E+00	0.59142E-02	0.18376E-01
0.24804E+04	0.14226E-01	0.42102E+00	0.59892E-02	0.18609E-01
0.24805E+04	0.14403E-01	0.42107E+00	0.60647E-02	0.18844E-01
0.24806E+04	0.14586E-01	0.42112E+00	0.61427E-02	0.19086E-01
0.24807E+04	0.14771E-01	0.42117E+00	0.62213E-02	0.19330E-01
0.24808E+04	0.14963E-01	0.42122E+00	0.63027E-02	0.19583E-01
0.24809E+04	0.15155E-01	0.42126E+00	0.63843E-02	0.19837E-01
0.24810E+04	0.15352E-01	0.42131E+00	0.64678E-02	0.20096E-01
0.24811E+04	0.15548E-01	0.42136E+00	0.65514E-02	0.20356E-01
0.24812E+04	0.15751E-01	0.42140E+00	0.66377E-02	0.20624E-01
0.24813E+04	0.15956E-01	0.42145E+00	0.67246E-02	0.20894E-01

0.24814E+04	0.16161E-01	0.42149E+00	0.68118E-02	0.21165E-01
0.24815E+04	0.16367E-01	0.42154E+00	0.68993E-02	0.21437E-01
0.24816E+04	0.16575E-01	0.42158E+00	0.69878E-02	0.21712E-01
0.24817E+04	0.16787E-01	0.42162E+00	0.70778E-02	0.21992E-01
0.24818E+04	0.17000E-01	0.42166E+00	0.71683E-02	0.22273E-01
0.24819E+04	0.17224E-01	0.42171E+00	0.72634E-02	0.22568E-01
0.24820E+04	0.17452E-01	0.42175E+00	0.73605E-02	0.22870E-01
0.24821E+04	0.17687E-01	0.42180E+00	0.74604E-02	0.23180E-01
0.24822E+04	0.17922E-01	0.42185E+00	0.75605E-02	0.23491E-01
0.24823E+04	0.18159E-01	0.42190E+00	0.76615E-02	0.23805E-01
0.24824E+04	0.18399E-01	0.42196E+00	0.77634E-02	0.24122E-01
0.24825E+04	0.18644E-01	0.42201E+00	0.78681E-02	0.24447E-01
0.24826E+04	0.18902E-01	0.42206E+00	0.79781E-02	0.24789E-01
0.24827E+04	0.19179E-01	0.42212E+00	0.80957E-02	0.25154E-01
0.24828E+04	0.19459E-01	0.42218E+00	0.82150E-02	0.25525E-01
0.24829E+04	0.19747E-01	0.42223E+00	0.83377E-02	0.25906E-01
0.24830E+04	0.20037E-01	0.42229E+00	0.84613E-02	0.26290E-01
0.24831E+04	0.20328E-01	0.42235E+00	0.85855E-02	0.26676E-01
0.24832E+04	0.20624E-01	0.42241E+00	0.87119E-02	0.27069E-01
0.24833E+04	0.20922E-01	0.42247E+00	0.88388E-02	0.27463E-01
0.24834E+04	0.21225E-01	0.42253E+00	0.89684E-02	0.27866E-01
0.24835E+04	0.21529E-01	0.42260E+00	0.90981E-02	0.28269E-01
0.24836E+04	0.21838E-01	0.42266E+00	0.92300E-02	0.28678E-01
0.24837E+04	0.22148E-01	0.42273E+00	0.93628E-02	0.29091E-01
0.24838E+04	0.22459E-01	0.42280E+00	0.94958E-02	0.29504E-01
0.24839E+04	0.22772E-01	0.42287E+00	0.96296E-02	0.29920E-01
0.24840E+04	0.23087E-01	0.42293E+00	0.97640E-02	0.30338E-01
0.24841E+04	0.23402E-01	0.42298E+00	0.98987E-02	0.30756E-01
0.24842E+04	0.23729E-01	0.42304E+00	0.10038E-01	0.31189E-01
0.24843E+04	0.24061E-01	0.42309E+00	0.10180E-01	0.31630E-01
0.24844E+04	0.24396E-01	0.42314E+00	0.10323E-01	0.32074E-01
0.24845E+04	0.24731E-01	0.42320E+00	0.10466E-01	0.32519E-01
0.24846E+04	0.25069E-01	0.42325E+00	0.10610E-01	0.32968E-01
0.24847E+04	0.25411E-01	0.42331E+00	0.10757E-01	0.33422E-01
0.24848E+04	0.25755E-01	0.42336E+00	0.10904E-01	0.33879E-01
0.24849E+04	0.26100E-01	0.42342E+00	0.11051E-01	0.34338E-01
0.24850E+04	0.26448E-01	0.42348E+00	0.11200E-01	0.34800E-01
0.24851E+04	0.26800E-01	0.42353E+00	0.11351E-01	0.35268E-01
0.24852E+04	0.27153E-01	0.42358E+00	0.11501E-01	0.35736E-01
0.24853E+04	0.27506E-01	0.42363E+00	0.11652E-01	0.36205E-01
0.24854E+04	0.27875E-01	0.42369E+00	0.11810E-01	0.36696E-01
0.24855E+04	0.28247E-01	0.42374E+00	0.11969E-01	0.37190E-01
0.24856E+04	0.28631E-01	0.42379E+00	0.12133E-01	0.37699E-01

0.24857E+04	0.29019E-01	0.42384E+00	0.12299E-01	0.38215E-01
0.24858E+04	0.29410E-01	0.42389E+00	0.12467E-01	0.38735E-01
0.24859E+04	0.29806E-01	0.42394E+00	0.12636E-01	0.39262E-01
0.24860E+04	0.30221E-01	0.42399E+00	0.12813E-01	0.39813E-01
0.24861E+04	0.30662E-01	0.42404E+00	0.13002E-01	0.40398E-01
0.24862E+04	0.31126E-01	0.42409E+00	0.13200E-01	0.41014E-01
0.24863E+04	0.31601E-01	0.42413E+00	0.13403E-01	0.41645E-01
0.24864E+04	0.32084E-01	0.42418E+00	0.13610E-01	0.42286E-01
0.24865E+04	0.32573E-01	0.42423E+00	0.13818E-01	0.42934E-01
0.24866E+04	0.33085E-01	0.42427E+00	0.14037E-01	0.43614E-01
0.24867E+04	0.33631E-01	0.42432E+00	0.14270E-01	0.44340E-01
0.24868E+04	0.34211E-01	0.42436E+00	0.14518E-01	0.45109E-01
0.24869E+04	0.34823E-01	0.42441E+00	0.14779E-01	0.45920E-01
0.24870E+04	0.35457E-01	0.42445E+00	0.15050E-01	0.46762E-01
0.24871E+04	0.36109E-01	0.42449E+00	0.15328E-01	0.47626E-01
0.24872E+04	0.36772E-01	0.42453E+00	0.15611E-01	0.48505E-01
0.24873E+04	0.37442E-01	0.42457E+00	0.15897E-01	0.49393E-01
0.24874E+04	0.38119E-01	0.42461E+00	0.16186E-01	0.50291E-01
0.24875E+04	0.38796E-01	0.42466E+00	0.16475E-01	0.51189E-01
0.24876E+04	0.39478E-01	0.42469E+00	0.16766E-01	0.52094E-01
0.24877E+04	0.40167E-01	0.42473E+00	0.17060E-01	0.53008E-01
0.24878E+04	0.40873E-01	0.42477E+00	0.17362E-01	0.53945E-01
0.24879E+04	0.41591E-01	0.42481E+00	0.17668E-01	0.54898E-01
0.24880E+04	0.42301E-01	0.42485E+00	0.17972E-01	0.55840E-01
0.24881E+04	0.43003E-01	0.42492E+00	0.18273E-01	0.56776E-01
0.24882E+04	0.43704E-01	0.42499E+00	0.18573E-01	0.57710E-01
0.24883E+04	0.44406E-01	0.42505E+00	0.18875E-01	0.58646E-01
0.24884E+04	0.45101E-01	0.42512E+00	0.19173E-01	0.59573E-01
0.24885E+04	0.45791E-01	0.42519E+00	0.19470E-01	0.60495E-01
0.24886E+04	0.46504E-01	0.42526E+00	0.19776E-01	0.61446E-01
0.24887E+04	0.47243E-01	0.42532E+00	0.20094E-01	0.62433E-01
0.24888E+04	0.48009E-01	0.42539E+00	0.20423E-01	0.63455E-01
0.24889E+04	0.48791E-01	0.42546E+00	0.20759E-01	0.64500E-01
0.24890E+04	0.49575E-01	0.42553E+00	0.21096E-01	0.65546E-01
0.24891E+04	0.50351E-01	0.42560E+00	0.21430E-01	0.66584E-01
0.24892E+04	0.51107E-01	0.42567E+00	0.21755E-01	0.67595E-01
0.24893E+04	0.51856E-01	0.42574E+00	0.22077E-01	0.68596E-01
0.24894E+04	0.52624E-01	0.42582E+00	0.22408E-01	0.69624E-01
0.24895E+04	0.53412E-01	0.42589E+00	0.22747E-01	0.70679E-01
0.24896E+04	0.54227E-01	0.42596E+00	0.23098E-01	0.71769E-01
0.24897E+04	0.55078E-01	0.42603E+00	0.23465E-01	0.72909E-01
0.24898E+04	0.55972E-01	0.42611E+00	0.23850E-01	0.74105E-01
0.24899E+04	0.56910E-01	0.42618E+00	0.24254E-01	0.75360E-01

0.24900E+04	0.57886E-01	0.42624E+00	0.24674E-01	0.76663E-01
0.24901E+04	0.58905E-01	0.42627E+00	0.25110E-01	0.78019E-01
0.24902E+04	0.59970E-01	0.42631E+00	0.25565E-01	0.79434E-01
0.24903E+04	0.61061E-01	0.42634E+00	0.26032E-01	0.80885E-01
0.24904E+04	0.62168E-01	0.42637E+00	0.26507E-01	0.82358E-01
0.24905E+04	0.63282E-01	0.42640E+00	0.26983E-01	0.83839E-01
0.24906E+04	0.64405E-01	0.42643E+00	0.27464E-01	0.85333E-01
0.24907E+04	0.65557E-01	0.42646E+00	0.27957E-01	0.86866E-01
0.24908E+04	0.66731E-01	0.42649E+00	0.28460E-01	0.88427E-01
0.24909E+04	0.67911E-01	0.42652E+00	0.28965E-01	0.89998E-01
0.24910E+04	0.69105E-01	0.42655E+00	0.29477E-01	0.91587E-01
0.24911E+04	0.70311E-01	0.42658E+00	0.29993E-01	0.93192E-01
0.24912E+04	0.71525E-01	0.42661E+00	0.30513E-01	0.94808E-01
0.24913E+04	0.72753E-01	0.42664E+00	0.31039E-01	0.96442E-01
0.24914E+04	0.74009E-01	0.42667E+00	0.31577E-01	0.98113E-01
0.24915E+04	0.75303E-01	0.42669E+00	0.32132E-01	0.99836E-01
0.24916E+04	0.76636E-01	0.42672E+00	0.32702E-01	0.10161E+00
0.24917E+04	0.78007E-01	0.42675E+00	0.33289E-01	0.10343E+00
0.24918E+04	0.79423E-01	0.42678E+00	0.33896E-01	0.10532E+00
0.24919E+04	0.80867E-01	0.42680E+00	0.34514E-01	0.10724E+00
0.24920E+04	0.82320E-01	0.42683E+00	0.35137E-01	0.10917E+00
0.24921E+04	0.83789E-01	0.42686E+00	0.35766E-01	0.11113E+00
0.24922E+04	0.85294E-01	0.42689E+00	0.36411E-01	0.11313E+00
0.24923E+04	0.86846E-01	0.42692E+00	0.37076E-01	0.11520E+00
0.24924E+04	0.88437E-01	0.42695E+00	0.37758E-01	0.11732E+00
0.24925E+04	0.90061E-01	0.42698E+00	0.38454E-01	0.11948E+00
0.24926E+04	0.91710E-01	0.42701E+00	0.39161E-01	0.12168E+00
0.24927E+04	0.93374E-01	0.42704E+00	0.39874E-01	0.12389E+00
0.24928E+04	0.95053E-01	0.42707E+00	0.40594E-01	0.12613E+00
0.24929E+04	0.96748E-01	0.42710E+00	0.41321E-01	0.12839E+00
0.24930E+04	0.98461E-01	0.42713E+00	0.42055E-01	0.13067E+00
0.24931E+04	0.10020E+00	0.42716E+00	0.42802E-01	0.13299E+00
0.24932E+04	0.10197E+00	0.42719E+00	0.43559E-01	0.13534E+00
0.24933E+04	0.10377E+00	0.42722E+00	0.44332E-01	0.13774E+00
0.24934E+04	0.10563E+00	0.42725E+00	0.45128E-01	0.14022E+00
0.24935E+04	0.10754E+00	0.42728E+00	0.45951E-01	0.14277E+00
0.24936E+04	0.10953E+00	0.42731E+00	0.46802E-01	0.14542E+00
0.24937E+04	0.11156E+00	0.42735E+00	0.47674E-01	0.14813E+00
0.24938E+04	0.11363E+00	0.42738E+00	0.48565E-01	0.15089E+00
0.24939E+04	0.11575E+00	0.42741E+00	0.49472E-01	0.15372E+00
0.24940E+04	0.11790E+00	0.42744E+00	0.50395E-01	0.15658E+00
0.24941E+04	0.12009E+00	0.42752E+00	0.51341E-01	0.15952E+00
0.24942E+04	0.12231E+00	0.42760E+00	0.52300E-01	0.16250E+00

0.24943E+04	0.12455E+00	0.42769E+00	0.53270E-01	0.16551E+00
0.24944E+04	0.12680E+00	0.42777E+00	0.54240E-01	0.16853E+00
0.24945E+04	0.12904E+00	0.42786E+00	0.55210E-01	0.17154E+00
0.24946E+04	0.13130E+00	0.42794E+00	0.56188E-01	0.17458E+00
0.24947E+04	0.13360E+00	0.42803E+00	0.57184E-01	0.17768E+00
0.24948E+04	0.13596E+00	0.42812E+00	0.58206E-01	0.18085E+00
0.24949E+04	0.13837E+00	0.42820E+00	0.59252E-01	0.18410E+00
0.24950E+04	0.14082E+00	0.42829E+00	0.60312E-01	0.18740E+00
0.24951E+04	0.14330E+00	0.42834E+00	0.61379E-01	0.19071E+00
0.24952E+04	0.14578E+00	0.42840E+00	0.62452E-01	0.19405E+00
0.24953E+04	0.14828E+00	0.42845E+00	0.63529E-01	0.19739E+00
0.24954E+04	0.15078E+00	0.42851E+00	0.64611E-01	0.20075E+00
0.24955E+04	0.15330E+00	0.42857E+00	0.65699E-01	0.20413E+00
0.24956E+04	0.15583E+00	0.42862E+00	0.66791E-01	0.20752E+00
0.24957E+04	0.15836E+00	0.42868E+00	0.67887E-01	0.21093E+00
0.24958E+04	0.16092E+00	0.42873E+00	0.68990E-01	0.21436E+00
0.24959E+04	0.16349E+00	0.42879E+00	0.70102E-01	0.21781E+00
0.24960E+04	0.16607E+00	0.42884E+00	0.71218E-01	0.22128E+00
0.24961E+04	0.16865E+00	0.42886E+00	0.72326E-01	0.22472E+00
0.24962E+04	0.17122E+00	0.42888E+00	0.73433E-01	0.22816E+00
0.24963E+04	0.17381E+00	0.42890E+00	0.74547E-01	0.23162E+00
0.24964E+04	0.17645E+00	0.42892E+00	0.75682E-01	0.23515E+00
0.24965E+04	0.17914E+00	0.42894E+00	0.76841E-01	0.23875E+00
0.24966E+04	0.18190E+00	0.42895E+00	0.78028E-01	0.24244E+00
0.24967E+04	0.18474E+00	0.42897E+00	0.79246E-01	0.24622E+00
0.24968E+04	0.18761E+00	0.42899E+00	0.80483E-01	0.25007E+00
0.24969E+04	0.19051E+00	0.42900E+00	0.81731E-01	0.25394E+00
0.24970E+04	0.19342E+00	0.42902E+00	0.82980E-01	0.25783E+00
0.24971E+04	0.19632E+00	0.42904E+00	0.84230E-01	0.26171E+00
0.24972E+04	0.19925E+00	0.42905E+00	0.85488E-01	0.26562E+00
0.24973E+04	0.20221E+00	0.42907E+00	0.86762E-01	0.26958E+00
0.24974E+04	0.20522E+00	0.42908E+00	0.88056E-01	0.27360E+00
0.24975E+04	0.20828E+00	0.42910E+00	0.89371E-01	0.27768E+00
0.24976E+04	0.21139E+00	0.42911E+00	0.90711E-01	0.28185E+00
0.24977E+04	0.21455E+00	0.42913E+00	0.92070E-01	0.28607E+00
0.24978E+04	0.21774E+00	0.42915E+00	0.93441E-01	0.29033E+00
0.24979E+04	0.22095E+00	0.42917E+00	0.94823E-01	0.29462E+00
0.24980E+04	0.22416E+00	0.42918E+00	0.96206E-01	0.29892E+00
0.24981E+04	0.22738E+00	0.42914E+00	0.97576E-01	0.30318E+00
0.24982E+04	0.23060E+00	0.42909E+00	0.98950E-01	0.30745E+00
0.24983E+04	0.23384E+00	0.42905E+00	0.10033E+00	0.31174E+00
0.24984E+04	0.23711E+00	0.42901E+00	0.10172E+00	0.31606E+00
0.24985E+04	0.24042E+00	0.42896E+00	0.10313E+00	0.32044E+00

0.24986E+04	0.24377E+00	0.42892E+00	0.10456E+00	0.32487E+00
0.24987E+04	0.24716E+00	0.42888E+00	0.10600E+00	0.32937E+00
0.24988E+04	0.25059E+00	0.42884E+00	0.10747E+00	0.33390E+00
0.24989E+04	0.25403E+00	0.42881E+00	0.10893E+00	0.33846E+00
0.24990E+04	0.25746E+00	0.42877E+00	0.11039E+00	0.34300E+00
0.24991E+04	0.26087E+00	0.42874E+00	0.11185E+00	0.34752E+00
0.24992E+04	0.26427E+00	0.42870E+00	0.11329E+00	0.35201E+00
0.24993E+04	0.26764E+00	0.42867E+00	0.11473E+00	0.35648E+00
0.24994E+04	0.27102E+00	0.42864E+00	0.11617E+00	0.36096E+00
0.24995E+04	0.27444E+00	0.42861E+00	0.11762E+00	0.36547E+00
0.24996E+04	0.27788E+00	0.42858E+00	0.11910E+00	0.37004E+00
0.24997E+04	0.28135E+00	0.42855E+00	0.12057E+00	0.37464E+00
0.24998E+04	0.28482E+00	0.42852E+00	0.12205E+00	0.37923E+00
0.24999E+04	0.28827E+00	0.42850E+00	0.12352E+00	0.38380E+00
0.25000E+04	0.29171E+00	0.42847E+00	0.12499E+00	0.38836E+00
0.25001E+04	0.29517E+00	0.42849E+00	0.12648E+00	0.39298E+00
0.25002E+04	0.29864E+00	0.42851E+00	0.12797E+00	0.39762E+00
0.25003E+04	0.30214E+00	0.42853E+00	0.12948E+00	0.40230E+00
0.25004E+04	0.30568E+00	0.42855E+00	0.13100E+00	0.40703E+00
0.25005E+04	0.30925E+00	0.42857E+00	0.13254E+00	0.41180E+00
0.25006E+04	0.31285E+00	0.42859E+00	0.13408E+00	0.41661E+00
0.25007E+04	0.31647E+00	0.42861E+00	0.13564E+00	0.42145E+00
0.25008E+04	0.32009E+00	0.42863E+00	0.13720E+00	0.42630E+00
0.25009E+04	0.32371E+00	0.42865E+00	0.13876E+00	0.43113E+00
0.25010E+04	0.32732E+00	0.42866E+00	0.14031E+00	0.43595E+00
0.25011E+04	0.33090E+00	0.42868E+00	0.14185E+00	0.44074E+00
0.25012E+04	0.33447E+00	0.42869E+00	0.14338E+00	0.44550E+00
0.25013E+04	0.33800E+00	0.42870E+00	0.14490E+00	0.45023E+00
0.25014E+04	0.34152E+00	0.42871E+00	0.14641E+00	0.45492E+00
0.25015E+04	0.34503E+00	0.42872E+00	0.14792E+00	0.45960E+00
0.25016E+04	0.34853E+00	0.42873E+00	0.14942E+00	0.46428E+00
0.25017E+04	0.35204E+00	0.42872E+00	0.15093E+00	0.46895E+00
0.25018E+04	0.35555E+00	0.42872E+00	0.15243E+00	0.47363E+00
0.25019E+04	0.35908E+00	0.42872E+00	0.15395E+00	0.47832E+00
0.25020E+04	0.36260E+00	0.42872E+00	0.15546E+00	0.48301E+00
0.25021E+04	0.36610E+00	0.42874E+00	0.15696E+00	0.48770E+00
0.25022E+04	0.36959E+00	0.42876E+00	0.15847E+00	0.49237E+00
0.25023E+04	0.37310E+00	0.42879E+00	0.15998E+00	0.49707E+00
0.25024E+04	0.37662E+00	0.42881E+00	0.16150E+00	0.50180E+00
0.25025E+04	0.38017E+00	0.42883E+00	0.16303E+00	0.50655E+00
0.25026E+04	0.38371E+00	0.42885E+00	0.16455E+00	0.51127E+00
0.25027E+04	0.38721E+00	0.42886E+00	0.16606E+00	0.51596E+00
0.25028E+04	0.39069E+00	0.42887E+00	0.16756E+00	0.52061E+00

0.25029E+04	0.39414E+00	0.42889E+00	0.16904E+00	0.52522E+00
0.25030E+04	0.39755E+00	0.42890E+00	0.17051E+00	0.52979E+00
0.25031E+04	0.40096E+00	0.42891E+00	0.17198E+00	0.53435E+00
0.25032E+04	0.40435E+00	0.42892E+00	0.17343E+00	0.53888E+00
0.25033E+04	0.40771E+00	0.42893E+00	0.17488E+00	0.54336E+00
0.25034E+04	0.41104E+00	0.42894E+00	0.17631E+00	0.54781E+00
0.25035E+04	0.41435E+00	0.42894E+00	0.17773E+00	0.55223E+00
0.25036E+04	0.41763E+00	0.42895E+00	0.17915E+00	0.55662E+00
0.25037E+04	0.42091E+00	0.42896E+00	0.18056E+00	0.56100E+00
0.25038E+04	0.42417E+00	0.42897E+00	0.18196E+00	0.56536E+00
0.25039E+04	0.42740E+00	0.42898E+00	0.18335E+00	0.56968E+00
0.25040E+04	0.43062E+00	0.42899E+00	0.18473E+00	0.57397E+00
0.25041E+04	0.43381E+00	0.42901E+00	0.18611E+00	0.57826E+00
0.25042E+04	0.43699E+00	0.42902E+00	0.18748E+00	0.58251E+00
0.25043E+04	0.44015E+00	0.42904E+00	0.18884E+00	0.58675E+00
0.25044E+04	0.44331E+00	0.42906E+00	0.19021E+00	0.59099E+00
0.25045E+04	0.44648E+00	0.42907E+00	0.19157E+00	0.59523E+00
0.25046E+04	0.44965E+00	0.42910E+00	0.19294E+00	0.59950E+00
0.25047E+04	0.45283E+00	0.42913E+00	0.19432E+00	0.60377E+00
0.25048E+04	0.45601E+00	0.42915E+00	0.19570E+00	0.60806E+00
0.25049E+04	0.45920E+00	0.42918E+00	0.19708E+00	0.61234E+00
0.25050E+04	0.46237E+00	0.42920E+00	0.19845E+00	0.61661E+00
0.25051E+04	0.46553E+00	0.42926E+00	0.19983E+00	0.62091E+00
0.25052E+04	0.46866E+00	0.42932E+00	0.20121E+00	0.62516E+00
0.25053E+04	0.47176E+00	0.42938E+00	0.20257E+00	0.62939E+00
0.25054E+04	0.47482E+00	0.42944E+00	0.20391E+00	0.63355E+00
0.25055E+04	0.47784E+00	0.42950E+00	0.20523E+00	0.63768E+00
0.25056E+04	0.48086E+00	0.42957E+00	0.20656E+00	0.64182E+00
0.25057E+04	0.48388E+00	0.42964E+00	0.20790E+00	0.64596E+00
0.25058E+04	0.48690E+00	0.42971E+00	0.20923E+00	0.65009E+00
0.25059E+04	0.48989E+00	0.42978E+00	0.21055E+00	0.65419E+00
0.25060E+04	0.49285E+00	0.42985E+00	0.21185E+00	0.65824E+00
0.25061E+04	0.49577E+00	0.42989E+00	0.21313E+00	0.66221E+00
0.25062E+04	0.49867E+00	0.42993E+00	0.21440E+00	0.66615E+00
0.25063E+04	0.50156E+00	0.42997E+00	0.21566E+00	0.67007E+00
0.25064E+04	0.50445E+00	0.43001E+00	0.21692E+00	0.67398E+00
0.25065E+04	0.50733E+00	0.43005E+00	0.21818E+00	0.67790E+00
0.25066E+04	0.51019E+00	0.43009E+00	0.21943E+00	0.68178E+00
0.25067E+04	0.51300E+00	0.43014E+00	0.22066E+00	0.68561E+00
0.25068E+04	0.51578E+00	0.43018E+00	0.22188E+00	0.68939E+00
0.25069E+04	0.51853E+00	0.43022E+00	0.22308E+00	0.69313E+00
0.25070E+04	0.52125E+00	0.43026E+00	0.22427E+00	0.69683E+00
0.25071E+04	0.52396E+00	0.43030E+00	0.22546E+00	0.70052E+00

0.25072E+04	0.52667E+00	0.43034E+00	0.22664E+00	0.70421E+00
0.25073E+04	0.52937E+00	0.43038E+00	0.22783E+00	0.70789E+00
0.25074E+04	0.53209E+00	0.43042E+00	0.22902E+00	0.71159E+00
0.25075E+04	0.53483E+00	0.43045E+00	0.23022E+00	0.71532E+00
0.25076E+04	0.53758E+00	0.43049E+00	0.23142E+00	0.71905E+00
0.25077E+04	0.54031E+00	0.43052E+00	0.23261E+00	0.72276E+00
0.25078E+04	0.54298E+00	0.43056E+00	0.23379E+00	0.72639E+00
0.25079E+04	0.54562E+00	0.43059E+00	0.23494E+00	0.72998E+00
0.25080E+04	0.54822E+00	0.43063E+00	0.23608E+00	0.73352E+00
0.25081E+04	0.55080E+00	0.43068E+00	0.23722E+00	0.73706E+00
0.25082E+04	0.55337E+00	0.43075E+00	0.23836E+00	0.74062E+00
0.25083E+04	0.55594E+00	0.43082E+00	0.23951E+00	0.74418E+00
0.25084E+04	0.55850E+00	0.43089E+00	0.24065E+00	0.74772E+00
0.25085E+04	0.56104E+00	0.43096E+00	0.24178E+00	0.75125E+00
0.25086E+04	0.56359E+00	0.43102E+00	0.24292E+00	0.75477E+00
0.25087E+04	0.56615E+00	0.43108E+00	0.24406E+00	0.75831E+00
0.25088E+04	0.56871E+00	0.43115E+00	0.24520E+00	0.76185E+00
0.25089E+04	0.57126E+00	0.43121E+00	0.24634E+00	0.76539E+00
0.25090E+04	0.57381E+00	0.43127E+00	0.24747E+00	0.76891E+00
0.25091E+04	0.57634E+00	0.43134E+00	0.24860E+00	0.77242E+00
0.25092E+04	0.57886E+00	0.43140E+00	0.24972E+00	0.77590E+00
0.25093E+04	0.58134E+00	0.43146E+00	0.25082E+00	0.77934E+00
0.25094E+04	0.58379E+00	0.43152E+00	0.25192E+00	0.78273E+00
0.25095E+04	0.58621E+00	0.43158E+00	0.25300E+00	0.78609E+00
0.25096E+04	0.58861E+00	0.43164E+00	0.25407E+00	0.78941E+00
0.25097E+04	0.59098E+00	0.43170E+00	0.25513E+00	0.79270E+00
0.25098E+04	0.59333E+00	0.43176E+00	0.25618E+00	0.79597E+00
0.25099E+04	0.59569E+00	0.43182E+00	0.25723E+00	0.79924E+00
0.25100E+04	0.59803E+00	0.43188E+00	0.25828E+00	0.80249E+00
0.25101E+04	0.60034E+00	0.43196E+00	0.25932E+00	0.80574E+00
0.25102E+04	0.60265E+00	0.43203E+00	0.26036E+00	0.80897E+00
0.25103E+04	0.60495E+00	0.43211E+00	0.26141E+00	0.81221E+00
0.25104E+04	0.60725E+00	0.43219E+00	0.26244E+00	0.81544E+00
0.25105E+04	0.60949E+00	0.43226E+00	0.26346E+00	0.81860E+00
0.25106E+04	0.61169E+00	0.43234E+00	0.26446E+00	0.82169E+00
0.25107E+04	0.61384E+00	0.43242E+00	0.26543E+00	0.82473E+00
0.25108E+04	0.61596E+00	0.43249E+00	0.26640E+00	0.82772E+00
0.25109E+04	0.61808E+00	0.43257E+00	0.26736E+00	0.83072E+00
0.25110E+04	0.62021E+00	0.43265E+00	0.26833E+00	0.83374E+00
0.25111E+04	0.62237E+00	0.43273E+00	0.26931E+00	0.83678E+00
0.25112E+04	0.62452E+00	0.43280E+00	0.27029E+00	0.83983E+00
0.25113E+04	0.62666E+00	0.43288E+00	0.27127E+00	0.84286E+00
0.25114E+04	0.62882E+00	0.43296E+00	0.27226E+00	0.84593E+00

0.25115E+04	0.63101E+00	0.43304E+00	0.27325E+00	0.84903E+00
0.25116E+04	0.63322E+00	0.43312E+00	0.27426E+00	0.85215E+00
0.25117E+04	0.63542E+00	0.43320E+00	0.27526E+00	0.85526E+00
0.25118E+04	0.63759E+00	0.43328E+00	0.27625E+00	0.85834E+00
0.25119E+04	0.63972E+00	0.43335E+00	0.27722E+00	0.86136E+00
0.25120E+04	0.64182E+00	0.43343E+00	0.27818E+00	0.86434E+00
0.25121E+04	0.64388E+00	0.43350E+00	0.27912E+00	0.86725E+00
0.25122E+04	0.64592E+00	0.43356E+00	0.28004E+00	0.87012E+00
0.25123E+04	0.64794E+00	0.43362E+00	0.28096E+00	0.87297E+00
0.25124E+04	0.64996E+00	0.43368E+00	0.28188E+00	0.87582E+00
0.25125E+04	0.65199E+00	0.43375E+00	0.28280E+00	0.87868E+00
0.25126E+04	0.65404E+00	0.43381E+00	0.28373E+00	0.88158E+00
0.25127E+04	0.65611E+00	0.43387E+00	0.28467E+00	0.88448E+00
0.25128E+04	0.65816E+00	0.43393E+00	0.28560E+00	0.88738E+00
0.25129E+04	0.66018E+00	0.43399E+00	0.28651E+00	0.89022E+00
0.25130E+04	0.66215E+00	0.43406E+00	0.28741E+00	0.89302E+00
0.25131E+04	0.66414E+00	0.43412E+00	0.28832E+00	0.89583E+00
0.25132E+04	0.66616E+00	0.43418E+00	0.28924E+00	0.89868E+00
0.25133E+04	0.66821E+00	0.43424E+00	0.29017E+00	0.90158E+00
0.25134E+04	0.67024E+00	0.43431E+00	0.29109E+00	0.90444E+00
0.25135E+04	0.67221E+00	0.43437E+00	0.29199E+00	0.90723E+00
0.25136E+04	0.67413E+00	0.43443E+00	0.29286E+00	0.90995E+00
0.25137E+04	0.67601E+00	0.43449E+00	0.29372E+00	0.91263E+00
0.25138E+04	0.67789E+00	0.43456E+00	0.29458E+00	0.91529E+00
0.25139E+04	0.67977E+00	0.43462E+00	0.29544E+00	0.91796E+00
0.25140E+04	0.68164E+00	0.43468E+00	0.29630E+00	0.92063E+00
0.25141E+04	0.68349E+00	0.43478E+00	0.29717E+00	0.92333E+00
0.25142E+04	0.68531E+00	0.43489E+00	0.29803E+00	0.92601E+00
0.25143E+04	0.68711E+00	0.43500E+00	0.29889E+00	0.92868E+00
0.25144E+04	0.68891E+00	0.43510E+00	0.29975E+00	0.93135E+00
0.25145E+04	0.69071E+00	0.43521E+00	0.30060E+00	0.93401E+00
0.25146E+04	0.69247E+00	0.43532E+00	0.30145E+00	0.93663E+00
0.25147E+04	0.69421E+00	0.43543E+00	0.30228E+00	0.93922E+00
0.25148E+04	0.69591E+00	0.43554E+00	0.30310E+00	0.94176E+00
0.25149E+04	0.69758E+00	0.43565E+00	0.30390E+00	0.94425E+00
0.25150E+04	0.69923E+00	0.43576E+00	0.30470E+00	0.94672E+00
0.25151E+04	0.70086E+00	0.43586E+00	0.30548E+00	0.94914E+00
0.25152E+04	0.70245E+00	0.43596E+00	0.30624E+00	0.95150E+00
0.25153E+04	0.70400E+00	0.43606E+00	0.30698E+00	0.95382E+00
0.25154E+04	0.70552E+00	0.43615E+00	0.30772E+00	0.95610E+00
0.25155E+04	0.70703E+00	0.43625E+00	0.30844E+00	0.95835E+00
0.25156E+04	0.70850E+00	0.43634E+00	0.30915E+00	0.96056E+00
0.25157E+04	0.70996E+00	0.43644E+00	0.30985E+00	0.96274E+00

0.25158E+04	0.71139E+00	0.43653E+00	0.31054E+00	0.96489E+00
0.25159E+04	0.71279E+00	0.43663E+00	0.31122E+00	0.96700E+00
0.25160E+04	0.71417E+00	0.43671E+00	0.31189E+00	0.96906E+00
0.25161E+04	0.71554E+00	0.43675E+00	0.31251E+00	0.97100E+00
0.25162E+04	0.71686E+00	0.43679E+00	0.31312E+00	0.97289E+00
0.25163E+04	0.71812E+00	0.43683E+00	0.31369E+00	0.97468E+00
0.25164E+04	0.71930E+00	0.43686E+00	0.31424E+00	0.97636E+00
0.25165E+04	0.72043E+00	0.43690E+00	0.31476E+00	0.97798E+00
0.25166E+04	0.72153E+00	0.43693E+00	0.31526E+00	0.97955E+00
0.25167E+04	0.72260E+00	0.43696E+00	0.31575E+00	0.98107E+00
0.25168E+04	0.72363E+00	0.43699E+00	0.31622E+00	0.98254E+00
0.25169E+04	0.72462E+00	0.43702E+00	0.31668E+00	0.98395E+00
0.25170E+04	0.72558E+00	0.43706E+00	0.31712E+00	0.98531E+00
0.25171E+04	0.72650E+00	0.43708E+00	0.31753E+00	0.98661E+00
0.25172E+04	0.72738E+00	0.43710E+00	0.31794E+00	0.98786E+00
0.25173E+04	0.72824E+00	0.43712E+00	0.31833E+00	0.98907E+00
0.25174E+04	0.72903E+00	0.43714E+00	0.31869E+00	0.99019E+00
0.25175E+04	0.72975E+00	0.43716E+00	0.31902E+00	0.99121E+00
0.25176E+04	0.73039E+00	0.43717E+00	0.31931E+00	0.99212E+00
0.25177E+04	0.73100E+00	0.43719E+00	0.31959E+00	0.99298E+00
0.25178E+04	0.73160E+00	0.43720E+00	0.31986E+00	0.99382E+00
0.25179E+04	0.73218E+00	0.43722E+00	0.32012E+00	0.99464E+00
0.25180E+04	0.73273E+00	0.43723E+00	0.32037E+00	0.99542E+00
0.25181E+04	0.73324E+00	0.43722E+00	0.32058E+00	0.99608E+00
0.25182E+04	0.73370E+00	0.43721E+00	0.32078E+00	0.99669E+00
0.25183E+04	0.73413E+00	0.43720E+00	0.32096E+00	0.99726E+00
0.25184E+04	0.73456E+00	0.43719E+00	0.32114E+00	0.99781E+00
0.25185E+04	0.73495E+00	0.43718E+00	0.32130E+00	0.99832E+00
0.25186E+04	0.73529E+00	0.43717E+00	0.32145E+00	0.99877E+00
0.25187E+04	0.73557E+00	0.43716E+00	0.32156E+00	0.99912E+00
0.25188E+04	0.73579E+00	0.43715E+00	0.32165E+00	0.99940E+00
0.25189E+04	0.73597E+00	0.43714E+00	0.32172E+00	0.99962E+00
0.25190E+04	0.73611E+00	0.43713E+00	0.32177E+00	0.99978E+00
0.25191E+04	0.73620E+00	0.43713E+00	0.32181E+00	0.99990E+00
0.25192E+04	0.73626E+00	0.43712E+00	0.32184E+00	0.99998E+00
0.25193E+04	0.73628E+00	0.43712E+00	0.32184E+00	0.10000E+01
0.25194E+04	0.73626E+00	0.43712E+00	0.32183E+00	0.99997E+00
0.25195E+04	0.73623E+00	0.43711E+00	0.32182E+00	0.99991E+00
0.25196E+04	0.73619E+00	0.43712E+00	0.32180E+00	0.99988E+00
0.25197E+04	0.73613E+00	0.43713E+00	0.32178E+00	0.99981E+00
0.25198E+04	0.73603E+00	0.43713E+00	0.32174E+00	0.99969E+00
0.25199E+04	0.73588E+00	0.43714E+00	0.32168E+00	0.99950E+00
0.25200E+04	0.73569E+00	0.43715E+00	0.32161E+00	0.99927E+00

0.25201E+04	0.73546E+00	0.43721E+00	0.32155E+00	0.99909E+00
0.25202E+04	0.73518E+00	0.43727E+00	0.32147E+00	0.99885E+00
0.25203E+04	0.73486E+00	0.43733E+00	0.32138E+00	0.99855E+00
0.25204E+04	0.73453E+00	0.43739E+00	0.32128E+00	0.99824E+00
0.25205E+04	0.73418E+00	0.43745E+00	0.32117E+00	0.99791E+00
0.25206E+04	0.73382E+00	0.43753E+00	0.32107E+00	0.99758E+00
0.25207E+04	0.73343E+00	0.43760E+00	0.32095E+00	0.99722E+00
0.25208E+04	0.73301E+00	0.43767E+00	0.32082E+00	0.99681E+00
0.25209E+04	0.73252E+00	0.43774E+00	0.32066E+00	0.99631E+00
0.25210E+04	0.73195E+00	0.43781E+00	0.32046E+00	0.99569E+00
0.25211E+04	0.73130E+00	0.43789E+00	0.32023E+00	0.99498E+00
0.25212E+04	0.73059E+00	0.43797E+00	0.31998E+00	0.99420E+00
0.25213E+04	0.72983E+00	0.43805E+00	0.31970E+00	0.99335E+00
0.25214E+04	0.72900E+00	0.43814E+00	0.31940E+00	0.99240E+00
0.25215E+04	0.72811E+00	0.43822E+00	0.31907E+00	0.99138E+00
0.25216E+04	0.72720E+00	0.43830E+00	0.31873E+00	0.99033E+00
0.25217E+04	0.72627E+00	0.43839E+00	0.31838E+00	0.98925E+00
0.25218E+04	0.72531E+00	0.43847E+00	0.31803E+00	0.98814E+00
0.25219E+04	0.72434E+00	0.43856E+00	0.31766E+00	0.98701E+00
0.25220E+04	0.72333E+00	0.43864E+00	0.31728E+00	0.98583E+00
0.25221E+04	0.72230E+00	0.43869E+00	0.31687E+00	0.98454E+00
0.25222E+04	0.72124E+00	0.43875E+00	0.31644E+00	0.98321E+00
0.25223E+04	0.72017E+00	0.43880E+00	0.31601E+00	0.98186E+00
0.25224E+04	0.71909E+00	0.43885E+00	0.31557E+00	0.98051E+00
0.25225E+04	0.71798E+00	0.43890E+00	0.31513E+00	0.97913E+00
0.25226E+04	0.71681E+00	0.43895E+00	0.31465E+00	0.97764E+00
0.25227E+04	0.71557E+00	0.43900E+00	0.31413E+00	0.97604E+00
0.25228E+04	0.71427E+00	0.43905E+00	0.31360E+00	0.97437E+00
0.25229E+04	0.71293E+00	0.43909E+00	0.31305E+00	0.97266E+00
0.25230E+04	0.71158E+00	0.43914E+00	0.31248E+00	0.97092E+00
0.25231E+04	0.71020E+00	0.43918E+00	0.31191E+00	0.96913E+00
0.25232E+04	0.70880E+00	0.43922E+00	0.31132E+00	0.96730E+00
0.25233E+04	0.70735E+00	0.43926E+00	0.31071E+00	0.96542E+00
0.25234E+04	0.70586E+00	0.43931E+00	0.31009E+00	0.96348E+00
0.25235E+04	0.70433E+00	0.43935E+00	0.30944E+00	0.96147E+00
0.25236E+04	0.70276E+00	0.43938E+00	0.30878E+00	0.95941E+00
0.25237E+04	0.70117E+00	0.43942E+00	0.30811E+00	0.95732E+00
0.25238E+04	0.69955E+00	0.43945E+00	0.30741E+00	0.95517E+00
0.25239E+04	0.69789E+00	0.43948E+00	0.30671E+00	0.95298E+00
0.25240E+04	0.69622E+00	0.43952E+00	0.30600E+00	0.95079E+00
0.25241E+04	0.69451E+00	0.43959E+00	0.30530E+00	0.94860E+00
0.25242E+04	0.69275E+00	0.43965E+00	0.30457E+00	0.94632E+00
0.25243E+04	0.69090E+00	0.43972E+00	0.30380E+00	0.94393E+00

0.25244E+04	0.68898E+00	0.43978E+00	0.30300E+00	0.94145E+00
0.25245E+04	0.68703E+00	0.43985E+00	0.30219E+00	0.93893E+00
0.25246E+04	0.68510E+00	0.43991E+00	0.30138E+00	0.93643E+00
0.25247E+04	0.68320E+00	0.43997E+00	0.30059E+00	0.93395E+00
0.25248E+04	0.68129E+00	0.44003E+00	0.29979E+00	0.93148E+00
0.25249E+04	0.67935E+00	0.44010E+00	0.29898E+00	0.92896E+00
0.25250E+04	0.67735E+00	0.44016E+00	0.29814E+00	0.92636E+00
0.25251E+04	0.67530E+00	0.44023E+00	0.29729E+00	0.92370E+00
0.25252E+04	0.67323E+00	0.44030E+00	0.29642E+00	0.92100E+00
0.25253E+04	0.67113E+00	0.44037E+00	0.29554E+00	0.91828E+00
0.25254E+04	0.66900E+00	0.44043E+00	0.29465E+00	0.91551E+00
0.25255E+04	0.66685E+00	0.44051E+00	0.29375E+00	0.91271E+00
0.25256E+04	0.66465E+00	0.44058E+00	0.29283E+00	0.90986E+00
0.25257E+04	0.66240E+00	0.44066E+00	0.29189E+00	0.90694E+00
0.25258E+04	0.66011E+00	0.44073E+00	0.29093E+00	0.90396E+00
0.25259E+04	0.65778E+00	0.44081E+00	0.28995E+00	0.90092E+00
0.25260E+04	0.65539E+00	0.44089E+00	0.28895E+00	0.89780E+00
0.25261E+04	0.65293E+00	0.44092E+00	0.28789E+00	0.89450E+00
0.25262E+04	0.65043E+00	0.44093E+00	0.28680E+00	0.89110E+00
0.25263E+04	0.64791E+00	0.44095E+00	0.28570E+00	0.88769E+00
0.25264E+04	0.64539E+00	0.44097E+00	0.28460E+00	0.88427E+00
0.25265E+04	0.64285E+00	0.44099E+00	0.28349E+00	0.88082E+00
0.25266E+04	0.64028E+00	0.44101E+00	0.28237E+00	0.87735E+00
0.25267E+04	0.63769E+00	0.44103E+00	0.28124E+00	0.87383E+00
0.25268E+04	0.63506E+00	0.44105E+00	0.28009E+00	0.87028E+00
0.25269E+04	0.63240E+00	0.44107E+00	0.27893E+00	0.86667E+00
0.25270E+04	0.62971E+00	0.44109E+00	0.27775E+00	0.86301E+00
0.25271E+04	0.62697E+00	0.44111E+00	0.27656E+00	0.85930E+00
0.25272E+04	0.62416E+00	0.44113E+00	0.27533E+00	0.85548E+00
0.25273E+04	0.62129E+00	0.44114E+00	0.27408E+00	0.85158E+00
0.25274E+04	0.61839E+00	0.44116E+00	0.27281E+00	0.84765E+00
0.25275E+04	0.61548E+00	0.44118E+00	0.27154E+00	0.84370E+00
0.25276E+04	0.61254E+00	0.44120E+00	0.27025E+00	0.83970E+00
0.25277E+04	0.60956E+00	0.44122E+00	0.26895E+00	0.83565E+00
0.25278E+04	0.60653E+00	0.44124E+00	0.26762E+00	0.83154E+00
0.25279E+04	0.60348E+00	0.44126E+00	0.26629E+00	0.82739E+00
0.25280E+04	0.60042E+00	0.44127E+00	0.26495E+00	0.82323E+00
0.25281E+04	0.59734E+00	0.44129E+00	0.26360E+00	0.81903E+00
0.25282E+04	0.59423E+00	0.44131E+00	0.26224E+00	0.81481E+00
0.25283E+04	0.59110E+00	0.44133E+00	0.26087E+00	0.81054E+00
0.25284E+04	0.58792E+00	0.44135E+00	0.25948E+00	0.80622E+00
0.25285E+04	0.58472E+00	0.44137E+00	0.25807E+00	0.80186E+00
0.25286E+04	0.58151E+00	0.44138E+00	0.25667E+00	0.79749E+00

0.25287E+04	0.57831E+00	0.44140E+00	0.25526E+00	0.79313E+00
0.25288E+04	0.57508E+00	0.44141E+00	0.25385E+00	0.78873E+00
0.25289E+04	0.57181E+00	0.44143E+00	0.25242E+00	0.78428E+00
0.25290E+04	0.56851E+00	0.44145E+00	0.25097E+00	0.77978E+00
0.25291E+04	0.56518E+00	0.44146E+00	0.24950E+00	0.77523E+00
0.25292E+04	0.56182E+00	0.44147E+00	0.24803E+00	0.77064E+00
0.25293E+04	0.55843E+00	0.44149E+00	0.24654E+00	0.76602E+00
0.25294E+04	0.55502E+00	0.44150E+00	0.24504E+00	0.76136E+00
0.25295E+04	0.55156E+00	0.44151E+00	0.24352E+00	0.75665E+00
0.25296E+04	0.54808E+00	0.44153E+00	0.24199E+00	0.75189E+00
0.25297E+04	0.54459E+00	0.44154E+00	0.24046E+00	0.74712E+00
0.25298E+04	0.54110E+00	0.44155E+00	0.23892E+00	0.74235E+00
0.25299E+04	0.53759E+00	0.44157E+00	0.23738E+00	0.73757E+00
0.25300E+04	0.53406E+00	0.44159E+00	0.23584E+00	0.73277E+00
0.25301E+04	0.53051E+00	0.44168E+00	0.23431E+00	0.72803E+00
0.25302E+04	0.52695E+00	0.44176E+00	0.23279E+00	0.72329E+00
0.25303E+04	0.52342E+00	0.44184E+00	0.23127E+00	0.71857E+00
0.25304E+04	0.51990E+00	0.44193E+00	0.22976E+00	0.71387E+00
0.25305E+04	0.51638E+00	0.44201E+00	0.22824E+00	0.70917E+00
0.25306E+04	0.51284E+00	0.44209E+00	0.22673E+00	0.70446E+00
0.25307E+04	0.50929E+00	0.44218E+00	0.22520E+00	0.69972E+00
0.25308E+04	0.50571E+00	0.44227E+00	0.22366E+00	0.69493E+00
0.25309E+04	0.50210E+00	0.44235E+00	0.22211E+00	0.69011E+00
0.25310E+04	0.49849E+00	0.44244E+00	0.22055E+00	0.68527E+00
0.25311E+04	0.49487E+00	0.44252E+00	0.21899E+00	0.68043E+00
0.25312E+04	0.49122E+00	0.44261E+00	0.21742E+00	0.67555E+00
0.25313E+04	0.48755E+00	0.44270E+00	0.21584E+00	0.67063E+00
0.25314E+04	0.48386E+00	0.44279E+00	0.21425E+00	0.66569E+00
0.25315E+04	0.48016E+00	0.44288E+00	0.21265E+00	0.66073E+00
0.25316E+04	0.47643E+00	0.44297E+00	0.21104E+00	0.65573E+00
0.25317E+04	0.47265E+00	0.44306E+00	0.20941E+00	0.65067E+00
0.25318E+04	0.46884E+00	0.44315E+00	0.20776E+00	0.64554E+00
0.25319E+04	0.46499E+00	0.44324E+00	0.20610E+00	0.64038E+00
0.25320E+04	0.46115E+00	0.44333E+00	0.20444E+00	0.63521E+00
0.25321E+04	0.45731E+00	0.44342E+00	0.20278E+00	0.63006E+00
0.25322E+04	0.45349E+00	0.44350E+00	0.20112E+00	0.62491E+00
0.25323E+04	0.44965E+00	0.44358E+00	0.19946E+00	0.61974E+00
0.25324E+04	0.44580E+00	0.44366E+00	0.19778E+00	0.61453E+00
0.25325E+04	0.44192E+00	0.44374E+00	0.19610E+00	0.60929E+00
0.25326E+04	0.43802E+00	0.44382E+00	0.19440E+00	0.60402E+00
0.25327E+04	0.43411E+00	0.44390E+00	0.19270E+00	0.59874E+00
0.25328E+04	0.43020E+00	0.44397E+00	0.19100E+00	0.59344E+00
0.25329E+04	0.42627E+00	0.44405E+00	0.18929E+00	0.58813E+00

0.25330E+04	0.42234E+00	0.44413E+00	0.18757E+00	0.58281E+00
0.25331E+04	0.41840E+00	0.44421E+00	0.18586E+00	0.57748E+00
0.25332E+04	0.41446E+00	0.44429E+00	0.18414E+00	0.57213E+00
0.25333E+04	0.41050E+00	0.44436E+00	0.18241E+00	0.56677E+00
0.25334E+04	0.40653E+00	0.44444E+00	0.18068E+00	0.56138E+00
0.25335E+04	0.40252E+00	0.44452E+00	0.17893E+00	0.55594E+00
0.25336E+04	0.39849E+00	0.44459E+00	0.17717E+00	0.55047E+00
0.25337E+04	0.39448E+00	0.44467E+00	0.17541E+00	0.54503E+00
0.25338E+04	0.39050E+00	0.44474E+00	0.17367E+00	0.53962E+00
0.25339E+04	0.38655E+00	0.44482E+00	0.17194E+00	0.53424E+00
0.25340E+04	0.38258E+00	0.44490E+00	0.17021E+00	0.52885E+00
0.25341E+04	0.37858E+00	0.44499E+00	0.16846E+00	0.52344E+00
0.25342E+04	0.37457E+00	0.44508E+00	0.16671E+00	0.51800E+00
0.25343E+04	0.37056E+00	0.44517E+00	0.16496E+00	0.51255E+00
0.25344E+04	0.36654E+00	0.44526E+00	0.16321E+00	0.50710E+00
0.25345E+04	0.36254E+00	0.44536E+00	0.16146E+00	0.50167E+00
0.25346E+04	0.35856E+00	0.44545E+00	0.15972E+00	0.49627E+00
0.25347E+04	0.35459E+00	0.44554E+00	0.15798E+00	0.49087E+00
0.25348E+04	0.35060E+00	0.44563E+00	0.15624E+00	0.48545E+00
0.25349E+04	0.34659E+00	0.44573E+00	0.15448E+00	0.47999E+00
0.25350E+04	0.34257E+00	0.44582E+00	0.15272E+00	0.47452E+00
0.25351E+04	0.33856E+00	0.44590E+00	0.15096E+00	0.46905E+00
0.25352E+04	0.33456E+00	0.44597E+00	0.14920E+00	0.46359E+00
0.25353E+04	0.33057E+00	0.44605E+00	0.14745E+00	0.45815E+00
0.25354E+04	0.32664E+00	0.44613E+00	0.14572E+00	0.45278E+00
0.25355E+04	0.32276E+00	0.44621E+00	0.14402E+00	0.44747E+00
0.25356E+04	0.31889E+00	0.44628E+00	0.14232E+00	0.44219E+00
0.25357E+04	0.31503E+00	0.44636E+00	0.14062E+00	0.43691E+00
0.25358E+04	0.31114E+00	0.44644E+00	0.13891E+00	0.43160E+00
0.25359E+04	0.30725E+00	0.44652E+00	0.13719E+00	0.42627E+00
0.25360E+04	0.30336E+00	0.44660E+00	0.13548E+00	0.42095E+00
0.25361E+04	0.29948E+00	0.44667E+00	0.13377E+00	0.41564E+00
0.25362E+04	0.29565E+00	0.44674E+00	0.13208E+00	0.41037E+00
0.25363E+04	0.29185E+00	0.44681E+00	0.13040E+00	0.40517E+00
0.25364E+04	0.28806E+00	0.44687E+00	0.12873E+00	0.39997E+00
0.25365E+04	0.28427E+00	0.44694E+00	0.12705E+00	0.39476E+00
0.25366E+04	0.28047E+00	0.44701E+00	0.12538E+00	0.38955E+00
0.25367E+04	0.27669E+00	0.44708E+00	0.12370E+00	0.38435E+00
0.25368E+04	0.27292E+00	0.44715E+00	0.12203E+00	0.37917E+00
0.25369E+04	0.26917E+00	0.44722E+00	0.12038E+00	0.37403E+00
0.25370E+04	0.26546E+00	0.44728E+00	0.11873E+00	0.36892E+00
0.25371E+04	0.26178E+00	0.44735E+00	0.11711E+00	0.36387E+00
0.25372E+04	0.25818E+00	0.44742E+00	0.11551E+00	0.35891E+00

0.25373E+04	0.25461E+00	0.44748E+00	0.11393E+00	0.35401E+00
0.25374E+04	0.25105E+00	0.44755E+00	0.11236E+00	0.34911E+00
0.25375E+04	0.24750E+00	0.44762E+00	0.11078E+00	0.34422E+00
0.25376E+04	0.24396E+00	0.44768E+00	0.10921E+00	0.33934E+00
0.25377E+04	0.24044E+00	0.44775E+00	0.10766E+00	0.33449E+00
0.25378E+04	0.23695E+00	0.44782E+00	0.10611E+00	0.32970E+00
0.25379E+04	0.23353E+00	0.44788E+00	0.10459E+00	0.32498E+00
0.25380E+04	0.23015E+00	0.44795E+00	0.10310E+00	0.32033E+00
0.25381E+04	0.22682E+00	0.44802E+00	0.10162E+00	0.31574E+00
0.25382E+04	0.22352E+00	0.44809E+00	0.10016E+00	0.31121E+00
0.25383E+04	0.22029E+00	0.44817E+00	0.98726E-01	0.30675E+00
0.25384E+04	0.21710E+00	0.44824E+00	0.97312E-01	0.30236E+00
0.25385E+04	0.21392E+00	0.44832E+00	0.95902E-01	0.29798E+00
0.25386E+04	0.21073E+00	0.44839E+00	0.94488E-01	0.29358E+00
0.25387E+04	0.20755E+00	0.44846E+00	0.93079E-01	0.28920E+00
0.25388E+04	0.20441E+00	0.44853E+00	0.91686E-01	0.28488E+00
0.25389E+04	0.20132E+00	0.44861E+00	0.90311E-01	0.28060E+00
0.25390E+04	0.19825E+00	0.44868E+00	0.88951E-01	0.27638E+00
0.25391E+04	0.19522E+00	0.44875E+00	0.87606E-01	0.27220E+00
0.25392E+04	0.19222E+00	0.44882E+00	0.86274E-01	0.26806E+00
0.25393E+04	0.18924E+00	0.44889E+00	0.84949E-01	0.26395E+00
0.25394E+04	0.18629E+00	0.44896E+00	0.83637E-01	0.25987E+00
0.25395E+04	0.18337E+00	0.44903E+00	0.82341E-01	0.25584E+00
0.25396E+04	0.18050E+00	0.44910E+00	0.81065E-01	0.25188E+00
0.25397E+04	0.17767E+00	0.44917E+00	0.79804E-01	0.24796E+00
0.25398E+04	0.17484E+00	0.44925E+00	0.78544E-01	0.24405E+00
0.25399E+04	0.17200E+00	0.44932E+00	0.77285E-01	0.24013E+00
0.25400E+04	0.16919E+00	0.44939E+00	0.76032E-01	0.23624E+00
0.25401E+04	0.16640E+00	0.44946E+00	0.74789E-01	0.23238E+00
0.25402E+04	0.16363E+00	0.44952E+00	0.73555E-01	0.22854E+00
0.25403E+04	0.16089E+00	0.44959E+00	0.72335E-01	0.22475E+00
0.25404E+04	0.15818E+00	0.44966E+00	0.71125E-01	0.22099E+00
0.25405E+04	0.15548E+00	0.44972E+00	0.69923E-01	0.21726E+00
0.25406E+04	0.15281E+00	0.44979E+00	0.68735E-01	0.21357E+00
0.25407E+04	0.15018E+00	0.44986E+00	0.67560E-01	0.20992E+00
0.25408E+04	0.14759E+00	0.44993E+00	0.66405E-01	0.20633E+00
0.25409E+04	0.14506E+00	0.44999E+00	0.65277E-01	0.20282E+00
0.25410E+04	0.14260E+00	0.45006E+00	0.64178E-01	0.19941E+00
0.25411E+04	0.14021E+00	0.45013E+00	0.63114E-01	0.19610E+00
0.25412E+04	0.13790E+00	0.45020E+00	0.62081E-01	0.19289E+00
0.25413E+04	0.13562E+00	0.45027E+00	0.61068E-01	0.18974E+00
0.25414E+04	0.13336E+00	0.45035E+00	0.60058E-01	0.18660E+00
0.25415E+04	0.13109E+00	0.45042E+00	0.59045E-01	0.18346E+00

0.25416E+04	0.12883E+00	0.45049E+00	0.58038E-01	0.18033E+00
0.25417E+04	0.12659E+00	0.45056E+00	0.57035E-01	0.17721E+00
0.25418E+04	0.12435E+00	0.45063E+00	0.56037E-01	0.17411E+00
0.25419E+04	0.12215E+00	0.45070E+00	0.55053E-01	0.17105E+00
0.25420E+04	0.11998E+00	0.45077E+00	0.54083E-01	0.16804E+00
0.25421E+04	0.11784E+00	0.45083E+00	0.53124E-01	0.16506E+00
0.25422E+04	0.11573E+00	0.45089E+00	0.52180E-01	0.16213E+00
0.25423E+04	0.11367E+00	0.45095E+00	0.51259E-01	0.15927E+00
0.25424E+04	0.11166E+00	0.45101E+00	0.50358E-01	0.15647E+00
0.25425E+04	0.10966E+00	0.45107E+00	0.49464E-01	0.15369E+00
0.25426E+04	0.10766E+00	0.45112E+00	0.48568E-01	0.15090E+00
0.25427E+04	0.10566E+00	0.45118E+00	0.47673E-01	0.14813E+00
0.25428E+04	0.10370E+00	0.45124E+00	0.46796E-01	0.14540E+00
0.25429E+04	0.10180E+00	0.45130E+00	0.45941E-01	0.14274E+00
0.25430E+04	0.99950E-01	0.45135E+00	0.45113E-01	0.14017E+00
0.25431E+04	0.98151E-01	0.45141E+00	0.44306E-01	0.13766E+00
0.25432E+04	0.96376E-01	0.45147E+00	0.43510E-01	0.13519E+00
0.25433E+04	0.94619E-01	0.45152E+00	0.42723E-01	0.13274E+00
0.25434E+04	0.92890E-01	0.45158E+00	0.41947E-01	0.13033E+00
0.25435E+04	0.91186E-01	0.45163E+00	0.41183E-01	0.12796E+00
0.25436E+04	0.89507E-01	0.45169E+00	0.40429E-01	0.12562E+00
0.25437E+04	0.87853E-01	0.45174E+00	0.39687E-01	0.12331E+00
0.25438E+04	0.86225E-01	0.45180E+00	0.38956E-01	0.12104E+00
0.25439E+04	0.84619E-01	0.45185E+00	0.38235E-01	0.11880E+00
0.25440E+04	0.83034E-01	0.45191E+00	0.37524E-01	0.11659E+00
0.25441E+04	0.81479E-01	0.45195E+00	0.36825E-01	0.11442E+00
0.25442E+04	0.79958E-01	0.45199E+00	0.36140E-01	0.11229E+00
0.25443E+04	0.78469E-01	0.45203E+00	0.35471E-01	0.11021E+00
0.25444E+04	0.77019E-01	0.45207E+00	0.34818E-01	0.10818E+00
0.25445E+04	0.75618E-01	0.45211E+00	0.34188E-01	0.10623E+00
0.25446E+04	0.74284E-01	0.45216E+00	0.33588E-01	0.10436E+00
0.25447E+04	0.73009E-01	0.45220E+00	0.33014E-01	0.10258E+00
0.25448E+04	0.71772E-01	0.45224E+00	0.32458E-01	0.10085E+00
0.25449E+04	0.70562E-01	0.45228E+00	0.31914E-01	0.99159E-01
0.25450E+04	0.69377E-01	0.45232E+00	0.31380E-01	0.97502E-01
0.25451E+04	0.68233E-01	0.45238E+00	0.30867E-01	0.95907E-01
0.25452E+04	0.67123E-01	0.45243E+00	0.30369E-01	0.94359E-01
0.25453E+04	0.66017E-01	0.45249E+00	0.29872E-01	0.92816E-01
0.25454E+04	0.64921E-01	0.45255E+00	0.29380E-01	0.91286E-01
0.25455E+04	0.63838E-01	0.45260E+00	0.28893E-01	0.89774E-01
0.25456E+04	0.62773E-01	0.45266E+00	0.28415E-01	0.88288E-01
0.25457E+04	0.61730E-01	0.45272E+00	0.27947E-01	0.86832E-01
0.25458E+04	0.60705E-01	0.45278E+00	0.27486E-01	0.85402E-01

0.25459E+04	0.59702E-01	0.45284E+00	0.27035E-01	0.84002E-01
0.25460E+04	0.58722E-01	0.45290E+00	0.26595E-01	0.82633E-01
0.25461E+04	0.57741E-01	0.45293E+00	0.26153E-01	0.81259E-01
0.25462E+04	0.56777E-01	0.45295E+00	0.25717E-01	0.79906E-01
0.25463E+04	0.55859E-01	0.45298E+00	0.25303E-01	0.78618E-01
0.25464E+04	0.54986E-01	0.45300E+00	0.24909E-01	0.77394E-01
0.25465E+04	0.54145E-01	0.45302E+00	0.24529E-01	0.76214E-01
0.25466E+04	0.53309E-01	0.45305E+00	0.24151E-01	0.75041E-01
0.25467E+04	0.52464E-01	0.45307E+00	0.23770E-01	0.73856E-01
0.25468E+04	0.51631E-01	0.45310E+00	0.23394E-01	0.72688E-01
0.25469E+04	0.50816E-01	0.45312E+00	0.23026E-01	0.71544E-01
0.25470E+04	0.50009E-01	0.45315E+00	0.22662E-01	0.70412E-01
0.25471E+04	0.49204E-01	0.45317E+00	0.22298E-01	0.69281E-01
0.25472E+04	0.48405E-01	0.45320E+00	0.21937E-01	0.68160E-01
0.25473E+04	0.47604E-01	0.45322E+00	0.21575E-01	0.67036E-01
0.25474E+04	0.46802E-01	0.45324E+00	0.21213E-01	0.65909E-01
0.25475E+04	0.46024E-01	0.45327E+00	0.20861E-01	0.64817E-01
0.25476E+04	0.45289E-01	0.45329E+00	0.20529E-01	0.63786E-01
0.25477E+04	0.44597E-01	0.45331E+00	0.20216E-01	0.62814E-01
0.25478E+04	0.43930E-01	0.45333E+00	0.19915E-01	0.61877E-01
0.25479E+04	0.43268E-01	0.45335E+00	0.19616E-01	0.60948E-01
0.25480E+04	0.42601E-01	0.45337E+00	0.19314E-01	0.60012E-01
0.25481E+04	0.41921E-01	0.45338E+00	0.19006E-01	0.59053E-01
0.25482E+04	0.41224E-01	0.45338E+00	0.18690E-01	0.58072E-01
0.25483E+04	0.40519E-01	0.45339E+00	0.18371E-01	0.57080E-01
0.25484E+04	0.39823E-01	0.45339E+00	0.18056E-01	0.56101E-01
0.25485E+04	0.39158E-01	0.45340E+00	0.17754E-01	0.55163E-01
0.25486E+04	0.38530E-01	0.45340E+00	0.17469E-01	0.54279E-01
0.25487E+04	0.37928E-01	0.45340E+00	0.17197E-01	0.53432E-01
0.25488E+04	0.37344E-01	0.45341E+00	0.16932E-01	0.52610E-01
0.25489E+04	0.36758E-01	0.45341E+00	0.16666E-01	0.51784E-01
0.25490E+04	0.36162E-01	0.45341E+00	0.16396E-01	0.50945E-01
0.25491E+04	0.35572E-01	0.45341E+00	0.16129E-01	0.50114E-01
0.25492E+04	0.35000E-01	0.45342E+00	0.15870E-01	0.49309E-01
0.25493E+04	0.34441E-01	0.45342E+00	0.15616E-01	0.48522E-01
0.25494E+04	0.33877E-01	0.45342E+00	0.15361E-01	0.47727E-01
0.25495E+04	0.33324E-01	0.45342E+00	0.15110E-01	0.46948E-01
0.25496E+04	0.32795E-01	0.45342E+00	0.14870E-01	0.46203E-01
0.25497E+04	0.32283E-01	0.45343E+00	0.14638E-01	0.45481E-01
0.25498E+04	0.31788E-01	0.45343E+00	0.14413E-01	0.44784E-01
0.25499E+04	0.31305E-01	0.45343E+00	0.14194E-01	0.44103E-01
0.25500E+04	0.30829E-01	0.45344E+00	0.13979E-01	0.43435E-01
0.25501E+04	0.30346E-01	0.45350E+00	0.13762E-01	0.42760E-01

0.25502E+04	0.29868E-01	0.45357E+00	0.13547E-01	0.42093E-01
0.25503E+04	0.29397E-01	0.45363E+00	0.13335E-01	0.41434E-01
0.25504E+04	0.28933E-01	0.45369E+00	0.13127E-01	0.40787E-01
0.25505E+04	0.28471E-01	0.45376E+00	0.12919E-01	0.40140E-01
0.25506E+04	0.28012E-01	0.45382E+00	0.12712E-01	0.39498E-01
0.25507E+04	0.27567E-01	0.45389E+00	0.12512E-01	0.38877E-01
0.25508E+04	0.27124E-01	0.45395E+00	0.12313E-01	0.38258E-01
0.25509E+04	0.26686E-01	0.45402E+00	0.12116E-01	0.37645E-01
0.25510E+04	0.26248E-01	0.45408E+00	0.11919E-01	0.37032E-01
0.25511E+04	0.25810E-01	0.45415E+00	0.11722E-01	0.36421E-01
0.25512E+04	0.25382E-01	0.45422E+00	0.11529E-01	0.35821E-01
0.25513E+04	0.24958E-01	0.45429E+00	0.11338E-01	0.35228E-01
0.25514E+04	0.24541E-01	0.45436E+00	0.11150E-01	0.34645E-01
0.25515E+04	0.24128E-01	0.45443E+00	0.10964E-01	0.34067E-01
0.25516E+04	0.23717E-01	0.45450E+00	0.10779E-01	0.33493E-01
0.25517E+04	0.23327E-01	0.45457E+00	0.10604E-01	0.32946E-01
0.25518E+04	0.22980E-01	0.45464E+00	0.10448E-01	0.32462E-01
0.25519E+04	0.22660E-01	0.45471E+00	0.10304E-01	0.32015E-01
0.25520E+04	0.22346E-01	0.45478E+00	0.10162E-01	0.31575E-01
0.25521E+04	0.22035E-01	0.45480E+00	0.10021E-01	0.31137E-01
0.25522E+04	0.21727E-01	0.45482E+00	0.98817E-02	0.30703E-01
0.25523E+04	0.21426E-01	0.45484E+00	0.97455E-02	0.30280E-01
0.25524E+04	0.21127E-01	0.45486E+00	0.96099E-02	0.29859E-01
0.25525E+04	0.20828E-01	0.45488E+00	0.94743E-02	0.29438E-01
0.25526E+04	0.20533E-01	0.45490E+00	0.93406E-02	0.29022E-01
0.25527E+04	0.20241E-01	0.45492E+00	0.92079E-02	0.28610E-01
0.25528E+04	0.19948E-01	0.45494E+00	0.90752E-02	0.28198E-01
0.25529E+04	0.19656E-01	0.45496E+00	0.89428E-02	0.27786E-01
0.25530E+04	0.19368E-01	0.45498E+00	0.88119E-02	0.27380E-01
0.25531E+04	0.19080E-01	0.45499E+00	0.86812E-02	0.26973E-01
0.25532E+04	0.18792E-01	0.45501E+00	0.85506E-02	0.26568E-01
0.25533E+04	0.18505E-01	0.45502E+00	0.84204E-02	0.26163E-01
0.25534E+04	0.18223E-01	0.45504E+00	0.82922E-02	0.25765E-01
0.25535E+04	0.17946E-01	0.45505E+00	0.81663E-02	0.25373E-01
0.25536E+04	0.17669E-01	0.45506E+00	0.80406E-02	0.24983E-01
0.25537E+04	0.17420E-01	0.45507E+00	0.79272E-02	0.24631E-01
0.25538E+04	0.17172E-01	0.45508E+00	0.78148E-02	0.24281E-01
0.25539E+04	0.16930E-01	0.45509E+00	0.77048E-02	0.23940E-01
0.25540E+04	0.16690E-01	0.45510E+00	0.75956E-02	0.23600E-01
0.25541E+04	0.16451E-01	0.45509E+00	0.74866E-02	0.23262E-01
0.25542E+04	0.16213E-01	0.45507E+00	0.73780E-02	0.22924E-01
0.25543E+04	0.15978E-01	0.45504E+00	0.72705E-02	0.22590E-01
0.25544E+04	0.15742E-01	0.45502E+00	0.71630E-02	0.22256E-01

0.25545E+04	0.15507E-01	0.45500E+00	0.70555E-02	0.21922E-01
0.25546E+04	0.15277E-01	0.45497E+00	0.69507E-02	0.21597E-01
0.25547E+04	0.15050E-01	0.45495E+00	0.68469E-02	0.21274E-01
0.25548E+04	0.14824E-01	0.45492E+00	0.67438E-02	0.20954E-01
0.25549E+04	0.14607E-01	0.45489E+00	0.66448E-02	0.20646E-01
0.25550E+04	0.14391E-01	0.45487E+00	0.65462E-02	0.20340E-01
0.25551E+04	0.14180E-01	0.45483E+00	0.64494E-02	0.20039E-01
0.25552E+04	0.13970E-01	0.45478E+00	0.63532E-02	0.19740E-01
0.25553E+04	0.13760E-01	0.45474E+00	0.62571E-02	0.19442E-01
0.25554E+04	0.13550E-01	0.45470E+00	0.61614E-02	0.19144E-01
0.25555E+04	0.13342E-01	0.45466E+00	0.60659E-02	0.18847E-01
0.25556E+04	0.13135E-01	0.45462E+00	0.59713E-02	0.18553E-01
0.25557E+04	0.12930E-01	0.45457E+00	0.58776E-02	0.18262E-01
0.25558E+04	0.12733E-01	0.45453E+00	0.57877E-02	0.17983E-01
0.25559E+04	0.12538E-01	0.45449E+00	0.56983E-02	0.17705E-01
0.25560E+04	0.12343E-01	0.45446E+00	0.56092E-02	0.17428E-01
0.25561E+04	0.12150E-01	0.45447E+00	0.55218E-02	0.17157E-01
0.25562E+04	0.11959E-01	0.45449E+00	0.54352E-02	0.16888E-01
0.25563E+04	0.11768E-01	0.45451E+00	0.53487E-02	0.16619E-01
0.25564E+04	0.11578E-01	0.45453E+00	0.52625E-02	0.16351E-01
0.25565E+04	0.11390E-01	0.45455E+00	0.51772E-02	0.16086E-01
0.25566E+04	0.11202E-01	0.45457E+00	0.50922E-02	0.15822E-01
0.25567E+04	0.11016E-01	0.45458E+00	0.50076E-02	0.15559E-01
0.25568E+04	0.10829E-01	0.45460E+00	0.49231E-02	0.15297E-01
0.25569E+04	0.10646E-01	0.45462E+00	0.48401E-02	0.15039E-01
0.25570E+04	0.10470E-01	0.45464E+00	0.47601E-02	0.14790E-01
0.25571E+04	0.10295E-01	0.45466E+00	0.46807E-02	0.14543E-01
0.25572E+04	0.10121E-01	0.45468E+00	0.46017E-02	0.14298E-01
0.25573E+04	0.99477E-02	0.45470E+00	0.45232E-02	0.14054E-01
0.25574E+04	0.97757E-02	0.45472E+00	0.44451E-02	0.13812E-01
0.25575E+04	0.96054E-02	0.45473E+00	0.43679E-02	0.13572E-01
0.25576E+04	0.94381E-02	0.45476E+00	0.42920E-02	0.13336E-01
0.25577E+04	0.92734E-02	0.45478E+00	0.42173E-02	0.13104E-01
0.25578E+04	0.91091E-02	0.45480E+00	0.41428E-02	0.12872E-01
0.25579E+04	0.89470E-02	0.45482E+00	0.40693E-02	0.12644E-01
0.25580E+04	0.87862E-02	0.45485E+00	0.39963E-02	0.12417E-01
0.25581E+04	0.86255E-02	0.45490E+00	0.39237E-02	0.12191E-01
0.25582E+04	0.84716E-02	0.45495E+00	0.38542E-02	0.11975E-01
0.25583E+04	0.83190E-02	0.45500E+00	0.37852E-02	0.11761E-01
0.25584E+04	0.81668E-02	0.45506E+00	0.37164E-02	0.11547E-01
0.25585E+04	0.80150E-02	0.45511E+00	0.36477E-02	0.11334E-01
0.25586E+04	0.78650E-02	0.45517E+00	0.35799E-02	0.11123E-01
0.25587E+04	0.77150E-02	0.45523E+00	0.35121E-02	0.10912E-01

0.25588E+04	0.75674E-02	0.45528E+00	0.34453E-02	0.10705E-01
0.25589E+04	0.74210E-02	0.45534E+00	0.33791E-02	0.10499E-01
0.25590E+04	0.72756E-02	0.45540E+00	0.33133E-02	0.10295E-01
0.25591E+04	0.71319E-02	0.45546E+00	0.32483E-02	0.10093E-01
0.25592E+04	0.69908E-02	0.45553E+00	0.31845E-02	0.98945E-02
0.25593E+04	0.68505E-02	0.45559E+00	0.31210E-02	0.96973E-02
0.25594E+04	0.67109E-02	0.45565E+00	0.30578E-02	0.95010E-02
0.25595E+04	0.65722E-02	0.45572E+00	0.29950E-02	0.93059E-02
0.25596E+04	0.64349E-02	0.45578E+00	0.29329E-02	0.91129E-02
0.25597E+04	0.63009E-02	0.45585E+00	0.28723E-02	0.89245E-02
0.25598E+04	0.61703E-02	0.45592E+00	0.28132E-02	0.87408E-02
0.25599E+04	0.60412E-02	0.45599E+00	0.27547E-02	0.85592E-02
0.25600E+04	0.59127E-02	0.45605E+00	0.26965E-02	0.83782E-02
0.25601E+04	0.57865E-02	0.45604E+00	0.26388E-02	0.81992E-02
0.25602E+04	0.56623E-02	0.45602E+00	0.25822E-02	0.80231E-02
0.25603E+04	0.55399E-02	0.45601E+00	0.25263E-02	0.78494E-02
0.25604E+04	0.54178E-02	0.45600E+00	0.24705E-02	0.76761E-02
0.25605E+04	0.52963E-02	0.45598E+00	0.24151E-02	0.75038E-02
0.25606E+04	0.51752E-02	0.45597E+00	0.23597E-02	0.73320E-02
0.25607E+04	0.50546E-02	0.45596E+00	0.23047E-02	0.71609E-02
0.25608E+04	0.49347E-02	0.45595E+00	0.22500E-02	0.69909E-02
0.25609E+04	0.48158E-02	0.45594E+00	0.21957E-02	0.68223E-02
0.25610E+04	0.46974E-02	0.45593E+00	0.21417E-02	0.66544E-02
0.25611E+04	0.45813E-02	0.45592E+00	0.20887E-02	0.64898E-02
0.25612E+04	0.44653E-02	0.45591E+00	0.20358E-02	0.63254E-02
0.25613E+04	0.43495E-02	0.45590E+00	0.19829E-02	0.61611E-02
0.25614E+04	0.42351E-02	0.45589E+00	0.19307E-02	0.59989E-02
0.25615E+04	0.41218E-02	0.45588E+00	0.18790E-02	0.58384E-02
0.25616E+04	0.40103E-02	0.45587E+00	0.18282E-02	0.56803E-02
0.25617E+04	0.39027E-02	0.45585E+00	0.17791E-02	0.55277E-02
0.25618E+04	0.37954E-02	0.45584E+00	0.17301E-02	0.53756E-02
0.25619E+04	0.36887E-02	0.45583E+00	0.16814E-02	0.52244E-02
0.25620E+04	0.35822E-02	0.45582E+00	0.16328E-02	0.50734E-02
0.25621E+04	0.34758E-02	0.45582E+00	0.15844E-02	0.49228E-02
0.25622E+04	0.33700E-02	0.45583E+00	0.15361E-02	0.47729E-02
0.25623E+04	0.32645E-02	0.45583E+00	0.14881E-02	0.46236E-02
0.25624E+04	0.31594E-02	0.45584E+00	0.14402E-02	0.44747E-02
0.25625E+04	0.30549E-02	0.45584E+00	0.13926E-02	0.43269E-02
0.25626E+04	0.29508E-02	0.45584E+00	0.13451E-02	0.41793E-02
0.25627E+04	0.28478E-02	0.45584E+00	0.12982E-02	0.40335E-02
0.25628E+04	0.27459E-02	0.45584E+00	0.12517E-02	0.38891E-02
0.25629E+04	0.26448E-02	0.45584E+00	0.12056E-02	0.37460E-02
0.25630E+04	0.25439E-02	0.45584E+00	0.11596E-02	0.36031E-02

0.25631E+04	0.24435E-02	0.45583E+00	0.11138E-02	0.34608E-02
0.25632E+04	0.23445E-02	0.45583E+00	0.10687E-02	0.33206E-02
0.25633E+04	0.22465E-02	0.45583E+00	0.10240E-02	0.31817E-02
0.25634E+04	0.21486E-02	0.45582E+00	0.97939E-03	0.30431E-02
0.25635E+04	0.20515E-02	0.45582E+00	0.93513E-03	0.29055E-02
0.25636E+04	0.19597E-02	0.45581E+00	0.89325E-03	0.27754E-02
0.25637E+04	0.18693E-02	0.45580E+00	0.85203E-03	0.26473E-02
0.25638E+04	0.17791E-02	0.45579E+00	0.81092E-03	0.25196E-02
0.25639E+04	0.16905E-02	0.45578E+00	0.77047E-03	0.23939E-02
0.25640E+04	0.16052E-02	0.45577E+00	0.73159E-03	0.22731E-02
0.25641E+04	0.15236E-02	0.45576E+00	0.69440E-03	0.21576E-02
0.25642E+04	0.14431E-02	0.45575E+00	0.65768E-03	0.20435E-02
0.25643E+04	0.13659E-02	0.45574E+00	0.62251E-03	0.19342E-02
0.25644E+04	0.12891E-02	0.45573E+00	0.58750E-03	0.18254E-02
0.25645E+04	0.12138E-02	0.45572E+00	0.55316E-03	0.17187E-02
0.25646E+04	0.11391E-02	0.45571E+00	0.51908E-03	0.16128E-02
0.25647E+04	0.10655E-02	0.45570E+00	0.48554E-03	0.15086E-02
0.25648E+04	0.99262E-03	0.45569E+00	0.45232E-03	0.14054E-02
0.25649E+04	0.91986E-03	0.45568E+00	0.41916E-03	0.13024E-02
0.25650E+04	0.84973E-03	0.45566E+00	0.38719E-03	0.12030E-02
0.25651E+04	0.78034E-03	0.45566E+00	0.35557E-03	0.11048E-02
0.25652E+04	0.71166E-03	0.45567E+00	0.32428E-03	0.10076E-02
0.25653E+04	0.64538E-03	0.45567E+00	0.29408E-03	0.91373E-03
0.25654E+04	0.57937E-03	0.45567E+00	0.26400E-03	0.82028E-03
0.25655E+04	0.51431E-03	0.45567E+00	0.23435E-03	0.72816E-03
0.25656E+04	0.45090E-03	0.45567E+00	0.20546E-03	0.63839E-03
0.25657E+04	0.38818E-03	0.45567E+00	0.17688E-03	0.54960E-03
0.25658E+04	0.32553E-03	0.45568E+00	0.14834E-03	0.46090E-03
0.25659E+04	0.26320E-03	0.45568E+00	0.11993E-03	0.37264E-03
0.25660E+04	0.20211E-03	0.45568E+00	0.92098E-04	0.28616E-03
0.25661E+04	0.14395E-03	0.45565E+00	0.65592E-04	0.20380E-03
0.25662E+04	0.88574E-04	0.45562E+00	0.40356E-04	0.12539E-03
0.25663E+04	0.34466E-04	0.45559E+00	0.15702E-04	0.48789E-04
0.25664E+04	0.00000E+00	0.45555E+00	0.00000E+00	0.00000E+00
Channel 19				
Wavenumber	HIRS Filter Transmittance	Optical Element Transmittance	Product of the HIRS Filter and Optical Element Transmittances	Normalized Value of Column 4
0.25554E+04	0.00000E+00	0.45470E+00	0.00000E+00	0.00000E+00
0.25556E+04	0.10676E-04	0.45462E+00	0.48536E-05	0.13004E-04
0.25558E+04	0.41062E-04	0.45453E+00	0.18664E-04	0.50006E-04
0.25560E+04	0.73501E-04	0.45446E+00	0.33403E-04	0.89495E-04

0.25562E+04	0.10862E-03	0.45449E+00	0.49365E-04	0.13226E-03
0.25564E+04	0.15652E-03	0.45453E+00	0.71143E-04	0.19061E-03
0.25566E+04	0.20857E-03	0.45457E+00	0.94807E-04	0.25401E-03
0.25568E+04	0.26349E-03	0.45460E+00	0.11978E-03	0.32093E-03
0.25570E+04	0.31868E-03	0.45464E+00	0.14489E-03	0.38819E-03
0.25572E+04	0.37604E-03	0.45468E+00	0.17098E-03	0.45810E-03
0.25574E+04	0.43398E-03	0.45472E+00	0.19734E-03	0.52872E-03
0.25576E+04	0.49263E-03	0.45476E+00	0.22403E-03	0.60023E-03
0.25578E+04	0.56409E-03	0.45480E+00	0.25655E-03	0.68737E-03
0.25580E+04	0.64071E-03	0.45485E+00	0.29142E-03	0.78081E-03
0.25582E+04	0.71764E-03	0.45495E+00	0.32649E-03	0.87476E-03
0.25584E+04	0.79844E-03	0.45506E+00	0.36333E-03	0.97348E-03
0.25586E+04	0.87991E-03	0.45517E+00	0.40051E-03	0.10731E-02
0.25588E+04	0.96235E-03	0.45528E+00	0.43814E-03	0.11739E-02
0.25590E+04	0.10449E-02	0.45540E+00	0.47587E-03	0.12750E-02
0.25592E+04	0.11317E-02	0.45553E+00	0.51551E-03	0.13812E-02
0.25594E+04	0.12190E-02	0.45565E+00	0.55545E-03	0.14882E-02
0.25596E+04	0.13085E-02	0.45578E+00	0.59640E-03	0.15979E-02
0.25598E+04	0.13996E-02	0.45592E+00	0.63811E-03	0.17097E-02
0.25600E+04	0.14914E-02	0.45605E+00	0.68014E-03	0.18223E-02
0.25602E+04	0.15832E-02	0.45602E+00	0.72200E-03	0.19344E-02
0.25604E+04	0.16766E-02	0.45600E+00	0.76454E-03	0.20484E-02
0.25606E+04	0.17702E-02	0.45597E+00	0.80714E-03	0.21626E-02
0.25608E+04	0.18642E-02	0.45595E+00	0.84996E-03	0.22773E-02
0.25610E+04	0.19588E-02	0.45593E+00	0.89309E-03	0.23928E-02
0.25612E+04	0.20541E-02	0.45591E+00	0.93648E-03	0.25091E-02
0.25614E+04	0.21516E-02	0.45589E+00	0.98089E-03	0.26281E-02
0.25616E+04	0.22497E-02	0.45587E+00	0.10255E-02	0.27477E-02
0.25618E+04	0.23487E-02	0.45584E+00	0.10706E-02	0.28685E-02
0.25620E+04	0.24499E-02	0.45582E+00	0.11167E-02	0.29919E-02
0.25622E+04	0.25516E-02	0.45583E+00	0.11631E-02	0.31162E-02
0.25624E+04	0.26540E-02	0.45584E+00	0.12098E-02	0.32414E-02
0.25626E+04	0.27577E-02	0.45584E+00	0.12571E-02	0.33681E-02
0.25628E+04	0.28625E-02	0.45584E+00	0.13048E-02	0.34960E-02
0.25630E+04	0.29676E-02	0.45584E+00	0.13527E-02	0.36244E-02
0.25632E+04	0.30736E-02	0.45583E+00	0.14010E-02	0.37537E-02
0.25634E+04	0.31804E-02	0.45582E+00	0.14497E-02	0.38842E-02
0.25636E+04	0.32882E-02	0.45581E+00	0.14988E-02	0.40157E-02
0.25638E+04	0.33975E-02	0.45579E+00	0.15485E-02	0.41489E-02
0.25640E+04	0.35070E-02	0.45577E+00	0.15984E-02	0.42826E-02
0.25642E+04	0.36175E-02	0.45575E+00	0.16487E-02	0.44173E-02
0.25644E+04	0.37292E-02	0.45573E+00	0.16995E-02	0.45534E-02
0.25646E+04	0.38409E-02	0.45571E+00	0.17503E-02	0.46896E-02

0.25648E+04	0.39548E-02	0.45569E+00	0.18022E-02	0.48285E-02
0.25650E+04	0.40700E-02	0.45566E+00	0.18545E-02	0.49688E-02
0.25652E+04	0.41855E-02	0.45567E+00	0.19072E-02	0.51099E-02
0.25654E+04	0.43017E-02	0.45567E+00	0.19602E-02	0.52518E-02
0.25656E+04	0.44188E-02	0.45567E+00	0.20135E-02	0.53948E-02
0.25658E+04	0.45385E-02	0.45568E+00	0.20681E-02	0.55409E-02
0.25660E+04	0.46584E-02	0.45568E+00	0.21228E-02	0.56875E-02
0.25662E+04	0.47785E-02	0.45562E+00	0.21772E-02	0.58333E-02
0.25664E+04	0.49000E-02	0.45555E+00	0.22322E-02	0.59807E-02
0.25666E+04	0.50225E-02	0.45549E+00	0.22877E-02	0.61294E-02
0.25668E+04	0.51456E-02	0.45543E+00	0.23435E-02	0.62788E-02
0.25670E+04	0.52701E-02	0.45537E+00	0.23998E-02	0.64298E-02
0.25672E+04	0.53971E-02	0.45531E+00	0.24574E-02	0.65840E-02
0.25674E+04	0.55255E-02	0.45526E+00	0.25155E-02	0.67398E-02
0.25676E+04	0.56542E-02	0.45520E+00	0.25738E-02	0.68958E-02
0.25678E+04	0.57842E-02	0.45514E+00	0.26327E-02	0.70536E-02
0.25680E+04	0.59150E-02	0.45509E+00	0.26918E-02	0.72122E-02
0.25682E+04	0.60470E-02	0.45499E+00	0.27513E-02	0.73715E-02
0.25684E+04	0.61806E-02	0.45488E+00	0.28114E-02	0.75326E-02
0.25686E+04	0.63156E-02	0.45478E+00	0.28722E-02	0.76955E-02
0.25688E+04	0.64519E-02	0.45468E+00	0.29335E-02	0.78597E-02
0.25690E+04	0.65920E-02	0.45457E+00	0.29965E-02	0.80286E-02
0.25692E+04	0.67337E-02	0.45447E+00	0.30602E-02	0.81992E-02
0.25694E+04	0.68772E-02	0.45436E+00	0.31247E-02	0.83720E-02
0.25696E+04	0.70216E-02	0.45425E+00	0.31896E-02	0.85458E-02
0.25698E+04	0.71681E-02	0.45415E+00	0.32554E-02	0.87220E-02
0.25700E+04	0.73161E-02	0.45404E+00	0.33218E-02	0.89000E-02
0.25702E+04	0.74643E-02	0.45393E+00	0.33882E-02	0.90780E-02
0.25704E+04	0.76131E-02	0.45382E+00	0.34549E-02	0.92568E-02
0.25706E+04	0.77628E-02	0.45371E+00	0.35220E-02	0.94365E-02
0.25708E+04	0.79142E-02	0.45360E+00	0.35899E-02	0.96182E-02
0.25710E+04	0.80666E-02	0.45349E+00	0.36581E-02	0.98012E-02
0.25712E+04	0.82202E-02	0.45338E+00	0.37269E-02	0.99853E-02
0.25714E+04	0.83738E-02	0.45327E+00	0.37956E-02	0.10169E-01
0.25716E+04	0.85292E-02	0.45317E+00	0.38652E-02	0.10356E-01
0.25718E+04	0.86851E-02	0.45306E+00	0.39349E-02	0.10543E-01
0.25720E+04	0.88412E-02	0.45296E+00	0.40047E-02	0.10730E-01
0.25722E+04	0.90035E-02	0.45283E+00	0.40771E-02	0.10924E-01
0.25724E+04	0.91676E-02	0.45270E+00	0.41502E-02	0.11120E-01
0.25726E+04	0.93330E-02	0.45257E+00	0.42239E-02	0.11317E-01
0.25728E+04	0.95025E-02	0.45244E+00	0.42994E-02	0.11519E-01
0.25730E+04	0.96791E-02	0.45231E+00	0.43780E-02	0.11730E-01
0.25732E+04	0.98569E-02	0.45219E+00	0.44572E-02	0.11942E-01

0.25734E+04	0.10037E-01	0.45206E+00	0.45371E-02	0.12156E-01
0.25736E+04	0.10221E-01	0.45194E+00	0.46193E-02	0.12376E-01
0.25738E+04	0.10415E-01	0.45181E+00	0.47056E-02	0.12608E-01
0.25740E+04	0.10610E-01	0.45169E+00	0.47923E-02	0.12840E-01
0.25742E+04	0.10805E-01	0.45159E+00	0.48793E-02	0.13073E-01
0.25744E+04	0.11008E-01	0.45150E+00	0.49701E-02	0.13316E-01
0.25746E+04	0.11213E-01	0.45141E+00	0.50615E-02	0.13561E-01
0.25748E+04	0.11418E-01	0.45131E+00	0.51531E-02	0.13807E-01
0.25750E+04	0.11626E-01	0.45121E+00	0.52459E-02	0.14055E-01
0.25752E+04	0.11854E-01	0.45110E+00	0.53472E-02	0.14327E-01
0.25754E+04	0.12082E-01	0.45098E+00	0.54489E-02	0.14599E-01
0.25756E+04	0.12316E-01	0.45086E+00	0.55528E-02	0.14877E-01
0.25758E+04	0.12550E-01	0.45073E+00	0.56567E-02	0.15156E-01
0.25760E+04	0.12787E-01	0.45061E+00	0.57620E-02	0.15438E-01
0.25762E+04	0.13025E-01	0.45052E+00	0.58679E-02	0.15722E-01
0.25764E+04	0.13263E-01	0.45042E+00	0.59739E-02	0.16006E-01
0.25766E+04	0.13519E-01	0.45032E+00	0.60880E-02	0.16311E-01
0.25768E+04	0.13783E-01	0.45022E+00	0.62052E-02	0.16626E-01
0.25770E+04	0.14076E-01	0.45013E+00	0.63359E-02	0.16976E-01
0.25772E+04	0.14369E-01	0.45002E+00	0.64666E-02	0.17326E-01
0.25774E+04	0.14674E-01	0.44992E+00	0.66019E-02	0.17688E-01
0.25776E+04	0.14983E-01	0.44982E+00	0.67396E-02	0.18057E-01
0.25778E+04	0.15301E-01	0.44973E+00	0.68815E-02	0.18437E-01
0.25780E+04	0.15629E-01	0.44963E+00	0.70273E-02	0.18828E-01
0.25782E+04	0.15960E-01	0.44951E+00	0.71743E-02	0.19222E-01
0.25784E+04	0.16293E-01	0.44938E+00	0.73217E-02	0.19617E-01
0.25786E+04	0.16626E-01	0.44926E+00	0.74695E-02	0.20013E-01
0.25788E+04	0.16963E-01	0.44915E+00	0.76188E-02	0.20413E-01
0.25790E+04	0.17301E-01	0.44904E+00	0.77687E-02	0.20815E-01
0.25792E+04	0.17639E-01	0.44894E+00	0.79189E-02	0.21217E-01
0.25794E+04	0.17979E-01	0.44884E+00	0.80697E-02	0.21621E-01
0.25796E+04	0.18332E-01	0.44874E+00	0.82262E-02	0.22040E-01
0.25798E+04	0.18686E-01	0.44865E+00	0.83833E-02	0.22461E-01
0.25800E+04	0.19042E-01	0.44856E+00	0.85418E-02	0.22886E-01
0.25802E+04	0.19404E-01	0.44876E+00	0.87075E-02	0.23330E-01
0.25804E+04	0.19771E-01	0.44895E+00	0.88763E-02	0.23782E-01
0.25806E+04	0.20139E-01	0.44915E+00	0.90454E-02	0.24235E-01
0.25808E+04	0.20516E-01	0.44935E+00	0.92187E-02	0.24699E-01
0.25810E+04	0.20894E-01	0.44955E+00	0.93927E-02	0.25166E-01
0.25812E+04	0.21283E-01	0.44975E+00	0.95719E-02	0.25646E-01
0.25814E+04	0.21680E-01	0.44995E+00	0.97549E-02	0.26136E-01
0.25816E+04	0.22078E-01	0.45015E+00	0.99387E-02	0.26628E-01
0.25818E+04	0.22483E-01	0.45035E+00	0.10125E-01	0.27129E-01

0.25820E+04	0.22891E-01	0.45055E+00	0.10314E-01	0.27633E-01
0.25822E+04	0.23299E-01	0.45076E+00	0.10502E-01	0.28138E-01
0.25824E+04	0.23711E-01	0.45096E+00	0.10693E-01	0.28649E-01
0.25826E+04	0.24135E-01	0.45117E+00	0.10889E-01	0.29175E-01
0.25828E+04	0.24562E-01	0.45137E+00	0.11087E-01	0.29704E-01
0.25830E+04	0.25005E-01	0.45157E+00	0.11292E-01	0.30254E-01
0.25832E+04	0.25453E-01	0.45177E+00	0.11499E-01	0.30809E-01
0.25834E+04	0.25929E-01	0.45197E+00	0.11719E-01	0.31399E-01
0.25836E+04	0.26413E-01	0.45217E+00	0.11943E-01	0.31999E-01
0.25838E+04	0.26944E-01	0.45236E+00	0.12189E-01	0.32656E-01
0.25840E+04	0.27480E-01	0.45255E+00	0.12436E-01	0.33320E-01
0.25842E+04	0.28024E-01	0.45263E+00	0.12685E-01	0.33986E-01
0.25844E+04	0.28574E-01	0.45271E+00	0.12936E-01	0.34659E-01
0.25846E+04	0.29124E-01	0.45279E+00	0.13187E-01	0.35332E-01
0.25848E+04	0.29677E-01	0.45287E+00	0.13440E-01	0.36010E-01
0.25850E+04	0.30235E-01	0.45295E+00	0.13695E-01	0.36692E-01
0.25852E+04	0.30797E-01	0.45299E+00	0.13951E-01	0.37378E-01
0.25854E+04	0.31370E-01	0.45302E+00	0.14211E-01	0.38076E-01
0.25856E+04	0.31984E-01	0.45305E+00	0.14490E-01	0.38824E-01
0.25858E+04	0.32617E-01	0.45308E+00	0.14778E-01	0.39595E-01
0.25860E+04	0.33218E-01	0.45312E+00	0.15052E-01	0.40328E-01
0.25862E+04	0.33799E-01	0.45322E+00	0.15319E-01	0.41043E-01
0.25864E+04	0.34384E-01	0.45333E+00	0.15587E-01	0.41762E-01
0.25866E+04	0.35020E-01	0.45343E+00	0.15879E-01	0.42545E-01
0.25868E+04	0.35714E-01	0.45353E+00	0.16197E-01	0.43397E-01
0.25870E+04	0.36419E-01	0.45363E+00	0.16521E-01	0.44263E-01
0.25872E+04	0.37103E-01	0.45372E+00	0.16835E-01	0.45105E-01
0.25874E+04	0.37782E-01	0.45382E+00	0.17146E-01	0.45940E-01
0.25876E+04	0.38468E-01	0.45392E+00	0.17461E-01	0.46784E-01
0.25878E+04	0.39179E-01	0.45402E+00	0.17788E-01	0.47659E-01
0.25880E+04	0.39983E-01	0.45413E+00	0.18157E-01	0.48648E-01
0.25882E+04	0.40812E-01	0.45427E+00	0.18540E-01	0.49673E-01
0.25884E+04	0.41612E-01	0.45442E+00	0.18909E-01	0.50663E-01
0.25886E+04	0.42427E-01	0.45456E+00	0.19286E-01	0.51672E-01
0.25888E+04	0.43302E-01	0.45472E+00	0.19690E-01	0.52756E-01
0.25890E+04	0.44217E-01	0.45487E+00	0.20113E-01	0.53889E-01
0.25892E+04	0.45179E-01	0.45503E+00	0.20558E-01	0.55080E-01
0.25894E+04	0.46182E-01	0.45519E+00	0.21021E-01	0.56322E-01
0.25896E+04	0.47176E-01	0.45535E+00	0.21481E-01	0.57555E-01
0.25898E+04	0.48135E-01	0.45551E+00	0.21926E-01	0.58746E-01
0.25900E+04	0.49068E-01	0.45567E+00	0.22359E-01	0.59906E-01
0.25902E+04	0.50022E-01	0.45575E+00	0.22798E-01	0.61082E-01
0.25904E+04	0.51015E-01	0.45584E+00	0.23254E-01	0.62305E-01

0.25906E+04	0.52074E-01	0.45592E+00	0.23742E-01	0.63610E-01
0.25908E+04	0.53193E-01	0.45599E+00	0.24256E-01	0.64987E-01
0.25910E+04	0.54320E-01	0.45606E+00	0.24773E-01	0.66375E-01
0.25912E+04	0.55398E-01	0.45613E+00	0.25268E-01	0.67701E-01
0.25914E+04	0.56447E-01	0.45619E+00	0.25750E-01	0.68993E-01
0.25916E+04	0.57546E-01	0.45624E+00	0.26255E-01	0.70345E-01
0.25918E+04	0.58671E-01	0.45629E+00	0.26771E-01	0.71727E-01
0.25920E+04	0.59806E-01	0.45634E+00	0.27292E-01	0.73123E-01
0.25922E+04	0.60947E-01	0.45635E+00	0.27813E-01	0.74519E-01
0.25924E+04	0.62154E-01	0.45635E+00	0.28364E-01	0.75995E-01
0.25926E+04	0.63383E-01	0.45635E+00	0.28925E-01	0.77498E-01
0.25928E+04	0.64641E-01	0.45635E+00	0.29499E-01	0.79036E-01
0.25930E+04	0.65905E-01	0.45634E+00	0.30075E-01	0.80580E-01
0.25932E+04	0.67193E-01	0.45633E+00	0.30662E-01	0.82152E-01
0.25934E+04	0.68477E-01	0.45632E+00	0.31247E-01	0.83720E-01
0.25936E+04	0.69768E-01	0.45631E+00	0.31836E-01	0.85297E-01
0.25938E+04	0.71049E-01	0.45630E+00	0.32420E-01	0.86861E-01
0.25940E+04	0.72360E-01	0.45629E+00	0.33017E-01	0.88462E-01
0.25942E+04	0.73732E-01	0.45626E+00	0.33641E-01	0.90134E-01
0.25944E+04	0.75188E-01	0.45624E+00	0.34304E-01	0.91909E-01
0.25946E+04	0.76716E-01	0.45622E+00	0.35000E-01	0.93774E-01
0.25948E+04	0.78314E-01	0.45621E+00	0.35728E-01	0.95724E-01
0.25950E+04	0.79928E-01	0.45620E+00	0.36463E-01	0.97695E-01
0.25952E+04	0.81515E-01	0.45625E+00	0.37192E-01	0.99647E-01
0.25954E+04	0.83108E-01	0.45630E+00	0.37923E-01	0.10161E+00
0.25956E+04	0.84772E-01	0.45636E+00	0.38687E-01	0.10365E+00
0.25958E+04	0.86504E-01	0.45643E+00	0.39483E-01	0.10579E+00
0.25960E+04	0.88313E-01	0.45650E+00	0.40315E-01	0.10802E+00
0.25962E+04	0.90191E-01	0.45663E+00	0.41184E-01	0.11034E+00
0.25964E+04	0.92080E-01	0.45675E+00	0.42058E-01	0.11268E+00
0.25966E+04	0.93922E-01	0.45688E+00	0.42911E-01	0.11497E+00
0.25968E+04	0.95762E-01	0.45700E+00	0.43763E-01	0.11725E+00
0.25970E+04	0.97650E-01	0.45713E+00	0.44639E-01	0.11960E+00
0.25972E+04	0.99630E-01	0.45726E+00	0.45557E-01	0.12206E+00
0.25974E+04	0.10168E+00	0.45739E+00	0.46507E-01	0.12460E+00
0.25976E+04	0.10381E+00	0.45751E+00	0.47496E-01	0.12725E+00
0.25978E+04	0.10602E+00	0.45763E+00	0.48517E-01	0.12999E+00
0.25980E+04	0.10824E+00	0.45775E+00	0.49547E-01	0.13275E+00
0.25982E+04	0.11045E+00	0.45789E+00	0.50574E-01	0.13550E+00
0.25984E+04	0.11267E+00	0.45803E+00	0.51607E-01	0.13827E+00
0.25986E+04	0.11492E+00	0.45817E+00	0.52655E-01	0.14108E+00
0.25988E+04	0.11727E+00	0.45830E+00	0.53742E-01	0.14399E+00
0.25990E+04	0.11971E+00	0.45843E+00	0.54879E-01	0.14704E+00

0.25992E+04	0.12216E+00	0.45854E+00	0.56013E-01	0.15007E+00
0.25994E+04	0.12461E+00	0.45865E+00	0.57151E-01	0.15312E+00
0.25996E+04	0.12713E+00	0.45876E+00	0.58324E-01	0.15627E+00
0.25998E+04	0.12976E+00	0.45886E+00	0.59540E-01	0.15953E+00
0.26000E+04	0.13246E+00	0.45895E+00	0.60791E-01	0.16288E+00
0.26002E+04	0.13523E+00	0.45881E+00	0.62045E-01	0.16624E+00
0.26004E+04	0.13806E+00	0.45867E+00	0.63322E-01	0.16966E+00
0.26006E+04	0.14097E+00	0.45853E+00	0.64638E-01	0.17318E+00
0.26008E+04	0.14401E+00	0.45839E+00	0.66014E-01	0.17687E+00
0.26010E+04	0.14713E+00	0.45824E+00	0.67419E-01	0.18063E+00
0.26012E+04	0.15024E+00	0.45810E+00	0.68825E-01	0.18440E+00
0.26014E+04	0.15336E+00	0.45796E+00	0.70233E-01	0.18818E+00
0.26016E+04	0.15655E+00	0.45782E+00	0.71673E-01	0.19203E+00
0.26018E+04	0.15984E+00	0.45769E+00	0.73159E-01	0.19601E+00
0.26020E+04	0.16322E+00	0.45755E+00	0.74683E-01	0.20010E+00
0.26022E+04	0.16669E+00	0.45746E+00	0.76254E-01	0.20431E+00
0.26024E+04	0.17024E+00	0.45736E+00	0.77863E-01	0.20862E+00
0.26026E+04	0.17388E+00	0.45727E+00	0.79509E-01	0.21303E+00
0.26028E+04	0.17751E+00	0.45718E+00	0.81155E-01	0.21744E+00
0.26030E+04	0.18116E+00	0.45710E+00	0.82809E-01	0.22187E+00
0.26032E+04	0.18487E+00	0.45702E+00	0.84491E-01	0.22637E+00
0.26034E+04	0.18870E+00	0.45695E+00	0.86225E-01	0.23102E+00
0.26036E+04	0.19263E+00	0.45688E+00	0.88011E-01	0.23581E+00
0.26038E+04	0.19665E+00	0.45682E+00	0.89835E-01	0.24069E+00
0.26040E+04	0.20070E+00	0.45675E+00	0.91668E-01	0.24561E+00
0.26042E+04	0.20480E+00	0.45682E+00	0.93555E-01	0.25066E+00
0.26044E+04	0.20899E+00	0.45690E+00	0.95485E-01	0.25583E+00
0.26046E+04	0.21326E+00	0.45698E+00	0.97454E-01	0.26111E+00
0.26048E+04	0.21760E+00	0.45706E+00	0.99455E-01	0.26647E+00
0.26050E+04	0.22202E+00	0.45714E+00	0.10149E+00	0.27193E+00
0.26052E+04	0.22651E+00	0.45717E+00	0.10355E+00	0.27744E+00
0.26054E+04	0.23105E+00	0.45719E+00	0.10563E+00	0.28302E+00
0.26056E+04	0.23565E+00	0.45721E+00	0.10774E+00	0.28867E+00
0.26058E+04	0.24034E+00	0.45722E+00	0.10989E+00	0.29443E+00
0.26060E+04	0.24511E+00	0.45724E+00	0.11208E+00	0.30028E+00
0.26062E+04	0.24995E+00	0.45717E+00	0.11427E+00	0.30617E+00
0.26064E+04	0.25488E+00	0.45711E+00	0.11651E+00	0.31215E+00
0.26066E+04	0.25989E+00	0.45703E+00	0.11878E+00	0.31824E+00
0.26068E+04	0.26499E+00	0.45696E+00	0.12109E+00	0.32443E+00
0.26070E+04	0.27016E+00	0.45688E+00	0.12343E+00	0.33070E+00
0.26072E+04	0.27536E+00	0.45680E+00	0.12579E+00	0.33701E+00
0.26074E+04	0.28064E+00	0.45672E+00	0.12817E+00	0.34341E+00
0.26076E+04	0.28601E+00	0.45664E+00	0.13060E+00	0.34992E+00

0.26078E+04	0.29148E+00	0.45656E+00	0.13308E+00	0.35656E+00
0.26080E+04	0.29704E+00	0.45650E+00	0.13560E+00	0.36330E+00
0.26082E+04	0.30265E+00	0.45652E+00	0.13817E+00	0.37019E+00
0.26084E+04	0.30832E+00	0.45655E+00	0.14076E+00	0.37715E+00
0.26086E+04	0.31407E+00	0.45658E+00	0.14340E+00	0.38421E+00
0.26088E+04	0.31990E+00	0.45662E+00	0.14608E+00	0.39138E+00
0.26090E+04	0.32582E+00	0.45666E+00	0.14879E+00	0.39865E+00
0.26092E+04	0.33184E+00	0.45672E+00	0.15156E+00	0.40606E+00
0.26094E+04	0.33788E+00	0.45677E+00	0.15433E+00	0.41350E+00
0.26096E+04	0.34383E+00	0.45683E+00	0.15707E+00	0.42084E+00
0.26098E+04	0.34979E+00	0.45689E+00	0.15982E+00	0.42819E+00
0.26100E+04	0.35583E+00	0.45696E+00	0.16260E+00	0.43565E+00
0.26102E+04	0.36198E+00	0.45709E+00	0.16546E+00	0.44331E+00
0.26104E+04	0.36822E+00	0.45723E+00	0.16836E+00	0.45109E+00
0.26106E+04	0.37449E+00	0.45736E+00	0.17128E+00	0.45891E+00
0.26108E+04	0.38076E+00	0.45750E+00	0.17420E+00	0.46672E+00
0.26110E+04	0.38709E+00	0.45764E+00	0.17715E+00	0.47463E+00
0.26112E+04	0.39351E+00	0.45777E+00	0.18013E+00	0.48263E+00
0.26114E+04	0.39998E+00	0.45790E+00	0.18315E+00	0.49071E+00
0.26116E+04	0.40652E+00	0.45803E+00	0.18620E+00	0.49888E+00
0.26118E+04	0.41310E+00	0.45815E+00	0.18926E+00	0.50708E+00
0.26120E+04	0.41966E+00	0.45826E+00	0.19231E+00	0.51527E+00
0.26122E+04	0.42627E+00	0.45821E+00	0.19532E+00	0.52332E+00
0.26124E+04	0.43295E+00	0.45816E+00	0.19836E+00	0.53147E+00
0.26126E+04	0.43962E+00	0.45810E+00	0.20139E+00	0.53958E+00
0.26128E+04	0.44625E+00	0.45804E+00	0.20440E+00	0.54765E+00
0.26130E+04	0.45285E+00	0.45797E+00	0.20739E+00	0.55566E+00
0.26132E+04	0.45946E+00	0.45791E+00	0.21039E+00	0.56369E+00
0.26134E+04	0.46611E+00	0.45784E+00	0.21340E+00	0.57176E+00
0.26136E+04	0.47279E+00	0.45777E+00	0.21643E+00	0.57987E+00
0.26138E+04	0.47947E+00	0.45769E+00	0.21945E+00	0.58796E+00
0.26140E+04	0.48618E+00	0.45762E+00	0.22249E+00	0.59610E+00
0.26142E+04	0.49294E+00	0.45754E+00	0.22554E+00	0.60428E+00
0.26144E+04	0.49969E+00	0.45747E+00	0.22859E+00	0.61246E+00
0.26146E+04	0.50640E+00	0.45739E+00	0.23163E+00	0.62059E+00
0.26148E+04	0.51306E+00	0.45732E+00	0.23464E+00	0.62865E+00
0.26150E+04	0.51962E+00	0.45725E+00	0.23760E+00	0.63659E+00
0.26152E+04	0.52612E+00	0.45724E+00	0.24056E+00	0.64453E+00
0.26154E+04	0.53264E+00	0.45723E+00	0.24354E+00	0.65251E+00
0.26156E+04	0.53916E+00	0.45722E+00	0.24652E+00	0.66049E+00
0.26158E+04	0.54563E+00	0.45722E+00	0.24947E+00	0.66840E+00
0.26160E+04	0.55208E+00	0.45721E+00	0.25242E+00	0.67631E+00
0.26162E+04	0.55855E+00	0.45725E+00	0.25540E+00	0.68429E+00

0.26164E+04	0.56499E+00	0.45730E+00	0.25837E+00	0.69224E+00
0.26166E+04	0.57135E+00	0.45734E+00	0.26130E+00	0.70010E+00
0.26168E+04	0.57760E+00	0.45738E+00	0.26418E+00	0.70781E+00
0.26170E+04	0.58375E+00	0.45742E+00	0.26702E+00	0.71542E+00
0.26172E+04	0.58988E+00	0.45745E+00	0.26984E+00	0.72298E+00
0.26174E+04	0.59597E+00	0.45749E+00	0.27265E+00	0.73050E+00
0.26176E+04	0.60197E+00	0.45752E+00	0.27541E+00	0.73790E+00
0.26178E+04	0.60786E+00	0.45755E+00	0.27813E+00	0.74518E+00
0.26180E+04	0.61370E+00	0.45758E+00	0.28081E+00	0.75238E+00
0.26182E+04	0.61946E+00	0.45751E+00	0.28341E+00	0.75933E+00
0.26184E+04	0.62511E+00	0.45743E+00	0.28595E+00	0.76613E+00
0.26186E+04	0.63064E+00	0.45736E+00	0.28843E+00	0.77278E+00
0.26188E+04	0.63607E+00	0.45728E+00	0.29087E+00	0.77931E+00
0.26190E+04	0.64140E+00	0.45721E+00	0.29325E+00	0.78571E+00
0.26192E+04	0.64667E+00	0.45714E+00	0.29562E+00	0.79204E+00
0.26194E+04	0.65191E+00	0.45706E+00	0.29796E+00	0.79833E+00
0.26196E+04	0.65707E+00	0.45699E+00	0.30027E+00	0.80452E+00
0.26198E+04	0.66213E+00	0.45692E+00	0.30254E+00	0.81060E+00
0.26200E+04	0.66711E+00	0.45685E+00	0.30477E+00	0.81657E+00
0.26202E+04	0.67194E+00	0.45669E+00	0.30687E+00	0.82218E+00
0.26204E+04	0.67668E+00	0.45652E+00	0.30891E+00	0.82767E+00
0.26206E+04	0.68136E+00	0.45635E+00	0.31094E+00	0.83309E+00
0.26208E+04	0.68594E+00	0.45618E+00	0.31291E+00	0.83838E+00
0.26210E+04	0.69035E+00	0.45602E+00	0.31481E+00	0.84347E+00
0.26212E+04	0.69466E+00	0.45585E+00	0.31666E+00	0.84842E+00
0.26214E+04	0.69889E+00	0.45569E+00	0.31848E+00	0.85330E+00
0.26216E+04	0.70307E+00	0.45553E+00	0.32027E+00	0.85809E+00
0.26218E+04	0.70710E+00	0.45536E+00	0.32199E+00	0.86270E+00
0.26220E+04	0.71101E+00	0.45520E+00	0.32365E+00	0.86716E+00
0.26222E+04	0.71485E+00	0.45506E+00	0.32530E+00	0.87157E+00
0.26224E+04	0.71856E+00	0.45492E+00	0.32688E+00	0.87582E+00
0.26226E+04	0.72208E+00	0.45478E+00	0.32839E+00	0.87984E+00
0.26228E+04	0.72549E+00	0.45463E+00	0.32983E+00	0.88371E+00
0.26230E+04	0.72883E+00	0.45449E+00	0.33124E+00	0.88750E+00
0.26232E+04	0.73209E+00	0.45434E+00	0.33262E+00	0.89118E+00
0.26234E+04	0.73524E+00	0.45420E+00	0.33394E+00	0.89472E+00
0.26236E+04	0.73819E+00	0.45405E+00	0.33518E+00	0.89803E+00
0.26238E+04	0.74101E+00	0.45391E+00	0.33635E+00	0.90117E+00
0.26240E+04	0.74375E+00	0.45377E+00	0.33749E+00	0.90424E+00
0.26242E+04	0.74645E+00	0.45371E+00	0.33867E+00	0.90740E+00
0.26244E+04	0.74905E+00	0.45365E+00	0.33980E+00	0.91043E+00
0.26246E+04	0.75153E+00	0.45359E+00	0.34088E+00	0.91332E+00
0.26248E+04	0.75387E+00	0.45353E+00	0.34190E+00	0.91605E+00

0.26250E+04	0.75608E+00	0.45347E+00	0.34286E+00	0.91861E+00
0.26252E+04	0.75818E+00	0.45342E+00	0.34378E+00	0.92107E+00
0.26254E+04	0.76021E+00	0.45338E+00	0.34466E+00	0.92345E+00
0.26256E+04	0.76221E+00	0.45333E+00	0.34553E+00	0.92577E+00
0.26258E+04	0.76412E+00	0.45329E+00	0.34636E+00	0.92801E+00
0.26260E+04	0.76592E+00	0.45324E+00	0.34715E+00	0.93011E+00
0.26262E+04	0.76764E+00	0.45321E+00	0.34790E+00	0.93213E+00
0.26264E+04	0.76928E+00	0.45318E+00	0.34862E+00	0.93406E+00
0.26266E+04	0.77083E+00	0.45315E+00	0.34930E+00	0.93588E+00
0.26268E+04	0.77231E+00	0.45312E+00	0.34995E+00	0.93760E+00
0.26270E+04	0.77371E+00	0.45309E+00	0.35056E+00	0.93924E+00
0.26272E+04	0.77504E+00	0.45305E+00	0.35113E+00	0.94077E+00
0.26274E+04	0.77631E+00	0.45301E+00	0.35167E+00	0.94223E+00
0.26276E+04	0.77751E+00	0.45296E+00	0.35218E+00	0.94360E+00
0.26278E+04	0.77861E+00	0.45292E+00	0.35265E+00	0.94485E+00
0.26280E+04	0.77965E+00	0.45286E+00	0.35308E+00	0.94599E+00
0.26282E+04	0.78061E+00	0.45271E+00	0.35339E+00	0.94682E+00
0.26284E+04	0.78150E+00	0.45255E+00	0.35367E+00	0.94758E+00
0.26286E+04	0.78241E+00	0.45239E+00	0.35395E+00	0.94834E+00
0.26288E+04	0.78328E+00	0.45223E+00	0.35422E+00	0.94906E+00
0.26290E+04	0.78409E+00	0.45206E+00	0.35446E+00	0.94970E+00
0.26292E+04	0.78476E+00	0.45190E+00	0.35463E+00	0.95015E+00
0.26294E+04	0.78524E+00	0.45173E+00	0.35472E+00	0.95039E+00
0.26296E+04	0.78565E+00	0.45156E+00	0.35477E+00	0.95052E+00
0.26298E+04	0.78607E+00	0.45139E+00	0.35482E+00	0.95067E+00
0.26300E+04	0.78645E+00	0.45122E+00	0.35486E+00	0.95078E+00
0.26302E+04	0.78671E+00	0.45115E+00	0.35493E+00	0.95095E+00
0.26304E+04	0.78693E+00	0.45109E+00	0.35498E+00	0.95108E+00
0.26306E+04	0.78717E+00	0.45102E+00	0.35503E+00	0.95122E+00
0.26308E+04	0.78744E+00	0.45095E+00	0.35510E+00	0.95141E+00
0.26310E+04	0.78768E+00	0.45089E+00	0.35516E+00	0.95156E+00
0.26312E+04	0.78785E+00	0.45083E+00	0.35519E+00	0.95165E+00
0.26314E+04	0.78801E+00	0.45077E+00	0.35521E+00	0.95172E+00
0.26316E+04	0.78815E+00	0.45072E+00	0.35523E+00	0.95177E+00
0.26318E+04	0.78823E+00	0.45067E+00	0.35523E+00	0.95176E+00
0.26320E+04	0.78824E+00	0.45062E+00	0.35519E+00	0.95167E+00
0.26322E+04	0.78826E+00	0.45060E+00	0.35519E+00	0.95166E+00
0.26324E+04	0.78827E+00	0.45059E+00	0.35519E+00	0.95164E+00
0.26326E+04	0.78825E+00	0.45058E+00	0.35517E+00	0.95160E+00
0.26328E+04	0.78821E+00	0.45058E+00	0.35515E+00	0.95155E+00
0.26330E+04	0.78812E+00	0.45058E+00	0.35511E+00	0.95144E+00
0.26332E+04	0.78802E+00	0.45060E+00	0.35508E+00	0.95136E+00
0.26334E+04	0.78791E+00	0.45062E+00	0.35505E+00	0.95127E+00

0.26336E+04	0.78781E+00	0.45065E+00	0.35502E+00	0.95120E+00
0.26338E+04	0.78769E+00	0.45068E+00	0.35500E+00	0.95114E+00
0.26340E+04	0.78756E+00	0.45072E+00	0.35497E+00	0.95106E+00
0.26342E+04	0.78739E+00	0.45079E+00	0.35495E+00	0.95102E+00
0.26344E+04	0.78719E+00	0.45087E+00	0.35492E+00	0.95093E+00
0.26346E+04	0.78698E+00	0.45095E+00	0.35489E+00	0.95085E+00
0.26348E+04	0.78680E+00	0.45104E+00	0.35488E+00	0.95082E+00
0.26350E+04	0.78663E+00	0.45113E+00	0.35487E+00	0.95079E+00
0.26352E+04	0.78643E+00	0.45117E+00	0.35482E+00	0.95066E+00
0.26354E+04	0.78626E+00	0.45122E+00	0.35477E+00	0.95054E+00
0.26356E+04	0.78612E+00	0.45127E+00	0.35475E+00	0.95047E+00
0.26358E+04	0.78598E+00	0.45131E+00	0.35472E+00	0.95039E+00
0.26360E+04	0.78582E+00	0.45135E+00	0.35468E+00	0.95029E+00
0.26362E+04	0.78565E+00	0.45144E+00	0.35467E+00	0.95026E+00
0.26364E+04	0.78549E+00	0.45153E+00	0.35467E+00	0.95026E+00
0.26366E+04	0.78530E+00	0.45161E+00	0.35465E+00	0.95021E+00
0.26368E+04	0.78507E+00	0.45169E+00	0.35461E+00	0.95009E+00
0.26370E+04	0.78481E+00	0.45176E+00	0.35455E+00	0.94994E+00
0.26372E+04	0.78460E+00	0.45182E+00	0.35450E+00	0.94981E+00
0.26374E+04	0.78444E+00	0.45188E+00	0.35447E+00	0.94974E+00
0.26376E+04	0.78426E+00	0.45193E+00	0.35443E+00	0.94963E+00
0.26378E+04	0.78412E+00	0.45198E+00	0.35440E+00	0.94955E+00
0.26380E+04	0.78401E+00	0.45200E+00	0.35437E+00	0.94946E+00
0.26382E+04	0.78388E+00	0.45187E+00	0.35421E+00	0.94903E+00
0.26384E+04	0.78370E+00	0.45174E+00	0.35402E+00	0.94853E+00
0.26386E+04	0.78351E+00	0.45160E+00	0.35384E+00	0.94802E+00
0.26388E+04	0.78335E+00	0.45146E+00	0.35366E+00	0.94754E+00
0.26390E+04	0.78324E+00	0.45133E+00	0.35349E+00	0.94711E+00
0.26392E+04	0.78320E+00	0.45119E+00	0.35337E+00	0.94677E+00
0.26394E+04	0.78319E+00	0.45105E+00	0.35326E+00	0.94648E+00
0.26396E+04	0.78317E+00	0.45091E+00	0.35314E+00	0.94616E+00
0.26398E+04	0.78314E+00	0.45078E+00	0.35302E+00	0.94584E+00
0.26400E+04	0.78312E+00	0.45064E+00	0.35290E+00	0.94553E+00
0.26402E+04	0.78308E+00	0.45066E+00	0.35290E+00	0.94553E+00
0.26404E+04	0.78311E+00	0.45068E+00	0.35293E+00	0.94559E+00
0.26406E+04	0.78316E+00	0.45069E+00	0.35297E+00	0.94570E+00
0.26408E+04	0.78318E+00	0.45071E+00	0.35299E+00	0.94576E+00
0.26410E+04	0.78316E+00	0.45073E+00	0.35300E+00	0.94578E+00
0.26412E+04	0.78316E+00	0.45076E+00	0.35302E+00	0.94583E+00
0.26414E+04	0.78319E+00	0.45078E+00	0.35305E+00	0.94591E+00
0.26416E+04	0.78322E+00	0.45080E+00	0.35308E+00	0.94599E+00
0.26418E+04	0.78324E+00	0.45083E+00	0.35311E+00	0.94608E+00
0.26420E+04	0.78333E+00	0.45085E+00	0.35316E+00	0.94623E+00

0.26422E+04	0.78343E+00	0.45098E+00	0.35331E+00	0.94662E+00
0.26424E+04	0.78354E+00	0.45111E+00	0.35346E+00	0.94702E+00
0.26426E+04	0.78368E+00	0.45124E+00	0.35363E+00	0.94747E+00
0.26428E+04	0.78384E+00	0.45138E+00	0.35381E+00	0.94796E+00
0.26430E+04	0.78396E+00	0.45151E+00	0.35397E+00	0.94838E+00
0.26432E+04	0.78404E+00	0.45165E+00	0.35412E+00	0.94877E+00
0.26434E+04	0.78418E+00	0.45179E+00	0.35429E+00	0.94924E+00
0.26436E+04	0.78437E+00	0.45194E+00	0.35449E+00	0.94977E+00
0.26438E+04	0.78457E+00	0.45209E+00	0.35470E+00	0.95033E+00
0.26440E+04	0.78472E+00	0.45224E+00	0.35488E+00	0.95082E+00
0.26442E+04	0.78482E+00	0.45233E+00	0.35500E+00	0.95114E+00
0.26444E+04	0.78497E+00	0.45242E+00	0.35513E+00	0.95151E+00
0.26446E+04	0.78519E+00	0.45251E+00	0.35530E+00	0.95196E+00
0.26448E+04	0.78544E+00	0.45260E+00	0.35549E+00	0.95245E+00
0.26450E+04	0.78567E+00	0.45269E+00	0.35566E+00	0.95292E+00
0.26452E+04	0.78594E+00	0.45281E+00	0.35588E+00	0.95350E+00
0.26454E+04	0.78626E+00	0.45292E+00	0.35612E+00	0.95413E+00
0.26456E+04	0.78661E+00	0.45304E+00	0.35637E+00	0.95481E+00
0.26458E+04	0.78692E+00	0.45316E+00	0.35660E+00	0.95543E+00
0.26460E+04	0.78719E+00	0.45327E+00	0.35681E+00	0.95600E+00
0.26462E+04	0.78748E+00	0.45330E+00	0.35696E+00	0.95640E+00
0.26464E+04	0.78779E+00	0.45332E+00	0.35712E+00	0.95683E+00
0.26466E+04	0.78810E+00	0.45334E+00	0.35728E+00	0.95725E+00
0.26468E+04	0.78840E+00	0.45336E+00	0.35742E+00	0.95764E+00
0.26470E+04	0.78871E+00	0.45337E+00	0.35758E+00	0.95806E+00
0.26472E+04	0.78904E+00	0.45338E+00	0.35773E+00	0.95847E+00
0.26474E+04	0.78938E+00	0.45338E+00	0.35789E+00	0.95889E+00
0.26476E+04	0.78973E+00	0.45339E+00	0.35805E+00	0.95933E+00
0.26478E+04	0.79011E+00	0.45339E+00	0.35823E+00	0.95979E+00
0.26480E+04	0.79052E+00	0.45339E+00	0.35841E+00	0.96028E+00
0.26482E+04	0.79094E+00	0.45339E+00	0.35860E+00	0.96080E+00
0.26484E+04	0.79140E+00	0.45339E+00	0.35881E+00	0.96135E+00
0.26486E+04	0.79181E+00	0.45339E+00	0.35899E+00	0.96185E+00
0.26488E+04	0.79218E+00	0.45339E+00	0.35917E+00	0.96231E+00
0.26490E+04	0.79255E+00	0.45339E+00	0.35933E+00	0.96276E+00
0.26492E+04	0.79293E+00	0.45340E+00	0.35952E+00	0.96324E+00
0.26494E+04	0.79332E+00	0.45341E+00	0.35970E+00	0.96374E+00
0.26496E+04	0.79372E+00	0.45342E+00	0.35989E+00	0.96425E+00
0.26498E+04	0.79408E+00	0.45344E+00	0.36007E+00	0.96472E+00
0.26500E+04	0.79449E+00	0.45346E+00	0.36027E+00	0.96525E+00
0.26502E+04	0.79498E+00	0.45346E+00	0.36049E+00	0.96587E+00
0.26504E+04	0.79550E+00	0.45347E+00	0.36073E+00	0.96651E+00
0.26506E+04	0.79601E+00	0.45347E+00	0.36097E+00	0.96714E+00

0.26508E+04	0.79652E+00	0.45348E+00	0.36120E+00	0.96777E+00
0.26510E+04	0.79703E+00	0.45349E+00	0.36144E+00	0.96840E+00
0.26512E+04	0.79759E+00	0.45349E+00	0.36170E+00	0.96910E+00
0.26514E+04	0.79816E+00	0.45349E+00	0.36196E+00	0.96980E+00
0.26516E+04	0.79865E+00	0.45349E+00	0.36218E+00	0.97039E+00
0.26518E+04	0.79914E+00	0.45349E+00	0.36240E+00	0.97098E+00
0.26520E+04	0.79966E+00	0.45349E+00	0.36263E+00	0.97160E+00
0.26522E+04	0.80019E+00	0.45352E+00	0.36290E+00	0.97232E+00
0.26524E+04	0.80074E+00	0.45357E+00	0.36319E+00	0.97310E+00
0.26526E+04	0.80130E+00	0.45361E+00	0.36348E+00	0.97386E+00
0.26528E+04	0.80176E+00	0.45365E+00	0.36371E+00	0.97449E+00
0.26530E+04	0.80215E+00	0.45368E+00	0.36392E+00	0.97504E+00
0.26532E+04	0.80255E+00	0.45370E+00	0.36412E+00	0.97558E+00
0.26534E+04	0.80297E+00	0.45372E+00	0.36433E+00	0.97614E+00
0.26536E+04	0.80343E+00	0.45374E+00	0.36455E+00	0.97673E+00
0.26538E+04	0.80388E+00	0.45376E+00	0.36476E+00	0.97731E+00
0.26540E+04	0.80429E+00	0.45377E+00	0.36496E+00	0.97784E+00
0.26542E+04	0.80473E+00	0.45381E+00	0.36519E+00	0.97846E+00
0.26544E+04	0.80521E+00	0.45385E+00	0.36544E+00	0.97912E+00
0.26546E+04	0.80573E+00	0.45388E+00	0.36571E+00	0.97984E+00
0.26548E+04	0.80625E+00	0.45392E+00	0.36597E+00	0.98055E+00
0.26550E+04	0.80669E+00	0.45396E+00	0.36621E+00	0.98118E+00
0.26552E+04	0.80713E+00	0.45400E+00	0.36644E+00	0.98178E+00
0.26554E+04	0.80764E+00	0.45403E+00	0.36669E+00	0.98247E+00
0.26556E+04	0.80812E+00	0.45406E+00	0.36694E+00	0.98313E+00
0.26558E+04	0.80848E+00	0.45411E+00	0.36714E+00	0.98367E+00
0.26560E+04	0.80884E+00	0.45416E+00	0.36734E+00	0.98421E+00
0.26562E+04	0.80921E+00	0.45429E+00	0.36762E+00	0.98495E+00
0.26564E+04	0.80960E+00	0.45442E+00	0.36790E+00	0.98570E+00
0.26566E+04	0.80993E+00	0.45456E+00	0.36816E+00	0.98640E+00
0.26568E+04	0.81020E+00	0.45469E+00	0.36839E+00	0.98702E+00
0.26570E+04	0.81050E+00	0.45483E+00	0.36864E+00	0.98770E+00
0.26572E+04	0.81085E+00	0.45498E+00	0.36892E+00	0.98844E+00
0.26574E+04	0.81118E+00	0.45513E+00	0.36920E+00	0.98918E+00
0.26576E+04	0.81148E+00	0.45528E+00	0.36946E+00	0.98988E+00
0.26578E+04	0.81175E+00	0.45544E+00	0.36970E+00	0.99054E+00
0.26580E+04	0.81199E+00	0.45559E+00	0.36994E+00	0.99117E+00
0.26582E+04	0.81220E+00	0.45576E+00	0.37017E+00	0.99178E+00
0.26584E+04	0.81241E+00	0.45592E+00	0.37040E+00	0.99239E+00
0.26586E+04	0.81265E+00	0.45609E+00	0.37064E+00	0.99305E+00
0.26588E+04	0.81292E+00	0.45626E+00	0.37090E+00	0.99375E+00
0.26590E+04	0.81317E+00	0.45643E+00	0.37115E+00	0.99442E+00
0.26592E+04	0.81340E+00	0.45660E+00	0.37140E+00	0.99509E+00

0.26594E+04	0.81361E+00	0.45678E+00	0.37164E+00	0.99572E+00
0.26596E+04	0.81376E+00	0.45695E+00	0.37185E+00	0.99629E+00
0.26598E+04	0.81387E+00	0.45714E+00	0.37205E+00	0.99683E+00
0.26600E+04	0.81396E+00	0.45732E+00	0.37224E+00	0.99733E+00
0.26602E+04	0.81403E+00	0.45739E+00	0.37233E+00	0.99757E+00
0.26604E+04	0.81411E+00	0.45746E+00	0.37243E+00	0.99784E+00
0.26606E+04	0.81416E+00	0.45754E+00	0.37251E+00	0.99805E+00
0.26608E+04	0.81414E+00	0.45761E+00	0.37256E+00	0.99819E+00
0.26610E+04	0.81414E+00	0.45769E+00	0.37262E+00	0.99835E+00
0.26612E+04	0.81415E+00	0.45776E+00	0.37268E+00	0.99853E+00
0.26614E+04	0.81416E+00	0.45783E+00	0.37275E+00	0.99869E+00
0.26616E+04	0.81415E+00	0.45790E+00	0.37279E+00	0.99882E+00
0.26618E+04	0.81409E+00	0.45796E+00	0.37282E+00	0.99889E+00
0.26620E+04	0.81401E+00	0.45804E+00	0.37285E+00	0.99896E+00
0.26622E+04	0.81390E+00	0.45820E+00	0.37292E+00	0.99917E+00
0.26624E+04	0.81375E+00	0.45836E+00	0.37299E+00	0.99934E+00
0.26626E+04	0.81364E+00	0.45851E+00	0.37306E+00	0.99954E+00
0.26628E+04	0.81353E+00	0.45866E+00	0.37313E+00	0.99973E+00
0.26630E+04	0.81336E+00	0.45881E+00	0.37318E+00	0.99985E+00
0.26632E+04	0.81316E+00	0.45896E+00	0.37321E+00	0.99993E+00
0.26634E+04	0.81297E+00	0.45910E+00	0.37323E+00	0.10000E+01
0.26636E+04	0.81270E+00	0.45924E+00	0.37322E+00	0.99997E+00
0.26638E+04	0.81234E+00	0.45938E+00	0.37317E+00	0.99983E+00
0.26640E+04	0.81196E+00	0.45951E+00	0.37310E+00	0.99965E+00
0.26642E+04	0.81166E+00	0.45960E+00	0.37303E+00	0.99946E+00
0.26644E+04	0.81144E+00	0.45968E+00	0.37301E+00	0.99940E+00
0.26646E+04	0.81121E+00	0.45977E+00	0.37297E+00	0.99930E+00
0.26648E+04	0.81091E+00	0.45986E+00	0.37290E+00	0.99911E+00
0.26650E+04	0.81060E+00	0.45994E+00	0.37283E+00	0.99892E+00
0.26652E+04	0.81031E+00	0.46004E+00	0.37278E+00	0.99878E+00
0.26654E+04	0.81002E+00	0.46014E+00	0.37272E+00	0.99863E+00
0.26656E+04	0.80971E+00	0.46023E+00	0.37266E+00	0.99845E+00
0.26658E+04	0.80934E+00	0.46033E+00	0.37256E+00	0.99820E+00
0.26660E+04	0.80895E+00	0.46042E+00	0.37246E+00	0.99793E+00
0.26662E+04	0.80858E+00	0.46046E+00	0.37232E+00	0.99755E+00
0.26664E+04	0.80819E+00	0.46049E+00	0.37216E+00	0.99712E+00
0.26666E+04	0.80774E+00	0.46051E+00	0.37197E+00	0.99662E+00
0.26668E+04	0.80728E+00	0.46054E+00	0.37178E+00	0.99610E+00
0.26670E+04	0.80680E+00	0.46056E+00	0.37158E+00	0.99557E+00
0.26672E+04	0.80632E+00	0.46058E+00	0.37138E+00	0.99503E+00
0.26674E+04	0.80582E+00	0.46060E+00	0.37116E+00	0.99445E+00
0.26676E+04	0.80528E+00	0.46063E+00	0.37094E+00	0.99384E+00
0.26678E+04	0.80476E+00	0.46065E+00	0.37071E+00	0.99324E+00

0.26680E+04	0.80423E+00	0.46067E+00	0.37048E+00	0.99262E+00
0.26682E+04	0.80363E+00	0.46068E+00	0.37022E+00	0.99192E+00
0.26684E+04	0.80301E+00	0.46069E+00	0.36994E+00	0.99118E+00
0.26686E+04	0.80240E+00	0.46071E+00	0.36967E+00	0.99045E+00
0.26688E+04	0.80185E+00	0.46072E+00	0.36943E+00	0.98980E+00
0.26690E+04	0.80136E+00	0.46074E+00	0.36922E+00	0.98923E+00
0.26692E+04	0.80082E+00	0.46076E+00	0.36899E+00	0.98862E+00
0.26694E+04	0.80020E+00	0.46078E+00	0.36872E+00	0.98789E+00
0.26696E+04	0.79957E+00	0.46080E+00	0.36845E+00	0.98717E+00
0.26698E+04	0.79898E+00	0.46083E+00	0.36819E+00	0.98649E+00
0.26700E+04	0.79843E+00	0.46085E+00	0.36796E+00	0.98586E+00
0.26702E+04	0.79782E+00	0.46087E+00	0.36769E+00	0.98515E+00
0.26704E+04	0.79713E+00	0.46089E+00	0.36739E+00	0.98434E+00
0.26706E+04	0.79647E+00	0.46090E+00	0.36709E+00	0.98355E+00
0.26708E+04	0.79585E+00	0.46092E+00	0.36682E+00	0.98282E+00
0.26710E+04	0.79521E+00	0.46093E+00	0.36654E+00	0.98206E+00
0.26712E+04	0.79453E+00	0.46094E+00	0.36624E+00	0.98125E+00
0.26714E+04	0.79381E+00	0.46095E+00	0.36591E+00	0.98037E+00
0.26716E+04	0.79304E+00	0.46096E+00	0.36556E+00	0.97944E+00
0.26718E+04	0.79231E+00	0.46096E+00	0.36523E+00	0.97854E+00
0.26720E+04	0.79155E+00	0.46097E+00	0.36488E+00	0.97761E+00
0.26722E+04	0.79075E+00	0.46101E+00	0.36454E+00	0.97671E+00
0.26724E+04	0.78996E+00	0.46105E+00	0.36421E+00	0.97583E+00
0.26726E+04	0.78912E+00	0.46110E+00	0.36386E+00	0.97488E+00
0.26728E+04	0.78818E+00	0.46114E+00	0.36346E+00	0.97381E+00
0.26730E+04	0.78726E+00	0.46118E+00	0.36307E+00	0.97276E+00
0.26732E+04	0.78638E+00	0.46121E+00	0.36269E+00	0.97174E+00
0.26734E+04	0.78550E+00	0.46125E+00	0.36231E+00	0.97074E+00
0.26736E+04	0.78461E+00	0.46129E+00	0.36193E+00	0.96972E+00
0.26738E+04	0.78368E+00	0.46133E+00	0.36154E+00	0.96866E+00
0.26740E+04	0.78276E+00	0.46138E+00	0.36115E+00	0.96762E+00
0.26742E+04	0.78190E+00	0.46136E+00	0.36074E+00	0.96653E+00
0.26744E+04	0.78098E+00	0.46135E+00	0.36031E+00	0.96536E+00
0.26746E+04	0.78005E+00	0.46134E+00	0.35987E+00	0.96419E+00
0.26748E+04	0.77913E+00	0.46134E+00	0.35944E+00	0.96304E+00
0.26750E+04	0.77822E+00	0.46134E+00	0.35902E+00	0.96192E+00
0.26752E+04	0.77736E+00	0.46134E+00	0.35862E+00	0.96085E+00
0.26754E+04	0.77644E+00	0.46134E+00	0.35820E+00	0.95973E+00
0.26756E+04	0.77545E+00	0.46134E+00	0.35775E+00	0.95851E+00
0.26758E+04	0.77448E+00	0.46135E+00	0.35731E+00	0.95733E+00
0.26760E+04	0.77353E+00	0.46136E+00	0.35688E+00	0.95617E+00
0.26762E+04	0.77254E+00	0.46132E+00	0.35639E+00	0.95487E+00
0.26764E+04	0.77156E+00	0.46128E+00	0.35590E+00	0.95357E+00

0.26766E+04	0.77060E+00	0.46123E+00	0.35543E+00	0.95229E+00
0.26768E+04	0.76968E+00	0.46118E+00	0.35496E+00	0.95105E+00
0.26770E+04	0.76882E+00	0.46114E+00	0.35453E+00	0.94990E+00
0.26772E+04	0.76797E+00	0.46109E+00	0.35410E+00	0.94874E+00
0.26774E+04	0.76709E+00	0.46104E+00	0.35366E+00	0.94755E+00
0.26776E+04	0.76617E+00	0.46098E+00	0.35319E+00	0.94629E+00
0.26778E+04	0.76521E+00	0.46092E+00	0.35270E+00	0.94498E+00
0.26780E+04	0.76429E+00	0.46086E+00	0.35223E+00	0.94372E+00
0.26782E+04	0.76342E+00	0.46090E+00	0.35186E+00	0.94274E+00
0.26784E+04	0.76256E+00	0.46096E+00	0.35151E+00	0.94179E+00
0.26786E+04	0.76174E+00	0.46101E+00	0.35117E+00	0.94089E+00
0.26788E+04	0.76093E+00	0.46106E+00	0.35084E+00	0.93999E+00
0.26790E+04	0.76009E+00	0.46111E+00	0.35048E+00	0.93904E+00
0.26792E+04	0.75929E+00	0.46115E+00	0.35015E+00	0.93814E+00
0.26794E+04	0.75853E+00	0.46119E+00	0.34983E+00	0.93728E+00
0.26796E+04	0.75776E+00	0.46123E+00	0.34950E+00	0.93642E+00
0.26798E+04	0.75702E+00	0.46127E+00	0.34919E+00	0.93558E+00
0.26800E+04	0.75630E+00	0.46131E+00	0.34888E+00	0.93476E+00
0.26802E+04	0.75561E+00	0.46124E+00	0.34851E+00	0.93377E+00
0.26804E+04	0.75495E+00	0.46117E+00	0.34816E+00	0.93283E+00
0.26806E+04	0.75430E+00	0.46111E+00	0.34781E+00	0.93189E+00
0.26808E+04	0.75366E+00	0.46104E+00	0.34747E+00	0.93097E+00
0.26810E+04	0.75306E+00	0.46098E+00	0.34715E+00	0.93010E+00
0.26812E+04	0.75246E+00	0.46091E+00	0.34682E+00	0.92923E+00
0.26814E+04	0.75185E+00	0.46085E+00	0.34649E+00	0.92834E+00
0.26816E+04	0.75122E+00	0.46079E+00	0.34616E+00	0.92745E+00
0.26818E+04	0.75061E+00	0.46073E+00	0.34583E+00	0.92658E+00
0.26820E+04	0.75007E+00	0.46067E+00	0.34553E+00	0.92577E+00
0.26822E+04	0.74952E+00	0.46056E+00	0.34519E+00	0.92488E+00
0.26824E+04	0.74896E+00	0.46045E+00	0.34486E+00	0.92397E+00
0.26826E+04	0.74848E+00	0.46034E+00	0.34455E+00	0.92315E+00
0.26828E+04	0.74799E+00	0.46023E+00	0.34425E+00	0.92234E+00
0.26830E+04	0.74743E+00	0.46013E+00	0.34391E+00	0.92144E+00
0.26832E+04	0.74687E+00	0.46003E+00	0.34358E+00	0.92056E+00
0.26834E+04	0.74634E+00	0.45993E+00	0.34326E+00	0.91970E+00
0.26836E+04	0.74582E+00	0.45983E+00	0.34295E+00	0.91886E+00
0.26838E+04	0.74532E+00	0.45974E+00	0.34265E+00	0.91806E+00
0.26840E+04	0.74485E+00	0.45965E+00	0.34237E+00	0.91730E+00
0.26842E+04	0.74442E+00	0.45965E+00	0.34217E+00	0.91677E+00
0.26844E+04	0.74402E+00	0.45965E+00	0.34199E+00	0.91628E+00
0.26846E+04	0.74359E+00	0.45965E+00	0.34179E+00	0.91575E+00
0.26848E+04	0.74313E+00	0.45965E+00	0.34158E+00	0.91519E+00
0.26850E+04	0.74270E+00	0.45965E+00	0.34139E+00	0.91467E+00

0.26852E+04	0.74230E+00	0.45967E+00	0.34121E+00	0.91421E+00
0.26854E+04	0.74197E+00	0.45968E+00	0.34107E+00	0.91382E+00
0.26856E+04	0.74170E+00	0.45969E+00	0.34095E+00	0.91351E+00
0.26858E+04	0.74145E+00	0.45970E+00	0.34084E+00	0.91322E+00
0.26860E+04	0.74117E+00	0.45971E+00	0.34072E+00	0.91289E+00
0.26862E+04	0.74089E+00	0.45970E+00	0.34058E+00	0.91252E+00
0.26864E+04	0.74063E+00	0.45968E+00	0.34046E+00	0.91218E+00
0.26866E+04	0.74035E+00	0.45967E+00	0.34031E+00	0.91179E+00
0.26868E+04	0.74000E+00	0.45964E+00	0.34013E+00	0.91131E+00
0.26870E+04	0.73965E+00	0.45961E+00	0.33995E+00	0.91083E+00
0.26872E+04	0.73938E+00	0.45958E+00	0.33980E+00	0.91043E+00
0.26874E+04	0.73915E+00	0.45954E+00	0.33967E+00	0.91008E+00
0.26876E+04	0.73897E+00	0.45950E+00	0.33956E+00	0.90978E+00
0.26878E+04	0.73882E+00	0.45946E+00	0.33946E+00	0.90950E+00
0.26880E+04	0.73864E+00	0.45941E+00	0.33934E+00	0.90919E+00
0.26882E+04	0.73843E+00	0.45935E+00	0.33919E+00	0.90880E+00
0.26884E+04	0.73826E+00	0.45928E+00	0.33906E+00	0.90845E+00
0.26886E+04	0.73813E+00	0.45921E+00	0.33896E+00	0.90816E+00
0.26888E+04	0.73805E+00	0.45914E+00	0.33887E+00	0.90793E+00
0.26890E+04	0.73796E+00	0.45908E+00	0.33878E+00	0.90769E+00
0.26892E+04	0.73781E+00	0.45902E+00	0.33867E+00	0.90738E+00
0.26894E+04	0.73769E+00	0.45896E+00	0.33857E+00	0.90713E+00
0.26896E+04	0.73767E+00	0.45890E+00	0.33852E+00	0.90699E+00
0.26898E+04	0.73765E+00	0.45885E+00	0.33847E+00	0.90687E+00
0.26900E+04	0.73758E+00	0.45880E+00	0.33840E+00	0.90668E+00
0.26902E+04	0.73747E+00	0.45872E+00	0.33829E+00	0.90638E+00
0.26904E+04	0.73736E+00	0.45864E+00	0.33818E+00	0.90608E+00
0.26906E+04	0.73731E+00	0.45856E+00	0.33810E+00	0.90586E+00
0.26908E+04	0.73728E+00	0.45848E+00	0.33803E+00	0.90567E+00
0.26910E+04	0.73728E+00	0.45840E+00	0.33797E+00	0.90552E+00
0.26912E+04	0.73734E+00	0.45832E+00	0.33794E+00	0.90543E+00
0.26914E+04	0.73740E+00	0.45824E+00	0.33791E+00	0.90535E+00
0.26916E+04	0.73742E+00	0.45816E+00	0.33786E+00	0.90522E+00
0.26918E+04	0.73744E+00	0.45808E+00	0.33780E+00	0.90507E+00
0.26920E+04	0.73746E+00	0.45799E+00	0.33775E+00	0.90493E+00
0.26922E+04	0.73748E+00	0.45790E+00	0.33770E+00	0.90479E+00
0.26924E+04	0.73749E+00	0.45782E+00	0.33763E+00	0.90462E+00
0.26926E+04	0.73748E+00	0.45773E+00	0.33756E+00	0.90443E+00
0.26928E+04	0.73751E+00	0.45763E+00	0.33750E+00	0.90427E+00
0.26930E+04	0.73755E+00	0.45753E+00	0.33745E+00	0.90413E+00
0.26932E+04	0.73754E+00	0.45743E+00	0.33737E+00	0.90391E+00
0.26934E+04	0.73749E+00	0.45732E+00	0.33727E+00	0.90364E+00
0.26936E+04	0.73745E+00	0.45721E+00	0.33717E+00	0.90337E+00

0.26938E+04	0.73744E+00	0.45710E+00	0.33708E+00	0.90314E+00
0.26940E+04	0.73742E+00	0.45700E+00	0.33700E+00	0.90292E+00
0.26942E+04	0.73736E+00	0.45691E+00	0.33691E+00	0.90267E+00
0.26944E+04	0.73723E+00	0.45683E+00	0.33679E+00	0.90235E+00
0.26946E+04	0.73711E+00	0.45675E+00	0.33668E+00	0.90205E+00
0.26948E+04	0.73698E+00	0.45668E+00	0.33656E+00	0.90175E+00
0.26950E+04	0.73682E+00	0.45661E+00	0.33644E+00	0.90141E+00
0.26952E+04	0.73663E+00	0.45655E+00	0.33631E+00	0.90106E+00
0.26954E+04	0.73640E+00	0.45649E+00	0.33615E+00	0.90065E+00
0.26956E+04	0.73614E+00	0.45643E+00	0.33600E+00	0.90023E+00
0.26958E+04	0.73584E+00	0.45638E+00	0.33582E+00	0.89977E+00
0.26960E+04	0.73550E+00	0.45633E+00	0.33563E+00	0.89926E+00
0.26962E+04	0.73519E+00	0.45621E+00	0.33540E+00	0.89864E+00
0.26964E+04	0.73485E+00	0.45609E+00	0.33516E+00	0.89798E+00
0.26966E+04	0.73446E+00	0.45597E+00	0.33489E+00	0.89726E+00
0.26968E+04	0.73402E+00	0.45585E+00	0.33460E+00	0.89649E+00
0.26970E+04	0.73354E+00	0.45573E+00	0.33430E+00	0.89568E+00
0.26972E+04	0.73303E+00	0.45561E+00	0.33398E+00	0.89482E+00
0.26974E+04	0.73245E+00	0.45549E+00	0.33363E+00	0.89389E+00
0.26976E+04	0.73180E+00	0.45537E+00	0.33324E+00	0.89285E+00
0.26978E+04	0.73108E+00	0.45525E+00	0.33282E+00	0.89173E+00
0.26980E+04	0.73030E+00	0.45513E+00	0.33238E+00	0.89054E+00
0.26982E+04	0.72942E+00	0.45497E+00	0.33187E+00	0.88917E+00
0.26984E+04	0.72852E+00	0.45482E+00	0.33135E+00	0.88777E+00
0.26986E+04	0.72765E+00	0.45466E+00	0.33083E+00	0.88639E+00
0.26988E+04	0.72673E+00	0.45449E+00	0.33029E+00	0.88494E+00
0.26990E+04	0.72570E+00	0.45432E+00	0.32970E+00	0.88337E+00
0.26992E+04	0.72456E+00	0.45415E+00	0.32906E+00	0.88165E+00
0.26994E+04	0.72330E+00	0.45398E+00	0.32836E+00	0.87978E+00
0.26996E+04	0.72197E+00	0.45381E+00	0.32764E+00	0.87783E+00
0.26998E+04	0.72061E+00	0.45363E+00	0.32689E+00	0.87583E+00
0.27000E+04	0.71917E+00	0.45346E+00	0.32611E+00	0.87374E+00
0.27002E+04	0.71765E+00	0.45339E+00	0.32538E+00	0.87177E+00
0.27004E+04	0.71605E+00	0.45332E+00	0.32460E+00	0.86970E+00
0.27006E+04	0.71439E+00	0.45326E+00	0.32380E+00	0.86755E+00
0.27008E+04	0.71265E+00	0.45319E+00	0.32296E+00	0.86531E+00
0.27010E+04	0.71081E+00	0.45312E+00	0.32208E+00	0.86295E+00
0.27012E+04	0.70887E+00	0.45305E+00	0.32115E+00	0.86046E+00
0.27014E+04	0.70683E+00	0.45298E+00	0.32018E+00	0.85785E+00
0.27016E+04	0.70466E+00	0.45291E+00	0.31915E+00	0.85509E+00
0.27018E+04	0.70236E+00	0.45284E+00	0.31806E+00	0.85217E+00
0.27020E+04	0.70001E+00	0.45278E+00	0.31695E+00	0.84919E+00
0.27022E+04	0.69757E+00	0.45277E+00	0.31584E+00	0.84621E+00

0.27024E+04	0.69505E+00	0.45276E+00	0.31469E+00	0.84314E+00
0.27026E+04	0.69244E+00	0.45274E+00	0.31350E+00	0.83995E+00
0.27028E+04	0.68971E+00	0.45273E+00	0.31225E+00	0.83661E+00
0.27030E+04	0.68683E+00	0.45271E+00	0.31094E+00	0.83309E+00
0.27032E+04	0.68383E+00	0.45269E+00	0.30956E+00	0.82941E+00
0.27034E+04	0.68069E+00	0.45268E+00	0.30813E+00	0.82557E+00
0.27036E+04	0.67743E+00	0.45266E+00	0.30664E+00	0.82158E+00
0.27038E+04	0.67405E+00	0.45264E+00	0.30510E+00	0.81745E+00
0.27040E+04	0.67055E+00	0.45262E+00	0.30351E+00	0.81318E+00
0.27042E+04	0.66696E+00	0.45256E+00	0.30184E+00	0.80872E+00
0.27044E+04	0.66326E+00	0.45250E+00	0.30013E+00	0.80413E+00
0.27046E+04	0.65946E+00	0.45245E+00	0.29837E+00	0.79941E+00
0.27048E+04	0.65554E+00	0.45239E+00	0.29656E+00	0.79457E+00
0.27050E+04	0.65154E+00	0.45234E+00	0.29472E+00	0.78963E+00
0.27052E+04	0.64749E+00	0.45228E+00	0.29285E+00	0.78462E+00
0.27054E+04	0.64336E+00	0.45223E+00	0.29094E+00	0.77952E+00
0.27056E+04	0.63910E+00	0.45218E+00	0.28899E+00	0.77428E+00
0.27058E+04	0.63471E+00	0.45213E+00	0.28697E+00	0.76888E+00
0.27060E+04	0.63020E+00	0.45208E+00	0.28491E+00	0.76334E+00
0.27062E+04	0.62560E+00	0.45208E+00	0.28282E+00	0.75775E+00
0.27064E+04	0.62086E+00	0.45207E+00	0.28067E+00	0.75201E+00
0.27066E+04	0.61597E+00	0.45206E+00	0.27845E+00	0.74606E+00
0.27068E+04	0.61094E+00	0.45205E+00	0.27618E+00	0.73996E+00
0.27070E+04	0.60588E+00	0.45204E+00	0.27388E+00	0.73380E+00
0.27072E+04	0.60074E+00	0.45203E+00	0.27155E+00	0.72756E+00
0.27074E+04	0.59550E+00	0.45201E+00	0.26917E+00	0.72119E+00
0.27076E+04	0.59017E+00	0.45199E+00	0.26676E+00	0.71471E+00
0.27078E+04	0.58476E+00	0.45197E+00	0.26429E+00	0.70812E+00
0.27080E+04	0.57923E+00	0.45196E+00	0.26179E+00	0.70140E+00
0.27082E+04	0.57358E+00	0.45199E+00	0.25925E+00	0.69461E+00
0.27084E+04	0.56784E+00	0.45202E+00	0.25668E+00	0.68771E+00
0.27086E+04	0.56201E+00	0.45205E+00	0.25406E+00	0.68070E+00
0.27088E+04	0.55612E+00	0.45208E+00	0.25142E+00	0.67361E+00
0.27090E+04	0.55018E+00	0.45211E+00	0.24874E+00	0.66645E+00
0.27092E+04	0.54419E+00	0.45215E+00	0.24605E+00	0.65925E+00
0.27094E+04	0.53818E+00	0.45218E+00	0.24335E+00	0.65202E+00
0.27096E+04	0.53209E+00	0.45222E+00	0.24062E+00	0.64469E+00
0.27098E+04	0.52588E+00	0.45226E+00	0.23784E+00	0.63723E+00
0.27100E+04	0.51961E+00	0.45230E+00	0.23502E+00	0.62969E+00
0.27102E+04	0.51333E+00	0.45233E+00	0.23219E+00	0.62211E+00
0.27104E+04	0.50703E+00	0.45235E+00	0.22935E+00	0.61450E+00
0.27106E+04	0.50069E+00	0.45237E+00	0.22650E+00	0.60685E+00
0.27108E+04	0.49435E+00	0.45240E+00	0.22364E+00	0.59921E+00

0.27110E+04	0.48801E+00	0.45242E+00	0.22079E+00	0.59155E+00
0.27112E+04	0.48158E+00	0.45245E+00	0.21789E+00	0.58379E+00
0.27114E+04	0.47505E+00	0.45248E+00	0.21495E+00	0.57592E+00
0.27116E+04	0.46846E+00	0.45251E+00	0.21198E+00	0.56796E+00
0.27118E+04	0.46187E+00	0.45253E+00	0.20901E+00	0.56000E+00
0.27120E+04	0.45531E+00	0.45256E+00	0.20605E+00	0.55207E+00
0.27122E+04	0.44873E+00	0.45256E+00	0.20308E+00	0.54410E+00
0.27124E+04	0.44213E+00	0.45256E+00	0.20009E+00	0.53610E+00
0.27126E+04	0.43557E+00	0.45256E+00	0.19712E+00	0.52815E+00
0.27128E+04	0.42904E+00	0.45255E+00	0.19416E+00	0.52022E+00
0.27130E+04	0.42244E+00	0.45255E+00	0.19117E+00	0.51221E+00
0.27132E+04	0.41581E+00	0.45252E+00	0.18816E+00	0.50414E+00
0.27134E+04	0.40923E+00	0.45250E+00	0.18518E+00	0.49614E+00
0.27136E+04	0.40272E+00	0.45247E+00	0.18222E+00	0.48822E+00
0.27138E+04	0.39624E+00	0.45244E+00	0.17927E+00	0.48033E+00
0.27140E+04	0.38971E+00	0.45240E+00	0.17631E+00	0.47237E+00
0.27142E+04	0.38316E+00	0.45233E+00	0.17332E+00	0.46437E+00
0.27144E+04	0.37667E+00	0.45226E+00	0.17035E+00	0.45642E+00
0.27146E+04	0.37023E+00	0.45219E+00	0.16741E+00	0.44855E+00
0.27148E+04	0.36384E+00	0.45212E+00	0.16450E+00	0.44074E+00
0.27150E+04	0.35750E+00	0.45205E+00	0.16161E+00	0.43300E+00
0.27152E+04	0.35125E+00	0.45199E+00	0.15876E+00	0.42537E+00
0.27154E+04	0.34509E+00	0.45193E+00	0.15595E+00	0.41785E+00
0.27156E+04	0.33897E+00	0.45187E+00	0.15317E+00	0.41039E+00
0.27158E+04	0.33291E+00	0.45182E+00	0.15041E+00	0.40300E+00
0.27160E+04	0.32689E+00	0.45177E+00	0.14768E+00	0.39567E+00
0.27162E+04	0.32088E+00	0.45172E+00	0.14494E+00	0.38835E+00
0.27164E+04	0.31485E+00	0.45166E+00	0.14221E+00	0.38101E+00
0.27166E+04	0.30892E+00	0.45162E+00	0.13951E+00	0.37379E+00
0.27168E+04	0.30311E+00	0.45157E+00	0.13688E+00	0.36674E+00
0.27170E+04	0.29740E+00	0.45153E+00	0.13428E+00	0.35978E+00
0.27172E+04	0.29173E+00	0.45149E+00	0.13171E+00	0.35290E+00
0.27174E+04	0.28609E+00	0.45146E+00	0.12916E+00	0.34605E+00
0.27176E+04	0.28049E+00	0.45142E+00	0.12662E+00	0.33926E+00
0.27178E+04	0.27494E+00	0.45139E+00	0.12411E+00	0.33251E+00
0.27180E+04	0.26945E+00	0.45136E+00	0.12162E+00	0.32585E+00
0.27182E+04	0.26404E+00	0.45134E+00	0.11917E+00	0.31930E+00
0.27184E+04	0.25871E+00	0.45133E+00	0.11676E+00	0.31284E+00
0.27186E+04	0.25341E+00	0.45131E+00	0.11437E+00	0.30642E+00
0.27188E+04	0.24818E+00	0.45130E+00	0.11200E+00	0.30009E+00
0.27190E+04	0.24307E+00	0.45128E+00	0.10969E+00	0.29390E+00
0.27192E+04	0.23802E+00	0.45127E+00	0.10741E+00	0.28778E+00
0.27194E+04	0.23302E+00	0.45126E+00	0.10515E+00	0.28173E+00

0.27196E+04	0.22813E+00	0.45124E+00	0.10294E+00	0.27581E+00
0.27198E+04	0.22333E+00	0.45123E+00	0.10078E+00	0.27001E+00
0.27200E+04	0.21861E+00	0.45121E+00	0.98640E-01	0.26429E+00
0.27202E+04	0.21396E+00	0.45117E+00	0.96533E-01	0.25864E+00
0.27204E+04	0.20939E+00	0.45114E+00	0.94465E-01	0.25310E+00
0.27206E+04	0.20496E+00	0.45111E+00	0.92459E-01	0.24772E+00
0.27208E+04	0.20061E+00	0.45107E+00	0.90491E-01	0.24245E+00
0.27210E+04	0.19627E+00	0.45104E+00	0.88528E-01	0.23719E+00
0.27212E+04	0.19199E+00	0.45101E+00	0.86590E-01	0.23200E+00
0.27214E+04	0.18781E+00	0.45098E+00	0.84700E-01	0.22694E+00
0.27216E+04	0.18374E+00	0.45095E+00	0.82860E-01	0.22201E+00
0.27218E+04	0.17980E+00	0.45092E+00	0.81074E-01	0.21722E+00
0.27220E+04	0.17595E+00	0.45089E+00	0.79332E-01	0.21255E+00
0.27222E+04	0.17213E+00	0.45082E+00	0.77599E-01	0.20791E+00
0.27224E+04	0.16836E+00	0.45076E+00	0.75887E-01	0.20332E+00
0.27226E+04	0.16465E+00	0.45068E+00	0.74206E-01	0.19882E+00
0.27228E+04	0.16102E+00	0.45061E+00	0.72558E-01	0.19440E+00
0.27230E+04	0.15743E+00	0.45053E+00	0.70929E-01	0.19004E+00
0.27232E+04	0.15390E+00	0.45045E+00	0.69324E-01	0.18574E+00
0.27234E+04	0.15048E+00	0.45037E+00	0.67771E-01	0.18158E+00
0.27236E+04	0.14718E+00	0.45028E+00	0.66271E-01	0.17756E+00
0.27238E+04	0.14395E+00	0.45019E+00	0.64804E-01	0.17363E+00
0.27240E+04	0.14078E+00	0.45011E+00	0.63367E-01	0.16978E+00
0.27242E+04	0.13767E+00	0.45013E+00	0.61967E-01	0.16603E+00
0.27244E+04	0.13461E+00	0.45014E+00	0.60596E-01	0.16235E+00
0.27246E+04	0.13167E+00	0.45016E+00	0.59274E-01	0.15881E+00
0.27248E+04	0.12881E+00	0.45018E+00	0.57986E-01	0.15536E+00
0.27250E+04	0.12597E+00	0.45020E+00	0.56712E-01	0.15195E+00
0.27252E+04	0.12320E+00	0.45022E+00	0.55466E-01	0.14861E+00
0.27254E+04	0.12049E+00	0.45025E+00	0.54249E-01	0.14535E+00
0.27256E+04	0.11786E+00	0.45028E+00	0.53071E-01	0.14219E+00
0.27258E+04	0.11533E+00	0.45031E+00	0.51933E-01	0.13914E+00
0.27260E+04	0.11283E+00	0.45035E+00	0.50813E-01	0.13614E+00
0.27262E+04	0.11034E+00	0.45042E+00	0.49698E-01	0.13315E+00
0.27264E+04	0.10787E+00	0.45049E+00	0.48593E-01	0.13020E+00
0.27266E+04	0.10543E+00	0.45056E+00	0.47501E-01	0.12727E+00
0.27268E+04	0.10306E+00	0.45063E+00	0.46440E-01	0.12443E+00
0.27270E+04	0.10079E+00	0.45070E+00	0.45425E-01	0.12171E+00
0.27272E+04	0.98588E-01	0.45076E+00	0.44440E-01	0.11907E+00
0.27274E+04	0.96472E-01	0.45082E+00	0.43491E-01	0.11652E+00
0.27276E+04	0.94434E-01	0.45087E+00	0.42577E-01	0.11408E+00
0.27278E+04	0.92451E-01	0.45091E+00	0.41687E-01	0.11169E+00
0.27280E+04	0.90523E-01	0.45095E+00	0.40822E-01	0.10937E+00

0.27282E+04	0.88617E-01	0.45094E+00	0.39961E-01	0.10707E+00
0.27284E+04	0.86715E-01	0.45093E+00	0.39103E-01	0.10477E+00
0.27286E+04	0.84875E-01	0.45092E+00	0.38272E-01	0.10254E+00
0.27288E+04	0.83110E-01	0.45090E+00	0.37474E-01	0.10040E+00
0.27290E+04	0.81379E-01	0.45088E+00	0.36692E-01	0.98309E-01
0.27292E+04	0.79679E-01	0.45086E+00	0.35924E-01	0.96251E-01
0.27294E+04	0.78016E-01	0.45084E+00	0.35173E-01	0.94237E-01
0.27296E+04	0.76404E-01	0.45082E+00	0.34445E-01	0.92287E-01
0.27298E+04	0.74844E-01	0.45081E+00	0.33740E-01	0.90400E-01
0.27300E+04	0.73315E-01	0.45080E+00	0.33050E-01	0.88551E-01
0.27302E+04	0.71818E-01	0.45063E+00	0.32363E-01	0.86710E-01
0.27304E+04	0.70346E-01	0.45046E+00	0.31688E-01	0.84902E-01
0.27306E+04	0.68909E-01	0.45031E+00	0.31030E-01	0.83139E-01
0.27308E+04	0.67526E-01	0.45016E+00	0.30397E-01	0.81443E-01
0.27310E+04	0.66142E-01	0.45001E+00	0.29765E-01	0.79749E-01
0.27312E+04	0.64740E-01	0.44989E+00	0.29126E-01	0.78037E-01
0.27314E+04	0.63381E-01	0.44977E+00	0.28507E-01	0.76378E-01
0.27316E+04	0.62048E-01	0.44966E+00	0.27900E-01	0.74753E-01
0.27318E+04	0.60722E-01	0.44955E+00	0.27298E-01	0.73138E-01
0.27320E+04	0.59421E-01	0.44944E+00	0.26706E-01	0.71554E-01
0.27322E+04	0.58141E-01	0.44945E+00	0.26132E-01	0.70014E-01
0.27324E+04	0.56915E-01	0.44947E+00	0.25582E-01	0.68541E-01
0.27326E+04	0.55761E-01	0.44949E+00	0.25064E-01	0.67153E-01
0.27328E+04	0.54613E-01	0.44950E+00	0.24549E-01	0.65773E-01
0.27330E+04	0.53438E-01	0.44952E+00	0.24021E-01	0.64360E-01
0.27332E+04	0.52273E-01	0.44951E+00	0.23497E-01	0.62956E-01
0.27334E+04	0.51127E-01	0.44951E+00	0.22982E-01	0.61575E-01
0.27336E+04	0.49996E-01	0.44949E+00	0.22473E-01	0.60211E-01
0.27338E+04	0.48871E-01	0.44946E+00	0.21966E-01	0.58853E-01
0.27340E+04	0.47720E-01	0.44943E+00	0.21447E-01	0.57463E-01
0.27342E+04	0.46607E-01	0.44938E+00	0.20944E-01	0.56115E-01
0.27344E+04	0.45578E-01	0.44932E+00	0.20479E-01	0.54869E-01
0.27346E+04	0.44570E-01	0.44925E+00	0.20023E-01	0.53647E-01
0.27348E+04	0.43555E-01	0.44917E+00	0.19563E-01	0.52416E-01
0.27350E+04	0.42574E-01	0.44908E+00	0.19119E-01	0.51226E-01
0.27352E+04	0.41668E-01	0.44900E+00	0.18709E-01	0.50127E-01
0.27354E+04	0.40804E-01	0.44892E+00	0.18318E-01	0.49078E-01
0.27356E+04	0.39940E-01	0.44883E+00	0.17926E-01	0.48029E-01
0.27358E+04	0.39075E-01	0.44875E+00	0.17535E-01	0.46980E-01
0.27360E+04	0.38198E-01	0.44865E+00	0.17138E-01	0.45917E-01
0.27362E+04	0.37312E-01	0.44852E+00	0.16735E-01	0.44838E-01
0.27364E+04	0.36471E-01	0.44838E+00	0.16353E-01	0.43815E-01
0.27366E+04	0.35693E-01	0.44826E+00	0.15999E-01	0.42867E-01

0.27368E+04	0.34924E-01	0.44813E+00	0.15650E-01	0.41932E-01
0.27370E+04	0.34152E-01	0.44801E+00	0.15301E-01	0.40995E-01
0.27372E+04	0.33409E-01	0.44791E+00	0.14964E-01	0.40093E-01
0.27374E+04	0.32704E-01	0.44780E+00	0.14645E-01	0.39238E-01
0.27376E+04	0.32016E-01	0.44770E+00	0.14334E-01	0.38404E-01
0.27378E+04	0.31318E-01	0.44762E+00	0.14018E-01	0.37559E-01
0.27380E+04	0.30637E-01	0.44753E+00	0.13711E-01	0.36735E-01
0.27382E+04	0.29982E-01	0.44744E+00	0.13415E-01	0.35943E-01
0.27384E+04	0.29313E-01	0.44736E+00	0.13114E-01	0.35135E-01
0.27386E+04	0.28689E-01	0.44728E+00	0.12832E-01	0.34381E-01
0.27388E+04	0.28149E-01	0.44721E+00	0.12589E-01	0.33729E-01
0.27390E+04	0.27624E-01	0.44714E+00	0.12352E-01	0.33094E-01
0.27392E+04	0.27084E-01	0.44708E+00	0.12109E-01	0.32443E-01
0.27394E+04	0.26577E-01	0.44701E+00	0.11880E-01	0.31831E-01
0.27396E+04	0.26084E-01	0.44695E+00	0.11658E-01	0.31236E-01
0.27398E+04	0.25598E-01	0.44688E+00	0.11439E-01	0.30650E-01
0.27400E+04	0.25129E-01	0.44682E+00	0.11228E-01	0.30084E-01
0.27402E+04	0.24650E-01	0.44665E+00	0.11010E-01	0.29498E-01
0.27404E+04	0.24193E-01	0.44646E+00	0.10801E-01	0.28940E-01
0.27406E+04	0.23759E-01	0.44627E+00	0.10603E-01	0.28408E-01
0.27408E+04	0.23327E-01	0.44608E+00	0.10406E-01	0.27879E-01
0.27410E+04	0.22896E-01	0.44589E+00	0.10209E-01	0.27353E-01
0.27412E+04	0.22467E-01	0.44569E+00	0.10013E-01	0.26829E-01
0.27414E+04	0.22043E-01	0.44549E+00	0.98197E-02	0.26310E-01
0.27416E+04	0.21628E-01	0.44528E+00	0.96306E-02	0.25803E-01
0.27418E+04	0.21223E-01	0.44508E+00	0.94459E-02	0.25308E-01
0.27420E+04	0.20828E-01	0.44487E+00	0.92657E-02	0.24826E-01
0.27422E+04	0.20436E-01	0.44469E+00	0.90878E-02	0.24349E-01
0.27424E+04	0.20046E-01	0.44450E+00	0.89106E-02	0.23874E-01
0.27426E+04	0.19659E-01	0.44431E+00	0.87345E-02	0.23402E-01
0.27428E+04	0.19285E-01	0.44412E+00	0.85649E-02	0.22948E-01
0.27430E+04	0.18934E-01	0.44392E+00	0.84053E-02	0.22520E-01
0.27432E+04	0.18585E-01	0.44372E+00	0.82465E-02	0.22095E-01
0.27434E+04	0.18244E-01	0.44352E+00	0.80917E-02	0.21680E-01
0.27436E+04	0.17912E-01	0.44332E+00	0.79409E-02	0.21276E-01
0.27438E+04	0.17584E-01	0.44311E+00	0.77915E-02	0.20876E-01
0.27440E+04	0.17259E-01	0.44290E+00	0.76440E-02	0.20481E-01
0.27442E+04	0.16935E-01	0.44262E+00	0.74958E-02	0.20083E-01
0.27444E+04	0.16613E-01	0.44234E+00	0.73485E-02	0.19689E-01
0.27446E+04	0.16294E-01	0.44206E+00	0.72029E-02	0.19299E-01
0.27448E+04	0.15979E-01	0.44178E+00	0.70593E-02	0.18914E-01
0.27450E+04	0.15667E-01	0.44150E+00	0.69169E-02	0.18532E-01
0.27452E+04	0.15359E-01	0.44119E+00	0.67762E-02	0.18155E-01

0.27454E+04	0.15055E-01	0.44088E+00	0.66372E-02	0.17783E-01
0.27456E+04	0.14752E-01	0.44056E+00	0.64990E-02	0.17413E-01
0.27458E+04	0.14449E-01	0.44026E+00	0.63615E-02	0.17044E-01
0.27460E+04	0.14148E-01	0.43994E+00	0.62245E-02	0.16677E-01
0.27462E+04	0.13852E-01	0.43957E+00	0.60889E-02	0.16314E-01
0.27464E+04	0.13557E-01	0.43921E+00	0.59543E-02	0.15953E-01
0.27466E+04	0.13269E-01	0.43884E+00	0.58229E-02	0.15601E-01
0.27468E+04	0.12993E-01	0.43848E+00	0.56973E-02	0.15265E-01
0.27470E+04	0.12723E-01	0.43812E+00	0.55741E-02	0.14935E-01
0.27472E+04	0.12453E-01	0.43776E+00	0.54513E-02	0.14606E-01
0.27474E+04	0.12193E-01	0.43739E+00	0.53330E-02	0.14288E-01
0.27476E+04	0.11934E-01	0.43703E+00	0.52153E-02	0.13973E-01
0.27478E+04	0.11679E-01	0.43667E+00	0.50998E-02	0.13664E-01
0.27480E+04	0.11429E-01	0.43630E+00	0.49867E-02	0.13361E-01
0.27482E+04	0.11182E-01	0.43599E+00	0.48752E-02	0.13062E-01
0.27484E+04	0.10936E-01	0.43569E+00	0.47646E-02	0.12766E-01
0.27486E+04	0.10690E-01	0.43538E+00	0.46542E-02	0.12470E-01
0.27488E+04	0.10445E-01	0.43507E+00	0.45445E-02	0.12176E-01
0.27490E+04	0.10205E-01	0.43477E+00	0.44369E-02	0.11888E-01
0.27492E+04	0.99665E-02	0.43446E+00	0.43301E-02	0.11601E-01
0.27494E+04	0.97292E-02	0.43415E+00	0.42240E-02	0.11317E-01
0.27496E+04	0.94935E-02	0.43385E+00	0.41188E-02	0.11035E-01
0.27498E+04	0.92580E-02	0.43355E+00	0.40138E-02	0.10754E-01
0.27500E+04	0.90256E-02	0.43325E+00	0.39104E-02	0.10477E-01
0.27502E+04	0.87973E-02	0.43297E+00	0.38090E-02	0.10205E-01
0.27504E+04	0.85692E-02	0.43270E+00	0.37079E-02	0.99344E-02
0.27506E+04	0.83419E-02	0.43243E+00	0.36073E-02	0.96649E-02
0.27508E+04	0.81160E-02	0.43216E+00	0.35074E-02	0.93974E-02
0.27510E+04	0.78923E-02	0.43190E+00	0.34087E-02	0.91329E-02
0.27512E+04	0.76688E-02	0.43165E+00	0.33103E-02	0.88691E-02
0.27514E+04	0.74458E-02	0.43140E+00	0.32121E-02	0.86062E-02
0.27516E+04	0.72229E-02	0.43116E+00	0.31143E-02	0.83440E-02
0.27518E+04	0.70047E-02	0.43093E+00	0.30185E-02	0.80875E-02
0.27520E+04	0.67885E-02	0.43069E+00	0.29237E-02	0.78335E-02
0.27522E+04	0.65739E-02	0.43044E+00	0.28297E-02	0.75815E-02
0.27524E+04	0.63621E-02	0.43018E+00	0.27369E-02	0.73328E-02
0.27526E+04	0.61554E-02	0.42993E+00	0.26464E-02	0.70905E-02
0.27528E+04	0.59519E-02	0.42967E+00	0.25574E-02	0.68520E-02
0.27530E+04	0.57496E-02	0.42942E+00	0.24690E-02	0.66151E-02
0.27532E+04	0.55547E-02	0.42916E+00	0.23839E-02	0.63870E-02
0.27534E+04	0.53602E-02	0.42890E+00	0.22990E-02	0.61596E-02
0.27536E+04	0.51685E-02	0.42863E+00	0.22154E-02	0.59356E-02
0.27538E+04	0.49792E-02	0.42836E+00	0.21329E-02	0.57147E-02

0.27540E+04	0.47913E-02	0.42809E+00	0.20511E-02	0.54955E-02
0.27542E+04	0.46055E-02	0.42780E+00	0.19703E-02	0.52789E-02
0.27544E+04	0.44214E-02	0.42752E+00	0.18902E-02	0.50644E-02
0.27546E+04	0.42400E-02	0.42722E+00	0.18114E-02	0.48533E-02
0.27548E+04	0.40598E-02	0.42692E+00	0.17332E-02	0.46438E-02
0.27550E+04	0.38808E-02	0.42661E+00	0.16556E-02	0.44359E-02
0.27552E+04	0.37085E-02	0.42627E+00	0.15808E-02	0.42355E-02
0.27554E+04	0.35458E-02	0.42593E+00	0.15103E-02	0.40464E-02
0.27556E+04	0.33844E-02	0.42559E+00	0.14404E-02	0.38592E-02
0.27558E+04	0.32236E-02	0.42524E+00	0.13708E-02	0.36728E-02
0.27560E+04	0.30643E-02	0.42489E+00	0.13020E-02	0.34884E-02
0.27562E+04	0.29105E-02	0.42462E+00	0.12359E-02	0.33112E-02
0.27564E+04	0.27572E-02	0.42436E+00	0.11701E-02	0.31349E-02
0.27566E+04	0.26057E-02	0.42410E+00	0.11051E-02	0.29608E-02
0.27568E+04	0.24562E-02	0.42385E+00	0.10411E-02	0.27894E-02
0.27570E+04	0.23099E-02	0.42360E+00	0.97848E-03	0.26216E-02
0.27572E+04	0.21658E-02	0.42335E+00	0.91689E-03	0.24566E-02
0.27574E+04	0.20262E-02	0.42311E+00	0.85730E-03	0.22969E-02
0.27576E+04	0.18881E-02	0.42286E+00	0.79841E-03	0.21392E-02
0.27578E+04	0.17557E-02	0.42263E+00	0.74201E-03	0.19881E-02
0.27580E+04	0.16241E-02	0.42240E+00	0.68603E-03	0.18381E-02
0.27582E+04	0.14940E-02	0.42191E+00	0.63031E-03	0.16888E-02
0.27584E+04	0.13647E-02	0.42141E+00	0.57509E-03	0.15408E-02
0.27586E+04	0.12391E-02	0.42092E+00	0.52158E-03	0.13975E-02
0.27588E+04	0.11139E-02	0.42044E+00	0.46834E-03	0.12548E-02
0.27590E+04	0.99110E-03	0.41995E+00	0.41621E-03	0.11151E-02
0.27592E+04	0.87275E-03	0.41946E+00	0.36609E-03	0.98085E-03
0.27594E+04	0.75531E-03	0.41897E+00	0.31645E-03	0.84787E-03
0.27596E+04	0.63805E-03	0.41848E+00	0.26701E-03	0.71541E-03
0.27598E+04	0.52826E-03	0.41799E+00	0.22081E-03	0.59160E-03
0.27600E+04	0.42075E-03	0.41750E+00	0.17566E-03	0.47065E-03
0.27602E+04	0.31435E-03	0.41708E+00	0.13111E-03	0.35127E-03
0.27604E+04	0.22414E-03	0.41665E+00	0.93388E-04	0.25021E-03
0.27606E+04	0.14164E-03	0.41622E+00	0.58954E-04	0.15795E-03
0.27608E+04	0.70722E-04	0.41579E+00	0.29405E-04	0.78785E-04
0.27610E+04	0.00000E+00	0.41535E+00	0.00000E+00	0.00000E+00

Table D.6-14. NOAA-19 HIRS/308 Channel 20 Slope and Intercept (Albedo %).		
Source	Slope	Intercept
Pre-launch calibration	0.021740	68.49
Post-launch calibration	TBD	TBD

AMSU:

Table D.6-15. NOAA-19 AMSU-A1 (S/N 107, ID=25) PRT Temperature Conversion Coefficients.

	PRT #	f_{k0} (K)	f_{k1} (K/count)	f_{k2} (K/count2)	f_{k3} (K/count3)
Scan Motor A1-1	1	263.1118	1.742062E-03	3.497049E-09	1.447318E-14
Scan Motor A1-2	2	263.7931	1.733920E-03	3.858388E-09	4.108136E-15
Feedhorn A1-1	3	264.0873	1.772267E-03	1.969058E-09	3.782504E-14
Feedhorn A1-2	4	263.7359	1.746087E-03	3.388829E-09	1.539593E-14
RF Mux A1-1	5	263.4033	1.731448E-03	4.052407E-09	6.281552E-15
RF Mux A1-2	6	263.6212	1.736000E-03	3.594951E-09	1.264543E-14
L.O. CH 3	7	262.6824	1.728847E-03	4.019764E-09	5.986536E-15
L.O. CH 4	8	263.4037	1.735807E-03	3.885898E-09	8.667607E-15
L.O. CH 5	9	262.7392	1.731672E-03	3.496970E-09	1.431707E-14
L.O. CH 6	10	263.3888	1.740029E-03	3.520360E-09	1.251986E-14
L.O. CH 7	11	263.6862	1.735802E-03	3.586685E-09	1.647744E-14
L.O. CH 8	12	263.6868	1.744705E-03	3.305509E-09	1.818267E-14
L.O. CH 15	13	263.6375	1.732038E-03	3.697993E-09	1.205412E-14
PLLO #2 CH9-14	14	263.9067	1.734456E-03	3.429725E-09	1.544829E-14
PLLO #1 CH9-14	15	263.3486	1.753624E-03	3.516755E-09	3.333381E-15
Not Used	16	0.00000E+00	0.00000E+00	0.00000E+00	0.000000E+00
Mixer/IF CH 3	17	263.2393	1.744402E-03	3.362316E-09	1.334880E-14
Mixer/IF CH 4	18	263.6364	1.771411E-03	3.576661E-09	8.852903E-15
Mixer/IF CH 5	19	263.8027	1.735185E-03	3.816865E-09	4.611234E-15
Mixer/IF CH 6	20	263.9944	1.732857E-03	3.865460E-03	1.188194E-14
Mixer/IF CH 7	21	263.5726	1.734105E-03	4.104094E-09	4.784842E-15
Mixer/IF CH 8	22	263.1446	1.735692E-03	3.487495E-09	1.448047E-14
Mixer/IF CH9 -14	23	263.3230	1.736698E-03	3.506417E-09	1.381465E-14
Mixer/IF CH 15	24	263.8131	1.733783E-03	3.705516E-09	1.114634E-14
IF Amp.CH11 - 14	25	263.5378	1.746153E-03	3.526695E-09	1.533726E-14
IF Amp. CH. 9	26	263.5392	1.735697E-03	3.888978E-09	1.279559E-14
IF Amp. Ch.10	27	263.1599	1.731394E-03	3.924602E-09	7.025278E-15
IF Amp. Ch.11	28	263.2114	1.735249E-03	3.437025E-09	1.482940E-14
DC/DC Converter	29	263.5982	1.739884E-03	3.453134E-09	1.511657E-14
IF Amp. Ch.13	30	263.6745	1.740961E-03	3.504604E-09	1.020772E-14
IF Amp. Ch.14	31	263.5161	1.740639E-03	3.555526E-09	1.322503E-14
IF Amp. Ch.12	32	263.0495	1.754169E-03	3.485714E-09	9.320949E-15
RF Shelf A1-1	33	263.7456	1.728914E-03	3.995046E-09	6.167204E-15
RF Shelf A1-2	34	264.5497	1.742660E-03	3.626275E-09	1.254250E-14
Detector/PreAmp	35	263.4284	1.726987E-03	3.945960E-09	7.127579E-15
A1-1WarmLoad#1	36	254.8741	1.637893E-03	5.902597E-09	2.947544E-14
A1-1WarmLoad#2	37	254.4845	1.634828E-03	5.860831E-09	2.909161E-14
A1-1WarmLoad#3	38	254.5352	1.627381E-03	5.878626E-09	3.107089E-14

A1-1WarmLoad#4	39	254.1389	1.638958E-03	5.777645E-09	2.745335E-14
A1-1WmLdCenter	40	254.6330	1.636434E-03	5.860082E-09	2.914760E-14
A1-2WarmLoad#1	41	254.6251	1.637361E-03	5.846084E-09	3.029967E-14
A1-2WarmLoad#2	42	254.6393	1.637848E-03	5.829585E-09	2.888881E-14
A1-2WarmLoad#3	43	254.1602	1.630533E-03	5.839149E-09	3.010925E-14
A1-2WarmLoad#4	44	255.0383	1.634408E-03	5.912973E-09	2.908720E-14
A1-2WmLdCenter	45	254.3306	1.632722E-03	5.889366E-09	2.895453E-14

Table D.6-16. NOAA-19 AMSU-A2 (S/N 109, ID=34) PRT Temperature Conversion Coefficients.

	PRT #	f _{k0} (K)	f _{k1} (K/count)	f _{k2} (K/count2)	f _{k3} (K/count3)
Scan Motor	1	263.3287	1.742668E-03	4.311887E-09	2.025034E-16
Feedhorn	2	263.3765	1.752967E-03	3.748854E-09	1.258927E-14
RF Diplexer	3	263.5512	1.739217E-03	3.818752E-09	1.353860E-14
Mixer/IF Ch 1	4	263.6189	1.749884E-03	3.816858E-09	1.067548E-14
Mixer/IF Ch 2	5	263.9912	1.751035E-03	3.631815E-09	1.485421E-14
Ch1 DRO	6	263.7419	1.753762E-03	3.693388E-09	1.127053E-14
Ch2 DRO	7	263.4610	1.747977E-03	4.016104E-09	7.197988E-15
Compensator Motor	8	263.4379	1.763693E-03	3.358171E-09	1.355759E-14
Sub Reflector	9	263.9190	1.751008E-03	4.282710E-09	2.331043E-15
DC/DC Converter	10	262.9899	1.747058E-03	3.705516E-09	1.233494E-14
RF Shelf	11	263.5386	1.745205E-03	4.009926E-09	9.340984E-15
Detector Pre-Amp	12	263.2827	1.749743E-03	4.089112E-09	6.352310E-15
Warm Load Ctr	13	254.4454	1.646443E-03	5.907230E-09	3.0598570E-14
Warm Load #1	14	254.3621	1.658168E-03	5.933477E-09	2.513103E-14
Warm Load #2	15	254.8100	1.652669E-03	5.849476E-09	3.025275E-14
Warm Load #3	16	254.1330	1.648472E-03	5.857347E-09	3.302980E-14
Warm Load #4	17	254.9246	1.648978E-03	5.884300E-09	3.126444E-14
Warm Load #5	18	254.7082	1.641230E-03	5.955578E-09	3.155298E-14
Warm Load #6	19	254.6145	1.648466E-03	5.895623E-09	3.138678E-14

Table D.6-17 contains the measured channel characteristics for NOAA-19 AMSU-A (channels 1-15). The central frequencies are interpolated from the temperature dependent data to 15 C. The f1, f2, f3, and f4 for channels 11-14 are computed from tabulated values. All values are for 15 C. Detailed information on the terminology used in this table can be found in Section 3.3.2.1.

Table D.6-17. NOAA-19 AMSU-A Measured Channel Characteristics.

Ch #	Instrument /Serial #	Central Frequency (GHz)	Central Wavenumber (cm ⁻¹)	I/F Frequencies (GHz)			
				Sideband 1		Sideband 2	
				Begin	End	Begin	End

				(f ₁)	(f ₂)	(f ₃)	(f ₄)
1*	A2/108	23.79974	.7938560	0.00861	0.13415	N/A	N/A
2*	A2/108	31.40210	1.047380	0.00875	0.08915	N/A	N/A
3*	A1-2/106	50.30027	1.677800	0.00884	0.08896	N/A	N/A
4*	A1-2/106	52.80066	1.761245	0.00904	0.19924	N/A	N/A
5	A1-2/106	53.59613	1.787790	0.03140	0.19926	N/A	N/A
6*	A1-1/106	54.40013	1.814596	0.00914	0.19911	N/A	N/A
7*	A1-1/106	54.93949	1.832595	0.00913	0.19928	N/A	N/A
8*	A1-2/106	55.49868	1.851254	0.00919	0.16425	N/A	N/A
9*	A1-1/106	57.29033	1.911000	0.00916	0.16422	N/A	N/A
10	A1-1/106	57.29033	1.911000	0.17934	0.25532	N/A	N/A
11	A1-1/106	57.29033	1.911000	0.25694	0.29183	0.35259	0.38788
12	A1-1/106	57.29033	1.911000	0.29255	0.30799	0.33624	0.35176
13	A1-1/106	57.29033	1.911000	0.30825	0.31607	0.32823	0.33689
14	A1-1/106	57.29033	1.911000	0.31627	0.31922	0.32526	0.32821
15*	A1-1/106	89.01000	2.969723	0.49157	1.48733	N/A	N/A

* The lower frequency cutoff in these single passband channels is due to the stop band.

MHS:

Table D.6-18. NOAA-19 MHS Coefficients for Converting PRT Resistance (Ohms) to PRT Temperature (K).

PRT #	f _{k0}	f _{k1}	f _{k2}	f _{k3}	PIE-A/B
A1	26.47922	2.381473	7.897082E-04	6.277443E-07	PIE-A
A2	25.72883	2.401215	6.160758E-04	1.1141268E-06	
A3	26.75906	2.375112	8.306877E-04	5.707352E-07	
A4	25.80272	2.401580	5.882624E-04	1.307091E-06	
A5	26.78935	2.370714	9.064551E-04	2.251251E-05	
B1	29.61185	2.288703	1.697296E-03	-2.305717E-05	PIE-B
B2	27.10648	2.361667	9.940398E-04	-6.092637E-07	
B3	26.16069	2.389169	7.264472E-04	8.079902E-07	
B4	26.36162	2.385427	7.459118E-04	7.869268E-07	
B5	25.97523	2.396943	6.291877E-03	1.187232E-06	

Table D.6-19. NOAA-19 MHS Resistances (Ohms) for Three PRT Calibration Channels.

Rcal_1	Rcal_2	Rcal_3	PIE-A or -B
117.988	95.289	80.602	PIE-A
118.006	95.293	80.601	PIE-B

Table D.6-20. NOAA-19 MHS Coefficients for Converting Counts into Temperatures(K).

g ₀	g ₁	g ₂	g ₃	g ₄
355.9982	-0.239278	-4.85712E-03	3.59838E-05	-8.02652E-08

Note:

1. One set of coefficients applies to 24 housekeeping thermistors.

Table D.6-21 NOAA-19 MHS Coefficients for Converting Counts into Current (amps) for Current Monitors .

Name	Intercept	Slope
RDM Motor	0.0	1.33700E-02
FDM Motor	0.0	1.33700E-02
EE+SM+5V	0.0	1.68100E-02
Receiver+8V	-0.1371000	2.22400E-02
Receiver+15V	-0.1012200	8.05400E-03
Receiver-15V	-0.9060000	1.89300E-03

Table D.6-22. NOAA-19 MHS Coefficients for Converting Volts into Temperatures (K).

h_0	h_1	h_2	h_3	h_4	h_5
363.4522	-108.10	64.212	-22.8659	4.110	-0.295

Table D.6-23. NOAA-19 MHS Values of the Nonlinearity Parameters μ (m^2 -sr-cm⁻¹)/mW.

Instrument Temp. (See Note 1)	Ch 16	Ch 17	Ch. 18	Ch. 19	Ch. 20	LO(C)
275.28	1.709693 E-02	5.452098 E-02	3.468686 E-02	2.263756 E-02	7.784018 E-03	LO-A
288.00	1.068579 E-01	8.246891 E-02	5.056471 E-02	2.977869 E-02	2.917676 E-02	LO-A
299.45	1.914666 E-01	1.071100 E-01	4.829732 E-02	4.355207 E-02	3.218666 E-02	LO-A
275.05	2.494872 E-02	6.442000 E-02	3.170855 E-02	2.66325 E-02	2.431330 E-02	LO-B
287.67	1.373525 E-01	6.58128 E-02	5.975961 E-02	4.189441 E-02	3.033467 E-02	LO-B
299.16	1.903727 E-01	9.679756 E-02	6.289427 E-02	5.412508 E-02	3.707770 E-02	LO-B

Note:

1. QBS5 temperature.

Table D.6-24. NOAA-19 MHS Wavenumbers and Band-Correction Factors.

Channel Number	Wavenumber (cm-1)	Band-correction factors: $T_w = b + c * T_w$	
		b	c
16	2.968720	0.0	1.0
17	5.236956	0.0	1.0
18	6.114597	0.0	1.0
19	6.114597	-0.0031	1.00027
20	6.348092	0.0	1.0

Channel	Frequency (GHz)		Wavenumber (cm-1)	Lower IF - 3Db Frequencies (GHz)	Upper IF - 3DB Frequencies (GHz)	# Sidebands
H1	89	*	2.968720031	0.118	1.217	1
H2	157	*	5.236955561	0.111	1.211	1
H3	183.311		6.114595929	0.745	1.219	2
H4	183.311		6.114595929	2.520	3.367	2
H5	190.311	*	6.348090763	0.112	1.071	1

* The lower frequency cutoff in these single sideband channels is due to the stop band.
Detailed information on the terminology used in this table can be found in Section 3.9.1 for the MHS instrument. Additional information can be found in Section 3.3.2.1

D.7 MetOp-B

Launch date: September 17, 2012

Operational dates: April 24, 2013 to present

Morning orbit: 2130 LST ascending node, 0930 LST descending node

AVHRR instrument: 6 channels (AVHRR/3): FM 307

Spacecraft ID: 12

Abnormalities:

Up to date information regarding abnormalities on the POES spacecraft and instruments can be found at: <http://www.oso.noaa.gov/poesstatus/>. This website allows a user to search and sort on any POES spacecraft, subsystem or instrument status. Once a user narrows down their window of interest, further details can be obtained by going to the NOAA/NESDIS/Office of Satellite Operations' (OSO) archive of weekly status reports at: <http://noaasis.noaa.gov/NOAASIS/ml/podocs.html>

Table D.7-1 contains the PRT weighting factors for MetOp-B and Table D.7-2 contains the radiance of space and the coefficients for nonlinear radiance correction quadratic for MetOp-B.

b_1	b_2	b_3	b_4
0.25	0.25	0.25	0.25

correction quadratic.				
	N_S	b_0	b_1	b_2
Channel 4	-4.75	4.85	-0.0096771	0.00048091
Channel 5	-4.39	4.36	-0.0766350	0.00033524

Table D.5-3 contains MetOp-A coefficients d_0 , d_1 , d_2 , d_3 and d_4 that relate temperature, T_{PRT} (Kelvin) of each PRT to count value, C_{PRT} , by the equation:

$$T_{PRT} = d_0 + d_1 C_{PRT} + d_2 C_{PRT}^2 + d_3 C_{PRT}^3 + d_4 C_{PRT}^4$$

Table D.7-3. MetOp-B AVHRR/3 conversion coefficients.					
PRT	d_0	d_1	d_2	d_3	d_4
1	276.5853	.05093323	1.543330 E-06	0	0
2	276.5335	.05103343	1.497510 E-06	0	0
3	276.5721	.05109724	1.429280 E-06	0	0
4	276.5720	.05102045	1.508410 E-06	0	0

Table D.7-4. MetOp-B AVHRR/3 Pre-launch Calibration Coefficients (Albedo Representation).			
Channel #	Contents	Slope	Intercept
1	Low albedo range (0-25%)	0.05176	-2.039
	High albedo range (26 - 100%)	0.15335	-52.899
2	Low albedo range (0-25%)	0.05678	-2.291
	High albedo range (26 - 100%)	.016727	-57.812
3A	Low albedo range (0-12.5%)	0.02919	-1.224
	High albedo range (12.6 - 100%)	0.2328	-88.417

Note: The albedo ranges given in parentheses are nominal; the points of intersection of the two regression lines are located at 500.54, 500.40 and 500.56 counts for channels 1, 2, and 3A respectively. This information is based on the data in AVHRR S/N A305 Alignment/ Calibration Handbook (Report 8172845, Rev B), January 2002.

Table D.7-5 contains a summary of the spectral response data as a function of wavenumber for all channels of the MetOp-A AVHRR/3.

Table D.7-5. Summary of MetOp-B AVHRR Spectral Response Data (as a Function of Wavenumber) for Each Channel.		
Channel 1		
The peak wavenumber was at 15480.00 and had a value of 1.00.		
File starting point is at wavenumber = 12050.00.		
File ending point is at wavenumber = 23250.00		
Moment Center Wavenumber = 15850.6296		
Percent line at which curve crosses	Wavenumber (cm ⁻¹)	μm

0.10%				
1.00%				
5.00%				
10.00%				
20.00%				
50.00%				
80.00%				
80.00%				
50.00%				
20.00%				
10.00%				
5.00%				
1.00%				
0.10%				
Area Point Limits	Lower (cm⁻¹)	Upper (cm⁻¹)		
99%				
96%				
70%				
50%				
0% (area center)				
Crossing	Lower (cm⁻¹)	Upper (cm⁻¹)	Width (cm⁻¹)	Center (cm⁻¹)
80%	14775.7832	16748.0781	1972.2949	15761.9307
50%	14710.2188	17017.4766	2307.2578	15863.8477
20%	14637.4912	17093.8965	2456.4053	15865.6934
5%	14535.3438	17182.9414	2647.5977	15859.1426

Channel	Equivalent Width w (μm)	Effective Wavelength λ_e (μm)	Extraterrestrial Solar Irradiance in Band F (W/m²)
1	0.086698	0.632815	140.3147
2	0.242643	0.841679	245.0039
3A	0.052664	1.606119	13.08457

Note: These quantities are based on the solar irradiance data of *Neckel and Labs* (1984), which is a widely used source of such data.

Table D.7-7 contains the temperature-to-radiance coefficients for MetOp-B AVHRR/3 Channels 3B, 4 and 5.

	v_C	A	B
Channel 3B	2684.32	1.763611	0.997018

Channel 4	933.63	0.504183	0.998638
Channel 5	839.62	0.381279	0.998610

Tables D.7-8 and D.7-9 contain the corresponding spectral response values for MetOp-AVHRR/3 Channels 1, 2, 3A and Channels 3B, 4 and 5, respectively. Note: Negative response values were caused by system response noise and are to be ignored but are included in the table for completeness.

Channel 1		Channel 2		Channel 3A	
Wavelength (µm)	Relative Response (percent)	Wavelength (µm)	Relative Response (percent)	Wavelength (µm)	Relative Response (percent)
0.4300	0.00170530	0.704000	0.06571600	1.49000	-0.000057095
0.4320	-0.00396940	0.708000	0.11023000	1.49100	-0.000415510
0.4340	-0.00689020	0.712000	0.16602000	1.49200	-0.000084923
0.4360	-0.00069278	0.716000	0.22298000	1.49300	-0.000271530
0.4380	0.00430250	0.720000	0.28474000	1.49400	0.000027630
0.4400	0.00479130	0.724000	0.35646000	1.49500	0.000025548
0.4420	-0.00347860	0.728000	0.46138000	1.49600	0.000070092
0.4440	0.00340570	0.732000	0.66201000	1.49700	-0.000028655
0.4460	0.00596430	0.736000	0.79958000	1.49800	-0.000085175
0.4480	0.00660970	0.740000	0.80953000	1.49900	0.000182220
0.4500	0.00449620	0.744000	0.83627000	1.50000	0.000067423
0.4520	0.00045112	0.748000	0.86800000	1.50100	-0.000153820
0.4540	-0.00499330	0.752000	0.91701000	1.50200	-0.000092297
0.4560	0.00007003	0.756000	0.95817000	1.50300	-0.000020863
0.4580	0.00456950	0.760000	0.97935000	1.50400	-0.000139350
0.4600	-0.01066900	0.764000	0.98524000	1.50500	-0.000201470
0.4620	0.00660340	0.768000	0.98108000	1.50600	-0.000038647
0.4640	0.00097228	0.772000	0.97106000	1.50700	-0.000252630
0.4660	0.00591270	0.776000	0.96624000	1.50800	-0.000102250
0.4680	0.00170350	0.780000	0.97502000	1.50900	0.000172940
0.4700	0.00643620	0.784000	0.98562000	1.51000	0.000117810
0.4720	0.00686720	0.788000	0.99622000	1.51100	0.000060353
0.4740	0.00609960	0.792000	0.99536000	1.51200	0.000034012
0.4760	-0.00128130	0.796000	0.98504000	1.51300	0.000010788
0.4780	0.00368500	0.800000	0.97536000	1.51400	-0.000007724
0.4800	0.00042110	0.804000	0.96838000	1.51500	0.000115800
0.4820	0.00081060	0.808000	0.97249000	1.51600	-0.000068045
0.4840	0.00113240	0.812000	0.97932000	1.51700	-0.000107600
0.4860	-0.00207330	0.816000	0.99262000	1.51800	-0.000180610
0.4880	0.00018531	0.820000	1.00000000	1.51900	0.000117110

0.4900	-0.00168470	0.824000	0.99791000	1.52000	0.000211300
0.4920	0.00045676	0.828000	0.99204000	1.52100	-0.000017930
0.4940	-0.00147990	0.832000	0.98125000	1.52200	-0.000030587
0.4960	0.00005477	0.836000	0.96832000	1.52300	-0.000074051
0.4980	0.00244080	0.840000	0.95512000	1.52400	-0.000015178
0.5000	-0.00040247	0.844000	0.94266000	1.52500	0.000101630
0.5020	-0.00037256	0.848000	0.92713000	1.52600	0.000006424
0.5040	0.00099225	0.852000	0.91182000	1.52700	-0.000176100
0.5060	0.00145780	0.856000	0.89494000	1.52800	-0.000024741
0.5080	0.00054801	0.860000	0.88137000	1.52900	0.000057610
0.5100	0.00232040	0.864000	0.87936000	1.53000	0.000055558
0.5120	-0.00080490	0.868000	0.87890000	1.53100	0.000091596
0.5140	0.00036360	0.872000	0.88140000	1.53200	0.000083413
0.5160	0.00065213	0.876000	0.88961000	1.53300	-0.000093936
0.5180	0.00059149	0.880000	0.90306000	1.53400	-0.000057554
0.5200	0.00105990	0.884000	0.91088000	1.53500	-0.000042028
0.5220	0.00035601	0.888000	0.91829000	1.53600	0.000075945
0.5240	0.00036057	0.892000	0.92122000	1.53700	-0.000012790
0.5260	0.00105190	0.896000	0.91803000	1.53800	0.000099378
0.5280	0.00055215	0.900000	0.91011000	1.53900	0.000045824
0.5300	-0.00012421	0.904000	0.90012000	1.54000	0.000021990
0.5320	0.00047263	0.908000	0.89090000	1.54100	-0.000019757
0.5340	0.00082340	0.912000	0.88094000	1.54200	0.000005220
0.5360	0.00014585	0.916000	0.87042000	1.54300	-0.000079663
0.5380	-0.00022358	0.920000	0.85882000	1.54400	0.000104140
0.5400	0.00044711	0.924000	0.84813000	1.54500	-0.000020148
0.5420	0.00076023	0.928000	0.83930000	1.54600	-0.000029887
0.5440	0.00019086	0.932000	0.83123000	1.54700	0.000131280
0.5460	0.00004385	0.936000	0.82524000	1.54800	0.000175410
0.5480	0.00011626	0.940000	0.81958000	1.54900	0.000183200
0.5500	0.00072587	0.944000	0.81343000	1.55000	0.000054998
0.5520	0.00007916	0.948000	0.80821000	1.55100	0.000069278
0.5540	0.00032135	0.952000	0.80033000	1.55200	0.000240400
0.5560	0.00050386	0.956000	0.79039000	1.55300	0.000401370
0.5580	-0.00020179	0.960000	0.78144000	1.55400	0.000313030
0.5600	0.00079493	0.964000	0.77299000	1.55500	0.000484210
0.5620	0.00007292	0.968000	0.76520000	1.55600	0.000591330
0.5640	0.00074593	0.972000	0.75469000	1.55700	0.000790040
0.5660	0.00064544	0.976000	0.73778000	1.55800	0.000961190
0.5680	0.00064496	0.980000	0.71486000	1.55900	0.001589000
0.5700	0.00097680	0.984000	0.69212000	1.56000	0.001800800
0.5720	0.00165710	0.988000	0.67341000	1.56100	0.002371600

0.5740	0.00251290	0.992000	0.63120000	1.56200	0.002972200
0.5760	0.00420400	0.996000	0.38835000	1.56300	0.003952100
0.5780	0.01161900	1.000000	0.14816000	1.56400	0.005211700
0.5800	0.02651400	1.004000	0.05347300	1.56500	0.006863100
0.5820	0.06341600	1.008000	0.02211000	1.56600	0.008723100
0.5840	0.16080000	1.012000	0.01094900	1.56700	0.011244000
0.5860	0.38693000	1.016000	0.00655780	1.56800	0.014642000
0.5880	0.66658000	1.020000	0.00458210	1.56900	0.019020000
0.5900	0.76907000	1.024000	0.00357610	1.57000	0.024393000
0.5920	0.76508000	1.028000	0.00292100	1.57100	0.032848000
0.5940	0.76763000	1.032000	0.00254410	1.57200	0.043169000
0.5960	0.79179000	1.036000	0.00217540	1.57300	0.057503000
0.5980	0.83469000	1.040000	0.00185040	1.57400	0.075742000
0.6000	0.87494000	1.044000	0.00159920	1.57500	0.098709000
0.6020	0.89889000	1.048000	0.00133900	1.57600	0.136560000
0.6040	0.90642000	1.052000	0.00108770	1.57700	0.176150000
0.6060	0.89700000	1.056000	0.00082893	1.57800	0.236340000
0.6080	0.88786000	1.060000	0.00066063	1.57900	0.310350000
0.6100	0.89147000	1.064000	0.00050663	1.58000	0.390550000
0.6120	0.90408000	1.068000	0.00037695	1.58100	0.496040000
0.6140	0.92198000	1.072000	0.00031597	1.58200	0.595130000
0.6160	0.94257000			1.58300	0.701360000
0.6180	0.96405000			1.58400	0.784250000
0.6200	0.98003000			1.58500	0.859190000
0.6220	0.98640000			1.58600	0.897820000
0.6240	0.98213000			1.58700	0.923290000
0.6260	0.97177000			1.58800	0.956980000
0.6280	0.95834000			1.58900	0.940140000
0.6300	0.94400000			1.59000	0.928070000
0.6320	0.93480000			1.59100	0.919140000
0.6340	0.93324000			1.59200	0.910820000
0.6360	0.93526000			1.59300	0.924050000
0.6380	0.94456000			1.59400	0.930060000
0.6400	0.95756000			1.59500	0.911520000
0.6420	0.96958000			1.59600	0.907940000
0.6440	0.98264000			1.59700	0.916790000
0.6460	0.99047000			1.59800	0.908530000
0.6480	0.99853000			1.59900	0.946930000
0.6500	1.00000000			1.60000	0.960790000
0.6520	0.99789000			1.60100	0.957710000
0.6540	0.99307000			1.60200	0.968370000
0.6560	0.98567000			1.60300	0.968100000

0.6580	0.97194000			1.60400	0.981100000
0.6600	0.95121000			1.60500	0.985740000
0.6620	0.92923000			1.60600	0.955700000
0.6640	0.90016000			1.60700	0.961040000
0.6660	0.87321000			1.60800	0.955620000
0.6680	0.85415000			1.60900	0.981330000
0.6700	0.85318000			1.61000	0.987600000
0.6720	0.86726000			1.61100	0.992380000
0.6740	0.87199000			1.61200	0.972550000
0.6760	0.81662000			1.61300	0.964410000
0.6780	0.64769000			1.61400	0.964830000
0.6800	0.43377000			1.61500	0.962300000
0.6820	0.25540000			1.61600	0.953390000
0.6840	0.14503000			1.61700	0.955320000
0.6860	0.08242100			1.61800	0.977560000
0.6880	0.04664600			1.61900	0.967290000
0.6900	0.02717600			1.62000	0.958620000
0.6920	0.01649200			1.62100	0.974000000
0.6940	0.00984420			1.62200	0.994910000
0.6960	0.00592750			1.62300	0.986090000
0.6980	0.00362220			1.62400	1.000000000
0.7000	0.00206610			1.62500	0.996360000
0.7020	0.00152460			1.62600	0.995200000
0.7040	0.00089587			1.62700	0.997270000
0.7060	0.00059520			1.62800	0.936490000
0.7080	0.00026319			1.62900	0.913790000
0.7100	0.00033777			1.63000	0.830290000
0.7120	0.00011142			1.63100	0.794160000
0.7140	-0.00057225			1.63200	0.687140000
0.7160	-0.00006643			1.63300	0.596050000
0.7180	-0.00007643			1.63400	0.492270000
0.7200	-0.00009934			1.63500	0.403400000
0.7220	0.00006103			1.63600	0.334640000
0.7240	-0.00010191			1.63700	0.265710000
0.7260	-0.00014393			1.63800	0.215530000
0.7280	-0.00010387			1.63900	0.165970000
0.7300	-0.00000720			1.64000	0.137340000
0.7320	0.00003358			1.64100	0.106560000
0.7340	-0.00016057			1.64200	0.083706000
0.7360	-0.00009983			1.64300	0.065608000
0.7380	0.00001037			1.64400	0.054346000
0.7400	0.00001561			1.64500	0.041714000

0.7420	-0.00017319			1.64600	0.035551000
0.7440	0.00002311			1.64700	0.028365000
0.7460	0.00004173			1.64800	0.022670000
0.7480	0.00000615			1.64900	0.018466000
0.7500	-0.00010863			1.65000	0.015188000
0.7520	-0.00004217			1.65100	0.012731000
0.7540	0.00017665			1.65200	0.010535000
0.7560	-0.00021392			1.65300	0.008633800
0.7580	-0.00001722			1.65400	0.007232600
0.7600	-0.00008858			1.65500	0.006012300
0.7620	-0.00017982			1.65600	0.004980000
0.7640	-0.00004305			1.65700	0.003837800
0.7660	0.00001801			1.65800	0.003580300
0.7680	0.00000340			1.65900	0.002976100
0.7700	-0.00003730			1.66000	0.002343600
0.7720	-0.00012824			1.66100	0.002314000
0.7740	-0.00009216			1.66200	0.001955400
0.7760	-0.00009263			1.66300	0.001346900
0.7780	-0.00011483			1.66400	0.001345400
0.7800	-0.00008490			1.66500	0.000995970
0.7820	-0.00013215			1.66600	0.001078900
0.7840	-0.01468800			1.66700	0.000904210
0.7860	-0.00006084			1.66800	0.000654970
0.7880	0.00000003			1.66900	0.000664360
0.7900	0.00007289			1.67000	0.000687900
0.7920	-0.00007105			1.67100	0.000279930
0.7940	0.00007421			1.67200	0.000522200
0.7960	-0.00010106			1.67300	0.000324490
0.7980	-0.00021559			1.67400	0.000353510
0.8000	-0.00000594			1.67500	0.000335800
0.8020	0.00002729			1.67600	0.000404280
0.8040	0.00012729			1.67700	0.000052339
0.8060	-0.00001864			1.67800	0.000362860
0.8080	-0.00004721			1.67900	0.000065419
0.8100	-0.00005338			1.68000	0.000237100
0.8120	-0.00009274			1.68100	0.000198800
0.8140	-0.00008285			1.68200	0.000236440
0.8160	0.00013825			1.68300	0.000161770
0.8180	-0.00005375			1.68400	0.000134050
0.8200	-0.00013776			1.68500	0.000087196
0.8220	0.00011589			1.68600	-0.000106600
0.8240	0.00003944			1.68700	0.000122260

0.8260	-0.00003713			1.68800	-0.000148200
0.8280	-0.00004543			1.68900	0.000175020
0.8300	-0.00023922			1.69000	0.000304520
-	-	-		1.69100	-0.000207450
-	-	-		1.69200	0.000159340
-	-	-		1.69300	0.000148790
-	-	-		1.69400	0.000115020
-	-	-		1.69500	0.000186090
-	-	-		1.69600	0.000129450
-	-	-		1.69700	0.000223220
-	-	-		1.69800	0.000022254
-	-	-		1.69900	0.000019095
-	-	-		1.70000	0.000259410
-	-	-		1.70100	-0.000112300
-	-	-		1.70200	0.000146930
-	-	-		1.70300	0.000136550
-	-	-		1.70400	-0.000011754
-	-	-		1.70500	-0.000136470
-	-	-		1.70600	0.000156500
-	-	-		1.70700	0.000210620
-	-	-		1.70800	0.000080756
-	-	-		1.70900	-0.000024426
-	-	-		1.71000	0.000049405
-	-	-		1.71100	-0.000162530
-	-	-		1.71200	0.000224280
-	-	-		1.71300	-0.000023573
-	-	-		1.71400	-0.000106120
-	-	-		1.71500	-0.000034273
-	-	-		1.71600	0.000045336
-	-	-		1.71700	0.000150760
-	-	-		1.71800	0.000007784
-	-	-		1.71900	0.000025023
-	-	-		1.72000	0.000078705
-	-	-		1.72100	-0.000053822
-	-	-		1.72200	0.000209280
-	-	-		1.72300	-0.000084665
-	-	-		1.72400	0.000123780
-	-	-		1.72500	-0.000188790
-	-	-		1.72600	-0.000198710
-	-	-		1.72700	0.000234720
-	-	-		1.72800	-0.000005186
-	-	-		1.72900	0.000091868

-	-	-		1.73000	0.000151680
---	---	---	--	---------	-------------

Table D.7-9. MetOp-B AVHRR/3 Spectral Response Values for Channels 3B, 4 and 5

Channel 3B		Channel 4		Channel 5	
Wavelength (µm)	Relative Response (percent)	Wavelength (µm)	Relative Response (percent)	Wavelength (µm)	Relative Response (percent)
2.980	0.00000508	8.800	-0.00008036	10.000	0.00056318
2.987	0.00000968	8.820	-0.00001893	10.020	-0.00062907
2.994	-0.00001838	8.840	0.00001916	10.040	-0.00021863
3.001	-0.00000229	8.860	0.00001761	10.060	-0.00072595
3.008	-0.00000685	8.880	-0.00006131	10.080	-0.00033386
3.015	-0.00000503	8.900	-0.00010735	10.100	-0.00054509
3.022	-0.00000902	8.920	-0.00004398	10.120	-0.00060754
3.029	0.00000730	8.940	0.00000435	10.140	-0.00107290
3.036	0.00000638	8.960	-0.00002393	10.160	-0.00035918
3.043	0.00000301	8.980	0.00015792	10.180	0.00005249
3.050	0.00000131	9.000	0.00004284	10.200	-0.00041883
3.057	0.00000494	9.020	-0.00006190	10.220	-0.00062141
3.064	0.00000747	9.040	-0.00005120	10.240	-0.00081826
3.071	-0.00000139	9.060	-0.00003418	10.260	-0.00083298
3.078	0.00004052	9.080	-0.00010853	10.280	-0.00078193
3.085	-0.00001776	9.100	0.00012205	10.300	-0.00048686
3.092	-0.00000298	9.120	0.00004106	10.320	0.00006655
3.099	0.00000392	9.140	0.00008082	10.340	-0.00090574
3.106	0.00000209	9.160	0.00005821	10.360	-0.00043211
3.113	0.00001145	9.180	-0.00001577	10.380	-0.00098842
3.120	0.00000231	9.200	0.00000850	10.400	0.00004499
3.127	0.00003747	9.220	0.00005747	10.420	-0.00095159
3.134	0.00001634	9.240	-0.00007981	10.440	0.00302120
3.141	0.00000384	9.260	-0.00012827	10.460	-0.00126600
3.148	0.00001853	9.280	-0.00002455	10.480	0.00113840
3.155	0.00001657	9.300	0.00005446	10.500	0.00276970
3.162	-0.00000870	9.320	-0.00008629	10.520	0.00044942
3.169	0.00002638	9.340	-0.00004530	10.540	0.00321480
3.176	-0.00002147	9.360	-0.00013713	10.560	0.00293380
3.183	-0.00000444	9.380	-0.00004247	10.580	0.00053494
3.190	-0.00000134	9.400	-0.00004495	10.600	0.00063912
3.197	-0.00001572	9.420	-0.00004136	10.620	0.00335800
3.204	0.00000819	9.440	-0.00011146	10.640	0.00078403
3.211	-0.00001928	9.460	-0.00003575	10.660	0.00232270
3.218	0.00002562	9.480	0.00007551	10.680	0.00074448
3.225	0.00001194	9.500	0.00003428	10.700	0.00129250

3.232	0.00002634	9.520	0.00006991	10.720	0.00098164
3.239	-0.00000750	9.540	-0.00007151	10.740	0.00201320
3.246	0.00001255	9.560	-0.00015015	10.760	0.00275120
3.253	0.00001039	9.580	0.00016461	10.780	0.00059896
3.260	0.00002364	9.600	0.00003256	10.800	-0.00027322
3.267	0.00003492	9.620	0.00005023	10.820	0.00104410
3.274	0.00005294	9.640	-0.00011511	10.840	0.00008504
3.281	0.00004137	9.660	-0.00005455	10.860	0.00281120
3.288	0.00005209	9.680	-0.00004720	10.880	0.00108480
3.295	0.00005639	9.700	0.00006324	10.900	0.00052293
3.302	0.00008997	9.720	0.00017170	10.920	0.00159440
3.309	0.00008804	9.740	0.00020018	10.940	0.00103110
3.316	0.00009646	9.760	0.00036281	10.960	-0.00009957
3.323	0.00012132	9.780	0.00055111	10.980	0.00041718
3.330	0.00015848	9.800	0.00080483	11.000	-0.00070797
3.337	0.00014111	9.820	0.00108120	11.020	-0.00152270
3.344	0.00014970	9.840	0.00131520	11.040	-0.00089280
3.351	0.00018777	9.860	0.00199330	11.060	-0.00019214
3.358	0.00018081	9.880	0.00233550	11.080	-0.00138710
3.365	0.00021912	9.900	0.00298780	11.100	0.00084211
3.372	0.00029479	9.920	0.00340950	11.120	0.00057674
3.379	0.00034177	9.940	0.00428190	11.140	-0.00012968
3.386	0.00046575	9.960	0.00511990	11.160	-0.00166320
3.393	0.00062269	9.980	0.00733500	11.180	-0.00091153
3.400	0.00084692	10.000	0.00958470	11.200	-0.00085143
3.407	0.00114880	10.020	0.01268000	11.220	-0.00141130
3.414	0.00159770	10.040	0.01652200	11.240	-0.00094531
3.421	0.00219360	10.060	0.02082300	11.260	0.00043440
3.428	0.00300610	10.080	0.02892400	11.280	-0.00114530
3.435	0.00419200	10.100	0.03943700	11.300	-0.00125770
3.442	0.00564300	10.120	0.05509200	11.320	-0.00117300
3.449	0.00719840	10.140	0.07504900	11.340	-0.00058341
3.456	0.00945620	10.160	0.10200000	11.360	-0.00049172
3.463	0.01182600	10.180	0.13521000	11.380	-0.00087076
3.470	0.01462200	10.200	0.18164000	11.400	-0.00036770
3.477	0.01772900	10.220	0.23043000	11.420	0.00122940
3.484	0.02147100	10.240	0.29141000	11.440	0.00207240
3.491	0.02665000	10.260	0.36924000	11.460	0.00984800
3.498	0.03288200	10.280	0.45517000	11.480	0.02555400
3.505	0.04224100	10.300	0.55460000	11.500	0.06010900
3.512	0.05615700	10.320	0.65000000	11.520	0.13300000
3.519	0.07560000	10.340	0.74947000	11.540	0.27534000

3.526	0.10291000	10.360	0.83280000	11.560	0.48804000
3.533	0.14057000	10.380	0.89197000	11.580	0.71559000
3.540	0.19644000	10.400	0.91304000	11.600	0.86876000
3.547	0.27236000	10.420	0.93720000	11.620	0.92259000
3.554	0.37133000	10.440	0.95083000	11.640	0.91984000
3.561	0.49216000	10.460	0.94759000	11.660	0.92366000
3.568	0.60520000	10.480	0.95763000	11.680	0.92348000
3.575	0.72277000	10.500	0.95225000	11.700	0.93083000
3.582	0.79223000	10.520	0.93030000	11.720	0.95631000
3.589	0.81015000	10.540	0.92223000	11.740	0.95621000
3.596	0.80347000	10.560	0.92482000	11.760	0.96991000
3.603	0.81107000	10.580	0.92058000	11.780	0.97494000
3.610	0.81369000	10.600	0.92652000	11.800	0.98129000
3.617	0.81523000	10.620	0.92953000	11.820	0.97413000
3.624	0.81808000	10.640	0.94701000	11.840	0.97974000
3.631	0.81110000	10.660	0.95510000	11.860	0.98314000
3.638	0.81260000	10.680	0.96635000	11.880	0.97241000
3.645	0.81168000	10.700	0.95574000	11.900	0.97657000
3.652	0.81712000	10.720	0.98638000	11.920	0.97378000
3.659	0.81911000	10.740	0.97441000	11.940	0.97118000
3.666	0.82706000	10.760	0.99517000	11.960	0.97575000
3.673	0.82531000	10.780	0.98963000	11.980	0.98938000
3.680	0.82369000	10.800	0.99661000	12.000	0.97946000
3.687	0.83100000	10.820	0.98475000	12.020	0.98884000
3.694	0.83753000	10.840	0.99270000	12.040	0.99137000
3.701	0.83408000	10.860	1.00000000	12.060	1.00000000
3.708	0.84100000	10.880	0.99252000	12.080	0.98730000
3.715	0.86250000	10.900	0.98772000	12.100	0.97913000
3.722	0.85965000	10.920	0.98035000	12.120	0.97358000
3.729	0.85962000	10.940	0.98203000	12.140	0.96800000
3.736	0.86691000	10.960	0.97078000	12.160	0.95843000
3.743	0.86264000	10.980	0.96874000	12.180	0.95541000
3.750	0.88044000	11.000	0.96789000	12.200	0.94383000
3.757	0.87646000	11.020	0.94467000	12.220	0.94400000
3.764	0.88621000	11.040	0.93186000	12.240	0.94149000
3.771	0.88511000	11.060	0.90258000	12.260	0.93329000
3.778	0.89247000	11.080	0.87792000	12.280	0.94086000
3.785	0.88768000	11.100	0.84537000	12.300	0.94037000
3.792	0.90158000	11.120	0.78800000	12.320	0.94119000
3.799	0.90945000	11.140	0.74996000	12.340	0.93364000
3.806	0.92280000	11.160	0.69041000	12.360	0.93111000
3.813	0.91846000	11.180	0.63093000	12.380	0.92813000

3.820	0.91929000	11.200	0.55366000	12.400	0.92528000
3.827	0.93736000	11.220	0.46137000	12.420	0.92541000
3.834	0.90004000	11.240	0.36089000	12.440	0.91432000
3.841	0.91983000	11.260	0.27573000	12.460	0.90642000
3.848	0.91578000	11.280	0.19609000	12.480	0.89346000
3.855	0.92624000	11.300	0.14017000	12.500	0.84529000
3.862	0.93888000	11.320	0.09843200	12.520	0.72033000
3.869	0.93830000	11.340	0.06945700	12.540	0.55962000
3.876	0.94799000	11.360	0.05135400	12.560	0.37422000
3.883	0.96071000	11.380	0.04026300	12.580	0.21811000
3.890	0.96331000	11.400	0.02983500	12.600	0.11665000
3.897	0.97377000	11.420	0.02402400	12.620	0.05073500
3.904	0.95895000	11.440	0.01966600	12.640	0.02499500
3.911	0.96854000	11.460	0.01440400	12.660	0.01256900
3.918	0.93834000	11.480	0.01077000	12.680	0.00526620
3.925	1.00000000	11.500	0.00874080	12.700	0.00176090
3.932	0.89143000	11.520	0.00716170	12.720	-0.00201850
3.939	0.75771000	11.540	0.00630190	12.740	0.00051316
3.946	0.59276000	11.560	0.00481460	12.760	0.00152930
3.953	0.44084000	11.580	0.00508080	12.780	-0.00151600
3.960	0.32923000	11.600	0.00326220	12.800	-0.00310900
3.967	0.23109000	11.620	0.00283510	12.820	0.00223100
3.974	0.16487000	11.640	0.00213150	12.840	0.00108980
3.981	0.11541000	11.660	0.00203150	12.860	-0.00069668
3.988	0.07918200	11.680	0.00131600	12.880	0.00157090
3.995	0.05659300	11.700	0.00132660	12.900	-0.00280910
4.002	0.04020200	11.720	0.00092098	12.920	-0.00360090
4.009	0.02894000	11.740	0.00061250	12.940	0.00112340
4.016	0.02120500	11.760	0.00030269	12.960	-0.00287450
4.023	0.01608500	11.780	-0.00037521	12.980	0.00052712
4.030	0.01224900	11.800	0.00059771	13.000	0.00211170
4.037	0.00935780	11.820	0.00028134	13.020	0.00304970
4.044	0.00747400	11.840	0.00041029	13.040	0.00176620
4.051	0.00584580	11.860	0.00016921	13.060	0.00311350
4.058	0.00471730	11.880	0.00010575	13.080	0.00218120
4.065	0.00390440	11.900	0.00011359	13.100	0.00423110
4.072	0.00305280	11.920	0.00040389	13.120	0.00065949
4.079	0.00259140	11.940	-0.00020131	13.140	-0.00391690
4.086	0.00199490	11.960	0.00045560	13.160	0.00314090
4.093	0.00174930	11.980	-0.00048074	13.180	-0.00284880
4.100	0.00136660	12.000	-0.00026066	13.200	-0.00295080
4.107	0.00111960	12.020	0.00001263	13.220	0.00118890

4.114	0.00083853	12.040	0.00016527	13.240	0.00290750
4.121	0.00065398	12.060	-0.00001229	13.260	0.00831410
4.128	0.00047147	12.080	-0.00000551	13.280	0.00110680
4.135	0.00034360	12.100	-0.00032664	13.300	0.00131090
4.142	0.00030657	12.120	0.00020091	13.320	-0.00104230
4.149	0.00026329	12.140	0.00008586	13.340	0.00100960
4.156	0.00020121	12.160	0.00019772	13.360	0.00093922
4.163	0.00019194	12.180	0.00001919	13.380	-0.00301550
4.170	0.00010838	12.200	0.00001924	13.400	-0.00105210
4.177	0.00032553	12.220	-0.00039087	13.420	-0.00201130
4.184	0.00021207	12.240	0.00029574	13.440	-0.00495900
4.191	0.00011910	12.260	-0.00003664	13.460	-0.00188660
4.198	0.00007604	12.280	-0.00002106	13.480	0.00204190
4.205	-0.00006446	12.300	-0.00010464	13.500	0.00081562
4.212	-0.00018282	12.320	-0.00008421	13.520	0.00058922
4.219	-0.00001561	12.340	0.00045498	13.540	0.00404220
4.226	0.00050283	12.360	-0.00039295	13.560	0.00038654
4.233	0.00003018	12.380	0.00072908	13.580	0.00145310
4.240	-0.00019533	12.400	-0.00014269	13.600	0.00051084
4.247	-0.00048255	12.420	0.00068225	13.620	0.00381940
4.254	-0.00012385	12.440	-0.00036456	13.640	0.00640420
4.261	-0.00014211	12.460	-0.00021209	13.660	0.00130070
4.268	-0.00026196	12.480	-0.00013351	13.680	0.00337420
4.275	-0.00016967	12.500	0.00018237	13.700	0.00519960
4.282	-0.00001760	12.520	0.00017760	13.720	0.00304820
4.289	0.00000386	12.540	-0.00050029	13.740	0.00038239
4.296	0.00001424	12.560	-0.00003255	13.760	0.00006128
4.303	0.00002041	12.580	0.00059975	13.780	-0.00119690
4.310	0.00001790	12.600	-0.00001191	13.800	-0.00384750
4.317	0.00005586	12.620	0.00022072	13.820	0.00486140
4.324	-0.00001387	12.640	-0.00023501	13.840	-0.00324080
4.331	-0.00002520	12.660	0.00004242	13.860	-0.00087508
4.338	-0.00005657	12.680	0.00036990	13.880	0.00655280
4.345	-0.00002541	12.700	-0.00014223	13.900	-0.00009481
4.352	-0.00003748	12.720	0.00010440	13.920	0.00391760
4.359	-0.00006434	12.740	-0.00039481	13.940	-0.00167550
4.366	-0.00001653	12.760	-0.00005571	13.960	-0.00325050
4.373	0.00005343	12.780	0.00006544	13.980	-0.00244970
4.380	0.00001735	12.800	0.00020174	14.000	0.00190970
4.387	-0.00000441				
4.394	-0.00000859				
4.401	-0.00001955				

4.408	-0.00003920				
4.415	-0.00000759				
4.422	0.00001209				
4.429	-0.00002412				
4.436	0.00003428				
4.443	-0.00000221				
4.450	0.00001969				
4.457	-0.00000986				
4.464	0.00004424				
4.471	0.00002294				
4.478	0.00002803				
4.485	-0.00000990				
4.492	0.00003985				
4.499	-0.00002494				

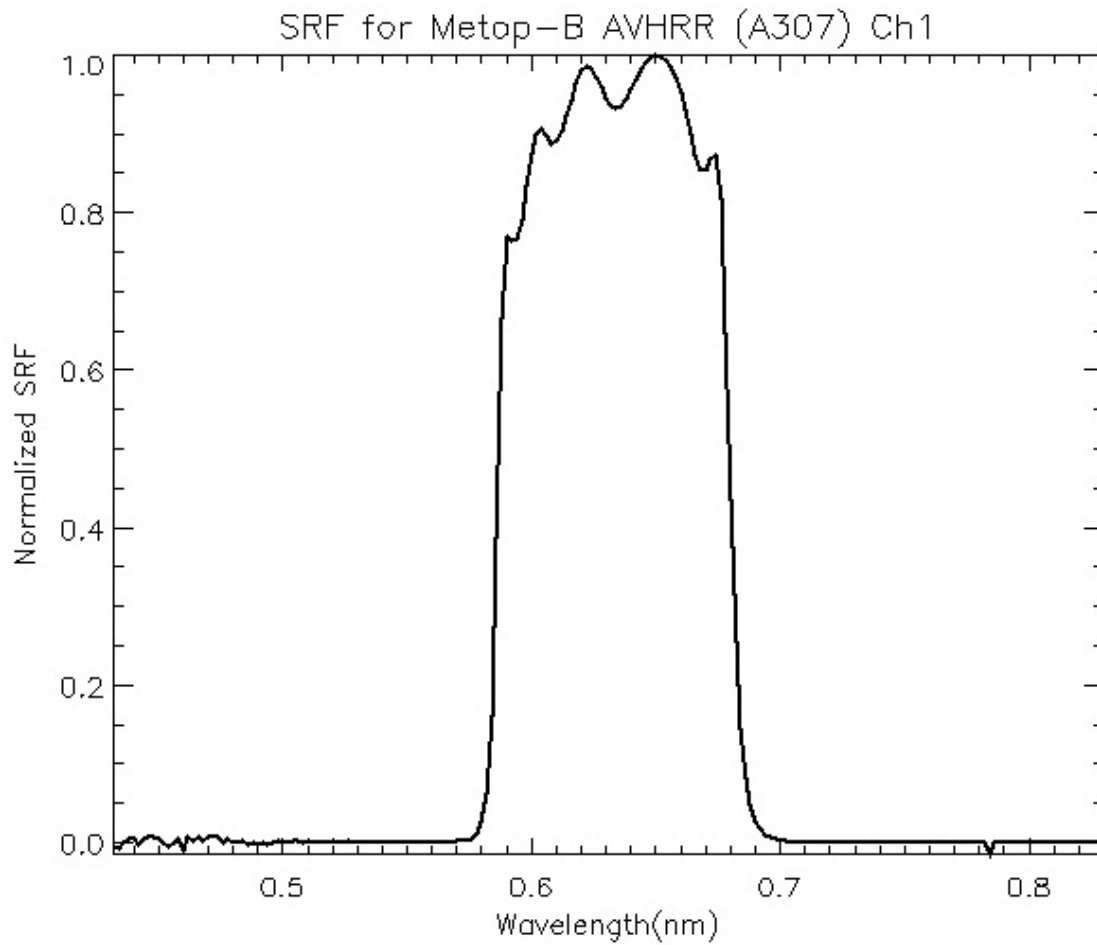

Figure D.7-1. Spectral Response Curve for MetOp-B Channel 1.

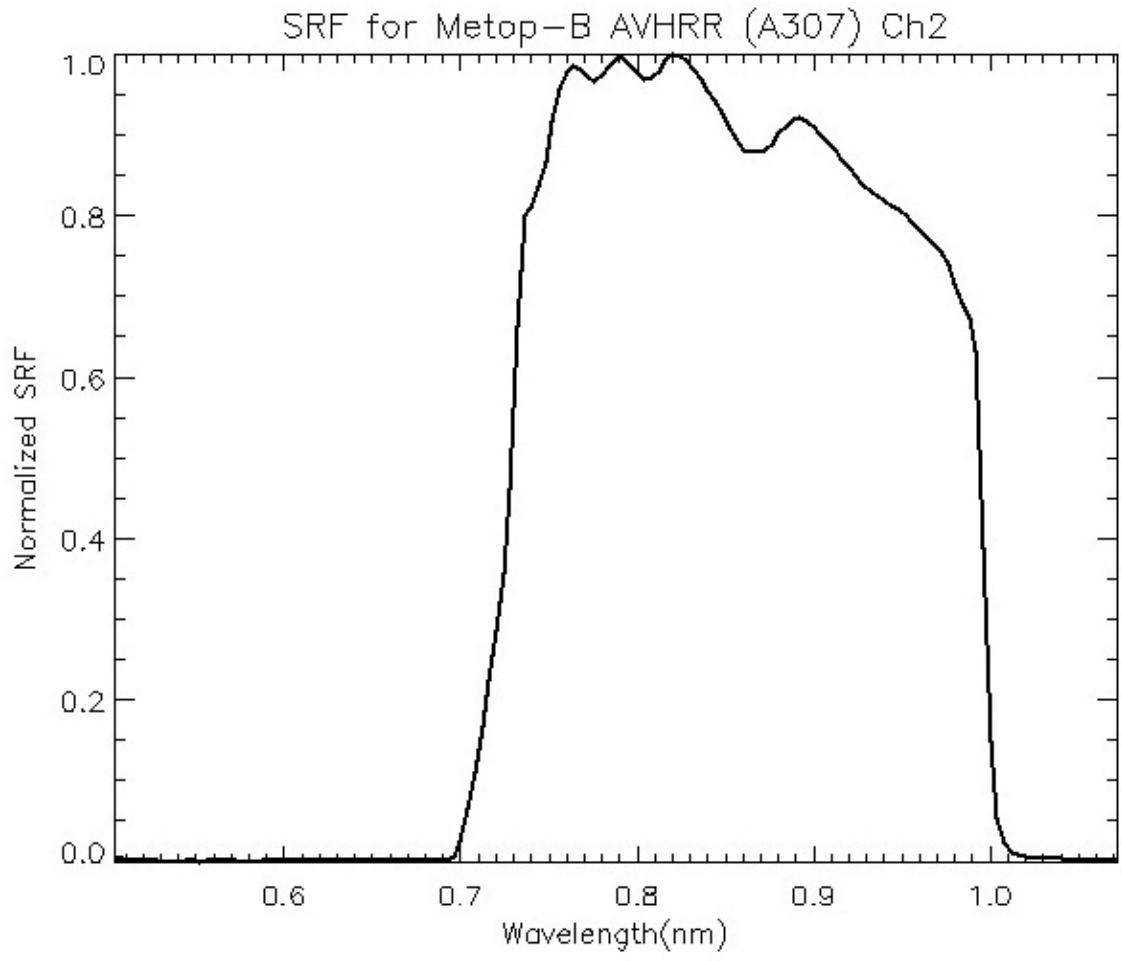

Figure D.7-2. Spectral Response Curve for MetOp-B Channel 2.

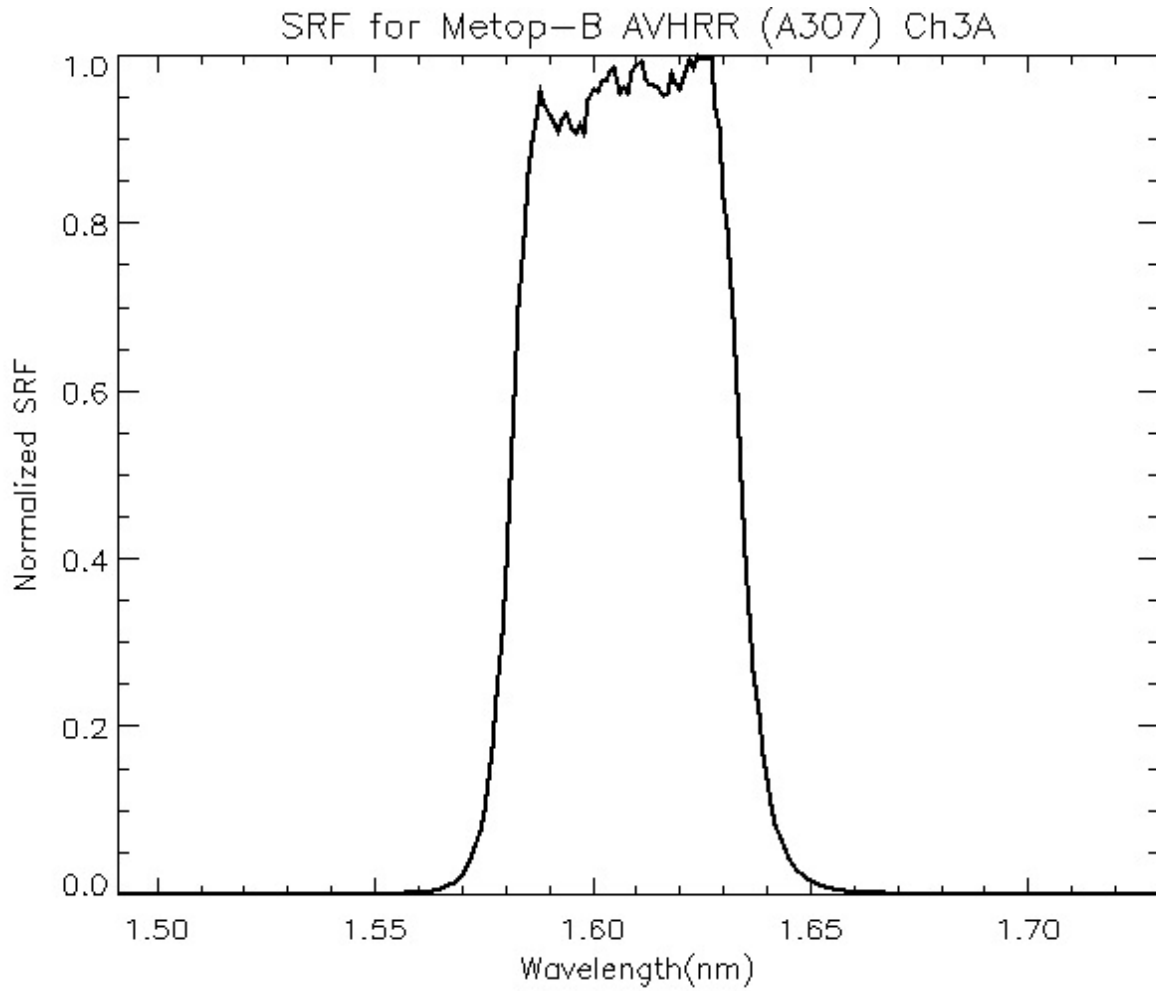

Figure D.7-3. Spectral Response Curve for MetOp-B Channel 3A.

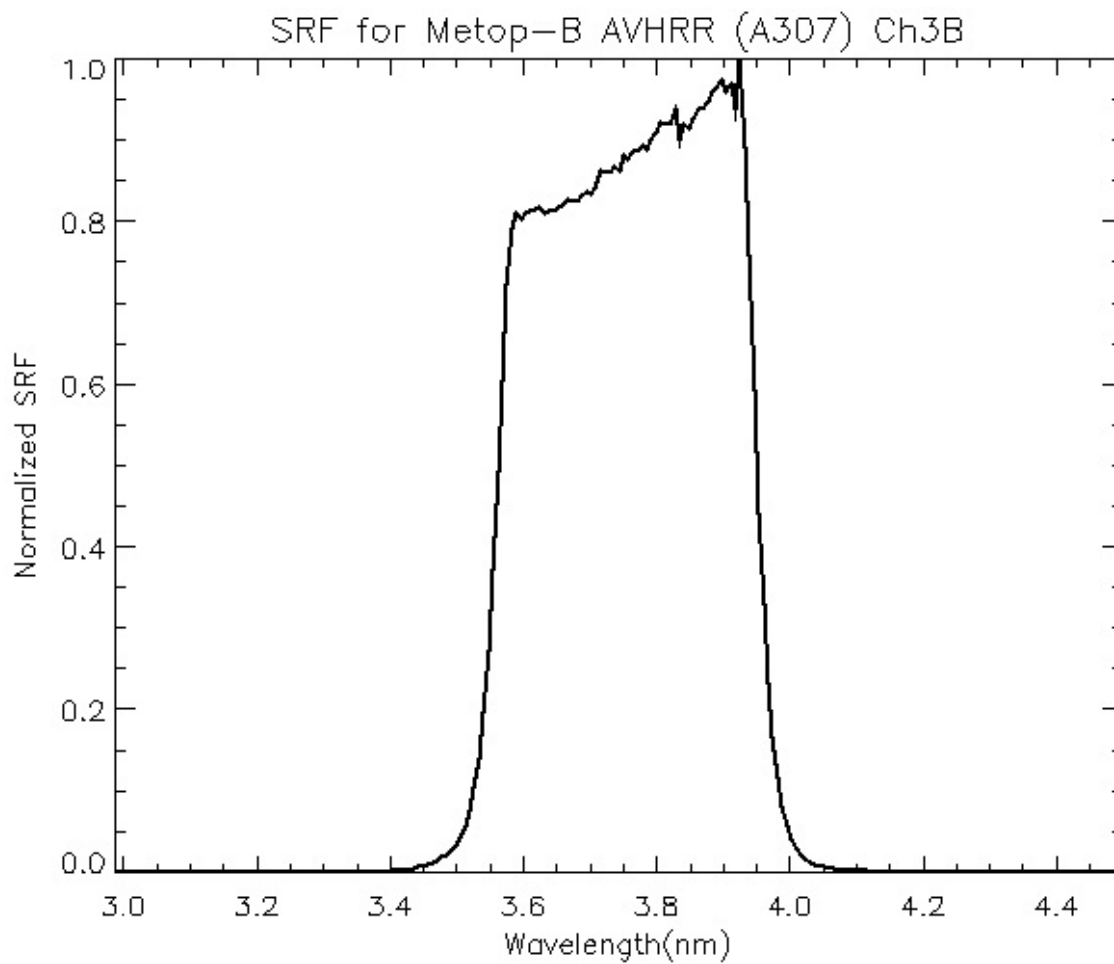

Figure D.7-4. Spectral Response Curve for MetOp-B Channel 3B.

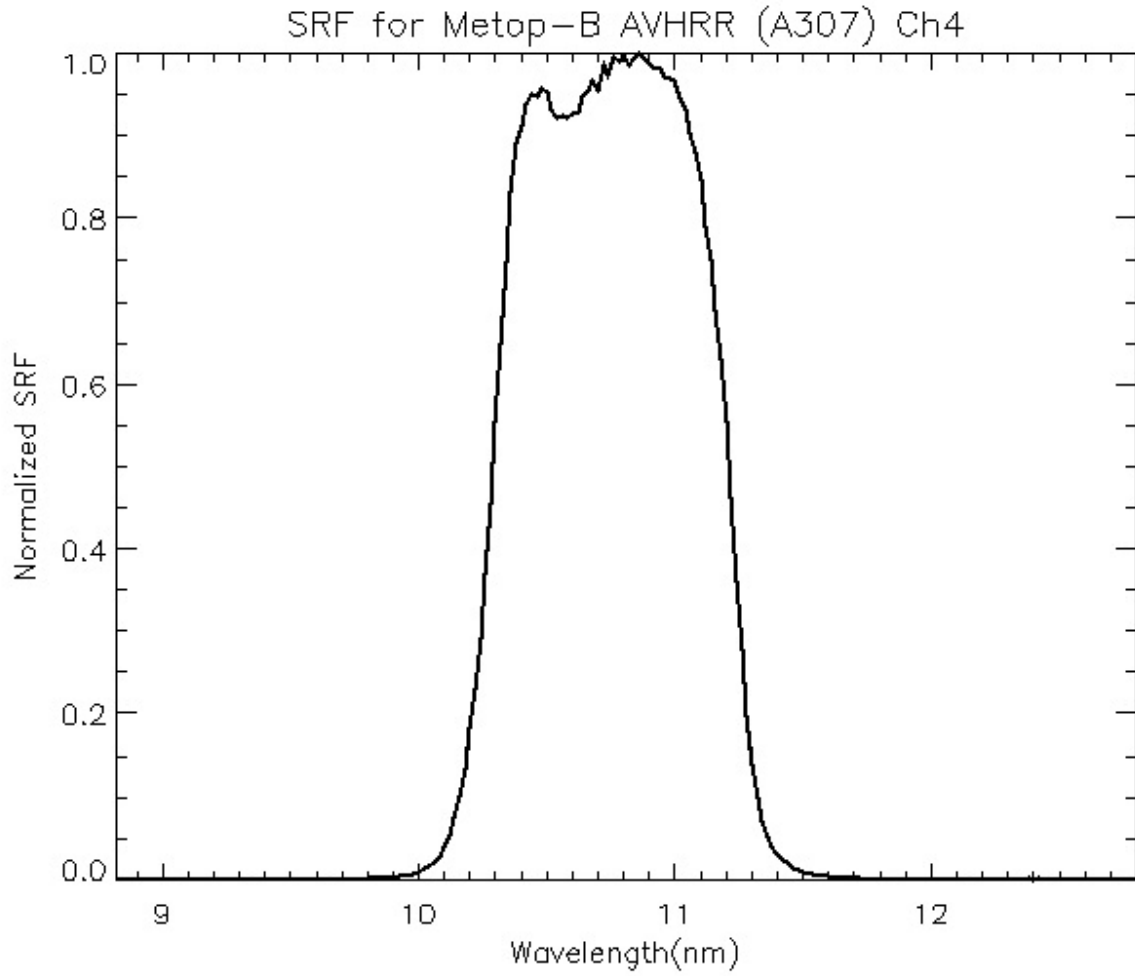

Figure D.7-5. Spectral Response Curve for MetOp-B Channel 4.

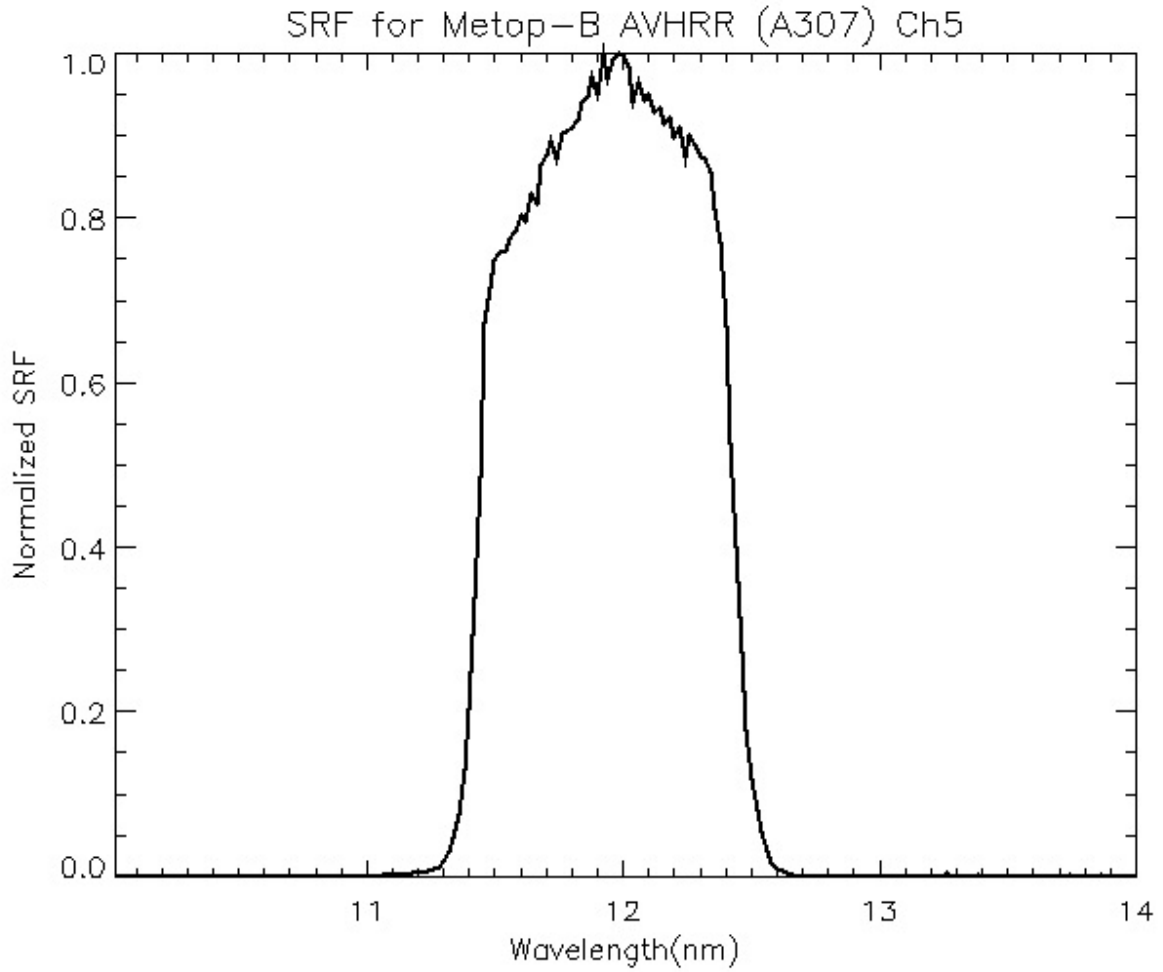

Figure D.7-6. Spectral Response Curve for MetOp-B Channel 5.

HIRS:

Table D.7-10 contains the NOAA-P HIRS/H308 central wave numbers, half power bandwidth and band correction coefficients for the thermal channels.

Channel #	ν_C (cm⁻¹)	Half power bandwidth (cm⁻¹)	b	c
1	668.83	3.20	0.002298	0.999989
2	679.28	12.14	.0127210.	0.999940
3	690.37	14.06	.0.022041	0.999898
4	703.80	14.88	0.019609	0.999911
5	714.94	17.53	0.026485	0.999882
6	731.45	14.85	0.022291	0.999903
7	747.36	18.32	0.027144	0.999884
8	898.80	34.83	0.065263	0.999769
9	1029.23	22.71	0.037616	0.999879
10	802.65	15.58	0.017691	0.999930
11	1360.75	36.89	0.084581	0.999787
12	1533.60	51.95	0.122084	0.999721
13	2185.71	22.79	0.026447	0.999956
14	2206.64	22.70	0.025216	0.999958
15	2234.18	20.45	0.020582	0.999966
16	2242.95	23.90	0.022796	0.999962
17	2421.05	30.84	0.042463	0.999935
18	2515.97	36.27	0.052340	0.999925
19	2664.83	102.99	0.396190	0.999574

Table D.6-11 contains the Internal Warm Temperature (IWT) PRT count to temperature coefficients for the NOAA-19 HIRS/H308 instrument.

PRT	A	B	C	D	E	F
1	301.3420	6.56263 E-03	8.746160 E-08	3.706978 E-11	1.074574 E-15	5.417087 E-19
2	301.3614	6.55501 E-03	8.781544 E-08	3.704888 E-11	9.813218 E-16	5.373182 E-19
3	301.3454	6.55864 E-03	8.759710 E-08	3.716591 E-11	1.021348 E-15	5.279012 E-19
4	301.3850	6.563882 E-03	8.735222 E-08	3.644194 E-11	1.045697 E-15	5.706749 E-19

5	301.4011	6.554222 E-03	8.723129 E-08	3.673249 E-11	1.045459 E-15	5.507417 E-19
This information is based on the data in HIRS/4 H308 Alignment/Calibration Handbook, Revision E,						

Table D.-12 contains the primary, secondary and tertiary telescope temperature coefficients for the MetOp-B HIRS/H307 instrument.

Table D.7-12. MetOp-B HIRS H307 Primary, Secondary and Tertiary Telescope Temperature Coefficients (C).						
	A	B	C	D	E	F
Primary	260.1752	1.776047 E-02	-3.942533 E-06	1.450393 E-09	-2.857401 E-13	2.971761 E-17
Secondary	260.2281	1.769937 E-02	-3.896008 E-06	1.437580 E-09	-2.851347 E-13	2.984052 E-017
Tertiary	260.1109	1.759282 E-02	1.303540 E-06	-2.473824 E-09	-2.473842 E-13	2.604968 E-17
This information is based on the data in HIRS/4 H308 Alignment/Calibration Handbook, Revision E, May 2003.						

Table D.7-13 contains the actual filter functions for MetOp-B HIRS/H307. The same information can be downloaded as an ASCII file or viewed as a graphic file from the following website: <http://www.orbit.nesdis.noaa.gov/smcd/spb/calibration/hirs/srf/hirssrf.html>.

Table D.7-13. Normalized Response Functions for the MetOp-B HIRS H307 Thermal Channels.				
Channel 1				
Wavenumber	HIRS Filter Transmittance	Optical Element Transmittance	Product of the HIRS Filter and Optical Element Transmittances	Normalized Value of Column 4
660.4	0.000000	0.203906	0.000000	0.000000
660.5	0.001000	0.204062	0.000204	0.002383
660.6	0.001391	0.204218	0.000284	0.003317
660.7	0.001783	0.204374	0.000364	0.004254
660.8	0.002174	0.204531	0.000445	0.005192
660.9	0.002565	0.204687	0.000525	0.006131
661.0	0.002956	0.204844	0.000606	0.007071
661.1	0.003348	0.205001	0.000686	0.008013
661.2	0.003739	0.205158	0.000767	0.008957
661.3	0.004130	0.205321	0.000848	0.009902
661.4	0.004522	0.205490	0.000929	0.010849
661.5	0.004913	0.205659	0.001010	0.011798
661.6	0.005304	0.205839	0.001092	0.012748

661.7	0.005696	0.206013	0.001173	0.013701
661.8	0.006087	0.206187	0.001255	0.014654
661.9	0.006478	0.206367	0.001337	0.015610
662.0	0.006870	0.206547	0.001419	0.016567
662.1	0.007261	0.207040	0.001503	0.017553
662.2	0.007652	0.207534	0.001588	0.018543
662.3	0.008044	0.208031	0.001673	0.019538
662.4	0.008435	0.208533	0.001759	0.020537
662.5	0.008826	0.209036	0.001845	0.021542
662.6	0.009217	0.209544	0.001931	0.022552
662.7	0.009609	0.210053	0.002018	0.023566
662.8	0.010000	0.210565	0.002106	0.024586
662.9	0.010403	0.211079	0.002196	0.025639
663.0	0.010817	0.211594	0.002289	0.026724
663.1	0.011243	0.212115	0.002385	0.027845
663.2	0.011681	0.212638	0.002484	0.029001
663.3	0.012130	0.213162	0.002586	0.030190
663.4	0.012591	0.213688	0.002691	0.031415
663.5	0.013064	0.214215	0.002799	0.032675
663.6	0.013548	0.214738	0.002909	0.033969
663.7	0.014043	0.215257	0.003023	0.035295
663.8	0.014551	0.215777	0.003140	0.036660
663.9	0.015070	0.216299	0.003260	0.038059
664.0	0.015600	0.216821	0.003382	0.039493
664.1	0.018009	0.217081	0.003909	0.045647
664.2	0.020900	0.217342	0.004542	0.053038
664.3	0.023691	0.217603	0.005155	0.060193
664.4	0.025800	0.217862	0.005621	0.065629
664.5	0.027809	0.218122	0.006066	0.070824
664.6	0.029500	0.218379	0.006442	0.075219
664.7	0.031010	0.218635	0.006780	0.079162
664.8	0.033000	0.218890	0.007223	0.084340
664.9	0.036013	0.219142	0.007892	0.092147
665.0	0.039600	0.219394	0.008688	0.101441
665.1	0.043150	0.219643	0.009478	0.110661
665.2	0.046400	0.219891	0.010203	0.119130
665.3	0.049289	0.220140	0.010850	0.126691
665.4	0.052200	0.220389	0.011504	0.134325
664.4	0.025800	0.217862	0.005621	0.065629
664.5	0.027809	0.218122	0.006066	0.070824
664.6	0.029500	0.218379	0.006442	0.075219
664.7	0.031010	0.218635	0.006780	0.079162
664.8	0.033000	0.218890	0.007223	0.084340

664.9	0.036013	0.219142	0.007892	0.092147
665.0	0.039600	0.219394	0.008688	0.101441
665.1	0.043150	0.219643	0.009478	0.110661
665.2	0.046400	0.219891	0.010203	0.119130
665.3	0.049289	0.220140	0.010850	0.126691
665.4	0.052200	0.220389	0.011504	0.134325
665.5	0.055584	0.220637	0.012264	0.143194
665.6	0.059700	0.220877	0.013186	0.153964
665.7	0.064652	0.221117	0.014296	0.166916
665.8	0.070100	0.221357	0.015517	0.181179
665.9	0.075685	0.221598	0.016772	0.195826
666.0	0.081400	0.221839	0.018058	0.210843
666.1	0.087208	0.222240	0.019381	0.226295
666.2	0.092600	0.222642	0.020617	0.240721
666.3	0.097170	0.223045	0.021673	0.253058
666.4	0.101400	0.223449	0.022658	0.264552
666.5	0.105990	0.223853	0.023726	0.277028
666.6	0.111600	0.224259	0.025027	0.292219
666.7	0.118800	0.224665	0.026690	0.311635
666.8	0.127800	0.225071	0.028764	0.335851
666.9	0.138460	0.225478	0.031220	0.364523
667.0	0.149600	0.225886	0.033793	0.394563
667.1	0.160010	0.226322	0.036214	0.422835
667.2	0.169300	0.226759	0.038390	0.448247
667.3	0.177570	0.227197	0.040343	0.471050
667.4	0.186000	0.227634	0.042340	0.494362
667.5	0.195890	0.228062	0.044675	0.521629
667.6	0.208000	0.228489	0.047526	0.554913
667.7	0.222810	0.228917	0.051005	0.595536
667.8	0.240100	0.229344	0.055066	0.642948
667.9	0.259150	0.229772	0.059545	0.695253
668.0	0.277900	0.230200	0.063972	0.746945
668.1	0.294320	0.230731	0.067909	0.792905
668.2	0.308000	0.231263	0.071229	0.831672
668.3	0.318980	0.231796	0.073938	0.863306
668.4	0.327600	0.232330	0.076111	0.888678
668.5	0.334370	0.232864	0.077863	0.909130
668.6	0.340300	0.233401	0.079426	0.927386
668.7	0.346280	0.233939	0.081008	0.945857
668.8	0.352200	0.234478	0.082583	0.964246
668.9	0.357560	0.235019	0.084033	0.981178
669.0	0.361400	0.235561	0.085132	0.994001
669.1	0.362750	0.236101	0.085645	1.000000

669.2	0.361100	0.236641	0.085451	0.997730
669.3	0.356310	0.237184	0.084511	0.986754
669.4	0.349200	0.237723	0.083013	0.969260
669.5	0.340580	0.238258	0.081146	0.947462
669.6	0.330300	0.238796	0.078874	0.920940
669.7	0.318040	0.239335	0.076118	0.888758
669.8	0.303800	0.239875	0.072874	0.850882
669.9	0.287780	0.240417	0.069187	0.807834
670.0	0.270700	0.240960	0.065228	0.761603
670.1	0.253450	0.241270	0.061150	0.713987
670.2	0.237100	0.241579	0.057278	0.668785
670.3	0.222380	0.241889	0.053791	0.628070
670.4	0.208500	0.242199	0.050499	0.589623
670.5	0.194450	0.242510	0.047156	0.550595
670.6	0.180000	0.242819	0.043707	0.510330
670.7	0.165090	0.243128	0.040138	0.468654
670.8	0.149600	0.243438	0.036418	0.425221
670.9	0.133660	0.243746	0.032579	0.380396
671.0	0.118400	0.244056	0.028896	0.337393
671.1	0.104970	0.244362	0.025651	0.299498
671.2	0.093500	0.244668	0.022876	0.267106
671.3	0.083932	0.244971	0.020561	0.240070
671.4	0.076400	0.245268	0.018738	0.218791
671.5	0.070852	0.245564	0.017399	0.203148
671.6	0.066300	0.245860	0.016301	0.190326
671.7	0.061671	0.246157	0.015181	0.177251
671.8	0.056500	0.246453	0.013925	0.162584
671.9	0.050450	0.246748	0.012448	0.145349
672.0	0.043100	0.247044	0.010648	0.124322
672.1	0.034453	0.247428	0.008525	0.099534
672.2	0.026300	0.247813	0.006517	0.076098
672.3	0.020439	0.248197	0.005073	0.059231
672.4	0.016900	0.248580	0.004201	0.049051
672.5	0.015253	0.248964	0.003797	0.044339
672.6	0.015000	0.249345	0.003740	0.043670
672.7	0.015560	0.249727	0.003886	0.045370
672.8	0.016100	0.250108	0.004027	0.047016
672.9	0.015895	0.250489	0.003982	0.046488
673.0	0.014900	0.250869	0.003738	0.043644
673.1	0.013189	0.251247	0.003314	0.038691
673.2	0.011700	0.251624	0.002944	0.034374
673.3	0.011371	0.251991	0.002865	0.033456
673.4	0.011060	0.252358	0.002791	0.032589

673.5	0.010768	0.252725	0.002721	0.031775
673.6	0.010494	0.253092	0.002656	0.031011
673.7	0.010238	0.253458	0.002595	0.030298
673.8	0.010000	0.253824	0.002538	0.029637
673.9	0.009780	0.254190	0.002486	0.029028
674.0	0.009561	0.254557	0.002434	0.028417
674.1	0.009342	0.254744	0.002380	0.027785
674.2	0.009122	0.254931	0.002325	0.027152
674.3	0.008902	0.255117	0.002271	0.026518
674.4	0.008683	0.255303	0.002217	0.025883
674.5	0.008463	0.255489	0.002162	0.025247
674.6	0.008244	0.255674	0.002108	0.024610
674.7	0.008024	0.255859	0.002053	0.023972
674.8	0.007805	0.256044	0.001998	0.023333
674.9	0.007585	0.256229	0.001944	0.022694
675.0	0.007366	0.256413	0.001889	0.022053
675.1	0.007146	0.256588	0.001834	0.021410
675.2	0.006927	0.256757	0.001779	0.020766
675.3	0.006707	0.256922	0.001723	0.020121
675.4	0.006488	0.257086	0.001668	0.019475
675.5	0.006268	0.257251	0.001613	0.018828
675.6	0.006049	0.257414	0.001557	0.018180
675.7	0.005829	0.257577	0.001501	0.017532
675.8	0.005610	0.257740	0.001446	0.016882
675.9	0.005390	0.257903	0.001390	0.016231
676.0	0.005171	0.258065	0.001334	0.015580
676.1	0.004951	0.258327	0.001279	0.014934
676.2	0.004732	0.258588	0.001224	0.014286
676.3	0.004512	0.258850	0.001168	0.013637
676.4	0.004293	0.259110	0.001112	0.012987
676.5	0.004073	0.259371	0.001056	0.012335
676.6	0.003854	0.259632	0.001001	0.011682
676.7	0.003634	0.259892	0.000944	0.011028
676.8	0.003415	0.260152	0.000888	0.010372
676.9	0.003195	0.260411	0.000832	0.009715
677.0	0.002976	0.260671	0.000776	0.009057
677.1	0.002756	0.260922	0.000719	0.008397
677.2	0.002537	0.261169	0.000662	0.007735
677.3	0.002317	0.261414	0.000606	0.007072
677.4	0.002098	0.261659	0.000549	0.006408
677.5	0.001878	0.261903	0.000492	0.005743
677.6	0.001659	0.262145	0.000435	0.005076
677.7	0.001439	0.262388	0.000378	0.004409

677.8	0.001220	0.262629	0.000320	0.003740
677.9	0.001000	0.262869	0.000263	0.003069
678.0	0.000000	0.263109	0.000000	0.000000
Channel 2				
Wavenumber	HIRS Filter Transmittance	Optical Element Transmittance	Product of the HIRS Filter and Optical Element Transmittances	Normalized Value of Column 4
659.7	0.000000	0.201968	0.000000	0.000000
659.8	0.000579	0.202405	0.000117	0.000678
659.9	0.001000	0.202843	0.000203	0.001175
660.0	0.001145	0.203281	0.000233	0.001348
660.1	0.001290	0.203437	0.000262	0.001520
660.2	0.001435	0.203593	0.000292	0.001693
660.3	0.001581	0.203749	0.000322	0.001865
660.4	0.001726	0.203906	0.000352	0.002038
660.5	0.001871	0.204062	0.000382	0.002211
660.6	0.002016	0.204218	0.000412	0.002385
660.7	0.002161	0.204374	0.000442	0.002558
660.8	0.002307	0.204531	0.000472	0.002732
660.9	0.002452	0.204687	0.000502	0.002906
661.0	0.002597	0.204844	0.000532	0.003081
661.1	0.002742	0.205001	0.000562	0.003256
661.2	0.002887	0.205158	0.000592	0.003431
661.3	0.003032	0.205321	0.000623	0.003606
661.4	0.003177	0.205490	0.000653	0.003782
661.5	0.003323	0.205659	0.000683	0.003958
661.6	0.003468	0.205839	0.000714	0.004134
661.7	0.003613	0.206013	0.000744	0.004311
661.8	0.003758	0.206187	0.000775	0.004488
661.9	0.003903	0.206367	0.000805	0.004665
662.0	0.004048	0.206547	0.000836	0.004843
662.1	0.004194	0.207040	0.000868	0.005029
662.2	0.004339	0.207534	0.000900	0.005215
662.3	0.004484	0.208031	0.000933	0.005403
662.4	0.004629	0.208533	0.000965	0.005591
662.5	0.004774	0.209036	0.000998	0.005780
662.6	0.004919	0.209544	0.001031	0.005970
662.7	0.005065	0.210053	0.001064	0.006161
662.8	0.005210	0.210565	0.001097	0.006353
662.9	0.005355	0.211079	0.001130	0.006546
663.0	0.005500	0.211594	0.001164	0.006740

663.1	0.005645	0.212115	0.001197	0.006935
663.2	0.005790	0.212638	0.001231	0.007131
663.3	0.005935	0.213162	0.001265	0.007328
663.4	0.006081	0.213688	0.001299	0.007526
663.5	0.006226	0.214215	0.001334	0.007724
663.6	0.006371	0.214738	0.001368	0.007924
663.7	0.006516	0.215257	0.001403	0.008124
663.8	0.006661	0.215777	0.001437	0.008325
663.9	0.006807	0.216299	0.001472	0.008527
664.0	0.006952	0.216821	0.001507	0.008730
664.1	0.007097	0.217081	0.001541	0.008923
664.2	0.007242	0.217342	0.001574	0.009116
664.3	0.007387	0.217603	0.001607	0.009310
664.4	0.007532	0.217862	0.001641	0.009504
664.5	0.007677	0.218122	0.001675	0.009699
664.6	0.007823	0.218379	0.001708	0.009894
664.7	0.007968	0.218635	0.001742	0.010089
664.8	0.008113	0.218890	0.001776	0.010285
664.9	0.008258	0.219142	0.001810	0.010481
665.0	0.008403	0.219394	0.001844	0.010678
665.1	0.008548	0.219643	0.001878	0.010875
665.2	0.008693	0.219891	0.001912	0.011072
665.3	0.008839	0.220140	0.001946	0.011269
665.4	0.008984	0.220389	0.001980	0.011468
665.5	0.009129	0.220637	0.002014	0.011666
665.6	0.009274	0.220877	0.002048	0.011864
665.7	0.009419	0.221117	0.002083	0.012063
665.8	0.009565	0.221357	0.002117	0.012262
665.9	0.009710	0.221598	0.002152	0.012462
666.0	0.009855	0.221839	0.002186	0.012662
666.1	0.010000	0.222240	0.002222	0.012872
666.2	0.013574	0.222642	0.003022	0.017504
666.3	0.017000	0.223045	0.003792	0.021961
666.4	0.017129	0.223449	0.003827	0.022168
666.5	0.016100	0.223853	0.003604	0.020874
666.6	0.015661	0.224259	0.003512	0.020341
666.7	0.016100	0.224665	0.003617	0.020950
666.8	0.017264	0.225071	0.003886	0.022505
666.9	0.018700	0.225478	0.004216	0.024421
667.0	0.019871	0.225886	0.004489	0.025997
667.1	0.020200	0.226322	0.004572	0.026478
667.2	0.019289	0.226759	0.004374	0.025333
667.3	0.017500	0.227197	0.003976	0.023028

667.4	0.015522	0.227634	0.003533	0.020464
667.5	0.014600	0.228062	0.003330	0.019285
667.6	0.015685	0.228489	0.003584	0.020757
667.7	0.018000	0.228917	0.004121	0.023865
667.8	0.020712	0.229344	0.004750	0.027512
667.9	0.024500	0.229772	0.005629	0.032604
668.0	0.029742	0.230200	0.006847	0.039654
668.1	0.034100	0.230731	0.007868	0.045569
668.2	0.035446	0.231263	0.008197	0.047477
668.3	0.035200	0.231796	0.008159	0.047257
668.4	0.035226	0.232330	0.008184	0.047400
668.5	0.035600	0.232864	0.008290	0.048014
668.6	0.036439	0.233401	0.008505	0.049259
668.7	0.039800	0.233939	0.009311	0.053926
668.8	0.047044	0.234478	0.011031	0.063888
668.9	0.054800	0.235019	0.012879	0.074593
669.0	0.059497	0.235561	0.014015	0.081173
669.1	0.061500	0.236101	0.014520	0.084098
669.2	0.062094	0.236641	0.014694	0.085105
669.3	0.062300	0.237184	0.014777	0.085583
669.4	0.063115	0.237723	0.015004	0.086899
669.5	0.065700	0.238258	0.015654	0.090662
669.6	0.070657	0.238796	0.016873	0.097723
669.7	0.076200	0.239335	0.018237	0.105627
669.8	0.080407	0.239875	0.019288	0.111710
669.9	0.083200	0.240417	0.020003	0.115852
670.0	0.085016	0.240960	0.020485	0.118648
670.1	0.086500	0.241270	0.020870	0.120874
670.2	0.088253	0.241579	0.021320	0.123482
670.3	0.090500	0.241889	0.021891	0.126788
670.4	0.093447	0.242199	0.022633	0.131085
670.5	0.097600	0.242510	0.023669	0.137086
670.6	0.103460	0.242819	0.025122	0.145502
670.7	0.111200	0.243128	0.027036	0.156586
670.8	0.120750	0.243438	0.029395	0.170251
670.9	0.131300	0.243746	0.032004	0.185360
671.0	0.141770	0.244056	0.034600	0.200395
671.1	0.150600	0.244362	0.036801	0.213143
671.2	0.156670	0.244668	0.038332	0.222012
671.3	0.161100	0.244971	0.039465	0.228573
671.4	0.165470	0.245268	0.040584	0.235057
671.5	0.171000	0.245564	0.041991	0.243206
671.6	0.178480	0.245860	0.043881	0.254151

671.7	0.187400	0.246157	0.046130	0.267174
671.8	0.196970	0.246453	0.048544	0.281156
671.9	0.206600	0.246748	0.050978	0.295255
672.0	0.215890	0.247044	0.053334	0.308902
672.1	0.225000	0.247428	0.055671	0.322437
672.2	0.234270	0.247813	0.058055	0.336244
672.3	0.244300	0.248197	0.060635	0.351183
672.4	0.255490	0.248580	0.063510	0.367836
672.5	0.267100	0.248964	0.066498	0.385144
672.6	0.278300	0.249345	0.069393	0.401909
672.7	0.289100	0.249727	0.072196	0.418145
672.8	0.299610	0.250108	0.074935	0.434008
672.9	0.309700	0.250489	0.077576	0.449306
673.0	0.319390	0.250869	0.080125	0.464068
673.1	0.329700	0.251247	0.082836	0.479769
673.2	0.341480	0.251624	0.085925	0.497658
673.3	0.354000	0.251991	0.089205	0.516657
673.4	0.366260	0.252358	0.092429	0.535328
673.5	0.377900	0.252725	0.095505	0.553145
673.6	0.388730	0.253092	0.098384	0.569822
673.7	0.398600	0.253458	0.101028	0.585136
673.8	0.407580	0.253824	0.103454	0.599183
673.9	0.416600	0.254190	0.105896	0.613327
674.0	0.426510	0.254557	0.108571	0.628822
674.1	0.436900	0.254744	0.111298	0.644613
674.2	0.447150	0.254931	0.113992	0.660220
674.3	0.457000	0.255117	0.116588	0.675257
674.4	0.466250	0.255303	0.119035	0.689427
674.5	0.474600	0.255489	0.121255	0.702285
674.6	0.481880	0.255674	0.123204	0.713575
674.7	0.488600	0.255859	0.125013	0.724050
674.8	0.495410	0.256044	0.126847	0.734672
674.9	0.502900	0.256229	0.128857	0.746316
675.0	0.511370	0.256413	0.131122	0.759431
675.1	0.520000	0.256588	0.133426	0.772776
675.2	0.527800	0.256757	0.135516	0.784882
675.3	0.534200	0.256922	0.137248	0.794910
675.4	0.538920	0.257086	0.138549	0.802447
675.5	0.542500	0.257251	0.139558	0.808294
675.6	0.545690	0.257414	0.140468	0.813564
675.7	0.549400	0.257577	0.141513	0.819615
675.8	0.554310	0.257740	0.142868	0.827463
675.9	0.560100	0.257903	0.144451	0.836633

676.0	0.566110	0.258065	0.146093	0.846143
676.1	0.571200	0.258327	0.147556	0.854616
676.2	0.574540	0.258588	0.148569	0.860484
676.3	0.576900	0.258850	0.149330	0.864892
676.4	0.579280	0.259110	0.150098	0.869335
676.5	0.582100	0.259371	0.150980	0.874447
676.6	0.585590	0.259632	0.152038	0.880572
676.7	0.589800	0.259892	0.153284	0.887792
676.8	0.594470	0.260152	0.154653	0.895717
676.9	0.598300	0.260411	0.155804	0.902386
677.0	0.600070	0.260671	0.156421	0.905956
677.1	0.600000	0.260922	0.156553	0.906726
677.2	0.598720	0.261169	0.156367	0.905646
677.3	0.597100	0.261414	0.156090	0.904045
677.4	0.595910	0.261659	0.155925	0.903087
677.5	0.595400	0.261903	0.155937	0.903157
677.6	0.595550	0.262145	0.156121	0.904220
677.7	0.595700	0.262388	0.156304	0.905284
677.8	0.595250	0.262629	0.156330	0.905431
677.9	0.594400	0.262869	0.156249	0.904964
678.0	0.593620	0.263109	0.156187	0.904601
678.1	0.593600	0.263499	0.156413	0.905914
678.2	0.594840	0.263890	0.156972	0.909152
678.3	0.596700	0.264281	0.157696	0.913345
678.4	0.598310	0.264671	0.158355	0.917161
678.5	0.598900	0.265061	0.158745	0.919420
678.6	0.598050	0.265451	0.158753	0.919465
678.7	0.596600	0.265841	0.158601	0.918583
678.8	0.595490	0.266231	0.158538	0.918219
678.9	0.594900	0.266621	0.158613	0.918653
679.0	0.594800	0.267010	0.158818	0.919841
679.1	0.595100	0.267402	0.159131	0.921653
679.2	0.595730	0.267793	0.159532	0.923979
679.3	0.596700	0.268185	0.160026	0.926837
679.4	0.598000	0.268576	0.160609	0.930214
679.5	0.599500	0.268969	0.161247	0.933908
679.6	0.600860	0.269361	0.161848	0.937392
679.7	0.601000	0.269753	0.162122	0.938977
679.8	0.599180	0.270146	0.161866	0.937496
679.9	0.596700	0.270538	0.161430	0.934971
680.0	0.595040	0.270931	0.161215	0.933723
680.1	0.594300	0.271108	0.161120	0.933173
680.2	0.594200	0.271285	0.161198	0.933625

680.3	0.594400	0.271462	0.161357	0.934548
680.4	0.594530	0.271639	0.161497	0.935361
680.5	0.594100	0.271815	0.161486	0.935292
680.6	0.593020	0.271992	0.161297	0.934199
680.7	0.593000	0.272168	0.161396	0.934772
680.8	0.595530	0.272344	0.162189	0.939368
680.9	0.599500	0.272520	0.163376	0.946240
681.0	0.603340	0.272689	0.164524	0.952890
681.1	0.606300	0.272860	0.165435	0.958166
681.2	0.607940	0.273030	0.165986	0.961357
681.3	0.608300	0.273200	0.166188	0.962527
681.4	0.607790	0.273371	0.166152	0.962318
681.5	0.607900	0.273540	0.166285	0.963091
681.6	0.609940	0.273710	0.166947	0.966923
681.7	0.613400	0.273879	0.167997	0.973008
681.8	0.617360	0.274048	0.169186	0.979894
681.9	0.621000	0.274217	0.170289	0.986278
682.0	0.623690	0.274386	0.171132	0.991160
682.1	0.625500	0.274744	0.171852	0.995333
682.2	0.626610	0.275101	0.172381	0.998398
682.3	0.626800	0.275459	0.172658	1.000000
682.4	0.625920	0.275817	0.172640	0.999894
682.5	0.624300	0.276175	0.172416	0.998600
682.6	0.622370	0.276533	0.172106	0.996803
682.7	0.620400	0.276891	0.171783	0.994934
682.8	0.618480	0.277249	0.171473	0.993137
682.9	0.616200	0.277602	0.171059	0.990737
683.0	0.613030	0.277952	0.170393	0.986883
683.1	0.608400	0.278303	0.169319	0.980664
683.2	0.601920	0.278653	0.167727	0.971439
683.3	0.594000	0.279003	0.165728	0.959862
683.4	0.585210	0.279354	0.163480	0.946846
683.5	0.576000	0.279704	0.161110	0.933114
683.6	0.566590	0.280055	0.158676	0.919022
683.7	0.556400	0.280406	0.156018	0.903623
683.8	0.544930	0.280756	0.152993	0.886103
683.9	0.532700	0.281108	0.149746	0.867299
684.0	0.520230	0.281459	0.146423	0.848055
684.1	0.507000	0.281610	0.142776	0.826932
684.2	0.492480	0.281761	0.138762	0.803679
684.3	0.477000	0.281912	0.134472	0.778834
684.4	0.461070	0.282063	0.130051	0.753228
684.5	0.444900	0.282214	0.125557	0.727201

684.6	0.428690	0.282365	0.121047	0.701081
684.7	0.412900	0.282517	0.116651	0.675620
684.8	0.397780	0.282666	0.112439	0.651224
684.9	0.382500	0.282811	0.108175	0.626528
685.0	0.366250	0.282955	0.103632	0.600217
685.1	0.349300	0.283097	0.098886	0.572727
685.2	0.332080	0.283239	0.094058	0.544766
685.3	0.314600	0.283382	0.089152	0.516350
685.4	0.297060	0.283524	0.084224	0.487806
685.5	0.280700	0.283665	0.079625	0.461171
685.6	0.266680	0.283807	0.075686	0.438357
685.7	0.254700	0.283949	0.072322	0.418874
685.8	0.243890	0.284091	0.069287	0.401296
685.9	0.232700	0.284233	0.066141	0.383075
686.0	0.219760	0.284374	0.062494	0.361953
686.1	0.205200	0.284861	0.058453	0.338550
686.2	0.189780	0.285347	0.054153	0.313644
686.3	0.175200	0.285834	0.050078	0.290042
686.4	0.163150	0.286321	0.046713	0.270554
686.5	0.154300	0.286809	0.044255	0.256314
686.6	0.148550	0.287298	0.042678	0.247183
686.7	0.143900	0.287786	0.041412	0.239852
686.8	0.138300	0.288269	0.039868	0.230905
686.9	0.131600	0.288752	0.038000	0.220087
687.0	0.124130	0.289235	0.035903	0.207942
687.1	0.116400	0.289720	0.033723	0.195319
687.2	0.108920	0.290206	0.031609	0.183074
687.3	0.102100	0.290692	0.029680	0.171898
687.4	0.096126	0.291178	0.027990	0.162111
687.5	0.090300	0.291664	0.026337	0.152540
687.6	0.084006	0.292151	0.024542	0.142145
687.7	0.077800	0.292637	0.022767	0.131863
687.8	0.072338	0.293124	0.021204	0.122810
687.9	0.067500	0.293612	0.019819	0.114786
688.0	0.062931	0.294099	0.018508	0.107194
688.1	0.058100	0.294481	0.017109	0.099094
688.2	0.052650	0.294864	0.015525	0.089915
688.3	0.047100	0.295246	0.013906	0.080541
688.4	0.042208	0.295629	0.012478	0.072270
688.5	0.038800	0.296012	0.011485	0.066520
688.6	0.037306	0.296395	0.011057	0.064042
688.7	0.036500	0.296774	0.010832	0.062738
688.8	0.035079	0.297151	0.010424	0.060372

688.9	0.033100	0.297529	0.009848	0.057039
689.0	0.030877	0.297906	0.009198	0.053276
689.1	0.028400	0.298283	0.008471	0.049064
689.2	0.025752	0.298660	0.007691	0.044545
689.3	0.023700	0.299037	0.007087	0.041047
689.4	0.022928	0.299414	0.006865	0.039760
689.5	0.023100	0.299790	0.006925	0.040109
689.6	0.023785	0.300167	0.007139	0.041350
689.7	0.025200	0.300544	0.007574	0.043865
689.8	0.027320	0.300921	0.008221	0.047615
689.9	0.028500	0.301298	0.008587	0.049734
690.0	0.027247	0.301675	0.008220	0.047607
690.1	0.024300	0.301968	0.007338	0.042499
690.2	0.020880	0.302261	0.006311	0.036553
690.3	0.017900	0.302554	0.005416	0.031367
690.4	0.016046	0.302847	0.004859	0.028145
690.5	0.015400	0.303140	0.004668	0.027038
690.6	0.015735	0.303431	0.004774	0.027653
690.7	0.016200	0.303719	0.004920	0.028497
690.8	0.015989	0.304008	0.004861	0.028153
690.9	0.015100	0.304296	0.004595	0.026613
691.0	0.013591	0.304584	0.004140	0.023976
691.1	0.012400	0.304867	0.003780	0.021895
691.2	0.011959	0.305150	0.003649	0.021136
691.3	0.011551	0.305433	0.003528	0.020434
691.4	0.011175	0.305716	0.003416	0.019787
691.5	0.010832	0.305999	0.003315	0.019197
691.6	0.010522	0.306282	0.003223	0.018665
691.7	0.010245	0.306566	0.003141	0.018191
691.8	0.010000	0.306849	0.003068	0.017772
691.9	0.009804	0.307133	0.003011	0.017440
692.0	0.009609	0.307416	0.002954	0.017108
692.1	0.009413	0.307737	0.002897	0.016777
692.2	0.009217	0.308058	0.002839	0.016446
692.3	0.009022	0.308379	0.002782	0.016113
692.4	0.008826	0.308701	0.002725	0.015780
692.5	0.008630	0.309022	0.002667	0.015447
692.6	0.008435	0.309339	0.002609	0.015112
692.7	0.008239	0.309657	0.002551	0.014777
692.8	0.008044	0.309975	0.002493	0.014441
692.9	0.007848	0.310293	0.002435	0.014104
693.0	0.007652	0.310611	0.002377	0.013766
693.1	0.007456	0.310924	0.002318	0.013428

693.2	0.007261	0.311237	0.002260	0.013089
693.3	0.007065	0.311549	0.002201	0.012749
693.4	0.006870	0.311862	0.002142	0.012408
693.5	0.006674	0.312175	0.002083	0.012067
693.6	0.006478	0.312488	0.002024	0.011725
693.7	0.006283	0.312800	0.001965	0.011382
693.8	0.006087	0.313113	0.001906	0.011039
693.9	0.005891	0.313426	0.001846	0.010694
694.0	0.005696	0.313739	0.001787	0.010350
694.1	0.005500	0.314003	0.001727	0.010003
694.2	0.005304	0.314267	0.001667	0.009655
694.3	0.005109	0.314531	0.001607	0.009307
694.4	0.004913	0.314795	0.001547	0.008958
694.5	0.004717	0.315056	0.001486	0.008608
694.6	0.004522	0.315317	0.001426	0.008258
694.7	0.004326	0.315579	0.001365	0.007907
694.8	0.004130	0.315840	0.001305	0.007556
694.9	0.003935	0.316101	0.001244	0.007204
695.0	0.003739	0.316362	0.001183	0.006851
695.1	0.003544	0.316622	0.001122	0.006498
695.2	0.003348	0.316883	0.001061	0.006144
695.3	0.003152	0.317143	0.001000	0.005790
695.4	0.002956	0.317403	0.000938	0.005435
695.5	0.002761	0.317664	0.000877	0.005080
695.6	0.002565	0.317924	0.000816	0.004723
695.7	0.002370	0.318185	0.000754	0.004367
695.8	0.002174	0.318445	0.000692	0.004009
695.9	0.001978	0.318706	0.000630	0.003652
696.0	0.001783	0.318966	0.000569	0.003293
696.1	0.001587	0.319049	0.000506	0.002933
696.2	0.001391	0.319131	0.000444	0.002572
696.3	0.001272	0.319213	0.000406	0.002351
696.4	0.001000	0.319294	0.000319	0.001849
696.5	0.000576	0.319374	0.000184	0.001066
696.6	0.000000	0.319454	0.000000	0.000000
Channel 3				
Wavenumber	HIRS Filter Transmittance	Optical Element Transmittance	Product of the HIRS Filter and Optical Element Transmittances	Normalized Value of Column 4
667.5	0.000000	0.228062	0.000000	0.000000
667.6	0.000445	0.228489	0.000102	0.000524
667.7	0.000802	0.228917	0.000184	0.000946

667.8	0.001071	0.229344	0.000246	0.001266
667.9	0.001252	0.229772	0.000288	0.001482
668.0	0.001345	0.230200	0.000310	0.001595
668.1	0.001495	0.230731	0.000345	0.001777
668.2	0.001645	0.231263	0.000380	0.001959
668.3	0.001795	0.231796	0.000416	0.002143
668.4	0.001945	0.232330	0.000452	0.002327
668.5	0.002095	0.232864	0.000488	0.002513
668.6	0.002245	0.233401	0.000524	0.002699
668.7	0.002395	0.233939	0.000560	0.002886
668.8	0.002545	0.234478	0.000597	0.003074
668.9	0.002695	0.235019	0.000633	0.003262
669.0	0.002845	0.235561	0.000670	0.003452
669.1	0.002995	0.236101	0.000707	0.003642
669.2	0.003145	0.236641	0.000744	0.003833
669.3	0.003295	0.237184	0.000782	0.004025
669.4	0.003445	0.237723	0.000819	0.004218
669.5	0.003595	0.238258	0.000857	0.004412
669.6	0.003745	0.238796	0.000894	0.004606
669.7	0.003895	0.239335	0.000932	0.004802
669.8	0.004045	0.239875	0.000970	0.004998
669.9	0.004195	0.240417	0.001009	0.005195
670.0	0.004345	0.240960	0.001047	0.005393
670.1	0.004495	0.241270	0.001085	0.005586
670.2	0.004645	0.241579	0.001122	0.005780
670.3	0.004795	0.241889	0.001160	0.005974
670.4	0.004945	0.242199	0.001198	0.006169
670.5	0.005095	0.242510	0.001236	0.006364
670.6	0.005245	0.242819	0.001274	0.006560
670.7	0.005395	0.243128	0.001312	0.006756
670.8	0.005545	0.243438	0.001350	0.006953
670.9	0.005695	0.243746	0.001388	0.007150
671.0	0.005845	0.244056	0.001427	0.007347
671.1	0.005995	0.244362	0.001465	0.007545
671.2	0.006145	0.244668	0.001503	0.007744
671.3	0.006295	0.244971	0.001542	0.007943
671.4	0.006445	0.245268	0.001581	0.008142
671.5	0.006595	0.245564	0.001619	0.008341
671.6	0.006745	0.245860	0.001658	0.008541
671.7	0.006895	0.246157	0.001697	0.008742
671.8	0.007045	0.246453	0.001736	0.008943
671.9	0.007195	0.246748	0.001775	0.009144
672.0	0.007345	0.247044	0.001815	0.009346

672.1	0.007495	0.247428	0.001854	0.009552
672.2	0.007645	0.247813	0.001895	0.009758
672.3	0.007795	0.248197	0.001935	0.009965
672.4	0.007945	0.248580	0.001975	0.010172
672.5	0.008095	0.248964	0.002015	0.010380
672.6	0.008245	0.249345	0.002056	0.010589
672.7	0.008395	0.249727	0.002096	0.010798
672.8	0.008545	0.250108	0.002137	0.011008
672.9	0.008695	0.250489	0.002178	0.011218
673.0	0.008845	0.250869	0.002219	0.011429
673.1	0.008995	0.251247	0.002260	0.011640
673.2	0.009145	0.251624	0.002301	0.011852
673.3	0.009295	0.251991	0.002342	0.012064
673.4	0.009445	0.252358	0.002384	0.012277
673.5	0.009595	0.252725	0.002425	0.012490
673.6	0.009745	0.253092	0.002466	0.012703
673.7	0.009895	0.253458	0.002508	0.012918
673.8	0.010221	0.253824	0.002594	0.013363
673.9	0.010924	0.254190	0.002777	0.014302
674.0	0.011575	0.254557	0.002946	0.015176
674.1	0.012174	0.254744	0.003101	0.015974
674.2	0.012722	0.254931	0.003243	0.016705
674.3	0.013218	0.255117	0.003372	0.017369
674.4	0.013663	0.255303	0.003488	0.017967
674.5	0.014056	0.255489	0.003591	0.018497
674.6	0.014397	0.255674	0.003681	0.018959
674.7	0.015091	0.255859	0.003861	0.019888
674.8	0.015787	0.256044	0.004042	0.020820
674.9	0.016526	0.256229	0.004234	0.021810
675.0	0.017280	0.256413	0.004431	0.022822
675.1	0.018018	0.256588	0.004623	0.023813
675.2	0.018734	0.256757	0.004810	0.024775
675.3	0.019457	0.256922	0.004999	0.025748
675.4	0.020220	0.257086	0.005198	0.026775
675.5	0.021055	0.257251	0.005416	0.027898
675.6	0.021995	0.257414	0.005662	0.029162
675.7	0.023060	0.257577	0.005940	0.030594
675.8	0.024245	0.257740	0.006249	0.032186
675.9	0.025545	0.257903	0.006588	0.033933
676.0	0.026953	0.258065	0.006956	0.035826
676.1	0.028464	0.258327	0.007353	0.037873
676.2	0.030073	0.258588	0.007777	0.040054
676.3	0.031781	0.258850	0.008227	0.042372

676.4	0.033590	0.259110	0.008704	0.044829
676.5	0.035501	0.259371	0.009208	0.047427
676.6	0.037515	0.259632	0.009740	0.050168
676.7	0.039622	0.259892	0.010297	0.053039
676.8	0.041798	0.260152	0.010874	0.056007
676.9	0.044015	0.260411	0.011462	0.059037
677.0	0.046245	0.260671	0.012055	0.062090
677.1	0.048462	0.260922	0.012645	0.065129
677.2	0.050652	0.261169	0.013229	0.068137
677.3	0.052825	0.261414	0.013809	0.071127
677.4	0.054992	0.261659	0.014389	0.074114
677.5	0.057167	0.261903	0.014972	0.077117
677.6	0.059361	0.262145	0.015561	0.080151
677.7	0.061595	0.262388	0.016162	0.083244
677.8	0.063904	0.262629	0.016783	0.086444
677.9	0.066325	0.262869	0.017435	0.089801
678.0	0.068894	0.263109	0.018127	0.093364
678.1	0.071648	0.263499	0.018879	0.097240
678.2	0.074607	0.263890	0.019688	0.101407
678.3	0.077763	0.264281	0.020551	0.105853
678.4	0.081109	0.264671	0.021467	0.110570
678.5	0.084632	0.265061	0.022433	0.115543
678.6	0.088325	0.265451	0.023446	0.120762
678.7	0.092167	0.265841	0.024502	0.126200
678.8	0.096124	0.266231	0.025591	0.131812
678.9	0.100160	0.266621	0.026705	0.137547
679.0	0.104240	0.267010	0.027833	0.143359
679.1	0.108320	0.267402	0.028965	0.149189
679.2	0.112390	0.267793	0.030097	0.155021
679.3	0.116430	0.268185	0.031225	0.160828
679.4	0.120450	0.268576	0.032350	0.166624
679.5	0.124430	0.268969	0.033468	0.172381
679.6	0.128380	0.269361	0.034581	0.178113
679.7	0.132310	0.269753	0.035691	0.183833
679.8	0.136280	0.270146	0.036815	0.189624
679.9	0.140330	0.270538	0.037965	0.195543
680.0	0.144540	0.270931	0.039160	0.201702
680.1	0.148950	0.271108	0.040382	0.207992
680.2	0.153600	0.271285	0.041669	0.214625
680.3	0.158500	0.271462	0.043027	0.221617
680.4	0.163650	0.271639	0.044454	0.228966
680.5	0.169060	0.271815	0.045953	0.236689
680.6	0.174730	0.271992	0.047525	0.244786

680.7	0.180650	0.272168	0.049167	0.253244
680.8	0.186780	0.272344	0.050868	0.262007
680.9	0.193070	0.272520	0.052615	0.271005
681.0	0.199470	0.272689	0.054393	0.280161
681.1	0.205950	0.272860	0.056195	0.289444
681.2	0.212450	0.273030	0.058005	0.298766
681.3	0.218940	0.273200	0.059815	0.308085
681.4	0.225380	0.273371	0.061612	0.317344
681.5	0.231730	0.273540	0.063388	0.326488
681.6	0.237950	0.273710	0.065129	0.335460
681.7	0.244030	0.273879	0.066835	0.344243
681.8	0.250000	0.274048	0.068512	0.352883
681.9	0.255890	0.274217	0.070169	0.361419
682.0	0.261730	0.274386	0.071815	0.369895
682.1	0.267550	0.274744	0.073508	0.378613
682.2	0.273360	0.275101	0.075202	0.387339
682.3	0.279180	0.275459	0.076903	0.396100
682.4	0.284980	0.275817	0.078602	0.404855
682.5	0.290760	0.276175	0.080301	0.413602
682.6	0.296530	0.276533	0.082000	0.422357
682.7	0.302250	0.276891	0.083690	0.431061
682.8	0.307940	0.277249	0.085376	0.439744
682.9	0.313570	0.277602	0.087048	0.448354
683.0	0.319140	0.277952	0.088706	0.456894
683.1	0.324640	0.278303	0.090348	0.465353
683.2	0.330060	0.278653	0.091972	0.473718
683.3	0.335390	0.279003	0.093575	0.481973
683.4	0.340650	0.279354	0.095162	0.490147
683.5	0.345820	0.279704	0.096727	0.498210
683.6	0.350920	0.280055	0.098277	0.506191
683.7	0.355930	0.280406	0.099805	0.514061
683.8	0.360850	0.280756	0.101311	0.521819
683.9	0.365650	0.281108	0.102787	0.529422
684.0	0.370320	0.281459	0.104230	0.536854
684.1	0.374840	0.281610	0.105559	0.543698
684.2	0.379210	0.281761	0.106847	0.550331
684.3	0.383390	0.281912	0.108082	0.556695
684.4	0.387390	0.282063	0.109268	0.562805
684.5	0.391180	0.282214	0.110396	0.568615
684.6	0.394750	0.282365	0.111464	0.574113
684.7	0.398080	0.282517	0.112464	0.579266
684.8	0.401200	0.282666	0.113406	0.584115
684.9	0.404110	0.282811	0.114287	0.588652

685.0	0.406820	0.282955	0.115112	0.592902
685.1	0.409340	0.283097	0.115883	0.596875
685.2	0.411680	0.283239	0.116604	0.600588
685.3	0.413850	0.283382	0.117278	0.604057
685.4	0.415860	0.283524	0.117906	0.607295
685.5	0.417700	0.283665	0.118487	0.610287
685.6	0.419390	0.283807	0.119026	0.613063
685.7	0.420940	0.283949	0.119526	0.615637
685.8	0.422400	0.284091	0.120000	0.618081
685.9	0.423780	0.284233	0.120452	0.620409
686.0	0.425140	0.284374	0.120899	0.622710
686.1	0.426510	0.284861	0.121496	0.625785
686.2	0.427920	0.285347	0.122106	0.628926
686.3	0.429370	0.285834	0.122729	0.632134
686.4	0.430860	0.286321	0.123364	0.635409
686.5	0.432400	0.286809	0.124016	0.638766
686.6	0.433980	0.287298	0.124681	0.642192
686.7	0.435600	0.287786	0.125360	0.645685
686.8	0.437240	0.288269	0.126043	0.649203
686.9	0.438860	0.288752	0.126722	0.652701
687.0	0.440440	0.289235	0.127391	0.656147
687.1	0.441940	0.289720	0.128039	0.659486
687.2	0.443330	0.290206	0.128657	0.662669
687.3	0.444570	0.290692	0.129233	0.665635
687.4	0.445620	0.291178	0.129755	0.668322
687.5	0.446410	0.291664	0.130202	0.670625
687.6	0.446920	0.292151	0.130568	0.672512
687.7	0.447120	0.292637	0.130844	0.673934
687.8	0.447060	0.293124	0.131044	0.674965
687.9	0.446770	0.293612	0.131177	0.675648
688.0	0.446310	0.294099	0.131259	0.676073
688.1	0.445710	0.294481	0.131253	0.676042
688.2	0.445040	0.294864	0.131226	0.675902
688.3	0.444400	0.295246	0.131208	0.675806
688.4	0.443910	0.295629	0.131233	0.675936
688.5	0.443660	0.296012	0.131329	0.676430
688.6	0.443780	0.296395	0.131534	0.677488
688.7	0.444310	0.296774	0.131860	0.679165
688.8	0.445210	0.297151	0.132295	0.681406
688.9	0.446450	0.297529	0.132832	0.684172
689.0	0.447980	0.297906	0.133456	0.687388
689.1	0.449760	0.298283	0.134156	0.690992
689.2	0.451710	0.298660	0.134908	0.694864

689.3	0.453760	0.299037	0.135691	0.698899
689.4	0.455780	0.299414	0.136467	0.702895
689.5	0.457690	0.299790	0.137211	0.706729
689.6	0.459380	0.300167	0.137891	0.710230
689.7	0.460800	0.300544	0.138491	0.713320
689.8	0.462020	0.300921	0.139032	0.716105
689.9	0.463080	0.301298	0.139525	0.718646
690.0	0.464050	0.301675	0.139992	0.721052
690.1	0.464980	0.301968	0.140409	0.723200
690.2	0.465960	0.302261	0.140842	0.725428
690.3	0.467080	0.302554	0.141317	0.727877
690.4	0.468460	0.302847	0.141872	0.730735
690.5	0.470210	0.303140	0.142540	0.734174
690.6	0.472420	0.303431	0.143347	0.738333
690.7	0.475150	0.303719	0.144312	0.743305
690.8	0.478340	0.304008	0.145419	0.749005
690.9	0.481940	0.304296	0.146652	0.755357
691.0	0.485870	0.304584	0.147988	0.762237
691.1	0.490090	0.304867	0.149412	0.769572
691.2	0.494530	0.305150	0.150906	0.777265
691.3	0.499140	0.305433	0.152454	0.785239
691.4	0.503860	0.305716	0.154038	0.793399
691.5	0.508640	0.305999	0.155643	0.801667
691.6	0.513440	0.306282	0.157258	0.809982
691.7	0.518210	0.306566	0.158865	0.818262
691.8	0.523000	0.306849	0.160482	0.826589
691.9	0.527820	0.307133	0.162111	0.834978
692.0	0.532720	0.307416	0.163767	0.843507
692.1	0.537710	0.307737	0.165473	0.852297
692.2	0.542800	0.308058	0.167214	0.861263
692.3	0.547950	0.308379	0.168976	0.870341
692.4	0.553120	0.308701	0.170749	0.879469
692.5	0.558250	0.309022	0.172511	0.888548
692.6	0.563310	0.309339	0.174254	0.897524
692.7	0.568250	0.309657	0.175963	0.906325
692.8	0.573050	0.309975	0.177631	0.914918
692.9	0.577700	0.310293	0.179256	0.923288
693.0	0.582180	0.310611	0.180831	0.931402
693.1	0.586460	0.310924	0.182344	0.939195
693.2	0.590540	0.311237	0.183798	0.946680
693.3	0.594400	0.311549	0.185185	0.953826
693.4	0.598040	0.311862	0.186506	0.960631
693.5	0.601450	0.312175	0.187758	0.967076

693.6	0.604630	0.312488	0.188939	0.973163
693.7	0.607540	0.312800	0.190039	0.978826
693.8	0.610150	0.313113	0.191046	0.984014
693.9	0.612400	0.313426	0.191942	0.988630
694.0	0.614260	0.313739	0.192717	0.992623
694.1	0.615670	0.314003	0.193322	0.995738
694.2	0.616590	0.314267	0.193774	0.998064
694.3	0.616970	0.314531	0.194056	0.999518
694.4	0.616750	0.314795	0.194150	1.000000
694.5	0.615900	0.315056	0.194043	0.999452
694.6	0.614360	0.315317	0.193718	0.997779
694.7	0.612100	0.315579	0.193166	0.994932
694.8	0.609080	0.315840	0.192372	0.990842
694.9	0.605290	0.316101	0.191333	0.985491
695.0	0.600700	0.316362	0.190039	0.978825
695.1	0.595290	0.316622	0.188482	0.970808
695.2	0.589050	0.316883	0.186660	0.961422
695.3	0.582010	0.317143	0.184580	0.950712
695.4	0.574210	0.317403	0.182256	0.938740
695.5	0.565690	0.317664	0.179699	0.925570
695.6	0.556460	0.317924	0.176912	0.911215
695.7	0.546580	0.318185	0.173913	0.895770
695.8	0.536090	0.318445	0.170715	0.879297
695.9	0.525040	0.318706	0.167333	0.861877
696.0	0.513470	0.318966	0.163779	0.843573
696.1	0.501450	0.319049	0.159987	0.824039
696.2	0.489010	0.319131	0.156058	0.803804
696.3	0.476240	0.319213	0.152022	0.783015
696.4	0.463190	0.319294	0.147894	0.761752
696.5	0.449950	0.319374	0.143703	0.740164
696.6	0.436580	0.319454	0.139467	0.718349
696.7	0.423120	0.319534	0.135201	0.696376
696.8	0.409600	0.319613	0.130913	0.674292
696.9	0.396010	0.319692	0.126601	0.652081
697.0	0.382370	0.319771	0.122271	0.629777
697.1	0.368690	0.319855	0.117927	0.607404
697.2	0.354980	0.319938	0.113572	0.584969
697.3	0.341290	0.320021	0.109220	0.562555
697.4	0.327650	0.320104	0.104882	0.540212
697.5	0.314100	0.320187	0.100571	0.518006
697.6	0.300690	0.320269	0.096302	0.496019
697.7	0.287450	0.320352	0.092085	0.474300
697.8	0.274420	0.320435	0.087934	0.452917

697.9	0.261620	0.320517	0.083854	0.431903
698.0	0.249090	0.320600	0.079858	0.411323
698.1	0.236870	0.320828	0.075995	0.391423
698.2	0.224970	0.321057	0.072228	0.372023
698.3	0.213440	0.321284	0.068575	0.353207
698.4	0.202310	0.321512	0.065045	0.335025
698.5	0.191620	0.321739	0.061652	0.317547
698.6	0.181380	0.321966	0.058398	0.300790
698.7	0.171630	0.322194	0.055298	0.284822
698.8	0.162360	0.322421	0.052348	0.269628
698.9	0.153560	0.322648	0.049546	0.255194
699.0	0.145240	0.322875	0.046894	0.241538
699.1	0.137390	0.323105	0.044391	0.228645
699.2	0.130000	0.323335	0.042034	0.216501
699.3	0.123020	0.323564	0.039805	0.205021
699.4	0.116430	0.323793	0.037699	0.194176
699.5	0.110190	0.324022	0.035704	0.183899
699.6	0.104250	0.324251	0.033803	0.174109
699.7	0.098592	0.324480	0.031991	0.164775
699.8	0.093182	0.324708	0.030257	0.155843
699.9	0.087993	0.324936	0.028592	0.147268
700.0	0.082997	0.325163	0.026988	0.139004
700.1	0.078167	0.325451	0.025440	0.131031
700.2	0.073495	0.325739	0.023940	0.123308
700.3	0.069011	0.326026	0.022499	0.115887
700.4	0.064748	0.326313	0.021128	0.108824
700.5	0.060739	0.326600	0.019837	0.102176
700.6	0.057015	0.326887	0.018637	0.095995
700.7	0.053590	0.327173	0.017533	0.090308
700.8	0.050446	0.327458	0.016519	0.085084
700.9	0.047563	0.327744	0.015588	0.080291
701.0	0.044919	0.328029	0.014735	0.075894
701.1	0.042494	0.328311	0.013951	0.071858
701.2	0.040265	0.328594	0.013231	0.068148
701.3	0.038206	0.328876	0.012565	0.064718
701.4	0.036293	0.329158	0.011946	0.061531
701.5	0.034498	0.329440	0.011365	0.058537
701.6	0.032798	0.329721	0.010814	0.055700
701.7	0.031177	0.330001	0.010288	0.052992
701.8	0.029636	0.330281	0.009788	0.050416
701.9	0.028178	0.330561	0.009315	0.047976
702.0	0.026807	0.330841	0.008869	0.045680
702.1	0.025525	0.330961	0.008448	0.043512

702.2	0.024333	0.331082	0.008056	0.041495
702.3	0.023225	0.331203	0.007692	0.039620
702.4	0.022194	0.331324	0.007353	0.037875
702.5	0.021234	0.331444	0.007038	0.036250
702.6	0.020337	0.331564	0.006743	0.034731
702.7	0.019501	0.331683	0.006468	0.033315
702.8	0.018722	0.331802	0.006212	0.031996
702.9	0.018000	0.331921	0.005975	0.030773
703.0	0.017334	0.332040	0.005756	0.029645
703.1	0.016722	0.332157	0.005554	0.028609
703.2	0.016160	0.332274	0.005370	0.027657
703.3	0.015635	0.332391	0.005197	0.026768
703.4	0.015134	0.332508	0.005032	0.025919
703.5	0.014643	0.332625	0.004871	0.025087
703.6	0.014152	0.332741	0.004709	0.024254
703.7	0.013651	0.332857	0.004544	0.023404
703.8	0.013146	0.332972	0.004377	0.022546
703.9	0.012642	0.333088	0.004211	0.021689
704.0	0.012143	0.333204	0.004046	0.020840
704.1	0.011655	0.333391	0.003886	0.020014
704.2	0.011181	0.333579	0.003730	0.019211
704.3	0.010725	0.333767	0.003580	0.018438
704.4	0.010291	0.333955	0.003437	0.017701
704.5	0.009961	0.334143	0.003328	0.017143
704.6	0.009830	0.334332	0.003287	0.016928
704.7	0.009700	0.334520	0.003245	0.016713
704.8	0.009570	0.334707	0.003203	0.016498
704.9	0.009439	0.334895	0.003161	0.016282
705.0	0.009309	0.335083	0.003119	0.016066
705.1	0.009178	0.335270	0.003077	0.015850
705.2	0.009048	0.335457	0.003035	0.015633
705.3	0.008917	0.335643	0.002993	0.015416
705.4	0.008787	0.335830	0.002951	0.015199
705.5	0.008656	0.336016	0.002909	0.014982
705.6	0.008526	0.336202	0.002866	0.014764
705.7	0.008396	0.336387	0.002824	0.014547
705.8	0.008265	0.336573	0.002782	0.014328
705.9	0.008135	0.336758	0.002739	0.014110
706.0	0.008004	0.336943	0.002697	0.013891
706.1	0.007874	0.337074	0.002654	0.013670
706.2	0.007744	0.337204	0.002611	0.013449
706.3	0.007613	0.337334	0.002568	0.013228
706.4	0.007483	0.337463	0.002525	0.013006

706.5	0.007352	0.337593	0.002482	0.012784
706.6	0.007222	0.337722	0.002439	0.012562
706.7	0.007091	0.337850	0.002396	0.012340
706.8	0.006961	0.337979	0.002353	0.012118
706.9	0.006830	0.338108	0.002309	0.011895
707.0	0.006700	0.338237	0.002266	0.011672
707.1	0.006570	0.338363	0.002223	0.011449
707.2	0.006439	0.338489	0.002180	0.011226
707.3	0.006309	0.338615	0.002136	0.011003
707.4	0.006178	0.338741	0.002093	0.010780
707.5	0.006048	0.338866	0.002049	0.010556
707.6	0.005917	0.338992	0.002006	0.010332
707.7	0.005787	0.339118	0.001962	0.010108
707.8	0.005657	0.339244	0.001919	0.009884
707.9	0.005526	0.339370	0.001875	0.009660
708.0	0.005396	0.339500	0.001832	0.009435
708.1	0.005265	0.339548	0.001788	0.009208
708.2	0.005135	0.339597	0.001744	0.008982
708.3	0.005004	0.339645	0.001700	0.008755
708.4	0.004874	0.339693	0.001656	0.008528
708.5	0.004744	0.339741	0.001612	0.008301
708.6	0.004613	0.339789	0.001567	0.008073
708.7	0.004483	0.339838	0.001523	0.007846
708.8	0.004352	0.339886	0.001479	0.007619
708.9	0.004222	0.339934	0.001435	0.007392
709.0	0.004091	0.339983	0.001391	0.007164
709.1	0.003961	0.340026	0.001347	0.006937
709.2	0.003830	0.340068	0.001303	0.006709
709.3	0.003700	0.340111	0.001258	0.006482
709.4	0.003570	0.340154	0.001214	0.006254
709.5	0.003439	0.340197	0.001170	0.006026
709.6	0.003309	0.340240	0.001126	0.005798
709.7	0.003178	0.340283	0.001082	0.005571
709.8	0.003048	0.340326	0.001037	0.005343
709.9	0.002917	0.340372	0.000993	0.005115
710.0	0.002787	0.340420	0.000949	0.004887
710.1	0.002657	0.340578	0.000905	0.004660
710.2	0.002526	0.340737	0.000861	0.004433
710.3	0.002396	0.340895	0.000817	0.004206
710.4	0.002265	0.341053	0.000773	0.003979
710.5	0.002135	0.341212	0.000728	0.003752
710.6	0.002004	0.341370	0.000684	0.003524
710.7	0.001874	0.341529	0.000640	0.003296

710.8	0.001744	0.341687	0.000596	0.003068
710.9	0.001613	0.341846	0.000551	0.002840
711.0	0.001483	0.342004	0.000507	0.002612
711.1	0.001352	0.342158	0.000463	0.002383
711.2	0.001269	0.342312	0.000434	0.002237
711.3	0.001175	0.342466	0.000403	0.002073
711.4	0.000897	0.342621	0.000307	0.001583
711.5	0.000434	0.342775	0.000149	0.000766
711.6	0.000000	0.342929	0.000000	0.000000
Channel 4				
Wavenumber	HIRS Filter Transmittance	Optical Element Transmittance	Product of the HIRS Filter and Optical Element Transmittances	Normalized Value of Column 4
681.3	0.000000	0.273200	0.000000	0.000000
681.4	0.000102	0.273371	0.000028	0.000110
681.5	0.000327	0.273540	0.000090	0.000354
681.6	0.000608	0.273710	0.000166	0.000657
681.7	0.000930	0.273879	0.000255	0.001006
681.8	0.001282	0.274048	0.000351	0.001387
681.9	0.001650	0.274217	0.000453	0.001787
682.0	0.002023	0.274386	0.000555	0.002192
682.1	0.002388	0.274744	0.000656	0.002591
682.2	0.002737	0.275101	0.000753	0.002974
682.3	0.003063	0.275459	0.000844	0.003332
682.4	0.003358	0.275817	0.000926	0.003658
682.5	0.003615	0.276175	0.000999	0.003944
682.6	0.003827	0.276533	0.001058	0.004180
682.7	0.003986	0.276891	0.001104	0.004359
682.8	0.004085	0.277249	0.001133	0.004473
682.9	0.004117	0.277602	0.001143	0.004513
683.0	0.004073	0.277952	0.001132	0.004471
683.1	0.003951	0.278303	0.001100	0.004343
683.2	0.003765	0.278653	0.001049	0.004144
683.3	0.003532	0.279003	0.000985	0.003892
683.4	0.003269	0.279354	0.000913	0.003607
683.5	0.002995	0.279704	0.000838	0.003308
683.6	0.002726	0.280055	0.000763	0.003015
683.7	0.002481	0.280406	0.000696	0.002748
683.8	0.002277	0.280756	0.000639	0.002525
683.9	0.002132	0.281108	0.000599	0.002368
684.0	0.002064	0.281459	0.000581	0.002294
684.1	0.002085	0.281610	0.000587	0.002319

684.2	0.002191	0.281761	0.000617	0.002438
684.3	0.002373	0.281912	0.000669	0.002642
684.4	0.002621	0.282063	0.000739	0.002920
684.5	0.002927	0.282214	0.000826	0.003263
684.6	0.003281	0.282365	0.000926	0.003659
684.7	0.003674	0.282517	0.001038	0.004100
684.8	0.004097	0.282666	0.001158	0.004574
684.9	0.004540	0.282811	0.001284	0.005071
685.0	0.004995	0.282955	0.001413	0.005582
685.1	0.005452	0.283097	0.001543	0.006096
685.2	0.005900	0.283239	0.001671	0.006601
685.3	0.006330	0.283382	0.001794	0.007085
685.4	0.006730	0.283524	0.001908	0.007536
685.5	0.007089	0.283665	0.002011	0.007943
685.6	0.007398	0.283807	0.002100	0.008293
685.7	0.007645	0.283949	0.002171	0.008574
685.8	0.007820	0.284091	0.002222	0.008774
685.9	0.007912	0.284233	0.002249	0.008882
686.0	0.007911	0.284374	0.002250	0.008885
686.1	0.007810	0.284861	0.002225	0.008787
686.2	0.007621	0.285347	0.002175	0.008588
686.3	0.007358	0.285834	0.002103	0.008307
686.4	0.007039	0.286321	0.002015	0.007960
686.5	0.006677	0.286809	0.001915	0.007564
686.6	0.006290	0.287298	0.001807	0.007137
686.7	0.005892	0.287786	0.001696	0.006697
686.8	0.005499	0.288269	0.001585	0.006261
686.9	0.005127	0.288752	0.001480	0.005847
687.0	0.004791	0.289235	0.001386	0.005473
687.1	0.004508	0.289720	0.001306	0.005158
687.2	0.004298	0.290206	0.001247	0.004926
687.3	0.004183	0.290692	0.001216	0.004802
687.4	0.004184	0.291178	0.001218	0.004811
687.5	0.004322	0.291664	0.001260	0.004978
687.6	0.004619	0.292151	0.001349	0.005329
687.7	0.005095	0.292637	0.001491	0.005889
687.8	0.005774	0.293124	0.001692	0.006684
687.9	0.006675	0.293612	0.001960	0.007740
688.0	0.007820	0.294099	0.002300	0.009083
688.1	0.009216	0.294481	0.002714	0.010719
688.2	0.010813	0.294864	0.003188	0.012593
688.3	0.012544	0.295246	0.003704	0.014628
688.4	0.014345	0.295629	0.004241	0.016749

688.5	0.016151	0.296012	0.004781	0.018882
688.6	0.017895	0.296395	0.005304	0.020948
688.7	0.019513	0.296774	0.005791	0.022872
688.8	0.020939	0.297151	0.006222	0.024574
688.9	0.022108	0.297529	0.006578	0.025979
689.0	0.022955	0.297906	0.006838	0.027009
689.1	0.023438	0.298283	0.006991	0.027612
689.2	0.023611	0.298660	0.007052	0.027851
689.3	0.023552	0.299037	0.007043	0.027816
689.4	0.023339	0.299414	0.006988	0.027600
689.5	0.023050	0.299790	0.006910	0.027292
689.6	0.022762	0.300167	0.006832	0.026985
689.7	0.022553	0.300544	0.006778	0.026771
689.8	0.022501	0.300921	0.006771	0.026743
689.9	0.022684	0.301298	0.006835	0.026994
690.0	0.023180	0.301675	0.006993	0.027619
690.1	0.024047	0.301968	0.007261	0.028679
690.2	0.025265	0.302261	0.007637	0.030161
690.3	0.026795	0.302554	0.008107	0.032019
690.4	0.028599	0.302847	0.008661	0.034208
690.5	0.030636	0.303140	0.009287	0.036680
690.6	0.032867	0.303431	0.009973	0.039389
690.7	0.035254	0.303719	0.010707	0.042289
690.8	0.037758	0.304008	0.011479	0.045336
690.9	0.040338	0.304296	0.012275	0.048480
691.0	0.042956	0.304584	0.013084	0.051675
691.1	0.045583	0.304867	0.013897	0.054886
691.2	0.048231	0.305150	0.014718	0.058128
691.3	0.050923	0.305433	0.015554	0.061430
691.4	0.053680	0.305716	0.016411	0.064816
691.5	0.056525	0.305999	0.017297	0.068314
691.6	0.059482	0.306282	0.018218	0.071954
691.7	0.062571	0.306566	0.019182	0.075761
691.8	0.065816	0.306849	0.020196	0.079764
691.9	0.069238	0.307133	0.021265	0.083988
692.0	0.072861	0.307416	0.022399	0.088465
692.1	0.076706	0.307737	0.023605	0.093231
692.2	0.080789	0.308058	0.024888	0.098296
692.3	0.085130	0.308379	0.026252	0.103685
692.4	0.089743	0.308701	0.027704	0.109418
692.5	0.094646	0.309022	0.029248	0.115516
692.6	0.099855	0.309339	0.030889	0.121998
692.7	0.105390	0.309657	0.032635	0.128893

692.8	0.111260	0.309975	0.034488	0.136212
692.9	0.117490	0.310293	0.036456	0.143987
693.0	0.124090	0.310611	0.038544	0.152231
693.1	0.131080	0.310924	0.040756	0.160968
693.2	0.138460	0.311237	0.043094	0.170202
693.3	0.146220	0.311549	0.045555	0.179921
693.4	0.154360	0.311862	0.048139	0.190128
693.5	0.162870	0.312175	0.050844	0.200811
693.6	0.171760	0.312488	0.053673	0.211985
693.7	0.181010	0.312800	0.056620	0.223624
693.8	0.190630	0.313113	0.059689	0.235745
693.9	0.200610	0.313426	0.062876	0.248335
694.0	0.210940	0.313739	0.066180	0.261383
694.1	0.221630	0.314003	0.069592	0.274860
694.2	0.232660	0.314267	0.073117	0.288782
694.3	0.244030	0.314531	0.076755	0.303149
694.4	0.255730	0.314795	0.080502	0.317950
694.5	0.267750	0.315056	0.084356	0.333171
694.6	0.280090	0.315317	0.088317	0.348815
694.7	0.292740	0.315579	0.092382	0.364871
694.8	0.305680	0.315840	0.096546	0.381314
694.9	0.318920	0.316101	0.100811	0.398159
695.0	0.332440	0.316362	0.105171	0.415381
695.1	0.346240	0.316622	0.109627	0.432980
695.2	0.360260	0.316883	0.114160	0.450883
695.3	0.374480	0.317143	0.118764	0.469065
695.4	0.388840	0.317403	0.123419	0.487452
695.5	0.403300	0.317664	0.128114	0.505994
695.6	0.417810	0.317924	0.132832	0.524628
695.7	0.432340	0.318185	0.137564	0.543318
695.8	0.446840	0.318445	0.142294	0.562000
695.9	0.461260	0.318706	0.147006	0.580610
696.0	0.475550	0.318966	0.151684	0.599087
696.1	0.489690	0.319049	0.156235	0.617060
696.2	0.503610	0.319131	0.160718	0.634765
696.3	0.517290	0.319213	0.165126	0.652175
696.4	0.530670	0.319294	0.169440	0.669214
696.5	0.543700	0.319374	0.173644	0.685818
696.6	0.556360	0.319454	0.177732	0.701962
696.7	0.568590	0.319534	0.181684	0.717572
696.8	0.580350	0.319613	0.185487	0.732595
696.9	0.591600	0.319692	0.189130	0.746981
697.0	0.602290	0.319771	0.192595	0.760667

697.1	0.612390	0.319855	0.195876	0.773624
697.2	0.621910	0.319938	0.198973	0.785855
697.3	0.630870	0.320021	0.201892	0.797384
697.4	0.639300	0.320104	0.204642	0.808248
697.5	0.647210	0.320187	0.207228	0.818461
697.6	0.654640	0.320269	0.209661	0.828071
697.7	0.661600	0.320352	0.211945	0.837091
697.8	0.668100	0.320435	0.214082	0.845533
697.9	0.674190	0.320517	0.216090	0.853460
698.0	0.679870	0.320600	0.217966	0.860872
698.1	0.685170	0.320828	0.219822	0.868201
698.2	0.690110	0.321057	0.221564	0.875083
698.3	0.694710	0.321284	0.223200	0.881541
698.4	0.698980	0.321512	0.224730	0.887587
698.5	0.702940	0.321739	0.226163	0.893247
698.6	0.706620	0.321966	0.227508	0.898557
698.7	0.710030	0.322194	0.228767	0.903531
698.8	0.713190	0.322421	0.229947	0.908193
698.9	0.716120	0.322648	0.231055	0.912567
699.0	0.718840	0.322875	0.232096	0.916678
699.1	0.721360	0.323105	0.233075	0.920546
699.2	0.723700	0.323335	0.233997	0.924188
699.3	0.725840	0.323564	0.234856	0.927578
699.4	0.727810	0.323793	0.235660	0.930755
699.5	0.729610	0.324022	0.236410	0.933716
699.6	0.731230	0.324251	0.237102	0.936450
699.7	0.732680	0.324480	0.237740	0.938968
699.8	0.733970	0.324708	0.238326	0.941283
699.9	0.735110	0.324936	0.238863	0.943407
700.0	0.736090	0.325163	0.239350	0.945327
700.1	0.736920	0.325451	0.239831	0.947230
700.2	0.737630	0.325739	0.240275	0.948980
700.3	0.738250	0.326026	0.240689	0.950617
700.4	0.738790	0.326313	0.241077	0.952150
700.5	0.739280	0.326600	0.241449	0.953620
700.6	0.739760	0.326887	0.241818	0.955075
700.7	0.740240	0.327173	0.242187	0.956532
700.8	0.740750	0.327458	0.242565	0.958026
700.9	0.741320	0.327744	0.242963	0.959598
701.0	0.741970	0.328029	0.243387	0.961274
701.1	0.742720	0.328311	0.243843	0.963076
701.2	0.743580	0.328594	0.244336	0.965021
701.3	0.744510	0.328876	0.244852	0.967058

701.4	0.745520	0.329158	0.245394	0.969200
701.5	0.746590	0.329440	0.245956	0.971421
701.6	0.747720	0.329721	0.246539	0.973721
701.7	0.748880	0.330001	0.247131	0.976062
701.8	0.750070	0.330281	0.247734	0.978443
701.9	0.751280	0.330561	0.248344	0.980852
702.0	0.752490	0.330841	0.248954	0.983262
702.1	0.753690	0.330961	0.249442	0.985187
702.2	0.754870	0.331082	0.249924	0.987090
702.3	0.756010	0.331203	0.250393	0.988942
702.4	0.757100	0.331324	0.250845	0.990730
702.5	0.758110	0.331444	0.251271	0.992412
702.6	0.759040	0.331564	0.251670	0.993988
702.7	0.759860	0.331683	0.252033	0.995420
702.8	0.760550	0.331802	0.252352	0.996682
702.9	0.761120	0.331921	0.252632	0.997787
703.0	0.761530	0.332040	0.252858	0.998681
703.1	0.761770	0.332157	0.253027	0.999348
703.2	0.761840	0.332274	0.253140	0.999792
703.3	0.761730	0.332391	0.253192	1.000000
703.4	0.761450	0.332508	0.253188	0.999984
703.5	0.761000	0.332625	0.253127	0.999744
703.6	0.760360	0.332741	0.253003	0.999251
703.7	0.759550	0.332857	0.252821	0.998534
703.8	0.758560	0.332972	0.252580	0.997580
703.9	0.757380	0.333088	0.252274	0.996374
704.0	0.756010	0.333204	0.251905	0.994917
704.1	0.754460	0.333391	0.251530	0.993434
704.2	0.752740	0.333579	0.251098	0.991729
704.3	0.750870	0.333767	0.250616	0.989823
704.4	0.748840	0.333955	0.250079	0.987704
704.5	0.746690	0.334143	0.249502	0.985423
704.6	0.744430	0.334332	0.248886	0.982993
704.7	0.742070	0.334520	0.248237	0.980428
704.8	0.739620	0.334707	0.247556	0.977740
704.9	0.737110	0.334895	0.246855	0.974969
705.0	0.734530	0.335083	0.246129	0.972101
705.1	0.731910	0.335270	0.245387	0.969174
705.2	0.729230	0.335457	0.244625	0.966163
705.3	0.726440	0.335643	0.243825	0.963002
705.4	0.723540	0.335830	0.242986	0.959690
705.5	0.720480	0.336016	0.242093	0.956162
705.6	0.717250	0.336202	0.241141	0.952401

705.7	0.713810	0.336387	0.240117	0.948357
705.8	0.710140	0.336573	0.239014	0.944001
705.9	0.706210	0.336758	0.237822	0.939294
706.0	0.701990	0.336943	0.236531	0.934195
706.1	0.697470	0.337074	0.235099	0.928538
706.2	0.692650	0.337204	0.233564	0.922477
706.3	0.687580	0.337334	0.231944	0.916078
706.4	0.682270	0.337463	0.230241	0.909353
706.5	0.676740	0.337593	0.228463	0.902329
706.6	0.671030	0.337722	0.226621	0.895056
706.7	0.665160	0.337850	0.224725	0.887565
706.8	0.659150	0.337979	0.222779	0.879880
706.9	0.653040	0.338108	0.220798	0.872056
707.0	0.646840	0.338237	0.218785	0.864106
707.1	0.640570	0.338363	0.216745	0.856049
707.2	0.634240	0.338489	0.214683	0.847905
707.3	0.627840	0.338615	0.212596	0.839661
707.4	0.621360	0.338741	0.210480	0.831304
707.5	0.614800	0.338866	0.208335	0.822833
707.6	0.608140	0.338992	0.206155	0.814222
707.7	0.601390	0.339118	0.203942	0.805483
707.8	0.594530	0.339244	0.201691	0.796591
707.9	0.587570	0.339370	0.199404	0.787558
708.0	0.580480	0.339500	0.197073	0.778353
708.1	0.573270	0.339548	0.194653	0.768795
708.2	0.565930	0.339597	0.192188	0.759059
708.3	0.558450	0.339645	0.189675	0.749132
708.4	0.550810	0.339693	0.187106	0.738988
708.5	0.543010	0.339741	0.184483	0.728627
708.6	0.535040	0.339789	0.181801	0.718035
708.7	0.526880	0.339838	0.179054	0.707185
708.8	0.518540	0.339886	0.176244	0.696089
708.9	0.509990	0.339934	0.173363	0.684709
709.0	0.501230	0.339983	0.170410	0.673044
709.1	0.492260	0.340026	0.167381	0.661082
709.2	0.483090	0.340068	0.164284	0.648849
709.3	0.473750	0.340111	0.161128	0.636384
709.4	0.464250	0.340154	0.157917	0.623702
709.5	0.454630	0.340197	0.154664	0.610855
709.6	0.444910	0.340240	0.151376	0.597870
709.7	0.435100	0.340283	0.148057	0.584761
709.8	0.425230	0.340326	0.144717	0.571568
709.9	0.415330	0.340372	0.141367	0.558336

710.0	0.405420	0.340420	0.138013	0.545092
710.1	0.395520	0.340578	0.134706	0.532029
710.2	0.385640	0.340737	0.131402	0.518980
710.3	0.375800	0.340895	0.128108	0.505972
710.4	0.366010	0.341053	0.124829	0.493020
710.5	0.356280	0.341212	0.121567	0.480137
710.6	0.346620	0.341370	0.118326	0.467335
710.7	0.337040	0.341529	0.115109	0.454630
710.8	0.327570	0.341687	0.111926	0.442061
710.9	0.318200	0.341846	0.108775	0.429615
711.0	0.308960	0.342004	0.105666	0.417333
711.1	0.299850	0.342158	0.102596	0.405210
711.2	0.290870	0.342312	0.099568	0.393251
711.3	0.282010	0.342466	0.096579	0.381445
711.4	0.273260	0.342621	0.093625	0.369776
711.5	0.264630	0.342775	0.090709	0.358259
711.6	0.256100	0.342929	0.087824	0.346867
711.7	0.247670	0.343083	0.084971	0.335600
711.8	0.239330	0.343238	0.082147	0.324446
711.9	0.231080	0.343399	0.079353	0.313408
712.0	0.222910	0.343560	0.076583	0.302469
712.1	0.214820	0.343696	0.073833	0.291607
712.2	0.206830	0.343832	0.071115	0.280873
712.3	0.198960	0.343968	0.068436	0.270292
712.4	0.191220	0.344104	0.065800	0.259880
712.5	0.183650	0.344241	0.063220	0.249691
712.6	0.176260	0.344377	0.060700	0.239738
712.7	0.169070	0.344514	0.058247	0.230050
712.8	0.162110	0.344650	0.055871	0.220667
712.9	0.155400	0.344787	0.053580	0.211617
713.0	0.148960	0.344924	0.051380	0.202928
713.1	0.142810	0.345063	0.049278	0.194628
713.2	0.136930	0.345201	0.047268	0.186690
713.3	0.131300	0.345340	0.045343	0.179086
713.4	0.125920	0.345479	0.043503	0.171817
713.5	0.120760	0.345619	0.041737	0.164843
713.6	0.115800	0.345759	0.040039	0.158136
713.7	0.111030	0.345899	0.038405	0.151684
713.8	0.106440	0.346046	0.036833	0.145475
713.9	0.102000	0.346195	0.035312	0.139466
714.0	0.097689	0.346343	0.033834	0.133629
714.1	0.093505	0.346420	0.032392	0.127934
714.2	0.089442	0.346496	0.030991	0.122402

714.3	0.085504	0.346573	0.029633	0.117039
714.4	0.081691	0.346650	0.028318	0.111845
714.5	0.078007	0.346727	0.027047	0.106825
714.6	0.074454	0.346804	0.025821	0.101982
714.7	0.071034	0.346881	0.024640	0.097319
714.8	0.067750	0.346958	0.023506	0.092840
714.9	0.064603	0.347035	0.022419	0.088547
715.0	0.061597	0.347111	0.021381	0.084446
715.1	0.058732	0.347189	0.020391	0.080536
715.2	0.056001	0.347267	0.019447	0.076808
715.3	0.053398	0.347344	0.018547	0.073254
715.4	0.050914	0.347421	0.017689	0.069862
715.5	0.048541	0.347499	0.016868	0.066621
715.6	0.046272	0.347576	0.016083	0.063521
715.7	0.044099	0.347658	0.015331	0.060552
715.8	0.042014	0.347743	0.014610	0.057703
715.9	0.040009	0.347828	0.013916	0.054963
716.0	0.038077	0.347913	0.013247	0.052322
716.1	0.036212	0.347914	0.012599	0.049759
716.2	0.034422	0.347915	0.011976	0.047300
716.3	0.032714	0.347916	0.011382	0.044953
716.4	0.031097	0.347917	0.010819	0.042731
716.5	0.029582	0.347918	0.010292	0.040649
716.6	0.028177	0.347919	0.009803	0.038719
716.7	0.026890	0.347920	0.009356	0.036950
716.8	0.025732	0.347921	0.008953	0.035359
716.9	0.024710	0.347921	0.008597	0.033955
717.0	0.023835	0.347922	0.008293	0.032753
717.1	0.023108	0.347924	0.008040	0.031754
717.2	0.022508	0.347926	0.007831	0.030930
717.3	0.022006	0.347928	0.007657	0.030240
717.4	0.021572	0.347930	0.007506	0.029644
717.5	0.021179	0.347932	0.007369	0.029104
717.6	0.020797	0.347938	0.007236	0.028579
717.7	0.020397	0.347948	0.007097	0.028030
717.8	0.019952	0.347959	0.006942	0.027420
717.9	0.019432	0.347970	0.006762	0.026706
718.0	0.018809	0.347980	0.006545	0.025851
718.1	0.018062	0.348149	0.006288	0.024836
718.2	0.017207	0.348317	0.005993	0.023672
718.3	0.016265	0.348485	0.005668	0.022387
718.4	0.015262	0.348653	0.005321	0.021016
718.5	0.014219	0.348821	0.004960	0.019589

718.6	0.013161	0.348989	0.004593	0.018141
718.7	0.012111	0.349158	0.004229	0.016701
718.8	0.011091	0.349326	0.003874	0.015302
718.9	0.010125	0.349494	0.003539	0.013976
719.0	0.009237	0.349662	0.003230	0.012756
719.1	0.008445	0.349830	0.002954	0.011669
719.2	0.007754	0.349997	0.002714	0.010719
719.3	0.007163	0.350165	0.002508	0.009907
719.4	0.006671	0.350334	0.002337	0.009231
719.5	0.006279	0.350503	0.002201	0.008692
719.6	0.005985	0.350680	0.002099	0.008289
719.7	0.005789	0.350857	0.002031	0.008023
719.8	0.005692	0.351034	0.001998	0.007891
719.9	0.005692	0.351212	0.001999	0.007895
720.0	0.005789	0.351389	0.002034	0.008034
720.1	0.005979	0.351398	0.002101	0.008297
720.2	0.006238	0.351408	0.002192	0.008658
720.3	0.006540	0.351418	0.002298	0.009077
720.4	0.006858	0.351428	0.002410	0.009519
720.5	0.007165	0.351438	0.002518	0.009945
720.6	0.007434	0.351447	0.002613	0.010318
720.7	0.007638	0.351457	0.002684	0.010602
720.8	0.007749	0.351467	0.002724	0.010757
720.9	0.007742	0.351477	0.002721	0.010747
721.0	0.007589	0.351486	0.002667	0.010535
721.1	0.007273	0.351495	0.002556	0.010096
721.2	0.006814	0.351503	0.002395	0.009460
721.3	0.006244	0.351512	0.002195	0.008669
721.4	0.005593	0.351520	0.001966	0.007766
721.5	0.004893	0.351536	0.001720	0.006793
721.6	0.004173	0.351554	0.001467	0.005794
721.7	0.003465	0.351571	0.001218	0.004811
721.8	0.002799	0.351589	0.000984	0.003887
721.9	0.002206	0.351606	0.000776	0.003064
722.0	0.001717	0.351624	0.000604	0.002385
722.1	0.001355	0.351604	0.000476	0.001882
722.2	0.001113	0.351585	0.000391	0.001546
722.3	0.000977	0.351566	0.000343	0.001356
722.4	0.000931	0.351546	0.000327	0.001293
722.5	0.000963	0.351526	0.000338	0.001336
722.6	0.001056	0.351507	0.000371	0.001466
722.7	0.001197	0.351487	0.000421	0.001662
722.8	0.001372	0.351467	0.000482	0.001904

722.9	0.001565	0.351447	0.000550	0.002172
723.0	0.001762	0.351427	0.000619	0.002446
723.1	0.001951	0.351408	0.000686	0.002708
723.2	0.002127	0.351389	0.000748	0.002952
723.3	0.002288	0.351369	0.000804	0.003175
723.4	0.002431	0.351355	0.000854	0.003374
723.5	0.002554	0.351345	0.000897	0.003543
723.6	0.002653	0.351336	0.000932	0.003681
723.7	0.002727	0.351326	0.000958	0.003783
723.8	0.002772	0.351316	0.000974	0.003846
723.9	0.002787	0.351307	0.000979	0.003867
724.0	0.002768	0.351297	0.000972	0.003841
724.1	0.002715	0.351381	0.000954	0.003767
724.2	0.002630	0.351465	0.000924	0.003651
724.3	0.002519	0.351548	0.000886	0.003498
724.4	0.002387	0.351632	0.000839	0.003315
724.5	0.002238	0.351716	0.000787	0.003109
724.6	0.002078	0.351800	0.000731	0.002887
724.7	0.001910	0.351884	0.000672	0.002654
724.8	0.001740	0.351968	0.000612	0.002419
724.9	0.001573	0.352052	0.000554	0.002187
725.0	0.001413	0.352135	0.000498	0.001965
725.1	0.001265	0.352219	0.000446	0.001760
725.2	0.001132	0.352303	0.000399	0.001575
725.3	0.001016	0.352389	0.000358	0.001414
725.4	0.000920	0.352482	0.000324	0.001281
725.5	0.000847	0.352576	0.000299	0.001180
725.6	0.000799	0.352670	0.000282	0.001112
725.7	0.000778	0.352763	0.000274	0.001084
725.8	0.000787	0.352857	0.000278	0.001097
725.9	0.000829	0.352951	0.000293	0.001156
726.0	0.000906	0.353045	0.000320	0.001263
726.1	0.001019	0.353156	0.000360	0.001421
726.2	0.001158	0.353267	0.000409	0.001616
726.3	0.001314	0.353378	0.000464	0.001834
726.4	0.001475	0.353490	0.000521	0.002060
726.5	0.001631	0.353601	0.000577	0.002278
726.6	0.001772	0.353712	0.000627	0.002475
726.7	0.001885	0.353824	0.000667	0.002634
726.8	0.001962	0.353936	0.000694	0.002742
726.9	0.001990	0.354048	0.000704	0.002782
727.0	0.001959	0.354160	0.000694	0.002740
727.1	0.001863	0.354270	0.000660	0.002606

727.2	0.001710	0.354381	0.000606	0.002393
727.3	0.001513	0.354500	0.000536	0.002119
727.4	0.001286	0.354621	0.000456	0.001801
727.5	0.001041	0.354741	0.000369	0.001458
727.6	0.000791	0.354861	0.000281	0.001108
727.7	0.000549	0.354982	0.000195	0.000769
727.8	0.000328	0.355102	0.000116	0.000460
727.9	0.000140	0.355222	0.000050	0.000197
728.0	0.000000	0.355343	0.000000	0.000000
Channel 5				
Wavenumber	HIRS Filter Transmittance	Optical Element Transmittance	Product of the HIRS Filter and Optical Element Transmittances	Normalized Value of Column 4
688.3	0.000197	0.295246	0.000058	0.000245
688.4	0.000407	0.295629	0.000120	0.000507
688.5	0.000607	0.296012	0.000180	0.000758
688.6	0.000799	0.296395	0.000237	0.000999
688.7	0.000982	0.296774	0.000291	0.001229
688.8	0.001100	0.297151	0.000327	0.001378
688.9	0.001211	0.297529	0.000360	0.001520
689.0	0.001322	0.297906	0.000394	0.001661
689.1	0.001433	0.298283	0.000428	0.001803
689.2	0.001544	0.298660	0.000461	0.001945
689.3	0.001656	0.299037	0.000495	0.002088
689.4	0.001767	0.299414	0.000529	0.002231
689.5	0.001878	0.299790	0.000563	0.002374
689.6	0.001989	0.300167	0.000597	0.002518
689.7	0.002100	0.300544	0.000631	0.002661
689.8	0.002211	0.300921	0.000665	0.002806
689.9	0.002322	0.301298	0.000700	0.002950
690.0	0.002433	0.301675	0.000734	0.003095
690.1	0.002544	0.301968	0.000768	0.003240
690.2	0.002656	0.302261	0.000803	0.003385
690.3	0.002767	0.302554	0.000837	0.003530
690.4	0.002878	0.302847	0.000872	0.003675
690.5	0.002989	0.303140	0.000906	0.003821
690.6	0.003100	0.303431	0.000941	0.003967
690.7	0.003211	0.303719	0.000975	0.004113
690.8	0.003322	0.304008	0.001010	0.004259
690.9	0.003433	0.304296	0.001045	0.004406
691.0	0.003544	0.304584	0.001080	0.004552
691.1	0.003656	0.304867	0.001114	0.004700

691.2	0.003767	0.305150	0.001149	0.004847
691.3	0.003878	0.305433	0.001184	0.004995
691.4	0.003989	0.305716	0.001219	0.005142
691.5	0.004100	0.305999	0.001255	0.005291
691.6	0.004211	0.306282	0.001290	0.005439
691.7	0.004322	0.306566	0.001325	0.005588
691.8	0.004433	0.306849	0.001360	0.005736
691.9	0.004544	0.307133	0.001396	0.005886
692.0	0.004656	0.307416	0.001431	0.006035
692.1	0.004767	0.307737	0.001467	0.006186
692.2	0.004878	0.308058	0.001503	0.006337
692.3	0.004989	0.308379	0.001538	0.006488
692.4	0.005100	0.308701	0.001574	0.006639
692.5	0.005211	0.309022	0.001610	0.006791
692.6	0.005322	0.309339	0.001646	0.006943
692.7	0.005433	0.309657	0.001682	0.007095
692.8	0.005544	0.309975	0.001719	0.007247
692.9	0.005656	0.310293	0.001755	0.007400
693.0	0.005767	0.310611	0.001791	0.007553
693.1	0.005878	0.310924	0.001828	0.007707
693.2	0.005989	0.311237	0.001864	0.007860
693.3	0.006100	0.311549	0.001900	0.008014
693.4	0.006211	0.311862	0.001937	0.008168
693.5	0.006322	0.312175	0.001974	0.008323
693.6	0.006433	0.312488	0.002010	0.008477
693.7	0.006544	0.312800	0.002047	0.008632
693.8	0.006656	0.313113	0.002084	0.008788
693.9	0.006767	0.313426	0.002121	0.008943
694.0	0.006878	0.313739	0.002158	0.009099
694.1	0.006989	0.314003	0.002195	0.009254
694.2	0.007100	0.314267	0.002231	0.009409
694.3	0.007211	0.314531	0.002268	0.009564
694.4	0.007322	0.314795	0.002305	0.009720
694.5	0.007433	0.315056	0.002342	0.009876
694.6	0.007544	0.315317	0.002379	0.010032
694.7	0.007656	0.315579	0.002416	0.010188
694.8	0.007767	0.315840	0.002453	0.010344
694.9	0.007878	0.316101	0.002490	0.010501
695.0	0.007989	0.316362	0.002527	0.010658
695.1	0.008100	0.316622	0.002565	0.010815
695.2	0.008211	0.316883	0.002602	0.010972
695.3	0.008322	0.317143	0.002639	0.011130
695.4	0.008433	0.317403	0.002677	0.011288

695.5	0.008544	0.317664	0.002714	0.011446
695.6	0.008656	0.317924	0.002752	0.011604
695.7	0.008767	0.318185	0.002789	0.011763
695.8	0.008878	0.318445	0.002827	0.011922
695.9	0.008989	0.318706	0.002865	0.012081
696.0	0.009100	0.318966	0.002903	0.012240
696.1	0.009211	0.319049	0.002939	0.012393
696.2	0.009322	0.319131	0.002975	0.012545
696.3	0.009433	0.319213	0.003011	0.012698
696.4	0.009544	0.319294	0.003047	0.012851
696.5	0.009656	0.319374	0.003084	0.013004
696.6	0.009767	0.319454	0.003120	0.013157
696.7	0.009878	0.319534	0.003156	0.013310
696.8	0.009989	0.319613	0.003193	0.013463
696.9	0.010288	0.319692	0.003289	0.013869
697.0	0.010624	0.319771	0.003397	0.014326
697.1	0.010980	0.319855	0.003512	0.014810
697.2	0.011360	0.319938	0.003634	0.015326
697.3	0.011768	0.320021	0.003766	0.015881
697.4	0.012189	0.320104	0.003902	0.016453
697.5	0.012608	0.320187	0.004037	0.017023
697.6	0.013006	0.320269	0.004165	0.017565
697.7	0.013367	0.320352	0.004282	0.018057
697.8	0.013679	0.320435	0.004383	0.018484
697.9	0.013972	0.320517	0.004478	0.018884
698.0	0.014286	0.320600	0.004580	0.019314
698.1	0.014663	0.320828	0.004704	0.019838
698.2	0.015145	0.321057	0.004862	0.020504
698.3	0.015760	0.321284	0.005063	0.021352
698.4	0.016483	0.321512	0.005299	0.022347
698.5	0.017267	0.321739	0.005555	0.023427
698.6	0.018064	0.321966	0.005816	0.024526
698.7	0.018827	0.322194	0.006066	0.025579
698.8	0.019520	0.322421	0.006294	0.026540
698.9	0.020156	0.322648	0.006503	0.027424
699.0	0.020766	0.322875	0.006705	0.028274
699.1	0.021381	0.323105	0.006908	0.029132
699.2	0.022032	0.323335	0.007124	0.030040
699.3	0.022749	0.323564	0.007361	0.031040
699.4	0.023562	0.323793	0.007629	0.032172
699.5	0.024499	0.324022	0.007938	0.033475
699.6	0.025589	0.324251	0.008297	0.034989
699.7	0.026862	0.324480	0.008716	0.036755

699.8	0.028335	0.324708	0.009201	0.038798
699.9	0.029977	0.324936	0.009741	0.041075
700.0	0.031738	0.325163	0.010320	0.043519
700.1	0.033568	0.325451	0.010925	0.046069
700.2	0.035416	0.325739	0.011536	0.048648
700.3	0.037236	0.326026	0.012140	0.051193
700.4	0.038992	0.326313	0.012724	0.053654
700.5	0.040654	0.326600	0.013278	0.055990
700.6	0.042191	0.326887	0.013792	0.058158
700.7	0.043572	0.327173	0.014256	0.060114
700.8	0.044779	0.327458	0.014663	0.061834
700.9	0.045866	0.327744	0.015032	0.063390
701.0	0.046909	0.328029	0.015387	0.064888
701.1	0.047986	0.328311	0.015754	0.066435
701.2	0.049172	0.328594	0.016158	0.068135
701.3	0.050537	0.328876	0.016620	0.070087
701.4	0.052103	0.329158	0.017150	0.072320
701.5	0.053875	0.329440	0.017749	0.074844
701.6	0.055861	0.329721	0.018419	0.077669
701.7	0.058067	0.330001	0.019162	0.080805
701.8	0.060494	0.330281	0.019980	0.084254
701.9	0.063111	0.330561	0.020862	0.087973
702.0	0.065879	0.330841	0.021795	0.091909
702.1	0.068756	0.330961	0.022756	0.095958
702.2	0.071703	0.331082	0.023740	0.100107
702.3	0.074688	0.331203	0.024737	0.104313
702.4	0.077729	0.331324	0.025753	0.108600
702.5	0.080862	0.331444	0.026801	0.113018
702.6	0.084123	0.331564	0.027892	0.117618
702.7	0.087547	0.331683	0.029038	0.122450
702.8	0.091168	0.331802	0.030250	0.127560
702.9	0.095007	0.331921	0.031535	0.132979
703.0	0.099084	0.332040	0.032900	0.138735
703.1	0.103420	0.332157	0.034352	0.144858
703.2	0.108020	0.332274	0.035892	0.151354
703.3	0.112920	0.332391	0.037534	0.158276
703.4	0.118120	0.332508	0.039276	0.165622
703.5	0.123610	0.332625	0.041116	0.173381
703.6	0.129390	0.332741	0.043053	0.181552
703.7	0.135480	0.332857	0.045095	0.190163
703.8	0.141850	0.332972	0.047232	0.199173
703.9	0.148520	0.333088	0.049470	0.208611
704.0	0.155450	0.333204	0.051797	0.218421

704.1	0.162630	0.333391	0.054219	0.228638
704.2	0.170050	0.333579	0.056725	0.239204
704.3	0.177680	0.333767	0.059304	0.250078
704.4	0.185510	0.333955	0.061952	0.261246
704.5	0.193520	0.334143	0.064663	0.272679
704.6	0.201680	0.334332	0.067428	0.284337
704.7	0.209960	0.334520	0.070236	0.296177
704.8	0.218360	0.334707	0.073087	0.308200
704.9	0.226880	0.334895	0.075981	0.320405
705.0	0.235530	0.335083	0.078922	0.332807
705.1	0.244330	0.335270	0.081916	0.345434
705.2	0.253290	0.335457	0.084968	0.358301
705.3	0.262430	0.335643	0.088083	0.371437
705.4	0.271770	0.335830	0.091268	0.384870
705.5	0.281310	0.336016	0.094525	0.398601
705.6	0.291080	0.336202	0.097862	0.412673
705.7	0.301090	0.336387	0.101283	0.427100
705.8	0.311350	0.336573	0.104792	0.441898
705.9	0.321880	0.336758	0.108396	0.457094
706.0	0.332690	0.336943	0.112098	0.472705
706.1	0.343770	0.337074	0.115876	0.488637
706.2	0.355150	0.337204	0.119758	0.505007
706.3	0.366800	0.337334	0.123734	0.521774
706.4	0.378670	0.337463	0.127787	0.538867
706.5	0.390660	0.337593	0.131884	0.556142
706.6	0.402670	0.337722	0.135990	0.573458
706.7	0.414610	0.337850	0.140076	0.590688
706.8	0.426400	0.337979	0.144114	0.607716
706.9	0.438020	0.338108	0.148098	0.624515
707.0	0.449460	0.338237	0.152024	0.641070
707.1	0.460720	0.338363	0.155890	0.657375
707.2	0.471800	0.338489	0.159699	0.673435
707.3	0.482700	0.338615	0.163449	0.689250
707.4	0.493400	0.338741	0.167135	0.704790
707.5	0.503900	0.338866	0.170755	0.720056
707.6	0.514170	0.338992	0.174300	0.735004
707.7	0.524210	0.339118	0.177769	0.749635
707.8	0.534000	0.339244	0.181156	0.763918
707.9	0.543510	0.339370	0.184451	0.777812
708.0	0.552730	0.339500	0.187652	0.791310
708.1	0.561620	0.339548	0.190697	0.804151
708.2	0.570170	0.339597	0.193628	0.816510
708.3	0.578340	0.339645	0.196430	0.828327

708.4	0.586130	0.339693	0.199104	0.839603
708.5	0.593550	0.339741	0.201653	0.850352
708.6	0.600590	0.339789	0.204074	0.860561
708.7	0.607250	0.339838	0.206367	0.870227
708.8	0.613550	0.339886	0.208537	0.879380
708.9	0.619500	0.339934	0.210589	0.888035
709.0	0.625160	0.339983	0.212544	0.896276
709.1	0.630540	0.340026	0.214400	0.904103
709.2	0.635700	0.340068	0.216181	0.911616
709.3	0.640650	0.340111	0.217892	0.918830
709.4	0.645380	0.340154	0.219529	0.925731
709.5	0.649870	0.340197	0.221084	0.932289
709.6	0.654060	0.340240	0.222537	0.938418
709.7	0.657930	0.340283	0.223882	0.944090
709.8	0.661450	0.340326	0.225108	0.949261
709.9	0.664620	0.340372	0.226218	0.953938
710.0	0.667450	0.340420	0.227213	0.958137
710.1	0.669940	0.340578	0.228167	0.962159
710.2	0.672100	0.340737	0.229009	0.965709
710.3	0.673950	0.340895	0.229746	0.968817
710.4	0.675550	0.341053	0.230399	0.971568
710.5	0.676970	0.341212	0.230990	0.974063
710.6	0.678280	0.341370	0.231545	0.976401
710.7	0.679570	0.341529	0.232093	0.978713
710.8	0.680890	0.341687	0.232651	0.981068
710.9	0.682240	0.341846	0.233221	0.983470
711.0	0.683590	0.342004	0.233791	0.985872
711.1	0.684910	0.342158	0.234347	0.988220
711.2	0.686180	0.342312	0.234888	0.990498
711.3	0.687360	0.342466	0.235398	0.992649
711.4	0.688420	0.342621	0.235867	0.994628
711.5	0.689320	0.342775	0.236282	0.996376
711.6	0.690010	0.342929	0.236624	0.997822
711.7	0.690470	0.343083	0.236888	0.998935
711.8	0.690650	0.343238	0.237057	0.999648
711.9	0.690570	0.343399	0.237141	1.000000
712.0	0.690230	0.343560	0.237135	0.999976
712.1	0.689670	0.343696	0.237037	0.999561
712.2	0.688890	0.343832	0.236863	0.998826
712.3	0.687920	0.343968	0.236623	0.997815
712.4	0.686810	0.344104	0.236334	0.996599
712.5	0.685600	0.344241	0.236011	0.995237
712.6	0.684350	0.344377	0.235674	0.993816

712.7	0.683120	0.344514	0.235344	0.992423
712.8	0.681950	0.344650	0.235034	0.991117
712.9	0.680830	0.344787	0.234741	0.989882
713.0	0.679760	0.344924	0.234466	0.988718
713.1	0.678730	0.345063	0.234204	0.987617
713.2	0.677700	0.345201	0.233943	0.986514
713.3	0.676690	0.345340	0.233688	0.985441
713.4	0.675710	0.345479	0.233444	0.984410
713.5	0.674820	0.345619	0.233231	0.983510
713.6	0.674050	0.345759	0.233059	0.982786
713.7	0.673450	0.345899	0.232946	0.982309
713.8	0.673050	0.346046	0.232906	0.982144
713.9	0.672800	0.346195	0.232920	0.982200
714.0	0.672620	0.346343	0.232957	0.982358
714.1	0.672460	0.346420	0.232953	0.982342
714.2	0.672230	0.346496	0.232925	0.982223
714.3	0.671870	0.346573	0.232852	0.981915
714.4	0.671380	0.346650	0.232734	0.981417
714.5	0.670770	0.346727	0.232574	0.980743
714.6	0.670030	0.346804	0.232369	0.979878
714.7	0.669190	0.346881	0.232129	0.978866
714.8	0.668260	0.346958	0.231858	0.977722
714.9	0.667290	0.347035	0.231573	0.976519
715.0	0.666370	0.347111	0.231305	0.975389
715.1	0.665560	0.347189	0.231075	0.974421
715.2	0.664950	0.347267	0.230915	0.973745
715.3	0.664580	0.347344	0.230838	0.973421
715.4	0.664420	0.347421	0.230834	0.973403
715.5	0.664400	0.347499	0.230878	0.973591
715.6	0.664450	0.347576	0.230947	0.973880
715.7	0.664500	0.347658	0.231019	0.974183
715.8	0.664480	0.347743	0.231068	0.974392
715.9	0.664370	0.347828	0.231086	0.974469
716.0	0.664160	0.347913	0.231070	0.974399
716.1	0.663830	0.347914	0.230956	0.973918
716.2	0.663360	0.347915	0.230793	0.973232
716.3	0.662740	0.347916	0.230578	0.972325
716.4	0.662000	0.347917	0.230321	0.971243
716.5	0.661160	0.347918	0.230030	0.970013
716.6	0.660250	0.347919	0.229714	0.968680
716.7	0.659300	0.347920	0.229384	0.967289
716.8	0.658330	0.347921	0.229047	0.965868
716.9	0.657370	0.347921	0.228713	0.964461

717.0	0.656420	0.347922	0.228383	0.963069
717.1	0.655490	0.347924	0.228061	0.961710
717.2	0.654590	0.347926	0.227749	0.960395
717.3	0.653720	0.347928	0.227448	0.959124
717.4	0.652860	0.347930	0.227150	0.957869
717.5	0.651940	0.347932	0.226831	0.956524
717.6	0.650910	0.347938	0.226476	0.955028
717.7	0.649730	0.347948	0.226073	0.953326
717.8	0.648350	0.347959	0.225599	0.951330
717.9	0.646770	0.347970	0.225056	0.949041
718.0	0.645010	0.347980	0.224451	0.946487
718.1	0.643080	0.348149	0.223887	0.944111
718.2	0.641010	0.348317	0.223275	0.941527
718.3	0.638820	0.348485	0.222619	0.938763
718.4	0.636550	0.348653	0.221935	0.935879
718.5	0.634270	0.348821	0.221247	0.932977
718.6	0.632030	0.348989	0.220572	0.930130
718.7	0.629900	0.349158	0.219934	0.927442
718.8	0.627930	0.349326	0.219352	0.924986
718.9	0.626050	0.349494	0.218801	0.922661
719.0	0.624190	0.349662	0.218255	0.920362
719.1	0.622280	0.349830	0.217692	0.917986
719.2	0.620220	0.349997	0.217075	0.915386
719.3	0.617950	0.350165	0.216385	0.912473
719.4	0.615470	0.350334	0.215620	0.909248
719.5	0.612800	0.350503	0.214788	0.905740
719.6	0.609970	0.350680	0.213904	0.902013
719.7	0.607000	0.350857	0.212970	0.898075
719.8	0.603910	0.351034	0.211993	0.893955
719.9	0.600690	0.351212	0.210969	0.889637
720.0	0.597300	0.351389	0.209885	0.885063
720.1	0.593710	0.351398	0.208629	0.879767
720.2	0.589890	0.351408	0.207292	0.874131
720.3	0.585830	0.351418	0.205871	0.868138
720.4	0.581520	0.351428	0.204362	0.861776
720.5	0.576960	0.351438	0.202765	0.855042
720.6	0.572160	0.351447	0.201084	0.847952
720.7	0.567120	0.351457	0.199318	0.840506
720.8	0.561840	0.351467	0.197468	0.832704
720.9	0.556330	0.351477	0.195537	0.824560
721.0	0.550610	0.351486	0.193532	0.816105
721.1	0.544670	0.351495	0.191449	0.807321
721.2	0.538530	0.351503	0.189295	0.798239

721.3	0.532180	0.351512	0.187068	0.788846
721.4	0.525640	0.351520	0.184773	0.779170
721.5	0.518880	0.351536	0.182405	0.769184
721.6	0.511920	0.351554	0.179967	0.758905
721.7	0.504730	0.351571	0.177449	0.748284
721.8	0.497330	0.351589	0.174856	0.737350
721.9	0.489730	0.351606	0.172192	0.726118
722.0	0.481970	0.351624	0.169472	0.714647
722.1	0.474080	0.351604	0.166689	0.702910
722.2	0.466100	0.351585	0.163874	0.691040
722.3	0.458060	0.351566	0.161038	0.679082
722.4	0.449940	0.351546	0.158175	0.667007
722.5	0.441730	0.351526	0.155280	0.654800
722.6	0.433410	0.351507	0.152346	0.642430
722.7	0.424950	0.351487	0.149364	0.629855
722.8	0.416350	0.351467	0.146333	0.617073
722.9	0.407630	0.351447	0.143260	0.604115
723.0	0.398820	0.351427	0.140156	0.591025
723.1	0.389960	0.351408	0.137035	0.577863
723.2	0.381090	0.351389	0.133911	0.564688
723.3	0.372230	0.351369	0.130790	0.551530
723.4	0.363410	0.351355	0.127686	0.538439
723.5	0.354670	0.351345	0.124612	0.525475
723.6	0.346000	0.351336	0.121562	0.512616
723.7	0.337450	0.351326	0.118555	0.499934
723.8	0.329020	0.351316	0.115590	0.487432
723.9	0.320680	0.351307	0.112657	0.475064
724.0	0.312400	0.351297	0.109745	0.462785
724.1	0.304130	0.351381	0.106865	0.450641
724.2	0.295830	0.351465	0.103974	0.438447
724.3	0.287470	0.351548	0.101060	0.426159
724.4	0.279040	0.351632	0.098119	0.413760
724.5	0.270550	0.351716	0.095157	0.401267
724.6	0.262020	0.351800	0.092179	0.388708
724.7	0.253460	0.351884	0.089189	0.376099
724.8	0.244880	0.351968	0.086190	0.363454
724.9	0.236320	0.352052	0.083197	0.350833
725.0	0.227850	0.352135	0.080234	0.338339
725.1	0.219530	0.352219	0.077323	0.326062
725.2	0.211400	0.352303	0.074477	0.314062
725.3	0.203520	0.352389	0.071718	0.302428
725.4	0.195920	0.352482	0.069058	0.291212
725.5	0.188600	0.352576	0.066496	0.280406

725.6	0.181570	0.352670	0.064034	0.270026
725.7	0.174850	0.352763	0.061681	0.260101
725.8	0.168450	0.352857	0.059439	0.250648
725.9	0.162340	0.352951	0.057298	0.241621
726.0	0.156500	0.353045	0.055252	0.232991
726.1	0.150910	0.353156	0.053295	0.224739
726.2	0.145530	0.353267	0.051411	0.216795
726.3	0.140340	0.353378	0.049593	0.209129
726.4	0.135320	0.353490	0.047834	0.201712
726.5	0.130460	0.353601	0.046131	0.194529
726.6	0.125740	0.353712	0.044476	0.187550
726.7	0.121150	0.353824	0.042866	0.180761
726.8	0.116680	0.353936	0.041297	0.174146
726.9	0.112330	0.354048	0.039770	0.167707
727.0	0.108100	0.354160	0.038285	0.161443
727.1	0.104020	0.354270	0.036851	0.155398
727.2	0.100080	0.354381	0.035466	0.149558
727.3	0.096305	0.354500	0.034140	0.143966
727.4	0.092660	0.354621	0.032859	0.138564
727.5	0.089119	0.354741	0.031614	0.133314
727.6	0.085656	0.354861	0.030396	0.128177
727.7	0.082240	0.354982	0.029194	0.123107
727.8	0.078854	0.355102	0.028001	0.118078
727.9	0.075535	0.355222	0.026832	0.113147
728.0	0.072342	0.355343	0.025706	0.108401
728.1	0.069332	0.355421	0.024642	0.103913
728.2	0.066562	0.355499	0.023663	0.099783
728.3	0.064074	0.355577	0.022783	0.096075
728.4	0.061830	0.355655	0.021990	0.092730
728.5	0.059763	0.355732	0.021260	0.089650
728.6	0.057806	0.355809	0.020568	0.086733
728.7	0.055892	0.355887	0.019891	0.083879
728.8	0.053962	0.355963	0.019208	0.081000
728.9	0.052005	0.356040	0.018516	0.078080
729.0	0.050024	0.356116	0.017814	0.075121
729.1	0.048023	0.356190	0.017105	0.072131
729.2	0.046003	0.356269	0.016389	0.069113
729.3	0.043972	0.356352	0.015670	0.066077
729.4	0.041959	0.356435	0.014956	0.063066
729.5	0.039997	0.356517	0.014260	0.060131
729.6	0.038122	0.356599	0.013594	0.057326
729.7	0.036367	0.356682	0.012971	0.054699
729.8	0.034764	0.356764	0.012403	0.052300

729.9	0.033312	0.356846	0.011887	0.050127
730.0	0.032005	0.356927	0.011423	0.048172
730.1	0.030836	0.356921	0.011006	0.046411
730.2	0.029797	0.356916	0.010635	0.044847
730.3	0.028877	0.356909	0.010306	0.043461
730.4	0.028049	0.356903	0.010011	0.042214
730.5	0.027278	0.356896	0.009735	0.041053
730.6	0.026532	0.356890	0.009469	0.039930
730.7	0.025777	0.356884	0.009199	0.038793
730.8	0.024985	0.356877	0.008917	0.037600
730.9	0.024158	0.356871	0.008621	0.036355
731.0	0.023307	0.356864	0.008317	0.035074
731.1	0.022446	0.356859	0.008010	0.033778
731.2	0.021585	0.356860	0.007703	0.032482
731.3	0.020738	0.356861	0.007401	0.031208
731.4	0.019914	0.356862	0.007107	0.029968
731.5	0.019121	0.356863	0.006824	0.028774
731.6	0.018369	0.356864	0.006555	0.027643
731.7	0.017667	0.356865	0.006305	0.026586
731.8	0.017228	0.356865	0.006148	0.025926
731.9	0.016831	0.356866	0.006006	0.025328
732.0	0.016449	0.356866	0.005870	0.024754
732.1	0.016084	0.357016	0.005742	0.024215
732.2	0.015734	0.357166	0.005620	0.023698
732.3	0.015400	0.357316	0.005503	0.023204
732.4	0.015083	0.357466	0.005392	0.022736
732.5	0.014781	0.357617	0.005286	0.022290
732.6	0.014496	0.357767	0.005186	0.021870
732.7	0.014226	0.357918	0.005092	0.021471
732.8	0.012822	0.358069	0.004591	0.019360
732.9	0.011237	0.358219	0.004025	0.016974
733.0	0.009900	0.358370	0.003548	0.014961
733.1	0.009789	0.358528	0.003510	0.014800
733.2	0.009678	0.358686	0.003471	0.014638
733.3	0.009567	0.358843	0.003433	0.014476
733.4	0.009456	0.359001	0.003395	0.014315
733.5	0.009344	0.359159	0.003356	0.014152
733.6	0.009233	0.359317	0.003318	0.013990
733.7	0.009122	0.359475	0.003279	0.013828
733.8	0.009011	0.359633	0.003241	0.013666
733.9	0.008900	0.359791	0.003202	0.013503
734.0	0.008789	0.359949	0.003164	0.013340
734.1	0.008678	0.359991	0.003124	0.013173

734.2	0.008567	0.360032	0.003084	0.013006
734.3	0.008456	0.360073	0.003045	0.012839
734.4	0.008344	0.360114	0.003005	0.012672
734.5	0.008233	0.360154	0.002965	0.012504
734.6	0.008122	0.360195	0.002926	0.012337
734.7	0.008011	0.360236	0.002886	0.012170
734.8	0.007900	0.360277	0.002846	0.012002
734.9	0.007789	0.360318	0.002806	0.011835
735.0	0.007678	0.360365	0.002767	0.011667
735.1	0.007567	0.360412	0.002727	0.011500
735.2	0.007456	0.360459	0.002687	0.011333
735.3	0.007344	0.360506	0.002648	0.011165
735.4	0.007233	0.360553	0.002608	0.010998
735.5	0.007122	0.360600	0.002568	0.010830
735.6	0.007011	0.360647	0.002529	0.010663
735.7	0.006900	0.360694	0.002489	0.010495
735.8	0.006789	0.360741	0.002449	0.010327
735.9	0.006678	0.360788	0.002409	0.010160
736.0	0.006567	0.360835	0.002369	0.009992
736.1	0.006456	0.360841	0.002329	0.009823
736.2	0.006344	0.360848	0.002289	0.009654
736.3	0.006233	0.360854	0.002249	0.009485
736.4	0.006122	0.360861	0.002209	0.009316
736.5	0.006011	0.360868	0.002169	0.009147
736.6	0.005900	0.360874	0.002129	0.008978
736.7	0.005789	0.360881	0.002089	0.008810
736.8	0.005678	0.360888	0.002049	0.008641
736.9	0.005567	0.360898	0.002009	0.008472
737.0	0.005456	0.360912	0.001969	0.008303
737.1	0.005344	0.360925	0.001929	0.008134
737.2	0.005233	0.360938	0.001889	0.007965
737.3	0.005122	0.360951	0.001849	0.007796
737.4	0.005011	0.360964	0.001809	0.007628
737.5	0.004900	0.360977	0.001769	0.007459
737.6	0.004789	0.360990	0.001729	0.007290
737.7	0.004678	0.361003	0.001689	0.007121
737.8	0.004567	0.361016	0.001649	0.006952
737.9	0.004456	0.361030	0.001609	0.006783
738.0	0.004344	0.361044	0.001569	0.006614
738.1	0.004233	0.361169	0.001529	0.006447
738.2	0.004122	0.361294	0.001489	0.006280
738.3	0.004011	0.361420	0.001450	0.006113
738.4	0.003900	0.361545	0.001410	0.005946

738.5	0.003789	0.361671	0.001370	0.005779
738.6	0.003678	0.361796	0.001331	0.005611
738.7	0.003567	0.361922	0.001291	0.005443
738.8	0.003456	0.362049	0.001251	0.005276
738.9	0.003344	0.362181	0.001211	0.005108
739.0	0.003233	0.362313	0.001171	0.004940
739.1	0.003122	0.362445	0.001132	0.004772
739.2	0.003011	0.362578	0.001092	0.004604
739.3	0.002900	0.362710	0.001052	0.004436
739.4	0.002789	0.362843	0.001012	0.004267
739.5	0.002678	0.362975	0.000972	0.004099
739.6	0.002567	0.363108	0.000932	0.003930
739.7	0.002456	0.363241	0.000892	0.003761
739.8	0.002344	0.363374	0.000852	0.003592
739.9	0.002233	0.363507	0.000812	0.003423
740.0	0.002122	0.363640	0.000772	0.003254
740.1	0.002011	0.363779	0.000732	0.003085
740.2	0.001900	0.363918	0.000691	0.002916
740.3	0.001789	0.364057	0.000651	0.002746
740.4	0.001678	0.364197	0.000611	0.002577
740.5	0.001567	0.364336	0.000571	0.002407
740.6	0.001456	0.364476	0.000531	0.002237
740.7	0.001344	0.364616	0.000490	0.002067
740.8	0.001233	0.364760	0.000450	0.001897
740.9	0.001122	0.364906	0.000409	0.001727
741.0	0.001011	0.365051	0.000369	0.001556
741.1	0.000586	0.365196	0.000214	0.000902
741.2	0.000057	0.365340	0.000021	0.000088
741.3	0.000000	0.365485	0.000000	0.000000
Channel 6				
Wavenumber	HIRS Filter Transmittance	Optical Element Transmittance	Product of the HIRS Filter and Optical Element Transmittances	Normalized Value of Column 4
705.1	0.000597	0.335270	0.000200	0.000790
705.2	0.001000	0.335457	0.000335	0.001324
705.3	0.001114	0.335643	0.000374	0.001476
705.4	0.001228	0.335830	0.000412	0.001628
705.5	0.001342	0.336016	0.000451	0.001780
705.6	0.001456	0.336202	0.000489	0.001932
705.7	0.001570	0.336387	0.000528	0.002085
705.8	0.001684	0.336573	0.000567	0.002237

705.9	0.001798	0.336758	0.000605	0.002390
706.0	0.001911	0.336943	0.000644	0.002543
706.1	0.002025	0.337074	0.000683	0.002695
706.2	0.002139	0.337204	0.000721	0.002848
706.3	0.002253	0.337334	0.000760	0.003001
706.4	0.002367	0.337463	0.000799	0.003154
706.5	0.002481	0.337593	0.000838	0.003307
706.6	0.002595	0.337722	0.000876	0.003460
706.7	0.002709	0.337850	0.000915	0.003613
706.8	0.002823	0.337979	0.000954	0.003767
706.9	0.002937	0.338108	0.000993	0.003920
707.0	0.003051	0.338237	0.001032	0.004074
707.1	0.003165	0.338363	0.001071	0.004228
707.2	0.003279	0.338489	0.001110	0.004381
707.3	0.003392	0.338615	0.001149	0.004535
707.4	0.003506	0.338741	0.001188	0.004689
707.5	0.003620	0.338866	0.001227	0.004844
707.6	0.003734	0.338992	0.001266	0.004998
707.7	0.003848	0.339118	0.001305	0.005152
707.8	0.003962	0.339244	0.001344	0.005307
707.9	0.004076	0.339370	0.001383	0.005461
708.0	0.004190	0.339500	0.001422	0.005616
708.1	0.004304	0.339548	0.001461	0.005770
708.2	0.004418	0.339597	0.001500	0.005923
708.3	0.004532	0.339645	0.001539	0.006077
708.4	0.004646	0.339693	0.001578	0.006230
708.5	0.004759	0.339741	0.001617	0.006384
708.6	0.004873	0.339789	0.001656	0.006538
708.7	0.004987	0.339838	0.001695	0.006692
708.8	0.005101	0.339886	0.001734	0.006845
708.9	0.005215	0.339934	0.001773	0.006999
709.0	0.005329	0.339983	0.001812	0.007153
709.1	0.005443	0.340026	0.001851	0.007307
709.2	0.005557	0.340068	0.001890	0.007461
709.3	0.005671	0.340111	0.001929	0.007615
709.4	0.005785	0.340154	0.001968	0.007769
709.5	0.005899	0.340197	0.002007	0.007923
709.6	0.006013	0.340240	0.002046	0.008077
709.7	0.006127	0.340283	0.002085	0.008231
709.8	0.006241	0.340326	0.002124	0.008385
709.9	0.006354	0.340372	0.002163	0.008539
710.0	0.006468	0.340420	0.002202	0.008694
710.1	0.006582	0.340578	0.002242	0.008851

710.2	0.006696	0.340737	0.002282	0.009008
710.3	0.006810	0.340895	0.002322	0.009166
710.4	0.006924	0.341053	0.002361	0.009323
710.5	0.007038	0.341212	0.002401	0.009481
710.6	0.007152	0.341370	0.002441	0.009639
710.7	0.007266	0.341529	0.002481	0.009797
710.8	0.007380	0.341687	0.002522	0.009955
710.9	0.007494	0.341846	0.002562	0.010114
711.0	0.007608	0.342004	0.002602	0.010272
711.1	0.007722	0.342158	0.002642	0.010431
711.2	0.007835	0.342312	0.002682	0.010589
711.3	0.007949	0.342466	0.002722	0.010748
711.4	0.008063	0.342621	0.002763	0.010907
711.5	0.008177	0.342775	0.002803	0.011066
711.6	0.008291	0.342929	0.002843	0.011225
711.7	0.008405	0.343083	0.002884	0.011385
711.8	0.008519	0.343238	0.002924	0.011544
711.9	0.008633	0.343399	0.002965	0.011704
712.0	0.008747	0.343560	0.003005	0.011864
712.1	0.008861	0.343696	0.003045	0.012024
712.2	0.008975	0.343832	0.003086	0.012183
712.3	0.009089	0.343968	0.003126	0.012343
712.4	0.009203	0.344104	0.003167	0.012502
712.5	0.009317	0.344241	0.003207	0.012662
712.6	0.009430	0.344377	0.003248	0.012822
712.7	0.009544	0.344514	0.003288	0.012982
712.8	0.009658	0.344650	0.003329	0.013142
712.9	0.009772	0.344787	0.003369	0.013302
713.0	0.009886	0.344924	0.003410	0.013463
713.1	0.010000	0.345063	0.003451	0.013623
713.2	0.010366	0.345201	0.003578	0.014128
713.3	0.010772	0.345340	0.003720	0.014687
713.4	0.011198	0.345479	0.003869	0.015274
713.5	0.011624	0.345619	0.004017	0.015861
713.6	0.012031	0.345759	0.004160	0.016423
713.7	0.012400	0.345899	0.004289	0.016934
713.8	0.012590	0.346046	0.004357	0.017201
713.9	0.012714	0.346195	0.004402	0.017378
714.0	0.012804	0.346343	0.004435	0.017508
714.1	0.012889	0.346420	0.004465	0.017628
714.2	0.013000	0.346496	0.004504	0.017784
714.3	0.013160	0.346573	0.004561	0.018007
714.4	0.013358	0.346650	0.004631	0.018282

714.5	0.013577	0.346727	0.004708	0.018586
714.6	0.013797	0.346804	0.004785	0.018891
714.7	0.014000	0.346881	0.004856	0.019173
714.8	0.014176	0.346958	0.004918	0.019419
714.9	0.014345	0.347035	0.004978	0.019655
715.0	0.014536	0.347111	0.005046	0.019921
715.1	0.014778	0.347189	0.005131	0.020257
715.2	0.015100	0.347267	0.005244	0.020703
715.3	0.015520	0.347344	0.005391	0.021283
715.4	0.016019	0.347421	0.005565	0.021973
715.5	0.016568	0.347499	0.005757	0.022731
715.6	0.017138	0.347576	0.005957	0.023518
715.7	0.017700	0.347658	0.006154	0.024295
715.8	0.018235	0.347743	0.006341	0.025035
715.9	0.018762	0.347828	0.006526	0.025765
716.0	0.019312	0.347913	0.006719	0.026527
716.1	0.019915	0.347914	0.006929	0.027355
716.2	0.020600	0.347915	0.007167	0.028296
716.3	0.021397	0.347916	0.007444	0.029391
716.4	0.022331	0.347917	0.007769	0.030674
716.5	0.023427	0.347918	0.008151	0.032180
716.6	0.024708	0.347919	0.008596	0.033939
716.7	0.026200	0.347920	0.009116	0.035989
716.8	0.027913	0.347921	0.009712	0.038342
716.9	0.029805	0.347921	0.010370	0.040941
717.0	0.031820	0.347922	0.011071	0.043709
717.1	0.033904	0.347924	0.011796	0.046572
717.2	0.036000	0.347926	0.012525	0.049451
717.3	0.038064	0.347928	0.013244	0.052287
717.4	0.040096	0.347930	0.013951	0.055079
717.5	0.042105	0.347932	0.014650	0.057839
717.6	0.044103	0.347938	0.015345	0.060584
717.7	0.046100	0.347948	0.016040	0.063329
717.8	0.048102	0.347959	0.016738	0.066082
717.9	0.050098	0.347970	0.017433	0.068826
718.0	0.052073	0.347980	0.018120	0.071541
718.1	0.054012	0.348149	0.018804	0.074241
718.2	0.055900	0.348317	0.019471	0.076873
718.3	0.057731	0.348485	0.020118	0.079430
718.4	0.059530	0.348653	0.020755	0.081944
718.5	0.061335	0.348821	0.021395	0.084470
718.6	0.063180	0.348989	0.022049	0.087052
718.7	0.065100	0.349158	0.022730	0.089741

718.8	0.067127	0.349326	0.023449	0.092580
718.9	0.069278	0.349494	0.024212	0.095593
719.0	0.071566	0.349662	0.025024	0.098797
719.1	0.074002	0.349830	0.025888	0.102209
719.2	0.076600	0.349997	0.026810	0.105848
719.3	0.079367	0.350165	0.027792	0.109724
719.4	0.082289	0.350334	0.028829	0.113818
719.5	0.085348	0.350503	0.029915	0.118106
719.6	0.088525	0.350680	0.031044	0.122565
719.7	0.091800	0.350857	0.032209	0.127163
719.8	0.095160	0.351034	0.033404	0.131884
719.9	0.098609	0.351212	0.034633	0.136733
720.0	0.102160	0.351389	0.035898	0.141729
720.1	0.105820	0.351398	0.037185	0.146810
720.2	0.109600	0.351408	0.038514	0.152059
720.3	0.113510	0.351418	0.039889	0.157488
720.4	0.117560	0.351428	0.041314	0.163112
720.5	0.121750	0.351438	0.042788	0.168930
720.6	0.126100	0.351447	0.044318	0.174970
720.7	0.130600	0.351457	0.045900	0.181219
720.8	0.135270	0.351467	0.047543	0.187705
720.9	0.140110	0.351477	0.049245	0.194426
721.0	0.145120	0.351486	0.051008	0.201384
721.1	0.150320	0.351495	0.052837	0.208605
721.2	0.155700	0.351503	0.054729	0.216076
721.3	0.161270	0.351512	0.056688	0.223812
721.4	0.167030	0.351520	0.058714	0.231811
721.5	0.172940	0.351536	0.060795	0.240024
721.6	0.179000	0.351554	0.062928	0.248447
721.7	0.185200	0.351571	0.065111	0.257066
721.8	0.191520	0.351589	0.067336	0.265851
721.9	0.197950	0.351606	0.069600	0.274790
722.0	0.204510	0.351624	0.071911	0.283911
722.1	0.211190	0.351604	0.074255	0.293168
722.2	0.218000	0.351585	0.076646	0.302605
722.3	0.224930	0.351566	0.079078	0.312207
722.4	0.231960	0.351546	0.081545	0.321947
722.5	0.239080	0.351526	0.084043	0.331811
722.6	0.246270	0.351507	0.086566	0.341770
722.7	0.253500	0.351487	0.089102	0.351784
722.8	0.260760	0.351467	0.091648	0.361838
722.9	0.268050	0.351447	0.094205	0.371933
723.0	0.275370	0.351427	0.096772	0.382068

723.1	0.282720	0.351408	0.099350	0.392245
723.2	0.290100	0.351389	0.101938	0.402462
723.3	0.297510	0.351369	0.104536	0.412719
723.4	0.304970	0.351355	0.107153	0.423051
723.5	0.312480	0.351345	0.109788	0.433457
723.6	0.320050	0.351336	0.112445	0.443945
723.7	0.327700	0.351326	0.115129	0.454544
723.8	0.335430	0.351316	0.117842	0.465253
723.9	0.343210	0.351307	0.120572	0.476031
724.0	0.351020	0.351297	0.123312	0.486851
724.1	0.358820	0.351381	0.126083	0.497788
724.2	0.366600	0.351465	0.128847	0.508702
724.3	0.374320	0.351548	0.131592	0.519538
724.4	0.381970	0.351632	0.134313	0.530282
724.5	0.389560	0.351716	0.137015	0.540948
724.6	0.397070	0.351800	0.139689	0.551508
724.7	0.404500	0.351884	0.142337	0.561962
724.8	0.411850	0.351968	0.144958	0.572310
724.9	0.419100	0.352052	0.147545	0.582523
725.0	0.426250	0.352135	0.150098	0.592602
725.1	0.433290	0.352219	0.152613	0.602533
725.2	0.440200	0.352303	0.155084	0.612288
725.3	0.446980	0.352389	0.157511	0.621870
725.4	0.453640	0.352482	0.159900	0.631303
725.5	0.460200	0.352576	0.162255	0.640602
725.6	0.466680	0.352670	0.164584	0.649795
725.7	0.473100	0.352763	0.166892	0.658909
725.8	0.479470	0.352857	0.169184	0.667959
725.9	0.485780	0.352951	0.171457	0.676930
726.0	0.492010	0.353045	0.173702	0.685794
726.1	0.498160	0.353156	0.175928	0.694584
726.2	0.504200	0.353267	0.178117	0.703227
726.3	0.510120	0.353378	0.180265	0.711707
726.4	0.515920	0.353490	0.182372	0.720026
726.5	0.521580	0.353601	0.184431	0.728154
726.6	0.527110	0.353712	0.186445	0.736107
726.7	0.532500	0.353824	0.188411	0.743868
726.8	0.537740	0.353936	0.190325	0.751426
726.9	0.542810	0.354048	0.192181	0.758750
727.0	0.547670	0.354160	0.193963	0.765786
727.1	0.552310	0.354270	0.195667	0.772515
727.2	0.556700	0.354381	0.197284	0.778898
727.3	0.560810	0.354500	0.198807	0.784913

727.4	0.564670	0.354621	0.200244	0.790584
727.5	0.568300	0.354741	0.201599	0.795936
727.6	0.571740	0.354861	0.202888	0.801026
727.7	0.575000	0.354982	0.204114	0.805866
727.8	0.578130	0.355102	0.205295	0.810528
727.9	0.581170	0.355222	0.206445	0.815066
728.0	0.584190	0.355343	0.207588	0.819578
728.1	0.587240	0.355421	0.208717	0.824039
728.2	0.590400	0.355499	0.209887	0.828655
728.3	0.593690	0.355577	0.211102	0.833456
728.4	0.597080	0.355655	0.212354	0.838398
728.5	0.600500	0.355732	0.213617	0.843384
728.6	0.603900	0.355809	0.214873	0.848343
728.7	0.607200	0.355887	0.216094	0.853164
728.8	0.610360	0.355963	0.217266	0.857789
728.9	0.613350	0.356040	0.218377	0.862176
729.0	0.616180	0.356116	0.219432	0.866340
729.1	0.618830	0.356190	0.220421	0.870246
729.2	0.621300	0.356269	0.221350	0.873914
729.3	0.623580	0.356352	0.222214	0.877325
729.4	0.625710	0.356435	0.223025	0.880526
729.5	0.627720	0.356517	0.223793	0.883559
729.6	0.629640	0.356599	0.224529	0.886466
729.7	0.631500	0.356682	0.225245	0.889290
729.8	0.633340	0.356764	0.225953	0.892087
729.9	0.635200	0.356846	0.226668	0.894911
730.0	0.637110	0.356927	0.227402	0.897808
730.1	0.639090	0.356921	0.228105	0.900583
730.2	0.641200	0.356916	0.228854	0.903542
730.3	0.643440	0.356909	0.229650	0.906683
730.4	0.645770	0.356903	0.230477	0.909949
730.5	0.648120	0.356896	0.231312	0.913244
730.6	0.650410	0.356890	0.232125	0.916455
730.7	0.652600	0.356884	0.232902	0.919524
730.8	0.654620	0.356877	0.233619	0.922354
730.9	0.656480	0.356871	0.234278	0.924957
731.0	0.658200	0.356864	0.234888	0.927362
731.1	0.659800	0.356859	0.235455	0.929603
731.2	0.661300	0.356860	0.235992	0.931720
731.3	0.662720	0.356861	0.236499	0.933724
731.4	0.664090	0.356862	0.236989	0.935657
731.5	0.665430	0.356863	0.237467	0.937547
731.6	0.666760	0.356864	0.237943	0.939423

731.7	0.668100	0.356865	0.238421	0.941313
731.8	0.669470	0.356865	0.238911	0.943245
731.9	0.670870	0.356866	0.239411	0.945219
732.0	0.672280	0.356866	0.239914	0.947207
732.1	0.673690	0.357016	0.240518	0.949592
732.2	0.675100	0.357166	0.241123	0.951979
732.3	0.676490	0.357316	0.241721	0.954340
732.4	0.677900	0.357466	0.242326	0.956731
732.5	0.679350	0.357617	0.242947	0.959181
732.6	0.680870	0.357767	0.243593	0.961732
732.7	0.682500	0.357918	0.244279	0.964440
732.8	0.684260	0.358069	0.245012	0.967335
732.9	0.686130	0.358219	0.245785	0.970386
733.0	0.688100	0.358370	0.246594	0.973582
733.1	0.690130	0.358528	0.247431	0.976884
733.2	0.692200	0.358686	0.248282	0.980245
733.3	0.694280	0.358843	0.249138	0.983623
733.4	0.696310	0.359001	0.249976	0.986933
733.5	0.698210	0.359159	0.250768	0.990061
733.6	0.699890	0.359317	0.251482	0.992880
733.7	0.701300	0.359475	0.252100	0.995318
733.8	0.702360	0.359633	0.252592	0.997260
733.9	0.703090	0.359791	0.252966	0.998736
734.0	0.703490	0.359949	0.253221	0.999744
734.1	0.703590	0.359991	0.253286	1.000000
734.2	0.703400	0.360032	0.253246	0.999844
734.3	0.702950	0.360073	0.253113	0.999318
734.4	0.702290	0.360114	0.252904	0.998493
734.5	0.701440	0.360154	0.252627	0.997398
734.6	0.700460	0.360195	0.252302	0.996118
734.7	0.699400	0.360236	0.251949	0.994723
734.8	0.698270	0.360277	0.251571	0.993229
734.9	0.697040	0.360318	0.251156	0.991592
735.0	0.695620	0.360365	0.250677	0.989701
735.1	0.693970	0.360412	0.250115	0.987481
735.2	0.692000	0.360459	0.249437	0.984806
735.3	0.689670	0.360506	0.248630	0.981618
735.4	0.686940	0.360553	0.247678	0.977860
735.5	0.683800	0.360600	0.246578	0.973517
735.6	0.680230	0.360647	0.245323	0.968561
735.7	0.676200	0.360694	0.243901	0.962948
735.8	0.671710	0.360741	0.242313	0.956678
735.9	0.666740	0.360788	0.240552	0.949724

736.0	0.661300	0.360835	0.238620	0.942099
736.1	0.655390	0.360841	0.236492	0.933696
736.2	0.649000	0.360848	0.234190	0.924609
736.3	0.642140	0.360854	0.231719	0.914852
736.4	0.634820	0.360861	0.229082	0.904440
736.5	0.627070	0.360868	0.226289	0.893415
736.6	0.618930	0.360874	0.223356	0.881834
736.7	0.610400	0.360881	0.220282	0.869697
736.8	0.601510	0.360888	0.217078	0.857047
736.9	0.592260	0.360898	0.213746	0.843891
737.0	0.582630	0.360912	0.210278	0.830201
737.1	0.572620	0.360925	0.206673	0.815967
737.2	0.562200	0.360938	0.202919	0.801147
737.3	0.551380	0.360951	0.199021	0.785757
737.4	0.540210	0.360964	0.194996	0.769867
737.5	0.528740	0.360977	0.190863	0.753547
737.6	0.517010	0.360990	0.186635	0.736857
737.7	0.505100	0.361003	0.182343	0.719909
737.8	0.493040	0.361016	0.177996	0.702746
737.9	0.480870	0.361030	0.173609	0.685425
738.0	0.468590	0.361044	0.169181	0.667947
738.1	0.456230	0.361169	0.164776	0.650554
738.2	0.443800	0.361294	0.160342	0.633049
738.3	0.431330	0.361420	0.155891	0.615475
738.4	0.418850	0.361545	0.151433	0.597875
738.5	0.406410	0.361671	0.146987	0.580319
738.6	0.394040	0.361796	0.142562	0.562851
738.7	0.381800	0.361922	0.138182	0.545557
738.8	0.369710	0.362049	0.133853	0.528467
738.9	0.357790	0.362181	0.129585	0.511615
739.0	0.346040	0.362313	0.125375	0.494994
739.1	0.334480	0.362445	0.121231	0.478632
739.2	0.323100	0.362578	0.117149	0.462517
739.3	0.311910	0.362710	0.113133	0.446661
739.4	0.300910	0.362843	0.109183	0.431067
739.5	0.290060	0.362975	0.105285	0.415675
739.6	0.279370	0.363108	0.101442	0.400502
739.7	0.268800	0.363241	0.097639	0.385490
739.8	0.258350	0.363374	0.093878	0.370639
739.9	0.248050	0.363507	0.090168	0.355993
740.0	0.237900	0.363640	0.086510	0.341551
740.1	0.227950	0.363779	0.082923	0.327391
740.2	0.218200	0.363918	0.079407	0.313507

740.3	0.208690	0.364057	0.075975	0.299958
740.4	0.199410	0.364197	0.072624	0.286729
740.5	0.190390	0.364336	0.069366	0.273864
740.6	0.181620	0.364476	0.066196	0.261350
740.7	0.173100	0.364616	0.063115	0.249185
740.8	0.164850	0.364760	0.060131	0.237403
740.9	0.156920	0.364906	0.057261	0.226073
741.0	0.149350	0.365051	0.054520	0.215252
741.1	0.142200	0.365196	0.051931	0.205028
741.2	0.135500	0.365340	0.049504	0.195446
741.3	0.129300	0.365485	0.047257	0.186577
741.4	0.123540	0.365630	0.045170	0.178336
741.5	0.118170	0.365776	0.043224	0.170652
741.6	0.113110	0.365921	0.041389	0.163410
741.7	0.108300	0.366067	0.039645	0.156523
741.8	0.103690	0.366212	0.037973	0.149920
741.9	0.099253	0.366358	0.036362	0.143562
742.0	0.094983	0.366503	0.034812	0.137440
742.1	0.090869	0.366665	0.033319	0.131545
742.2	0.086900	0.366828	0.031877	0.125855
742.3	0.083072	0.366990	0.030487	0.120364
742.4	0.079409	0.367152	0.029155	0.115108
742.5	0.075940	0.367315	0.027894	0.110128
742.6	0.072693	0.367477	0.026713	0.105466
742.7	0.069700	0.367643	0.025625	0.101169
742.8	0.066977	0.367810	0.024635	0.097261
742.9	0.064496	0.367977	0.023733	0.093701
743.0	0.062216	0.368144	0.022904	0.090429
743.1	0.060098	0.368310	0.022135	0.087390
743.2	0.058100	0.368476	0.021408	0.084523
743.3	0.056184	0.368642	0.020712	0.081772
743.4	0.054317	0.368808	0.020033	0.079091
743.5	0.052469	0.368974	0.019360	0.076434
743.6	0.050607	0.369141	0.018681	0.073755
743.7	0.048700	0.369307	0.017985	0.071008
743.8	0.046727	0.369474	0.017264	0.068162
743.9	0.044699	0.369640	0.016523	0.065233
744.0	0.042637	0.369807	0.015767	0.062252
744.1	0.040564	0.370003	0.015009	0.059256
744.2	0.038500	0.370198	0.014253	0.056271
744.3	0.036471	0.370394	0.013509	0.053334
744.4	0.034519	0.370590	0.012792	0.050506
744.5	0.032692	0.370786	0.012122	0.047858

744.6	0.031036	0.370983	0.011514	0.045458
744.7	0.029600	0.371182	0.010987	0.043378
744.8	0.028411	0.371382	0.010551	0.041658
744.9	0.027422	0.371582	0.010190	0.040229
745.0	0.026568	0.371781	0.009877	0.038997
745.1	0.025782	0.371980	0.009590	0.037864
745.2	0.025000	0.372179	0.009304	0.036735
745.3	0.024169	0.372378	0.009000	0.035533
745.4	0.023294	0.372577	0.008679	0.034265
745.5	0.022395	0.372776	0.008348	0.032960
745.6	0.021491	0.372975	0.008016	0.031646
745.7	0.020600	0.373174	0.007687	0.030351
745.8	0.019742	0.373373	0.007371	0.029102
745.9	0.018935	0.373573	0.007074	0.027927
746.0	0.018197	0.373772	0.006802	0.026853
746.1	0.017546	0.373885	0.006560	0.025900
746.2	0.017000	0.373999	0.006358	0.025102
746.3	0.016565	0.374112	0.006197	0.024467
746.4	0.016200	0.374225	0.006062	0.023935
746.5	0.015853	0.374338	0.005934	0.023430
746.6	0.015470	0.374453	0.005793	0.022871
746.7	0.015000	0.374568	0.005619	0.022183
746.8	0.014306	0.374683	0.005360	0.021163
746.9	0.013540	0.374798	0.005075	0.020036
747.0	0.012780	0.374913	0.004791	0.018917
747.1	0.012107	0.375028	0.004540	0.017926
747.2	0.011600	0.375143	0.004352	0.017181
747.3	0.011500	0.375258	0.004315	0.017038
747.4	0.011400	0.375373	0.004279	0.016895
747.5	0.011300	0.375488	0.004243	0.016752
747.6	0.011200	0.375603	0.004207	0.016609
747.7	0.011100	0.375718	0.004170	0.016465
747.8	0.011000	0.375834	0.004134	0.016322
747.9	0.010900	0.375949	0.004098	0.016179
748.0	0.010800	0.376063	0.004061	0.016035
748.1	0.010700	0.376320	0.004027	0.015898
748.2	0.010600	0.376577	0.003992	0.015760
748.3	0.010500	0.376834	0.003957	0.015622
748.4	0.010400	0.377092	0.003922	0.015484
748.5	0.010300	0.377350	0.003887	0.015345
748.6	0.010200	0.377608	0.003852	0.015207
748.7	0.010100	0.377866	0.003816	0.015068
748.8	0.010000	0.378124	0.003781	0.014929

748.9	0.009875	0.378383	0.003737	0.014752
749.0	0.009750	0.378641	0.003692	0.014575
749.1	0.009625	0.378901	0.003647	0.014398
749.2	0.009500	0.379161	0.003602	0.014221
749.3	0.009375	0.379420	0.003557	0.014044
749.4	0.009250	0.379680	0.003512	0.013866
749.5	0.009125	0.379940	0.003467	0.013688
749.6	0.009000	0.380200	0.003422	0.013510
749.7	0.008875	0.380460	0.003377	0.013331
749.8	0.008750	0.380720	0.003331	0.013152
749.9	0.008625	0.380980	0.003286	0.012973
750.0	0.008500	0.381240	0.003241	0.012794
750.1	0.008375	0.381383	0.003194	0.012611
750.2	0.008250	0.381526	0.003148	0.012427
750.3	0.008125	0.381669	0.003101	0.012243
750.4	0.008000	0.381812	0.003054	0.012059
750.5	0.007875	0.381954	0.003008	0.011875
750.6	0.007750	0.382097	0.002961	0.011691
750.7	0.007625	0.382240	0.002915	0.011507
750.8	0.007500	0.382382	0.002868	0.011323
750.9	0.007375	0.382525	0.002821	0.011138
751.0	0.007250	0.382668	0.002774	0.010953
751.1	0.007125	0.382810	0.002728	0.010769
751.2	0.007000	0.382952	0.002681	0.010584
751.3	0.006875	0.383095	0.002634	0.010398
751.4	0.006750	0.383237	0.002587	0.010213
751.5	0.006625	0.383379	0.002540	0.010028
751.6	0.006500	0.383522	0.002493	0.009842
751.7	0.006375	0.383665	0.002446	0.009657
751.8	0.006250	0.383807	0.002399	0.009471
751.9	0.006125	0.383950	0.002352	0.009285
752.0	0.006000	0.384093	0.002305	0.009099
752.1	0.005875	0.384283	0.002258	0.008913
752.2	0.005750	0.384473	0.002211	0.008728
752.3	0.005625	0.384663	0.002164	0.008543
752.4	0.005500	0.384852	0.002117	0.008357
752.5	0.005375	0.385041	0.002070	0.008171
752.6	0.005250	0.385231	0.002022	0.007985
752.7	0.005125	0.385420	0.001975	0.007799
752.8	0.005000	0.385608	0.001928	0.007612
752.9	0.004875	0.385797	0.001881	0.007425
753.0	0.004750	0.385985	0.001833	0.007239
753.1	0.004625	0.386172	0.001786	0.007051

753.2	0.004500	0.386358	0.001739	0.006864
753.3	0.004375	0.386543	0.001691	0.006677
753.4	0.004250	0.386729	0.001644	0.006489
753.5	0.004125	0.386914	0.001596	0.006301
753.6	0.004000	0.387099	0.001548	0.006113
753.7	0.003875	0.387284	0.001501	0.005925
753.8	0.003750	0.387468	0.001453	0.005737
753.9	0.003625	0.387653	0.001405	0.005548
754.0	0.003500	0.387837	0.001357	0.005359
754.1	0.003375	0.387953	0.001309	0.005169
754.2	0.003250	0.388069	0.001261	0.004979
754.3	0.003125	0.388181	0.001213	0.004789
754.4	0.003000	0.388294	0.001165	0.004599
754.5	0.002875	0.388407	0.001117	0.004409
754.6	0.002750	0.388519	0.001068	0.004218
754.7	0.002625	0.388632	0.001020	0.004028
754.8	0.002500	0.388744	0.000972	0.003837
754.9	0.002375	0.388857	0.000924	0.003646
755.0	0.002250	0.388969	0.000875	0.003455
755.1	0.002125	0.389077	0.000827	0.003264
755.2	0.002000	0.389185	0.000778	0.003073
755.3	0.001875	0.389293	0.000730	0.002882
755.4	0.001750	0.389402	0.000681	0.002690
755.5	0.001625	0.389510	0.000633	0.002499
755.6	0.001500	0.389619	0.000596	0.002354
755.7	0.001420	0.389727	0.000553	0.002185
755.8	0.001295	0.389836	0.000505	0.001993
755.9	0.001155	0.389945	0.000450	0.001778
756.0	0.001000	0.390053	0.000390	0.001540
756.1	0.000830	0.390369	0.000324	0.001279
756.2	0.000645	0.390682	0.000252	0.000995
756.3	0.000445	0.390994	0.000174	0.000687
756.4	0.000230	0.391306	0.000090	0.000355
756.5	0.000000	0.391618	0.000000	0.000000
Channel 7				
Wavenumber	HIRS Filter Transmittance	Optical Element Transmittance	Product of the HIRS Filter and Optical Element Transmittances	Normalized Value of Column 4
716.6	0.000034	0.347919	0.000012	0.000039
716.7	0.000143	0.347920	0.000050	0.000165
716.8	0.000270	0.347921	0.000094	0.000310
716.9	0.000407	0.347921	0.000142	0.000469

717.0	0.000551	0.347922	0.000192	0.000635
717.1	0.000696	0.347924	0.000242	0.000802
717.2	0.000839	0.347926	0.000292	0.000967
717.3	0.000976	0.347928	0.000339	0.001123
717.4	0.001101	0.347930	0.000383	0.001268
717.5	0.001212	0.347932	0.000422	0.001395
717.6	0.001303	0.347938	0.000454	0.001501
717.7	0.001372	0.347948	0.000477	0.001580
717.8	0.001414	0.347959	0.000492	0.001629
717.9	0.001425	0.347970	0.000496	0.001641
718.0	0.001401	0.347980	0.000488	0.001614
718.1	0.001340	0.348149	0.000466	0.001544
718.2	0.001249	0.348317	0.000435	0.001440
718.3	0.001136	0.348485	0.000396	0.001311
718.4	0.001011	0.348653	0.000353	0.001167
718.5	0.000883	0.348821	0.000308	0.001019
718.6	0.000760	0.348989	0.000265	0.000878
718.7	0.000652	0.349158	0.000228	0.000753
718.8	0.000567	0.349326	0.000198	0.000655
718.9	0.000514	0.349494	0.000180	0.000594
719.0	0.000502	0.349662	0.000176	0.000581
719.1	0.000538	0.349830	0.000188	0.000622
719.2	0.000616	0.349997	0.000215	0.000713
719.3	0.000729	0.350165	0.000255	0.000844
719.4	0.000869	0.350334	0.000304	0.001007
719.5	0.001029	0.350503	0.000361	0.001193
719.6	0.001201	0.350680	0.000421	0.001394
719.7	0.001377	0.350857	0.000483	0.001599
719.8	0.001550	0.351034	0.000544	0.001801
719.9	0.001713	0.351212	0.000602	0.001991
720.0	0.001857	0.351389	0.000653	0.002160
720.1	0.001976	0.351398	0.000695	0.002299
720.2	0.002070	0.351408	0.000727	0.002407
720.3	0.002136	0.351418	0.000750	0.002484
720.4	0.002174	0.351428	0.000764	0.002529
720.5	0.002185	0.351438	0.000768	0.002542
720.6	0.002168	0.351447	0.000762	0.002522
720.7	0.002121	0.351457	0.000746	0.002468
720.8	0.002045	0.351467	0.000719	0.002380
720.9	0.001940	0.351477	0.000682	0.002257
721.0	0.001804	0.351486	0.000634	0.002099
721.1	0.001639	0.351495	0.000576	0.001907
721.2	0.001454	0.351503	0.000511	0.001691

721.3	0.001258	0.351512	0.000442	0.001463
721.4	0.001062	0.351520	0.000373	0.001235
721.5	0.000876	0.351536	0.000308	0.001019
721.6	0.000710	0.351554	0.000249	0.000826
721.7	0.000574	0.351571	0.000202	0.000668
721.8	0.000479	0.351589	0.000168	0.000558
721.9	0.000435	0.351606	0.000153	0.000506
722.0	0.000452	0.351624	0.000159	0.000526
722.1	0.000536	0.351604	0.000189	0.000624
722.2	0.000679	0.351585	0.000239	0.000791
722.3	0.000869	0.351566	0.000306	0.001011
722.4	0.001093	0.351546	0.000384	0.001271
722.5	0.001338	0.351526	0.000470	0.001557
722.6	0.001593	0.351507	0.000560	0.001853
722.7	0.001845	0.351487	0.000648	0.002146
722.8	0.002081	0.351467	0.000731	0.002421
722.9	0.002289	0.351447	0.000805	0.002663
723.0	0.002458	0.351427	0.000864	0.002859
723.1	0.002578	0.351408	0.000906	0.002998
723.2	0.002654	0.351389	0.000933	0.003087
723.3	0.002697	0.351369	0.000948	0.003137
723.4	0.002716	0.351355	0.000954	0.003159
723.5	0.002721	0.351345	0.000956	0.003164
723.6	0.002720	0.351336	0.000956	0.003163
723.7	0.002724	0.351326	0.000957	0.003168
723.8	0.002742	0.351316	0.000963	0.003188
723.9	0.002783	0.351307	0.000978	0.003236
724.0	0.002857	0.351297	0.001004	0.003322
724.1	0.002971	0.351381	0.001044	0.003455
724.2	0.003121	0.351465	0.001097	0.003631
724.3	0.003303	0.351548	0.001161	0.003843
724.4	0.003510	0.351632	0.001234	0.004085
724.5	0.003736	0.351716	0.001314	0.004349
724.6	0.003976	0.351800	0.001399	0.004630
724.7	0.004224	0.351884	0.001486	0.004920
724.8	0.004475	0.351968	0.001575	0.005214
724.9	0.004723	0.352052	0.001663	0.005503
725.0	0.004961	0.352135	0.001747	0.005782
725.1	0.005186	0.352219	0.001827	0.006046
725.2	0.005400	0.352303	0.001902	0.006297
725.3	0.005604	0.352389	0.001975	0.006537
725.4	0.005803	0.352482	0.002045	0.006770
725.5	0.005998	0.352576	0.002115	0.007000

725.6	0.006193	0.352670	0.002184	0.007229
725.7	0.006390	0.352763	0.002254	0.007462
725.8	0.006593	0.352857	0.002326	0.007701
725.9	0.006804	0.352951	0.002402	0.007950
726.0	0.007027	0.353045	0.002481	0.008212
726.1	0.007263	0.353156	0.002565	0.008490
726.2	0.007511	0.353267	0.002653	0.008783
726.3	0.007769	0.353378	0.002745	0.009087
726.4	0.008036	0.353490	0.002841	0.009402
726.5	0.008309	0.353601	0.002938	0.009725
726.6	0.008587	0.353712	0.003037	0.010054
726.7	0.008868	0.353824	0.003138	0.010386
726.8	0.009150	0.353936	0.003239	0.010720
726.9	0.009432	0.354048	0.003339	0.011053
727.0	0.009710	0.354160	0.003439	0.011383
727.1	0.009984	0.354270	0.003537	0.011708
727.2	0.010253	0.354381	0.003633	0.012027
727.3	0.010515	0.354500	0.003728	0.012338
727.4	0.010770	0.354621	0.003819	0.012642
727.5	0.011018	0.354741	0.003909	0.012937
727.6	0.011257	0.354861	0.003995	0.013222
727.7	0.011486	0.354982	0.004077	0.013496
727.8	0.011705	0.355102	0.004156	0.013758
727.9	0.011914	0.355222	0.004232	0.014008
728.0	0.012110	0.355343	0.004303	0.014244
728.1	0.012295	0.355421	0.004370	0.014464
728.2	0.012478	0.355499	0.004436	0.014683
728.3	0.012667	0.355577	0.004504	0.014909
728.4	0.012873	0.355655	0.004578	0.015154
728.5	0.013105	0.355732	0.004662	0.015431
728.6	0.013373	0.355809	0.004758	0.015750
728.7	0.013686	0.355887	0.004871	0.016122
728.8	0.014055	0.355963	0.005003	0.016560
728.9	0.014489	0.356040	0.005159	0.017075
729.0	0.014997	0.356116	0.005341	0.017678
729.1	0.015587	0.356190	0.005552	0.018377
729.2	0.016254	0.356269	0.005791	0.019168
729.3	0.016991	0.356352	0.006055	0.020041
729.4	0.017791	0.356435	0.006341	0.020990
729.5	0.018646	0.356517	0.006648	0.022004
729.6	0.019550	0.356599	0.006972	0.023076
729.7	0.020494	0.356682	0.007310	0.024196
729.8	0.021472	0.356764	0.007660	0.025356

729.9	0.022477	0.356846	0.008021	0.026549
730.0	0.023501	0.356927	0.008388	0.027765
730.1	0.024538	0.356921	0.008758	0.028990
730.2	0.025586	0.356916	0.009132	0.030227
730.3	0.026643	0.356909	0.009509	0.031475
730.4	0.027708	0.356903	0.009889	0.032733
730.5	0.028780	0.356896	0.010271	0.033999
730.6	0.029858	0.356890	0.010656	0.035272
730.7	0.030940	0.356884	0.011042	0.036549
730.8	0.032025	0.356877	0.011429	0.037830
730.9	0.033112	0.356871	0.011817	0.039113
731.0	0.034199	0.356864	0.012204	0.040397
731.1	0.035288	0.356859	0.012593	0.041682
731.2	0.036391	0.356860	0.012986	0.042985
731.3	0.037524	0.356861	0.013391	0.044324
731.4	0.038700	0.356862	0.013811	0.045713
731.5	0.039935	0.356863	0.014251	0.047172
731.6	0.041244	0.356864	0.014718	0.048718
731.7	0.042642	0.356865	0.015217	0.050370
731.8	0.044144	0.356865	0.015753	0.052144
731.9	0.045765	0.356866	0.016332	0.054059
732.0	0.047519	0.356866	0.016958	0.056131
732.1	0.049418	0.357016	0.017643	0.058399
732.2	0.051454	0.357166	0.018378	0.060830
732.3	0.053616	0.357316	0.019158	0.063413
732.4	0.055894	0.357466	0.019980	0.066135
732.5	0.058276	0.357617	0.020840	0.068982
732.6	0.060752	0.357767	0.021735	0.071943
732.7	0.063309	0.357918	0.022659	0.075003
732.8	0.065938	0.358069	0.023610	0.078150
732.9	0.068626	0.358219	0.024583	0.081371
733.0	0.071364	0.358370	0.025575	0.084653
733.1	0.074143	0.358528	0.026582	0.087988
733.2	0.076974	0.358686	0.027609	0.091388
733.3	0.079869	0.358843	0.028660	0.094866
733.4	0.082843	0.359001	0.029741	0.098442
733.5	0.085908	0.359159	0.030855	0.102129
733.6	0.089077	0.359317	0.032007	0.105943
733.7	0.092365	0.359475	0.033203	0.109902
733.8	0.095785	0.359633	0.034447	0.114021
733.9	0.099350	0.359791	0.035745	0.118317
734.0	0.103070	0.359949	0.037100	0.122801
734.1	0.106970	0.359991	0.038508	0.127463

734.2	0.111040	0.360032	0.039978	0.132327
734.3	0.115290	0.360073	0.041513	0.137408
734.4	0.119730	0.360114	0.043116	0.142716
734.5	0.124360	0.360154	0.044789	0.148251
734.6	0.129190	0.360195	0.046534	0.154027
734.7	0.134220	0.360236	0.048351	0.160042
734.8	0.139460	0.360277	0.050244	0.166309
734.9	0.144900	0.360318	0.052210	0.172816
735.0	0.150570	0.360365	0.054260	0.179602
735.1	0.156450	0.360412	0.056386	0.186640
735.2	0.162540	0.360459	0.058589	0.193930
735.3	0.168840	0.360506	0.060868	0.201473
735.4	0.175340	0.360553	0.063219	0.209256
735.5	0.182030	0.360600	0.065640	0.217269
735.6	0.188910	0.360647	0.068130	0.225510
735.7	0.195960	0.360694	0.070682	0.233957
735.8	0.203180	0.360741	0.073295	0.242608
735.9	0.210560	0.360788	0.075967	0.251453
736.0	0.218100	0.360835	0.078698	0.260492
736.1	0.225790	0.360841	0.081474	0.269681
736.2	0.233620	0.360848	0.084301	0.279038
736.3	0.241620	0.360854	0.087190	0.288598
736.4	0.249780	0.360861	0.090136	0.298351
736.5	0.258110	0.360868	0.093144	0.308306
736.6	0.266610	0.360874	0.096213	0.318465
736.7	0.275290	0.360881	0.099347	0.328839
736.8	0.284150	0.360888	0.102546	0.339429
736.9	0.293210	0.360898	0.105819	0.350262
737.0	0.302460	0.360912	0.109161	0.361325
737.1	0.311900	0.360925	0.112572	0.372616
737.2	0.321530	0.360938	0.116052	0.384134
737.3	0.331310	0.360951	0.119587	0.395833
737.4	0.341230	0.360964	0.123172	0.407699
737.5	0.351260	0.360977	0.126797	0.419698
737.6	0.361380	0.360990	0.130455	0.431806
737.7	0.371570	0.361003	0.134138	0.443998
737.8	0.381810	0.361016	0.137840	0.456251
737.9	0.392080	0.361030	0.141553	0.468541
738.0	0.402350	0.361044	0.145266	0.480832
738.1	0.412600	0.361169	0.149018	0.493252
738.2	0.422820	0.361294	0.152762	0.505645
738.3	0.433000	0.361420	0.156495	0.517999
738.4	0.443120	0.361545	0.160208	0.530290

738.5	0.453170	0.361671	0.163898	0.542505
738.6	0.463150	0.361796	0.167566	0.554645
738.7	0.473020	0.361922	0.171196	0.566662
738.8	0.482800	0.362049	0.174797	0.578581
738.9	0.492450	0.362181	0.178356	0.590360
739.0	0.501980	0.362313	0.181874	0.602005
739.1	0.511360	0.362445	0.185340	0.613478
739.2	0.520590	0.362578	0.188754	0.624779
739.3	0.529670	0.362710	0.192117	0.635909
739.4	0.538600	0.362843	0.195427	0.646866
739.5	0.547360	0.362975	0.198678	0.657627
739.6	0.555960	0.363108	0.201874	0.668204
739.7	0.564390	0.363241	0.205009	0.678583
739.8	0.572640	0.363374	0.208082	0.688755
739.9	0.580720	0.363507	0.211096	0.698729
740.0	0.588610	0.363640	0.214042	0.708482
740.1	0.596320	0.363779	0.216929	0.718036
740.2	0.603830	0.363918	0.219745	0.727357
740.3	0.611160	0.364057	0.222497	0.736469
740.4	0.618300	0.364197	0.225183	0.745358
740.5	0.625240	0.364336	0.227798	0.754012
740.6	0.631990	0.364476	0.230345	0.762445
740.7	0.638540	0.364616	0.232822	0.770642
740.8	0.644900	0.364760	0.235234	0.778627
740.9	0.651070	0.364906	0.237579	0.786389
741.0	0.657030	0.365051	0.239849	0.793904
741.1	0.662790	0.365196	0.242048	0.801181
741.2	0.668360	0.365340	0.244179	0.808235
741.3	0.673720	0.365485	0.246235	0.815040
741.4	0.678880	0.365630	0.248219	0.821608
741.5	0.683840	0.365776	0.250132	0.827939
741.6	0.688590	0.365921	0.251970	0.834022
741.7	0.693140	0.366067	0.253735	0.839867
741.8	0.697480	0.366212	0.255426	0.845461
741.9	0.701620	0.366358	0.257044	0.850818
742.0	0.705550	0.366503	0.258587	0.855924
742.1	0.709270	0.366665	0.260065	0.860817
742.2	0.712800	0.366828	0.261475	0.865484
742.3	0.716160	0.366990	0.262823	0.869948
742.4	0.719360	0.367152	0.264115	0.874222
742.5	0.722410	0.367315	0.265352	0.878317
742.6	0.725340	0.367477	0.266546	0.882270
742.7	0.728160	0.367643	0.267703	0.886099

742.8	0.730880	0.367810	0.268825	0.889813
742.9	0.733530	0.367977	0.269922	0.893445
743.0	0.736110	0.368144	0.270994	0.896994
743.1	0.738650	0.368310	0.272052	0.900495
743.2	0.741120	0.368476	0.273085	0.903913
743.3	0.743540	0.368642	0.274100	0.907273
743.4	0.745870	0.368808	0.275083	0.910527
743.5	0.748120	0.368974	0.276037	0.913685
743.6	0.750270	0.369141	0.276955	0.916724
743.7	0.752310	0.369307	0.277833	0.919631
743.8	0.754230	0.369474	0.278668	0.922395
743.9	0.756020	0.369640	0.279456	0.925001
744.0	0.757670	0.369807	0.280192	0.927437
744.1	0.759170	0.370003	0.280895	0.929765
744.2	0.760540	0.370198	0.281551	0.931935
744.3	0.761800	0.370394	0.282166	0.933973
744.4	0.762970	0.370590	0.282749	0.935902
744.5	0.764080	0.370786	0.283310	0.937759
744.6	0.765140	0.370983	0.283854	0.939559
744.7	0.766180	0.371182	0.284392	0.941341
744.8	0.767220	0.371382	0.284932	0.943126
744.9	0.768280	0.371582	0.285479	0.944937
745.0	0.769390	0.371781	0.286045	0.946811
745.1	0.770550	0.371980	0.286629	0.948745
745.2	0.771750	0.372179	0.287229	0.950731
745.3	0.772980	0.372378	0.287840	0.952755
745.4	0.774210	0.372577	0.288453	0.954781
745.5	0.775420	0.372776	0.289058	0.956784
745.6	0.776590	0.372975	0.289648	0.958739
745.7	0.777710	0.373174	0.290221	0.960635
745.8	0.778740	0.373373	0.290761	0.962421
745.9	0.779670	0.373573	0.291263	0.964085
746.0	0.780480	0.373772	0.291722	0.965602
746.1	0.781160	0.373885	0.292064	0.966736
746.2	0.781710	0.373999	0.292358	0.967709
746.3	0.782150	0.374112	0.292611	0.968547
746.4	0.782490	0.374225	0.292827	0.969261
746.5	0.782760	0.374338	0.293017	0.969888
746.6	0.782960	0.374453	0.293182	0.970434
746.7	0.783120	0.374568	0.293332	0.970931
746.8	0.783250	0.374683	0.293470	0.971390
746.9	0.783360	0.374798	0.293602	0.971824
747.0	0.783460	0.374913	0.293729	0.972247

747.1	0.783590	0.375028	0.293868	0.972706
747.2	0.783730	0.375143	0.294011	0.973179
747.3	0.783890	0.375258	0.294161	0.973676
747.4	0.784080	0.375373	0.294322	0.974210
747.5	0.784290	0.375488	0.294492	0.974770
747.6	0.784530	0.375603	0.294672	0.975367
747.7	0.784790	0.375718	0.294860	0.975990
747.8	0.785090	0.375834	0.295063	0.976662
747.9	0.785430	0.375949	0.295281	0.977384
748.0	0.785800	0.376063	0.295511	0.978143
748.1	0.786210	0.376320	0.295867	0.979321
748.2	0.786650	0.376577	0.296234	0.980539
748.3	0.787110	0.376834	0.296610	0.981782
748.4	0.787590	0.377092	0.296994	0.983052
748.5	0.788080	0.377350	0.297382	0.984336
748.6	0.788570	0.377608	0.297770	0.985622
748.7	0.789060	0.377866	0.298159	0.986909
748.8	0.789530	0.378124	0.298540	0.988172
748.9	0.789980	0.378383	0.298915	0.989411
749.0	0.790400	0.378641	0.299278	0.990614
749.1	0.790790	0.378901	0.299631	0.991782
749.2	0.791140	0.379161	0.299969	0.992901
749.3	0.791440	0.379420	0.300288	0.993958
749.4	0.791700	0.379680	0.300593	0.994965
749.5	0.791920	0.379940	0.300882	0.995923
749.6	0.792080	0.380200	0.301149	0.996805
749.7	0.792190	0.380460	0.301396	0.997625
749.8	0.792250	0.380720	0.301625	0.998382
749.9	0.792240	0.380980	0.301828	0.999052
750.0	0.792170	0.381240	0.302007	0.999647
750.1	0.792040	0.381383	0.302071	0.999857
750.2	0.791840	0.381526	0.302108	0.999979
750.3	0.791560	0.381669	0.302114	1.000000
750.4	0.791210	0.381812	0.302093	0.999932
750.5	0.790770	0.381954	0.302038	0.999749
750.6	0.790240	0.382097	0.301948	0.999452
750.7	0.789620	0.382240	0.301824	0.999041
750.8	0.788900	0.382382	0.301661	0.998502
750.9	0.788070	0.382525	0.301456	0.997824
751.0	0.787140	0.382668	0.301213	0.997019
751.1	0.786090	0.382810	0.300923	0.996059
751.2	0.784930	0.382952	0.300591	0.994958
751.3	0.783620	0.383095	0.300201	0.993667

751.4	0.782180	0.383237	0.299760	0.992210
751.5	0.780570	0.383379	0.299254	0.990535
751.6	0.778800	0.383522	0.298687	0.988657
751.7	0.776850	0.383665	0.298050	0.986548
751.8	0.774720	0.383807	0.297343	0.984209
751.9	0.772380	0.383950	0.296555	0.981600
752.0	0.769840	0.384093	0.295690	0.978736
752.1	0.767070	0.384283	0.294772	0.975698
752.2	0.764070	0.384473	0.293764	0.972363
752.3	0.760840	0.384663	0.292667	0.968731
752.4	0.757350	0.384852	0.291468	0.964762
752.5	0.753600	0.385041	0.290167	0.960456
752.6	0.749580	0.385231	0.288761	0.955802
752.7	0.745270	0.385420	0.287242	0.950773
752.8	0.740680	0.385608	0.285612	0.945380
752.9	0.735780	0.385797	0.283862	0.939585
753.0	0.730570	0.385985	0.281989	0.933388
753.1	0.725040	0.386172	0.279990	0.926769
753.2	0.719180	0.386358	0.277861	0.919721
753.3	0.712990	0.386543	0.275601	0.912243
753.4	0.706460	0.386729	0.273208	0.904322
753.5	0.699590	0.386914	0.270681	0.895957
753.6	0.692370	0.387099	0.268016	0.887135
753.7	0.684800	0.387284	0.265212	0.877854
753.8	0.676870	0.387468	0.262266	0.868102
753.9	0.668580	0.387653	0.259177	0.857878
754.0	0.659910	0.387837	0.255938	0.847156
754.1	0.650880	0.387953	0.252511	0.835813
754.2	0.641510	0.388069	0.248950	0.824027
754.3	0.631810	0.388181	0.245257	0.811803
754.4	0.621830	0.388294	0.241453	0.799211
754.5	0.611580	0.388407	0.237542	0.786265
754.6	0.601100	0.388519	0.233539	0.773016
754.7	0.590410	0.388632	0.229452	0.759489
754.8	0.579540	0.388744	0.225293	0.745722
754.9	0.568530	0.388857	0.221077	0.731766
755.0	0.557390	0.388969	0.216808	0.717635
755.1	0.546150	0.389077	0.212495	0.703359
755.2	0.534820	0.389185	0.208144	0.688959
755.3	0.523410	0.389293	0.203760	0.674448
755.4	0.511930	0.389402	0.199347	0.659839
755.5	0.500370	0.389510	0.194899	0.645119
755.6	0.488740	0.389619	0.190422	0.630300

755.7	0.477050	0.389727	0.185919	0.615395
755.8	0.465300	0.389836	0.181391	0.600405
755.9	0.453510	0.389945	0.176844	0.585355
756.0	0.441670	0.390053	0.172275	0.570232
756.1	0.429790	0.390369	0.167777	0.555342
756.2	0.417900	0.390682	0.163266	0.540412
756.3	0.406030	0.390994	0.158755	0.525482
756.4	0.394190	0.391306	0.154249	0.510566
756.5	0.382410	0.391618	0.149759	0.495703
756.6	0.370720	0.391931	0.145297	0.480933
756.7	0.359150	0.392243	0.140874	0.466295
756.8	0.347710	0.392556	0.136496	0.451802
756.9	0.336440	0.392868	0.132177	0.437506
757.0	0.325370	0.393181	0.127929	0.423447
757.1	0.314500	0.393495	0.123754	0.409628
757.2	0.303860	0.393810	0.119663	0.396086
757.3	0.293430	0.394125	0.115648	0.382796
757.4	0.283240	0.394440	0.111721	0.369798
757.5	0.273260	0.394755	0.107871	0.357053
757.6	0.263520	0.395070	0.104109	0.344601
757.7	0.254010	0.395385	0.100432	0.332430
757.8	0.244730	0.395700	0.096840	0.320540
757.9	0.235700	0.396015	0.093341	0.308959
758.0	0.226900	0.396331	0.089928	0.297661
758.1	0.218340	0.396726	0.086621	0.286717
758.2	0.210030	0.397118	0.083407	0.276077
758.3	0.201970	0.397510	0.080285	0.265745
758.4	0.194170	0.397903	0.077261	0.255734
758.5	0.186620	0.398295	0.074330	0.246033
758.6	0.179340	0.398688	0.071501	0.236668
758.7	0.172320	0.399081	0.068770	0.227628
758.8	0.165580	0.399474	0.066145	0.218941
758.9	0.159110	0.399868	0.063623	0.210593
759.0	0.152930	0.400261	0.061212	0.202612
759.1	0.147020	0.400653	0.058904	0.194973
759.2	0.141380	0.401045	0.056700	0.187677
759.3	0.135980	0.401438	0.054587	0.180685
759.4	0.130810	0.401830	0.052563	0.173986
759.5	0.125840	0.402223	0.050616	0.167539
759.6	0.121060	0.402617	0.048741	0.161332
759.7	0.116440	0.403010	0.046926	0.155327
759.8	0.111960	0.403403	0.045165	0.149497
759.9	0.107610	0.403797	0.043453	0.143828

760.0	0.103360	0.404190	0.041777	0.138283
760.1	0.099207	0.404446	0.040124	0.132810
760.2	0.095141	0.404701	0.038504	0.127447
760.3	0.091174	0.404956	0.036921	0.122210
760.4	0.087313	0.405211	0.035380	0.117109
760.5	0.083564	0.405466	0.033882	0.112151
760.6	0.079934	0.405721	0.032431	0.107347
760.7	0.076431	0.405976	0.031029	0.102707
760.8	0.073061	0.406231	0.029680	0.098240
760.9	0.069832	0.406486	0.028386	0.093957
761.0	0.066750	0.406741	0.027150	0.089867
761.1	0.063822	0.406991	0.025975	0.085977
761.2	0.061050	0.407241	0.024862	0.082294
761.3	0.058436	0.407491	0.023812	0.078818
761.4	0.055983	0.407741	0.022827	0.075556
761.5	0.053694	0.407991	0.021907	0.072511
761.6	0.051569	0.408241	0.021053	0.069684
761.7	0.049611	0.408490	0.020266	0.067079
761.8	0.047822	0.408740	0.019547	0.064700
761.9	0.046205	0.408990	0.018897	0.062551
762.0	0.044761	0.409235	0.018318	0.060632
762.1	0.043487	0.409427	0.017805	0.058934
762.2	0.042356	0.409619	0.017350	0.057428
762.3	0.041336	0.409811	0.016940	0.056071
762.4	0.040394	0.410004	0.016562	0.054819
762.5	0.039499	0.410196	0.016202	0.053630
762.6	0.038617	0.410388	0.015848	0.052457
762.7	0.037716	0.410580	0.015485	0.051257
762.8	0.036763	0.410772	0.015101	0.049985
762.9	0.035728	0.410963	0.014683	0.048601
763.0	0.034576	0.411155	0.014216	0.047055
763.1	0.033287	0.411346	0.013692	0.045322
763.2	0.031883	0.411536	0.013121	0.043431
763.3	0.030398	0.411726	0.012516	0.041427
763.4	0.028867	0.411915	0.011891	0.039359
763.5	0.027321	0.412105	0.011259	0.037268
763.6	0.025796	0.412295	0.010636	0.035204
763.7	0.024326	0.412485	0.010034	0.033213
763.8	0.022943	0.412674	0.009468	0.031339
763.9	0.021681	0.412861	0.008951	0.029629
764.0	0.020575	0.413043	0.008498	0.028130
764.1	0.019649	0.413237	0.008120	0.026876
764.2	0.018892	0.413431	0.007811	0.025853

764.3	0.018282	0.413624	0.007562	0.025030
764.4	0.017801	0.413818	0.007366	0.024383
764.5	0.017426	0.414012	0.007215	0.023880
764.6	0.017139	0.414205	0.007099	0.023498
764.7	0.016918	0.414398	0.007011	0.023206
764.8	0.016742	0.414591	0.006941	0.022975
764.9	0.016592	0.414784	0.006882	0.022780
765.0	0.016447	0.414977	0.006825	0.022591
765.1	0.016289	0.415172	0.006763	0.022385
765.2	0.016110	0.415368	0.006692	0.022149
765.3	0.015905	0.415563	0.006610	0.021878
765.4	0.015668	0.415758	0.006514	0.021562
765.5	0.015394	0.415954	0.006403	0.021195
765.6	0.015079	0.416148	0.006275	0.020771
765.7	0.014715	0.416343	0.006126	0.020279
765.8	0.014299	0.416536	0.005956	0.019715
765.9	0.013825	0.416722	0.005761	0.019070
766.0	0.013287	0.416907	0.005539	0.018336
766.1	0.012684	0.417251	0.005292	0.017518
766.2	0.012029	0.417594	0.005023	0.016627
766.3	0.011339	0.417938	0.004739	0.015686
766.4	0.010630	0.418281	0.004446	0.014717
766.5	0.009919	0.418623	0.004152	0.013745
766.6	0.009224	0.418966	0.003865	0.012792
766.7	0.008561	0.419309	0.003590	0.011882
766.8	0.007946	0.419652	0.003335	0.011037
766.9	0.007397	0.419994	0.003107	0.010283
767.0	0.006930	0.420337	0.002913	0.009642
767.1	0.006558	0.420679	0.002759	0.009132
767.2	0.006277	0.421022	0.002643	0.008748
767.3	0.006079	0.421365	0.002561	0.008478
767.4	0.005954	0.421707	0.002511	0.008311
767.5	0.005896	0.422050	0.002489	0.008237
767.6	0.005896	0.422393	0.002491	0.008244
767.7	0.005946	0.422735	0.002513	0.008320
767.8	0.006037	0.423071	0.002554	0.008453
767.9	0.006160	0.423405	0.002608	0.008634
768.0	0.006309	0.423739	0.002673	0.008849
768.1	0.006473	0.423943	0.002744	0.009084
768.2	0.006639	0.424147	0.002816	0.009321
768.3	0.006793	0.424352	0.002883	0.009542
768.4	0.006920	0.424556	0.002938	0.009724
768.5	0.007005	0.424761	0.002975	0.009848

768.6	0.007033	0.424965	0.002989	0.009894
768.7	0.006991	0.425169	0.002973	0.009839
768.8	0.006864	0.425373	0.002920	0.009665
768.9	0.006637	0.425577	0.002824	0.009349
769.0	0.006295	0.425781	0.002680	0.008872
769.1	0.005832	0.425982	0.002484	0.008224
769.2	0.005276	0.426182	0.002248	0.007442
769.3	0.004659	0.426382	0.001987	0.006576
769.4	0.004019	0.426583	0.001714	0.005675
769.5	0.003388	0.426783	0.001446	0.004787
769.6	0.002803	0.426983	0.001197	0.003961
769.7	0.002297	0.427179	0.000981	0.003248
769.8	0.001906	0.427369	0.000815	0.002697
769.9	0.001665	0.427560	0.000712	0.002356
770.0	0.001608	0.427751	0.000688	0.002277
770.1	0.001757	0.427994	0.000752	0.002489
770.2	0.002082	0.428237	0.000892	0.002951
770.3	0.002539	0.428480	0.001088	0.003601
770.4	0.003086	0.428723	0.001323	0.004379
770.5	0.003678	0.428966	0.001578	0.005222
770.6	0.004273	0.429209	0.001834	0.006070
770.7	0.004826	0.429451	0.002073	0.006861
770.8	0.005296	0.429694	0.002276	0.007532
770.9	0.005638	0.429937	0.002424	0.008023
771.0	0.005809	0.430179	0.002499	0.008271
771.1	0.005778	0.430423	0.002487	0.008233
771.2	0.005566	0.430667	0.002397	0.007935
771.3	0.005205	0.430911	0.002243	0.007424
771.4	0.004728	0.431154	0.002038	0.006747
771.5	0.004167	0.431398	0.001798	0.005950
771.6	0.003555	0.431640	0.001534	0.005079
771.7	0.002924	0.431874	0.001263	0.004180
771.8	0.002308	0.432108	0.000997	0.003301
771.9	0.001739	0.432342	0.000752	0.002488
772.0	0.001249	0.432577	0.000540	0.001788
772.1	0.000864	0.432737	0.000374	0.001237
772.2	0.000577	0.432897	0.000250	0.000827
772.3	0.000374	0.433057	0.000162	0.000537
772.4	0.000242	0.433217	0.000105	0.000348
772.5	0.000167	0.433378	0.000072	0.000239
772.6	0.000134	0.433538	0.000058	0.000192
772.7	0.000130	0.433698	0.000056	0.000187
772.8	0.000141	0.433859	0.000061	0.000202

772.9	0.000152	0.434019	0.000066	0.000219
773.0	0.000151	0.434180	0.000066	0.000217
773.1	0.000127	0.434345	0.000055	0.000182
773.2	0.000086	0.434511	0.000037	0.000124
773.3	0.000040	0.434677	0.000017	0.000058
773.4	0.000000	0.434842	0.000000	0.000000
8 639				
Channel 8				
Wavenumber	HIRS Filter Transmittance	Optical Element Transmittance	Product of the HIRS Filter and Optical Element Transmittances	Normalized Value of Column 4
867.3	0.002912	0.482673	0.001406	0.003174
867.4	0.004500	0.482781	0.002173	0.004907
867.5	0.005666	0.482890	0.002736	0.006179
867.6	0.005722	0.482998	0.002764	0.006241
867.7	0.005052	0.483108	0.002441	0.005512
867.8	0.004844	0.483217	0.002341	0.005287
867.9	0.004950	0.483327	0.002393	0.005403
868.0	0.005434	0.483437	0.002627	0.005932
868.1	0.006065	0.483559	0.002933	0.006624
868.2	0.005946	0.483682	0.002876	0.006495
868.3	0.005356	0.483804	0.002591	0.005852
868.4	0.004934	0.483928	0.002388	0.005392
868.5	0.004630	0.484052	0.002241	0.005062
868.6	0.004534	0.484177	0.002195	0.004957
868.7	0.004535	0.484303	0.002196	0.004960
868.8	0.004167	0.484429	0.002019	0.004559
868.9	0.003618	0.484557	0.001753	0.003959
869.0	0.003348	0.484684	0.001623	0.003665
869.1	0.003354	0.484810	0.001626	0.003672
869.2	0.003867	0.484937	0.001875	0.004235
869.3	0.004765	0.485064	0.002311	0.005220
869.4	0.005871	0.485193	0.002849	0.006434
869.5	0.006990	0.485323	0.003392	0.007661
869.6	0.007313	0.485455	0.003550	0.008018
869.7	0.007070	0.485587	0.003433	0.007753
869.8	0.006882	0.485721	0.003343	0.007549
869.9	0.006555	0.485855	0.003185	0.007192
870.0	0.005294	0.485988	0.002573	0.005810
870.1	0.003656	0.485977	0.001777	0.004013
870.2	0.003516	0.485966	0.001709	0.003859
870.3	0.004406	0.485956	0.002141	0.004836

870.4	0.005325	0.485947	0.002587	0.005843
870.5	0.006414	0.485939	0.003117	0.007039
870.6	0.008132	0.485932	0.003952	0.008924
870.7	0.010061	0.485925	0.004889	0.011041
870.8	0.010793	0.485919	0.005245	0.011844
870.9	0.010642	0.485914	0.005171	0.011678
871.0	0.010228	0.485909	0.004970	0.011224
871.1	0.009601	0.485904	0.004665	0.010536
871.2	0.009212	0.485899	0.004476	0.010108
871.3	0.009008	0.485895	0.004377	0.009885
871.4	0.008948	0.485891	0.004348	0.009819
871.5	0.009090	0.485888	0.004417	0.009975
871.6	0.009671	0.485886	0.004699	0.010612
871.7	0.010645	0.485884	0.005172	0.011681
871.8	0.012176	0.485883	0.005916	0.013361
871.9	0.014002	0.485881	0.006803	0.015364
872.0	0.015384	0.485876	0.007475	0.016881
872.1	0.016228	0.485982	0.007887	0.017811
872.2	0.015667	0.486088	0.007616	0.017199
872.3	0.014163	0.486195	0.006886	0.015551
872.4	0.012918	0.486303	0.006282	0.014187
872.5	0.012146	0.486411	0.005908	0.013342
872.6	0.013557	0.486520	0.006596	0.014896
872.7	0.016429	0.486629	0.007995	0.018055
872.8	0.019025	0.486739	0.009260	0.020913
872.9	0.021116	0.486850	0.010280	0.023217
873.0	0.020734	0.486961	0.010097	0.022802
873.1	0.018725	0.487071	0.009120	0.020597
873.2	0.017402	0.487181	0.008478	0.019146
873.3	0.016733	0.487292	0.008154	0.018414
873.4	0.017893	0.487404	0.008721	0.019695
873.5	0.020327	0.487516	0.009910	0.022380
873.6	0.022637	0.487630	0.011038	0.024929
873.7	0.024672	0.487743	0.012034	0.027176
873.8	0.025030	0.487858	0.012211	0.027577
873.9	0.024323	0.487970	0.011869	0.026804
874.0	0.024392	0.488081	0.011905	0.026886
874.1	0.025077	0.488143	0.012241	0.027645
874.2	0.026794	0.488205	0.013081	0.029541
874.3	0.029250	0.488268	0.014282	0.032253
874.4	0.031823	0.488333	0.015540	0.035095
874.5	0.034230	0.488397	0.016718	0.037755
874.6	0.034925	0.488463	0.017060	0.038527

874.7	0.034500	0.488529	0.016854	0.038063
874.8	0.034723	0.488596	0.016966	0.038314
874.9	0.035304	0.488664	0.017252	0.038961
875.0	0.035756	0.488732	0.017475	0.039465
875.1	0.036427	0.488804	0.017806	0.040211
875.2	0.038990	0.488876	0.019061	0.043047
875.3	0.042626	0.488948	0.020842	0.047068
875.4	0.044795	0.489022	0.021906	0.049471
875.5	0.046031	0.489096	0.022514	0.050844
875.6	0.047332	0.489171	0.023153	0.052289
875.7	0.048709	0.489247	0.023831	0.053818
875.8	0.050887	0.489321	0.024900	0.056233
875.9	0.053600	0.489394	0.026232	0.059240
876.0	0.056289	0.489467	0.027552	0.062221
876.1	0.058842	0.489661	0.028813	0.065069
876.2	0.060472	0.489855	0.029623	0.066898
876.3	0.061606	0.490049	0.030190	0.068180
876.4	0.063854	0.490244	0.031304	0.070696
876.5	0.066882	0.490440	0.032802	0.074078
876.6	0.070199	0.490636	0.034442	0.077783
876.7	0.073869	0.490832	0.036257	0.081882
876.8	0.078309	0.491028	0.038452	0.086838
876.9	0.083066	0.491224	0.040804	0.092150
877.0	0.086506	0.491421	0.042511	0.096005
877.1	0.089033	0.491618	0.043770	0.098849
877.2	0.091505	0.491816	0.045004	0.101634
877.3	0.094000	0.492013	0.046249	0.104447
877.4	0.097474	0.492210	0.047978	0.108351
877.5	0.101670	0.492408	0.050063	0.113060
877.6	0.106190	0.492605	0.052310	0.118134
877.7	0.111000	0.492801	0.054701	0.123534
877.8	0.115910	0.492994	0.057143	0.129049
877.9	0.120820	0.493186	0.059587	0.134568
878.0	0.124980	0.493379	0.061663	0.139256
878.1	0.128820	0.493503	0.063573	0.143571
878.2	0.134360	0.493627	0.066324	0.149783
878.3	0.140900	0.493752	0.069570	0.157113
878.4	0.146490	0.493876	0.072348	0.163387
878.5	0.151680	0.494002	0.074930	0.169219
878.6	0.158120	0.494127	0.078131	0.176449
878.7	0.165380	0.494253	0.081740	0.184597
878.8	0.172730	0.494379	0.085394	0.192850
878.9	0.180190	0.494505	0.089105	0.201230

879.0	0.187590	0.494631	0.092788	0.209548
879.1	0.195100	0.494754	0.096527	0.217991
879.2	0.203330	0.494878	0.100624	0.227244
879.3	0.212080	0.495002	0.104980	0.237082
879.4	0.220910	0.495126	0.109378	0.247015
879.5	0.229740	0.495250	0.113779	0.256953
879.6	0.237830	0.495374	0.117815	0.266068
879.7	0.245480	0.495494	0.121634	0.274693
879.8	0.253260	0.495615	0.125519	0.283468
879.9	0.261340	0.495735	0.129556	0.292582
880.0	0.271340	0.495856	0.134546	0.303852
880.1	0.282700	0.495918	0.140196	0.316613
880.2	0.293950	0.495981	0.145794	0.329254
880.3	0.305110	0.496043	0.151348	0.341797
880.4	0.314640	0.496105	0.156095	0.352517
880.5	0.323150	0.496168	0.160337	0.362097
880.6	0.332260	0.496230	0.164878	0.372352
880.7	0.341990	0.496293	0.169727	0.383304
880.8	0.353350	0.496355	0.175387	0.396086
880.9	0.366000	0.496417	0.181688	0.410317
881.0	0.378940	0.496479	0.188136	0.424877
881.1	0.392120	0.496542	0.194704	0.439711
881.2	0.404190	0.496606	0.200723	0.453304
881.3	0.415660	0.496669	0.206446	0.466228
881.4	0.427470	0.496733	0.212338	0.479536
881.5	0.439570	0.496796	0.218377	0.493172
881.6	0.451940	0.496857	0.224550	0.507113
881.7	0.464520	0.496917	0.230828	0.521292
881.8	0.476890	0.496978	0.237004	0.535239
881.9	0.489130	0.497038	0.243116	0.549043
882.0	0.500580	0.497099	0.248838	0.561964
882.1	0.511620	0.497047	0.254299	0.574298
882.2	0.522730	0.496996	0.259795	0.586708
882.3	0.534020	0.496944	0.265378	0.599318
882.4	0.545450	0.496893	0.271030	0.612082
882.5	0.557110	0.496842	0.276796	0.625103
882.6	0.569340	0.496791	0.282843	0.638760
882.7	0.582090	0.496740	0.289147	0.652997
882.8	0.594370	0.496688	0.295217	0.666704
882.9	0.606380	0.496637	0.301151	0.680106
883.0	0.617500	0.496586	0.306642	0.692507
883.1	0.628030	0.496537	0.311840	0.704246
883.2	0.638360	0.496488	0.316938	0.715759

883.3	0.648480	0.496440	0.321931	0.727035
883.4	0.657690	0.496391	0.326471	0.737288
883.5	0.666480	0.496340	0.330801	0.747066
883.6	0.675990	0.496288	0.335486	0.757646
883.7	0.686150	0.496236	0.340493	0.768953
883.8	0.696560	0.496185	0.345622	0.780538
883.9	0.707190	0.496132	0.350860	0.792366
884.0	0.716750	0.496081	0.355566	0.802994
884.1	0.725590	0.496202	0.360039	0.813096
884.2	0.733230	0.496323	0.363919	0.821858
884.3	0.740110	0.496443	0.367423	0.829771
884.4	0.747670	0.496564	0.371266	0.838450
884.5	0.755780	0.496685	0.375384	0.847751
884.6	0.764050	0.496805	0.379584	0.857235
884.7	0.772370	0.496925	0.383810	0.866779
884.8	0.779330	0.497045	0.387362	0.874800
884.9	0.785230	0.497164	0.390388	0.881635
885.0	0.789580	0.497283	0.392645	0.886732
885.1	0.792940	0.497403	0.394410	0.890719
885.2	0.797350	0.497522	0.396699	0.895888
885.3	0.802420	0.497641	0.399317	0.901799
885.4	0.806980	0.497759	0.401681	0.907139
885.5	0.811430	0.497875	0.403991	0.912355
885.6	0.816760	0.497991	0.406739	0.918561
885.7	0.822640	0.498106	0.409762	0.925389
885.8	0.827320	0.498221	0.412188	0.930868
885.9	0.831320	0.498336	0.414277	0.935584
886.0	0.835600	0.498450	0.416505	0.940616
886.1	0.839960	0.498509	0.418727	0.945635
886.2	0.843310	0.498567	0.420446	0.949518
886.3	0.845970	0.498625	0.421822	0.952624
886.4	0.848600	0.498683	0.423183	0.955697
886.5	0.851210	0.498741	0.424534	0.958748
886.6	0.853820	0.498798	0.425884	0.961797
886.7	0.856490	0.498855	0.427265	0.964915
886.8	0.858980	0.498912	0.428555	0.967830
886.9	0.861350	0.498968	0.429786	0.970610
887.0	0.863340	0.499024	0.430828	0.972962
887.1	0.865140	0.499079	0.431773	0.975097
887.2	0.867200	0.499134	0.432849	0.977526
887.3	0.869420	0.499188	0.434004	0.980135
887.4	0.871240	0.499240	0.434958	0.982290
887.5	0.872710	0.499293	0.435738	0.984051

887.6	0.873400	0.499345	0.436128	0.984931
887.7	0.873450	0.499397	0.436198	0.985090
887.8	0.873130	0.499448	0.436083	0.984831
887.9	0.872600	0.499499	0.435863	0.984334
888.0	0.872900	0.499551	0.436058	0.984773
888.1	0.873860	0.499601	0.436581	0.985955
888.2	0.875350	0.499651	0.437369	0.987736
888.3	0.877280	0.499701	0.438378	0.990013
888.4	0.879050	0.499751	0.439306	0.992109
888.5	0.880630	0.499801	0.440140	0.993992
888.6	0.881210	0.499851	0.440473	0.994745
888.7	0.881020	0.499900	0.440422	0.994630
888.8	0.880410	0.499950	0.440161	0.994040
888.9	0.879510	0.499999	0.439754	0.993122
889.0	0.879180	0.500049	0.439633	0.992848
889.1	0.879350	0.500099	0.439762	0.993139
889.2	0.880440	0.500149	0.440351	0.994470
889.3	0.882230	0.500198	0.441290	0.996590
889.4	0.883650	0.500247	0.442043	0.998291
889.5	0.884770	0.500296	0.442647	0.999654
889.6	0.884990	0.500345	0.442800	1.000000
889.7	0.884540	0.500394	0.442618	0.999589
889.8	0.884280	0.500442	0.442531	0.999392
889.9	0.883980	0.500491	0.442424	0.999150
890.0	0.882940	0.500540	0.441946	0.998072
890.1	0.881520	0.500523	0.441221	0.996433
890.2	0.881490	0.500506	0.441191	0.996366
890.3	0.882390	0.500488	0.441626	0.997348
890.4	0.882900	0.500471	0.441866	0.997890
890.5	0.883240	0.500453	0.442020	0.998239
890.6	0.883770	0.500435	0.442270	0.998802
890.7	0.884310	0.500417	0.442524	0.999377
890.8	0.883910	0.500400	0.442308	0.998889
890.9	0.882950	0.500382	0.441812	0.997769
891.0	0.882950	0.500363	0.441796	0.997732
891.1	0.883530	0.500349	0.442073	0.998358
891.2	0.883600	0.500334	0.442095	0.998407
891.3	0.883370	0.500318	0.441966	0.998117
891.4	0.883170	0.500303	0.441853	0.997861
891.5	0.882980	0.500288	0.441745	0.997616
891.6	0.882870	0.500273	0.441676	0.997461
891.7	0.882780	0.500258	0.441617	0.997329
891.8	0.882280	0.500242	0.441353	0.996733

891.9	0.881530	0.500226	0.440964	0.995854
892.0	0.881190	0.500211	0.440781	0.995439
892.1	0.881030	0.500321	0.440798	0.995479
892.2	0.880420	0.500432	0.440591	0.995010
892.3	0.879390	0.500543	0.440173	0.994067
892.4	0.877960	0.500654	0.439554	0.992670
892.5	0.876150	0.500765	0.438745	0.990843
892.6	0.874310	0.500876	0.437921	0.988981
892.7	0.872580	0.500987	0.437151	0.987243
892.8	0.872530	0.501098	0.437223	0.987405
892.9	0.873720	0.501209	0.437917	0.988971
893.0	0.874890	0.501320	0.438600	0.990515
893.1	0.876090	0.501431	0.439298	0.992092
893.2	0.876540	0.501540	0.439620	0.992819
893.3	0.876360	0.501651	0.439627	0.992833
893.4	0.875340	0.501761	0.439211	0.991895
893.5	0.873710	0.501871	0.438489	0.990265
893.6	0.872820	0.501981	0.438139	0.989474
893.7	0.872290	0.502091	0.437969	0.989090
893.8	0.871030	0.502202	0.437433	0.987878
893.9	0.869290	0.502312	0.436655	0.986122
894.0	0.868360	0.502423	0.436284	0.985284
894.1	0.867960	0.502399	0.436062	0.984784
894.2	0.867730	0.502376	0.435926	0.984477
894.3	0.867640	0.502352	0.435861	0.984328
894.4	0.867410	0.502328	0.435725	0.984021
894.5	0.866990	0.502305	0.435493	0.983498
894.6	0.865920	0.502281	0.434935	0.982239
894.7	0.864480	0.502258	0.434192	0.980560
894.8	0.864380	0.502235	0.434122	0.980401
894.9	0.865210	0.502212	0.434518	0.981297
895.0	0.865880	0.502188	0.434835	0.982012
895.1	0.866310	0.502168	0.435033	0.982459
895.2	0.864980	0.502147	0.434347	0.980909
895.3	0.862380	0.502125	0.433023	0.977920
895.4	0.860790	0.502104	0.432206	0.976075
895.5	0.859760	0.502083	0.431671	0.974866
895.6	0.859080	0.502062	0.431312	0.974055
895.7	0.858600	0.502042	0.431053	0.973471
895.8	0.857660	0.502021	0.430563	0.972365
895.9	0.856400	0.502000	0.429913	0.970896
896.0	0.855420	0.501980	0.429403	0.969745
896.1	0.854610	0.501963	0.428982	0.968794

896.2	0.854110	0.501946	0.428717	0.968195
896.3	0.853830	0.501928	0.428562	0.967844
896.4	0.853300	0.501911	0.428281	0.967210
896.5	0.852750	0.501894	0.427990	0.966553
896.6	0.853280	0.501877	0.428241	0.967121
896.7	0.854630	0.501860	0.428904	0.968619
896.8	0.855920	0.501843	0.429537	0.970047
896.9	0.857060	0.501826	0.430095	0.971306
897.0	0.856270	0.501808	0.429683	0.970378
897.1	0.854120	0.501791	0.428590	0.967908
897.2	0.852980	0.501774	0.428003	0.966582
897.3	0.852490	0.501756	0.427742	0.965994
897.4	0.852750	0.501739	0.427858	0.966255
897.5	0.853520	0.501722	0.428230	0.967094
897.6	0.853570	0.501704	0.428240	0.967118
897.7	0.853000	0.501687	0.427939	0.966439
897.8	0.851400	0.501670	0.427122	0.964593
897.9	0.849050	0.501652	0.425928	0.961897
898.0	0.848080	0.501635	0.425427	0.960765
898.1	0.847920	0.501636	0.425347	0.960585
898.2	0.847250	0.501636	0.425012	0.959827
898.3	0.846230	0.501637	0.424500	0.958673
898.4	0.845060	0.501638	0.423914	0.957349
898.5	0.843880	0.501639	0.423323	0.956014
898.6	0.844160	0.501640	0.423465	0.956334
898.7	0.845490	0.501642	0.424133	0.957844
898.8	0.846420	0.501644	0.424601	0.958901
898.9	0.847080	0.501646	0.424934	0.959652
899.0	0.846700	0.501649	0.424746	0.959227
899.1	0.845550	0.501653	0.424173	0.957932
899.2	0.844700	0.501657	0.423750	0.956977
899.3	0.844030	0.501661	0.423417	0.956227
899.4	0.844010	0.501666	0.423411	0.956213
899.5	0.844350	0.501671	0.423586	0.956607
899.6	0.843650	0.501675	0.423238	0.955822
899.7	0.842300	0.501679	0.422564	0.954301
899.8	0.842120	0.501684	0.422478	0.954105
899.9	0.842760	0.501688	0.422803	0.954839
900.0	0.843500	0.501693	0.423178	0.955686
900.1	0.844340	0.501711	0.423615	0.956672
900.2	0.844860	0.501729	0.423890	0.957295
900.3	0.845050	0.501746	0.424001	0.957545
900.4	0.845220	0.501764	0.424101	0.957771

900.5	0.845420	0.501782	0.424216	0.958031
900.6	0.846400	0.501798	0.424722	0.959174
900.7	0.847910	0.501815	0.425494	0.960917
900.8	0.848320	0.501832	0.425714	0.961413
900.9	0.847660	0.501848	0.425397	0.960697
901.0	0.846510	0.501865	0.424834	0.959426
901.1	0.845080	0.501880	0.424128	0.957833
901.2	0.845200	0.501894	0.424201	0.957996
901.3	0.846750	0.501908	0.424990	0.959779
901.4	0.848050	0.501921	0.425654	0.961279
901.5	0.849080	0.501935	0.426183	0.962472
901.6	0.849270	0.501947	0.426289	0.962712
901.7	0.848750	0.501960	0.426039	0.962147
901.8	0.849330	0.501972	0.426340	0.962828
901.9	0.850780	0.501984	0.427078	0.964494
902.0	0.851800	0.501995	0.427600	0.965672
902.1	0.852260	0.502010	0.427843	0.966222
902.2	0.851450	0.502025	0.427449	0.965332
902.3	0.849430	0.502039	0.426447	0.963070
902.4	0.847600	0.502054	0.425541	0.961022
902.5	0.846030	0.502068	0.424764	0.959269
902.6	0.845290	0.502082	0.424405	0.958457
902.7	0.845450	0.502096	0.424497	0.958665
902.8	0.845650	0.502110	0.424609	0.958918
902.9	0.846050	0.502123	0.424821	0.959398
903.0	0.846700	0.502137	0.425160	0.960161
903.1	0.847580	0.502150	0.425612	0.961184
903.2	0.848550	0.502163	0.426111	0.962309
903.3	0.849480	0.502176	0.426589	0.963389
903.4	0.849900	0.502189	0.426810	0.963890
903.5	0.849780	0.502202	0.426761	0.963778
903.6	0.849630	0.502214	0.426696	0.963631
903.7	0.849460	0.502226	0.426621	0.963462
903.8	0.849760	0.502238	0.426782	0.963825
903.9	0.850470	0.502250	0.427148	0.964653
904.0	0.851040	0.502262	0.427445	0.965322
904.1	0.851520	0.502268	0.427691	0.965879
904.2	0.852150	0.502274	0.428013	0.966605
904.3	0.852740	0.502280	0.428314	0.967286
904.4	0.852390	0.502286	0.428144	0.966900
904.5	0.851140	0.502292	0.427521	0.965493
904.6	0.849900	0.502297	0.426902	0.964097
904.7	0.848680	0.502302	0.426294	0.962723

904.8	0.847810	0.502308	0.425862	0.961747
904.9	0.847310	0.502313	0.425615	0.961190
905.0	0.846680	0.502319	0.425303	0.960486
905.1	0.846050	0.502323	0.424990	0.959778
905.2	0.845740	0.502326	0.424837	0.959434
905.3	0.845760	0.502329	0.424850	0.959463
905.4	0.845860	0.502332	0.424903	0.959582
905.5	0.846140	0.502335	0.425046	0.959905
905.6	0.847020	0.502338	0.425490	0.960908
905.7	0.848290	0.502340	0.426130	0.962353
905.8	0.848270	0.502342	0.426122	0.962334
905.9	0.847080	0.502344	0.425525	0.960987
906.0	0.846140	0.502345	0.425054	0.959924
906.1	0.845330	0.502190	0.424517	0.958709
906.2	0.844440	0.502036	0.423939	0.957405
906.3	0.843590	0.501881	0.423381	0.956146
906.4	0.843140	0.501725	0.423024	0.955339
906.5	0.843060	0.501569	0.422853	0.954952
906.6	0.842620	0.501413	0.422500	0.954156
906.7	0.841900	0.501257	0.422008	0.953045
906.8	0.841070	0.501101	0.421461	0.951809
906.9	0.840160	0.500945	0.420874	0.950483
907.0	0.839320	0.500789	0.420322	0.949237
907.1	0.838600	0.500632	0.419830	0.948126
907.2	0.838020	0.500476	0.419409	0.947174
907.3	0.837710	0.500319	0.419122	0.946526
907.4	0.838180	0.500162	0.419225	0.946760
907.5	0.839380	0.500004	0.419694	0.947818
907.6	0.840310	0.499847	0.420026	0.948568
907.7	0.840870	0.499689	0.420173	0.948901
907.8	0.840100	0.499531	0.419656	0.947732
907.9	0.838170	0.499372	0.418559	0.945255
908.0	0.837480	0.499214	0.418082	0.944177
908.1	0.837820	0.499095	0.418152	0.944335
908.2	0.837680	0.498975	0.417982	0.943951
908.3	0.837160	0.498856	0.417622	0.943139
908.4	0.836310	0.498736	0.417098	0.941956
908.5	0.835230	0.498617	0.416460	0.940514
908.6	0.835070	0.498507	0.416288	0.940127
908.7	0.835770	0.498402	0.416549	0.940717
908.8	0.836540	0.498297	0.416845	0.941385
908.9	0.837320	0.498192	0.417146	0.942063
909.0	0.837270	0.498086	0.417033	0.941808

909.1	0.836350	0.497977	0.416483	0.940567
909.2	0.834990	0.497868	0.415715	0.938832
909.3	0.833320	0.497759	0.414792	0.936749
909.4	0.833130	0.497650	0.414607	0.936329
909.5	0.834370	0.497540	0.415133	0.937517
909.6	0.835750	0.497430	0.415727	0.938860
909.7	0.837260	0.497320	0.416386	0.940348
909.8	0.837840	0.497210	0.416583	0.940791
909.9	0.837550	0.497100	0.416346	0.940258
910.0	0.837650	0.496990	0.416304	0.940162
910.1	0.838060	0.496996	0.416512	0.940633
910.2	0.838980	0.497002	0.416974	0.941676
910.3	0.840260	0.497008	0.417616	0.943124
910.4	0.840580	0.497013	0.417780	0.943495
910.5	0.839960	0.497024	0.417480	0.942819
910.6	0.839250	0.497041	0.417141	0.942054
910.7	0.838410	0.497057	0.416738	0.941142
910.8	0.838040	0.497074	0.416568	0.940758
910.9	0.838190	0.497090	0.416656	0.940958
911.0	0.838870	0.497107	0.417008	0.941752
911.1	0.840010	0.497122	0.417587	0.943060
911.2	0.840400	0.497137	0.417794	0.943526
911.3	0.840080	0.497151	0.417647	0.943195
911.4	0.839680	0.497166	0.417460	0.942773
911.5	0.839090	0.497180	0.417179	0.942138
911.6	0.838120	0.497195	0.416709	0.941076
911.7	0.836850	0.497209	0.416089	0.939677
911.8	0.836200	0.497223	0.415778	0.938974
911.9	0.836060	0.497237	0.415720	0.938843
912.0	0.835330	0.497251	0.415368	0.938050
912.1	0.834060	0.497200	0.414694	0.936527
912.2	0.832660	0.497148	0.413955	0.934858
912.3	0.831020	0.497097	0.413097	0.932921
912.4	0.828910	0.497044	0.412005	0.930453
912.5	0.826400	0.496981	0.410705	0.927519
912.6	0.824240	0.496918	0.409580	0.924976
912.7	0.822300	0.496854	0.408563	0.922681
912.8	0.819360	0.496791	0.407050	0.919264
912.9	0.815510	0.496726	0.405085	0.914827
913.0	0.811560	0.496662	0.403071	0.910278
913.1	0.807420	0.496604	0.400968	0.905528
913.2	0.802660	0.496545	0.398557	0.900083
913.3	0.797370	0.496486	0.395883	0.894044

913.4	0.791890	0.496426	0.393115	0.887793
913.5	0.786220	0.496366	0.390253	0.881329
913.6	0.780120	0.496305	0.387178	0.874385
913.7	0.773630	0.496245	0.383910	0.867005
913.8	0.766510	0.496184	0.380330	0.858920
913.9	0.758840	0.496123	0.376478	0.850221
914.0	0.750990	0.496062	0.372537	0.841322
914.1	0.742920	0.496014	0.368499	0.832201
914.2	0.733730	0.495966	0.363905	0.821828
914.3	0.723440	0.495919	0.358767	0.810224
914.4	0.712130	0.495871	0.353124	0.797480
914.5	0.699950	0.495823	0.347051	0.783765
914.6	0.687700	0.495775	0.340944	0.769974
914.7	0.675660	0.495727	0.334943	0.756420
914.8	0.664500	0.495678	0.329378	0.743853
914.9	0.654220	0.495630	0.324251	0.732274
915.0	0.641870	0.495581	0.318099	0.718380
915.1	0.627770	0.495534	0.311081	0.702532
915.2	0.613340	0.495486	0.303902	0.686318
915.3	0.598680	0.495439	0.296609	0.669849
915.4	0.584100	0.495391	0.289358	0.653473
915.5	0.569980	0.495343	0.282336	0.637615
915.6	0.556710	0.495295	0.275736	0.622710
915.7	0.544480	0.495247	0.269652	0.608970
915.8	0.531040	0.495198	0.262970	0.593880
915.9	0.516780	0.495149	0.255883	0.577876
916.0	0.502620	0.495101	0.248847	0.561986
916.1	0.488670	0.495028	0.241905	0.546308
916.2	0.474020	0.494955	0.234619	0.529852
916.3	0.458970	0.494883	0.227136	0.512955
916.4	0.444360	0.494810	0.219874	0.496553
916.5	0.430350	0.494738	0.212910	0.480827
916.6	0.415960	0.494664	0.205761	0.464680
916.7	0.401560	0.494591	0.198608	0.448527
916.8	0.387840	0.494517	0.191793	0.433137
916.9	0.375010	0.494442	0.185421	0.418746
917.0	0.361880	0.494367	0.178901	0.404023
917.1	0.348740	0.494288	0.172378	0.389291
917.2	0.335240	0.494209	0.165679	0.374161
917.3	0.321710	0.494130	0.158967	0.359003
917.4	0.309200	0.494050	0.152760	0.344987
917.5	0.297790	0.493970	0.147099	0.332203
917.6	0.285660	0.493889	0.141084	0.318619

917.7	0.273120	0.493808	0.134869	0.304582
917.8	0.260980	0.493726	0.128853	0.290995
917.9	0.249360	0.493644	0.123095	0.277992
918.0	0.237410	0.493561	0.117176	0.264626
918.1	0.225520	0.493377	0.111266	0.251279
918.2	0.214910	0.493192	0.105992	0.239368
918.3	0.205720	0.493008	0.101422	0.229046
918.4	0.196120	0.492822	0.096652	0.218275
918.5	0.186550	0.492637	0.091901	0.207546
918.6	0.178070	0.492450	0.087691	0.198037
918.7	0.170800	0.492264	0.084079	0.189879
918.8	0.163480	0.492077	0.080445	0.181673
918.9	0.156310	0.491889	0.076887	0.173638
919.0	0.149130	0.491701	0.073327	0.165599
919.1	0.142010	0.491513	0.069800	0.157633
919.2	0.134680	0.491325	0.066172	0.149439
919.3	0.127290	0.491136	0.062517	0.141185
919.4	0.120500	0.490947	0.059159	0.133602
919.5	0.114480	0.490757	0.056182	0.126879
919.6	0.109160	0.490567	0.053550	0.120936
919.7	0.104740	0.490377	0.051362	0.115994
919.8	0.100680	0.490187	0.049352	0.111454
919.9	0.097125	0.489997	0.047591	0.107477
920.0	0.093581	0.489806	0.045837	0.103515
920.1	0.090071	0.489675	0.044106	0.099606
920.2	0.086278	0.489544	0.042237	0.095386
920.3	0.082124	0.489413	0.040193	0.090769
920.4	0.077296	0.489282	0.037820	0.085410
920.5	0.071844	0.489150	0.035143	0.079364
920.6	0.067147	0.489018	0.032836	0.074156
920.7	0.063203	0.488886	0.030899	0.069781
920.8	0.059588	0.488754	0.029124	0.065772
920.9	0.056502	0.488621	0.027608	0.062349
921.0	0.054094	0.488488	0.026424	0.059675
921.1	0.052396	0.488357	0.025588	0.057787
921.2	0.050124	0.488226	0.024472	0.055266
921.3	0.047402	0.488095	0.023137	0.052251
921.4	0.045021	0.487964	0.021969	0.049613
921.5	0.042977	0.487833	0.020966	0.047348
921.6	0.041193	0.487701	0.020090	0.045370
921.7	0.039788	0.487570	0.019399	0.043811
921.8	0.039007	0.487439	0.019014	0.042939
921.9	0.038836	0.487308	0.018925	0.042740

922.0	0.037966	0.487177	0.018496	0.041771
922.1	0.036461	0.487043	0.017758	0.040104
922.2	0.034977	0.486909	0.017031	0.038461
922.3	0.033475	0.486775	0.016295	0.036799
922.4	0.032392	0.486642	0.015763	0.035599
922.5	0.031677	0.486508	0.015411	0.034804
922.6	0.030545	0.486374	0.014856	0.033551
922.7	0.029017	0.486240	0.014109	0.031864
922.8	0.027402	0.486105	0.013320	0.030082
922.9	0.025671	0.485971	0.012475	0.028174
923.0	0.024284	0.485836	0.011798	0.026644
923.1	0.023199	0.485704	0.011268	0.025447
923.2	0.022000	0.485572	0.010683	0.024125
923.3	0.020693	0.485439	0.010045	0.022686
923.4	0.019130	0.485306	0.009284	0.020966
923.5	0.017424	0.485174	0.008454	0.019091
923.6	0.016874	0.485041	0.008185	0.018484
923.7	0.017493	0.484908	0.008482	0.019156
923.8	0.018083	0.484775	0.008766	0.019797
923.9	0.018737	0.484642	0.009081	0.020508
924.0	0.018867	0.484509	0.009141	0.020644
924.1	0.018365	0.484419	0.008896	0.020091
924.2	0.016898	0.484329	0.008184	0.018483
924.3	0.014450	0.484239	0.006997	0.015802
924.4	0.013077	0.484149	0.006331	0.014298
924.5	0.012669	0.484059	0.006133	0.013849
924.6	0.012139	0.483969	0.005875	0.013268
924.7	0.011693	0.483879	0.005658	0.012778
924.8	0.012106	0.483789	0.005857	0.013227
924.9	0.013245	0.483699	0.006407	0.014468
925.0	0.012776	0.483609	0.006179	0.013953
925.1	0.010813	0.483520	0.005228	0.011807
925.2	0.009544	0.483430	0.004614	0.010420
925.3	0.008788	0.483340	0.004247	0.009592
925.4	0.007980	0.483250	0.003856	0.008709
925.5	0.007287	0.483160	0.003521	0.007951
925.6	0.007638	0.483071	0.003690	0.008333
925.7	0.008996	0.482982	0.004345	0.009813
925.8	0.009442	0.482893	0.004560	0.010297
925.9	0.009073	0.482804	0.004380	0.009892
926.0	0.008669	0.482716	0.004185	0.009451
926.1	0.008046	0.482525	0.003882	0.008768
926.2	0.006803	0.482334	0.003282	0.007411

926.3	0.004926	0.482143	0.002375	0.005364
926.4	0.003564	0.481953	0.001718	0.003879
926.5	0.002771	0.481763	0.001335	0.003014
926.6	0.003266	0.481573	0.001573	0.003551
926.7	0.005094	0.481383	0.002452	0.005538
926.8	0.006064	0.481194	0.002918	0.006590
926.9	0.006292	0.481004	0.003026	0.006835
927.0	0.006034	0.480815	0.002901	0.006553
927.1	0.005247	0.480623	0.002522	0.005695
927.2	0.005132	0.480431	0.002465	0.005568
927.3	0.005641	0.480240	0.002709	0.006118
927.4	0.006176	0.480048	0.002965	0.006695
927.5	0.006773	0.479857	0.003250	0.007339
927.6	0.006877	0.479665	0.003299	0.007450
927.7	0.006435	0.479474	0.003085	0.006968
927.8	0.005628	0.479283	0.002697	0.006092
927.9	0.004371	0.479091	0.002094	0.004729
928.0	0.003348	0.478900	0.001603	0.003621
928.1	0.002542	0.478867	0.001217	0.002749
928.2	0.002271	0.478834	0.001087	0.002456
928.3	0.002562	0.478801	0.001226	0.002770
928.4	0.002649	0.478767	0.001268	0.002864
928.5	0.002632	0.478734	0.001260	0.002845
928.6	0.002873	0.478700	0.001375	0.003106
928.7	0.003348	0.478666	0.001603	0.003619
928.8	0.003538	0.478633	0.001693	0.003824
928.9	0.003457	0.478599	0.001655	0.003737
929.0	0.003345	0.478565	0.001601	0.003615
929.1	0.003104	0.478535	0.001485	0.003354
929.2	0.002304	0.478504	0.001103	0.002490
929.3	0.000988	0.478473	0.000473	0.001068
929.4	0.000674	0.478441	0.000322	0.000728
929.5	0.001342	0.478410	0.000642	0.001450
929.6	0.002064	0.478379	0.000988	0.002230
929.7	0.002967	0.478347	0.001419	0.003205
929.8	0.003558	0.478315	0.001702	0.003843
929.9	0.003852	0.478284	0.001842	0.004161
930.0	0.004005	0.478252	0.001916	0.004326
930.1	0.003944	0.478069	0.001886	0.004258
930.2	0.003592	0.477885	0.001717	0.003877
930.3	0.002944	0.477701	0.001406	0.003176
930.4	0.002850	0.477518	0.001361	0.003074
930.5	0.003232	0.477334	0.001543	0.003484

930.6	0.003050	0.477150	0.001455	0.003287
930.7	0.002298	0.476967	0.001096	0.002476
930.8	0.001131	0.476783	0.000539	0.001218
930.9	0.000000	0.476599	0.000000	0.000000
CHANNEL 9				
Wavenumber	HIRS Filter Transmittance	Optical Element Transmittance	Product of the HIRS Filter and Optical Element Transmittances	Normalized Value of Column 4
999.4	0.003000	0.436028	0.001308	0.003873
999.5	0.002000	0.436030	0.000872	0.002582
999.6	0.002000	0.436032	0.000872	0.002582
999.7	0.002000	0.436034	0.000872	0.002582
999.8	0.002000	0.436036	0.000872	0.002582
999.9	0.002000	0.436038	0.000872	0.002582
1000.0	0.002000	0.436039	0.000872	0.002582
1000.1	0.002000	0.435979	0.000872	0.002582
1000.2	0.002000	0.435919	0.000872	0.002582
1000.3	0.002000	0.435859	0.000872	0.002581
1000.4	0.002000	0.435798	0.000872	0.002581
1000.5	0.003000	0.435738	0.001307	0.003871
1000.6	0.003000	0.435678	0.001307	0.003870
1000.7	0.003000	0.435617	0.001307	0.003870
1000.8	0.004000	0.435557	0.001742	0.005159
1000.9	0.004000	0.435496	0.001742	0.005158
1001.0	0.004000	0.435436	0.001742	0.005157
1001.1	0.004000	0.435376	0.001742	0.005157
1001.2	0.004000	0.435315	0.001741	0.005156
1001.3	0.004000	0.435255	0.001741	0.005155
1001.4	0.004000	0.435194	0.001741	0.005155
1001.5	0.003000	0.435134	0.001305	0.003865
1001.6	0.003000	0.435074	0.001305	0.003865
1001.7	0.003000	0.435014	0.001305	0.003864
1001.8	0.003000	0.434954	0.001305	0.003864
1001.9	0.003000	0.434893	0.001305	0.003863
1002.0	0.004000	0.434833	0.001739	0.005150
1002.1	0.005000	0.434827	0.002174	0.006438
1002.2	0.006000	0.434822	0.002609	0.007725
1002.3	0.005000	0.434817	0.002174	0.006438
1002.4	0.005000	0.434811	0.002174	0.006438
1002.5	0.006000	0.434806	0.002609	0.007725
1002.6	0.006000	0.434800	0.002609	0.007725
1002.7	0.006000	0.434794	0.002609	0.007725

1002.8	0.007000	0.434789	0.003044	0.009012
1002.9	0.007000	0.434783	0.003043	0.009012
1003.0	0.007000	0.434777	0.003043	0.009012
1003.1	0.007000	0.434769	0.003043	0.009012
1003.2	0.007000	0.434762	0.003043	0.009012
1003.3	0.007000	0.434754	0.003043	0.009011
1003.4	0.007000	0.434747	0.003043	0.009011
1003.5	0.007000	0.434739	0.003043	0.009011
1003.6	0.007000	0.434731	0.003043	0.009011
1003.7	0.008000	0.434722	0.003478	0.010298
1003.8	0.008000	0.434714	0.003478	0.010298
1003.9	0.008000	0.434706	0.003478	0.010298
1004.0	0.008000	0.434698	0.003478	0.010297
1004.1	0.009000	0.434688	0.003912	0.011584
1004.2	0.009000	0.434678	0.003912	0.011584
1004.3	0.010000	0.434668	0.004347	0.012871
1004.4	0.010000	0.434658	0.004347	0.012871
1004.5	0.010000	0.434648	0.004346	0.012870
1004.6	0.010000	0.434637	0.004346	0.012870
1004.7	0.010000	0.434627	0.004346	0.012870
1004.8	0.010000	0.434617	0.004346	0.012869
1004.9	0.011000	0.434606	0.004781	0.014156
1005.0	0.012000	0.434597	0.005215	0.015443
1005.1	0.011000	0.434600	0.004781	0.014156
1005.2	0.012000	0.434602	0.005215	0.015443
1005.3	0.012000	0.434604	0.005215	0.015443
1005.4	0.012000	0.434607	0.005215	0.015443
1005.5	0.012000	0.434609	0.005215	0.015443
1005.6	0.012000	0.434610	0.005215	0.015443
1005.7	0.013000	0.434612	0.005650	0.016730
1005.8	0.013000	0.434614	0.005650	0.016730
1005.9	0.014000	0.434616	0.006085	0.018017
1006.0	0.014000	0.434618	0.006085	0.018017
1006.1	0.014000	0.434699	0.006086	0.018021
1006.2	0.014000	0.434780	0.006087	0.018024
1006.3	0.015000	0.434860	0.006523	0.019315
1006.4	0.017000	0.434941	0.007394	0.021894
1006.5	0.017000	0.435022	0.007395	0.021898
1006.6	0.017000	0.435102	0.007397	0.021902
1006.7	0.017000	0.435183	0.007398	0.021907
1006.8	0.018000	0.435263	0.007835	0.023199
1006.9	0.019000	0.435344	0.008272	0.024493
1007.0	0.019000	0.435424	0.008273	0.024497

1007.1	0.019000	0.435508	0.008275	0.024502
1007.2	0.020000	0.435591	0.008712	0.025797
1007.3	0.020000	0.435675	0.008713	0.025801
1007.4	0.020000	0.435758	0.008715	0.025806
1007.5	0.022000	0.435841	0.009589	0.028392
1007.6	0.023000	0.435924	0.010026	0.029689
1007.7	0.023000	0.436007	0.010028	0.029694
1007.8	0.022000	0.436090	0.009594	0.028409
1007.9	0.026000	0.436173	0.011340	0.033580
1008.0	0.028000	0.436255	0.012215	0.036170
1008.1	0.025000	0.436290	0.010907	0.032297
1008.2	0.026000	0.436324	0.011344	0.033592
1008.3	0.027000	0.436358	0.011782	0.034887
1008.4	0.028000	0.436392	0.012219	0.036182
1008.5	0.028000	0.436426	0.012220	0.036184
1008.6	0.028000	0.436460	0.012221	0.036187
1008.7	0.029000	0.436494	0.012658	0.037482
1008.8	0.031000	0.436527	0.013532	0.040071
1008.9	0.032000	0.436561	0.013970	0.041366
1009.0	0.033000	0.436594	0.014408	0.042662
1009.1	0.033000	0.436625	0.014409	0.042665
1009.2	0.035000	0.436655	0.015283	0.045254
1009.3	0.036000	0.436686	0.015721	0.046551
1009.4	0.037000	0.436716	0.016159	0.047847
1009.5	0.037000	0.436746	0.016160	0.047850
1009.6	0.038000	0.436776	0.016598	0.049147
1009.7	0.040000	0.436806	0.017472	0.051737
1009.8	0.040000	0.436836	0.017473	0.051741
1009.9	0.041000	0.436865	0.017911	0.053038
1010.0	0.039000	0.436894	0.017039	0.050454
1010.1	0.043000	0.436917	0.018787	0.055631
1010.2	0.046000	0.436941	0.020099	0.059516
1010.3	0.046000	0.436963	0.020100	0.059519
1010.4	0.047000	0.436986	0.020538	0.060816
1010.5	0.049000	0.437008	0.021413	0.063407
1010.6	0.049000	0.437030	0.021414	0.063410
1010.7	0.052000	0.437051	0.022727	0.067296
1010.8	0.053000	0.437073	0.023165	0.068593
1010.9	0.055000	0.437094	0.024040	0.071185
1011.0	0.057000	0.437116	0.024916	0.073778
1011.1	0.057000	0.437135	0.024917	0.073781
1011.2	0.060000	0.437155	0.026229	0.077667
1011.3	0.064000	0.437174	0.027979	0.082849

1011.4	0.065000	0.437193	0.028418	0.084147
1011.5	0.066000	0.437211	0.028856	0.085445
1011.6	0.069000	0.437230	0.030169	0.089333
1011.7	0.071000	0.437249	0.031045	0.091926
1011.8	0.073000	0.437267	0.031920	0.094520
1011.9	0.075000	0.437285	0.032796	0.097113
1012.0	0.078000	0.437303	0.034110	0.101002
1012.1	0.081000	0.437287	0.035420	0.104883
1012.2	0.083000	0.437270	0.036293	0.107468
1012.3	0.086000	0.437254	0.037604	0.111349
1012.4	0.088000	0.437237	0.038477	0.113934
1012.5	0.090000	0.437221	0.039350	0.116519
1012.6	0.093000	0.437204	0.040660	0.120398
1012.7	0.096000	0.437187	0.041970	0.124277
1012.8	0.099000	0.437170	0.043280	0.128156
1012.9	0.101000	0.437153	0.044152	0.130740
1013.0	0.104000	0.437137	0.045462	0.134618
1013.1	0.107000	0.437120	0.046772	0.138496
1013.2	0.109000	0.437104	0.047644	0.141079
1013.3	0.111000	0.437087	0.048517	0.143662
1013.4	0.116000	0.437070	0.050700	0.150128
1013.5	0.119000	0.437053	0.052009	0.154004
1013.6	0.123000	0.437035	0.053755	0.159175
1013.7	0.127000	0.437018	0.055501	0.164345
1013.8	0.131000	0.437001	0.057247	0.169514
1013.9	0.134000	0.436983	0.058556	0.173389
1014.0	0.138000	0.436966	0.060301	0.178558
1014.1	0.143000	0.436878	0.062474	0.184990
1014.2	0.146000	0.436790	0.063771	0.188833
1014.3	0.152000	0.436702	0.066379	0.196554
1014.4	0.155000	0.436614	0.067675	0.200393
1014.5	0.160000	0.436526	0.069844	0.206815
1014.6	0.164000	0.436437	0.071576	0.211943
1014.7	0.167000	0.436349	0.072870	0.215776
1014.8	0.174000	0.436261	0.075909	0.224775
1014.9	0.176000	0.436173	0.076766	0.227313
1015.0	0.179000	0.436085	0.078059	0.231141
1015.1	0.190000	0.435995	0.082839	0.245295
1015.2	0.194000	0.435906	0.084566	0.250407
1015.3	0.201000	0.435817	0.087599	0.259390
1015.4	0.207000	0.435728	0.090196	0.267078
1015.5	0.212000	0.435638	0.092355	0.273473
1015.6	0.223000	0.435549	0.097127	0.287604

1015.7	0.227000	0.435460	0.098849	0.292702
1015.8	0.232000	0.435370	0.101006	0.299088
1015.9	0.253000	0.435281	0.110126	0.326094
1016.0	0.256000	0.435192	0.111409	0.329893
1016.1	0.257000	0.435154	0.111835	0.331153
1016.2	0.257000	0.435116	0.111825	0.331124
1016.3	0.267000	0.435078	0.116166	0.343978
1016.4	0.274000	0.435040	0.119201	0.352966
1016.5	0.274000	0.435002	0.119191	0.352935
1016.6	0.283000	0.434965	0.123095	0.364496
1016.7	0.287000	0.434927	0.124824	0.369616
1016.8	0.292000	0.434889	0.126988	0.376023
1016.9	0.299000	0.434852	0.130021	0.385004
1017.0	0.308000	0.434814	0.133923	0.396558
1017.1	0.321000	0.434772	0.139562	0.413256
1017.2	0.330000	0.434731	0.143461	0.424802
1017.3	0.334000	0.434689	0.145186	0.429910
1017.4	0.338000	0.434646	0.146910	0.435016
1017.5	0.343000	0.434604	0.149069	0.441408
1017.6	0.349000	0.434561	0.151662	0.449086
1017.7	0.361000	0.434519	0.156861	0.464481
1017.8	0.364000	0.434476	0.158149	0.468295
1017.9	0.395000	0.434433	0.171601	0.508128
1018.0	0.407000	0.434390	0.176797	0.523513
1018.1	0.407000	0.434296	0.176759	0.523399
1018.2	0.408000	0.434202	0.177154	0.524572
1018.3	0.409000	0.434108	0.177550	0.525743
1018.4	0.417000	0.434014	0.180984	0.535910
1018.5	0.424000	0.433920	0.183982	0.544788
1018.6	0.424000	0.433825	0.183942	0.544670
1018.7	0.434000	0.433731	0.188239	0.557394
1018.8	0.450000	0.433636	0.195136	0.577818
1018.9	0.465000	0.433542	0.201597	0.596948
1019.0	0.470000	0.433447	0.203720	0.603235
1019.1	0.473000	0.433355	0.204977	0.606957
1019.2	0.489000	0.433263	0.211866	0.627355
1019.3	0.492000	0.433171	0.213120	0.631070
1019.4	0.503000	0.433079	0.217839	0.645042
1019.5	0.504000	0.432987	0.218226	0.646187
1019.6	0.506000	0.432895	0.219045	0.648613
1019.7	0.509000	0.432803	0.220297	0.652320
1019.8	0.517000	0.432711	0.223712	0.662432
1019.9	0.519000	0.432619	0.224529	0.664853

1020.0	0.522000	0.432528	0.225779	0.668555
1020.1	0.528000	0.432369	0.228291	0.675992
1020.2	0.536000	0.432211	0.231665	0.685982
1020.3	0.544000	0.432053	0.235037	0.695966
1020.4	0.549000	0.431895	0.237110	0.702106
1020.5	0.559000	0.431737	0.241341	0.714634
1020.6	0.570000	0.431580	0.246000	0.728431
1020.7	0.576000	0.431422	0.248499	0.735830
1020.8	0.581000	0.431265	0.250565	0.741947
1020.9	0.583000	0.431108	0.251336	0.744230
1021.0	0.586000	0.430951	0.252537	0.747787
1021.1	0.592000	0.430794	0.255030	0.755168
1021.2	0.595000	0.430637	0.256229	0.758719
1021.3	0.599000	0.430480	0.257858	0.763542
1021.4	0.605000	0.430324	0.260346	0.770909
1021.5	0.612000	0.430167	0.263262	0.779545
1021.6	0.617000	0.430011	0.265317	0.785628
1021.7	0.623000	0.429854	0.267799	0.792980
1021.8	0.627000	0.429699	0.269421	0.797782
1021.9	0.632000	0.429543	0.271471	0.803852
1022.0	0.637000	0.429387	0.273520	0.809918
1022.1	0.640000	0.429310	0.274759	0.813587
1022.2	0.643000	0.429234	0.275997	0.817255
1022.3	0.647000	0.429157	0.277665	0.822192
1022.4	0.653000	0.429081	0.280190	0.829669
1022.5	0.658000	0.429004	0.282285	0.835873
1022.6	0.662000	0.428929	0.283951	0.840806
1022.7	0.665000	0.428853	0.285187	0.844467
1022.8	0.669000	0.428777	0.286852	0.849396
1022.9	0.673000	0.428701	0.288516	0.854324
1023.0	0.676000	0.428625	0.289751	0.857980
1023.1	0.679000	0.428547	0.290984	0.861631
1023.2	0.682000	0.428469	0.292216	0.865280
1023.3	0.686000	0.428391	0.293876	0.870196
1023.4	0.689000	0.428313	0.295108	0.873842
1023.5	0.692000	0.428235	0.296339	0.877487
1023.6	0.695000	0.428157	0.297569	0.881132
1023.7	0.698000	0.428080	0.298800	0.884775
1023.8	0.701000	0.428002	0.300029	0.888416
1023.9	0.703000	0.427924	0.300831	0.890789
1024.0	0.709000	0.427846	0.303343	0.898228
1024.1	0.710000	0.427720	0.303681	0.899229
1024.2	0.711000	0.427593	0.304019	0.900229

1024.3	0.714000	0.427467	0.305211	0.903760
1024.4	0.716000	0.427341	0.305976	0.906024
1024.5	0.718000	0.427215	0.306740	0.908287
1024.6	0.720000	0.427089	0.307504	0.910549
1024.7	0.722000	0.426963	0.308267	0.912810
1024.8	0.724000	0.426838	0.309031	0.915070
1024.9	0.726000	0.426713	0.309793	0.917328
1025.0	0.726000	0.426587	0.309702	0.917059
1025.1	0.726000	0.426465	0.309614	0.916796
1025.2	0.729000	0.426342	0.310804	0.920320
1025.3	0.731000	0.426220	0.311567	0.922580
1025.4	0.732000	0.426098	0.311904	0.923577
1025.5	0.733000	0.425976	0.312240	0.924574
1025.6	0.735000	0.425854	0.313003	0.926832
1025.7	0.737000	0.425733	0.313765	0.929089
1025.8	0.740000	0.425612	0.314953	0.932605
1025.9	0.740000	0.425491	0.314863	0.932340
1026.0	0.741000	0.425369	0.315199	0.933334
1026.1	0.743000	0.425194	0.315919	0.935468
1026.2	0.745000	0.425019	0.316639	0.937599
1026.3	0.746000	0.424845	0.316934	0.938472
1026.4	0.747000	0.424670	0.317229	0.939345
1026.5	0.749000	0.424496	0.317948	0.941474
1026.6	0.750000	0.424322	0.318242	0.942344
1026.7	0.751000	0.424148	0.318535	0.943214
1026.8	0.752000	0.423975	0.318829	0.944084
1026.9	0.755000	0.423802	0.319970	0.947463
1027.0	0.756000	0.423629	0.320263	0.948330
1027.1	0.757000	0.423456	0.320557	0.949199
1027.2	0.758000	0.423284	0.320850	0.950067
1027.3	0.760000	0.423112	0.321565	0.952187
1027.4	0.762000	0.422941	0.322281	0.954305
1027.5	0.762000	0.422769	0.322150	0.953918
1027.6	0.764000	0.422598	0.322865	0.956034
1027.7	0.766000	0.422427	0.323579	0.958149
1027.8	0.766000	0.422256	0.323448	0.957761
1027.9	0.768000	0.422085	0.324161	0.959872
1028.0	0.770000	0.421914	0.324874	0.961982
1028.1	0.770000	0.421775	0.324767	0.961666
1028.2	0.771000	0.421636	0.325082	0.962598
1028.3	0.774000	0.421498	0.326239	0.966026
1028.4	0.775000	0.421360	0.326554	0.966957
1028.5	0.776000	0.421222	0.326868	0.967888

1028.6	0.777000	0.421083	0.327182	0.968817
1028.7	0.779000	0.420945	0.327916	0.970992
1028.8	0.779000	0.420807	0.327809	0.970674
1028.9	0.781000	0.420670	0.328543	0.972848
1029.0	0.781000	0.420532	0.328435	0.972529
1029.1	0.783000	0.420395	0.329169	0.974702
1029.2	0.783000	0.420258	0.329062	0.974384
1029.3	0.784000	0.420121	0.329375	0.975311
1029.4	0.786000	0.419984	0.330107	0.977480
1029.5	0.787000	0.419847	0.330420	0.978404
1029.6	0.788000	0.419710	0.330731	0.979328
1029.7	0.790000	0.419573	0.331463	0.981493
1029.8	0.790000	0.419436	0.331355	0.981173
1029.9	0.791000	0.419300	0.331666	0.982095
1030.0	0.792000	0.419163	0.331977	0.983016
1030.1	0.792000	0.419089	0.331918	0.982842
1030.2	0.794000	0.419015	0.332698	0.985150
1030.3	0.795000	0.418941	0.333058	0.986216
1030.4	0.795000	0.418866	0.332999	0.986042
1030.5	0.796000	0.418792	0.333359	0.987107
1030.6	0.797000	0.418718	0.333718	0.988172
1030.7	0.799000	0.418644	0.334497	0.990477
1030.8	0.800000	0.418570	0.334856	0.991541
1030.9	0.799000	0.418496	0.334378	0.990127
1031.0	0.800000	0.418422	0.334738	0.991191
1031.1	0.802000	0.418350	0.335517	0.993498
1031.2	0.802000	0.418278	0.335459	0.993327
1031.3	0.802000	0.418206	0.335401	0.993156
1031.4	0.804000	0.418135	0.336180	0.995462
1031.5	0.804000	0.418063	0.336123	0.995291
1031.6	0.804000	0.417991	0.336064	0.995119
1031.7	0.805000	0.417918	0.336424	0.996185
1031.8	0.807000	0.417846	0.337202	0.998488
1031.9	0.806000	0.417774	0.336726	0.997079
1032.0	0.807000	0.417703	0.337086	0.998144
1032.1	0.808000	0.417574	0.337399	0.999072
1032.2	0.809000	0.417445	0.337713	1.000000
1032.3	0.809000	0.417315	0.337608	0.999691
1032.4	0.809000	0.417186	0.337504	0.999381
1032.5	0.809000	0.417057	0.337399	0.999071
1032.6	0.809000	0.416928	0.337295	0.998762
1032.7	0.809000	0.416799	0.337190	0.998452
1032.8	0.810000	0.416669	0.337502	0.999377

1032.9	0.810000	0.416540	0.337398	0.999067
1033.0	0.811000	0.416411	0.337709	0.999990
1033.1	0.810000	0.416282	0.337188	0.998446
1033.2	0.811000	0.416152	0.337499	0.999368
1033.3	0.811000	0.416022	0.337394	0.999057
1033.4	0.810000	0.415893	0.336873	0.997514
1033.5	0.810000	0.415763	0.336768	0.997203
1033.6	0.809000	0.415633	0.336247	0.995661
1033.7	0.809000	0.415503	0.336142	0.995350
1033.8	0.809000	0.415374	0.336037	0.995039
1033.9	0.809000	0.415244	0.335933	0.994729
1034.0	0.809000	0.415115	0.335828	0.994419
1034.1	0.808000	0.414875	0.335219	0.992615
1034.2	0.806000	0.414634	0.334195	0.989585
1034.3	0.806000	0.414394	0.334002	0.989011
1034.4	0.804000	0.414154	0.332980	0.985986
1034.5	0.804000	0.413914	0.332787	0.985414
1034.6	0.803000	0.413674	0.332180	0.983618
1034.7	0.800000	0.413434	0.330747	0.979374
1034.8	0.799000	0.413194	0.330142	0.977582
1034.9	0.798000	0.412954	0.329537	0.975791
1035.0	0.796000	0.412714	0.328520	0.972780
1035.1	0.790000	0.412473	0.325854	0.964885
1035.2	0.790000	0.412233	0.325664	0.964322
1035.3	0.789000	0.411992	0.325062	0.962540
1035.4	0.788000	0.411752	0.324460	0.960759
1035.5	0.784000	0.411511	0.322625	0.955324
1035.6	0.782000	0.411271	0.321614	0.952330
1035.7	0.780000	0.411031	0.320604	0.949340
1035.8	0.778000	0.410790	0.319595	0.946352
1035.9	0.773000	0.410550	0.317355	0.939719
1036.0	0.769000	0.410310	0.315528	0.934310
1036.1	0.766000	0.410199	0.314212	0.930413
1036.2	0.762000	0.410088	0.312487	0.925303
1036.3	0.757000	0.409976	0.310352	0.918983
1036.4	0.754000	0.409865	0.309038	0.915093
1036.5	0.750000	0.409754	0.307316	0.909992
1036.6	0.746000	0.409643	0.305594	0.904893
1036.7	0.740000	0.409532	0.303054	0.897371
1036.8	0.735000	0.409421	0.300924	0.891066
1036.9	0.733000	0.409310	0.300024	0.888400
1037.0	0.725000	0.409199	0.296669	0.878465
1037.1	0.711000	0.409085	0.290860	0.861264

1037.2	0.711000	0.408972	0.290779	0.861025
1037.3	0.706000	0.408859	0.288654	0.854734
1037.4	0.694000	0.408746	0.283670	0.839973
1037.5	0.690000	0.408633	0.281957	0.834901
1037.6	0.690000	0.408519	0.281878	0.834669
1037.7	0.683000	0.408406	0.278941	0.825973
1037.8	0.676000	0.408293	0.276006	0.817281
1037.9	0.661000	0.408180	0.269807	0.798925
1038.0	0.657000	0.408067	0.268100	0.793870
1038.1	0.654000	0.407985	0.266822	0.790086
1038.2	0.648000	0.407903	0.264321	0.782681
1038.3	0.646000	0.407821	0.263453	0.780108
1038.4	0.629000	0.407739	0.256468	0.759427
1038.5	0.616000	0.407658	0.251117	0.743582
1038.6	0.613000	0.407576	0.249844	0.739812
1038.7	0.609000	0.407494	0.248164	0.734837
1038.8	0.595000	0.407412	0.242410	0.717801
1038.9	0.589000	0.407331	0.239918	0.710420
1039.0	0.582000	0.407249	0.237019	0.701836
1039.1	0.576000	0.407166	0.234528	0.694460
1039.2	0.561000	0.407084	0.228374	0.676237
1039.3	0.558000	0.407001	0.227107	0.672485
1039.4	0.542000	0.406919	0.220550	0.653070
1039.5	0.517000	0.406836	0.210334	0.622820
1039.6	0.511000	0.406754	0.207851	0.615468
1039.7	0.505000	0.406672	0.205369	0.608118
1039.8	0.499000	0.406606	0.202896	0.600796
1039.9	0.473000	0.406541	0.192294	0.569400
1040.0	0.473000	0.406475	0.192263	0.569308
1040.1	0.465000	0.406333	0.188945	0.559485
1040.2	0.462000	0.406192	0.187661	0.555681
1040.3	0.458000	0.406050	0.185971	0.550678
1040.4	0.432000	0.405909	0.175353	0.519236
1040.5	0.424000	0.405767	0.172045	0.509443
1040.6	0.415000	0.405626	0.168335	0.498455
1040.7	0.406000	0.405484	0.164627	0.487475
1040.8	0.389000	0.405343	0.157678	0.466901
1040.9	0.381000	0.405201	0.154382	0.457139
1041.0	0.363000	0.405060	0.147037	0.435390
1041.1	0.362000	0.404922	0.146582	0.434042
1041.2	0.357000	0.404783	0.144508	0.427901
1041.3	0.351000	0.404644	0.142030	0.420565
1041.4	0.332000	0.404506	0.134296	0.397663

1041.5	0.328000	0.404367	0.132632	0.392738
1041.6	0.320000	0.404229	0.129353	0.383028
1041.7	0.312000	0.404091	0.126076	0.373324
1041.8	0.307000	0.403953	0.124014	0.367216
1041.9	0.305000	0.403815	0.123164	0.364699
1042.0	0.302000	0.403677	0.121910	0.360988
1042.1	0.296000	0.403494	0.119434	0.353656
1042.2	0.270000	0.403311	0.108894	0.322446
1042.3	0.259000	0.403129	0.104410	0.309169
1042.4	0.257000	0.402946	0.103557	0.306642
1042.5	0.254000	0.402763	0.102302	0.302925
1042.6	0.237000	0.402580	0.095411	0.282523
1042.7	0.232000	0.402397	0.093356	0.276437
1042.8	0.230000	0.402215	0.092509	0.273929
1042.9	0.218000	0.402032	0.087643	0.259520
1043.0	0.215000	0.401850	0.086398	0.255832
1043.1	0.210000	0.401667	0.084350	0.249769
1043.2	0.198000	0.401485	0.079494	0.235390
1043.3	0.193000	0.401303	0.077451	0.229341
1043.4	0.188000	0.401121	0.075411	0.223298
1043.5	0.182000	0.400939	0.072971	0.216074
1043.6	0.175000	0.400757	0.070132	0.207669
1043.7	0.172000	0.400575	0.068899	0.204016
1043.8	0.161000	0.400393	0.064463	0.190882
1043.9	0.155000	0.400211	0.062033	0.183685
1044.0	0.144000	0.400030	0.057604	0.170572
1044.1	0.142000	0.399880	0.056783	0.168140
1044.2	0.140000	0.399730	0.055962	0.165709
1044.3	0.134000	0.399580	0.053544	0.158548
1044.4	0.129000	0.399430	0.051527	0.152575
1044.5	0.123000	0.399281	0.049112	0.145424
1044.6	0.120000	0.399132	0.047896	0.141824
1044.7	0.115000	0.398982	0.045883	0.135864
1044.8	0.111000	0.398833	0.044270	0.131089
1044.9	0.108000	0.398684	0.043058	0.127499
1045.0	0.104000	0.398535	0.041448	0.122730
1045.1	0.099000	0.398389	0.039440	0.116787
1045.2	0.097000	0.398242	0.038629	0.114386
1045.3	0.095000	0.398096	0.037819	0.111986
1045.4	0.093000	0.397950	0.037009	0.109588
1045.5	0.086000	0.397803	0.034211	0.101302
1045.6	0.085000	0.397658	0.033801	0.100088
1045.7	0.081000	0.397512	0.032198	0.095343

1045.8	0.078000	0.397367	0.030995	0.091778
1045.9	0.076000	0.397222	0.030189	0.089392
1046.0	0.073000	0.397077	0.028987	0.085832
1046.1	0.069000	0.397042	0.027396	0.081122
1046.2	0.069000	0.397008	0.027394	0.081115
1046.3	0.068000	0.396973	0.026994	0.079932
1046.4	0.064000	0.396939	0.025404	0.075224
1046.5	0.061000	0.396905	0.024211	0.071692
1046.6	0.058000	0.396871	0.023019	0.068160
1046.7	0.057000	0.396838	0.022620	0.066979
1046.8	0.056000	0.396804	0.022221	0.065799
1046.9	0.055000	0.396770	0.021822	0.064618
1047.0	0.049000	0.396737	0.019440	0.057564
1047.1	0.049000	0.396707	0.019439	0.057560
1047.2	0.048000	0.396677	0.019041	0.056381
1047.3	0.045000	0.396648	0.017849	0.052853
1047.4	0.044000	0.396619	0.017451	0.051675
1047.5	0.043000	0.396590	0.017053	0.050497
1047.6	0.041000	0.396561	0.016259	0.048144
1047.7	0.039000	0.396532	0.015465	0.045793
1047.8	0.038000	0.396503	0.015067	0.044615
1047.9	0.037000	0.396475	0.014670	0.043438
1048.0	0.035000	0.396446	0.013876	0.041087
1048.1	0.034000	0.396358	0.013476	0.039904
1048.2	0.033000	0.396269	0.013077	0.038722
1048.3	0.031000	0.396181	0.012282	0.036367
1048.4	0.031000	0.396092	0.012279	0.036359
1048.5	0.030000	0.396004	0.011880	0.035178
1048.6	0.028000	0.395916	0.011086	0.032826
1048.7	0.028000	0.395828	0.011083	0.032818
1048.8	0.026000	0.395740	0.010289	0.030467
1048.9	0.026000	0.395652	0.010287	0.030461
1049.0	0.025000	0.395564	0.009889	0.029283
1049.1	0.025000	0.395476	0.009887	0.029276
1049.2	0.023000	0.395387	0.009094	0.026928
1049.3	0.022000	0.395299	0.008697	0.025751
1049.4	0.022000	0.395210	0.008695	0.025746
1049.5	0.020000	0.395122	0.007902	0.023400
1049.6	0.019000	0.395034	0.007506	0.022225
1049.7	0.019000	0.394946	0.007504	0.022220
1049.8	0.018000	0.394858	0.007107	0.021046
1049.9	0.018000	0.394770	0.007106	0.021041
1050.0	0.017000	0.394682	0.006710	0.019868

1050.1	0.017000	0.394540	0.006707	0.019861
1050.2	0.017000	0.394397	0.006705	0.019853
1050.3	0.015000	0.394254	0.005914	0.017511
1050.4	0.015000	0.394112	0.005912	0.017505
1050.5	0.015000	0.393969	0.005910	0.017499
1050.6	0.015000	0.393827	0.005907	0.017492
1050.7	0.015000	0.393684	0.005905	0.017486
1050.8	0.013000	0.393542	0.005116	0.015149
1050.9	0.013000	0.393399	0.005114	0.015144
1051.0	0.013000	0.393257	0.005112	0.015138
1051.1	0.011000	0.393111	0.004324	0.012804
1051.2	0.010000	0.392966	0.003930	0.011636
1051.3	0.011000	0.392821	0.004321	0.012795
1051.4	0.010000	0.392675	0.003927	0.011627
1051.5	0.009000	0.392530	0.003533	0.010461
1051.6	0.009000	0.392385	0.003531	0.010457
1051.7	0.008000	0.392240	0.003138	0.009292
1051.8	0.008000	0.392095	0.003137	0.009288
1051.9	0.008000	0.391950	0.003136	0.009285
1052.0	0.008000	0.391805	0.003134	0.009281
1052.1	0.008000	0.391707	0.003134	0.009279
1052.2	0.007000	0.391609	0.002741	0.008117
1052.3	0.007000	0.391512	0.002741	0.008115
1052.4	0.008000	0.391414	0.003131	0.009272
1052.5	0.007000	0.391316	0.002739	0.008111
1052.6	0.007000	0.391218	0.002739	0.008109
1052.7	0.007000	0.391121	0.002738	0.008107
1052.8	0.008000	0.391023	0.003128	0.009263
1052.9	0.008000	0.390925	0.003127	0.009261
1053.0	0.008000	0.390828	0.003127	0.009258
1053.1	0.007000	0.390728	0.002735	0.008099
1053.2	0.007000	0.390627	0.002734	0.008097
1053.3	0.007000	0.390528	0.002734	0.008095
1053.4	0.007000	0.390428	0.002733	0.008093
1053.5	0.007000	0.390328	0.002732	0.008091
1053.6	0.007000	0.390229	0.002732	0.008089
1053.7	0.008000	0.390129	0.003121	0.009242
1053.8	0.008000	0.390030	0.003120	0.009239
1053.9	0.008000	0.389930	0.003119	0.009237
1054.0	0.008000	0.389830	0.003119	0.009235
1054.1	0.008000	0.389662	0.003117	0.009231
1054.2	0.009000	0.389494	0.003505	0.010380
1054.3	0.009000	0.389326	0.003504	0.010375

1054.4	0.008000	0.389157	0.003113	0.009219
1054.5	0.008000	0.388989	0.003112	0.009215
1054.6	0.008000	0.388821	0.003111	0.009211
1054.7	0.008000	0.388653	0.003109	0.009207
1054.8	0.007000	0.388485	0.002719	0.008052
1054.9	0.006000	0.388318	0.002330	0.006899
1055.0	0.005000	0.388150	0.001941	0.005747
1055.1	0.005000	0.387980	0.001940	0.005744
1055.2	0.004000	0.387810	0.001551	0.004593
1055.3	0.004000	0.387639	0.001551	0.004591
1055.4	0.004000	0.387469	0.001550	0.004589
1055.5	0.004000	0.387299	0.001549	0.004587
1055.6	0.004000	0.387129	0.001549	0.004585
1055.7	0.003000	0.386960	0.001161	0.003437
1055.8	0.003000	0.386790	0.001160	0.003436
1055.9	0.002000	0.386621	0.000773	0.002290
1056.0	0.002000	0.386451	0.000773	0.002289
1056.1	0.002000	0.386319	0.000773	0.002288
1056.2	0.002000	0.386187	0.000772	0.002287
1056.3	0.002000	0.386055	0.000772	0.002286
1056.4	0.002000	0.385923	0.000772	0.002286
1056.5	0.002000	0.385791	0.000772	0.002285
1056.6	0.002000	0.385659	0.000771	0.002284
1056.7	0.001000	0.385527	0.000386	0.001142
1056.8	0.000000	0.385396	0.000000	0.000000
CHANNEL 10				
Wavenumber	HIRS Filter Transmittance	Optical Element Transmittance	Product of the HIRS Filter and Optical Element Transmittances	Normalized Value of Column 4
780.1	0.000124	0.445151	0.000055	0.000154
780.2	0.000247	0.445279	0.000110	0.000308
780.3	0.000369	0.445407	0.000165	0.000462
780.4	0.000492	0.445535	0.000219	0.000614
780.5	0.000613	0.445663	0.000273	0.000767
780.6	0.000735	0.445791	0.000327	0.000919
780.7	0.000855	0.445919	0.000381	0.001070
780.8	0.000976	0.446047	0.000435	0.001221
780.9	0.001096	0.446176	0.000489	0.001372
781.0	0.001216	0.446305	0.000543	0.001522
781.1	0.001336	0.446433	0.000596	0.001672
781.2	0.001455	0.446561	0.000650	0.001822
781.3	0.001574	0.446683	0.000703	0.001972

781.4	0.001693	0.446803	0.000756	0.002121
781.5	0.001811	0.446923	0.000810	0.002271
781.6	0.001930	0.447043	0.000863	0.002420
781.7	0.002048	0.447163	0.000916	0.002569
781.8	0.002167	0.447283	0.000969	0.002718
781.9	0.002285	0.447404	0.001022	0.002867
782.0	0.002403	0.447525	0.001075	0.003016
782.1	0.002521	0.447685	0.001129	0.003166
782.2	0.002639	0.447845	0.001182	0.003316
782.3	0.002758	0.448006	0.001235	0.003465
782.4	0.002876	0.448166	0.001289	0.003615
782.5	0.002994	0.448327	0.001342	0.003765
782.6	0.003113	0.448487	0.001396	0.003916
782.7	0.003232	0.448648	0.001450	0.004067
782.8	0.003350	0.448808	0.001504	0.004218
782.9	0.003469	0.448969	0.001558	0.004369
783.0	0.003589	0.449130	0.001612	0.004521
783.1	0.003708	0.449287	0.001666	0.004673
783.2	0.003828	0.449440	0.001721	0.004826
783.3	0.003948	0.449589	0.001775	0.004979
783.4	0.004069	0.449737	0.001830	0.005133
783.5	0.004190	0.449886	0.001885	0.005287
783.6	0.004311	0.450034	0.001940	0.005442
783.7	0.004433	0.450182	0.001996	0.005597
783.8	0.004555	0.450331	0.002051	0.005753
783.9	0.004678	0.450478	0.002107	0.005910
784.0	0.004801	0.450626	0.002163	0.006068
784.1	0.004924	0.450814	0.002220	0.006227
784.2	0.005049	0.451001	0.002277	0.006387
784.3	0.005174	0.451189	0.002334	0.006547
784.4	0.005299	0.451376	0.002392	0.006709
784.5	0.005425	0.451563	0.002450	0.006871
784.6	0.005552	0.451750	0.002508	0.007035
784.7	0.005679	0.451938	0.002567	0.007199
784.8	0.005808	0.452125	0.002626	0.007365
784.9	0.005937	0.452312	0.002685	0.007532
785.0	0.006066	0.452499	0.002745	0.007700
785.1	0.006197	0.452681	0.002805	0.007868
785.2	0.006328	0.452856	0.002866	0.008038
785.3	0.006461	0.453032	0.002927	0.008210
785.4	0.006594	0.453207	0.002988	0.008382
785.5	0.006728	0.453383	0.003050	0.008556
785.6	0.006863	0.453558	0.003113	0.008731

785.7	0.006999	0.453734	0.003176	0.008907
785.8	0.007136	0.453909	0.003239	0.009085
785.9	0.007274	0.454084	0.003303	0.009265
786.0	0.007413	0.454259	0.003368	0.009446
786.1	0.007554	0.454142	0.003430	0.009622
786.2	0.007695	0.454026	0.003494	0.009799
786.3	0.007837	0.453909	0.003557	0.009978
786.4	0.007981	0.453793	0.003622	0.010159
786.5	0.008126	0.453676	0.003686	0.010340
786.6	0.008272	0.453559	0.003752	0.010523
786.7	0.008419	0.453443	0.003818	0.010708
786.8	0.008568	0.453326	0.003884	0.010894
786.9	0.008718	0.453210	0.003951	0.011082
787.0	0.008869	0.453093	0.004018	0.011271
787.1	0.009022	0.452971	0.004087	0.011462
787.2	0.009176	0.452848	0.004155	0.011655
787.3	0.009331	0.452725	0.004224	0.011849
787.4	0.009488	0.452602	0.004294	0.012045
787.5	0.009646	0.452479	0.004365	0.012243
787.6	0.009806	0.452356	0.004436	0.012442
787.7	0.009968	0.452233	0.004508	0.012643
787.8	0.010132	0.452110	0.004581	0.012849
787.9	0.010308	0.451987	0.004659	0.013068
788.0	0.010512	0.451864	0.004750	0.013323
788.1	0.010755	0.451962	0.004861	0.013634
788.2	0.011052	0.452061	0.004996	0.014014
788.3	0.011418	0.452159	0.005163	0.014481
788.4	0.011863	0.452257	0.005365	0.015049
788.5	0.012387	0.452355	0.005603	0.015717
788.6	0.012986	0.452454	0.005876	0.016480
788.7	0.013651	0.452552	0.006178	0.017328
788.8	0.014377	0.452650	0.006508	0.018254
788.9	0.015158	0.452748	0.006863	0.019249
789.0	0.015988	0.452842	0.007240	0.020308
789.1	0.016861	0.452936	0.007637	0.021421
789.2	0.017770	0.453029	0.008050	0.022580
789.3	0.018709	0.453123	0.008477	0.023778
789.4	0.019674	0.453216	0.008917	0.025010
789.5	0.020667	0.453309	0.009369	0.026278
789.6	0.021698	0.453403	0.009838	0.027594
789.7	0.022773	0.453496	0.010327	0.028967
789.8	0.023900	0.453590	0.010841	0.030407
789.9	0.025087	0.453683	0.011382	0.031924

790.0	0.026342	0.453777	0.011953	0.033528
790.1	0.027672	0.453809	0.012558	0.035223
790.2	0.029084	0.453842	0.013200	0.037023
790.3	0.030588	0.453875	0.013883	0.038941
790.4	0.032190	0.453907	0.014611	0.040983
790.5	0.033904	0.453939	0.015390	0.043168
790.6	0.035745	0.453972	0.016227	0.045516
790.7	0.037728	0.454005	0.017129	0.048044
790.8	0.039867	0.454037	0.018101	0.050772
790.9	0.042179	0.454068	0.019152	0.053720
791.0	0.044677	0.454095	0.020288	0.056905
791.1	0.047377	0.454119	0.021515	0.060347
791.2	0.050293	0.454144	0.022840	0.064065
791.3	0.053441	0.454168	0.024271	0.068078
791.4	0.056836	0.454192	0.025814	0.072407
791.5	0.060491	0.454215	0.027476	0.077067
791.6	0.064418	0.454239	0.029261	0.082075
791.7	0.068631	0.454263	0.031177	0.087447
791.8	0.073142	0.454287	0.033227	0.093200
791.9	0.077963	0.454310	0.035419	0.099348
792.0	0.083109	0.454333	0.037759	0.105911
792.1	0.088591	0.454314	0.040248	0.112892
792.2	0.094423	0.454296	0.042896	0.120319
792.3	0.100620	0.454277	0.045709	0.128210
792.4	0.107180	0.454258	0.048687	0.136563
792.5	0.114130	0.454239	0.051842	0.145412
792.6	0.121460	0.454219	0.055169	0.154745
792.7	0.129180	0.454199	0.058673	0.164573
792.8	0.137290	0.454178	0.062354	0.174897
792.9	0.145800	0.454152	0.066215	0.185727
793.0	0.154700	0.454126	0.070253	0.197053
793.1	0.164000	0.454094	0.074471	0.208885
793.2	0.173710	0.454062	0.078875	0.221237
793.3	0.183830	0.454030	0.083464	0.234109
793.4	0.194350	0.453997	0.088234	0.247488
793.5	0.205280	0.453964	0.093190	0.261387
793.6	0.216590	0.453929	0.098317	0.275768
793.7	0.228260	0.453895	0.103606	0.290605
793.8	0.240280	0.453861	0.109054	0.305884
793.9	0.252630	0.453825	0.114650	0.321581
794.0	0.265290	0.453790	0.120386	0.337670
794.1	0.278240	0.453806	0.126267	0.354166
794.2	0.291480	0.453821	0.132280	0.371032

794.3	0.304970	0.453837	0.138407	0.388216
794.4	0.318710	0.453851	0.144647	0.405720
794.5	0.332660	0.453866	0.150983	0.423492
794.6	0.346800	0.453880	0.157406	0.441507
794.7	0.361100	0.453894	0.163901	0.459726
794.8	0.375520	0.453905	0.170450	0.478096
794.9	0.390040	0.453916	0.177045	0.496594
795.0	0.404620	0.453926	0.183668	0.515169
795.1	0.419250	0.453933	0.190312	0.533805
795.2	0.433880	0.453941	0.196956	0.552441
795.3	0.448480	0.453948	0.203586	0.571039
795.4	0.463040	0.453955	0.210199	0.589587
795.5	0.477510	0.453962	0.216771	0.608021
795.6	0.491860	0.453969	0.223289	0.626303
795.7	0.506070	0.453976	0.229743	0.644407
795.8	0.520100	0.453983	0.236116	0.662283
795.9	0.533910	0.453990	0.242390	0.679878
796.0	0.547480	0.453996	0.248554	0.697169
796.1	0.560780	0.453977	0.254581	0.714074
796.2	0.573770	0.453957	0.260467	0.730584
796.3	0.586410	0.453938	0.266194	0.746646
796.4	0.598690	0.453918	0.271756	0.762249
796.5	0.610580	0.453899	0.277141	0.777353
796.6	0.622080	0.453878	0.282349	0.791959
796.7	0.633170	0.453857	0.287368	0.806039
796.8	0.643840	0.453834	0.292196	0.819581
796.9	0.654080	0.453812	0.296829	0.832575
797.0	0.663890	0.453789	0.301266	0.845021
797.1	0.673240	0.453759	0.305488	0.856864
797.2	0.682140	0.453728	0.309506	0.868133
797.3	0.690570	0.453697	0.313310	0.878802
797.4	0.698520	0.453667	0.316895	0.888859
797.5	0.706000	0.453636	0.320267	0.898316
797.6	0.713020	0.453605	0.323429	0.907186
797.7	0.719590	0.453574	0.326387	0.915483
797.8	0.725720	0.453542	0.329145	0.923217
797.9	0.731430	0.453510	0.331711	0.930416
798.0	0.736720	0.453478	0.334087	0.937079
798.1	0.741610	0.453537	0.336348	0.943421
798.2	0.746100	0.453596	0.338428	0.949256
798.3	0.750220	0.453654	0.340341	0.954621
798.4	0.753970	0.453712	0.342085	0.959515
798.5	0.757370	0.453770	0.343672	0.963964

798.6	0.760450	0.453827	0.345113	0.968007
798.7	0.763230	0.453884	0.346418	0.971666
798.8	0.765740	0.453940	0.347600	0.974982
798.9	0.767990	0.453995	0.348664	0.977967
799.0	0.770010	0.454051	0.349624	0.980660
799.1	0.771820	0.454104	0.350486	0.983079
799.2	0.773450	0.454156	0.351267	0.985269
799.3	0.774920	0.454209	0.351975	0.987255
799.4	0.776260	0.454261	0.352625	0.989077
799.5	0.777470	0.454314	0.353215	0.990733
799.6	0.778570	0.454366	0.353756	0.992249
799.7	0.779570	0.454419	0.354251	0.993639
799.8	0.780470	0.454471	0.354701	0.994901
799.9	0.781300	0.454524	0.355120	0.996075
800.0	0.782050	0.454577	0.355502	0.997147
800.1	0.782740	0.454408	0.355684	0.997657
800.2	0.783380	0.454240	0.355842	0.998102
800.3	0.783980	0.454071	0.355983	0.998496
800.4	0.784550	0.453904	0.356110	0.998852
800.5	0.785090	0.453736	0.356223	0.999170
800.6	0.785600	0.453567	0.356322	0.999448
800.7	0.786060	0.453399	0.356399	0.999663
800.8	0.786490	0.453231	0.356462	0.999839
800.9	0.786870	0.453063	0.356502	0.999951
801.0	0.787200	0.452895	0.356519	1.000000
801.1	0.787480	0.452726	0.356513	0.999983
801.2	0.787710	0.452558	0.356484	0.999902
801.3	0.787870	0.452389	0.356424	0.999733
801.4	0.787980	0.452221	0.356341	0.999500
801.5	0.788020	0.452053	0.356226	0.999179
801.6	0.788000	0.451885	0.356085	0.998783
801.7	0.787920	0.451717	0.355917	0.998311
801.8	0.787770	0.451550	0.355717	0.997751
801.9	0.787550	0.451382	0.355486	0.997102
802.0	0.787260	0.451215	0.355223	0.996365
802.1	0.786910	0.451176	0.355035	0.995837
802.2	0.786490	0.451138	0.354815	0.995221
802.3	0.786010	0.451099	0.354569	0.994529
802.4	0.785450	0.451061	0.354286	0.993736
802.5	0.784820	0.451023	0.353972	0.992856
802.6	0.784130	0.450986	0.353631	0.991900
802.7	0.783370	0.450949	0.353260	0.990857
802.8	0.782560	0.450911	0.352865	0.989751

802.9	0.781680	0.450874	0.352439	0.988556
803.0	0.780750	0.450837	0.351991	0.987298
803.1	0.779760	0.450793	0.351510	0.985951
803.2	0.778720	0.450750	0.351008	0.984541
803.3	0.777620	0.450706	0.350478	0.983055
803.4	0.776480	0.450662	0.349930	0.981519
803.5	0.775290	0.450619	0.349360	0.979920
803.6	0.774060	0.450576	0.348773	0.978272
803.7	0.772770	0.450532	0.348158	0.976548
803.8	0.771440	0.450489	0.347526	0.974774
803.9	0.770050	0.450447	0.346866	0.972925
804.0	0.768620	0.450404	0.346189	0.971026
804.1	0.767140	0.450350	0.345482	0.969042
804.2	0.765600	0.450297	0.344748	0.966982
804.3	0.764020	0.450244	0.343995	0.964872
804.4	0.762390	0.450191	0.343221	0.962701
804.5	0.760710	0.450140	0.342426	0.960470
804.6	0.758990	0.450089	0.341613	0.958190
804.7	0.757230	0.450038	0.340782	0.955860
804.8	0.755440	0.449988	0.339939	0.953493
804.9	0.753610	0.449937	0.339077	0.951077
805.0	0.751760	0.449887	0.338207	0.948636
805.1	0.749880	0.449838	0.337325	0.946161
805.2	0.747990	0.449789	0.336438	0.943674
805.3	0.746080	0.449740	0.335542	0.941162
805.4	0.744160	0.449692	0.334642	0.938638
805.5	0.742230	0.449643	0.333738	0.936102
805.6	0.740270	0.449595	0.332821	0.933530
805.7	0.738280	0.449546	0.331891	0.930921
805.8	0.736250	0.449499	0.330943	0.928263
805.9	0.734160	0.449451	0.329969	0.925530
806.0	0.732020	0.449403	0.328972	0.922734
806.1	0.729820	0.449325	0.327926	0.919799
806.2	0.727540	0.449246	0.326844	0.916765
806.3	0.725180	0.449167	0.325727	0.913631
806.4	0.722730	0.449091	0.324571	0.910390
806.5	0.720180	0.449014	0.323371	0.907023
806.6	0.717500	0.448938	0.322113	0.903494
806.7	0.714690	0.448862	0.320797	0.899803
806.8	0.711720	0.448786	0.319410	0.895912
806.9	0.708580	0.448710	0.317947	0.891809
807.0	0.705260	0.448634	0.316404	0.887481
807.1	0.701740	0.448566	0.314777	0.882917

807.2	0.698000	0.448497	0.313051	0.878077
807.3	0.694020	0.448429	0.311219	0.872937
807.4	0.689800	0.448361	0.309279	0.867497
807.5	0.685310	0.448293	0.307219	0.861719
807.6	0.680540	0.448224	0.305035	0.855591
807.7	0.675480	0.448156	0.302720	0.849100
807.8	0.670110	0.448087	0.300268	0.842221
807.9	0.664420	0.448019	0.297673	0.834942
808.0	0.658400	0.447951	0.294931	0.827251
808.1	0.652020	0.447912	0.292048	0.819164
808.2	0.645290	0.447873	0.289008	0.810638
808.3	0.638170	0.447837	0.285796	0.801629
808.4	0.630660	0.447801	0.282410	0.792133
808.5	0.622770	0.447766	0.278855	0.782161
808.6	0.614490	0.447731	0.275126	0.771701
808.7	0.605840	0.447696	0.271232	0.760779
808.8	0.596810	0.447662	0.267169	0.749382
808.9	0.587430	0.447627	0.262950	0.737547
809.0	0.577680	0.447593	0.258565	0.725250
809.1	0.567590	0.447561	0.254031	0.712532
809.2	0.557160	0.447530	0.249346	0.699390
809.3	0.546390	0.447499	0.244509	0.685823
809.4	0.535300	0.447468	0.239530	0.671856
809.5	0.523890	0.447437	0.234408	0.657489
809.6	0.512210	0.447407	0.229166	0.642788
809.7	0.500270	0.447376	0.223809	0.627762
809.8	0.488090	0.447347	0.218345	0.612437
809.9	0.475710	0.447317	0.212793	0.596864
810.0	0.463140	0.447288	0.207157	0.581055
810.1	0.450420	0.447192	0.201424	0.564975
810.2	0.437570	0.447098	0.195637	0.548741
810.3	0.424600	0.447006	0.189799	0.532366
810.4	0.411560	0.446914	0.183932	0.515910
810.5	0.398460	0.446822	0.178041	0.499387
810.6	0.385330	0.446732	0.172139	0.482833
810.7	0.372210	0.446641	0.166244	0.466298
810.8	0.359110	0.446550	0.160360	0.449795
810.9	0.346080	0.446459	0.154510	0.433386
811.0	0.333130	0.446368	0.148698	0.417084
811.1	0.320290	0.446281	0.142939	0.400930
811.2	0.307600	0.446194	0.137249	0.384970
811.3	0.295080	0.446107	0.131637	0.369229
811.4	0.282760	0.446021	0.126117	0.353745

811.5	0.270660	0.445934	0.120697	0.338541
811.6	0.258790	0.445847	0.115381	0.323631
811.7	0.247170	0.445760	0.110179	0.309040
811.8	0.235820	0.445673	0.105099	0.294791
811.9	0.224750	0.445585	0.100145	0.280898
812.0	0.213970	0.445498	0.095323	0.267372
812.1	0.203520	0.445564	0.090681	0.254351
812.2	0.193390	0.445633	0.086181	0.241729
812.3	0.183610	0.445703	0.081835	0.229540
812.4	0.174200	0.445772	0.077653	0.217810
812.5	0.165140	0.445841	0.073626	0.206514
812.6	0.156450	0.445909	0.069762	0.195677
812.7	0.148110	0.445978	0.066054	0.185274
812.8	0.140120	0.446047	0.062500	0.175306
812.9	0.132480	0.446115	0.059101	0.165773
813.0	0.125180	0.446183	0.055853	0.156663
813.1	0.118230	0.446258	0.052761	0.147989
813.2	0.111610	0.446332	0.049815	0.139726
813.3	0.105320	0.446406	0.047015	0.131874
813.4	0.099359	0.446480	0.044362	0.124430
813.5	0.093718	0.446553	0.041850	0.117385
813.6	0.088386	0.446627	0.039476	0.110725
813.7	0.083351	0.446700	0.037233	0.104434
813.8	0.078603	0.446773	0.035118	0.098502
813.9	0.074129	0.446846	0.033124	0.092910
814.0	0.069920	0.446919	0.031249	0.087649
814.1	0.065965	0.446926	0.029481	0.082692
814.2	0.062251	0.446932	0.027822	0.078038
814.3	0.058770	0.446939	0.026267	0.073675
814.4	0.055508	0.446946	0.024809	0.069587
814.5	0.052455	0.446953	0.023445	0.065761
814.6	0.049598	0.446960	0.022168	0.062180
814.7	0.046925	0.446967	0.020974	0.058830
814.8	0.044423	0.446974	0.019856	0.055694
814.9	0.042081	0.446980	0.018809	0.052758
815.0	0.039885	0.446987	0.017828	0.050006
815.1	0.037823	0.447002	0.016907	0.047422
815.2	0.035884	0.447017	0.016041	0.044993
815.3	0.034054	0.447031	0.015223	0.042700
815.4	0.032322	0.447046	0.014449	0.040529
815.5	0.030682	0.447060	0.013717	0.038474
815.6	0.029130	0.447074	0.013023	0.036529
815.7	0.027662	0.447088	0.012367	0.034689

815.8	0.026274	0.447102	0.011747	0.032950
815.9	0.024963	0.447116	0.011161	0.031306
816.0	0.023723	0.447133	0.010607	0.029752
816.1	0.022553	0.447250	0.010087	0.028293
816.2	0.021447	0.447367	0.009595	0.026912
816.3	0.020402	0.447484	0.009130	0.025607
816.4	0.019414	0.447600	0.008690	0.024374
816.5	0.018480	0.447716	0.008274	0.023207
816.6	0.017598	0.447832	0.007881	0.022105
816.7	0.016765	0.447948	0.007510	0.021064
816.8	0.015978	0.448064	0.007159	0.020081
816.9	0.015235	0.448179	0.006828	0.019152
817.0	0.014533	0.448294	0.006515	0.018274
817.1	0.013870	0.448410	0.006219	0.017445
817.2	0.013242	0.448527	0.005939	0.016659
817.3	0.012648	0.448643	0.005674	0.015916
817.4	0.012086	0.448759	0.005424	0.015213
817.5	0.011551	0.448875	0.005185	0.014543
817.6	0.011042	0.448990	0.004958	0.013906
817.7	0.010556	0.449105	0.004741	0.013297
817.8	0.010091	0.449220	0.004533	0.012715
817.9	0.009644	0.449337	0.004333	0.012154
818.0	0.009214	0.449457	0.004141	0.011615
818.1	0.008800	0.449288	0.003954	0.011090
818.2	0.008403	0.449119	0.003774	0.010586
818.3	0.008023	0.448950	0.003602	0.010103
818.4	0.007658	0.448781	0.003437	0.009639
818.5	0.007308	0.448612	0.003278	0.009196
818.6	0.006973	0.448443	0.003127	0.008771
818.7	0.006653	0.448273	0.002982	0.008365
818.8	0.006347	0.448103	0.002844	0.007977
818.9	0.006055	0.447933	0.002712	0.007607
819.0	0.005776	0.447763	0.002586	0.007254
819.1	0.005510	0.447592	0.002466	0.006918
819.2	0.005258	0.447420	0.002352	0.006598
819.3	0.005017	0.447248	0.002244	0.006294
819.4	0.004789	0.447077	0.002141	0.006006
819.5	0.004572	0.446905	0.002043	0.005732
819.6	0.004367	0.446733	0.001951	0.005472
819.7	0.004173	0.446561	0.001863	0.005227
819.8	0.003989	0.446389	0.001781	0.004995
819.9	0.003815	0.446223	0.001703	0.004776
820.0	0.003652	0.446056	0.001629	0.004569

820.1	0.003498	0.446046	0.001560	0.004376
820.2	0.003353	0.446037	0.001495	0.004195
820.3	0.003216	0.446027	0.001435	0.004024
820.4	0.003089	0.446018	0.001378	0.003864
820.5	0.002969	0.446009	0.001324	0.003714
820.6	0.002857	0.445999	0.001274	0.003574
820.7	0.002752	0.445990	0.001227	0.003442
820.8	0.002654	0.445980	0.001184	0.003320
820.9	0.002563	0.445971	0.001143	0.003206
821.0	0.002478	0.445961	0.001105	0.003099
821.1	0.002398	0.445960	0.001070	0.003000
821.2	0.002325	0.445959	0.001037	0.002908
821.3	0.002256	0.445958	0.001006	0.002822
821.4	0.002192	0.445957	0.000978	0.002742
821.5	0.002133	0.445956	0.000951	0.002668
821.6	0.002077	0.445954	0.000926	0.002599
821.7	0.002026	0.445953	0.000903	0.002534
821.8	0.001977	0.445955	0.000882	0.002473
821.9	0.001932	0.445959	0.000862	0.002417
822.0	0.001889	0.445962	0.000842	0.002363
822.1	0.001848	0.445959	0.000824	0.002312
822.2	0.001810	0.445956	0.000807	0.002264
822.3	0.001772	0.445952	0.000790	0.002217
822.4	0.001736	0.445948	0.000774	0.002172
822.5	0.001701	0.445944	0.000758	0.002127
822.6	0.001666	0.445940	0.000743	0.002083
822.7	0.001631	0.445936	0.000727	0.002040
822.8	0.001595	0.445932	0.000711	0.001996
822.9	0.001559	0.445927	0.000695	0.001951
823.0	0.001523	0.445922	0.000679	0.001904
823.1	0.001484	0.445924	0.000662	0.001856
823.2	0.001444	0.445926	0.000644	0.001806
823.3	0.001401	0.445928	0.000625	0.001753
823.4	0.001357	0.445929	0.000605	0.001697
823.5	0.001309	0.445931	0.000584	0.001637
823.6	0.001258	0.445933	0.000561	0.001573
823.7	0.001203	0.445937	0.000537	0.001505
823.8	0.001145	0.445944	0.000510	0.001432
823.9	0.001082	0.445951	0.000482	0.001353
824.0	0.001014	0.445957	0.000452	0.001269
824.1	0.000941	0.446029	0.000420	0.001178
824.2	0.000863	0.446100	0.000385	0.001080
824.3	0.000780	0.446171	0.000348	0.000976

824.4	0.000690	0.446242	0.000308	0.000863
824.5	0.000593	0.446314	0.000265	0.000742
824.6	0.000490	0.446385	0.000219	0.000613
824.7	0.000379	0.446457	0.000169	0.000475
824.8	0.000261	0.446528	0.000116	0.000327
824.9	0.000135	0.446600	0.000060	0.000169
825.0	0.000000	0.446671	0.000000	0.000000
Channel 11				
Wavenumber	HIRS Filter Transmittance	Optical Element Transmittance	Product of the HIRS Filter and Optical Element Transmittances	Normalized Value of Column 4
1311.1	0.000099	0.282074	0.000028	0.000146
1311.2	0.000198	0.282109	0.000056	0.000292
1311.3	0.000297	0.282144	0.000084	0.000438
1311.4	0.000397	0.282180	0.000112	0.000585
1311.5	0.000497	0.282215	0.000140	0.000733
1311.6	0.000597	0.282250	0.000168	0.000881
1311.7	0.000697	0.282285	0.000197	0.001030
1311.8	0.000798	0.282317	0.000225	0.001178
1311.9	0.000899	0.282349	0.000254	0.001328
1312.0	0.001000	0.282381	0.000282	0.001477
1312.1	0.001057	0.282381	0.000299	0.001562
1312.2	0.001115	0.282380	0.000315	0.001646
1312.3	0.001172	0.282380	0.000331	0.001731
1312.4	0.001229	0.282380	0.000347	0.001816
1312.5	0.001287	0.282379	0.000363	0.001900
1312.6	0.001344	0.282379	0.000379	0.001985
1312.7	0.001401	0.282378	0.000396	0.002070
1312.8	0.001459	0.282378	0.000412	0.002155
1312.9	0.001516	0.282378	0.000428	0.002239
1313.0	0.001573	0.282378	0.000444	0.002324
1313.1	0.001631	0.282379	0.000460	0.002409
1313.2	0.001688	0.282379	0.000477	0.002493
1313.3	0.001745	0.282380	0.000493	0.002578
1313.4	0.001803	0.282380	0.000509	0.002663
1313.5	0.001860	0.282381	0.000525	0.002747
1313.6	0.001917	0.282381	0.000541	0.002832
1313.7	0.001975	0.282382	0.000558	0.002917
1313.8	0.002032	0.282383	0.000574	0.003001
1313.9	0.002089	0.282383	0.000590	0.003086
1314.0	0.002147	0.282384	0.000606	0.003171
1314.1	0.002204	0.282359	0.000622	0.003255

1314.2	0.002261	0.282335	0.000638	0.003339
1314.3	0.002318	0.282311	0.000655	0.003424
1314.4	0.002376	0.282286	0.000671	0.003508
1314.5	0.002433	0.282262	0.000687	0.003593
1314.6	0.002490	0.282237	0.000703	0.003677
1314.7	0.002548	0.282213	0.000719	0.003761
1314.8	0.002605	0.282189	0.000735	0.003845
1314.9	0.002662	0.282165	0.000751	0.003930
1315.0	0.002720	0.282141	0.000767	0.004014
1315.1	0.002777	0.282119	0.000783	0.004098
1315.2	0.002834	0.282098	0.000800	0.004183
1315.3	0.002892	0.282076	0.000816	0.004267
1315.4	0.002949	0.282055	0.000832	0.004351
1315.5	0.003006	0.282033	0.000848	0.004435
1315.6	0.003064	0.282012	0.000864	0.004520
1315.7	0.003121	0.281991	0.000880	0.004604
1315.8	0.003178	0.281970	0.000896	0.004688
1315.9	0.003236	0.281949	0.000912	0.004772
1316.0	0.003293	0.281927	0.000928	0.004856
1316.1	0.003350	0.282060	0.000945	0.004943
1316.2	0.003408	0.282192	0.000962	0.005030
1316.3	0.003465	0.282325	0.000978	0.005117
1316.4	0.003522	0.282457	0.000995	0.005204
1316.5	0.003580	0.282589	0.001012	0.005291
1316.6	0.003637	0.282722	0.001028	0.005379
1316.7	0.003694	0.282854	0.001045	0.005466
1316.8	0.003752	0.282987	0.001062	0.005554
1316.9	0.003809	0.283119	0.001078	0.005641
1317.0	0.003866	0.283251	0.001095	0.005728
1317.1	0.003924	0.283385	0.001112	0.005816
1317.2	0.003981	0.283519	0.001129	0.005904
1317.3	0.004038	0.283653	0.001145	0.005992
1317.4	0.004096	0.283787	0.001162	0.006080
1317.5	0.004153	0.283921	0.001179	0.006168
1317.6	0.004210	0.284055	0.001196	0.006256
1317.7	0.004267	0.284189	0.001213	0.006344
1317.8	0.004325	0.284323	0.001230	0.006432
1317.9	0.004382	0.284457	0.001247	0.006521
1318.0	0.004439	0.284591	0.001263	0.006609
1318.1	0.004497	0.284659	0.001280	0.006696
1318.2	0.004554	0.284728	0.001297	0.006783
1318.3	0.004612	0.284796	0.001313	0.006870
1318.4	0.004669	0.284865	0.001330	0.006957

1318.5	0.004726	0.284933	0.001347	0.007044
1318.6	0.004783	0.285001	0.001363	0.007131
1318.7	0.004841	0.285069	0.001380	0.007219
1318.8	0.004898	0.285138	0.001397	0.007306
1318.9	0.004955	0.285206	0.001413	0.007393
1319.0	0.005013	0.285274	0.001430	0.007480
1319.1	0.005070	0.285336	0.001447	0.007568
1319.2	0.005127	0.285399	0.001463	0.007655
1319.3	0.005185	0.285461	0.001480	0.007742
1319.4	0.005242	0.285523	0.001497	0.007829
1319.5	0.005299	0.285585	0.001513	0.007917
1319.6	0.005357	0.285647	0.001530	0.008004
1319.7	0.005414	0.285709	0.001547	0.008091
1319.8	0.005471	0.285771	0.001564	0.008179
1319.9	0.005529	0.285834	0.001580	0.008266
1320.0	0.005586	0.285896	0.001597	0.008354
1320.1	0.005643	0.285962	0.001614	0.008442
1320.2	0.005701	0.286029	0.001631	0.008529
1320.3	0.005758	0.286096	0.001647	0.008617
1320.4	0.005815	0.286162	0.001664	0.008705
1320.5	0.005873	0.286229	0.001681	0.008793
1320.6	0.005930	0.286295	0.001698	0.008881
1320.7	0.005987	0.286361	0.001715	0.008969
1320.8	0.006045	0.286428	0.001731	0.009057
1320.9	0.006102	0.286494	0.001748	0.009145
1321.0	0.006159	0.286560	0.001765	0.009233
1321.1	0.006217	0.286628	0.001782	0.009321
1321.2	0.006274	0.286695	0.001799	0.009409
1321.3	0.006331	0.286762	0.001816	0.009497
1321.4	0.006389	0.286829	0.001832	0.009585
1321.5	0.006446	0.286896	0.001849	0.009674
1321.6	0.006503	0.286963	0.001866	0.009762
1321.7	0.006561	0.287030	0.001883	0.009850
1321.8	0.006618	0.287097	0.001900	0.009939
1321.9	0.006675	0.287164	0.001917	0.010027
1322.0	0.006732	0.287231	0.001934	0.010116
1322.1	0.006790	0.287252	0.001950	0.010202
1322.2	0.006847	0.287274	0.001967	0.010289
1322.3	0.006905	0.287295	0.001984	0.010376
1322.4	0.006962	0.287316	0.002000	0.010463
1322.5	0.007019	0.287337	0.002017	0.010550
1322.6	0.007076	0.287358	0.002033	0.010637
1322.7	0.007134	0.287379	0.002050	0.010724

1322.8	0.007191	0.287400	0.002067	0.010811
1322.9	0.007248	0.287421	0.002083	0.010898
1323.0	0.007306	0.287442	0.002100	0.010985
1323.1	0.007363	0.287463	0.002117	0.011072
1323.2	0.007420	0.287484	0.002133	0.011159
1323.3	0.007478	0.287505	0.002150	0.011246
1323.4	0.007535	0.287526	0.002167	0.011333
1323.5	0.007592	0.287547	0.002183	0.011420
1323.6	0.007650	0.287568	0.002200	0.011507
1323.7	0.007707	0.287589	0.002216	0.011594
1323.8	0.007764	0.287610	0.002233	0.011681
1323.9	0.007822	0.287631	0.002250	0.011769
1324.0	0.007879	0.287652	0.002266	0.011856
1324.1	0.007936	0.287728	0.002283	0.011945
1324.2	0.007994	0.287804	0.002301	0.012034
1324.3	0.008051	0.287881	0.002318	0.012124
1324.4	0.008108	0.287957	0.002335	0.012214
1324.5	0.008166	0.288034	0.002352	0.012303
1324.6	0.008223	0.288110	0.002369	0.012393
1324.7	0.008280	0.288186	0.002386	0.012483
1324.8	0.008338	0.288263	0.002403	0.012572
1324.9	0.008395	0.288339	0.002421	0.012662
1325.0	0.008452	0.288415	0.002438	0.012752
1325.1	0.008510	0.288491	0.002455	0.012842
1325.2	0.008567	0.288567	0.002472	0.012932
1325.3	0.008624	0.288642	0.002489	0.013022
1325.4	0.008682	0.288718	0.002507	0.013112
1325.5	0.008739	0.288794	0.002524	0.013202
1325.6	0.008796	0.288870	0.002541	0.013292
1325.7	0.008854	0.288946	0.002558	0.013382
1325.8	0.008911	0.289021	0.002575	0.013472
1325.9	0.008968	0.289097	0.002593	0.013562
1326.0	0.009026	0.289173	0.002610	0.013653
1326.1	0.009083	0.289267	0.002627	0.013744
1326.2	0.009140	0.289360	0.002645	0.013835
1326.3	0.009198	0.289454	0.002662	0.013926
1326.4	0.009255	0.289548	0.002680	0.014018
1326.5	0.009312	0.289641	0.002697	0.014109
1326.6	0.009369	0.289735	0.002715	0.014200
1326.7	0.009427	0.289829	0.002732	0.014292
1326.8	0.009484	0.289923	0.002750	0.014383
1326.9	0.009541	0.290017	0.002767	0.014475
1327.0	0.009599	0.290110	0.002785	0.014567

1327.1	0.009656	0.290206	0.002802	0.014659
1327.2	0.009713	0.290301	0.002820	0.014750
1327.3	0.009771	0.290397	0.002837	0.014842
1327.4	0.009828	0.290492	0.002855	0.014934
1327.5	0.009885	0.290588	0.002873	0.015026
1327.6	0.009943	0.290684	0.002890	0.015119
1327.7	0.010000	0.290779	0.002908	0.015211
1327.8	0.009954	0.290875	0.002895	0.015146
1327.9	0.009917	0.290971	0.002885	0.015094
1328.0	0.009897	0.291067	0.002881	0.015068
1328.1	0.009905	0.291112	0.002884	0.015084
1328.2	0.009952	0.291158	0.002898	0.015157
1328.3	0.010047	0.291204	0.002926	0.015304
1328.4	0.010200	0.291249	0.002971	0.015540
1328.5	0.010419	0.291295	0.003035	0.015876
1328.6	0.010702	0.291341	0.003118	0.016310
1328.7	0.011044	0.291387	0.003218	0.016834
1328.8	0.011441	0.291433	0.003334	0.017442
1328.9	0.011887	0.291479	0.003465	0.018124
1329.0	0.012378	0.291525	0.003608	0.018876
1329.1	0.012910	0.291572	0.003764	0.019690
1329.2	0.013477	0.291618	0.003930	0.020559
1329.3	0.014075	0.291665	0.004105	0.021474
1329.4	0.014700	0.291712	0.004288	0.022431
1329.5	0.015347	0.291759	0.004478	0.023422
1329.6	0.016018	0.291806	0.004674	0.024450
1329.7	0.016713	0.291853	0.004878	0.025515
1329.8	0.017434	0.291900	0.005089	0.026620
1329.9	0.018184	0.291946	0.005309	0.027770
1330.0	0.018962	0.291993	0.005537	0.028963
1330.1	0.019772	0.292071	0.005775	0.030208
1330.2	0.020613	0.292150	0.006022	0.031502
1330.3	0.021489	0.292228	0.006280	0.032849
1330.4	0.022400	0.292306	0.006548	0.034251
1330.5	0.023348	0.292384	0.006827	0.035710
1330.6	0.024332	0.292462	0.007116	0.037225
1330.7	0.025353	0.292540	0.007417	0.038797
1330.8	0.026410	0.292618	0.007728	0.040425
1330.9	0.027503	0.292696	0.008050	0.042110
1331.0	0.028632	0.292774	0.008383	0.043850
1331.1	0.029797	0.292854	0.008726	0.045647
1331.2	0.030996	0.292934	0.009080	0.047496
1331.3	0.032231	0.293014	0.009444	0.049402

1331.4	0.033500	0.293093	0.009819	0.051361
1331.5	0.034804	0.293173	0.010204	0.053375
1331.6	0.036141	0.293253	0.010598	0.055440
1331.7	0.037513	0.293332	0.011004	0.057561
1331.8	0.038917	0.293412	0.011419	0.059731
1331.9	0.040353	0.293491	0.011843	0.061952
1332.0	0.041821	0.293571	0.012277	0.064223
1332.1	0.043320	0.293606	0.012719	0.066533
1332.2	0.044850	0.293641	0.013170	0.068891
1332.3	0.046410	0.293676	0.013629	0.071296
1332.4	0.048000	0.293711	0.014098	0.073747
1332.5	0.049619	0.293746	0.014575	0.076244
1332.6	0.051266	0.293781	0.015061	0.078784
1332.7	0.052941	0.293816	0.015555	0.081368
1332.8	0.054643	0.293851	0.016057	0.083994
1332.9	0.056372	0.293886	0.016567	0.086662
1333.0	0.058128	0.293921	0.017085	0.089372
1333.1	0.059909	0.293956	0.017611	0.092121
1333.2	0.061715	0.293990	0.018144	0.094909
1333.3	0.063545	0.294024	0.018684	0.097735
1333.4	0.065400	0.294058	0.019231	0.100599
1333.5	0.067278	0.294092	0.019786	0.103500
1333.6	0.069179	0.294126	0.020347	0.106437
1333.7	0.071103	0.294160	0.020916	0.109410
1333.8	0.073050	0.294194	0.021491	0.112419
1333.9	0.075020	0.294228	0.022073	0.115464
1334.0	0.077012	0.294262	0.022662	0.118544
1334.1	0.079026	0.294281	0.023256	0.121651
1334.2	0.081062	0.294300	0.023857	0.124793
1334.3	0.083120	0.294318	0.024464	0.127970
1334.4	0.085200	0.294337	0.025077	0.131180
1334.5	0.087301	0.294355	0.025697	0.134424
1334.6	0.089422	0.294374	0.026323	0.137698
1334.7	0.091561	0.294392	0.026955	0.141001
1334.8	0.093716	0.294410	0.027591	0.144328
1334.9	0.095886	0.294429	0.028232	0.147680
1335.0	0.098069	0.294448	0.028876	0.151051
1335.1	0.100260	0.294467	0.029523	0.154436
1335.2	0.102470	0.294487	0.030176	0.157851
1335.3	0.104680	0.294506	0.030829	0.161266
1335.4	0.106900	0.294526	0.031485	0.164697
1335.5	0.109120	0.294545	0.032141	0.168128
1335.6	0.111350	0.294564	0.032800	0.171576

1335.7	0.113580	0.294584	0.033459	0.175023
1335.8	0.115820	0.294603	0.034121	0.178487
1335.9	0.118060	0.294623	0.034783	0.181951
1336.0	0.120300	0.294642	0.035445	0.185415
1336.1	0.122550	0.294622	0.036106	0.188870
1336.2	0.124800	0.294601	0.036766	0.192324
1336.3	0.127050	0.294581	0.037426	0.195778
1336.4	0.129300	0.294560	0.038087	0.199231
1336.5	0.131550	0.294540	0.038747	0.202684
1336.6	0.133810	0.294519	0.039410	0.206152
1336.7	0.136080	0.294499	0.040075	0.209634
1336.8	0.138350	0.294478	0.040741	0.213117
1336.9	0.140630	0.294458	0.041410	0.216614
1337.0	0.142930	0.294438	0.042084	0.220142
1337.1	0.145240	0.294418	0.042761	0.223685
1337.2	0.147570	0.294399	0.043444	0.227258
1337.3	0.149930	0.294379	0.044136	0.230877
1337.4	0.152300	0.294360	0.044831	0.234511
1337.5	0.154700	0.294340	0.045534	0.238191
1337.6	0.157130	0.294321	0.046247	0.241916
1337.7	0.159580	0.294302	0.046965	0.245672
1337.8	0.162060	0.294282	0.047691	0.249474
1337.9	0.164570	0.294263	0.048427	0.253321
1338.0	0.167110	0.294244	0.049171	0.257214
1338.1	0.169690	0.294180	0.049919	0.261128
1338.2	0.172290	0.294116	0.050673	0.265072
1338.3	0.174930	0.294052	0.051439	0.269075
1338.4	0.177600	0.293988	0.052212	0.273123
1338.5	0.180310	0.293924	0.052998	0.277230
1338.6	0.183050	0.293861	0.053791	0.281382
1338.7	0.185850	0.293797	0.054602	0.285624
1338.8	0.188690	0.293734	0.055425	0.289926
1338.9	0.191590	0.293670	0.056264	0.294319
1339.0	0.194550	0.293607	0.057121	0.298801
1339.1	0.197570	0.293540	0.057995	0.303371
1339.2	0.200670	0.293474	0.058891	0.308061
1339.3	0.203840	0.293407	0.059808	0.312857
1339.4	0.207100	0.293341	0.060751	0.317788
1339.5	0.210440	0.293275	0.061717	0.322841
1339.6	0.213870	0.293209	0.062709	0.328029
1339.7	0.217390	0.293142	0.063726	0.333352
1339.8	0.221000	0.293076	0.064770	0.338811
1339.9	0.224710	0.293010	0.065842	0.344421

1340.0	0.228510	0.292944	0.066941	0.350166
1340.1	0.232410	0.292937	0.068081	0.356134
1340.2	0.236410	0.292930	0.069252	0.362255
1340.3	0.240500	0.292923	0.070448	0.368513
1340.4	0.244700	0.292915	0.071676	0.374939
1340.5	0.249000	0.292908	0.072934	0.381519
1340.6	0.253410	0.292901	0.074224	0.388266
1340.7	0.257920	0.292894	0.075543	0.395167
1340.8	0.262540	0.292887	0.076895	0.402236
1340.9	0.267270	0.292880	0.078278	0.409473
1341.0	0.272110	0.292873	0.079694	0.416878
1341.1	0.277060	0.292868	0.081142	0.424454
1341.2	0.282130	0.292863	0.082626	0.432214
1341.3	0.287310	0.292858	0.084141	0.440142
1341.4	0.292600	0.292853	0.085689	0.448239
1341.5	0.298010	0.292848	0.087272	0.456518
1341.6	0.303540	0.292843	0.088890	0.464982
1341.7	0.309180	0.292838	0.090540	0.473613
1341.8	0.314930	0.292833	0.092222	0.482413
1341.9	0.320790	0.292828	0.093936	0.491381
1342.0	0.326760	0.292823	0.095683	0.500516
1342.1	0.332840	0.292738	0.097435	0.509682
1342.2	0.339020	0.292653	0.099215	0.518995
1342.3	0.345310	0.292568	0.101027	0.528471
1342.4	0.351700	0.292483	0.102866	0.538094
1342.5	0.358190	0.292398	0.104734	0.547865
1342.6	0.364770	0.292314	0.106627	0.557767
1342.7	0.371430	0.292229	0.108543	0.567786
1342.8	0.378170	0.292144	0.110480	0.577922
1342.9	0.384970	0.292059	0.112434	0.588143
1343.0	0.391820	0.291975	0.114402	0.598435
1343.1	0.398720	0.291891	0.116383	0.608799
1343.2	0.405660	0.291808	0.118375	0.619219
1343.3	0.412620	0.291724	0.120371	0.629663
1343.4	0.419600	0.291641	0.122373	0.640131
1343.5	0.426590	0.291558	0.124376	0.650609
1343.6	0.433580	0.291474	0.126377	0.661080
1343.7	0.440550	0.291390	0.128372	0.671515
1343.8	0.447500	0.291307	0.130360	0.681913
1343.9	0.454420	0.291223	0.132338	0.692259
1344.0	0.461290	0.291140	0.134300	0.702523
1344.1	0.468100	0.291059	0.136245	0.712697
1344.2	0.474850	0.290979	0.138171	0.722773

1344.3	0.481520	0.290898	0.140073	0.732723
1344.4	0.488100	0.290817	0.141948	0.742529
1344.5	0.494580	0.290737	0.143792	0.752179
1344.6	0.500940	0.290656	0.145601	0.761641
1344.7	0.507170	0.290576	0.147371	0.770900
1344.8	0.513260	0.290495	0.149100	0.779941
1344.9	0.519180	0.290415	0.150778	0.788718
1345.0	0.524920	0.290334	0.152402	0.797217
1345.1	0.530470	0.290252	0.153970	0.805417
1345.2	0.535810	0.290170	0.155476	0.813294
1345.3	0.540930	0.290087	0.156917	0.820833
1345.4	0.545800	0.290005	0.158285	0.827988
1345.5	0.550420	0.289923	0.159579	0.834759
1345.6	0.554780	0.289840	0.160798	0.841133
1345.7	0.558890	0.289758	0.161943	0.847124
1345.8	0.562730	0.289676	0.163009	0.852703
1345.9	0.566320	0.289594	0.164003	0.857899
1346.0	0.569660	0.289512	0.164923	0.862713
1346.1	0.572730	0.289384	0.165739	0.866979
1346.2	0.575550	0.289256	0.166481	0.870863
1346.3	0.578100	0.289128	0.167145	0.874334
1346.4	0.580400	0.288999	0.167735	0.877424
1346.5	0.582440	0.288872	0.168250	0.880118
1346.6	0.584220	0.288744	0.168690	0.882418
1346.7	0.585740	0.288616	0.169054	0.884323
1346.8	0.586990	0.288489	0.169340	0.885819
1346.9	0.587990	0.288361	0.169554	0.886935
1347.0	0.588720	0.288234	0.169689	0.887643
1347.1	0.589190	0.288106	0.169749	0.887960
1347.2	0.589390	0.287979	0.169732	0.887870
1347.3	0.589330	0.287853	0.169640	0.887388
1347.4	0.589000	0.287726	0.169470	0.886500
1347.5	0.588410	0.287599	0.169226	0.885221
1347.6	0.587550	0.287472	0.168904	0.883537
1347.7	0.586460	0.287345	0.168516	0.881509
1347.8	0.585120	0.287218	0.168057	0.879107
1347.9	0.583550	0.287092	0.167532	0.876362
1348.0	0.581760	0.286965	0.166945	0.873288
1348.1	0.579760	0.286826	0.166290	0.869865
1348.2	0.577560	0.286688	0.165579	0.866146
1348.3	0.575170	0.286549	0.164814	0.862144
1348.4	0.572600	0.286411	0.163999	0.857878
1348.5	0.569850	0.286272	0.163132	0.853345

1348.6	0.566950	0.286134	0.162224	0.848592
1348.7	0.563890	0.285996	0.161270	0.843604
1348.8	0.560690	0.285857	0.160277	0.838410
1348.9	0.557350	0.285719	0.159245	0.833013
1349.0	0.553900	0.285581	0.158183	0.827456
1349.1	0.550340	0.285442	0.157090	0.821738
1349.2	0.546680	0.285303	0.155969	0.815875
1349.3	0.542930	0.285163	0.154824	0.809883
1349.4	0.539100	0.285024	0.153656	0.803777
1349.5	0.535200	0.284885	0.152470	0.797573
1349.6	0.531250	0.284746	0.151271	0.791300
1349.7	0.527250	0.284607	0.150059	0.784958
1349.8	0.523220	0.284468	0.148839	0.778578
1349.9	0.519160	0.284328	0.147612	0.772158
1350.0	0.515090	0.284189	0.146383	0.765730
1350.1	0.511020	0.284073	0.145167	0.759369
1350.2	0.506960	0.283957	0.143955	0.753027
1350.3	0.502910	0.283840	0.142746	0.746706
1350.4	0.498900	0.283724	0.141550	0.740448
1350.5	0.494930	0.283608	0.140366	0.734255
1350.6	0.491000	0.283492	0.139194	0.728126
1350.7	0.487130	0.283375	0.138041	0.722091
1350.8	0.483320	0.283259	0.136905	0.716150
1350.9	0.479570	0.283143	0.135787	0.710302
1351.0	0.475900	0.283027	0.134693	0.704577
1351.1	0.472290	0.282910	0.133616	0.698944
1351.2	0.468770	0.282794	0.132565	0.693449
1351.3	0.465340	0.282677	0.131541	0.688092
1351.4	0.462000	0.282561	0.130543	0.682872
1351.5	0.458760	0.282444	0.129574	0.677803
1351.6	0.455620	0.282328	0.128634	0.672886
1351.7	0.452580	0.282211	0.127723	0.668120
1351.8	0.449640	0.282095	0.126841	0.663505
1351.9	0.446810	0.281978	0.125991	0.659057
1352.0	0.444080	0.281861	0.125169	0.654759
1352.1	0.441470	0.281728	0.124375	0.650604
1352.2	0.438970	0.281596	0.123612	0.646615
1352.3	0.436580	0.281463	0.122881	0.642792
1352.4	0.434300	0.281331	0.122182	0.639133
1352.5	0.432140	0.281198	0.121517	0.635655
1352.6	0.430100	0.281065	0.120886	0.632355
1352.7	0.428170	0.280933	0.120287	0.629221
1352.8	0.426370	0.280800	0.119725	0.626280

1352.9	0.424680	0.280667	0.119194	0.623503
1353.0	0.423120	0.280534	0.118700	0.620918
1353.1	0.421680	0.280403	0.118240	0.618515
1353.2	0.420360	0.280271	0.117815	0.616289
1353.3	0.419170	0.280139	0.117426	0.614255
1353.4	0.418100	0.280007	0.117071	0.612398
1353.5	0.417160	0.279875	0.116753	0.610734
1353.6	0.416340	0.279743	0.116468	0.609246
1353.7	0.415650	0.279611	0.116220	0.607949
1353.8	0.415070	0.279479	0.116003	0.606813
1353.9	0.414610	0.279346	0.115820	0.605854
1354.0	0.414270	0.279214	0.115670	0.605070
1354.1	0.414040	0.279115	0.115565	0.604520
1354.2	0.413920	0.279016	0.115490	0.604130
1354.3	0.413910	0.278917	0.115447	0.603901
1354.4	0.414000	0.278818	0.115431	0.603818
1354.5	0.414200	0.278719	0.115445	0.603894
1354.6	0.414500	0.278619	0.115488	0.604116
1354.7	0.414900	0.278520	0.115558	0.604483
1354.8	0.415400	0.278420	0.115656	0.604996
1354.9	0.416000	0.278321	0.115782	0.605654
1355.0	0.416710	0.278222	0.115938	0.606471
1355.1	0.417510	0.278124	0.116119	0.607421
1355.2	0.418410	0.278025	0.116329	0.608515
1355.3	0.419410	0.277927	0.116565	0.609753
1355.4	0.420500	0.277829	0.116827	0.611122
1355.5	0.421690	0.277730	0.117116	0.612634
1355.6	0.422970	0.277632	0.117430	0.614276
1355.7	0.424350	0.277534	0.117771	0.616062
1355.8	0.425820	0.277435	0.118137	0.617977
1355.9	0.427370	0.277337	0.118525	0.620006
1356.0	0.429010	0.277238	0.118938	0.622165
1356.1	0.430740	0.277102	0.119359	0.624367
1356.2	0.432550	0.276966	0.119802	0.626682
1356.3	0.434430	0.276830	0.120263	0.629097
1356.4	0.436400	0.276694	0.120749	0.631639
1356.5	0.438440	0.276558	0.121254	0.634280
1356.6	0.440560	0.276422	0.121781	0.637034
1356.7	0.442750	0.276286	0.122326	0.639886
1356.8	0.445010	0.276150	0.122890	0.642835
1356.9	0.447340	0.276014	0.123472	0.645883
1357.0	0.449740	0.275878	0.124074	0.649029
1357.1	0.452210	0.275744	0.124694	0.652276

1357.2	0.454740	0.275610	0.125331	0.655606
1357.3	0.457340	0.275476	0.125986	0.659034
1357.4	0.460000	0.275342	0.126657	0.662545
1357.5	0.462720	0.275208	0.127344	0.666138
1357.6	0.465500	0.275074	0.128047	0.669814
1357.7	0.468320	0.274940	0.128760	0.673543
1357.8	0.471200	0.274806	0.129489	0.677356
1357.9	0.474130	0.274673	0.130231	0.681236
1358.0	0.477090	0.274539	0.130980	0.685156
1358.1	0.480100	0.274427	0.131752	0.689197
1358.2	0.483140	0.274315	0.132532	0.693277
1358.3	0.486200	0.274202	0.133317	0.697383
1358.4	0.489300	0.274090	0.134112	0.701542
1358.5	0.492420	0.273978	0.134912	0.705727
1358.6	0.495560	0.273867	0.135717	0.709937
1358.7	0.498720	0.273755	0.136527	0.714173
1358.8	0.501910	0.273643	0.137344	0.718448
1358.9	0.505120	0.273532	0.138166	0.722748
1359.0	0.508350	0.273420	0.138993	0.727073
1359.1	0.511610	0.273309	0.139828	0.731438
1359.2	0.514880	0.273198	0.140664	0.735814
1359.3	0.518180	0.273087	0.141508	0.740229
1359.4	0.521500	0.272976	0.142357	0.744668
1359.5	0.524840	0.272865	0.143210	0.749133
1359.6	0.528200	0.272754	0.144069	0.753624
1359.7	0.531570	0.272644	0.144929	0.758124
1359.8	0.534960	0.272533	0.145794	0.762650
1359.9	0.538350	0.272423	0.146659	0.767172
1360.0	0.541750	0.272313	0.147525	0.771705
1360.1	0.545140	0.272185	0.148379	0.776169
1360.2	0.548540	0.272057	0.149234	0.780643
1360.3	0.551920	0.271929	0.150083	0.785085
1360.4	0.555300	0.271801	0.150931	0.789522
1360.5	0.558660	0.271674	0.151773	0.793927
1360.6	0.562010	0.271547	0.152612	0.798313
1360.7	0.565340	0.271419	0.153444	0.802667
1360.8	0.568660	0.271292	0.154273	0.807002
1360.9	0.571950	0.271165	0.155093	0.811291
1361.0	0.575230	0.271038	0.155909	0.815560
1361.1	0.578480	0.270912	0.156717	0.819789
1361.2	0.581710	0.270787	0.157520	0.823986
1361.3	0.584920	0.270662	0.158316	0.828151
1361.4	0.588100	0.270538	0.159103	0.832269

1361.5	0.591250	0.270413	0.159881	0.836340
1361.6	0.594380	0.270288	0.160654	0.840380
1361.7	0.597480	0.270163	0.161417	0.844373
1361.8	0.600550	0.270038	0.162172	0.848320
1361.9	0.603590	0.269914	0.162917	0.852220
1362.0	0.606590	0.269789	0.163651	0.856061
1362.1	0.609570	0.269729	0.164418	0.860073
1362.2	0.612510	0.269668	0.165174	0.864028
1362.3	0.615420	0.269608	0.165922	0.867938
1362.4	0.618300	0.269547	0.166661	0.871804
1362.5	0.621140	0.269487	0.167389	0.875612
1362.6	0.623950	0.269426	0.168109	0.879376
1362.7	0.626720	0.269366	0.168817	0.883082
1362.8	0.629450	0.269305	0.169514	0.886729
1362.9	0.632150	0.269245	0.170203	0.890333
1363.0	0.634810	0.269185	0.170881	0.893880
1363.1	0.637440	0.269126	0.171552	0.897386
1363.2	0.640030	0.269067	0.172211	0.900835
1363.3	0.642580	0.269007	0.172859	0.904225
1363.4	0.645100	0.268948	0.173498	0.907571
1363.5	0.647580	0.268889	0.174127	0.910859
1363.6	0.650020	0.268830	0.174745	0.914089
1363.7	0.652430	0.268770	0.175354	0.917276
1363.8	0.654800	0.268711	0.175952	0.920405
1363.9	0.657140	0.268652	0.176542	0.923490
1364.0	0.659440	0.268592	0.177120	0.926517
1364.1	0.661700	0.268514	0.177676	0.929422
1364.2	0.663940	0.268436	0.178225	0.932296
1364.3	0.666140	0.268357	0.178763	0.935112
1364.4	0.668300	0.268279	0.179291	0.937870
1364.5	0.670430	0.268200	0.179810	0.940585
1364.6	0.672530	0.268122	0.180320	0.943255
1364.7	0.674600	0.268044	0.180822	0.945881
1364.8	0.676630	0.267965	0.181313	0.948449
1364.9	0.678630	0.267886	0.181796	0.950973
1365.0	0.680590	0.267808	0.182267	0.953440
1365.1	0.682520	0.267727	0.182729	0.955857
1365.2	0.684410	0.267647	0.183180	0.958216
1365.3	0.686270	0.267566	0.183623	0.960531
1365.4	0.688100	0.267486	0.184057	0.962803
1365.5	0.689890	0.267405	0.184480	0.965017
1365.6	0.691640	0.267325	0.184893	0.967174
1365.7	0.693360	0.267245	0.185297	0.969287

1365.8	0.695040	0.267164	0.185690	0.971344
1365.9	0.696670	0.267084	0.186069	0.973329
1366.0	0.698270	0.267003	0.186440	0.975270
1366.1	0.699820	0.266947	0.186815	0.977230
1366.2	0.701330	0.266891	0.187179	0.979133
1366.3	0.702790	0.266835	0.187529	0.980965
1366.4	0.704200	0.266779	0.187866	0.982727
1366.5	0.705560	0.266723	0.188189	0.984419
1366.6	0.706880	0.266667	0.188502	0.986053
1366.7	0.708140	0.266611	0.188798	0.987603
1366.8	0.709340	0.266555	0.189078	0.989069
1366.9	0.710490	0.266500	0.189345	0.990465
1367.0	0.711580	0.266444	0.189596	0.991777
1367.1	0.712610	0.266388	0.189831	0.993007
1367.2	0.713570	0.266333	0.190047	0.994139
1367.3	0.714470	0.266278	0.190248	0.995187
1367.4	0.715300	0.266223	0.190430	0.996137
1367.5	0.716060	0.266168	0.190593	0.996990
1367.6	0.716750	0.266114	0.190737	0.997745
1367.7	0.717360	0.266059	0.190860	0.998389
1367.8	0.717890	0.266004	0.190962	0.998922
1367.9	0.718340	0.265950	0.191042	0.999343
1368.0	0.718710	0.265895	0.191102	0.999653
1368.1	0.719000	0.265853	0.191148	0.999896
1368.2	0.719190	0.265810	0.191168	1.000000
1368.3	0.719290	0.265768	0.191164	0.999979
1368.4	0.719300	0.265725	0.191136	0.999833
1368.5	0.719210	0.265683	0.191082	0.999549
1368.6	0.719030	0.265640	0.191003	0.999139
1368.7	0.718740	0.265598	0.190896	0.998577
1368.8	0.718360	0.265556	0.190765	0.997891
1368.9	0.717880	0.265514	0.190607	0.997066
1369.0	0.717300	0.265472	0.190423	0.996102
1369.1	0.716630	0.265431	0.190216	0.995018
1369.2	0.715850	0.265390	0.189979	0.993782
1369.3	0.714970	0.265349	0.189717	0.992408
1369.4	0.714000	0.265309	0.189430	0.990910
1369.5	0.712930	0.265268	0.189117	0.989274
1369.6	0.711750	0.265227	0.188776	0.987485
1369.7	0.710470	0.265187	0.188407	0.985559
1369.8	0.709080	0.265146	0.188010	0.983480
1369.9	0.707580	0.265106	0.187584	0.981250
1370.0	0.705980	0.265065	0.187131	0.978882

1370.1	0.704260	0.265052	0.186665	0.976446
1370.2	0.702420	0.265038	0.186168	0.973844
1370.3	0.700470	0.265024	0.185641	0.971090
1370.4	0.698400	0.265010	0.185083	0.968170
1370.5	0.696210	0.264997	0.184493	0.965085
1370.6	0.693900	0.264983	0.183872	0.961834
1370.7	0.691460	0.264969	0.183216	0.958402
1370.8	0.688910	0.264956	0.182531	0.954818
1370.9	0.686250	0.264942	0.181816	0.951082
1371.0	0.683460	0.264928	0.181068	0.947167
1371.1	0.680570	0.264912	0.180291	0.943103
1371.2	0.677560	0.264895	0.179483	0.938874
1371.3	0.674430	0.264879	0.178642	0.934478
1371.4	0.671200	0.264862	0.177776	0.929945
1371.5	0.667860	0.264846	0.176880	0.925259
1371.6	0.664410	0.264829	0.175955	0.920423
1371.7	0.660860	0.264813	0.175004	0.915448
1371.8	0.657210	0.264796	0.174027	0.910335
1371.9	0.653480	0.264780	0.173028	0.905112
1372.0	0.649660	0.264764	0.172006	0.899765
1372.1	0.645750	0.264754	0.170965	0.894317
1372.2	0.641770	0.264744	0.169905	0.888773
1372.3	0.637720	0.264735	0.168827	0.883132
1372.4	0.633600	0.264725	0.167730	0.877394
1372.5	0.629420	0.264715	0.166617	0.871574
1372.6	0.625180	0.264706	0.165489	0.865672
1372.7	0.620880	0.264696	0.164345	0.859687
1372.8	0.616530	0.264687	0.163187	0.853633
1372.9	0.612140	0.264677	0.162020	0.847524
1373.0	0.607700	0.264668	0.160839	0.841347
1373.1	0.603220	0.264658	0.159647	0.835115
1373.2	0.598710	0.264649	0.158448	0.828843
1373.3	0.594170	0.264640	0.157241	0.822529
1373.4	0.589600	0.264631	0.156026	0.816174
1373.5	0.585010	0.264619	0.154805	0.809785
1373.6	0.580400	0.264608	0.153578	0.803369
1373.7	0.575770	0.264597	0.152347	0.796927
1373.8	0.571140	0.264585	0.151115	0.790485
1373.9	0.566500	0.264574	0.149881	0.784030
1374.0	0.561860	0.264563	0.148648	0.777576
1374.1	0.557220	0.264568	0.147423	0.771168
1374.2	0.552600	0.264573	0.146203	0.764789
1374.3	0.547990	0.264578	0.144986	0.758423

1374.4	0.543400	0.264583	0.143774	0.752085
1374.5	0.538830	0.264588	0.142568	0.745774
1374.6	0.534290	0.264593	0.141370	0.739505
1374.7	0.529760	0.264599	0.140174	0.733250
1374.8	0.525260	0.264604	0.138986	0.727037
1374.9	0.520780	0.264610	0.137804	0.720851
1375.0	0.516310	0.264616	0.136624	0.714679
1375.1	0.511860	0.264624	0.135451	0.708542
1375.2	0.507430	0.264633	0.134283	0.702433
1375.3	0.503010	0.264641	0.133117	0.696337
1375.4	0.498600	0.264650	0.131955	0.690254
1375.5	0.494210	0.264659	0.130797	0.684200
1375.6	0.489830	0.264668	0.129642	0.678158
1375.7	0.485470	0.264676	0.128492	0.672144
1375.8	0.481130	0.264685	0.127348	0.666158
1375.9	0.476820	0.264694	0.126212	0.660213
1376.0	0.472550	0.264703	0.125086	0.654323
1376.1	0.468300	0.264736	0.123976	0.648519
1376.2	0.464090	0.264769	0.122877	0.642769
1376.3	0.459920	0.264802	0.121788	0.637073
1376.4	0.455800	0.264835	0.120712	0.631444
1376.5	0.451720	0.264868	0.119646	0.625870
1376.6	0.447690	0.264902	0.118594	0.620364
1376.7	0.443700	0.264935	0.117552	0.614912
1376.8	0.439740	0.264968	0.116517	0.609500
1376.9	0.435810	0.265001	0.115490	0.604128
1377.0	0.431910	0.265034	0.114471	0.598797
1377.1	0.428040	0.265067	0.113459	0.593506
1377.2	0.424180	0.265101	0.112450	0.588228
1377.3	0.420330	0.265134	0.111444	0.582963
1377.4	0.416500	0.265168	0.110442	0.577724
1377.5	0.412670	0.265201	0.109441	0.572484
1377.6	0.408850	0.265234	0.108441	0.567255
1377.7	0.405030	0.265268	0.107441	0.562026
1377.8	0.401220	0.265301	0.106444	0.556810
1377.9	0.397410	0.265335	0.105447	0.551591
1378.0	0.393600	0.265368	0.104449	0.546372
1378.1	0.389800	0.265405	0.103455	0.541173
1378.2	0.386000	0.265443	0.102461	0.535973
1378.3	0.382200	0.265480	0.101467	0.530772
1378.4	0.378400	0.265518	0.100472	0.525568
1378.5	0.374600	0.265555	0.099477	0.520363
1378.6	0.370800	0.265592	0.098481	0.515157

1378.7	0.366990	0.265629	0.097483	0.509935
1378.8	0.363170	0.265666	0.096482	0.504697
1378.9	0.359330	0.265703	0.095475	0.499430
1379.0	0.355480	0.265740	0.094465	0.494148
1379.1	0.351600	0.265775	0.093446	0.488818
1379.2	0.347700	0.265809	0.092422	0.483459
1379.3	0.343770	0.265843	0.091389	0.478056
1379.4	0.339800	0.265877	0.090345	0.472595
1379.5	0.335800	0.265911	0.089293	0.467092
1379.6	0.331760	0.265945	0.088230	0.461531
1379.7	0.327700	0.265979	0.087161	0.455942
1379.8	0.323600	0.266013	0.086082	0.450294
1379.9	0.319480	0.266046	0.084997	0.444617
1380.0	0.315340	0.266080	0.083906	0.438910
1380.1	0.311180	0.266141	0.082818	0.433220
1380.2	0.307000	0.266202	0.081724	0.427498
1380.3	0.302800	0.266263	0.080624	0.421746
1380.4	0.298600	0.266324	0.079524	0.415991
1380.5	0.294390	0.266384	0.078421	0.410220
1380.6	0.290170	0.266445	0.077314	0.404431
1380.7	0.285930	0.266505	0.076202	0.398611
1380.8	0.281690	0.266565	0.075089	0.392789
1380.9	0.277430	0.266625	0.073970	0.386936
1381.0	0.273160	0.266684	0.072848	0.381066
1381.1	0.268870	0.266745	0.071720	0.375166
1381.2	0.264570	0.266806	0.070589	0.369251
1381.3	0.260240	0.266867	0.069449	0.363290
1381.4	0.255900	0.266927	0.068307	0.357313
1381.5	0.251540	0.266988	0.067158	0.351304
1381.6	0.247150	0.267048	0.066001	0.345251
1381.7	0.242760	0.267108	0.064843	0.339195
1381.8	0.238350	0.267168	0.063680	0.333108
1381.9	0.233940	0.267228	0.062515	0.327018
1382.0	0.229520	0.267288	0.061348	0.320911
1382.1	0.225100	0.267328	0.060176	0.314779
1382.2	0.220690	0.267369	0.059006	0.308659
1382.3	0.216290	0.267409	0.057838	0.302551
1382.4	0.211900	0.267450	0.056673	0.296455
1382.5	0.207530	0.267490	0.055512	0.290385
1382.6	0.203170	0.267530	0.054354	0.284326
1382.7	0.198840	0.267570	0.053204	0.278308
1382.8	0.194540	0.267610	0.052061	0.272331
1382.9	0.190260	0.267650	0.050923	0.266379

1383.0	0.186030	0.267690	0.049798	0.260495
1383.1	0.181830	0.267731	0.048682	0.254653
1383.2	0.177670	0.267772	0.047575	0.248866
1383.3	0.173560	0.267814	0.046482	0.243146
1383.4	0.169500	0.267855	0.045401	0.237495
1383.5	0.165490	0.267896	0.044334	0.231912
1383.6	0.161540	0.267937	0.043283	0.226411
1383.7	0.157650	0.267978	0.042247	0.220993
1383.8	0.153810	0.268019	0.041224	0.215643
1383.9	0.150020	0.268059	0.040214	0.210361
1384.0	0.146300	0.268100	0.039223	0.205176
1384.1	0.142640	0.268109	0.038243	0.200049
1384.2	0.139030	0.268117	0.037276	0.194993
1384.3	0.135480	0.268126	0.036326	0.190020
1384.4	0.132000	0.268135	0.035394	0.185145
1384.5	0.128580	0.268143	0.034478	0.180354
1384.6	0.125220	0.268151	0.033578	0.175646
1384.7	0.121920	0.268160	0.032694	0.171023
1384.8	0.118670	0.268168	0.031824	0.166469
1384.9	0.115490	0.268176	0.030972	0.162013
1385.0	0.112360	0.268185	0.030133	0.157627
1385.1	0.109290	0.268191	0.029311	0.153324
1385.2	0.106270	0.268197	0.028501	0.149090
1385.3	0.103310	0.268203	0.027708	0.144941
1385.4	0.100400	0.268209	0.026928	0.140861
1385.5	0.097542	0.268215	0.026162	0.136855
1385.6	0.094737	0.268221	0.025410	0.132922
1385.7	0.091985	0.268227	0.024673	0.129064
1385.8	0.089288	0.268233	0.023950	0.125283
1385.9	0.086647	0.268239	0.023242	0.121580
1386.0	0.084061	0.268245	0.022549	0.117954
1386.1	0.081533	0.268254	0.021872	0.114410
1386.2	0.079063	0.268263	0.021210	0.110948
1386.3	0.076651	0.268272	0.020563	0.107567
1386.4	0.074300	0.268281	0.019933	0.104271
1386.5	0.072009	0.268290	0.019319	0.101059
1386.6	0.069779	0.268299	0.018722	0.097933
1386.7	0.067609	0.268308	0.018140	0.094891
1386.8	0.065499	0.268317	0.017574	0.091932
1386.9	0.063450	0.268326	0.017025	0.089059
1387.0	0.061460	0.268335	0.016492	0.086269
1387.1	0.059531	0.268341	0.015975	0.083563
1387.2	0.057661	0.268348	0.015473	0.080940

1387.3	0.055851	0.268354	0.014988	0.078401
1387.4	0.054100	0.268360	0.014518	0.075945
1387.5	0.052408	0.268367	0.014065	0.073572
1387.6	0.050774	0.268373	0.013626	0.071280
1387.7	0.049194	0.268380	0.013203	0.069063
1387.8	0.047667	0.268387	0.012793	0.066921
1387.9	0.046191	0.268393	0.012397	0.064851
1388.0	0.044764	0.268400	0.012015	0.062849
1388.1	0.043384	0.268418	0.011645	0.060915
1388.2	0.042048	0.268435	0.011287	0.059043
1388.3	0.040754	0.268453	0.010941	0.057230
1388.4	0.039500	0.268471	0.010605	0.055473
1388.5	0.038285	0.268489	0.010279	0.053770
1388.6	0.037108	0.268507	0.009964	0.052120
1388.7	0.035970	0.268524	0.009659	0.050525
1388.8	0.034870	0.268542	0.009364	0.048983
1388.9	0.033809	0.268559	0.009080	0.047496
1389.0	0.032788	0.268577	0.008806	0.046065
1389.1	0.031806	0.268594	0.008543	0.044688
1389.2	0.030864	0.268611	0.008290	0.043367
1389.3	0.029962	0.268628	0.008049	0.042102
1389.4	0.029100	0.268646	0.007818	0.040894
1389.5	0.028278	0.268663	0.007597	0.039741
1389.6	0.027495	0.268680	0.007387	0.038643
1389.7	0.026748	0.268697	0.007187	0.037596
1389.8	0.026037	0.268714	0.006997	0.036599
1389.9	0.025359	0.268731	0.006815	0.035648
1390.0	0.024712	0.268748	0.006641	0.034741
1390.1	0.024094	0.268750	0.006475	0.033872
1390.2	0.023504	0.268753	0.006317	0.033043
1390.3	0.022940	0.268755	0.006165	0.032250
1390.4	0.022400	0.268757	0.006020	0.031492
1390.5	0.021882	0.268760	0.005881	0.030764
1390.6	0.021386	0.268762	0.005748	0.030066
1390.7	0.020910	0.268764	0.005620	0.029397
1390.8	0.020455	0.268766	0.005498	0.028758
1390.9	0.020019	0.268769	0.005380	0.028145
1391.0	0.019601	0.268771	0.005268	0.027558
1391.1	0.019201	0.268775	0.005161	0.026996
1391.2	0.018818	0.268780	0.005058	0.026458
1391.3	0.018451	0.268784	0.004959	0.025942
1391.4	0.018100	0.268789	0.004865	0.025449
1391.5	0.017763	0.268793	0.004775	0.024976

1391.6	0.017439	0.268797	0.004688	0.024521
1391.7	0.017125	0.268802	0.004603	0.024080
1391.8	0.016819	0.268806	0.004521	0.023650
1391.9	0.016517	0.268810	0.004440	0.023225
1392.0	0.016218	0.268815	0.004360	0.022805
1392.1	0.015919	0.268810	0.004279	0.022384
1392.2	0.015618	0.268805	0.004198	0.021961
1392.3	0.015313	0.268801	0.004116	0.021532
1392.4	0.015000	0.268796	0.004032	0.021091
1392.5	0.014679	0.268791	0.003946	0.020639
1392.6	0.014351	0.268787	0.003857	0.020178
1392.7	0.014020	0.268782	0.003768	0.019712
1392.8	0.013690	0.268778	0.003680	0.019248
1392.9	0.013363	0.268774	0.003592	0.018788
1393.0	0.013043	0.268770	0.003506	0.018338
1393.1	0.012734	0.268765	0.003422	0.017903
1393.2	0.012438	0.268760	0.003343	0.017486
1393.3	0.012159	0.268755	0.003268	0.017094
1393.4	0.011900	0.268751	0.003198	0.016729
1393.5	0.011664	0.268746	0.003135	0.016397
1393.6	0.011449	0.268741	0.003077	0.016095
1393.7	0.011255	0.268737	0.003025	0.015822
1393.8	0.011080	0.268733	0.002978	0.015576
1393.9	0.010922	0.268729	0.002935	0.015353
1394.0	0.010779	0.268724	0.002897	0.015152
1394.1	0.010650	0.268719	0.002862	0.014970
1394.2	0.010533	0.268714	0.002830	0.014806
1394.3	0.010427	0.268709	0.002802	0.014656
1394.4	0.010330	0.268704	0.002776	0.014520
1394.5	0.010240	0.268698	0.002751	0.014393
1394.6	0.010156	0.268694	0.002729	0.014275
1394.7	0.010077	0.268689	0.002708	0.014163
1394.8	0.010000	0.268684	0.002687	0.014055
1394.9	0.009948	0.268680	0.002673	0.013981
1395.0	0.009895	0.268676	0.002659	0.013907
1395.1	0.009843	0.268673	0.002645	0.013834
1395.2	0.009791	0.268670	0.002630	0.013760
1395.3	0.009738	0.268666	0.002616	0.013686
1395.4	0.009686	0.268664	0.002602	0.013613
1395.5	0.009634	0.268661	0.002588	0.013539
1395.6	0.009581	0.268659	0.002574	0.013465
1395.7	0.009529	0.268656	0.002560	0.013392
1395.8	0.009477	0.268654	0.002546	0.013318

1395.9	0.009424	0.268652	0.002532	0.013244
1396.0	0.009372	0.268650	0.002518	0.013171
1396.1	0.009320	0.268623	0.002504	0.013096
1396.2	0.009267	0.268596	0.002489	0.013021
1396.3	0.009215	0.268569	0.002475	0.012946
1396.4	0.009163	0.268543	0.002461	0.012871
1396.5	0.009111	0.268516	0.002446	0.012797
1396.6	0.009058	0.268489	0.002432	0.012722
1396.7	0.009006	0.268463	0.002418	0.012647
1396.8	0.008953	0.268437	0.002403	0.012572
1396.9	0.008901	0.268411	0.002389	0.012498
1397.0	0.008849	0.268384	0.002375	0.012423
1397.1	0.008797	0.268360	0.002361	0.012348
1397.2	0.008744	0.268335	0.002346	0.012274
1397.3	0.008692	0.268310	0.002332	0.012199
1397.4	0.008639	0.268286	0.002318	0.012125
1397.5	0.008587	0.268261	0.002304	0.012050
1397.6	0.008535	0.268237	0.002289	0.011976
1397.7	0.008483	0.268213	0.002275	0.011901
1397.8	0.008430	0.268188	0.002261	0.011827
1397.9	0.008378	0.268164	0.002247	0.011752
1398.0	0.008326	0.268140	0.002232	0.011678
1398.1	0.008273	0.268096	0.002218	0.011603
1398.2	0.008221	0.268051	0.002204	0.011527
1398.3	0.008169	0.268007	0.002189	0.011452
1398.4	0.008116	0.267963	0.002175	0.011377
1398.5	0.008064	0.267918	0.002160	0.011302
1398.6	0.008012	0.267874	0.002146	0.011226
1398.7	0.007959	0.267830	0.002132	0.011151
1398.8	0.007907	0.267787	0.002117	0.011076
1398.9	0.007855	0.267743	0.002103	0.011001
1399.0	0.007802	0.267699	0.002089	0.010926
1399.1	0.007750	0.267656	0.002074	0.010851
1399.2	0.007698	0.267612	0.002060	0.010776
1399.3	0.007645	0.267568	0.002046	0.010701
1399.4	0.007593	0.267524	0.002031	0.010626
1399.5	0.007541	0.267480	0.002017	0.010551
1399.6	0.007488	0.267437	0.002003	0.010476
1399.7	0.007436	0.267394	0.001988	0.010401
1399.8	0.007384	0.267351	0.001974	0.010326
1399.9	0.007331	0.267308	0.001960	0.010251
1400.0	0.007279	0.267264	0.001945	0.010177
1400.1	0.007227	0.267257	0.001931	0.010103

1400.2	0.007174	0.267249	0.001917	0.010030
1400.3	0.007122	0.267242	0.001903	0.009956
1400.4	0.007070	0.267235	0.001889	0.009883
1400.5	0.007017	0.267228	0.001875	0.009809
1400.6	0.006965	0.267220	0.001861	0.009736
1400.7	0.006913	0.267213	0.001847	0.009663
1400.8	0.006861	0.267206	0.001833	0.009589
1400.9	0.006808	0.267199	0.001819	0.009516
1401.0	0.006756	0.267191	0.001805	0.009442
1401.1	0.006704	0.267184	0.001791	0.009369
1401.2	0.006651	0.267178	0.001777	0.009296
1401.3	0.006599	0.267171	0.001763	0.009222
1401.4	0.006547	0.267164	0.001749	0.009149
1401.5	0.006494	0.267157	0.001735	0.009076
1401.6	0.006442	0.267150	0.001721	0.009002
1401.7	0.006390	0.267143	0.001707	0.008929
1401.8	0.006337	0.267136	0.001693	0.008856
1401.9	0.006285	0.267129	0.001679	0.008782
1402.0	0.006233	0.267122	0.001665	0.008709
1402.1	0.006180	0.267041	0.001650	0.008633
1402.2	0.006128	0.266960	0.001636	0.008557
1402.3	0.006076	0.266879	0.001621	0.008482
1402.4	0.006023	0.266799	0.001607	0.008406
1402.5	0.005971	0.266719	0.001593	0.008331
1402.6	0.005919	0.266638	0.001578	0.008255
1402.7	0.005866	0.266558	0.001564	0.008180
1402.8	0.005814	0.266478	0.001549	0.008104
1402.9	0.005762	0.266398	0.001535	0.008029
1403.0	0.005709	0.266319	0.001520	0.007954
1403.1	0.005657	0.266241	0.001506	0.007879
1403.2	0.005605	0.266162	0.001492	0.007803
1403.3	0.005552	0.266084	0.001477	0.007728
1403.4	0.005500	0.266006	0.001463	0.007653
1403.5	0.005448	0.265929	0.001449	0.007578
1403.6	0.005395	0.265851	0.001434	0.007503
1403.7	0.005343	0.265774	0.001420	0.007428
1403.8	0.005291	0.265697	0.001406	0.007353
1403.9	0.005238	0.265620	0.001391	0.007279
1404.0	0.005186	0.265542	0.001377	0.007204
1404.1	0.005134	0.265514	0.001363	0.007130
1404.2	0.005081	0.265486	0.001349	0.007057
1404.3	0.005029	0.265458	0.001335	0.006983
1404.4	0.004977	0.265430	0.001321	0.006910

1404.5	0.004924	0.265402	0.001307	0.006837
1404.6	0.004872	0.265375	0.001293	0.006763
1404.7	0.004820	0.265347	0.001279	0.006690
1404.8	0.004767	0.265320	0.001265	0.006617
1404.9	0.004715	0.265292	0.001251	0.006543
1405.0	0.004663	0.265264	0.001237	0.006470
1405.1	0.004611	0.265238	0.001223	0.006397
1405.2	0.004558	0.265212	0.001209	0.006324
1405.3	0.004506	0.265186	0.001195	0.006250
1405.4	0.004454	0.265159	0.001181	0.006177
1405.5	0.004401	0.265133	0.001167	0.006104
1405.6	0.004349	0.265107	0.001153	0.006031
1405.7	0.004297	0.265081	0.001139	0.005958
1405.8	0.004244	0.265054	0.001125	0.005885
1405.9	0.004192	0.265028	0.001111	0.005811
1406.0	0.004140	0.265002	0.001097	0.005738
1406.1	0.004087	0.264992	0.001083	0.005666
1406.2	0.004035	0.264982	0.001069	0.005593
1406.3	0.003983	0.264972	0.001055	0.005520
1406.4	0.003930	0.264962	0.001041	0.005447
1406.5	0.003878	0.264953	0.001027	0.005375
1406.6	0.003826	0.264942	0.001014	0.005302
1406.7	0.003773	0.264932	0.001000	0.005229
1406.8	0.003721	0.264922	0.000986	0.005156
1406.9	0.003669	0.264911	0.000972	0.005084
1407.0	0.003616	0.264901	0.000958	0.005011
1407.1	0.003564	0.264889	0.000944	0.004938
1407.2	0.003512	0.264877	0.000930	0.004866
1407.3	0.003459	0.264865	0.000916	0.004793
1407.4	0.003407	0.264852	0.000902	0.004720
1407.5	0.003355	0.264840	0.000888	0.004648
1407.6	0.003302	0.264827	0.000875	0.004575
1407.7	0.003250	0.264814	0.000861	0.004502
1407.8	0.003198	0.264801	0.000847	0.004429
1407.9	0.003145	0.264787	0.000833	0.004357
1408.0	0.003093	0.264774	0.000819	0.004284
1408.1	0.003041	0.264673	0.000805	0.004210
1408.2	0.002988	0.264572	0.000791	0.004136
1408.3	0.002936	0.264471	0.000776	0.004062
1408.4	0.002884	0.264370	0.000762	0.003988
1408.5	0.002831	0.264269	0.000748	0.003914
1408.6	0.002779	0.264167	0.000734	0.003840
1408.7	0.002727	0.264065	0.000720	0.003766

1408.8	0.002674	0.263963	0.000706	0.003693
1408.9	0.002622	0.263860	0.000692	0.003619
1409.0	0.002570	0.263758	0.000678	0.003546
1409.1	0.002517	0.263655	0.000664	0.003472
1409.2	0.002465	0.263553	0.000650	0.003398
1409.3	0.002413	0.263450	0.000636	0.003325
1409.4	0.002361	0.263346	0.000622	0.003252
1409.5	0.002308	0.263243	0.000608	0.003178
1409.6	0.002256	0.263139	0.000594	0.003105
1409.7	0.002204	0.263035	0.000580	0.003032
1409.8	0.002151	0.262930	0.000566	0.002959
1409.9	0.002099	0.262825	0.000552	0.002886
1410.0	0.002047	0.262720	0.000538	0.002812
1410.1	0.001994	0.262656	0.000524	0.002740
1410.2	0.001942	0.262593	0.000510	0.002667
1410.3	0.001889	0.262530	0.000496	0.002595
1410.4	0.001837	0.262466	0.000482	0.002522
1410.5	0.001785	0.262402	0.000468	0.002450
1410.6	0.001733	0.262337	0.000455	0.002378
1410.7	0.001680	0.262272	0.000441	0.002305
1410.8	0.001628	0.262207	0.000427	0.002233
1410.9	0.001576	0.262141	0.000413	0.002161
1411.0	0.001523	0.262076	0.000399	0.002088
1411.1	0.001471	0.262012	0.000385	0.002016
1411.2	0.001419	0.261949	0.000372	0.001944
1411.3	0.001366	0.261885	0.000358	0.001872
1411.4	0.001314	0.261821	0.000344	0.001800
1411.5	0.001262	0.261757	0.000330	0.001727
1411.6	0.001209	0.261693	0.000316	0.001655
1411.7	0.001157	0.261628	0.000303	0.001583
1411.8	0.001105	0.261563	0.000289	0.001511
1411.9	0.001052	0.261498	0.000275	0.001439
1412.0	0.001000	0.261433	0.000261	0.001368
1412.1	0.000906	0.261419	0.000237	0.001239
1412.2	0.000810	0.261405	0.000212	0.001108
1412.3	0.000714	0.261391	0.000187	0.000976
1412.4	0.000616	0.261377	0.000161	0.000842
1412.5	0.000516	0.261363	0.000135	0.000706
1412.6	0.000416	0.261348	0.000109	0.000568
1412.7	0.000314	0.261333	0.000082	0.000429
1412.8	0.000211	0.261318	0.000055	0.000288
1412.9	0.000106	0.261302	0.000028	0.000145
1413.0	0.000000	0.261287	0.000000	0.000000

Channel 12				
Wavenumber	HIRS Filter Transmittance	Optical Element Transmittance	Product of the HIRS Filter and Optical Element Transmittances	Normalized Value of Column 4
1488.3	0.001000	0.287981	0.000288	0.001626
1488.4	0.003000	0.287845	0.000864	0.004876
1488.5	0.004000	0.287709	0.001151	0.006498
1488.6	0.005000	0.287572	0.001438	0.008119
1488.7	0.004000	0.287436	0.001150	0.006492
1488.8	0.002000	0.287299	0.000575	0.003244
1488.9	0.001000	0.287162	0.000287	0.001621
1489.0	0.003000	0.287024	0.000861	0.004862
1489.1	0.004000	0.286888	0.001148	0.006479
1489.2	0.002000	0.286752	0.000574	0.003238
1489.3	0.001000	0.286615	0.000287	0.001618
1489.4	0.003000	0.286478	0.000859	0.004853
1489.5	0.006000	0.286341	0.001718	0.009701
1489.6	0.007000	0.286204	0.002003	0.011312
1489.7	0.007000	0.286067	0.002002	0.011306
1489.8	0.007000	0.285929	0.002002	0.011301
1489.9	0.007000	0.285792	0.002001	0.011296
1490.0	0.007000	0.285654	0.002000	0.011290
1490.1	0.006000	0.285504	0.001713	0.009672
1490.2	0.006000	0.285354	0.001712	0.009667
1490.3	0.005000	0.285204	0.001426	0.008052
1490.4	0.005000	0.285054	0.001425	0.008047
1490.5	0.005000	0.284903	0.001425	0.008043
1490.6	0.004000	0.284753	0.001139	0.006431
1490.7	0.005000	0.284602	0.001423	0.008035
1490.8	0.006000	0.284452	0.001707	0.009637
1490.9	0.006000	0.284301	0.001706	0.009631
1491.0	0.005000	0.284151	0.001421	0.008022
1491.1	0.006000	0.284001	0.001704	0.009621
1491.2	0.006000	0.283852	0.001703	0.009616
1491.3	0.007000	0.283702	0.001986	0.011213
1491.4	0.007000	0.283553	0.001985	0.011207
1491.5	0.007000	0.283404	0.001984	0.011201
1491.6	0.007000	0.283254	0.001983	0.011195
1491.7	0.007000	0.283105	0.001982	0.011189
1491.8	0.007000	0.282955	0.001981	0.011183
1491.9	0.007000	0.282806	0.001980	0.011178
1492.0	0.007000	0.282656	0.001979	0.011172

1492.1	0.007000	0.282583	0.001978	0.011169
1492.2	0.007000	0.282510	0.001978	0.011166
1492.3	0.007000	0.282437	0.001977	0.011163
1492.4	0.007000	0.282364	0.001977	0.011160
1492.5	0.006000	0.282291	0.001694	0.009563
1492.6	0.007000	0.282218	0.001976	0.011154
1492.7	0.007000	0.282145	0.001975	0.011151
1492.8	0.008000	0.282072	0.002257	0.012741
1492.9	0.008000	0.281999	0.002256	0.012738
1493.0	0.008000	0.281926	0.002255	0.012735
1493.1	0.008000	0.281855	0.002255	0.012731
1493.2	0.008000	0.281784	0.002254	0.012728
1493.3	0.008000	0.281712	0.002254	0.012725
1493.4	0.008000	0.281641	0.002253	0.012722
1493.5	0.009000	0.281570	0.002534	0.014308
1493.6	0.009000	0.281499	0.002533	0.014305
1493.7	0.008000	0.281428	0.002251	0.012712
1493.8	0.008000	0.281356	0.002251	0.012709
1493.9	0.009000	0.281285	0.002532	0.014294
1494.0	0.009000	0.281214	0.002531	0.014290
1494.1	0.009000	0.280960	0.002529	0.014277
1494.2	0.009000	0.280706	0.002526	0.014264
1494.3	0.009000	0.280452	0.002524	0.014252
1494.4	0.009000	0.280198	0.002522	0.014239
1494.5	0.009000	0.279944	0.002519	0.014226
1494.6	0.009000	0.279690	0.002517	0.014213
1494.7	0.009000	0.279437	0.002515	0.014200
1494.8	0.009000	0.279183	0.002513	0.014187
1494.9	0.009000	0.278928	0.002510	0.014174
1495.0	0.010000	0.278675	0.002787	0.015735
1495.1	0.011000	0.278421	0.003063	0.017292
1495.2	0.011000	0.278167	0.003060	0.017277
1495.3	0.012000	0.277913	0.003335	0.018830
1495.4	0.012000	0.277659	0.003332	0.018813
1495.5	0.012000	0.277406	0.003329	0.018796
1495.6	0.012000	0.277151	0.003326	0.018778
1495.7	0.012000	0.276897	0.003323	0.018761
1495.8	0.012000	0.276643	0.003320	0.018744
1495.9	0.012000	0.276388	0.003317	0.018727
1496.0	0.013000	0.276133	0.003590	0.020269
1496.1	0.013000	0.275913	0.003587	0.020252
1496.2	0.014000	0.275692	0.003860	0.021793
1496.3	0.015000	0.275471	0.004132	0.023331

1496.4	0.015000	0.275250	0.004129	0.023312
1496.5	0.015000	0.275029	0.004125	0.023293
1496.6	0.015000	0.274807	0.004122	0.023274
1496.7	0.016000	0.274585	0.004393	0.024806
1496.8	0.017000	0.274364	0.004664	0.026335
1496.9	0.017000	0.274142	0.004660	0.026314
1497.0	0.016000	0.273920	0.004383	0.024746
1497.1	0.016000	0.273698	0.004379	0.024726
1497.2	0.017000	0.273475	0.004649	0.026250
1497.3	0.018000	0.273253	0.004919	0.027771
1497.4	0.018000	0.273031	0.004915	0.027749
1497.5	0.019000	0.272808	0.005183	0.029266
1497.6	0.020000	0.272585	0.005452	0.030782
1497.7	0.020000	0.272362	0.005447	0.030756
1497.8	0.020000	0.272140	0.005443	0.030731
1497.9	0.020000	0.271917	0.005438	0.030706
1498.0	0.021000	0.271694	0.005706	0.032215
1498.1	0.022000	0.271557	0.005974	0.033732
1498.2	0.023000	0.271421	0.006243	0.035248
1498.3	0.023000	0.271285	0.006240	0.035230
1498.4	0.023000	0.271148	0.006236	0.035212
1498.5	0.023000	0.271012	0.006233	0.035195
1498.6	0.024000	0.270875	0.006501	0.036706
1498.7	0.025000	0.270738	0.006768	0.038216
1498.8	0.025000	0.270601	0.006765	0.038197
1498.9	0.025000	0.270464	0.006762	0.038178
1499.0	0.025000	0.270327	0.006758	0.038158
1499.1	0.026000	0.270188	0.007025	0.039664
1499.2	0.027000	0.270049	0.007291	0.041169
1499.3	0.027000	0.269910	0.007288	0.041147
1499.4	0.028000	0.269771	0.007554	0.042649
1499.5	0.029000	0.269632	0.007819	0.044150
1499.6	0.029000	0.269492	0.007815	0.044127
1499.7	0.030000	0.269353	0.008081	0.045625
1499.8	0.031000	0.269213	0.008346	0.047121
1499.9	0.030000	0.269074	0.008072	0.045578
1500.0	0.031000	0.268934	0.008337	0.047072
1500.1	0.033000	0.268778	0.008870	0.050080
1500.2	0.033000	0.268622	0.008865	0.050051
1500.3	0.033000	0.268466	0.008859	0.050022
1500.4	0.034000	0.268310	0.009123	0.051508
1500.5	0.035000	0.268153	0.009385	0.052992
1500.6	0.036000	0.267997	0.009648	0.054474

1500.7	0.036000	0.267841	0.009642	0.054443
1500.8	0.036000	0.267685	0.009637	0.054411
1500.9	0.038000	0.267528	0.010166	0.057400
1501.0	0.040000	0.267372	0.010695	0.060386
1501.1	0.041000	0.267215	0.010956	0.061859
1501.2	0.041000	0.267057	0.010949	0.061823
1501.3	0.041000	0.266900	0.010943	0.061786
1501.4	0.042000	0.266742	0.011203	0.063256
1501.5	0.044000	0.266584	0.011730	0.066229
1501.6	0.044000	0.266427	0.011723	0.066190
1501.7	0.045000	0.266269	0.011982	0.067654
1501.8	0.046000	0.266112	0.012241	0.069117
1501.9	0.046000	0.265955	0.012234	0.069076
1502.0	0.046000	0.265797	0.012227	0.069035
1502.1	0.049000	0.265625	0.013016	0.073489
1502.2	0.058000	0.265452	0.015396	0.086931
1502.3	0.067000	0.265280	0.017774	0.100355
1502.4	0.067000	0.265108	0.017762	0.100290
1502.5	0.068000	0.264935	0.018016	0.101720
1502.6	0.068000	0.264763	0.018004	0.101654
1502.7	0.074000	0.264591	0.019580	0.110552
1502.8	0.080000	0.264419	0.021154	0.119438
1502.9	0.084000	0.264247	0.022197	0.125328
1503.0	0.087000	0.264075	0.022975	0.129720
1503.1	0.088000	0.263902	0.023223	0.131125
1503.2	0.090000	0.263729	0.023736	0.134017
1503.3	0.092000	0.263556	0.024247	0.136905
1503.4	0.094000	0.263383	0.024758	0.139790
1503.5	0.100000	0.263210	0.026321	0.148615
1503.6	0.108000	0.263037	0.028408	0.160398
1503.7	0.114000	0.262865	0.029967	0.169198
1503.8	0.117000	0.262692	0.030735	0.173537
1503.9	0.119000	0.262520	0.031240	0.176388
1504.0	0.123000	0.262348	0.032269	0.182197
1504.1	0.128000	0.262122	0.033552	0.189440
1504.2	0.134000	0.261896	0.035094	0.198150
1504.3	0.137000	0.261670	0.035849	0.202411
1504.4	0.137000	0.261445	0.035818	0.202237
1504.5	0.138000	0.261219	0.036048	0.203537
1504.6	0.139000	0.260994	0.036278	0.204835
1504.7	0.140000	0.260769	0.036508	0.206131
1504.8	0.142000	0.260544	0.036997	0.208895
1504.9	0.151000	0.260319	0.039308	0.221943

1505.0	0.161000	0.260094	0.041875	0.236437
1505.1	0.163000	0.259869	0.042359	0.239167
1505.2	0.165000	0.259645	0.042841	0.241893
1505.3	0.168000	0.259420	0.043583	0.246078
1505.4	0.170000	0.259195	0.044063	0.248791
1505.5	0.185000	0.258970	0.047910	0.270509
1505.6	0.198000	0.258746	0.051232	0.289267
1505.7	0.200000	0.258522	0.051704	0.291935
1505.8	0.200000	0.258297	0.051659	0.291682
1505.9	0.201000	0.258073	0.051873	0.292886
1506.0	0.214000	0.257849	0.055180	0.311558
1506.1	0.231000	0.257686	0.059526	0.336096
1506.2	0.241000	0.257524	0.062063	0.350424
1506.3	0.242000	0.257362	0.062282	0.351657
1506.4	0.242000	0.257199	0.062242	0.351435
1506.5	0.243000	0.257037	0.062460	0.352665
1506.6	0.254000	0.256875	0.065246	0.368396
1506.7	0.261000	0.256713	0.067002	0.378310
1506.8	0.269000	0.256551	0.069012	0.389660
1506.9	0.280000	0.256389	0.071789	0.405338
1507.0	0.301000	0.256227	0.077124	0.435463
1507.1	0.328000	0.256065	0.083989	0.474225
1507.2	0.345000	0.255904	0.088287	0.498488
1507.3	0.352000	0.255742	0.090021	0.508281
1507.4	0.356000	0.255580	0.090986	0.513732
1507.5	0.363000	0.255418	0.092717	0.523502
1507.6	0.373000	0.255257	0.095211	0.537583
1507.7	0.381000	0.255095	0.097191	0.548766
1507.8	0.383000	0.254934	0.097640	0.551297
1507.9	0.387000	0.254772	0.098597	0.556702
1508.0	0.391000	0.254611	0.099553	0.562100
1508.1	0.406000	0.254482	0.103319	0.583367
1508.2	0.417000	0.254352	0.106065	0.598868
1508.3	0.423000	0.254223	0.107536	0.607175
1508.4	0.429000	0.254093	0.109006	0.615474
1508.5	0.436000	0.253964	0.110728	0.625199
1508.6	0.445000	0.253835	0.112956	0.637779
1508.7	0.451000	0.253705	0.114421	0.646049
1508.8	0.451000	0.253576	0.114363	0.645720
1508.9	0.452000	0.253447	0.114558	0.646822
1509.0	0.453000	0.253317	0.114753	0.647921
1509.1	0.457000	0.253188	0.115707	0.653310
1509.2	0.459000	0.253059	0.116154	0.655835

1509.3	0.468000	0.252931	0.118372	0.668354
1509.4	0.486000	0.252802	0.122862	0.693707
1509.5	0.500000	0.252673	0.126337	0.713327
1509.6	0.501000	0.252544	0.126525	0.714388
1509.7	0.502000	0.252415	0.126712	0.715449
1509.8	0.503000	0.252286	0.126900	0.716507
1509.9	0.504000	0.252157	0.127087	0.717564
1510.0	0.505000	0.252027	0.127274	0.718619
1510.1	0.509000	0.251865	0.128199	0.723845
1510.2	0.509000	0.251703	0.128117	0.723379
1510.3	0.515000	0.251541	0.129544	0.731434
1510.4	0.528000	0.251379	0.132728	0.749414
1510.5	0.540000	0.251216	0.135657	0.765951
1510.6	0.546000	0.251054	0.137075	0.773961
1510.7	0.547000	0.250891	0.137238	0.774877
1510.8	0.548000	0.250729	0.137399	0.775790
1510.9	0.548000	0.250566	0.137310	0.775287
1511.0	0.555000	0.250403	0.138974	0.784680
1511.1	0.559000	0.250241	0.139884	0.789822
1511.2	0.564000	0.250078	0.141044	0.796368
1511.3	0.579000	0.249915	0.144701	0.817016
1511.4	0.598000	0.249752	0.149352	0.843275
1511.5	0.610000	0.249589	0.152249	0.859635
1511.6	0.618000	0.249425	0.154145	0.870339
1511.7	0.625000	0.249262	0.155789	0.879621
1511.8	0.633000	0.249099	0.157679	0.890296
1511.9	0.637000	0.248935	0.158572	0.895334
1512.0	0.639000	0.248772	0.158965	0.897555
1512.1	0.640000	0.248633	0.159125	0.898460
1512.2	0.644000	0.248495	0.160031	0.903571
1512.3	0.650000	0.248356	0.161431	0.911481
1512.4	0.655000	0.248217	0.162582	0.917979
1512.5	0.656000	0.248079	0.162740	0.918867
1512.6	0.661000	0.247940	0.163888	0.925352
1512.7	0.674000	0.247801	0.167018	0.943022
1512.8	0.684000	0.247661	0.169400	0.956476
1512.9	0.684000	0.247522	0.169305	0.955938
1513.0	0.685000	0.247383	0.169457	0.956797
1513.1	0.686000	0.247242	0.169608	0.957648
1513.2	0.690000	0.247101	0.170500	0.962683
1513.3	0.694000	0.246960	0.171390	0.967711
1513.4	0.697000	0.246818	0.172032	0.971337
1513.5	0.700000	0.246677	0.172674	0.974959

1513.6	0.704000	0.246536	0.173561	0.979968
1513.7	0.708000	0.246394	0.174447	0.984971
1513.8	0.710000	0.246253	0.174840	0.987186
1513.9	0.712000	0.246111	0.175231	0.989397
1514.0	0.714000	0.245969	0.175622	0.991605
1514.1	0.715000	0.245876	0.175802	0.992618
1514.2	0.716000	0.245783	0.175981	0.993630
1514.3	0.716000	0.245694	0.175917	0.993269
1514.4	0.717000	0.245606	0.176099	0.994299
1514.5	0.718000	0.245517	0.176282	0.995328
1514.6	0.719000	0.245429	0.176463	0.996355
1514.7	0.719000	0.245340	0.176400	0.995996
1514.8	0.718000	0.245252	0.176091	0.994251
1514.9	0.718000	0.245163	0.176027	0.993892
1515.0	0.718000	0.245074	0.175963	0.993532
1515.1	0.718000	0.244983	0.175898	0.993162
1515.2	0.718000	0.244892	0.175832	0.992793
1515.3	0.718000	0.244801	0.175767	0.992422
1515.4	0.719000	0.244709	0.175946	0.993433
1515.5	0.718000	0.244618	0.175635	0.991680
1515.6	0.717000	0.244526	0.175325	0.989928
1515.7	0.716000	0.244434	0.175015	0.988177
1515.8	0.714000	0.244343	0.174461	0.985047
1515.9	0.713000	0.244251	0.174151	0.983298
1516.0	0.712000	0.244159	0.173841	0.981550
1516.1	0.710000	0.244042	0.173270	0.978324
1516.2	0.709000	0.243925	0.172943	0.976477
1516.3	0.708000	0.243808	0.172616	0.974631
1516.4	0.707000	0.243691	0.172289	0.972787
1516.5	0.706000	0.243574	0.171963	0.970944
1516.6	0.706000	0.243456	0.171880	0.970477
1516.7	0.704000	0.243339	0.171311	0.967262
1516.8	0.702000	0.243222	0.170742	0.964049
1516.9	0.699000	0.243105	0.169930	0.959467
1517.0	0.698000	0.242987	0.169605	0.957632
1517.1	0.697000	0.242870	0.169280	0.955796
1517.2	0.696000	0.242752	0.168955	0.953962
1517.3	0.693000	0.242634	0.168145	0.949389
1517.4	0.690000	0.242516	0.167336	0.944820
1517.5	0.688000	0.242398	0.166770	0.941624
1517.6	0.687000	0.242281	0.166447	0.939799
1517.7	0.685000	0.242163	0.165882	0.936608
1517.8	0.682000	0.242045	0.165075	0.932053

1517.9	0.680000	0.241928	0.164511	0.928868
1518.0	0.679000	0.241810	0.164189	0.927051
1518.1	0.677000	0.241749	0.163664	0.924089
1518.2	0.674000	0.241689	0.162898	0.919763
1518.3	0.672000	0.241628	0.162374	0.916804
1518.4	0.670000	0.241568	0.161850	0.913847
1518.5	0.667000	0.241507	0.161085	0.909527
1518.6	0.664000	0.241447	0.160321	0.905209
1518.7	0.661000	0.241386	0.159556	0.900894
1518.8	0.658000	0.241326	0.158792	0.896581
1518.9	0.655000	0.241265	0.158029	0.892270
1519.0	0.652000	0.241205	0.157266	0.887961
1519.1	0.649000	0.241144	0.156503	0.883652
1519.2	0.647000	0.241084	0.155981	0.880707
1519.3	0.644000	0.241023	0.155219	0.876402
1519.4	0.641000	0.240962	0.154457	0.872100
1519.5	0.639000	0.240901	0.153936	0.869160
1519.6	0.637000	0.240841	0.153416	0.866222
1519.7	0.635000	0.240780	0.152895	0.863285
1519.8	0.633000	0.240720	0.152376	0.860350
1519.9	0.632000	0.240660	0.152097	0.858776
1520.0	0.632000	0.240599	0.152059	0.858560
1520.1	0.632000	0.240552	0.152029	0.858392
1520.2	0.630000	0.240505	0.151518	0.855508
1520.3	0.628000	0.240458	0.151008	0.852626
1520.4	0.626000	0.240411	0.150497	0.849744
1520.5	0.625000	0.240364	0.150227	0.848221
1520.6	0.624000	0.240317	0.149958	0.846699
1520.7	0.623000	0.240270	0.149688	0.845178
1520.8	0.623000	0.240224	0.149660	0.845014
1520.9	0.623000	0.240178	0.149631	0.844851
1521.0	0.623000	0.240131	0.149602	0.844689
1521.1	0.623000	0.240083	0.149572	0.844518
1521.2	0.622000	0.240034	0.149301	0.842991
1521.3	0.622000	0.239986	0.149271	0.842822
1521.4	0.622000	0.239938	0.149242	0.842654
1521.5	0.623000	0.239890	0.149452	0.843840
1521.6	0.623000	0.239843	0.149422	0.843674
1521.7	0.623000	0.239796	0.149393	0.843508
1521.8	0.623000	0.239749	0.149364	0.843343
1521.9	0.623000	0.239702	0.149335	0.843179
1522.0	0.623000	0.239656	0.149306	0.843015
1522.1	0.623000	0.239687	0.149325	0.843127

1522.2	0.623000	0.239719	0.149345	0.843238
1522.3	0.623000	0.239751	0.149365	0.843351
1522.4	0.623000	0.239783	0.149385	0.843464
1522.5	0.624000	0.239815	0.149645	0.844931
1522.6	0.625000	0.239848	0.149905	0.846399
1522.7	0.626000	0.239880	0.150165	0.847868
1522.8	0.626000	0.239913	0.150185	0.847983
1522.9	0.627000	0.239945	0.150446	0.849453
1523.0	0.628000	0.239978	0.150706	0.850924
1523.1	0.628000	0.240011	0.150727	0.851042
1523.2	0.628000	0.240045	0.150748	0.851161
1523.3	0.628000	0.240079	0.150769	0.851280
1523.4	0.628000	0.240112	0.150790	0.851399
1523.5	0.628000	0.240146	0.150811	0.851518
1523.6	0.628000	0.240179	0.150833	0.851637
1523.7	0.628000	0.240213	0.150854	0.851756
1523.8	0.629000	0.240246	0.151115	0.853232
1523.9	0.630000	0.240280	0.151376	0.854708
1524.0	0.629000	0.240314	0.151157	0.853471
1524.1	0.630000	0.240319	0.151401	0.854845
1524.2	0.631000	0.240323	0.151644	0.856220
1524.3	0.631000	0.240328	0.151647	0.856237
1524.4	0.631000	0.240333	0.151650	0.856254
1524.5	0.632000	0.240338	0.151894	0.857629
1524.6	0.633000	0.240343	0.152137	0.859003
1524.7	0.634000	0.240348	0.152380	0.860377
1524.8	0.633000	0.240352	0.152143	0.859036
1524.9	0.634000	0.240356	0.152386	0.860408
1525.0	0.636000	0.240361	0.152869	0.863137
1525.1	0.637000	0.240365	0.153112	0.864509
1525.2	0.637000	0.240369	0.153115	0.864524
1525.3	0.638000	0.240373	0.153358	0.865895
1525.4	0.640000	0.240376	0.153841	0.868623
1525.5	0.642000	0.240380	0.154324	0.871350
1525.6	0.643000	0.240383	0.154566	0.872719
1525.7	0.644000	0.240386	0.154809	0.874088
1525.8	0.644000	0.240389	0.154811	0.874098
1525.9	0.645000	0.240392	0.155053	0.875466
1526.0	0.645000	0.240395	0.155055	0.875476
1526.1	0.646000	0.240423	0.155313	0.876936
1526.2	0.647000	0.240451	0.155572	0.878396
1526.3	0.648000	0.240479	0.155830	0.879856
1526.4	0.650000	0.240506	0.156329	0.882672

1526.5	0.651000	0.240534	0.156588	0.884131
1526.6	0.652000	0.240561	0.156846	0.885589
1526.7	0.654000	0.240588	0.157344	0.888404
1526.8	0.656000	0.240614	0.157843	0.891219
1526.9	0.658000	0.240640	0.158341	0.894032
1527.0	0.661000	0.240666	0.159080	0.898205
1527.1	0.662000	0.240690	0.159337	0.899654
1527.2	0.663000	0.240714	0.159594	0.901104
1527.3	0.664000	0.240738	0.159850	0.902553
1527.4	0.666000	0.240761	0.160347	0.905359
1527.5	0.668000	0.240785	0.160844	0.908165
1527.6	0.670000	0.240807	0.161341	0.910968
1527.7	0.671000	0.240829	0.161596	0.912412
1527.8	0.673000	0.240851	0.162093	0.915214
1527.9	0.674000	0.240872	0.162348	0.916654
1528.0	0.675000	0.240893	0.162603	0.918095
1528.1	0.676000	0.240941	0.162876	0.919637
1528.2	0.678000	0.240988	0.163390	0.922540
1528.3	0.681000	0.241035	0.164145	0.926803
1528.4	0.683000	0.241082	0.164659	0.929704
1528.5	0.684000	0.241128	0.164932	0.931244
1528.6	0.685000	0.241173	0.165204	0.932780
1528.7	0.686000	0.241218	0.165476	0.934316
1528.8	0.688000	0.241263	0.165989	0.937212
1528.9	0.689000	0.241306	0.166260	0.938744
1529.0	0.692000	0.241350	0.167014	0.943002
1529.1	0.695000	0.241392	0.167767	0.947255
1529.2	0.696000	0.241434	0.168038	0.948782
1529.3	0.697000	0.241475	0.168308	0.950307
1529.4	0.700000	0.241515	0.169060	0.954556
1529.5	0.703000	0.241555	0.169813	0.958806
1529.6	0.703000	0.241593	0.169840	0.958959
1529.7	0.703000	0.241632	0.169867	0.959112
1529.8	0.704000	0.241670	0.170135	0.960626
1529.9	0.706000	0.241707	0.170645	0.963502
1530.0	0.707000	0.241743	0.170913	0.965014
1530.1	0.708000	0.241791	0.171188	0.966568
1530.2	0.710000	0.241838	0.171705	0.969488
1530.3	0.711000	0.241884	0.171980	0.971040
1530.4	0.712000	0.241930	0.172254	0.972590
1530.5	0.714000	0.241976	0.172771	0.975506
1530.6	0.715000	0.242020	0.173044	0.977051
1530.7	0.717000	0.242064	0.173560	0.979962

1530.8	0.718000	0.242108	0.173833	0.981505
1530.9	0.719000	0.242150	0.174106	0.983046
1531.0	0.720000	0.242193	0.174379	0.984586
1531.1	0.720000	0.242235	0.174409	0.984756
1531.2	0.721000	0.242277	0.174681	0.986294
1531.3	0.721000	0.242318	0.174711	0.986461
1531.4	0.721000	0.242358	0.174740	0.986625
1531.5	0.721000	0.242398	0.174769	0.986789
1531.6	0.721000	0.242438	0.174798	0.986950
1531.7	0.721000	0.242477	0.174826	0.987110
1531.8	0.722000	0.242516	0.175097	0.988638
1531.9	0.722000	0.242554	0.175124	0.988793
1532.0	0.722000	0.242592	0.175152	0.988949
1532.1	0.723000	0.242697	0.175470	0.990745
1532.2	0.723000	0.242801	0.175545	0.991171
1532.3	0.723000	0.242905	0.175620	0.991595
1532.4	0.722000	0.243009	0.175452	0.990646
1532.5	0.722000	0.243112	0.175527	0.991067
1532.6	0.722000	0.243215	0.175601	0.991486
1532.7	0.722000	0.243317	0.175675	0.991904
1532.8	0.722000	0.243419	0.175749	0.992320
1532.9	0.722000	0.243521	0.175822	0.992736
1533.0	0.722000	0.243623	0.175896	0.993152
1533.1	0.722000	0.243724	0.175969	0.993564
1533.2	0.723000	0.243825	0.176286	0.995352
1533.3	0.723000	0.243926	0.176359	0.995763
1533.4	0.724000	0.244027	0.176675	0.997551
1533.5	0.723000	0.244127	0.176504	0.996584
1533.6	0.723000	0.244227	0.176576	0.996992
1533.7	0.723000	0.244327	0.176648	0.997400
1533.8	0.724000	0.244427	0.176965	0.999187
1533.9	0.724000	0.244526	0.177037	0.999594
1534.0	0.724000	0.244626	0.177109	1.000000
1534.1	0.724000	0.244621	0.177106	0.999982
1534.2	0.724000	0.244617	0.177102	0.999963
1534.3	0.724000	0.244612	0.177099	0.999945
1534.4	0.724000	0.244608	0.177096	0.999926
1534.5	0.724000	0.244603	0.177093	0.999908
1534.6	0.723000	0.244599	0.176845	0.998508
1534.7	0.723000	0.244594	0.176841	0.998489
1534.8	0.722000	0.244589	0.176593	0.997089
1534.9	0.722000	0.244585	0.176590	0.997071
1535.0	0.722000	0.244580	0.176587	0.997052

1535.1	0.721000	0.244575	0.176339	0.995652
1535.2	0.720000	0.244571	0.176091	0.994252
1535.3	0.719000	0.244566	0.175843	0.992853
1535.4	0.717000	0.244562	0.175351	0.990073
1535.5	0.716000	0.244557	0.175103	0.988674
1535.6	0.714000	0.244553	0.174611	0.985897
1535.7	0.712000	0.244549	0.174119	0.983118
1535.8	0.708000	0.244545	0.173138	0.977579
1535.9	0.705000	0.244541	0.172402	0.973421
1536.0	0.702000	0.244537	0.171665	0.969264
1536.1	0.700000	0.244610	0.171227	0.966788
1536.2	0.696000	0.244682	0.170299	0.961547
1536.3	0.693000	0.244754	0.169615	0.957686
1536.4	0.691000	0.244827	0.169175	0.955205
1536.5	0.688000	0.244899	0.168491	0.951340
1536.6	0.684000	0.244973	0.167561	0.946091
1536.7	0.681000	0.245045	0.166876	0.942222
1536.8	0.679000	0.245119	0.166436	0.939736
1536.9	0.678000	0.245192	0.166240	0.938634
1537.0	0.675000	0.245266	0.165554	0.934761
1537.1	0.673000	0.245341	0.165114	0.932276
1537.2	0.671000	0.245416	0.164674	0.929788
1537.3	0.670000	0.245491	0.164479	0.928687
1537.4	0.667000	0.245566	0.163793	0.924813
1537.5	0.664000	0.245642	0.163106	0.920936
1537.6	0.663000	0.245718	0.162911	0.919836
1537.7	0.662000	0.245795	0.162716	0.918734
1537.8	0.661000	0.245872	0.162521	0.917634
1537.9	0.659000	0.245949	0.162080	0.915145
1538.0	0.658000	0.246026	0.161885	0.914044
1538.1	0.657000	0.246074	0.161671	0.912832
1538.2	0.656000	0.246122	0.161456	0.911620
1538.3	0.655000	0.246171	0.161242	0.910410
1538.4	0.652000	0.246220	0.160535	0.906420
1538.5	0.651000	0.246268	0.160321	0.905209
1538.6	0.650000	0.246318	0.160107	0.904002
1538.7	0.648000	0.246368	0.159646	0.901403
1538.8	0.647000	0.246418	0.159433	0.900195
1538.9	0.645000	0.246469	0.158972	0.897596
1539.0	0.644000	0.246519	0.158758	0.896388
1539.1	0.643000	0.246570	0.158544	0.895179
1539.2	0.641000	0.246620	0.158083	0.892577
1539.3	0.640000	0.246671	0.157869	0.891368

1539.4	0.639000	0.246722	0.157655	0.890160
1539.5	0.637000	0.246773	0.157194	0.887558
1539.6	0.636000	0.246825	0.156981	0.886351
1539.7	0.636000	0.246877	0.157014	0.886537
1539.8	0.632000	0.246929	0.156059	0.881147
1539.9	0.622000	0.246981	0.153622	0.867389
1540.0	0.615000	0.247034	0.151926	0.857809
1540.1	0.615000	0.247097	0.151964	0.858028
1540.2	0.616000	0.247159	0.152250	0.859642
1540.3	0.616000	0.247223	0.152289	0.859862
1540.4	0.614000	0.247286	0.151834	0.857290
1540.5	0.614000	0.247350	0.151873	0.857510
1540.6	0.613000	0.247414	0.151665	0.856336
1540.7	0.613000	0.247478	0.151704	0.856557
1540.8	0.611000	0.247542	0.151248	0.853984
1540.9	0.610000	0.247606	0.151040	0.852808
1541.0	0.609000	0.247670	0.150831	0.851630
1541.1	0.610000	0.247734	0.151118	0.853249
1541.2	0.609000	0.247798	0.150909	0.852069
1541.3	0.607000	0.247862	0.150452	0.849490
1541.4	0.607000	0.247926	0.150491	0.849709
1541.5	0.607000	0.247990	0.150530	0.849928
1541.6	0.606000	0.248054	0.150321	0.848747
1541.7	0.605000	0.248118	0.150111	0.847565
1541.8	0.604000	0.248182	0.149902	0.846384
1541.9	0.603000	0.248247	0.149693	0.845201
1542.0	0.602000	0.248311	0.149483	0.844017
1542.1	0.602000	0.248372	0.149520	0.844226
1542.2	0.602000	0.248433	0.149557	0.844433
1542.3	0.602000	0.248494	0.149593	0.844641
1542.4	0.601000	0.248555	0.149382	0.843445
1542.5	0.600000	0.248616	0.149170	0.842249
1542.6	0.599000	0.248677	0.148958	0.841051
1542.7	0.599000	0.248738	0.148994	0.841257
1542.8	0.599000	0.248799	0.149031	0.841463
1542.9	0.599000	0.248860	0.149067	0.841669
1543.0	0.599000	0.248920	0.149103	0.841874
1543.1	0.599000	0.248981	0.149140	0.842079
1543.2	0.599000	0.249042	0.149176	0.842284
1543.3	0.599000	0.249102	0.149212	0.842488
1543.4	0.599000	0.249162	0.149248	0.842691
1543.5	0.599000	0.249222	0.149284	0.842894
1543.6	0.599000	0.249282	0.149320	0.843096

1543.7	0.599000	0.249342	0.149356	0.843298
1543.8	0.601000	0.249401	0.149890	0.846316
1543.9	0.602000	0.249461	0.150175	0.847926
1544.0	0.602000	0.249520	0.150211	0.848127
1544.1	0.601000	0.249536	0.149971	0.846774
1544.2	0.601000	0.249552	0.149981	0.846828
1544.3	0.602000	0.249568	0.150240	0.848291
1544.4	0.604000	0.249583	0.150748	0.851162
1544.5	0.605000	0.249599	0.151007	0.852624
1544.6	0.604000	0.249614	0.150767	0.851266
1544.7	0.604000	0.249629	0.150776	0.851316
1544.8	0.604000	0.249643	0.150784	0.851366
1544.9	0.605000	0.249657	0.151043	0.852824
1545.0	0.607000	0.249672	0.151551	0.855692
1545.1	0.607000	0.249685	0.151559	0.855738
1545.2	0.607000	0.249698	0.151567	0.855783
1545.3	0.607000	0.249711	0.151575	0.855826
1545.4	0.608000	0.249723	0.151832	0.857279
1545.5	0.609000	0.249735	0.152089	0.858730
1545.6	0.610000	0.249747	0.152346	0.860180
1545.7	0.610000	0.249758	0.152352	0.860219
1545.8	0.610000	0.249769	0.152359	0.860257
1545.9	0.609000	0.249780	0.152116	0.858883
1546.0	0.610000	0.249790	0.152372	0.860329
1546.1	0.610000	0.249773	0.152361	0.860270
1546.2	0.611000	0.249755	0.152600	0.861619
1546.3	0.611000	0.249737	0.152589	0.861556
1546.4	0.611000	0.249718	0.152578	0.861492
1546.5	0.612000	0.249699	0.152816	0.862836
1546.6	0.612000	0.249680	0.152804	0.862768
1546.7	0.612000	0.249660	0.152792	0.862699
1546.8	0.612000	0.249639	0.152779	0.862629
1546.9	0.612000	0.249618	0.152766	0.862556
1547.0	0.612000	0.249597	0.152753	0.862483
1547.1	0.613000	0.249575	0.152989	0.863814
1547.2	0.614000	0.249552	0.153225	0.865145
1547.3	0.614000	0.249529	0.153211	0.865064
1547.4	0.613000	0.249505	0.152947	0.863573
1547.5	0.612000	0.249481	0.152682	0.862082
1547.6	0.612000	0.249456	0.152667	0.861997
1547.7	0.612000	0.249432	0.152652	0.861911
1547.8	0.612000	0.249406	0.152637	0.861824
1547.9	0.612000	0.249381	0.152621	0.861736

1548.0	0.612000	0.249355	0.152605	0.861646
1548.1	0.612000	0.249321	0.152585	0.861530
1548.2	0.612000	0.249287	0.152564	0.861412
1548.3	0.611000	0.249253	0.152294	0.859886
1548.4	0.611000	0.249218	0.152272	0.859767
1548.5	0.612000	0.249183	0.152500	0.861054
1548.6	0.612000	0.249148	0.152479	0.860931
1548.7	0.611000	0.249112	0.152207	0.859400
1548.8	0.611000	0.249076	0.152185	0.859276
1548.9	0.611000	0.249039	0.152163	0.859150
1549.0	0.610000	0.249003	0.151892	0.857618
1549.1	0.610000	0.248965	0.151869	0.857487
1549.2	0.610000	0.248927	0.151845	0.857356
1549.3	0.610000	0.248888	0.151822	0.857223
1549.4	0.608000	0.248850	0.151301	0.854280
1549.5	0.607000	0.248811	0.151028	0.852741
1549.6	0.607000	0.248771	0.151004	0.852606
1549.7	0.607000	0.248732	0.150980	0.852470
1549.8	0.605000	0.248692	0.150459	0.849526
1549.9	0.604000	0.248652	0.150186	0.847986
1550.0	0.604000	0.248612	0.150162	0.847849
1550.1	0.604000	0.248530	0.150112	0.847569
1550.2	0.603000	0.248448	0.149814	0.845886
1550.3	0.601000	0.248365	0.149268	0.842801
1550.4	0.601000	0.248283	0.149218	0.842521
1550.5	0.600000	0.248200	0.148920	0.840839
1550.6	0.599000	0.248117	0.148622	0.839156
1550.7	0.598000	0.248034	0.148324	0.837475
1550.8	0.597000	0.247951	0.148026	0.835793
1550.9	0.596000	0.247867	0.147729	0.834113
1551.0	0.594000	0.247784	0.147183	0.831033
1551.1	0.593000	0.247697	0.146884	0.829345
1551.2	0.592000	0.247611	0.146585	0.827657
1551.3	0.590000	0.247524	0.146039	0.824572
1551.4	0.588000	0.247437	0.145493	0.821489
1551.5	0.585000	0.247350	0.144700	0.817011
1551.6	0.583000	0.247263	0.144154	0.813931
1551.7	0.582000	0.247176	0.143856	0.812249
1551.8	0.581000	0.247089	0.143559	0.810567
1551.9	0.579000	0.247001	0.143014	0.807491
1552.0	0.577000	0.246914	0.142469	0.804416
1552.1	0.575000	0.246852	0.141940	0.801428
1552.2	0.573000	0.246790	0.141411	0.798440

1552.3	0.571000	0.246728	0.140882	0.795454
1552.4	0.570000	0.246666	0.140600	0.793861
1552.5	0.568000	0.246604	0.140071	0.790876
1552.6	0.567000	0.246542	0.139789	0.789284
1552.7	0.566000	0.246479	0.139507	0.787692
1552.8	0.564000	0.246417	0.138979	0.784709
1552.9	0.563000	0.246354	0.138697	0.783119
1553.0	0.562000	0.246292	0.138416	0.781530
1553.1	0.559000	0.246228	0.137642	0.777158
1553.2	0.558000	0.246165	0.137360	0.775568
1553.3	0.557000	0.246102	0.137079	0.773979
1553.4	0.556000	0.246038	0.136797	0.772390
1553.5	0.555000	0.245974	0.136516	0.770802
1553.6	0.554000	0.245911	0.136235	0.769215
1553.7	0.553000	0.245848	0.135954	0.767629
1553.8	0.552000	0.245784	0.135673	0.766043
1553.9	0.550000	0.245721	0.135147	0.763071
1554.0	0.548000	0.245657	0.134620	0.760098
1554.1	0.547000	0.245573	0.134328	0.758450
1554.2	0.545000	0.245488	0.133791	0.755416
1554.3	0.543000	0.245403	0.133254	0.752385
1554.4	0.542000	0.245319	0.132963	0.750740
1554.5	0.541000	0.245234	0.132672	0.749097
1554.6	0.540000	0.245150	0.132381	0.747456
1554.7	0.529000	0.245066	0.129640	0.731977
1554.8	0.527000	0.244981	0.129105	0.728959
1554.9	0.525000	0.244897	0.128571	0.725942
1555.0	0.522000	0.244813	0.127792	0.721546
1555.1	0.511000	0.244730	0.125057	0.706101
1555.2	0.505000	0.244646	0.123546	0.697573
1555.3	0.502000	0.244563	0.122771	0.693194
1555.4	0.499000	0.244481	0.121996	0.688818
1555.5	0.495000	0.244397	0.120977	0.683064
1555.6	0.491000	0.244315	0.119959	0.677315
1555.7	0.488000	0.244232	0.119185	0.672948
1555.8	0.485000	0.244149	0.118412	0.668584
1555.9	0.482000	0.244066	0.117640	0.664224
1556.0	0.480000	0.243984	0.117112	0.661244
1556.1	0.478000	0.243863	0.116567	0.658163
1556.2	0.478000	0.243743	0.116509	0.657838
1556.3	0.475000	0.243622	0.115721	0.653386
1556.4	0.467000	0.243502	0.113715	0.642065
1556.5	0.460000	0.243381	0.111955	0.632127

1556.6	0.459000	0.243261	0.111657	0.630441
1556.7	0.458000	0.243140	0.111358	0.628755
1556.8	0.455000	0.243020	0.110574	0.624327
1556.9	0.452000	0.242899	0.109790	0.619903
1557.0	0.451000	0.242778	0.109493	0.618223
1557.1	0.449000	0.242658	0.108954	0.615179
1557.2	0.447000	0.242539	0.108415	0.612136
1557.3	0.444000	0.242419	0.107634	0.607728
1557.4	0.443000	0.242300	0.107339	0.606060
1557.5	0.442000	0.242180	0.107044	0.604394
1557.6	0.440000	0.242060	0.106507	0.601362
1557.7	0.439000	0.241941	0.106212	0.599698
1557.8	0.436000	0.241821	0.105434	0.595305
1557.9	0.435000	0.241701	0.105140	0.593645
1558.0	0.433000	0.241581	0.104605	0.590623
1558.1	0.432000	0.241484	0.104321	0.589021
1558.2	0.430000	0.241386	0.103796	0.586058
1558.3	0.426000	0.241289	0.102789	0.580372
1558.4	0.419000	0.241192	0.101059	0.570605
1558.5	0.405000	0.241094	0.097643	0.551317
1558.6	0.399000	0.240997	0.096158	0.542929
1558.7	0.396000	0.240899	0.095396	0.538630
1558.8	0.390000	0.240802	0.093913	0.530254
1558.9	0.387000	0.240704	0.093153	0.525962
1559.0	0.384000	0.240607	0.092393	0.521673
1559.1	0.383000	0.240508	0.092114	0.520101
1559.2	0.359000	0.240409	0.086307	0.487309
1559.3	0.343000	0.240310	0.082426	0.465399
1559.4	0.336000	0.240211	0.080711	0.455713
1559.5	0.336000	0.240112	0.080678	0.455525
1559.6	0.336000	0.240013	0.080644	0.455337
1559.7	0.332000	0.239914	0.079651	0.449731
1559.8	0.327000	0.239815	0.078419	0.442775
1559.9	0.324000	0.239716	0.077668	0.438532
1560.0	0.319000	0.239617	0.076438	0.431586
1560.1	0.312000	0.239478	0.074717	0.421870
1560.2	0.307000	0.239338	0.073477	0.414868
1560.3	0.305000	0.239199	0.072956	0.411926
1560.4	0.304000	0.239060	0.072674	0.410336
1560.5	0.302000	0.238920	0.072154	0.407399
1560.6	0.301000	0.238781	0.071873	0.405813
1560.7	0.299000	0.238642	0.071354	0.402882
1560.8	0.297000	0.238503	0.070835	0.399954

1560.9	0.294000	0.238364	0.070079	0.395683
1561.0	0.293000	0.238225	0.069800	0.394107
1561.1	0.291000	0.238084	0.069283	0.391186
1561.2	0.290000	0.237944	0.069004	0.389611
1561.3	0.289000	0.237803	0.068725	0.388039
1561.4	0.287000	0.237663	0.068209	0.385126
1561.5	0.286000	0.237522	0.067931	0.383557
1561.6	0.285000	0.237382	0.067654	0.381990
1561.7	0.283000	0.237241	0.067139	0.379084
1561.8	0.281000	0.237100	0.066625	0.376182
1561.9	0.279000	0.236960	0.066112	0.373283
1562.0	0.277000	0.236819	0.065599	0.370388
1562.1	0.275000	0.236690	0.065090	0.367513
1562.2	0.273000	0.236561	0.064581	0.364641
1562.3	0.270000	0.236432	0.063837	0.360437
1562.4	0.266000	0.236303	0.062857	0.354904
1562.5	0.262000	0.236174	0.061878	0.349376
1562.6	0.257000	0.236045	0.060664	0.342521
1562.7	0.254000	0.235916	0.059923	0.338338
1562.8	0.251000	0.235787	0.059183	0.334159
1562.9	0.248000	0.235658	0.058443	0.329984
1563.0	0.245000	0.235529	0.057705	0.325814
1563.1	0.241000	0.235401	0.056732	0.320321
1563.2	0.239000	0.235273	0.056230	0.317490
1563.3	0.236000	0.235145	0.055494	0.313334
1563.4	0.231000	0.235017	0.054289	0.306529
1563.5	0.228000	0.234889	0.053555	0.302383
1563.6	0.225000	0.234761	0.052821	0.298242
1563.7	0.220000	0.234634	0.051619	0.291456
1563.8	0.212000	0.234506	0.049715	0.280704
1563.9	0.202000	0.234378	0.047344	0.267317
1564.0	0.192000	0.234250	0.044976	0.253945
1564.1	0.192000	0.234149	0.044957	0.253836
1564.2	0.188000	0.234049	0.044001	0.248442
1564.3	0.182000	0.233948	0.042579	0.240409
1564.4	0.174000	0.233848	0.040690	0.229743
1564.5	0.159000	0.233747	0.037166	0.209847
1564.6	0.154000	0.233647	0.035982	0.203161
1564.7	0.152000	0.233546	0.035499	0.200436
1564.8	0.150000	0.233446	0.035017	0.197714
1564.9	0.147000	0.233345	0.034302	0.193676
1565.0	0.123000	0.233245	0.028689	0.161986
1565.1	0.115000	0.233142	0.026811	0.151384

1565.2	0.114000	0.233040	0.026567	0.150001
1565.3	0.114000	0.232938	0.026555	0.149935
1565.4	0.113000	0.232836	0.026310	0.148555
1565.5	0.113000	0.232733	0.026299	0.148490
1565.6	0.111000	0.232631	0.025822	0.145798
1565.7	0.107000	0.232529	0.024881	0.140482
1565.8	0.104000	0.232427	0.024172	0.136484
1565.9	0.100000	0.232326	0.023233	0.131177
1566.0	0.097000	0.232224	0.022526	0.127186
1566.1	0.093000	0.232093	0.021585	0.121872
1566.2	0.089000	0.231963	0.020645	0.116565
1566.3	0.085000	0.231832	0.019706	0.111263
1566.4	0.082000	0.231701	0.019000	0.107276
1566.5	0.077000	0.231571	0.017831	0.100678
1566.6	0.072000	0.231441	0.016664	0.094088
1566.7	0.068000	0.231311	0.015729	0.088810
1566.8	0.064000	0.231180	0.014796	0.083539
1566.9	0.060000	0.231050	0.013863	0.078274
1567.0	0.056000	0.230920	0.012932	0.073014
1567.1	0.053000	0.230784	0.012232	0.069062
1567.2	0.051000	0.230649	0.011763	0.066417
1567.3	0.048000	0.230513	0.011065	0.062474
1567.4	0.045000	0.230378	0.010367	0.058535
1567.5	0.042000	0.230242	0.009670	0.054600
1567.6	0.041000	0.230106	0.009434	0.053269
1567.7	0.041000	0.229971	0.009429	0.053237
1567.8	0.041000	0.229835	0.009423	0.053206
1567.9	0.039000	0.229699	0.008958	0.050581
1568.0	0.038000	0.229563	0.008723	0.049255
1568.1	0.037000	0.229467	0.008490	0.047938
1568.2	0.037000	0.229371	0.008487	0.047918
1568.3	0.036000	0.229274	0.008254	0.046603
1568.4	0.035000	0.229178	0.008021	0.045290
1568.5	0.033000	0.229082	0.007560	0.042684
1568.6	0.033000	0.228985	0.007557	0.042666
1568.7	0.033000	0.228888	0.007553	0.042648
1568.8	0.032000	0.228791	0.007321	0.041338
1568.9	0.031000	0.228695	0.007090	0.040029
1569.0	0.030000	0.228598	0.006858	0.038722
1569.1	0.029000	0.228497	0.006626	0.037414
1569.2	0.028000	0.228397	0.006395	0.036108
1569.3	0.027000	0.228296	0.006164	0.034803
1569.4	0.026000	0.228196	0.005933	0.033500

1569.5	0.025000	0.228095	0.005702	0.032197
1569.6	0.025000	0.227995	0.005700	0.032183
1569.7	0.024000	0.227894	0.005469	0.030882
1569.8	0.023000	0.227793	0.005239	0.029582
1569.9	0.022000	0.227693	0.005009	0.028283
1570.0	0.022000	0.227592	0.005007	0.028271
1570.1	0.021000	0.227451	0.004776	0.026969
1570.2	0.020000	0.227311	0.004546	0.025669
1570.3	0.020000	0.227170	0.004543	0.025653
1570.4	0.019000	0.227029	0.004314	0.024355
1570.5	0.018000	0.226888	0.004084	0.023059
1570.6	0.018000	0.226747	0.004081	0.023045
1570.7	0.017000	0.226606	0.003852	0.021751
1570.8	0.016000	0.226465	0.003623	0.020459
1570.9	0.016000	0.226324	0.003621	0.020446
1571.0	0.015000	0.226183	0.003393	0.019156
1571.1	0.015000	0.226041	0.003391	0.019144
1571.2	0.015000	0.225900	0.003388	0.019132
1571.3	0.015000	0.225759	0.003386	0.019120
1571.4	0.015000	0.225617	0.003384	0.019108
1571.5	0.014000	0.225476	0.003157	0.017823
1571.6	0.014000	0.225334	0.003155	0.017812
1571.7	0.013000	0.225192	0.002928	0.016529
1571.8	0.012000	0.225050	0.002701	0.015248
1571.9	0.012000	0.224908	0.002699	0.015239
1572.0	0.012000	0.224766	0.002697	0.015229
1572.1	0.012000	0.224660	0.002696	0.015222
1572.2	0.012000	0.224554	0.002695	0.015215
1572.3	0.012000	0.224447	0.002693	0.015207
1572.4	0.011000	0.224341	0.002468	0.013934
1572.5	0.010000	0.224234	0.002242	0.012661
1572.6	0.009000	0.224127	0.002017	0.011389
1572.7	0.009000	0.224020	0.002016	0.011384
1572.8	0.009000	0.223913	0.002015	0.011378
1572.9	0.009000	0.223805	0.002014	0.011373
1573.0	0.008000	0.223698	0.001790	0.010104
1573.1	0.008000	0.223592	0.001789	0.010100
1573.2	0.008000	0.223486	0.001788	0.010095
1573.3	0.008000	0.223380	0.001787	0.010090
1573.4	0.008000	0.223273	0.001786	0.010085
1573.5	0.008000	0.223166	0.001785	0.010080
1573.6	0.008000	0.223059	0.001784	0.010076
1573.7	0.007000	0.222952	0.001561	0.008812

1573.8	0.007000	0.222845	0.001560	0.008808
1573.9	0.008000	0.222737	0.001782	0.010061
1574.0	0.008000	0.222630	0.001781	0.010056
1574.1	0.007000	0.222536	0.001558	0.008795
1574.2	0.006000	0.222441	0.001335	0.007536
1574.3	0.007000	0.222347	0.001556	0.008788
1574.4	0.007000	0.222253	0.001556	0.008784
1574.5	0.007000	0.222158	0.001555	0.008781
1574.6	0.007000	0.222063	0.001554	0.008777
1574.7	0.007000	0.221969	0.001554	0.008773
1574.8	0.007000	0.221874	0.001553	0.008769
1574.9	0.007000	0.221778	0.001552	0.008766
1575.0	0.007000	0.221683	0.001552	0.008762
1575.1	0.007000	0.221584	0.001551	0.008758
1575.2	0.007000	0.221486	0.001550	0.008754
1575.3	0.007000	0.221387	0.001550	0.008750
1575.4	0.007000	0.221288	0.001549	0.008746
1575.5	0.007000	0.221189	0.001548	0.008742
1575.6	0.007000	0.221090	0.001548	0.008738
1575.7	0.007000	0.220991	0.001547	0.008734
1575.8	0.007000	0.220891	0.001546	0.008730
1575.9	0.007000	0.220792	0.001546	0.008727
1576.0	0.007000	0.220692	0.001545	0.008723
1576.1	0.007000	0.220536	0.001544	0.008716
1576.2	0.007000	0.220380	0.001543	0.008710
1576.3	0.007000	0.220223	0.001542	0.008704
1576.4	0.007000	0.220067	0.001540	0.008698
1576.5	0.007000	0.219911	0.001539	0.008692
1576.6	0.007000	0.219754	0.001538	0.008685
1576.7	0.007000	0.219597	0.001537	0.008679
1576.8	0.007000	0.219441	0.001536	0.008673
1576.9	0.007000	0.219284	0.001535	0.008667
1577.0	0.007000	0.219127	0.001534	0.008661
1577.1	0.007000	0.218970	0.001533	0.008655
1577.2	0.007000	0.218813	0.001532	0.008648
1577.3	0.007000	0.218655	0.001531	0.008642
1577.4	0.007000	0.218498	0.001529	0.008636
1577.5	0.007000	0.218340	0.001528	0.008630
1577.6	0.007000	0.218183	0.001527	0.008623
1577.7	0.007000	0.218025	0.001526	0.008617
1577.8	0.007000	0.217867	0.001525	0.008611
1577.9	0.007000	0.217709	0.001524	0.008605
1578.0	0.007000	0.217552	0.001523	0.008598

1578.1	0.007000	0.217432	0.001522	0.008594
1578.2	0.007000	0.217312	0.001521	0.008589
1578.3	0.007000	0.217191	0.001520	0.008584
1578.4	0.007000	0.217071	0.001519	0.008579
1578.5	0.007000	0.216951	0.001519	0.008575
1578.6	0.007000	0.216830	0.001518	0.008570
1578.7	0.007000	0.216709	0.001517	0.008565
1578.8	0.007000	0.216588	0.001516	0.008560
1578.9	0.007000	0.216467	0.001515	0.008556
1579.0	0.007000	0.216346	0.001514	0.008551
1579.1	0.007000	0.216228	0.001514	0.008546
1579.2	0.007000	0.216111	0.001513	0.008541
1579.3	0.007000	0.215993	0.001512	0.008537
1579.4	0.007000	0.215875	0.001511	0.008532
1579.5	0.007000	0.215757	0.001510	0.008528
1579.6	0.007000	0.215638	0.001509	0.008523
1579.7	0.007000	0.215520	0.001509	0.008518
1579.8	0.007000	0.215401	0.001508	0.008513
1579.9	0.007000	0.215282	0.001507	0.008509
1580.0	0.007000	0.215163	0.001506	0.008504
1580.1	0.007000	0.215078	0.001506	0.008501
1580.2	0.007000	0.214994	0.001505	0.008497
1580.3	0.007000	0.214909	0.001504	0.008494
1580.4	0.007000	0.214824	0.001504	0.008491
1580.5	0.007000	0.214739	0.001503	0.008487
1580.6	0.007000	0.214653	0.001503	0.008484
1580.7	0.007000	0.214567	0.001502	0.008480
1580.8	0.007000	0.214481	0.001501	0.008477
1580.9	0.007000	0.214395	0.001501	0.008474
1581.0	0.007000	0.214309	0.001500	0.008470
1581.1	0.007000	0.214220	0.001500	0.008467
1581.2	0.007000	0.214132	0.001499	0.008463
1581.3	0.007000	0.214043	0.001498	0.008460
1581.4	0.007000	0.213954	0.001498	0.008456
1581.5	0.007000	0.213865	0.001497	0.008453
1581.6	0.007000	0.213775	0.001496	0.008449
1581.7	0.007000	0.213686	0.001496	0.008446
1581.8	0.007000	0.213596	0.001495	0.008442
1581.9	0.007000	0.213506	0.001495	0.008439
1582.0	0.007000	0.213415	0.001494	0.008435
1582.1	0.007000	0.213273	0.001493	0.008429
1582.2	0.007000	0.213130	0.001492	0.008424
1582.3	0.007000	0.212987	0.001491	0.008418

1582.4	0.006000	0.212843	0.001277	0.007211
1582.5	0.005000	0.212700	0.001063	0.006005
1582.6	0.005000	0.212556	0.001063	0.006001
1582.7	0.004000	0.212413	0.000850	0.004797
1582.8	0.004000	0.212269	0.000849	0.004794
1582.9	0.004000	0.212124	0.000848	0.004791
1583.0	0.004000	0.211980	0.000848	0.004788
1583.1	0.004000	0.211832	0.000847	0.004784
1583.2	0.004000	0.211685	0.000847	0.004781
1583.3	0.004000	0.211536	0.000846	0.004778
1583.4	0.004000	0.211388	0.000846	0.004774
1583.5	0.004000	0.211240	0.000845	0.004771
1583.6	0.004000	0.211091	0.000844	0.004767
1583.7	0.004000	0.210942	0.000844	0.004764
1583.8	0.004000	0.210794	0.000843	0.004761
1583.9	0.004000	0.210644	0.000843	0.004757
1584.0	0.003000	0.210495	0.000631	0.003566
1584.1	0.003000	0.210358	0.000631	0.003563
1584.2	0.003000	0.210221	0.000631	0.003561
1584.3	0.003000	0.210084	0.000630	0.003559
1584.4	0.003000	0.209946	0.000630	0.003556
1584.5	0.003000	0.209809	0.000629	0.003554
1584.6	0.004000	0.209670	0.000839	0.004735
1584.7	0.004000	0.209532	0.000838	0.004732
1584.8	0.004000	0.209394	0.000838	0.004729
1584.9	0.004000	0.209255	0.000837	0.004726
1585.0	0.004000	0.209116	0.000836	0.004723
1585.1	0.005000	0.208974	0.001045	0.005900
1585.2	0.006000	0.208832	0.001253	0.007075
1585.3	0.007000	0.208690	0.001461	0.008248
1585.4	0.007000	0.208547	0.001460	0.008243
1585.5	0.007000	0.208405	0.001459	0.008237
1585.6	0.007000	0.208262	0.001458	0.008231
1585.7	0.007000	0.208119	0.001457	0.008226
1585.8	0.007000	0.207976	0.001456	0.008220
1585.9	0.007000	0.207833	0.001455	0.008214
1586.0	0.007000	0.207690	0.001454	0.008209
1586.1	0.007000	0.207554	0.001453	0.008203
1586.2	0.007000	0.207417	0.001452	0.008198
1586.3	0.007000	0.207281	0.001451	0.008193
1586.4	0.007000	0.207144	0.001450	0.008187
1586.5	0.007000	0.207008	0.001449	0.008182
1586.6	0.007000	0.206871	0.001448	0.008176

1586.7	0.007000	0.206733	0.001447	0.008171
1586.8	0.007000	0.206596	0.001446	0.008165
1586.9	0.007000	0.206458	0.001445	0.008160
1587.0	0.007000	0.206321	0.001444	0.008155
1587.1	0.007000	0.206183	0.001443	0.008149
1587.2	0.007000	0.206045	0.001442	0.008144
1587.3	0.007000	0.205907	0.001441	0.008138
1587.4	0.007000	0.205769	0.001440	0.008133
1587.5	0.007000	0.205631	0.001439	0.008127
1587.6	0.007000	0.205492	0.001438	0.008122
1587.7	0.007000	0.205353	0.001437	0.008116
1587.8	0.006000	0.205214	0.001231	0.006952
1587.9	0.006000	0.205075	0.001230	0.006947
1588.0	0.005000	0.204935	0.001025	0.005786
1588.1	0.005000	0.204772	0.001024	0.005781
1588.2	0.005000	0.204609	0.001023	0.005776
1588.3	0.005000	0.204445	0.001022	0.005772
1588.4	0.005000	0.204282	0.001021	0.005767
1588.5	0.005000	0.204118	0.001021	0.005763
1588.6	0.005000	0.203954	0.001020	0.005758
1588.7	0.005000	0.203790	0.001019	0.005753
1588.8	0.005000	0.203625	0.001018	0.005749
1588.9	0.005000	0.203461	0.001017	0.005744
1589.0	0.005000	0.203296	0.001016	0.005739
1589.1	0.004000	0.203132	0.000813	0.004588
1589.2	0.004000	0.202967	0.000812	0.004584
1589.3	0.004000	0.202803	0.000811	0.004580
1589.4	0.005000	0.202638	0.001013	0.005721
1589.5	0.005000	0.202474	0.001012	0.005716
1589.6	0.005000	0.202308	0.001012	0.005711
1589.7	0.004000	0.202143	0.000809	0.004565
1589.8	0.005000	0.201978	0.001010	0.005702
1589.9	0.005000	0.201812	0.001009	0.005697
1590.0	0.005000	0.201646	0.001008	0.005693
1590.1	0.004000	0.201440	0.000806	0.004550
1590.2	0.004000	0.201234	0.000805	0.004545
1590.3	0.004000	0.201028	0.000804	0.004540
1590.4	0.005000	0.200822	0.001004	0.005669
1590.5	0.005000	0.200615	0.001003	0.005664
1590.6	0.005000	0.200409	0.001002	0.005658
1590.7	0.005000	0.200202	0.001001	0.005652
1590.8	0.005000	0.199996	0.001000	0.005646
1590.9	0.005000	0.199789	0.000999	0.005640

1591.0	0.005000	0.199582	0.000998	0.005634
1591.1	0.006000	0.199374	0.001196	0.006754
1591.2	0.007000	0.199165	0.001394	0.007872
1591.3	0.006000	0.198957	0.001194	0.006740
1591.4	0.005000	0.198749	0.000994	0.005611
1591.5	0.006000	0.198540	0.001191	0.006726
1591.6	0.007000	0.198331	0.001388	0.007839
1591.7	0.006000	0.198123	0.001189	0.006712
1591.8	0.005000	0.197914	0.000990	0.005587
1591.9	0.006000	0.197705	0.001186	0.006698
1592.0	0.006000	0.197497	0.001185	0.006691
1592.1	0.007000	0.197299	0.001381	0.007798
1592.2	0.007000	0.197102	0.001380	0.007790
1592.3	0.007000	0.196904	0.001378	0.007782
1592.4	0.007000	0.196707	0.001377	0.007775
1592.5	0.007000	0.196509	0.001376	0.007767
1592.6	0.007000	0.196312	0.001374	0.007759
1592.7	0.007000	0.196114	0.001373	0.007751
1592.8	0.007000	0.195916	0.001371	0.007743
1592.9	0.007000	0.195719	0.001370	0.007736
1593.0	0.007000	0.195521	0.001369	0.007728
1593.1	0.007000	0.195323	0.001367	0.007720
1593.2	0.007000	0.195125	0.001366	0.007712
1593.3	0.007000	0.194928	0.001364	0.007704
1593.4	0.007000	0.194730	0.001363	0.007696
1593.5	0.007000	0.194532	0.001362	0.007689
1593.6	0.007000	0.194334	0.001360	0.007681
1593.7	0.006000	0.194135	0.001165	0.006577
1593.8	0.005000	0.193937	0.000970	0.005475
1593.9	0.006000	0.193739	0.001162	0.006563
1594.0	0.007000	0.193541	0.001355	0.007649
1594.1	0.006000	0.193310	0.001160	0.006549
1594.2	0.005000	0.193078	0.000965	0.005451
1594.3	0.005000	0.192847	0.000964	0.005444
1594.4	0.005000	0.192616	0.000963	0.005438
1594.5	0.005000	0.192385	0.000962	0.005431
1594.6	0.006000	0.192154	0.001153	0.006510
1594.7	0.006000	0.191923	0.001152	0.006502
1594.8	0.007000	0.191693	0.001342	0.007576
1594.9	0.007000	0.191462	0.001340	0.007567
1595.0	0.006000	0.191231	0.001147	0.006478
1595.1	0.006000	0.191001	0.001146	0.006471
1595.2	0.005000	0.190771	0.000954	0.005386

1595.3	0.004000	0.190542	0.000762	0.004303
1595.4	0.004000	0.190312	0.000761	0.004298
1595.5	0.004000	0.190082	0.000760	0.004293
1595.6	0.004000	0.189853	0.000759	0.004288
1595.7	0.004000	0.189623	0.000758	0.004283
1595.8	0.003000	0.189394	0.000568	0.003208
1595.9	0.003000	0.189164	0.000567	0.003204
1596.0	0.003000	0.188935	0.000567	0.003200
1596.1	0.003000	0.188663	0.000566	0.003196
1596.2	0.003000	0.188391	0.000565	0.003191
1596.3	0.003000	0.188120	0.000564	0.003187
1596.4	0.003000	0.187849	0.000564	0.003182
1596.5	0.003000	0.187578	0.000563	0.003177
1596.6	0.003000	0.187306	0.000562	0.003173
1596.7	0.003000	0.187036	0.000561	0.003168
1596.8	0.003000	0.186765	0.000560	0.003164
1596.9	0.003000	0.186495	0.000559	0.003159
1597.0	0.003000	0.186225	0.000559	0.003154
1597.1	0.003000	0.185954	0.000558	0.003150
1597.2	0.003000	0.185683	0.000557	0.003145
1597.3	0.003000	0.185413	0.000556	0.003141
1597.4	0.003000	0.185142	0.000555	0.003136
1597.5	0.003000	0.184872	0.000555	0.003132
1597.6	0.003000	0.184603	0.000554	0.003127
1597.7	0.003000	0.184333	0.000553	0.003122
1597.8	0.003000	0.184063	0.000552	0.003118
1597.9	0.003000	0.183794	0.000551	0.003113
1598.0	0.003000	0.183525	0.000551	0.003109
1598.1	0.003000	0.183259	0.000550	0.003104
1598.2	0.003000	0.182993	0.000549	0.003100
1598.3	0.003000	0.182728	0.000548	0.003095
1598.4	0.003000	0.182463	0.000547	0.003091
1598.5	0.003000	0.182198	0.000547	0.003086
1598.6	0.003000	0.181933	0.000546	0.003082
1598.7	0.003000	0.181668	0.000545	0.003077
1598.8	0.003000	0.181403	0.000544	0.003073
1598.9	0.003000	0.181139	0.000543	0.003068
1599.0	0.003000	0.180874	0.000543	0.003064
1599.1	0.003000	0.180609	0.000542	0.003059
1599.2	0.003000	0.180343	0.000541	0.003055
1599.3	0.003000	0.180077	0.000540	0.003050
1599.4	0.003000	0.179812	0.000539	0.003046
1599.5	0.003000	0.179547	0.000539	0.003041

1599.6	0.003000	0.179281	0.000538	0.003037
1599.7	0.003000	0.179017	0.000537	0.003032
1599.8	0.003000	0.178752	0.000536	0.003028
1599.9	0.003000	0.178487	0.000535	0.003023
1600.0	0.003000	0.178223	0.000535	0.003019
1600.1	0.003000	0.177924	0.000534	0.003014
1600.2	0.003000	0.177625	0.000533	0.003009
1600.3	0.003000	0.177326	0.000532	0.003004
1600.4	0.003000	0.177027	0.000531	0.002999
1600.5	0.003000	0.176729	0.000530	0.002994
1600.6	0.003000	0.176431	0.000529	0.002989
1600.7	0.003000	0.176134	0.000528	0.002983
1600.8	0.003000	0.175836	0.000528	0.002978
1600.9	0.003000	0.175539	0.000527	0.002973
1601.0	0.003000	0.175242	0.000526	0.002968
1601.1	0.003000	0.174944	0.000525	0.002963
1601.2	0.003000	0.174646	0.000524	0.002958
1601.3	0.003000	0.174349	0.000523	0.002953
1601.4	0.003000	0.174052	0.000522	0.002948
1601.5	0.003000	0.173755	0.000521	0.002943
1601.6	0.003000	0.173458	0.000520	0.002938
1601.7	0.003000	0.173162	0.000519	0.002933
1601.8	0.003000	0.172866	0.000519	0.002928
1601.9	0.003000	0.172570	0.000518	0.002923
1602.0	0.003000	0.172275	0.000517	0.002918
1602.1	0.003000	0.171999	0.000516	0.002913
1602.2	0.003000	0.171723	0.000515	0.002909
1602.3	0.003000	0.171448	0.000514	0.002904
1602.4	0.003000	0.171173	0.000514	0.002899
1602.5	0.003000	0.170898	0.000513	0.002895
1602.6	0.003000	0.170623	0.000512	0.002890
1602.7	0.003000	0.170349	0.000511	0.002885
1602.8	0.003000	0.170074	0.000510	0.002881
1602.9	0.003000	0.169800	0.000509	0.002876
1603.0	0.003000	0.169526	0.000509	0.002872
1603.1	0.003000	0.169251	0.000508	0.002867
1603.2	0.003000	0.168976	0.000507	0.002862
1603.3	0.003000	0.168702	0.000506	0.002858
1603.4	0.003000	0.168427	0.000505	0.002853
1603.5	0.003000	0.168153	0.000504	0.002848
1603.6	0.003000	0.167879	0.000504	0.002844
1603.7	0.003000	0.167605	0.000503	0.002839
1603.8	0.003000	0.167331	0.000502	0.002834

1603.9	0.003000	0.167058	0.000501	0.002830
1604.0	0.003000	0.166785	0.000500	0.002825
1604.1	0.003000	0.166492	0.000499	0.002820
1604.2	0.003000	0.166200	0.000499	0.002815
1604.3	0.003000	0.165908	0.000498	0.002810
1604.4	0.003000	0.165616	0.000497	0.002805
1604.5	0.003000	0.165325	0.000496	0.002800
1604.6	0.003000	0.165034	0.000495	0.002795
1604.7	0.003000	0.164743	0.000494	0.002791
1604.8	0.003000	0.164452	0.000493	0.002786
1604.9	0.003000	0.164162	0.000492	0.002781
1605.0	0.003000	0.163872	0.000492	0.002776
1605.1	0.003000	0.163583	0.000491	0.002771
1605.2	0.003000	0.163295	0.000490	0.002766
1605.3	0.003000	0.163006	0.000489	0.002761
1605.4	0.003000	0.162717	0.000488	0.002756
1605.5	0.003000	0.162429	0.000487	0.002751
1605.6	0.003000	0.162141	0.000486	0.002746
1605.7	0.003000	0.161853	0.000486	0.002742
1605.8	0.004000	0.161566	0.000646	0.003649
1605.9	0.004000	0.161279	0.000645	0.003642
1606.0	0.004000	0.160992	0.000644	0.003636
1606.1	0.004000	0.160708	0.000643	0.003630
1606.2	0.004000	0.160425	0.000642	0.003623
1606.3	0.005000	0.160142	0.000801	0.004521
1606.4	0.005000	0.159859	0.000799	0.004513
1606.5	0.006000	0.159576	0.000957	0.005406
1606.6	0.007000	0.159294	0.001115	0.006296
1606.7	0.007000	0.159012	0.001113	0.006285
1606.8	0.007000	0.158730	0.001111	0.006274
1606.9	0.007000	0.158449	0.001109	0.006262
1607.0	0.007000	0.158168	0.001107	0.006251
1607.1	0.007000	0.157887	0.001105	0.006240
1607.2	0.007000	0.157607	0.001103	0.006229
1607.3	0.007000	0.157328	0.001101	0.006218
1607.4	0.007000	0.157048	0.001099	0.006207
1607.5	0.007000	0.156769	0.001097	0.006196
1607.6	0.007000	0.156491	0.001095	0.006185
1607.7	0.007000	0.156212	0.001093	0.006174
1607.8	0.007000	0.155934	0.001092	0.006163
1607.9	0.007000	0.155656	0.001090	0.006152
1608.0	0.007000	0.155378	0.001088	0.006141
1608.1	0.007000	0.155081	0.001086	0.006129

1608.2	0.007000	0.154785	0.001083	0.006118
1608.3	0.007000	0.154488	0.001081	0.006106
1608.4	0.006000	0.154192	0.000925	0.005224
1608.5	0.004000	0.153897	0.000616	0.003476
1608.6	0.004000	0.153602	0.000614	0.003469
1608.7	0.004000	0.153307	0.000613	0.003462
1608.8	0.004000	0.153013	0.000612	0.003456
1608.9	0.004000	0.152719	0.000611	0.003449
1609.0	0.003000	0.152425	0.000457	0.002582
1609.1	0.003000	0.152131	0.000456	0.002577
1609.2	0.002000	0.151837	0.000304	0.001715
1609.3	0.003000	0.151543	0.000455	0.002567
1609.4	0.003000	0.151250	0.000454	0.002562
1609.5	0.004000	0.150957	0.000604	0.003409
1609.6	0.004000	0.150664	0.000603	0.003403
1609.7	0.004000	0.150372	0.000601	0.003396
1609.8	0.005000	0.150080	0.000750	0.004237
1609.9	0.005000	0.149788	0.000749	0.004229
1610.0	0.006000	0.149497	0.000897	0.005065
1610.1	0.007000	0.149237	0.001045	0.005898
1610.2	0.007000	0.148978	0.001043	0.005888
1610.3	0.007000	0.148720	0.001041	0.005878
1610.4	0.007000	0.148461	0.001039	0.005868
1610.5	0.007000	0.148203	0.001037	0.005858
1610.6	0.007000	0.147946	0.001036	0.005847
1610.7	0.007000	0.147688	0.001034	0.005837
1610.8	0.007000	0.147431	0.001032	0.005827
1610.9	0.007000	0.147174	0.001030	0.005817
1611.0	0.007000	0.146918	0.001028	0.005807
1611.1	0.007000	0.146660	0.001027	0.005797
1611.2	0.007000	0.146402	0.001025	0.005786
1611.3	0.007000	0.146145	0.001023	0.005776
1611.4	0.007000	0.145888	0.001021	0.005766
1611.5	0.007000	0.145632	0.001019	0.005756
1611.6	0.007000	0.145375	0.001018	0.005746
1611.7	0.006000	0.145119	0.000871	0.004916
1611.8	0.005000	0.144864	0.000724	0.004090
1611.9	0.006000	0.144609	0.000868	0.004899
1612.0	0.007000	0.144354	0.001010	0.005705
1612.1	0.006000	0.144107	0.000865	0.004882
1612.2	0.004000	0.143861	0.000575	0.003249
1612.3	0.004000	0.143616	0.000574	0.003244
1612.4	0.005000	0.143370	0.000717	0.004048

1612.5	0.005000	0.143125	0.000716	0.004041
1612.6	0.004000	0.142880	0.000572	0.003227
1612.7	0.004000	0.142635	0.000571	0.003221
1612.8	0.004000	0.142390	0.000570	0.003216
1612.9	0.004000	0.142146	0.000569	0.003210
1613.0	0.004000	0.141902	0.000568	0.003205
1613.1	0.004000	0.141658	0.000567	0.003199
1613.2	0.004000	0.141415	0.000566	0.003194
1613.3	0.004000	0.141171	0.000565	0.003188
1613.4	0.004000	0.140928	0.000564	0.003183
1613.5	0.004000	0.140685	0.000563	0.003177
1613.6	0.004000	0.140443	0.000562	0.003172
1613.7	0.005000	0.140200	0.000701	0.003958
1613.8	0.005000	0.139958	0.000700	0.003951
1613.9	0.005000	0.139716	0.000699	0.003944
1614.0	0.005000	0.139475	0.000697	0.003938
1614.1	0.005000	0.139220	0.000696	0.003930
1614.2	0.005000	0.138965	0.000695	0.003923
1614.3	0.005000	0.138710	0.000694	0.003916
1614.4	0.006000	0.138456	0.000831	0.004691
1614.5	0.006000	0.138202	0.000829	0.004682
1614.6	0.007000	0.137948	0.000966	0.005452
1614.7	0.007000	0.137695	0.000964	0.005442
1614.8	0.007000	0.137442	0.000962	0.005432
1614.9	0.007000	0.137190	0.000960	0.005422
1615.0	0.007000	0.136938	0.000959	0.005412
1615.1	0.007000	0.136685	0.000957	0.005402
1615.2	0.007000	0.136432	0.000955	0.005392
1615.3	0.007000	0.136180	0.000953	0.005382
1615.4	0.007000	0.135927	0.000951	0.005372
1615.5	0.007000	0.135676	0.000950	0.005362
1615.6	0.007000	0.135424	0.000948	0.005352
1615.7	0.007000	0.135173	0.000946	0.005343
1615.8	0.007000	0.134923	0.000944	0.005333
1615.9	0.007000	0.134673	0.000943	0.005323
1616.0	0.007000	0.134423	0.000941	0.005313
1616.1	0.007000	0.134205	0.000939	0.005304
1616.2	0.007000	0.133987	0.000938	0.005296
1616.3	0.007000	0.133770	0.000936	0.005287
1616.4	0.007000	0.133553	0.000935	0.005278
1616.5	0.007000	0.133336	0.000933	0.005270
1616.6	0.007000	0.133120	0.000932	0.005261
1616.7	0.008000	0.132904	0.001063	0.006003

1616.8	0.008000	0.132688	0.001062	0.005994
1616.9	0.008000	0.132473	0.001060	0.005984
1617.0	0.008000	0.132258	0.001058	0.005974
1617.1	0.008000	0.132042	0.001056	0.005964
1617.2	0.008000	0.131826	0.001055	0.005955
1617.3	0.008000	0.131610	0.001053	0.005945
1617.4	0.008000	0.131395	0.001051	0.005935
1617.5	0.008000	0.131180	0.001049	0.005925
1617.6	0.007000	0.130965	0.000917	0.005176
1617.7	0.007000	0.130751	0.000915	0.005168
1617.8	0.007000	0.130537	0.000914	0.005159
1617.9	0.007000	0.130323	0.000912	0.005151
1618.0	0.007000	0.130110	0.000911	0.005142
1618.1	0.007000	0.129898	0.000909	0.005134
1618.2	0.007000	0.129687	0.000908	0.005126
1618.3	0.007000	0.129475	0.000906	0.005117
1618.4	0.007000	0.129265	0.000905	0.005109
1618.5	0.007000	0.129054	0.000903	0.005101
1618.6	0.007000	0.128844	0.000902	0.005092
1618.7	0.006000	0.128635	0.000772	0.004358
1618.8	0.005000	0.128426	0.000642	0.003626
1618.9	0.006000	0.128217	0.000769	0.004344
1619.0	0.007000	0.128009	0.000896	0.005059
1619.1	0.006000	0.127800	0.000767	0.004330
1619.2	0.006000	0.127593	0.000766	0.004323
1619.3	0.004000	0.127385	0.000510	0.002877
1619.4	0.004000	0.127178	0.000509	0.002872
1619.5	0.005000	0.126971	0.000635	0.003585
1619.6	0.005000	0.126765	0.000634	0.003579
1619.7	0.005000	0.126560	0.000633	0.003573
1619.8	0.004000	0.126355	0.000505	0.002854
1619.9	0.004000	0.126150	0.000505	0.002849
1620.0	0.004000	0.125946	0.000504	0.002844
1620.1	0.004000	0.125802	0.000503	0.002841
1620.2	0.004000	0.125658	0.000503	0.002838
1620.3	0.004000	0.125514	0.000502	0.002835
1620.4	0.004000	0.125371	0.000501	0.002832
1620.5	0.004000	0.125228	0.000501	0.002828
1620.6	0.004000	0.125085	0.000500	0.002825
1620.7	0.004000	0.124943	0.000500	0.002822
1620.8	0.004000	0.124802	0.000499	0.002819
1620.9	0.004000	0.124660	0.000499	0.002815
1621.0	0.004000	0.124519	0.000498	0.002812

1621.1	0.004000	0.124379	0.000498	0.002809
1621.2	0.004000	0.124238	0.000497	0.002806
1621.3	0.004000	0.124099	0.000496	0.002803
1621.4	0.004000	0.123959	0.000496	0.002800
1621.5	0.004000	0.123820	0.000495	0.002796
1621.6	0.004000	0.123681	0.000495	0.002793
1621.7	0.004000	0.123543	0.000494	0.002790
1621.8	0.004000	0.123405	0.000494	0.002787
1621.9	0.004000	0.123267	0.000493	0.002784
1622.0	0.004000	0.123130	0.000493	0.002781
1622.1	0.004000	0.122979	0.000492	0.002777
1622.2	0.004000	0.122829	0.000491	0.002774
1622.3	0.004000	0.122679	0.000491	0.002771
1622.4	0.004000	0.122530	0.000490	0.002767
1622.5	0.004000	0.122381	0.000490	0.002764
1622.6	0.004000	0.122232	0.000489	0.002761
1622.7	0.004000	0.122084	0.000488	0.002757
1622.8	0.005000	0.121936	0.000610	0.003442
1622.9	0.007000	0.121788	0.000853	0.004814
1623.0	0.007000	0.121641	0.000851	0.004808
1623.1	0.007000	0.121495	0.000850	0.004802
1623.2	0.007000	0.121349	0.000849	0.004796
1623.3	0.007000	0.121203	0.000848	0.004790
1623.4	0.007000	0.121058	0.000847	0.004785
1623.5	0.007000	0.120913	0.000846	0.004779
1623.6	0.007000	0.120769	0.000845	0.004773
1623.7	0.007000	0.120625	0.000844	0.004768
1623.8	0.007000	0.120481	0.000843	0.004762
1623.9	0.007000	0.120337	0.000842	0.004756
1624.0	0.006000	0.120194	0.000721	0.004072
1624.1	0.005000	0.120058	0.000600	0.003389
1624.2	0.004000	0.119922	0.000480	0.002708
1624.3	0.004000	0.119786	0.000479	0.002705
1624.4	0.004000	0.119651	0.000479	0.002702
1624.5	0.004000	0.119515	0.000478	0.002699
1624.6	0.004000	0.119381	0.000478	0.002696
1624.7	0.004000	0.119246	0.000477	0.002693
1624.8	0.003000	0.119112	0.000357	0.002018
1624.9	0.002000	0.118978	0.000238	0.001344
1625.0	0.002000	0.118844	0.000238	0.001342
1625.1	0.001000	0.118711	0.000119	0.000670
1625.2	0.001000	0.118578	0.000119	0.000670
1625.3	0.001000	0.118445	0.000118	0.000669

1625.4	0.001000	0.118313	0.000118	0.000668
1625.5	0.001000	0.118181	0.000118	0.000667
1625.6	0.001000	0.118049	0.000118	0.000667
1625.7	0.001000	0.117918	0.000118	0.000666
1625.8	0.000000	0.117786	0.000000	0.000000
Channel 13				
Wavenumber	HIRS Filter Transmittance	Optical Element Transmittance	Product of the HIRS Filter and Optical Element Transmittances	Normalized Value of Column 4
2154.1	0.000312	0.397524	0.000124	0.000493
2154.2	0.000583	0.397676	0.000232	0.000920
2154.3	0.000812	0.397827	0.000323	0.001282
2154.4	0.001000	0.397979	0.000398	0.001579
2154.5	0.001084	0.398130	0.000432	0.001713
2154.6	0.001168	0.398717	0.000466	0.001848
2154.7	0.001252	0.398868	0.000500	0.001982
2154.8	0.001336	0.399018	0.000533	0.002116
2154.9	0.001421	0.399167	0.000567	0.002250
2155.0	0.001505	0.399317	0.000601	0.002384
2155.1	0.001589	0.399467	0.000635	0.002519
2155.2	0.001673	0.399617	0.000669	0.002653
2155.3	0.001757	0.399766	0.000702	0.002787
2155.4	0.001841	0.399915	0.000736	0.002922
2155.5	0.001925	0.400064	0.000770	0.003056
2155.6	0.002009	0.400213	0.000804	0.003191
2155.7	0.002093	0.400361	0.000838	0.003326
2155.8	0.002178	0.400508	0.000872	0.003461
2155.9	0.002262	0.401094	0.000907	0.003600
2156.0	0.002346	0.401241	0.000941	0.003735
2156.1	0.002430	0.401645	0.000976	0.003873
2156.2	0.002514	0.402048	0.001011	0.004011
2156.3	0.002598	0.402452	0.001046	0.004149
2156.4	0.002682	0.402855	0.001081	0.004288
2156.5	0.002766	0.403259	0.001116	0.004427
2156.6	0.002851	0.403663	0.001151	0.004566
2156.7	0.002935	0.404067	0.001186	0.004705
2156.8	0.003019	0.404471	0.001221	0.004845
2156.9	0.003103	0.404875	0.001256	0.004985
2157.0	0.003187	0.405279	0.001292	0.005125
2157.1	0.003271	0.405618	0.001327	0.005265
2157.2	0.003355	0.405956	0.001362	0.005405
2157.3	0.003439	0.406295	0.001397	0.005545

2157.4	0.003523	0.406633	0.001433	0.005685
2157.5	0.003608	0.406972	0.001468	0.005826
2157.6	0.003692	0.407311	0.001504	0.005967
2157.7	0.003776	0.407650	0.001539	0.006108
2157.8	0.003860	0.407989	0.001575	0.006249
2157.9	0.003944	0.408327	0.001610	0.006391
2158.0	0.004028	0.408667	0.001646	0.006532
2158.1	0.004112	0.409076	0.001682	0.006675
2158.2	0.004196	0.409485	0.001718	0.006819
2158.3	0.004280	0.409894	0.001755	0.006962
2158.4	0.004365	0.410304	0.001791	0.007106
2158.5	0.004449	0.410713	0.001827	0.007250
2158.6	0.004533	0.411123	0.001863	0.007395
2158.7	0.004617	0.411534	0.001900	0.007540
2158.8	0.004701	0.411944	0.001937	0.007685
2158.9	0.004785	0.412355	0.001973	0.007830
2159.0	0.004869	0.412766	0.002010	0.007976
2159.1	0.004953	0.413137	0.002046	0.008121
2159.2	0.005037	0.413509	0.002083	0.008266
2159.3	0.005122	0.413881	0.002120	0.008411
2159.4	0.005206	0.414289	0.002157	0.008558
2159.5	0.005290	0.414755	0.002194	0.008706
2159.6	0.005374	0.415222	0.002231	0.008854
2159.7	0.005458	0.415688	0.002269	0.009003
2159.8	0.005542	0.416155	0.002306	0.009152
2159.9	0.005626	0.416554	0.002344	0.009300
2160.0	0.005710	0.416928	0.002381	0.009448
2160.1	0.005794	0.417097	0.002417	0.009591
2160.2	0.005879	0.417267	0.002453	0.009734
2160.3	0.005963	0.417436	0.002489	0.009877
2160.4	0.006047	0.417605	0.002525	0.010020
2160.5	0.006131	0.417775	0.002561	0.010164
2160.6	0.006215	0.417944	0.002598	0.010308
2160.7	0.006299	0.418113	0.002634	0.010451
2160.8	0.006383	0.418282	0.002670	0.010595
2160.9	0.006467	0.418451	0.002706	0.010739
2161.0	0.006551	0.418620	0.002743	0.010883
2161.1	0.006635	0.418813	0.002779	0.011028
2161.2	0.006720	0.419179	0.002817	0.011177
2161.3	0.006804	0.419631	0.002855	0.011330
2161.4	0.006888	0.419824	0.002892	0.011475
2161.5	0.006972	0.420018	0.002928	0.011621
2161.6	0.007056	0.420211	0.002965	0.011766

2161.7	0.007140	0.420403	0.003002	0.011912
2161.8	0.007224	0.420596	0.003039	0.012058
2161.9	0.007308	0.420789	0.003075	0.012204
2162.0	0.007392	0.420982	0.003112	0.012350
2162.1	0.007477	0.421210	0.003149	0.012497
2162.2	0.007561	0.421439	0.003186	0.012644
2162.3	0.007645	0.421667	0.003224	0.012792
2162.4	0.007729	0.421895	0.003261	0.012940
2162.5	0.007813	0.422123	0.003298	0.013088
2162.6	0.007897	0.422351	0.003335	0.013236
2162.7	0.007981	0.422580	0.003373	0.013384
2162.8	0.008065	0.423270	0.003414	0.013547
2162.9	0.008150	0.423498	0.003451	0.013696
2163.0	0.008234	0.423727	0.003489	0.013844
2163.1	0.008318	0.423964	0.003526	0.013994
2163.2	0.008402	0.424201	0.003564	0.014143
2163.3	0.008486	0.424438	0.003602	0.014293
2163.4	0.008570	0.424675	0.003640	0.014443
2163.5	0.008654	0.424912	0.003677	0.014592
2163.6	0.008738	0.425149	0.003715	0.014742
2163.7	0.008822	0.425386	0.003753	0.014893
2163.8	0.008906	0.425623	0.003791	0.015043
2163.9	0.008991	0.425860	0.003829	0.015194
2164.0	0.009075	0.426096	0.003867	0.015344
2164.1	0.009159	0.426619	0.003907	0.015505
2164.2	0.009243	0.427142	0.003948	0.015667
2164.3	0.009327	0.427665	0.003989	0.015829
2164.4	0.009411	0.428188	0.004030	0.015991
2164.5	0.009495	0.428712	0.004071	0.016154
2164.6	0.009579	0.429237	0.004112	0.016317
2164.7	0.009664	0.429761	0.004153	0.016480
2164.8	0.009748	0.430286	0.004194	0.016644
2164.9	0.009832	0.430812	0.004236	0.016808
2165.0	0.009916	0.431338	0.004277	0.016973
2165.1	0.010000	0.431816	0.004318	0.017136
2165.2	0.011109	0.432294	0.004802	0.019057
2165.3	0.012312	0.432775	0.005328	0.021144
2165.4	0.013500	0.433256	0.005849	0.023210
2165.5	0.014233	0.433737	0.006173	0.024498
2165.6	0.014726	0.434219	0.006394	0.025374
2165.7	0.015053	0.434701	0.006544	0.025967
2165.8	0.015286	0.435183	0.006652	0.026398
2165.9	0.015500	0.435665	0.006753	0.026797

2166.0	0.015752	0.436148	0.006870	0.027263
2166.1	0.016037	0.436347	0.006998	0.027769
2166.2	0.016337	0.436546	0.007132	0.028301
2166.3	0.016631	0.436744	0.007263	0.028823
2166.4	0.016900	0.436943	0.007384	0.029303
2166.5	0.017132	0.437141	0.007489	0.029719
2166.6	0.017343	0.437818	0.007593	0.030131
2166.7	0.017559	0.438016	0.007691	0.030520
2166.8	0.017803	0.438215	0.007802	0.030959
2166.9	0.018100	0.438413	0.007935	0.031489
2167.0	0.018471	0.438454	0.008099	0.032138
2167.1	0.018923	0.438357	0.008295	0.032917
2167.2	0.019459	0.438554	0.008534	0.033864
2167.3	0.020083	0.438751	0.008811	0.034966
2167.4	0.020800	0.438948	0.009130	0.036231
2167.5	0.021608	0.439145	0.009489	0.037655
2167.6	0.022492	0.439342	0.009882	0.039213
2167.7	0.023432	0.439539	0.010299	0.040870
2167.8	0.024408	0.439735	0.010733	0.042592
2167.9	0.025400	0.439932	0.011174	0.044342
2168.0	0.026393	0.440129	0.011616	0.046097
2168.1	0.027391	0.440349	0.012062	0.047864
2168.2	0.028402	0.440570	0.012513	0.049655
2168.3	0.029436	0.440791	0.012975	0.051489
2168.4	0.030500	0.441011	0.013451	0.053376
2168.5	0.031606	0.441232	0.013946	0.055340
2168.6	0.032776	0.441452	0.014469	0.057417
2168.7	0.034032	0.441673	0.015031	0.059647
2168.8	0.035399	0.441893	0.015643	0.062074
2168.9	0.036900	0.442113	0.016314	0.064738
2169.0	0.038556	0.442334	0.017055	0.067677
2169.1	0.040378	0.442562	0.017870	0.070912
2169.2	0.042371	0.442790	0.018761	0.074450
2169.3	0.044543	0.443018	0.019733	0.078307
2169.4	0.046900	0.443246	0.020788	0.082493
2169.5	0.049442	0.443474	0.021926	0.087009
2169.6	0.052141	0.443703	0.023135	0.091806
2169.7	0.054957	0.443931	0.024397	0.096814
2169.8	0.057856	0.444159	0.025697	0.101973
2169.9	0.060800	0.444387	0.027019	0.107217
2170.0	0.063760	0.444615	0.028349	0.112495
2170.1	0.066739	0.444963	0.029696	0.117843
2170.2	0.069749	0.445371	0.031064	0.123271

2170.3	0.072799	0.445819	0.032455	0.128791
2170.4	0.075900	0.446267	0.033872	0.134412
2170.5	0.079068	0.446716	0.035321	0.140163
2170.6	0.082335	0.447164	0.036817	0.146101
2170.7	0.085739	0.447523	0.038370	0.152263
2170.8	0.089315	0.447872	0.040002	0.158737
2170.9	0.093100	0.448222	0.041729	0.165593
2171.0	0.097127	0.448571	0.043568	0.172891
2171.1	0.101410	0.448894	0.045522	0.180645
2171.2	0.105960	0.449217	0.047599	0.188885
2171.3	0.110790	0.449540	0.049804	0.197637
2171.4	0.115900	0.449863	0.052139	0.206902
2171.5	0.121300	0.450186	0.054608	0.216697
2171.6	0.126980	0.450509	0.057206	0.227007
2171.7	0.132900	0.450832	0.059916	0.237761
2171.8	0.139050	0.451156	0.062733	0.248942
2171.9	0.145400	0.451480	0.065645	0.260497
2172.0	0.151930	0.451804	0.068643	0.272392
2172.1	0.158610	0.451918	0.071679	0.284440
2172.2	0.165450	0.452033	0.074789	0.296782
2172.3	0.172410	0.452147	0.077955	0.309344
2172.4	0.179500	0.452261	0.081181	0.322147
2172.5	0.186700	0.452375	0.084458	0.335153
2172.6	0.194010	0.452489	0.087787	0.348363
2172.7	0.201460	0.452603	0.091181	0.361832
2172.8	0.209050	0.452717	0.094640	0.375558
2172.9	0.216800	0.452830	0.098174	0.389579
2173.0	0.224720	0.452944	0.101786	0.403912
2173.1	0.232820	0.453055	0.105480	0.418574
2173.2	0.241110	0.453167	0.109263	0.433584
2173.3	0.249600	0.453278	0.113138	0.448962
2173.4	0.258300	0.453389	0.117110	0.464725
2173.5	0.267200	0.453500	0.121175	0.480855
2173.6	0.276280	0.453611	0.125324	0.497317
2173.7	0.285490	0.453722	0.129533	0.514022
2173.8	0.294770	0.453833	0.133776	0.530860
2173.9	0.304100	0.453944	0.138044	0.547796
2174.0	0.313420	0.454054	0.142310	0.564722
2174.1	0.322690	0.454351	0.146615	0.581805
2174.2	0.331880	0.454648	0.150888	0.598765
2174.3	0.340930	0.454944	0.155104	0.615494
2174.4	0.349800	0.455241	0.159243	0.631920
2174.5	0.358470	0.455538	0.163297	0.648005

2174.6	0.366930	0.455835	0.167260	0.663730
2174.7	0.375220	0.456133	0.171150	0.679169
2174.8	0.383330	0.456430	0.174963	0.694300
2174.9	0.391300	0.456727	0.178717	0.709198
2175.0	0.399130	0.457025	0.182412	0.723860
2175.1	0.406820	0.457310	0.186043	0.738267
2175.2	0.414370	0.457596	0.189614	0.752438
2175.3	0.421760	0.457881	0.193116	0.766335
2175.4	0.429000	0.458167	0.196554	0.779976
2175.5	0.436070	0.458453	0.199917	0.793325
2175.6	0.442950	0.458738	0.203198	0.806344
2175.7	0.449630	0.459024	0.206391	0.819014
2175.8	0.456090	0.459310	0.209487	0.831298
2175.9	0.462300	0.459596	0.212471	0.843142
2176.0	0.468250	0.459882	0.215340	0.854525
2176.1	0.473940	0.460161	0.218089	0.865433
2176.2	0.479380	0.460440	0.220726	0.875897
2176.3	0.484560	0.460719	0.223246	0.885898
2176.4	0.489500	0.461501	0.225905	0.896448
2176.5	0.494190	0.461780	0.228207	0.905586
2176.6	0.498660	0.462060	0.230411	0.914330
2176.7	0.502920	0.462339	0.232520	0.922698
2176.8	0.507000	0.462618	0.234548	0.930746
2176.9	0.510900	0.462898	0.236495	0.938473
2177.0	0.514640	0.463178	0.238370	0.945914
2177.1	0.518220	0.463423	0.240155	0.952998
2177.2	0.521600	0.463668	0.241849	0.959721
2177.3	0.524760	0.463913	0.243443	0.966046
2177.4	0.527700	0.464159	0.244936	0.971972
2177.5	0.530380	0.464404	0.246311	0.977425
2177.6	0.532790	0.464649	0.247560	0.982385
2177.7	0.534890	0.464895	0.248668	0.986779
2177.8	0.536670	0.465647	0.249899	0.991665
2177.9	0.538100	0.465893	0.250697	0.994832
2178.0	0.539160	0.466139	0.251324	0.997318
2178.1	0.539870	0.466237	0.251707	0.998841
2178.2	0.540230	0.466335	0.251928	0.999717
2178.3	0.540270	0.466432	0.251999	1.000000
2178.4	0.540000	0.466530	0.251926	0.999709
2178.5	0.539440	0.466628	0.251718	0.998881
2178.6	0.538620	0.466725	0.251387	0.997572
2178.7	0.537580	0.466823	0.250954	0.995853
2178.8	0.536360	0.466920	0.250437	0.993800

2178.9	0.535000	0.467525	0.250126	0.992566
2179.0	0.533530	0.467623	0.249491	0.990046
2179.1	0.531950	0.467700	0.248793	0.987276
2179.2	0.530260	0.467777	0.248043	0.984301
2179.3	0.528440	0.467853	0.247232	0.981083
2179.4	0.526500	0.467930	0.246365	0.977641
2179.5	0.524420	0.468006	0.245432	0.973938
2179.6	0.522180	0.468083	0.244423	0.969936
2179.7	0.519760	0.468159	0.243330	0.965599
2179.8	0.517140	0.468236	0.242143	0.960888
2179.9	0.514300	0.468312	0.240853	0.955767
2180.0	0.511220	0.468388	0.239449	0.950198
2180.1	0.507910	0.468963	0.238191	0.945205
2180.2	0.504410	0.469029	0.236583	0.938823
2180.3	0.500730	0.469094	0.234890	0.932104
2180.4	0.496900	0.469160	0.233126	0.925104
2180.5	0.492940	0.469225	0.231300	0.917859
2180.6	0.488880	0.469291	0.229427	0.910426
2180.7	0.484740	0.469356	0.227516	0.902842
2180.8	0.480540	0.469422	0.225576	0.895144
2180.9	0.476300	0.469487	0.223617	0.887370
2181.0	0.472050	0.469553	0.221652	0.879575
2181.1	0.467800	0.469591	0.219675	0.871727
2181.2	0.463550	0.469630	0.217697	0.863879
2181.3	0.459320	0.469669	0.215728	0.856066
2181.4	0.455100	0.469707	0.213764	0.848271
2181.5	0.450910	0.469746	0.211813	0.840530
2181.6	0.446760	0.469785	0.209881	0.832863
2181.7	0.442650	0.469823	0.207967	0.825269
2181.8	0.438590	0.469862	0.206077	0.817767
2181.9	0.434600	0.469901	0.204219	0.810394
2182.0	0.430680	0.469939	0.202393	0.803150
2182.1	0.426830	0.470092	0.200649	0.796229
2182.2	0.423080	0.470244	0.198951	0.789489
2182.3	0.419430	0.470396	0.197298	0.782932
2182.4	0.415900	0.470549	0.195701	0.776594
2182.5	0.412490	0.470701	0.194160	0.770476
2182.6	0.409210	0.470854	0.192678	0.764598
2182.7	0.406050	0.471007	0.191252	0.758939
2182.8	0.403010	0.471159	0.189882	0.753501
2182.9	0.400100	0.471312	0.188572	0.748303
2183.0	0.397310	0.471464	0.187318	0.743325
2183.1	0.394630	0.471643	0.186124	0.738591

2183.2	0.392040	0.471822	0.184973	0.734022
2183.3	0.389530	0.472513	0.184058	0.730391
2183.4	0.387100	0.472692	0.182979	0.726109
2183.5	0.384730	0.472871	0.181928	0.721937
2183.6	0.382420	0.473050	0.180904	0.717874
2183.7	0.380190	0.473229	0.179917	0.713957
2183.8	0.378040	0.473408	0.178967	0.710189
2183.9	0.376000	0.473587	0.178069	0.706623
2184.0	0.374060	0.473766	0.177217	0.703243
2184.1	0.372230	0.473927	0.176410	0.700040
2184.2	0.370510	0.474087	0.175654	0.697042
2184.3	0.368900	0.474248	0.174950	0.694248
2184.4	0.367400	0.474409	0.174298	0.691659
2184.5	0.366010	0.474569	0.173697	0.689276
2184.6	0.364720	0.474730	0.173144	0.687079
2184.7	0.363520	0.474893	0.172633	0.685053
2184.8	0.362420	0.475055	0.172170	0.683214
2184.9	0.361400	0.475218	0.171744	0.681524
2185.0	0.360460	0.475380	0.171356	0.679984
2185.1	0.359590	0.475579	0.171013	0.678626
2185.2	0.358800	0.476294	0.170894	0.678153
2185.3	0.358070	0.476493	0.170618	0.677057
2185.4	0.357400	0.476692	0.170370	0.676072
2185.5	0.356800	0.476891	0.170155	0.675219
2185.6	0.356280	0.477090	0.169978	0.674516
2185.7	0.355860	0.477289	0.169848	0.674002
2185.8	0.355560	0.477489	0.169776	0.673715
2185.9	0.355400	0.477688	0.169770	0.673693
2186.0	0.355400	0.477887	0.169841	0.673974
2186.1	0.355540	0.478041	0.169963	0.674457
2186.2	0.355800	0.478195	0.170142	0.675168
2186.3	0.356160	0.478429	0.170397	0.676181
2186.4	0.356600	0.478997	0.170810	0.677820
2186.5	0.357100	0.479151	0.171105	0.678989
2186.6	0.357650	0.479305	0.171424	0.680254
2186.7	0.358210	0.479460	0.171747	0.681538
2186.8	0.358770	0.479614	0.172071	0.682823
2186.9	0.359300	0.480288	0.172568	0.684793
2187.0	0.359790	0.480369	0.172832	0.685843
2187.1	0.360220	0.480070	0.172931	0.686235
2187.2	0.360610	0.480192	0.173162	0.687152
2187.3	0.360930	0.480313	0.173359	0.687936
2187.4	0.361200	0.480435	0.173533	0.688624

2187.5	0.361410	0.480556	0.173678	0.689199
2187.6	0.361560	0.480678	0.173794	0.689660
2187.7	0.361690	0.480799	0.173900	0.690082
2187.8	0.361800	0.481021	0.174033	0.690610
2187.9	0.361900	0.481248	0.174164	0.691127
2188.0	0.362010	0.481475	0.174299	0.691663
2188.1	0.362130	0.481732	0.174450	0.692262
2188.2	0.362260	0.481973	0.174600	0.692857
2188.3	0.362380	0.482125	0.174712	0.693305
2188.4	0.362500	0.482277	0.174825	0.693753
2188.5	0.362610	0.482429	0.174934	0.694182
2188.6	0.362710	0.482581	0.175037	0.694593
2188.7	0.362810	0.482733	0.175140	0.695003
2188.8	0.362900	0.483408	0.175429	0.696148
2188.9	0.363000	0.483561	0.175533	0.696559
2189.0	0.363100	0.483713	0.175636	0.696970
2189.1	0.363210	0.483851	0.175739	0.697380
2189.2	0.363310	0.483988	0.175838	0.697770
2189.3	0.363410	0.484126	0.175936	0.698161
2189.4	0.363500	0.484263	0.176030	0.698532
2189.5	0.363580	0.484401	0.176118	0.698884
2189.6	0.363630	0.484538	0.176193	0.699178
2189.7	0.363660	0.484676	0.176257	0.699435
2189.8	0.363650	0.484813	0.176302	0.699614
2189.9	0.363600	0.484951	0.176328	0.699716
2190.0	0.363500	0.485088	0.176330	0.699722
2190.1	0.363360	0.485362	0.176361	0.699847
2190.2	0.363180	0.485636	0.176373	0.699896
2190.3	0.362960	0.485910	0.176366	0.699867
2190.4	0.362700	0.486185	0.176339	0.699760
2190.5	0.362410	0.486459	0.176298	0.699595
2190.6	0.362090	0.486754	0.176249	0.699401
2190.7	0.361740	0.487135	0.176216	0.699272
2190.8	0.361340	0.487516	0.176159	0.699046
2190.9	0.360900	0.487898	0.176082	0.698741
2191.0	0.360410	0.488279	0.175981	0.698338
2191.1	0.359880	0.488613	0.175842	0.697788
2191.2	0.359320	0.488882	0.175665	0.697086
2191.3	0.358720	0.489152	0.175469	0.696306
2191.4	0.358100	0.489422	0.175262	0.695486
2191.5	0.357460	0.490222	0.175235	0.695377
2191.6	0.356810	0.490492	0.175012	0.694495
2191.7	0.356140	0.490762	0.174780	0.693572

2191.8	0.355470	0.491032	0.174547	0.692649
2191.9	0.354800	0.491302	0.174314	0.691724
2192.0	0.354120	0.491573	0.174076	0.690778
2192.1	0.353430	0.492156	0.173943	0.690250
2192.2	0.352710	0.492208	0.173607	0.688917
2192.3	0.351930	0.492260	0.173241	0.687466
2192.4	0.351100	0.492312	0.172851	0.685917
2192.5	0.350190	0.492895	0.172607	0.684950
2192.6	0.349200	0.492947	0.172137	0.683085
2192.7	0.348140	0.492999	0.171633	0.681083
2192.8	0.347000	0.493050	0.171088	0.678924
2192.9	0.345800	0.493102	0.170515	0.676647
2193.0	0.344520	0.493153	0.169901	0.674213
2193.1	0.343160	0.493718	0.169424	0.672320
2193.2	0.341700	0.493750	0.168714	0.669503
2193.3	0.340120	0.493783	0.167945	0.666451
2193.4	0.338400	0.493815	0.167107	0.663124
2193.5	0.336530	0.493847	0.166194	0.659503
2193.6	0.334510	0.493879	0.165208	0.655587
2193.7	0.332340	0.493912	0.164147	0.651377
2193.8	0.330040	0.493944	0.163021	0.646911
2193.9	0.327600	0.494508	0.162001	0.642861
2194.0	0.325040	0.494540	0.160745	0.637880
2194.1	0.322370	0.494629	0.159454	0.632754
2194.2	0.319620	0.494718	0.158122	0.627468
2194.3	0.316820	0.494806	0.156765	0.622083
2194.4	0.314000	0.494895	0.155397	0.616656
2194.5	0.311170	0.494983	0.154024	0.611208
2194.6	0.308350	0.495072	0.152655	0.605777
2194.7	0.305540	0.495161	0.151291	0.600364
2194.8	0.302750	0.495249	0.149937	0.594988
2194.9	0.300000	0.495338	0.148601	0.589689
2195.0	0.297280	0.495427	0.147280	0.584448
2195.1	0.294560	0.495528	0.145963	0.579218
2195.2	0.291830	0.495629	0.144639	0.573967
2195.3	0.289050	0.495729	0.143291	0.568615
2195.4	0.286200	0.495830	0.141907	0.563123
2195.5	0.283250	0.495931	0.140473	0.557432
2195.6	0.280190	0.496032	0.138983	0.551522
2195.7	0.277050	0.496133	0.137454	0.545452
2195.8	0.273810	0.496234	0.135874	0.539183
2195.9	0.270500	0.496335	0.134259	0.532774
2196.0	0.267110	0.496970	0.132746	0.526769

2196.1	0.263680	0.497125	0.131082	0.520167
2196.2	0.260230	0.497280	0.129407	0.513522
2196.3	0.256800	0.497435	0.127741	0.506911
2196.4	0.253400	0.497590	0.126089	0.500356
2196.5	0.250070	0.497746	0.124471	0.493935
2196.6	0.246810	0.497901	0.122887	0.487648
2196.7	0.243630	0.498056	0.121341	0.481515
2196.8	0.240530	0.498212	0.119835	0.475536
2196.9	0.237500	0.498367	0.118362	0.469692
2197.0	0.234550	0.498523	0.116928	0.464003
2197.1	0.231670	0.498654	0.115523	0.458426
2197.2	0.228860	0.498785	0.114152	0.452985
2197.3	0.226110	0.498917	0.112810	0.447660
2197.4	0.223400	0.499048	0.111487	0.442411
2197.5	0.220730	0.499180	0.110184	0.437239
2197.6	0.218100	0.499311	0.108900	0.432143
2197.7	0.215470	0.499443	0.107615	0.427045
2197.8	0.212840	0.499575	0.106329	0.421943
2197.9	0.210200	0.499706	0.105038	0.416819
2198.0	0.207530	0.499838	0.103731	0.411633
2198.1	0.204820	0.499848	0.102379	0.406266
2198.2	0.202080	0.500396	0.101120	0.401271
2198.3	0.199310	0.500406	0.099736	0.395779
2198.4	0.196500	0.500417	0.098332	0.390207
2198.5	0.193660	0.500427	0.096913	0.384575
2198.6	0.190770	0.500438	0.095469	0.378844
2198.7	0.187850	0.500448	0.094009	0.373053
2198.8	0.184900	0.500459	0.092535	0.367202
2198.9	0.181900	0.500469	0.091035	0.361252
2199.0	0.178860	0.500479	0.089516	0.355222
2199.1	0.175790	0.500450	0.087974	0.349105
2199.2	0.172690	0.500421	0.086418	0.342928
2199.3	0.169560	0.500392	0.084847	0.336693
2199.4	0.166400	0.500363	0.083260	0.330399
2199.5	0.163230	0.500334	0.081670	0.324086
2199.6	0.160050	0.500842	0.080160	0.318095
2199.7	0.156890	0.500813	0.078573	0.311797
2199.8	0.153770	0.500784	0.077006	0.305578
2199.9	0.150700	0.500755	0.075464	0.299460
2200.0	0.147700	0.500726	0.073957	0.293482
2200.1	0.144780	0.500834	0.072511	0.287742
2200.2	0.141940	0.500943	0.071104	0.282159
2200.3	0.139170	0.501051	0.069731	0.276712

2200.4	0.136500	0.501159	0.068408	0.271462
2200.5	0.133910	0.501267	0.067125	0.266369
2200.6	0.131390	0.501376	0.065876	0.261412
2200.7	0.128910	0.501484	0.064646	0.256534
2200.8	0.126450	0.501593	0.063426	0.251693
2200.9	0.124000	0.501702	0.062211	0.246870
2201.0	0.121530	0.502348	0.061050	0.242264
2201.1	0.119050	0.502480	0.059820	0.237383
2201.2	0.116580	0.502613	0.058595	0.232519
2201.3	0.114130	0.502745	0.057378	0.227692
2201.4	0.111700	0.502878	0.056171	0.222903
2201.5	0.109310	0.503010	0.054984	0.218191
2201.6	0.106980	0.503143	0.053826	0.213596
2201.7	0.104690	0.503275	0.052688	0.209079
2201.8	0.102460	0.503407	0.051579	0.204680
2201.9	0.100300	0.503540	0.050505	0.200417
2202.0	0.098202	0.503672	0.049462	0.196277
2202.1	0.096148	0.503907	0.048450	0.192261
2202.2	0.094114	0.504142	0.047447	0.188281
2202.3	0.092073	0.504377	0.046439	0.184284
2202.4	0.090000	0.505152	0.045464	0.180412
2202.5	0.087878	0.505387	0.044412	0.176240
2202.6	0.085723	0.505622	0.043343	0.171998
2202.7	0.083559	0.505857	0.042269	0.167734
2202.8	0.081410	0.506092	0.041201	0.163496
2202.9	0.079300	0.506328	0.040152	0.159333
2203.0	0.077253	0.506563	0.039134	0.155292
2203.1	0.075290	0.506827	0.038159	0.151425
2203.2	0.073430	0.507092	0.037236	0.147761
2203.3	0.071693	0.507356	0.036374	0.144341
2203.4	0.070100	0.507620	0.035584	0.141207
2203.5	0.068663	0.507885	0.034873	0.138385
2203.6	0.067368	0.508149	0.034233	0.135845
2203.7	0.066190	0.508414	0.033652	0.133540
2203.8	0.065109	0.508678	0.033120	0.131427
2203.9	0.064100	0.508943	0.032623	0.129458
2204.0	0.063141	0.509208	0.032152	0.127587
2204.1	0.062201	0.509299	0.031679	0.125710
2204.2	0.061252	0.509390	0.031201	0.123814
2204.3	0.060261	0.510026	0.030735	0.121963
2204.4	0.059200	0.510117	0.030199	0.119837
2204.5	0.058048	0.510207	0.029617	0.117526
2204.6	0.056828	0.510298	0.028999	0.115077

2204.7	0.055574	0.510389	0.028364	0.112557
2204.8	0.054320	0.510480	0.027729	0.110037
2204.9	0.053100	0.510571	0.027111	0.107585
2205.0	0.051939	0.510661	0.026523	0.105251
2205.1	0.050827	0.510698	0.025957	0.103005
2205.2	0.049746	0.510735	0.025407	0.100822
2205.3	0.048676	0.510771	0.024862	0.098660
2205.4	0.047600	0.510808	0.024314	0.096486
2205.5	0.046503	0.510845	0.023756	0.094269
2205.6	0.045387	0.510881	0.023187	0.092014
2205.7	0.044260	0.510918	0.022613	0.089735
2205.8	0.043129	0.510955	0.022037	0.087448
2205.9	0.042000	0.510991	0.021462	0.085165
2206.0	0.040882	0.511028	0.020892	0.082904
2206.1	0.039783	0.511112	0.020334	0.080689
2206.2	0.038713	0.511196	0.019790	0.078532
2206.3	0.037682	0.511281	0.019266	0.076453
2206.4	0.036700	0.511365	0.018767	0.074473
2206.5	0.035772	0.511450	0.018296	0.072602
2206.6	0.034891	0.511534	0.017848	0.070825
2206.7	0.034043	0.511619	0.017417	0.069115
2206.8	0.033217	0.512250	0.017015	0.067522
2206.9	0.032400	0.512335	0.016600	0.065872
2207.0	0.031579	0.512419	0.016182	0.064213
2207.1	0.030737	0.512436	0.015751	0.062503
2207.2	0.029856	0.512453	0.015300	0.060714
2207.3	0.028916	0.512470	0.014819	0.058804
2207.4	0.027900	0.512488	0.014298	0.056740
2207.5	0.026796	0.512505	0.013733	0.054496
2207.6	0.025620	0.512522	0.013131	0.052106
2207.7	0.024397	0.512539	0.012504	0.049621
2207.8	0.023149	0.512556	0.011865	0.047084
2207.9	0.021900	0.512573	0.011225	0.044545
2208.0	0.020673	0.512590	0.010597	0.042051
2208.1	0.019489	0.512718	0.009992	0.039652
2208.2	0.018368	0.512847	0.009420	0.037381
2208.3	0.017332	0.512975	0.008891	0.035281
2208.4	0.016400	0.513103	0.008415	0.033393
2208.5	0.015590	0.513232	0.008001	0.031751
2208.6	0.014904	0.513360	0.007651	0.030362
2208.7	0.014344	0.514037	0.007373	0.029259
2208.8	0.013910	0.514165	0.007152	0.028381
2208.9	0.013600	0.514294	0.006994	0.027756

2209.0	0.013412	0.514422	0.006899	0.027379
2209.1	0.013329	0.514591	0.006859	0.027218
2209.2	0.013330	0.515254	0.006868	0.027255
2209.3	0.013394	0.515460	0.006904	0.027397
2209.4	0.013500	0.515630	0.006961	0.027623
2209.5	0.013630	0.515799	0.007030	0.027898
2209.6	0.013772	0.515969	0.007106	0.028198
2209.7	0.013920	0.516138	0.007185	0.028511
2209.8	0.014066	0.516308	0.007262	0.028819
2209.9	0.014200	0.516477	0.007334	0.029103
2210.0	0.014317	0.516647	0.007397	0.029353
2210.1	0.014415	0.516657	0.007448	0.029554
2210.2	0.014494	0.516666	0.007489	0.029717
2210.3	0.014556	0.516676	0.007521	0.029844
2210.4	0.014600	0.516685	0.007544	0.029935
2210.5	0.014622	0.516206	0.007548	0.029952
2210.6	0.014600	0.516173	0.007536	0.029905
2210.7	0.014507	0.516183	0.007488	0.029715
2210.8	0.014316	0.516192	0.007390	0.029325
2210.9	0.014000	0.516202	0.007227	0.028678
2211.0	0.013428	0.516211	0.006932	0.027507
2211.1	0.012661	0.516278	0.006537	0.025939
2211.2	0.011816	0.516344	0.006101	0.024211
2211.3	0.011012	0.516410	0.005687	0.022566
2211.4	0.010367	0.516476	0.005354	0.021247
2211.5	0.010000	0.516542	0.005165	0.020498
2211.6	0.009925	0.516608	0.005127	0.020347
2211.7	0.009850	0.516674	0.005089	0.020195
2211.8	0.009775	0.516740	0.005051	0.020044
2211.9	0.009700	0.516807	0.005013	0.019893
2212.0	0.009625	0.517424	0.004980	0.019763
2212.1	0.009550	0.517554	0.004943	0.019614
2212.2	0.009475	0.517683	0.004905	0.019465
2212.3	0.009400	0.517813	0.004867	0.019315
2212.4	0.009325	0.517955	0.004830	0.019166
2212.5	0.009250	0.518196	0.004793	0.019021
2212.6	0.009175	0.518437	0.004757	0.018876
2212.7	0.009100	0.518679	0.004720	0.018730
2212.8	0.009025	0.519472	0.004688	0.018604
2212.9	0.008950	0.519690	0.004651	0.018457
2213.0	0.008875	0.519821	0.004613	0.018307
2213.1	0.008800	0.519909	0.004575	0.018156
2213.2	0.008725	0.519997	0.004537	0.018004

2213.3	0.008650	0.520085	0.004499	0.017852
2213.4	0.008575	0.519620	0.004456	0.017682
2213.5	0.008500	0.519708	0.004418	0.017530
2213.6	0.008425	0.520350	0.004384	0.017397
2213.7	0.008350	0.520439	0.004346	0.017245
2213.8	0.008275	0.520527	0.004307	0.017093
2213.9	0.008200	0.520615	0.004269	0.016941
2214.0	0.008125	0.520703	0.004231	0.016789
2214.1	0.008050	0.520917	0.004193	0.016640
2214.2	0.007975	0.521131	0.004156	0.016492
2214.3	0.007900	0.521345	0.004119	0.016344
2214.4	0.007825	0.521559	0.004081	0.016195
2214.5	0.007750	0.521773	0.004044	0.016047
2214.6	0.007675	0.521987	0.004006	0.015898
2214.7	0.007600	0.522201	0.003969	0.015749
2214.8	0.007525	0.522415	0.003931	0.015600
2214.9	0.007450	0.522629	0.003894	0.015451
2215.0	0.007375	0.522843	0.003856	0.015301
2215.1	0.007300	0.523023	0.003818	0.015151
2215.2	0.007225	0.523203	0.003780	0.015001
2215.3	0.007150	0.523383	0.003742	0.014850
2215.4	0.007075	0.523563	0.003704	0.014699
2215.5	0.007000	0.523742	0.003666	0.014548
2215.6	0.006925	0.523922	0.003628	0.014397
2215.7	0.006850	0.524660	0.003594	0.014262
2215.8	0.006775	0.524840	0.003556	0.014110
2215.9	0.006700	0.525020	0.003518	0.013959
2216.0	0.006625	0.525201	0.003479	0.013807
2216.1	0.006550	0.524977	0.003439	0.013645
2216.2	0.006475	0.524753	0.003398	0.013483
2216.3	0.006400	0.524530	0.003357	0.013321
2216.4	0.006325	0.524306	0.003316	0.013160
2216.5	0.006250	0.524083	0.003276	0.012998
2216.6	0.006175	0.523859	0.003235	0.012837
2216.7	0.006100	0.523635	0.003194	0.012675
2216.8	0.006025	0.523411	0.003154	0.012514
2216.9	0.005950	0.523187	0.003113	0.012353
2217.0	0.005875	0.522962	0.003072	0.012192
2217.1	0.005800	0.522779	0.003032	0.012032
2217.2	0.005725	0.522596	0.002992	0.011872
2217.3	0.005650	0.522412	0.002952	0.011713
2217.4	0.005575	0.522229	0.002911	0.011553
2217.5	0.005500	0.522045	0.002871	0.011394

2217.6	0.005425	0.521861	0.002831	0.011235
2217.7	0.005350	0.521677	0.002791	0.011075
2217.8	0.005275	0.521493	0.002751	0.010916
2217.9	0.005200	0.521309	0.002711	0.010757
2218.0	0.005125	0.521125	0.002671	0.010598
2218.1	0.005050	0.521326	0.002633	0.010447
2218.2	0.004975	0.521527	0.002595	0.010296
2218.3	0.004900	0.521728	0.002556	0.010145
2218.4	0.004825	0.521930	0.002518	0.009993
2218.5	0.004750	0.522131	0.002480	0.009842
2218.6	0.004675	0.522333	0.002442	0.009690
2218.7	0.004600	0.522534	0.002404	0.009538
2218.8	0.004525	0.522736	0.002365	0.009386
2218.9	0.004450	0.523493	0.002330	0.009244
2219.0	0.004375	0.523695	0.002291	0.009092
2219.1	0.004300	0.523910	0.002253	0.008940
2219.2	0.004225	0.524124	0.002214	0.008787
2219.3	0.004150	0.524339	0.002176	0.008635
2219.4	0.004075	0.524554	0.002138	0.008482
2219.5	0.004000	0.524768	0.002099	0.008330
2219.6	0.003925	0.524983	0.002061	0.008177
2219.7	0.003850	0.525198	0.002022	0.008024
2219.8	0.003775	0.525413	0.001983	0.007871
2219.9	0.003700	0.525628	0.001945	0.007718
2220.0	0.003625	0.525843	0.001906	0.007564
2220.1	0.003550	0.526146	0.001868	0.007412
2220.2	0.003475	0.526450	0.001829	0.007260
2220.3	0.003400	0.526754	0.001791	0.007107
2220.4	0.003325	0.527057	0.001752	0.006954
2220.5	0.003250	0.527361	0.001714	0.006801
2220.6	0.003175	0.527665	0.001675	0.006648
2220.7	0.003100	0.527970	0.001637	0.006495
2220.8	0.003025	0.528835	0.001600	0.006348
2220.9	0.002950	0.529140	0.001561	0.006194
2221.0	0.002875	0.529445	0.001522	0.006040
2221.1	0.002800	0.529705	0.001483	0.005886
2221.2	0.002725	0.529965	0.001444	0.005731
2221.3	0.002650	0.530225	0.001405	0.005576
2221.4	0.002575	0.530485	0.001366	0.005421
2221.5	0.002500	0.530745	0.001327	0.005265
2221.6	0.002425	0.531005	0.001288	0.005110
2221.7	0.002350	0.531266	0.001248	0.004954
2221.8	0.002275	0.531526	0.001209	0.004799

2221.9	0.002200	0.531787	0.001170	0.004643
2222.0	0.002125	0.532048	0.001131	0.004487
2222.1	0.002050	0.531950	0.001090	0.004327
2222.2	0.001975	0.531853	0.001050	0.004168
2222.3	0.001900	0.531755	0.001010	0.004009
2222.4	0.001825	0.531657	0.000970	0.003850
2222.5	0.001750	0.531559	0.000930	0.003691
2222.6	0.001675	0.532026	0.000891	0.003536
2222.7	0.001600	0.531928	0.000851	0.003377
2222.8	0.001525	0.531830	0.000811	0.003218
2222.9	0.001450	0.531732	0.000771	0.003060
2223.0	0.001375	0.531634	0.000731	0.002901
2223.1	0.001300	0.531518	0.000691	0.002742
2223.2	0.001225	0.531402	0.000651	0.002583
2223.3	0.001150	0.531286	0.000611	0.002425
2223.4	0.001075	0.531170	0.000571	0.002266
2223.5	0.001000	0.531054	0.000531	0.002107
2223.6	0.000850	0.530937	0.000451	0.001791
2223.7	0.000675	0.530821	0.000358	0.001422
2223.8	0.000475	0.530705	0.000252	0.001000
2223.9	0.000250	0.530589	0.000133	0.000526
2224.0	0.000000	0.530473	0.000000	0.000000
Channel 14				
Wavenumber	HIRS Filter Transmittance	Optical Element Transmittance	Product of the HIRS Filter and Optical Element Transmittances	Normalized Value of Column 4
2142.1	0.000123	0.352980	0.000043	0.000178
2142.2	0.000266	0.353023	0.000094	0.000384
2142.3	0.000424	0.353111	0.000150	0.000611
2142.4	0.000591	0.353416	0.000209	0.000853
2142.5	0.000762	0.353391	0.000269	0.001100
2142.6	0.000932	0.353515	0.000329	0.001346
2142.7	0.001096	0.354033	0.000388	0.001585
2142.8	0.001249	0.354080	0.000442	0.001807
2142.9	0.001385	0.354122	0.000491	0.002004
2143.0	0.001500	0.354165	0.000531	0.002171
2143.1	0.001589	0.354185	0.000563	0.002300
2143.2	0.001656	0.354204	0.000586	0.002396
2143.3	0.001703	0.354223	0.000603	0.002464
2143.4	0.001734	0.354243	0.000614	0.002510
2143.5	0.001753	0.354262	0.000621	0.002538
2143.6	0.001764	0.354281	0.000625	0.002554

2143.7	0.001771	0.354300	0.000627	0.002564
2143.8	0.001777	0.354318	0.000630	0.002572
2143.9	0.001786	0.354732	0.000633	0.002588
2144.0	0.001801	0.354750	0.000639	0.002610
2144.1	0.001826	0.354985	0.000648	0.002648
2144.2	0.001859	0.355614	0.000661	0.002701
2144.3	0.001898	0.355849	0.000675	0.002759
2144.4	0.001941	0.356084	0.000691	0.002823
2144.5	0.001985	0.356319	0.000707	0.002890
2144.6	0.002029	0.356553	0.000723	0.002955
2144.7	0.002070	0.356788	0.000738	0.003017
2144.8	0.002105	0.357023	0.000752	0.003071
2144.9	0.002134	0.357258	0.000762	0.003115
2145.0	0.002153	0.357494	0.000770	0.003145
2145.1	0.002161	0.357749	0.000773	0.003159
2145.2	0.002160	0.358004	0.000773	0.003159
2145.3	0.002151	0.358260	0.000771	0.003148
2145.4	0.002136	0.358516	0.000766	0.003129
2145.5	0.002119	0.359171	0.000761	0.003109
2145.6	0.002100	0.359427	0.000755	0.003084
2145.7	0.002082	0.360083	0.000750	0.003062
2145.8	0.002066	0.360340	0.000745	0.003042
2145.9	0.002056	0.360996	0.000742	0.003033
2146.0	0.002053	0.361254	0.000742	0.003030
2146.1	0.002058	0.361588	0.000744	0.003041
2146.2	0.002071	0.361923	0.000750	0.003062
2146.3	0.002089	0.362660	0.000757	0.003095
2146.4	0.002110	0.362995	0.000766	0.003129
2146.5	0.002133	0.362928	0.000774	0.003162
2146.6	0.002155	0.363264	0.000783	0.003199
2146.7	0.002175	0.363600	0.000791	0.003231
2146.8	0.002191	0.363936	0.000797	0.003258
2146.9	0.002201	0.364272	0.000802	0.003275
2147.0	0.002202	0.364608	0.000803	0.003280
2147.1	0.002194	0.365107	0.000801	0.003273
2147.2	0.002176	0.366012	0.000796	0.003253
2147.3	0.002147	0.366513	0.000787	0.003215
2147.4	0.002108	0.367015	0.000774	0.003161
2147.5	0.002059	0.367516	0.000757	0.003092
2147.6	0.001999	0.368425	0.000736	0.003009
2147.7	0.001928	0.368928	0.000711	0.002907
2147.8	0.001847	0.369431	0.000682	0.002788
2147.9	0.001755	0.369934	0.000649	0.002652

2148.0	0.001651	0.370438	0.000612	0.002499
2148.1	0.001537	0.370720	0.000570	0.002328
2148.2	0.001415	0.371001	0.000525	0.002145
2148.3	0.001290	0.371282	0.000479	0.001956
2148.4	0.001163	0.371562	0.000432	0.001766
2148.5	0.001040	0.371843	0.000387	0.001581
2148.6	0.000924	0.372123	0.000344	0.001405
2148.7	0.000818	0.372403	0.000305	0.001245
2148.8	0.000726	0.372683	0.000271	0.001106
2148.9	0.000651	0.372963	0.000243	0.000993
2149.0	0.000598	0.373655	0.000223	0.000913
2149.1	0.000568	0.373925	0.000213	0.000868
2149.2	0.000563	0.374195	0.000211	0.000861
2149.3	0.000581	0.374465	0.000217	0.000888
2149.4	0.000621	0.375148	0.000233	0.000952
2149.5	0.000683	0.375418	0.000256	0.001048
2149.6	0.000767	0.375687	0.000288	0.001177
2149.7	0.000871	0.375956	0.000327	0.001338
2149.8	0.000995	0.376225	0.000374	0.001529
2149.9	0.001138	0.376494	0.000429	0.001751
2150.0	0.001300	0.376762	0.000490	0.002001
2150.1	0.001479	0.377148	0.000558	0.002279
2150.2	0.001671	0.377535	0.000631	0.002578
2150.3	0.001871	0.377921	0.000707	0.002889
2150.4	0.002075	0.378307	0.000785	0.003207
2150.5	0.002277	0.378694	0.000862	0.003524
2150.6	0.002473	0.379081	0.000938	0.003831
2150.7	0.002658	0.379467	0.001009	0.004122
2150.8	0.002828	0.379854	0.001074	0.004388
2150.9	0.002976	0.380241	0.001132	0.004623
2151.0	0.003099	0.380628	0.001180	0.004819
2151.1	0.003193	0.380996	0.001216	0.004970
2151.2	0.003259	0.381364	0.001243	0.005079
2151.3	0.003301	0.382154	0.001262	0.005155
2151.4	0.003322	0.382522	0.001271	0.005191
2151.5	0.003323	0.382891	0.001272	0.005199
2151.6	0.003309	0.383260	0.001268	0.005182
2151.7	0.003282	0.383629	0.001259	0.005144
2151.8	0.003244	0.383998	0.001246	0.005090
2151.9	0.003200	0.384791	0.001231	0.005031
2152.0	0.003151	0.385161	0.001214	0.004959
2152.1	0.003100	0.385672	0.001196	0.004885
2152.2	0.003050	0.386183	0.001178	0.004812

2152.3	0.002999	0.387121	0.001161	0.004744
2152.4	0.002951	0.387633	0.001144	0.004673
2152.5	0.002905	0.388146	0.001127	0.004607
2152.6	0.002863	0.388660	0.001113	0.004546
2152.7	0.002825	0.389173	0.001100	0.004493
2152.8	0.002794	0.390116	0.001090	0.004454
2152.9	0.002770	0.390631	0.001082	0.004420
2153.0	0.002753	0.391147	0.001077	0.004400
2153.1	0.002745	0.391680	0.001075	0.004393
2153.2	0.002744	0.392214	0.001076	0.004397
2153.3	0.002749	0.393180	0.001081	0.004416
2153.4	0.002758	0.393715	0.001086	0.004437
2153.5	0.002769	0.394251	0.001092	0.004461
2153.6	0.002782	0.394787	0.001098	0.004487
2153.7	0.002793	0.395324	0.001104	0.004511
2153.8	0.002802	0.396295	0.001110	0.004536
2153.9	0.002806	0.396833	0.001114	0.004550
2154.0	0.002805	0.397372	0.001115	0.004554
2154.1	0.002797	0.397524	0.001112	0.004543
2154.2	0.002782	0.397676	0.001106	0.004521
2154.3	0.002762	0.397827	0.001099	0.004490
2154.4	0.002738	0.397979	0.001090	0.004452
2154.5	0.002710	0.398130	0.001079	0.004408
2154.6	0.002680	0.398717	0.001068	0.004365
2154.7	0.002648	0.398868	0.001056	0.004315
2154.8	0.002615	0.399018	0.001044	0.004264
2154.9	0.002583	0.399167	0.001031	0.004213
2155.0	0.002553	0.399317	0.001019	0.004165
2155.1	0.002525	0.399467	0.001009	0.004121
2155.2	0.002500	0.399617	0.000999	0.004081
2155.3	0.002477	0.399766	0.000990	0.004045
2155.4	0.002457	0.399915	0.000982	0.004014
2155.5	0.002440	0.400064	0.000976	0.003988
2155.6	0.002426	0.400213	0.000971	0.003966
2155.7	0.002415	0.400361	0.000967	0.003950
2155.8	0.002407	0.400508	0.000964	0.003939
2155.9	0.002403	0.401094	0.000964	0.003938
2156.0	0.002402	0.401241	0.000964	0.003938
2156.1	0.002404	0.401645	0.000966	0.003946
2156.2	0.002408	0.402048	0.000968	0.003956
2156.3	0.002412	0.402452	0.000971	0.003966
2156.4	0.002413	0.402855	0.000972	0.003971
2156.5	0.002409	0.403259	0.000972	0.003970

2156.6	0.002399	0.403663	0.000968	0.003957
2156.7	0.002381	0.404067	0.000962	0.003930
2156.8	0.002351	0.404471	0.000951	0.003886
2156.9	0.002309	0.404875	0.000935	0.003820
2157.0	0.002253	0.405279	0.000913	0.003731
2157.1	0.002181	0.405618	0.000884	0.003614
2157.2	0.002093	0.405956	0.000850	0.003472
2157.3	0.001993	0.406295	0.000810	0.003309
2157.4	0.001883	0.406633	0.000766	0.003128
2157.5	0.001763	0.406972	0.000717	0.002931
2157.6	0.001636	0.407311	0.000667	0.002723
2157.7	0.001505	0.407650	0.000613	0.002506
2157.8	0.001370	0.407989	0.000559	0.002284
2157.9	0.001235	0.408327	0.000504	0.002060
2158.0	0.001100	0.408667	0.000450	0.001837
2158.1	0.000968	0.409076	0.000396	0.001618
2158.2	0.000841	0.409485	0.000344	0.001407
2158.3	0.000721	0.409894	0.000296	0.001208
2158.4	0.000610	0.410304	0.000250	0.001023
2158.5	0.000510	0.410713	0.000209	0.000856
2158.6	0.000423	0.411123	0.000174	0.000711
2158.7	0.000351	0.411534	0.000145	0.000591
2158.8	0.000297	0.411944	0.000122	0.000500
2158.9	0.000262	0.412355	0.000108	0.000441
2159.0	0.000248	0.412766	0.000102	0.000418
2159.1	0.000257	0.413137	0.000106	0.000433
2159.2	0.000286	0.413509	0.000118	0.000483
2159.3	0.000333	0.413881	0.000138	0.000563
2159.4	0.000394	0.414289	0.000163	0.000667
2159.5	0.000467	0.414755	0.000194	0.000791
2159.6	0.000548	0.415222	0.000228	0.000930
2159.7	0.000635	0.415688	0.000264	0.001079
2159.8	0.000725	0.416155	0.000302	0.001232
2159.9	0.000814	0.416554	0.000339	0.001385
2160.0	0.000900	0.416928	0.000375	0.001533
2160.1	0.000980	0.417097	0.000409	0.001671
2160.2	0.001055	0.417267	0.000440	0.001798
2160.3	0.001124	0.417436	0.000469	0.001917
2160.4	0.001189	0.417605	0.000496	0.002028
2160.5	0.001249	0.417775	0.000522	0.002132
2160.6	0.001305	0.417944	0.000545	0.002228
2160.7	0.001358	0.418113	0.000568	0.002320
2160.8	0.001408	0.418282	0.000589	0.002406

2160.9	0.001455	0.418451	0.000609	0.002488
2161.0	0.001501	0.418620	0.000628	0.002567
2161.1	0.001545	0.418813	0.000647	0.002644
2161.2	0.001589	0.419179	0.000666	0.002722
2161.3	0.001635	0.419631	0.000686	0.002803
2161.4	0.001683	0.419824	0.000707	0.002887
2161.5	0.001735	0.420018	0.000729	0.002978
2161.6	0.001793	0.420211	0.000753	0.003078
2161.7	0.001857	0.420403	0.000781	0.003190
2161.8	0.001929	0.420596	0.000811	0.003315
2161.9	0.002011	0.420789	0.000846	0.003458
2162.0	0.002104	0.420982	0.000886	0.003619
2162.1	0.002208	0.421210	0.000930	0.003800
2162.2	0.002320	0.421439	0.000978	0.003995
2162.3	0.002436	0.421667	0.001027	0.004197
2162.4	0.002552	0.421895	0.001077	0.004399
2162.5	0.002663	0.422123	0.001124	0.004594
2162.6	0.002766	0.422351	0.001168	0.004773
2162.7	0.002856	0.422580	0.001207	0.004931
2162.8	0.002929	0.423270	0.001240	0.005064
2162.9	0.002980	0.423498	0.001262	0.005156
2163.0	0.003006	0.423727	0.001274	0.005204
2163.1	0.003004	0.423964	0.001274	0.005203
2163.2	0.002975	0.424201	0.001262	0.005157
2163.3	0.002925	0.424438	0.001241	0.005072
2163.4	0.002856	0.424675	0.001213	0.004955
2163.5	0.002772	0.424912	0.001178	0.004812
2163.6	0.002676	0.425149	0.001138	0.004648
2163.7	0.002573	0.425386	0.001094	0.004472
2163.8	0.002465	0.425623	0.001049	0.004287
2163.9	0.002358	0.425860	0.001004	0.004102
2164.0	0.002253	0.426096	0.000960	0.003922
2164.1	0.002155	0.426619	0.000919	0.003756
2164.2	0.002063	0.427142	0.000881	0.003601
2164.3	0.001979	0.427665	0.000846	0.003458
2164.4	0.001902	0.428188	0.000815	0.003328
2164.5	0.001833	0.428712	0.000786	0.003210
2164.6	0.001771	0.429237	0.000760	0.003106
2164.7	0.001717	0.429761	0.000738	0.003015
2164.8	0.001670	0.430286	0.000719	0.002937
2164.9	0.001632	0.430812	0.000703	0.002873
2165.0	0.001602	0.431338	0.000691	0.002823
2165.1	0.001580	0.431816	0.000682	0.002787

2165.2	0.001564	0.432294	0.000676	0.002762
2165.3	0.001553	0.432775	0.000672	0.002746
2165.4	0.001545	0.433256	0.000669	0.002734
2165.5	0.001537	0.433737	0.000667	0.002724
2165.6	0.001529	0.434219	0.000664	0.002713
2165.7	0.001519	0.434701	0.000660	0.002697
2165.8	0.001503	0.435183	0.000654	0.002673
2165.9	0.001482	0.435665	0.000646	0.002637
2166.0	0.001452	0.436148	0.000633	0.002587
2166.1	0.001413	0.436347	0.000616	0.002519
2166.2	0.001365	0.436546	0.000596	0.002434
2166.3	0.001308	0.436744	0.000571	0.002334
2166.4	0.001244	0.436943	0.000543	0.002220
2166.5	0.001173	0.437141	0.000513	0.002095
2166.6	0.001097	0.437818	0.000480	0.001961
2166.7	0.001015	0.438016	0.000445	0.001816
2166.8	0.000929	0.438215	0.000407	0.001663
2166.9	0.000840	0.438413	0.000368	0.001504
2167.0	0.000748	0.438454	0.000328	0.001340
2167.1	0.000655	0.438357	0.000287	0.001173
2167.2	0.000563	0.438554	0.000247	0.001008
2167.3	0.000474	0.438751	0.000208	0.000850
2167.4	0.000392	0.438948	0.000172	0.000704
2167.5	0.000320	0.439145	0.000141	0.000574
2167.6	0.000260	0.439342	0.000114	0.000466
2167.7	0.000215	0.439539	0.000094	0.000385
2167.8	0.000187	0.439735	0.000082	0.000336
2167.9	0.000180	0.439932	0.000079	0.000323
2168.0	0.000196	0.440129	0.000086	0.000352
2168.1	0.000237	0.440349	0.000104	0.000427
2168.2	0.000300	0.440570	0.000132	0.000540
2168.3	0.000381	0.440791	0.000168	0.000686
2168.4	0.000476	0.441011	0.000210	0.000857
2168.5	0.000580	0.441232	0.000256	0.001045
2168.6	0.000689	0.441452	0.000304	0.001243
2168.7	0.000800	0.441673	0.000353	0.001444
2168.8	0.000908	0.441893	0.000401	0.001640
2168.9	0.001010	0.442113	0.000446	0.001824
2169.0	0.001100	0.442334	0.000487	0.001988
2169.1	0.001176	0.442562	0.000520	0.002126
2169.2	0.001238	0.442790	0.000548	0.002240
2169.3	0.001287	0.443018	0.000570	0.002329
2169.4	0.001324	0.443246	0.000587	0.002397

2169.5	0.001350	0.443474	0.000598	0.002445
2169.6	0.001366	0.443703	0.000606	0.002475
2169.7	0.001373	0.443931	0.000609	0.002490
2169.8	0.001372	0.444159	0.000609	0.002489
2169.9	0.001364	0.444387	0.000606	0.002477
2170.0	0.001351	0.444615	0.000601	0.002454
2170.1	0.001333	0.444963	0.000593	0.002423
2170.2	0.001311	0.445371	0.000584	0.002386
2170.3	0.001286	0.445819	0.000573	0.002343
2170.4	0.001259	0.446267	0.000562	0.002296
2170.5	0.001231	0.446716	0.000550	0.002247
2170.6	0.001202	0.447164	0.000538	0.002196
2170.7	0.001174	0.447523	0.000525	0.002146
2170.8	0.001147	0.447872	0.000514	0.002099
2170.9	0.001122	0.448222	0.000503	0.002055
2171.0	0.001100	0.448571	0.000493	0.002016
2171.1	0.001082	0.448894	0.000486	0.001984
2171.2	0.001066	0.449217	0.000479	0.001956
2171.3	0.001052	0.449540	0.000473	0.001932
2171.4	0.001038	0.449863	0.000467	0.001908
2171.5	0.001023	0.450186	0.000461	0.001882
2171.6	0.001007	0.450509	0.000454	0.001853
2171.7	0.000987	0.450832	0.000445	0.001819
2171.8	0.000964	0.451156	0.000435	0.001776
2171.9	0.000935	0.451480	0.000422	0.001724
2172.0	0.000899	0.451804	0.000406	0.001660
2172.1	0.000857	0.451918	0.000387	0.001582
2172.2	0.000812	0.452033	0.000367	0.001499
2172.3	0.000768	0.452147	0.000347	0.001419
2172.4	0.000731	0.452261	0.000330	0.001350
2172.5	0.000704	0.452375	0.000319	0.001302
2172.6	0.000693	0.452489	0.000314	0.001282
2172.7	0.000703	0.452603	0.000318	0.001300
2172.8	0.000737	0.452717	0.000334	0.001364
2172.9	0.000801	0.452830	0.000363	0.001482
2173.0	0.000899	0.452944	0.000407	0.001664
2173.1	0.001034	0.453055	0.000468	0.001914
2173.2	0.001200	0.453167	0.000544	0.002222
2173.3	0.001390	0.453278	0.000630	0.002574
2173.4	0.001596	0.453389	0.000724	0.002956
2173.5	0.001811	0.453500	0.000821	0.003355
2173.6	0.002027	0.453611	0.000919	0.003757
2173.7	0.002237	0.453722	0.001015	0.004147

2173.8	0.002433	0.453833	0.001104	0.004511
2173.9	0.002608	0.453944	0.001184	0.004837
2174.0	0.002754	0.454054	0.001250	0.005109
2174.1	0.002865	0.454351	0.001302	0.005319
2174.2	0.002943	0.454648	0.001338	0.005466
2174.3	0.002988	0.454944	0.001360	0.005555
2174.4	0.003004	0.455241	0.001368	0.005588
2174.5	0.002993	0.455538	0.001363	0.005571
2174.6	0.002957	0.455835	0.001348	0.005506
2174.7	0.002897	0.456133	0.001322	0.005400
2174.8	0.002818	0.456430	0.001286	0.005254
2174.9	0.002719	0.456727	0.001242	0.005074
2175.0	0.002605	0.457025	0.001191	0.004864
2175.1	0.002477	0.457310	0.001133	0.004628
2175.2	0.002338	0.457596	0.001070	0.004372
2175.3	0.002193	0.457881	0.001004	0.004102
2175.4	0.002043	0.458167	0.000936	0.003825
2175.5	0.001893	0.458453	0.000868	0.003546
2175.6	0.001746	0.458738	0.000801	0.003272
2175.7	0.001605	0.459024	0.000737	0.003009
2175.8	0.001473	0.459310	0.000676	0.002764
2175.9	0.001354	0.459596	0.000622	0.002542
2176.0	0.001251	0.459882	0.000575	0.002351
2176.1	0.001167	0.460161	0.000537	0.002194
2176.2	0.001102	0.460440	0.000508	0.002074
2176.3	0.001057	0.460719	0.000487	0.001989
2176.4	0.001030	0.461501	0.000475	0.001942
2176.5	0.001022	0.461780	0.000472	0.001927
2176.6	0.001032	0.462060	0.000477	0.001948
2176.7	0.001060	0.462339	0.000490	0.002002
2176.8	0.001106	0.462618	0.000512	0.002090
2176.9	0.001170	0.462898	0.000541	0.002212
2177.0	0.001251	0.463178	0.000579	0.002367
2177.1	0.001349	0.463423	0.000625	0.002554
2177.2	0.001461	0.463668	0.000678	0.002768
2177.3	0.001585	0.463913	0.000735	0.003003
2177.4	0.001716	0.464159	0.000796	0.003254
2177.5	0.001853	0.464404	0.000860	0.003515
2177.6	0.001991	0.464649	0.000925	0.003780
2177.7	0.002129	0.464895	0.000990	0.004043
2177.8	0.002262	0.465647	0.001053	0.004304
2177.9	0.002389	0.465893	0.001113	0.004547
2178.0	0.002505	0.466139	0.001168	0.004771

2178.1	0.002609	0.466237	0.001217	0.004971
2178.2	0.002704	0.466335	0.001261	0.005152
2178.3	0.002793	0.466432	0.001303	0.005323
2178.4	0.002880	0.466530	0.001343	0.005489
2178.5	0.002968	0.466628	0.001385	0.005658
2178.6	0.003061	0.466725	0.001429	0.005838
2178.7	0.003163	0.466823	0.001477	0.006034
2178.8	0.003278	0.466920	0.001531	0.006253
2178.9	0.003409	0.467525	0.001594	0.006511
2179.0	0.003559	0.467623	0.001664	0.006800
2179.1	0.003732	0.467700	0.001745	0.007131
2179.2	0.003923	0.467777	0.001835	0.007498
2179.3	0.004130	0.467853	0.001932	0.007896
2179.4	0.004349	0.467930	0.002035	0.008314
2179.5	0.004574	0.468006	0.002141	0.008747
2179.6	0.004803	0.468083	0.002248	0.009185
2179.7	0.005030	0.468159	0.002355	0.009622
2179.8	0.005253	0.468236	0.002460	0.010049
2179.9	0.005466	0.468312	0.002560	0.010459
2180.0	0.005666	0.468388	0.002654	0.010843
2180.1	0.005849	0.468963	0.002743	0.011208
2180.2	0.006015	0.469029	0.002821	0.011527
2180.3	0.006164	0.469094	0.002892	0.011814
2180.4	0.006296	0.469160	0.002954	0.012068
2180.5	0.006410	0.469225	0.003008	0.012288
2180.6	0.006507	0.469291	0.003053	0.012476
2180.7	0.006586	0.469356	0.003091	0.012630
2180.8	0.006648	0.469422	0.003121	0.012750
2180.9	0.006693	0.469487	0.003142	0.012838
2181.0	0.006720	0.469553	0.003155	0.012892
2181.1	0.006731	0.469591	0.003161	0.012914
2181.2	0.006729	0.469630	0.003160	0.012911
2181.3	0.006719	0.469669	0.003156	0.012893
2181.4	0.006706	0.469707	0.003150	0.012869
2181.5	0.006694	0.469746	0.003144	0.012847
2181.6	0.006688	0.469785	0.003142	0.012837
2181.7	0.006693	0.469823	0.003145	0.012848
2181.8	0.006714	0.469862	0.003155	0.012889
2181.9	0.006755	0.469901	0.003174	0.012968
2182.0	0.006820	0.469939	0.003205	0.013095
2182.1	0.006914	0.470092	0.003250	0.013279
2182.2	0.007036	0.470244	0.003308	0.013517
2182.3	0.007183	0.470396	0.003379	0.013805

2182.4	0.007354	0.470549	0.003461	0.014139
2182.5	0.007548	0.470701	0.003553	0.014515
2182.6	0.007761	0.470854	0.003654	0.014930
2182.7	0.007992	0.471007	0.003765	0.015381
2182.8	0.008240	0.471159	0.003883	0.015863
2182.9	0.008503	0.471312	0.004008	0.016374
2183.0	0.008778	0.471464	0.004139	0.016909
2183.1	0.009064	0.471643	0.004275	0.017467
2183.2	0.009362	0.471822	0.004417	0.018048
2183.3	0.009673	0.472513	0.004571	0.018674
2183.4	0.009997	0.472692	0.004726	0.019308
2183.5	0.010337	0.472871	0.004888	0.019971
2183.6	0.010692	0.473050	0.005058	0.020665
2183.7	0.011064	0.473229	0.005236	0.021392
2183.8	0.011454	0.473408	0.005422	0.022154
2183.9	0.011862	0.473587	0.005618	0.022952
2184.0	0.012291	0.473766	0.005823	0.023791
2184.1	0.012740	0.473927	0.006038	0.024669
2184.2	0.013203	0.474087	0.006259	0.025574
2184.3	0.013677	0.474248	0.006486	0.026501
2184.4	0.014154	0.474409	0.006715	0.027435
2184.5	0.014630	0.474569	0.006943	0.028367
2184.6	0.015099	0.474730	0.007168	0.029286
2184.7	0.015554	0.474893	0.007386	0.030179
2184.8	0.015991	0.475055	0.007597	0.031038
2184.9	0.016403	0.475218	0.007795	0.031848
2185.0	0.016786	0.475380	0.007980	0.032603
2185.1	0.017135	0.475579	0.008149	0.033295
2185.2	0.017455	0.476294	0.008314	0.033968
2185.3	0.017754	0.476493	0.008460	0.034564
2185.4	0.018037	0.476692	0.008598	0.035129
2185.5	0.018312	0.476891	0.008733	0.035680
2185.6	0.018585	0.477090	0.008867	0.036227
2185.7	0.018864	0.477289	0.009004	0.036786
2185.8	0.019156	0.477489	0.009147	0.037371
2185.9	0.019466	0.477688	0.009299	0.037992
2186.0	0.019802	0.477887	0.009463	0.038664
2186.1	0.020170	0.478041	0.009642	0.039395
2186.2	0.020573	0.478195	0.009838	0.040195
2186.3	0.021013	0.478429	0.010053	0.041075
2186.4	0.021492	0.478997	0.010295	0.042061
2186.5	0.022012	0.479151	0.010547	0.043092
2186.6	0.022575	0.479305	0.010820	0.044209

2186.7	0.023184	0.479460	0.011116	0.045416
2186.8	0.023840	0.479614	0.011434	0.046716
2186.9	0.024546	0.480288	0.011789	0.048167
2187.0	0.025303	0.480369	0.012155	0.049661
2187.1	0.026113	0.480070	0.012536	0.051219
2187.2	0.026975	0.480192	0.012953	0.052923
2187.3	0.027887	0.480313	0.013394	0.054726
2187.4	0.028847	0.480435	0.013859	0.056624
2187.5	0.029853	0.480556	0.014346	0.058614
2187.6	0.030902	0.480678	0.014854	0.060689
2187.7	0.031994	0.480799	0.015383	0.062849
2187.8	0.033125	0.481021	0.015934	0.065101
2187.9	0.034295	0.481248	0.016504	0.067432
2188.0	0.035501	0.481475	0.017093	0.069837
2188.1	0.036741	0.481732	0.017699	0.072315
2188.2	0.038015	0.481973	0.018322	0.074859
2188.3	0.039322	0.482125	0.018958	0.077458
2188.4	0.040660	0.482277	0.019609	0.080119
2188.5	0.042030	0.482429	0.020276	0.082844
2188.6	0.043430	0.482581	0.020958	0.085631
2188.7	0.044860	0.482733	0.021655	0.088478
2188.8	0.046319	0.483408	0.022391	0.091483
2188.9	0.047806	0.483561	0.023117	0.094450
2189.0	0.049321	0.483713	0.023857	0.097474
2189.1	0.050863	0.483851	0.024610	0.100550
2189.2	0.052433	0.483988	0.025377	0.103683
2189.3	0.054033	0.484126	0.026159	0.106878
2189.4	0.055664	0.484263	0.026956	0.110135
2189.5	0.057328	0.484401	0.027770	0.113459
2189.6	0.059026	0.484538	0.028600	0.116853
2189.7	0.060759	0.484676	0.029448	0.120318
2189.8	0.062529	0.484813	0.030315	0.123858
2189.9	0.064338	0.484951	0.031201	0.127478
2190.0	0.066187	0.485088	0.032107	0.131178
2190.1	0.068077	0.485362	0.033042	0.135001
2190.2	0.070010	0.485636	0.033999	0.138912
2190.3	0.071989	0.485910	0.034980	0.142920
2190.4	0.074013	0.486185	0.035984	0.147021
2190.5	0.076087	0.486459	0.037013	0.151226
2190.6	0.078210	0.486754	0.038069	0.155540
2190.7	0.080385	0.487135	0.039158	0.159990
2190.8	0.082614	0.487516	0.040276	0.164555
2190.9	0.084898	0.487898	0.041422	0.169237

2191.0	0.087240	0.488279	0.042597	0.174042
2191.1	0.089640	0.488613	0.043799	0.178952
2191.2	0.092100	0.488882	0.045026	0.183964
2191.3	0.094620	0.489152	0.046284	0.189102
2191.4	0.097200	0.489422	0.047572	0.194366
2191.5	0.099842	0.490222	0.048945	0.199975
2191.6	0.102550	0.490492	0.050300	0.205512
2191.7	0.105310	0.490762	0.051682	0.211159
2191.8	0.108140	0.491032	0.053100	0.216953
2191.9	0.111030	0.491302	0.054549	0.222873
2192.0	0.113990	0.491573	0.056034	0.228941
2192.1	0.117010	0.492156	0.057587	0.235285
2192.2	0.120080	0.492208	0.059104	0.241484
2192.3	0.123220	0.492260	0.060656	0.247825
2192.4	0.126400	0.492312	0.062228	0.254248
2192.5	0.129620	0.492895	0.063889	0.261033
2192.6	0.132890	0.492947	0.065508	0.267647
2192.7	0.136180	0.492999	0.067137	0.274302
2192.8	0.139500	0.493050	0.068781	0.281018
2192.9	0.142850	0.493102	0.070440	0.287797
2193.0	0.146210	0.493153	0.072104	0.294597
2193.1	0.149590	0.493718	0.073855	0.301752
2193.2	0.152980	0.493750	0.075534	0.308611
2193.3	0.156390	0.493783	0.077223	0.315511
2193.4	0.159820	0.493815	0.078922	0.322452
2193.5	0.163270	0.493847	0.080630	0.329434
2193.6	0.166750	0.493879	0.082354	0.336478
2193.7	0.170250	0.493912	0.084088	0.343562
2193.8	0.173790	0.493944	0.085842	0.350729
2193.9	0.177370	0.494508	0.087711	0.358362
2194.0	0.180980	0.494540	0.089502	0.365680
2194.1	0.184630	0.494629	0.091323	0.373122
2194.2	0.188320	0.494718	0.093165	0.380648
2194.3	0.192040	0.494806	0.095023	0.388236
2194.4	0.195790	0.494895	0.096895	0.395888
2194.5	0.199550	0.494983	0.098774	0.403563
2194.6	0.203340	0.495072	0.100668	0.411302
2194.7	0.207130	0.495161	0.102563	0.419043
2194.8	0.210930	0.495249	0.104463	0.426807
2194.9	0.214730	0.495338	0.106364	0.434574
2195.0	0.218520	0.495427	0.108261	0.442323
2195.1	0.222310	0.495528	0.110161	0.450087
2195.2	0.226090	0.495629	0.112057	0.457833

2195.3	0.229860	0.495729	0.113948	0.465562
2195.4	0.233620	0.495830	0.115836	0.473274
2195.5	0.237370	0.495931	0.117719	0.480968
2195.6	0.241120	0.496032	0.119603	0.488666
2195.7	0.244850	0.496133	0.121478	0.496327
2195.8	0.248580	0.496234	0.123354	0.503990
2195.9	0.252300	0.496335	0.125225	0.511637
2196.0	0.256010	0.496970	0.127229	0.519824
2196.1	0.259720	0.497125	0.129113	0.527521
2196.2	0.263420	0.497280	0.130993	0.535203
2196.3	0.267120	0.497435	0.132875	0.542890
2196.4	0.270810	0.497590	0.134752	0.550562
2196.5	0.274510	0.497746	0.136636	0.558258
2196.6	0.278210	0.497901	0.138521	0.565959
2196.7	0.281910	0.498056	0.140407	0.573665
2196.8	0.285620	0.498212	0.142299	0.581396
2196.9	0.289340	0.498367	0.144198	0.589152
2197.0	0.293080	0.498523	0.146107	0.596953
2197.1	0.296820	0.498654	0.148010	0.604730
2197.2	0.300570	0.498785	0.149920	0.612532
2197.3	0.304330	0.498917	0.151835	0.620358
2197.4	0.308070	0.499048	0.153742	0.628147
2197.5	0.311800	0.499180	0.155644	0.635920
2197.6	0.315520	0.499311	0.157543	0.643677
2197.7	0.319200	0.499443	0.159422	0.651355
2197.8	0.322860	0.499575	0.161293	0.658998
2197.9	0.326470	0.499706	0.163139	0.666542
2198.0	0.330030	0.499838	0.164961	0.673987
2198.1	0.333550	0.499848	0.166724	0.681190
2198.2	0.337010	0.500396	0.168638	0.689010
2198.3	0.340420	0.500406	0.170348	0.695997
2198.4	0.343790	0.500417	0.172038	0.702901
2198.5	0.347110	0.500427	0.173703	0.709704
2198.6	0.350390	0.500438	0.175348	0.716426
2198.7	0.353640	0.500448	0.176978	0.723086
2198.8	0.356840	0.500459	0.178584	0.729644
2198.9	0.360010	0.500469	0.180174	0.736141
2199.0	0.363160	0.500479	0.181754	0.742597
2199.1	0.366270	0.500450	0.183300	0.748913
2199.2	0.369350	0.500421	0.184831	0.755167
2199.3	0.372410	0.500392	0.186351	0.761379
2199.4	0.375430	0.500363	0.187851	0.767509
2199.5	0.378440	0.500334	0.189346	0.773618

2199.6	0.381410	0.500842	0.191026	0.780481
2199.7	0.384360	0.500813	0.192493	0.786472
2199.8	0.387290	0.500784	0.193949	0.792421
2199.9	0.390190	0.500755	0.195390	0.798308
2200.0	0.393070	0.500726	0.196820	0.804154
2200.1	0.395930	0.500834	0.198295	0.810180
2200.2	0.398750	0.500943	0.199751	0.816127
2200.3	0.401550	0.501051	0.201197	0.822036
2200.4	0.404300	0.501159	0.202619	0.827844
2200.5	0.407000	0.501267	0.204016	0.833553
2200.6	0.409660	0.501376	0.205394	0.839182
2200.7	0.412250	0.501484	0.206737	0.844670
2200.8	0.414780	0.501593	0.208051	0.850038
2200.9	0.417230	0.501702	0.209325	0.855245
2201.0	0.419610	0.502348	0.210790	0.861231
2201.1	0.421910	0.502480	0.212002	0.866180
2201.2	0.424140	0.502613	0.213178	0.870988
2201.3	0.426290	0.502745	0.214315	0.875633
2201.4	0.428390	0.502878	0.215428	0.880179
2201.5	0.430440	0.503010	0.216516	0.884624
2201.6	0.432450	0.503143	0.217584	0.888989
2201.7	0.434430	0.503275	0.218638	0.893294
2201.8	0.436380	0.503407	0.219677	0.897540
2201.9	0.438310	0.503540	0.220707	0.901747
2202.0	0.440240	0.503672	0.221737	0.905956
2202.1	0.442170	0.503907	0.222813	0.910351
2202.2	0.444090	0.504142	0.223884	0.914730
2202.3	0.445990	0.504377	0.224947	0.919071
2202.4	0.447880	0.505152	0.226247	0.924384
2202.5	0.449730	0.505387	0.227288	0.928635
2202.6	0.451550	0.505622	0.228314	0.932827
2202.7	0.453330	0.505857	0.229320	0.936940
2202.8	0.455050	0.506092	0.230297	0.940932
2202.9	0.456710	0.506328	0.231245	0.944804
2203.0	0.458310	0.506563	0.232163	0.948555
2203.1	0.459840	0.506827	0.233060	0.952217
2203.2	0.461290	0.507092	0.233916	0.955718
2203.3	0.462670	0.507356	0.234738	0.959077
2203.4	0.463990	0.507620	0.235531	0.962314
2203.5	0.465250	0.507885	0.236293	0.965430
2203.6	0.466440	0.508149	0.237021	0.968403
2203.7	0.467570	0.508414	0.237719	0.971255
2203.8	0.468650	0.508678	0.238392	0.974005

2203.9	0.469670	0.508943	0.239035	0.976633
2204.0	0.470640	0.509208	0.239654	0.979159
2204.1	0.471560	0.509299	0.240165	0.981248
2204.2	0.472430	0.509390	0.240651	0.983234
2204.3	0.473250	0.510026	0.241370	0.986171
2204.4	0.474010	0.510117	0.241800	0.987930
2204.5	0.474730	0.510207	0.242211	0.989607
2204.6	0.475390	0.510298	0.242591	0.991159
2204.7	0.475990	0.510389	0.242940	0.992587
2204.8	0.476540	0.510480	0.243264	0.993910
2204.9	0.477030	0.510571	0.243557	0.995109
2205.0	0.477460	0.510661	0.243820	0.996183
2205.1	0.477830	0.510698	0.244027	0.997027
2205.2	0.478150	0.510735	0.244208	0.997766
2205.3	0.478410	0.510771	0.244358	0.998380
2205.4	0.478620	0.510808	0.244483	0.998890
2205.5	0.478780	0.510845	0.244582	0.999296
2205.6	0.478900	0.510881	0.244661	0.999618
2205.7	0.478970	0.510918	0.244714	0.999836
2205.8	0.479000	0.510955	0.244747	0.999970
2205.9	0.478980	0.510991	0.244755	1.000000
2206.0	0.478940	0.511028	0.244752	0.999988
2206.1	0.478850	0.511112	0.244746	0.999965
2206.2	0.478730	0.511196	0.244725	0.999879
2206.3	0.478570	0.511281	0.244684	0.999710
2206.4	0.478370	0.511365	0.244622	0.999458
2206.5	0.478120	0.511450	0.244534	0.999100
2206.6	0.477830	0.511534	0.244426	0.998659
2206.7	0.477490	0.511619	0.244293	0.998114
2206.8	0.477110	0.512250	0.244400	0.998550
2206.9	0.476670	0.512335	0.244215	0.997794
2207.0	0.476180	0.512419	0.244004	0.996932
2207.1	0.475630	0.512436	0.243730	0.995814
2207.2	0.475030	0.512453	0.243431	0.994591
2207.3	0.474380	0.512470	0.243106	0.993263
2207.4	0.473680	0.512488	0.242755	0.991831
2207.5	0.472940	0.512505	0.242384	0.990314
2207.6	0.472170	0.512522	0.241997	0.988735
2207.7	0.471350	0.512539	0.241585	0.987051
2207.8	0.470510	0.512556	0.241163	0.985324
2207.9	0.469640	0.512573	0.240725	0.983535
2208.0	0.468740	0.512590	0.240271	0.981683
2208.1	0.467810	0.512718	0.239855	0.979981

2208.2	0.466870	0.512847	0.239433	0.978257
2208.3	0.465910	0.512975	0.239000	0.976490
2208.4	0.464950	0.513103	0.238567	0.974721
2208.5	0.463970	0.513232	0.238124	0.972910
2208.6	0.462980	0.513360	0.237675	0.971076
2208.7	0.462000	0.514037	0.237485	0.970298
2208.8	0.461020	0.514165	0.237040	0.968483
2208.9	0.460040	0.514294	0.236596	0.966666
2209.0	0.459070	0.514422	0.236156	0.964868
2209.1	0.458110	0.514591	0.235739	0.963167
2209.2	0.457160	0.515254	0.235554	0.962407
2209.3	0.456220	0.515460	0.235163	0.960813
2209.4	0.455270	0.515630	0.234751	0.959128
2209.5	0.454320	0.515799	0.234338	0.957441
2209.6	0.453370	0.515969	0.233925	0.955753
2209.7	0.452400	0.516138	0.233501	0.954021
2209.8	0.451420	0.516308	0.233072	0.952267
2209.9	0.450420	0.516477	0.232632	0.950469
2210.0	0.449400	0.516647	0.232181	0.948629
2210.1	0.448350	0.516657	0.231643	0.946430
2210.2	0.447280	0.516666	0.231094	0.944189
2210.3	0.446190	0.516676	0.230536	0.941905
2210.4	0.445080	0.516685	0.229966	0.939579
2210.5	0.443950	0.516206	0.229170	0.936324
2210.6	0.442810	0.516173	0.228567	0.933861
2210.7	0.441650	0.516183	0.227972	0.931432
2210.8	0.440480	0.516192	0.227372	0.928981
2210.9	0.439300	0.516202	0.226767	0.926510
2211.0	0.438110	0.516211	0.226157	0.924017
2211.1	0.436920	0.516278	0.225572	0.921626
2211.2	0.435720	0.516344	0.224981	0.919212
2211.3	0.434510	0.516410	0.224385	0.916777
2211.4	0.433300	0.516476	0.223789	0.914341
2211.5	0.432070	0.516542	0.223182	0.911862
2211.6	0.430840	0.516608	0.222575	0.909382
2211.7	0.429600	0.516674	0.221963	0.906881
2211.8	0.428350	0.516740	0.221346	0.904358
2211.9	0.427090	0.516807	0.220723	0.901814
2212.0	0.425810	0.517424	0.220324	0.900184
2212.1	0.424530	0.517554	0.219717	0.897704
2212.2	0.423220	0.517683	0.219094	0.895158
2212.3	0.421900	0.517813	0.218465	0.892590
2212.4	0.420540	0.517955	0.217821	0.889957

2212.5	0.419160	0.518196	0.217207	0.887449
2212.6	0.417740	0.518437	0.216572	0.884854
2212.7	0.416280	0.518679	0.215915	0.882172
2212.8	0.414770	0.519472	0.215462	0.880317
2212.9	0.413210	0.519690	0.214741	0.877374
2213.0	0.411590	0.519821	0.213953	0.874153
2213.1	0.409910	0.519909	0.213116	0.870733
2213.2	0.408170	0.519997	0.212247	0.867184
2213.3	0.406370	0.520085	0.211347	0.863506
2213.4	0.404510	0.519620	0.210192	0.858785
2213.5	0.402580	0.519708	0.209224	0.854832
2213.6	0.400600	0.520350	0.208452	0.851679
2213.7	0.398560	0.520439	0.207426	0.847486
2213.8	0.396450	0.520527	0.206363	0.843142
2213.9	0.394290	0.520615	0.205273	0.838691
2214.0	0.392070	0.520703	0.204152	0.834110
2214.1	0.389780	0.520917	0.203043	0.829578
2214.2	0.387440	0.521131	0.201907	0.824937
2214.3	0.385040	0.521345	0.200739	0.820164
2214.4	0.382580	0.521559	0.199538	0.815258
2214.5	0.380070	0.521773	0.198310	0.810241
2214.6	0.377490	0.521987	0.197045	0.805071
2214.7	0.374860	0.522201	0.195752	0.799790
2214.8	0.372180	0.522415	0.194432	0.794397
2214.9	0.369440	0.522629	0.193080	0.788872
2215.0	0.366640	0.522843	0.191695	0.783214
2215.1	0.363790	0.523023	0.190271	0.777393
2215.2	0.360880	0.523203	0.188813	0.771440
2215.3	0.357900	0.523383	0.187319	0.765333
2215.4	0.354860	0.523563	0.185791	0.759093
2215.5	0.351760	0.523742	0.184232	0.752720
2215.6	0.348580	0.523922	0.182629	0.746171
2215.7	0.345320	0.524660	0.181176	0.740234
2215.8	0.341990	0.524840	0.179490	0.733348
2215.9	0.338570	0.525020	0.177756	0.726263
2216.0	0.335070	0.525201	0.175979	0.719002
2216.1	0.331480	0.524977	0.174019	0.710995
2216.2	0.327800	0.524753	0.172014	0.702803
2216.3	0.324050	0.524530	0.169974	0.694467
2216.4	0.320240	0.524306	0.167904	0.686009
2216.5	0.316360	0.524083	0.165799	0.677408
2216.6	0.312420	0.523859	0.163664	0.668686
2216.7	0.308440	0.523635	0.161510	0.659885

2216.8	0.304410	0.523411	0.159332	0.650985
2216.9	0.300350	0.523187	0.157139	0.642027
2217.0	0.296270	0.522962	0.154938	0.633035
2217.1	0.292160	0.522779	0.152735	0.624034
2217.2	0.288030	0.522596	0.150523	0.614997
2217.3	0.283870	0.522412	0.148297	0.605902
2217.4	0.279700	0.522229	0.146067	0.596791
2217.5	0.275510	0.522045	0.143829	0.587644
2217.6	0.271290	0.521861	0.141576	0.578439
2217.7	0.267050	0.521677	0.139314	0.569198
2217.8	0.262790	0.521493	0.137043	0.559921
2217.9	0.258500	0.521309	0.134758	0.550586
2218.0	0.254190	0.521125	0.132465	0.541214
2218.1	0.249860	0.521326	0.130258	0.532200
2218.2	0.245510	0.521527	0.128040	0.523137
2218.3	0.241130	0.521728	0.125804	0.514002
2218.4	0.236730	0.521930	0.123556	0.504818
2218.5	0.232310	0.522131	0.121296	0.495584
2218.6	0.227870	0.522333	0.119024	0.486299
2218.7	0.223410	0.522534	0.116739	0.476965
2218.8	0.218930	0.522736	0.114443	0.467581
2218.9	0.214430	0.523493	0.112253	0.458633
2219.0	0.209910	0.523695	0.109929	0.449139
2219.1	0.205380	0.523910	0.107601	0.439627
2219.2	0.200830	0.524124	0.105260	0.430063
2219.3	0.196280	0.524339	0.102917	0.420492
2219.4	0.191730	0.524554	0.100573	0.410912
2219.5	0.187170	0.524768	0.098221	0.401304
2219.6	0.182630	0.524983	0.095878	0.391730
2219.7	0.178100	0.525198	0.093538	0.382170
2219.8	0.173590	0.525413	0.091206	0.372644
2219.9	0.169100	0.525628	0.088884	0.363154
2220.0	0.164630	0.525843	0.086570	0.353699
2220.1	0.160210	0.526146	0.084294	0.344402
2220.2	0.155820	0.526450	0.082031	0.335158
2220.3	0.151480	0.526754	0.079793	0.326011
2220.4	0.147200	0.527057	0.077583	0.316982
2220.5	0.142980	0.527361	0.075402	0.308072
2220.6	0.138830	0.527665	0.073256	0.299303
2220.7	0.134770	0.527970	0.071154	0.290718
2220.8	0.130790	0.528835	0.069166	0.282595
2220.9	0.126900	0.529140	0.067148	0.274348
2221.0	0.123110	0.529445	0.065180	0.266308

2221.1	0.119440	0.529705	0.063268	0.258496
2221.2	0.115870	0.529965	0.061407	0.250892
2221.3	0.112400	0.530225	0.059597	0.243498
2221.4	0.109020	0.530485	0.057833	0.236292
2221.5	0.105740	0.530745	0.056121	0.229295
2221.6	0.102550	0.531005	0.054455	0.222487
2221.7	0.099449	0.531266	0.052834	0.215865
2221.8	0.096425	0.531526	0.051252	0.209403
2221.9	0.093478	0.531787	0.049710	0.203103
2222.0	0.090605	0.532048	0.048206	0.196957
2222.1	0.087801	0.531950	0.046706	0.190827
2222.2	0.085066	0.531853	0.045243	0.184849
2222.3	0.082400	0.531755	0.043817	0.179023
2222.4	0.079803	0.531657	0.042428	0.173348
2222.5	0.077274	0.531559	0.041076	0.167824
2222.6	0.074813	0.532026	0.039802	0.162622
2222.7	0.072421	0.531928	0.038523	0.157393
2222.8	0.070096	0.531830	0.037279	0.152312
2222.9	0.067840	0.531732	0.036073	0.147383
2223.0	0.065652	0.531634	0.034903	0.142603
2223.1	0.063531	0.531518	0.033768	0.137966
2223.2	0.061475	0.531402	0.032668	0.133472
2223.3	0.059481	0.531286	0.031601	0.129115
2223.4	0.057546	0.531170	0.030567	0.124887
2223.5	0.055667	0.531054	0.029562	0.120783
2223.6	0.053842	0.530937	0.028587	0.116798
2223.7	0.052067	0.530821	0.027638	0.112922
2223.8	0.050340	0.530705	0.026716	0.109153
2223.9	0.048658	0.530589	0.025817	0.105483
2224.0	0.047017	0.530473	0.024941	0.101903
2224.1	0.045416	0.530543	0.024095	0.098446
2224.2	0.043855	0.530613	0.023270	0.095075
2224.3	0.042335	0.530683	0.022466	0.091792
2224.4	0.040856	0.530753	0.021684	0.088597
2224.5	0.039420	0.530823	0.020925	0.085494
2224.6	0.038027	0.530893	0.020188	0.082484
2224.7	0.036678	0.531526	0.019495	0.079652
2224.8	0.035374	0.531596	0.018805	0.076831
2224.9	0.034116	0.531666	0.018138	0.074108
2225.0	0.032905	0.531736	0.017497	0.071487
2225.1	0.031741	0.531801	0.016880	0.068967
2225.2	0.030623	0.531867	0.016287	0.066546
2225.3	0.029550	0.531933	0.015719	0.064222

2225.4	0.028519	0.531999	0.015172	0.061989
2225.5	0.027529	0.532064	0.014647	0.059844
2225.6	0.026579	0.532130	0.014143	0.057786
2225.7	0.025666	0.532196	0.013659	0.055808
2225.8	0.024790	0.532261	0.013195	0.053910
2225.9	0.023948	0.532327	0.012748	0.052086
2226.0	0.023139	0.532393	0.012319	0.050332
2226.1	0.022361	0.532536	0.011908	0.048653
2226.2	0.021614	0.532680	0.011513	0.047040
2226.3	0.020895	0.532824	0.011133	0.045488
2226.4	0.020204	0.532967	0.010768	0.043995
2226.5	0.019540	0.533111	0.010417	0.042561
2226.6	0.018901	0.533255	0.010079	0.041180
2226.7	0.018286	0.533399	0.009754	0.039851
2226.8	0.017694	0.533543	0.009441	0.038571
2226.9	0.017124	0.533686	0.009139	0.037339
2227.0	0.016574	0.533830	0.008848	0.036149
2227.1	0.016044	0.533967	0.008567	0.035002
2227.2	0.015531	0.534104	0.008295	0.033892
2227.3	0.015033	0.534241	0.008031	0.032813
2227.4	0.014548	0.534378	0.007774	0.031763
2227.5	0.014075	0.534515	0.007523	0.030738
2227.6	0.013610	0.534086	0.007269	0.029699
2227.7	0.013153	0.534223	0.007027	0.028709
2227.8	0.012700	0.534360	0.006786	0.027727
2227.9	0.012250	0.534496	0.006548	0.026752
2228.0	0.011801	0.534633	0.006309	0.025778
2228.1	0.011352	0.534508	0.006068	0.024791
2228.2	0.010906	0.534384	0.005828	0.023812
2228.3	0.010468	0.534259	0.005593	0.022850
2228.4	0.010043	0.534134	0.005364	0.021917
2228.5	0.009636	0.534008	0.005146	0.021024
2228.6	0.009251	0.533883	0.004939	0.020180
2228.7	0.008894	0.533758	0.004747	0.019396
2228.8	0.008569	0.533633	0.004572	0.018682
2228.9	0.008280	0.533508	0.004417	0.018048
2229.0	0.008033	0.533382	0.004285	0.017506
2229.1	0.007830	0.533250	0.004176	0.017060
2229.2	0.007667	0.533118	0.004088	0.016701
2229.3	0.007537	0.532985	0.004017	0.016413
2229.4	0.007433	0.532853	0.003961	0.016182
2229.5	0.007348	0.532720	0.003914	0.015993
2229.6	0.007275	0.532588	0.003875	0.015830

2229.7	0.007208	0.532455	0.003838	0.015681
2229.8	0.007140	0.532323	0.003801	0.015529
2229.9	0.007064	0.532190	0.003759	0.015359
2230.0	0.006973	0.532058	0.003710	0.015158
2230.1	0.006862	0.532213	0.003652	0.014922
2230.2	0.006733	0.532368	0.003584	0.014645
2230.3	0.006588	0.532523	0.003508	0.014333
2230.4	0.006430	0.532678	0.003425	0.013993
2230.5	0.006261	0.532832	0.003336	0.013630
2230.6	0.006085	0.532987	0.003243	0.013251
2230.7	0.005904	0.533142	0.003148	0.012861
2230.8	0.005722	0.533298	0.003051	0.012467
2230.9	0.005540	0.533453	0.002955	0.012075
2231.0	0.005362	0.533608	0.002861	0.011690
2231.1	0.005190	0.533749	0.002770	0.011319
2231.2	0.005026	0.533889	0.002683	0.010964
2231.3	0.004870	0.534030	0.002601	0.010627
2231.4	0.004725	0.534171	0.002524	0.010311
2231.5	0.004589	0.534312	0.002452	0.010019
2231.6	0.004466	0.533886	0.002384	0.009742
2231.7	0.004356	0.534026	0.002326	0.009504
2231.8	0.004259	0.534167	0.002275	0.009295
2231.9	0.004178	0.534308	0.002232	0.009120
2232.0	0.004112	0.534448	0.002198	0.008979
2232.1	0.004063	0.535127	0.002174	0.008882
2232.2	0.004026	0.535239	0.002155	0.008804
2232.3	0.003998	0.535350	0.002140	0.008744
2232.4	0.003973	0.534895	0.002125	0.008683
2232.5	0.003948	0.535006	0.002112	0.008630
2232.6	0.003918	0.535117	0.002097	0.008566
2232.7	0.003879	0.535229	0.002076	0.008482
2232.8	0.003826	0.535341	0.002048	0.008368
2232.9	0.003755	0.535452	0.002010	0.008214
2233.0	0.003661	0.535564	0.001961	0.008011
2233.1	0.003542	0.535674	0.001897	0.007751
2233.2	0.003398	0.535785	0.001821	0.007439
2233.3	0.003233	0.535895	0.001733	0.007079
2233.4	0.003049	0.536005	0.001634	0.006677
2233.5	0.002849	0.536115	0.001527	0.006241
2233.6	0.002636	0.536226	0.001413	0.005775
2233.7	0.002412	0.536336	0.001294	0.005285
2233.8	0.002180	0.536446	0.001169	0.004778
2233.9	0.001943	0.536557	0.001042	0.004259

2234.0	0.001703	0.536667	0.000914	0.003734
2234.1	0.001464	0.536584	0.000785	0.003209
2234.2	0.001229	0.536502	0.000659	0.002693
2234.3	0.001002	0.536419	0.000538	0.002196
2234.4	0.000788	0.536336	0.000423	0.001727
2234.5	0.000591	0.536253	0.000317	0.001295
2234.6	0.000415	0.536170	0.000222	0.000908
2234.7	0.000263	0.536087	0.000141	0.000576
2234.8	0.000141	0.536004	0.000075	0.000308
2234.9	0.000052	0.535922	0.000028	0.000113
2235.0	0.000000	0.535839	0.000000	0.000000
Channel 15				
Wavenumber	HIRS Filter Transmittance	Optical Element Transmittance	Product of the HIRS Filter and Optical Element Transmittances	Normalized Value of Column 4
2201.1	0.000196	0.502480	0.000099	0.000293
2201.2	0.000381	0.502613	0.000191	0.000568
2201.3	0.000553	0.502745	0.000278	0.000826
2201.4	0.000714	0.502878	0.000359	0.001067
2201.5	0.000863	0.503010	0.000434	0.001290
2201.6	0.001000	0.503143	0.000503	0.001495
2201.7	0.001125	0.503275	0.000566	0.001683
2201.8	0.001239	0.503407	0.000624	0.001853
2201.9	0.001340	0.503540	0.000675	0.002005
2202.0	0.001430	0.503672	0.000720	0.002140
2202.1	0.001508	0.503907	0.000760	0.002258
2202.2	0.001574	0.504142	0.000794	0.002358
2202.3	0.001670	0.504377	0.000842	0.002503
2202.4	0.001766	0.505152	0.000892	0.002650
2202.5	0.001862	0.505387	0.000941	0.002795
2202.6	0.001957	0.505622	0.000990	0.002940
2202.7	0.002053	0.505857	0.001039	0.003086
2202.8	0.002149	0.506092	0.001088	0.003231
2202.9	0.002245	0.506328	0.001137	0.003377
2203.0	0.002340	0.506563	0.001186	0.003522
2203.1	0.002436	0.506827	0.001235	0.003668
2203.2	0.002532	0.507092	0.001284	0.003814
2203.3	0.002628	0.507356	0.001333	0.003961
2203.4	0.002723	0.507620	0.001382	0.004107
2203.5	0.002819	0.507885	0.001432	0.004254
2203.6	0.002915	0.508149	0.001481	0.004401
2203.7	0.003011	0.508414	0.001531	0.004547

2203.8	0.003106	0.508678	0.001580	0.004695
2203.9	0.003202	0.508943	0.001630	0.004842
2204.0	0.003298	0.509208	0.001679	0.004989
2204.1	0.003394	0.509299	0.001728	0.005135
2204.2	0.003489	0.509390	0.001777	0.005281
2204.3	0.003585	0.510026	0.001828	0.005432
2204.4	0.003681	0.510117	0.001878	0.005579
2204.5	0.003777	0.510207	0.001927	0.005725
2204.6	0.003872	0.510298	0.001976	0.005871
2204.7	0.003968	0.510389	0.002025	0.006017
2204.8	0.004064	0.510480	0.002074	0.006163
2204.9	0.004160	0.510571	0.002124	0.006310
2205.0	0.004255	0.510661	0.002173	0.006456
2205.1	0.004351	0.510698	0.002222	0.006602
2205.2	0.004447	0.510735	0.002271	0.006747
2205.3	0.004543	0.510771	0.002320	0.006893
2205.4	0.004638	0.510808	0.002369	0.007039
2205.5	0.004734	0.510845	0.002418	0.007185
2205.6	0.004830	0.510881	0.002467	0.007331
2205.7	0.004926	0.510918	0.002517	0.007477
2205.8	0.005021	0.510955	0.002566	0.007622
2205.9	0.005117	0.510991	0.002615	0.007768
2206.0	0.005213	0.511028	0.002664	0.007914
2206.1	0.005308	0.511112	0.002713	0.008061
2206.2	0.005404	0.511196	0.002763	0.008208
2206.3	0.005500	0.511281	0.002812	0.008354
2206.4	0.005596	0.511365	0.002861	0.008501
2206.5	0.005692	0.511450	0.002911	0.008648
2206.6	0.005787	0.511534	0.002960	0.008795
2206.7	0.005883	0.511619	0.003010	0.008942
2206.8	0.005979	0.512250	0.003063	0.009099
2206.9	0.006075	0.512335	0.003112	0.009246
2207.0	0.006170	0.512419	0.003162	0.009393
2207.1	0.006266	0.512436	0.003211	0.009540
2207.2	0.006362	0.512453	0.003260	0.009686
2207.3	0.006457	0.512470	0.003309	0.009832
2207.4	0.006553	0.512488	0.003358	0.009978
2207.5	0.006649	0.512505	0.003408	0.010124
2207.6	0.006745	0.512522	0.003457	0.010270
2207.7	0.006840	0.512539	0.003506	0.010416
2207.8	0.006936	0.512556	0.003555	0.010562
2207.9	0.007032	0.512573	0.003604	0.010708
2208.0	0.007128	0.512590	0.003654	0.010855

2208.1	0.007223	0.512718	0.003704	0.011003
2208.2	0.007319	0.512847	0.003754	0.011152
2208.3	0.007415	0.512975	0.003804	0.011301
2208.4	0.007511	0.513103	0.003854	0.011449
2208.5	0.007606	0.513232	0.003904	0.011598
2208.6	0.007702	0.513360	0.003954	0.011747
2208.7	0.007798	0.514037	0.004008	0.011909
2208.8	0.007894	0.514165	0.004059	0.012058
2208.9	0.007989	0.514294	0.004109	0.012207
2209.0	0.008085	0.514422	0.004159	0.012357
2209.1	0.008181	0.514591	0.004210	0.012507
2209.2	0.008277	0.515254	0.004265	0.012670
2209.3	0.008372	0.515460	0.004316	0.012821
2209.4	0.008468	0.515630	0.004366	0.012972
2209.5	0.008564	0.515799	0.004417	0.013123
2209.6	0.008660	0.515969	0.004468	0.013275
2209.7	0.008755	0.516138	0.004519	0.013426
2209.8	0.008851	0.516308	0.004570	0.013577
2209.9	0.008947	0.516477	0.004621	0.013728
2210.0	0.009043	0.516647	0.004672	0.013880
2210.1	0.009138	0.516657	0.004721	0.014027
2210.2	0.009234	0.516666	0.004771	0.014174
2210.3	0.009330	0.516676	0.004820	0.014321
2210.4	0.009425	0.516685	0.004870	0.014469
2210.5	0.009521	0.516206	0.004915	0.014602
2210.6	0.009617	0.516173	0.004964	0.014748
2210.7	0.009713	0.516183	0.005014	0.014895
2210.8	0.009808	0.516192	0.005063	0.015042
2210.9	0.009904	0.516202	0.005113	0.015189
2211.0	0.010000	0.516211	0.005162	0.015336
2211.1	0.010800	0.516278	0.005576	0.016565
2211.2	0.011600	0.516344	0.005990	0.017795
2211.3	0.012300	0.516410	0.006352	0.018871
2211.4	0.013100	0.516476	0.006766	0.020101
2211.5	0.013800	0.516542	0.007128	0.021178
2211.6	0.014400	0.516608	0.007439	0.022101
2211.7	0.014900	0.516674	0.007698	0.022872
2211.8	0.015400	0.516740	0.007958	0.023642
2211.9	0.015800	0.516807	0.008166	0.024260
2212.0	0.016000	0.517424	0.008279	0.024596
2212.1	0.016200	0.517554	0.008384	0.024910
2212.2	0.016300	0.517683	0.008438	0.025070
2212.3	0.016300	0.517813	0.008440	0.025076

2212.4	0.016300	0.517955	0.008443	0.025083
2212.5	0.016200	0.518196	0.008395	0.024941
2212.6	0.016200	0.518437	0.008399	0.024952
2212.7	0.016200	0.518679	0.008403	0.024964
2212.8	0.016234	0.519472	0.008433	0.025055
2212.9	0.016400	0.519690	0.008523	0.025321
2213.0	0.016600	0.519821	0.008629	0.025637
2213.1	0.016900	0.519909	0.008786	0.026104
2213.2	0.017400	0.519997	0.009048	0.026881
2213.3	0.018000	0.520085	0.009362	0.027813
2213.4	0.018700	0.519620	0.009717	0.028869
2213.5	0.019500	0.519708	0.010134	0.030109
2213.6	0.020400	0.520350	0.010615	0.031537
2213.7	0.021400	0.520439	0.011137	0.033089
2213.8	0.022400	0.520527	0.011660	0.034641
2213.9	0.023600	0.520615	0.012287	0.036503
2214.0	0.024757	0.520703	0.012891	0.038299
2214.1	0.026000	0.520917	0.013544	0.040238
2214.2	0.027300	0.521131	0.014227	0.042268
2214.3	0.028600	0.521345	0.014910	0.044298
2214.4	0.030000	0.521559	0.015647	0.046486
2214.5	0.031339	0.521773	0.016352	0.048581
2214.6	0.032700	0.521987	0.017069	0.050711
2214.7	0.034000	0.522201	0.017755	0.052749
2214.8	0.035400	0.522415	0.018493	0.054943
2214.9	0.036700	0.522629	0.019180	0.056984
2215.0	0.037952	0.522843	0.019843	0.058953
2215.1	0.039200	0.523023	0.020503	0.060912
2215.2	0.040400	0.523203	0.021137	0.062798
2215.3	0.041600	0.523383	0.021773	0.064686
2215.4	0.042800	0.523563	0.022408	0.066575
2215.5	0.043900	0.523742	0.022992	0.068309
2215.6	0.045100	0.523922	0.023629	0.070201
2215.7	0.046300	0.524660	0.024292	0.072170
2215.8	0.047446	0.524840	0.024902	0.073982
2215.9	0.048700	0.525020	0.025568	0.075963
2216.0	0.049900	0.525201	0.026208	0.077862
2216.1	0.051300	0.524977	0.026931	0.080012
2216.2	0.052700	0.524753	0.027655	0.082161
2216.3	0.054300	0.524530	0.028482	0.084619
2216.4	0.055900	0.524306	0.029309	0.087075
2216.5	0.057700	0.524083	0.030240	0.089841
2216.6	0.059600	0.523859	0.031222	0.092759

2216.7	0.061600	0.523635	0.032256	0.095831
2216.8	0.063800	0.523411	0.033394	0.099211
2216.9	0.066000	0.523187	0.034530	0.102588
2217.0	0.068265	0.522962	0.035700	0.106064
2217.1	0.070600	0.522779	0.036908	0.109653
2217.2	0.073000	0.522596	0.038149	0.113341
2217.3	0.075300	0.522412	0.039338	0.116871
2217.4	0.077700	0.522229	0.040577	0.120553
2217.5	0.080100	0.522045	0.041816	0.124233
2217.6	0.082500	0.521861	0.043054	0.127910
2217.7	0.084900	0.521677	0.044290	0.131585
2217.8	0.087200	0.521493	0.045474	0.135102
2217.9	0.089600	0.521309	0.046709	0.138772
2218.0	0.091900	0.521125	0.047891	0.142283
2218.1	0.094300	0.521326	0.049161	0.146056
2218.2	0.096700	0.521527	0.050432	0.149831
2218.3	0.099000	0.521728	0.051651	0.153453
2218.4	0.101424	0.521930	0.052936	0.157272
2218.5	0.103878	0.522131	0.054238	0.161139
2218.6	0.106400	0.522333	0.055576	0.165115
2218.7	0.109005	0.522534	0.056959	0.169223
2218.8	0.111701	0.522736	0.058390	0.173475
2218.9	0.114495	0.523493	0.059937	0.178072
2219.0	0.117393	0.523695	0.061478	0.182649
2219.1	0.120400	0.523910	0.063079	0.187405
2219.2	0.123522	0.524124	0.064741	0.192343
2219.3	0.126756	0.524339	0.066463	0.197460
2219.4	0.130100	0.524554	0.068244	0.202751
2219.5	0.133549	0.524768	0.070082	0.208212
2219.6	0.137100	0.524983	0.071975	0.213836
2219.7	0.140748	0.525198	0.073920	0.219614
2219.8	0.144477	0.525413	0.075910	0.225527
2219.9	0.148274	0.525628	0.077937	0.231547
2220.0	0.152120	0.525843	0.079991	0.237650
2220.1	0.156000	0.526146	0.082079	0.243853
2220.2	0.159896	0.526450	0.084177	0.250088
2220.3	0.163782	0.526754	0.086273	0.256314
2220.4	0.167630	0.527057	0.088351	0.262487
2220.5	0.171412	0.527361	0.090396	0.268564
2220.6	0.175100	0.527665	0.092394	0.274500
2220.7	0.178673	0.527970	0.094334	0.280263
2220.8	0.182142	0.528835	0.096323	0.286173
2220.9	0.185525	0.529140	0.098169	0.291655

2221.0	0.188838	0.529445	0.099979	0.297035
2221.1	0.192100	0.529705	0.101756	0.302314
2221.2	0.195329	0.529965	0.103518	0.307547
2221.3	0.198550	0.530225	0.105276	0.312771
2221.4	0.201785	0.530485	0.107044	0.318024
2221.5	0.205061	0.530745	0.108835	0.323344
2221.6	0.208400	0.531005	0.110661	0.328771
2221.7	0.211825	0.531266	0.112535	0.334338
2221.8	0.215342	0.531526	0.114460	0.340057
2221.9	0.218958	0.531787	0.116439	0.345935
2222.0	0.222675	0.532048	0.118474	0.351982
2222.1	0.226500	0.531950	0.120487	0.357962
2222.2	0.230432	0.531853	0.122556	0.364109
2222.3	0.234457	0.531755	0.124674	0.370401
2222.4	0.238556	0.531657	0.126830	0.376807
2222.5	0.242710	0.531559	0.129015	0.383298
2222.6	0.246900	0.532026	0.131357	0.390257
2222.7	0.251109	0.531928	0.133572	0.396837
2222.8	0.255325	0.531830	0.135789	0.403425
2222.9	0.259536	0.531732	0.138004	0.410003
2223.0	0.263731	0.531634	0.140208	0.416554
2223.1	0.267900	0.531518	0.142394	0.423046
2223.2	0.272033	0.531402	0.144559	0.429478
2223.3	0.276128	0.531286	0.146703	0.435849
2223.4	0.280187	0.531170	0.148827	0.442160
2223.5	0.284211	0.531054	0.150931	0.448411
2223.6	0.288200	0.530937	0.153016	0.454605
2223.7	0.292154	0.530821	0.155081	0.460741
2223.8	0.296067	0.530705	0.157124	0.466811
2223.9	0.299934	0.530589	0.159141	0.472803
2224.0	0.303747	0.530473	0.161129	0.478709
2224.1	0.307500	0.530543	0.163142	0.484689
2224.2	0.311193	0.530613	0.165123	0.490574
2224.3	0.314850	0.530683	0.167085	0.496405
2224.4	0.318500	0.530753	0.169045	0.502226
2224.5	0.322174	0.530823	0.171017	0.508085
2224.6	0.325900	0.530893	0.173018	0.514030
2224.7	0.329706	0.531526	0.175247	0.520653
2224.8	0.333607	0.531596	0.177344	0.526883
2224.9	0.337615	0.531666	0.179498	0.533283
2225.0	0.341742	0.531736	0.181717	0.539873
2225.1	0.346000	0.531801	0.184003	0.546667
2225.2	0.350395	0.531867	0.186363	0.553679

2225.3	0.354907	0.531933	0.188787	0.560878
2225.4	0.359512	0.531999	0.191260	0.568226
2225.5	0.364185	0.532064	0.193770	0.575683
2225.6	0.368900	0.532130	0.196303	0.583208
2225.7	0.373632	0.532196	0.198845	0.590762
2225.8	0.378355	0.532261	0.201384	0.598303
2225.9	0.383042	0.532327	0.203903	0.605790
2226.0	0.387666	0.532393	0.206390	0.613178
2226.1	0.392200	0.532536	0.208861	0.620518
2226.2	0.396623	0.532680	0.211273	0.627685
2226.3	0.400932	0.532824	0.213626	0.634676
2226.4	0.405130	0.532967	0.215921	0.641494
2226.5	0.409218	0.533111	0.218159	0.648142
2226.6	0.413200	0.533255	0.220341	0.654625
2226.7	0.417082	0.533399	0.222471	0.660953
2226.8	0.420891	0.533543	0.224563	0.667169
2226.9	0.424659	0.533686	0.226635	0.673323
2227.0	0.428418	0.533830	0.228703	0.679467
2227.1	0.432200	0.533967	0.230781	0.685641
2227.2	0.436033	0.534104	0.232887	0.691899
2227.3	0.439930	0.534241	0.235029	0.698262
2227.4	0.443901	0.534378	0.237211	0.704745
2227.5	0.447954	0.534515	0.239438	0.711362
2227.6	0.452100	0.534086	0.241460	0.717369
2227.7	0.456341	0.534223	0.243788	0.724284
2227.8	0.460652	0.534360	0.246154	0.731314
2227.9	0.465003	0.534496	0.248542	0.738410
2228.0	0.469363	0.534633	0.250937	0.745524
2228.1	0.473700	0.534508	0.253197	0.752238
2228.2	0.477988	0.534384	0.255429	0.758870
2228.3	0.482218	0.534259	0.257629	0.765407
2228.4	0.486384	0.534134	0.259794	0.771837
2228.5	0.490479	0.534008	0.261920	0.778155
2228.6	0.494500	0.533883	0.264005	0.784349
2228.7	0.498443	0.533758	0.266048	0.790418
2228.8	0.502314	0.533633	0.268051	0.796370
2228.9	0.506125	0.533508	0.270021	0.802223
2229.0	0.509883	0.533382	0.271963	0.807991
2229.1	0.513600	0.533250	0.273877	0.813679
2229.2	0.517282	0.533118	0.275772	0.819309
2229.3	0.520927	0.532985	0.277647	0.824878
2229.4	0.524532	0.532853	0.279498	0.830379
2229.5	0.528091	0.532720	0.281325	0.835805

2229.6	0.531600	0.532588	0.283124	0.841150
2229.7	0.535056	0.532455	0.284894	0.846408
2229.8	0.538461	0.532323	0.286635	0.851583
2229.9	0.541818	0.532190	0.288351	0.856679
2230.0	0.545130	0.532058	0.290041	0.861700
2230.1	0.548400	0.532213	0.291865	0.867121
2230.2	0.551631	0.532368	0.293671	0.872484
2230.3	0.554830	0.532523	0.295460	0.877799
2230.4	0.558003	0.532678	0.297236	0.883077
2230.5	0.561158	0.532832	0.299003	0.888327
2230.6	0.564300	0.532987	0.300765	0.893561
2230.7	0.567436	0.533142	0.302524	0.898788
2230.8	0.570565	0.533298	0.304281	0.904007
2230.9	0.573686	0.533453	0.306034	0.909217
2231.0	0.576798	0.533608	0.307784	0.914415
2231.1	0.579900	0.533749	0.309521	0.919575
2231.2	0.582988	0.533889	0.311251	0.924715
2231.3	0.586048	0.534030	0.312967	0.929814
2231.4	0.589064	0.534171	0.314661	0.934845
2231.5	0.592020	0.534312	0.316323	0.939784
2231.6	0.594900	0.533886	0.317609	0.943603
2231.7	0.597689	0.534026	0.319181	0.948276
2231.8	0.600374	0.534167	0.320700	0.952787
2231.9	0.602945	0.534308	0.322158	0.957119
2232.0	0.605391	0.534448	0.323550	0.961255
2232.1	0.607700	0.535127	0.325197	0.966148
2232.2	0.609864	0.535239	0.326423	0.969791
2232.3	0.611884	0.535350	0.327572	0.973205
2232.4	0.613761	0.534895	0.328298	0.975360
2232.5	0.615499	0.535006	0.329296	0.978325
2232.6	0.617100	0.535117	0.330221	0.981074
2232.7	0.618567	0.535229	0.331075	0.983611
2232.8	0.619905	0.535341	0.331860	0.985944
2232.9	0.621119	0.535452	0.332580	0.988082
2233.0	0.622216	0.535564	0.333236	0.990032
2233.1	0.623200	0.535674	0.333832	0.991803
2233.2	0.624076	0.535785	0.334370	0.993402
2233.3	0.624845	0.535895	0.334851	0.994831
2233.4	0.625506	0.536005	0.335274	0.996088
2233.5	0.626058	0.536115	0.335639	0.997172
2233.6	0.626500	0.536226	0.335945	0.998081
2233.7	0.626832	0.536336	0.336193	0.998816
2233.8	0.627056	0.536446	0.336382	0.999379

2233.9	0.627174	0.536557	0.336515	0.999772
2234.0	0.627188	0.536667	0.336591	1.000000
2234.1	0.627100	0.536584	0.336492	0.999706
2234.2	0.626912	0.536502	0.336339	0.999252
2234.3	0.626626	0.536419	0.336134	0.998642
2234.4	0.626244	0.536336	0.335878	0.997880
2234.5	0.625768	0.536253	0.335570	0.996967
2234.6	0.625200	0.536170	0.335214	0.995907
2234.7	0.624544	0.536087	0.334810	0.994709
2234.8	0.623817	0.536004	0.334369	0.993397
2234.9	0.623038	0.535922	0.333899	0.992003
2235.0	0.622226	0.535839	0.333413	0.990557
2235.1	0.621400	0.535767	0.332926	0.989110
2235.2	0.620574	0.535696	0.332439	0.987663
2235.3	0.619736	0.535625	0.331946	0.986199
2235.4	0.618873	0.535553	0.331439	0.984693
2235.5	0.617966	0.535482	0.330909	0.983120
2235.6	0.617000	0.535410	0.330348	0.981452
2235.7	0.615963	0.535339	0.329749	0.979672
2235.8	0.614858	0.535267	0.329113	0.977784
2235.9	0.613691	0.535196	0.328445	0.975798
2236.0	0.612470	0.535124	0.327747	0.973725
2236.1	0.611200	0.535032	0.327011	0.971538
2236.2	0.609889	0.534939	0.326253	0.969286
2236.3	0.608539	0.534846	0.325475	0.966973
2236.4	0.607156	0.534753	0.324678	0.964606
2236.5	0.605742	0.534092	0.323522	0.961172
2236.6	0.604300	0.533999	0.322696	0.958717
2236.7	0.602834	0.533907	0.321857	0.956225
2236.8	0.601343	0.533814	0.321005	0.953694
2236.9	0.599824	0.533721	0.320139	0.951120
2237.0	0.598277	0.533628	0.319258	0.948502
2237.1	0.596700	0.533554	0.318372	0.945870
2237.2	0.595092	0.533480	0.317469	0.943190
2237.3	0.593454	0.533406	0.316552	0.940464
2237.4	0.591791	0.533332	0.315621	0.937698
2237.5	0.590105	0.533258	0.314678	0.934897
2237.6	0.588400	0.533183	0.313725	0.932066
2237.7	0.586677	0.533109	0.312763	0.929208
2237.8	0.584937	0.533035	0.311792	0.926322
2237.9	0.583179	0.532960	0.310811	0.923408
2238.0	0.581400	0.532886	0.309820	0.920463
2238.1	0.579600	0.533004	0.308929	0.917816

2238.2	0.577776	0.533121	0.308025	0.915130
2238.3	0.575917	0.533239	0.307101	0.912387
2238.4	0.574010	0.533357	0.306152	0.909566
2238.5	0.572042	0.533474	0.305170	0.906648
2238.6	0.570000	0.533592	0.304148	0.903611
2238.7	0.567871	0.533710	0.303078	0.900434
2238.8	0.565640	0.533828	0.301954	0.897095
2238.9	0.563295	0.533945	0.300769	0.893572
2239.0	0.560819	0.534063	0.299513	0.889841
2239.1	0.558200	0.534154	0.298165	0.885837
2239.2	0.555429	0.534246	0.296735	0.881590
2239.3	0.552521	0.534337	0.295233	0.877126
2239.4	0.549500	0.534429	0.293668	0.872478
2239.5	0.546385	0.534520	0.292054	0.867681
2239.6	0.543200	0.534612	0.290401	0.862771
2239.7	0.539964	0.534703	0.288720	0.857777
2239.8	0.536687	0.534795	0.287017	0.852717
2239.9	0.533378	0.534886	0.285297	0.847606
2240.0	0.530046	0.534978	0.283563	0.842455
2240.1	0.526700	0.534992	0.281780	0.837158
2240.2	0.523344	0.535006	0.279992	0.831846
2240.3	0.519969	0.535020	0.278194	0.826503
2240.4	0.516562	0.535034	0.276378	0.821109
2240.5	0.513110	0.535048	0.274538	0.815643
2240.6	0.509600	0.535062	0.272667	0.810085
2240.7	0.506021	0.535076	0.270760	0.804417
2240.8	0.502372	0.535090	0.268814	0.798636
2240.9	0.498652	0.535104	0.266830	0.792743
2241.0	0.494861	0.535118	0.264809	0.786738
2241.1	0.491000	0.535165	0.262766	0.780668
2241.2	0.487071	0.535212	0.260687	0.774490
2241.3	0.483090	0.535259	0.258578	0.768226
2241.4	0.479072	0.535306	0.256451	0.761905
2241.5	0.475037	0.535354	0.254313	0.755553
2241.6	0.471000	0.535401	0.252174	0.749199
2241.7	0.466976	0.535448	0.250042	0.742865
2241.8	0.462967	0.535496	0.247917	0.736551
2241.9	0.458969	0.535543	0.245798	0.730255
2242.0	0.454981	0.535590	0.243683	0.723974
2242.1	0.451000	0.535789	0.241641	0.717906
2242.2	0.447019	0.535987	0.239597	0.711833
2242.3	0.443012	0.536186	0.237536	0.705712
2242.4	0.438944	0.536384	0.235443	0.699491

2242.5	0.434784	0.536583	0.233298	0.693119
2242.6	0.430500	0.536779	0.231083	0.686540
2242.7	0.426064	0.536974	0.228785	0.679712
2242.8	0.421468	0.537169	0.226400	0.672625
2242.9	0.416710	0.537365	0.223925	0.665274
2243.0	0.411789	0.537560	0.221361	0.657655
2243.1	0.406700	0.537771	0.218711	0.649784
2243.2	0.401447	0.537411	0.215742	0.640961
2243.3	0.396047	0.537621	0.212923	0.632588
2243.4	0.390524	0.537832	0.210037	0.624011
2243.5	0.384901	0.538043	0.207094	0.615267
2243.6	0.379200	0.538255	0.204106	0.606392
2243.7	0.373445	0.538466	0.201087	0.597422
2243.8	0.367661	0.538677	0.198050	0.588400
2243.9	0.361874	0.538888	0.195010	0.579367
2244.0	0.356112	0.539099	0.191980	0.570365
2244.1	0.350400	0.539363	0.188993	0.561491
2244.2	0.344758	0.539627	0.186041	0.552720
2244.3	0.339180	0.539891	0.183120	0.544043
2244.4	0.333652	0.540156	0.180224	0.535439
2244.5	0.328163	0.540420	0.177346	0.526888
2244.6	0.322700	0.540684	0.174479	0.518370
2244.7	0.317248	0.540948	0.171615	0.509862
2244.8	0.311791	0.541213	0.168745	0.501336
2244.9	0.306310	0.541477	0.165860	0.492763
2245.0	0.300786	0.541741	0.162948	0.484112
2245.1	0.295200	0.541951	0.159984	0.475307
2245.2	0.289538	0.542161	0.156976	0.466370
2245.3	0.283796	0.542371	0.153923	0.457299
2245.4	0.277976	0.542581	0.150824	0.448093
2245.5	0.272077	0.542214	0.147524	0.438288
2245.6	0.266100	0.542423	0.144339	0.428825
2245.7	0.260051	0.542633	0.141112	0.419239
2245.8	0.253955	0.542843	0.137858	0.409570
2245.9	0.247844	0.543052	0.134593	0.399869
2246.0	0.241749	0.543262	0.131333	0.390185
2246.1	0.235700	0.543189	0.128030	0.380371
2246.2	0.229724	0.543116	0.124767	0.370678
2246.3	0.223831	0.543043	0.121550	0.361121
2246.4	0.218026	0.542971	0.118382	0.351708
2246.5	0.212314	0.542897	0.115265	0.342447
2246.6	0.206700	0.542824	0.112202	0.333347
2246.7	0.201189	0.542751	0.109196	0.324417

2246.8	0.195788	0.542678	0.106250	0.315665
2246.9	0.190502	0.542605	0.103368	0.307101
2247.0	0.185337	0.542532	0.100552	0.298735
2247.1	0.180300	0.542454	0.097804	0.290573
2247.2	0.175395	0.542376	0.095130	0.282627
2247.3	0.170622	0.542298	0.092528	0.274898
2247.4	0.165982	0.542221	0.089999	0.267384
2247.5	0.161475	0.542143	0.087542	0.260085
2247.6	0.157100	0.542065	0.085158	0.253002
2247.7	0.152855	0.541987	0.082846	0.246131
2247.8	0.148733	0.541909	0.080600	0.239459
2247.9	0.144723	0.541831	0.078415	0.232969
2248.0	0.140815	0.541753	0.076287	0.226646
2248.1	0.137000	0.541758	0.074221	0.220508
2248.2	0.133267	0.541764	0.072199	0.214501
2248.3	0.129604	0.541769	0.070215	0.208607
2248.4	0.125997	0.541774	0.068262	0.202803
2248.5	0.122434	0.541202	0.066261	0.196860
2248.6	0.118900	0.541208	0.064350	0.191180
2248.7	0.115385	0.541213	0.062448	0.185530
2248.8	0.111882	0.541218	0.060553	0.179900
2248.9	0.108387	0.541224	0.058662	0.174281
2249.0	0.104894	0.541229	0.056772	0.168667
2249.1	0.101400	0.541223	0.054880	0.163047
2249.2	0.097900	0.541217	0.052985	0.157417
2249.3	0.094400	0.541211	0.051090	0.151788
2249.4	0.091000	0.541205	0.049250	0.146319
2249.5	0.087600	0.541199	0.047409	0.140851
2249.6	0.084300	0.541194	0.045623	0.135543
2249.7	0.081104	0.541188	0.043892	0.130403
2249.8	0.078000	0.541182	0.042212	0.125411
2249.9	0.075100	0.541176	0.040642	0.120747
2250.0	0.072200	0.541170	0.039072	0.116083
2250.1	0.069500	0.541302	0.037620	0.111769
2250.2	0.066900	0.541434	0.036222	0.107614
2250.3	0.064476	0.541566	0.034918	0.103739
2250.4	0.062100	0.541698	0.033639	0.099941
2250.5	0.059900	0.541830	0.032456	0.096424
2250.6	0.057800	0.541962	0.031325	0.093067
2250.7	0.055800	0.542094	0.030249	0.089868
2250.8	0.053800	0.542226	0.029172	0.086668
2250.9	0.051900	0.542358	0.028148	0.083628
2251.0	0.050100	0.542489	0.027179	0.080747

2251.1	0.048300	0.542600	0.026208	0.077862
2251.2	0.046500	0.542710	0.025236	0.074975
2251.3	0.044800	0.542821	0.024318	0.072249
2251.4	0.043133	0.542931	0.023418	0.069574
2251.5	0.041500	0.543042	0.022536	0.066954
2251.6	0.039800	0.543152	0.021617	0.064225
2251.7	0.038200	0.543262	0.020753	0.061655
2251.8	0.036500	0.543373	0.019833	0.058923
2251.9	0.035000	0.542904	0.019002	0.056453
2252.0	0.033400	0.543014	0.018137	0.053883
2252.1	0.032000	0.542854	0.017371	0.051610
2252.2	0.030600	0.542695	0.016606	0.049337
2252.3	0.029400	0.542536	0.015951	0.047389
2252.4	0.028207	0.542377	0.015299	0.045452
2252.5	0.027100	0.542217	0.014694	0.043656
2252.6	0.026200	0.542058	0.014202	0.042193
2252.7	0.025400	0.541899	0.013764	0.040893
2252.8	0.024600	0.541740	0.013327	0.039593
2252.9	0.024000	0.541581	0.012998	0.038616
2253.0	0.023400	0.541422	0.012669	0.037640
2253.1	0.022900	0.541277	0.012395	0.036826
2253.2	0.022400	0.541133	0.012121	0.036012
2253.3	0.022000	0.540988	0.011902	0.035360
2253.4	0.021500	0.540843	0.011628	0.034547
2253.5	0.021100	0.540698	0.011409	0.033895
2253.6	0.020700	0.540554	0.011189	0.033243
2253.7	0.020300	0.540986	0.010982	0.032627
2253.8	0.019894	0.540841	0.010760	0.031967
2253.9	0.019500	0.540696	0.010544	0.031325
2254.0	0.019100	0.540552	0.010325	0.030674
2254.1	0.018600	0.540502	0.010053	0.029868
2254.2	0.018100	0.540453	0.009782	0.029063
2254.3	0.017602	0.540403	0.009512	0.028260
2254.4	0.017000	0.540354	0.009186	0.027291
2254.5	0.016400	0.540304	0.008861	0.026326
2254.6	0.015800	0.540255	0.008536	0.025360
2254.7	0.015100	0.540206	0.008157	0.024234
2254.8	0.014400	0.540156	0.007778	0.023109
2254.9	0.013700	0.540107	0.007399	0.021984
2255.0	0.013000	0.540057	0.007021	0.020858
2255.1	0.012400	0.540020	0.006696	0.019894
2255.2	0.011900	0.539983	0.006426	0.019091
2255.3	0.011500	0.539946	0.006209	0.018448

2255.4	0.011100	0.539908	0.005993	0.017805
2255.5	0.010800	0.539871	0.005831	0.017323
2255.6	0.010600	0.539834	0.005722	0.017001
2255.7	0.010400	0.539797	0.005614	0.016679
2255.8	0.010200	0.539760	0.005506	0.016357
2255.9	0.010100	0.539722	0.005451	0.016195
2256.0	0.010000	0.539685	0.005397	0.016034
2256.1	0.009890	0.539834	0.005339	0.015862
2256.2	0.009790	0.539982	0.005286	0.015706
2256.3	0.009680	0.540131	0.005228	0.015534
2256.4	0.009590	0.540279	0.005181	0.015393
2256.5	0.009490	0.540428	0.005129	0.015237
2256.6	0.009400	0.540839	0.005084	0.015104
2256.7	0.009310	0.541282	0.005039	0.014972
2256.8	0.009220	0.541431	0.004992	0.014831
2256.9	0.009140	0.541580	0.004950	0.014706
2257.0	0.009060	0.541728	0.004908	0.014582
2257.1	0.008980	0.541855	0.004866	0.014456
2257.2	0.008900	0.541982	0.004824	0.014331
2257.3	0.008830	0.542109	0.004787	0.014221
2257.4	0.008760	0.542235	0.004750	0.014112
2257.5	0.008690	0.542362	0.004713	0.014003
2257.6	0.008620	0.542489	0.004676	0.013893
2257.7	0.008560	0.542615	0.004645	0.013799
2257.8	0.008490	0.542742	0.004608	0.013690
2257.9	0.008430	0.542868	0.004576	0.013596
2258.0	0.008370	0.542995	0.004545	0.013503
2258.1	0.008310	0.542868	0.004511	0.013403
2258.2	0.008250	0.542742	0.004478	0.013303
2258.3	0.008190	0.542615	0.004444	0.013203
2258.4	0.008140	0.542489	0.004416	0.013119
2258.5	0.008080	0.542362	0.004382	0.013020
2258.6	0.008030	0.542236	0.004354	0.012936
2258.7	0.007980	0.542109	0.004326	0.012852
2258.8	0.007920	0.541982	0.004293	0.012753
2258.9	0.007870	0.541856	0.004264	0.012669
2259.0	0.007820	0.541729	0.004236	0.012586
2259.1	0.007770	0.541572	0.004208	0.012502
2259.2	0.007720	0.541416	0.004180	0.012418
2259.3	0.007670	0.541260	0.004151	0.012334
2259.4	0.007620	0.540527	0.004119	0.012237
2259.5	0.007560	0.540370	0.004085	0.012137
2259.6	0.007510	0.540214	0.004057	0.012053

2259.7	0.007460	0.540058	0.004029	0.011970
2259.8	0.007410	0.539902	0.004001	0.011886
2259.9	0.007350	0.539746	0.003967	0.011786
2260.0	0.007300	0.539589	0.003939	0.011703
2260.1	0.007250	0.539630	0.003912	0.011623
2260.2	0.007190	0.539670	0.003880	0.011528
2260.3	0.007130	0.539710	0.003848	0.011433
2260.4	0.007080	0.539750	0.003821	0.011353
2260.5	0.007020	0.539790	0.003789	0.011258
2260.6	0.006960	0.539830	0.003757	0.011163
2260.7	0.006900	0.539870	0.003725	0.011067
2260.8	0.006830	0.539910	0.003688	0.010956
2260.9	0.006770	0.539950	0.003655	0.010860
2261.0	0.006700	0.539990	0.003618	0.010749
2261.1	0.006630	0.540031	0.003580	0.010637
2261.2	0.006560	0.540072	0.003543	0.010526
2261.3	0.006490	0.539537	0.003502	0.010403
2261.4	0.006410	0.539579	0.003459	0.010276
2261.5	0.006330	0.540196	0.003419	0.010159
2261.6	0.006250	0.540237	0.003376	0.010031
2261.7	0.006170	0.540278	0.003334	0.009904
2261.8	0.006080	0.540319	0.003285	0.009760
2261.9	0.006000	0.540360	0.003242	0.009632
2262.0	0.005900	0.540401	0.003188	0.009473
2262.1	0.005810	0.540436	0.003140	0.009329
2262.2	0.005710	0.540472	0.003086	0.009169
2262.3	0.005610	0.540508	0.003032	0.009009
2262.4	0.005510	0.540544	0.002978	0.008849
2262.5	0.005400	0.540580	0.002919	0.008673
2262.6	0.005290	0.540616	0.002860	0.008497
2262.7	0.005170	0.541228	0.002798	0.008313
2262.8	0.005050	0.541264	0.002733	0.008121
2262.9	0.004930	0.541300	0.002669	0.007928
2263.0	0.004800	0.541336	0.002598	0.007720
2263.1	0.004670	0.541972	0.002531	0.007520
2263.2	0.004540	0.542030	0.002461	0.007311
2263.3	0.004400	0.542089	0.002385	0.007086
2263.4	0.004250	0.542149	0.002304	0.006845
2263.5	0.004100	0.542784	0.002225	0.006612
2263.6	0.003950	0.542843	0.002144	0.006370
2263.7	0.003790	0.542902	0.002058	0.006113
2263.8	0.003630	0.542961	0.001971	0.005856
2263.9	0.003460	0.543020	0.001879	0.005582

2264.0	0.003290	0.543078	0.001787	0.005308
2264.1	0.003110	0.543188	0.001689	0.005019
2264.2	0.002920	0.543409	0.001587	0.004714
2264.3	0.002730	0.543295	0.001483	0.004407
2264.4	0.002540	0.543182	0.001380	0.004099
2264.5	0.002330	0.543068	0.001265	0.003759
2264.6	0.002130	0.542954	0.001156	0.003436
2264.7	0.001910	0.542841	0.001037	0.003080
2264.8	0.001700	0.542727	0.000923	0.002741
2264.9	0.001470	0.542613	0.000798	0.002370
2265.0	0.001240	0.542500	0.000673	0.001999
2265.1	0.001000	0.542402	0.000542	0.001611
2265.2	0.000756	0.542304	0.000410	0.001218
2265.3	0.000507	0.542205	0.000275	0.000817
2265.4	0.000254	0.542107	0.000138	0.000409
2265.5	0.000000	0.542009	0.000000	0.000000
Channel 16				
Wavenumber	HIRS Filter Transmittance	Optical Element Transmittance	Product of the HIRS Filter and Optical Element Transmittances	Normalized Value of Column 4
2207.1	0.000131	0.512436	0.000067	0.000203
2207.2	0.000260	0.512453	0.000133	0.000403
2207.3	0.000388	0.512470	0.000199	0.000601
2207.4	0.000514	0.512488	0.000263	0.000795
2207.5	0.000638	0.512505	0.000327	0.000987
2207.6	0.000760	0.512522	0.000390	0.001177
2207.7	0.000881	0.512539	0.000451	0.001364
2207.8	0.001000	0.512556	0.000513	0.001549
2207.9	0.001118	0.512573	0.000573	0.001731
2208.0	0.001234	0.512590	0.000632	0.001910
2208.1	0.001348	0.512718	0.000691	0.002088
2208.2	0.001461	0.512847	0.000749	0.002264
2208.3	0.001572	0.512975	0.000807	0.002437
2208.4	0.001683	0.513103	0.000863	0.002608
2208.5	0.001791	0.513232	0.000919	0.002777
2208.6	0.001898	0.513360	0.000975	0.002944
2208.7	0.002004	0.514037	0.001030	0.003113
2208.8	0.002109	0.514165	0.001084	0.003276
2208.9	0.002212	0.514294	0.001138	0.003437
2209.0	0.002314	0.514422	0.001190	0.003597
2209.1	0.002415	0.514591	0.001243	0.003754
2209.2	0.002514	0.515254	0.001295	0.003914

2209.3	0.002612	0.515460	0.001347	0.004069
2209.4	0.002710	0.515630	0.001397	0.004222
2209.5	0.002806	0.515799	0.001447	0.004373
2209.6	0.002901	0.515969	0.001497	0.004522
2209.7	0.002995	0.516138	0.001546	0.004670
2209.8	0.003087	0.516308	0.001594	0.004816
2209.9	0.003179	0.516477	0.001642	0.004961
2210.0	0.003270	0.516647	0.001689	0.005105
2210.1	0.003360	0.516657	0.001736	0.005245
2210.2	0.003449	0.516666	0.001782	0.005384
2210.3	0.003537	0.516676	0.001827	0.005521
2210.4	0.003624	0.516685	0.001873	0.005658
2210.5	0.003710	0.516206	0.001915	0.005787
2210.6	0.003796	0.516173	0.001959	0.005920
2210.7	0.003881	0.516183	0.002003	0.006052
2210.8	0.003965	0.516192	0.002046	0.006183
2210.9	0.004048	0.516202	0.002090	0.006313
2211.0	0.004130	0.516211	0.002132	0.006442
2211.1	0.004212	0.516278	0.002175	0.006571
2211.2	0.004294	0.516344	0.002217	0.006698
2211.3	0.004374	0.516410	0.002259	0.006825
2211.4	0.004454	0.516476	0.002301	0.006951
2211.5	0.004534	0.516542	0.002342	0.007076
2211.6	0.004613	0.516608	0.002383	0.007200
2211.7	0.004691	0.516674	0.002424	0.007324
2211.8	0.004769	0.516740	0.002465	0.007446
2211.9	0.004847	0.516807	0.002505	0.007568
2212.0	0.004924	0.517424	0.002548	0.007698
2212.1	0.005001	0.517554	0.002588	0.007820
2212.2	0.005077	0.517683	0.002628	0.007942
2212.3	0.005154	0.517813	0.002669	0.008063
2212.4	0.005229	0.517955	0.002709	0.008184
2212.5	0.005305	0.518196	0.002749	0.008306
2212.6	0.005380	0.518437	0.002789	0.008428
2212.7	0.005455	0.518679	0.002830	0.008549
2212.8	0.005530	0.519472	0.002873	0.008680
2212.9	0.005605	0.519690	0.002913	0.008801
2213.0	0.005680	0.519821	0.002952	0.008921
2213.1	0.005754	0.519909	0.002992	0.009039
2213.2	0.005829	0.519997	0.003031	0.009158
2213.3	0.005903	0.520085	0.003070	0.009276
2213.4	0.005978	0.519620	0.003106	0.009385
2213.5	0.006052	0.519708	0.003145	0.009504

2213.6	0.006127	0.520350	0.003188	0.009632
2213.7	0.006201	0.520439	0.003227	0.009751
2213.8	0.006276	0.520527	0.003267	0.009871
2213.9	0.006351	0.520615	0.003306	0.009990
2214.0	0.006426	0.520703	0.003346	0.010110
2214.1	0.006501	0.520917	0.003387	0.010232
2214.2	0.006577	0.521131	0.003427	0.010355
2214.3	0.006652	0.521345	0.003468	0.010479
2214.4	0.006728	0.521559	0.003509	0.010603
2214.5	0.006805	0.521773	0.003550	0.010727
2214.6	0.006881	0.521987	0.003592	0.010853
2214.7	0.006958	0.522201	0.003634	0.010979
2214.8	0.007036	0.522415	0.003676	0.011105
2214.9	0.007113	0.522629	0.003718	0.011233
2215.0	0.007192	0.522843	0.003760	0.011361
2215.1	0.007271	0.523023	0.003803	0.011489
2215.2	0.007350	0.523203	0.003845	0.011619
2215.3	0.007430	0.523383	0.003888	0.011749
2215.4	0.007510	0.523563	0.003932	0.011880
2215.5	0.007591	0.523742	0.003976	0.012012
2215.6	0.007672	0.523922	0.004020	0.012146
2215.7	0.007755	0.524660	0.004069	0.012293
2215.8	0.007838	0.524840	0.004114	0.012429
2215.9	0.007921	0.525020	0.004159	0.012566
2216.0	0.008006	0.525201	0.004205	0.012704
2216.1	0.008091	0.524977	0.004247	0.012833
2216.2	0.008177	0.524753	0.004291	0.012964
2216.3	0.008264	0.524530	0.004335	0.013096
2216.4	0.008351	0.524306	0.004379	0.013230
2216.5	0.008440	0.524083	0.004423	0.013364
2216.6	0.008529	0.523859	0.004468	0.013500
2216.7	0.008620	0.523635	0.004514	0.013637
2216.8	0.008711	0.523411	0.004559	0.013776
2216.9	0.008803	0.523187	0.004606	0.013916
2217.0	0.008897	0.522962	0.004653	0.014058
2217.1	0.008991	0.522779	0.004700	0.014202
2217.2	0.009087	0.522596	0.004749	0.014348
2217.3	0.009183	0.522412	0.004797	0.014495
2217.4	0.009281	0.522229	0.004847	0.014644
2217.5	0.009380	0.522045	0.004897	0.014795
2217.6	0.009480	0.521861	0.004947	0.014948
2217.7	0.009582	0.521677	0.004999	0.015103
2217.8	0.009684	0.521493	0.005050	0.015259

2217.9	0.009788	0.521309	0.005103	0.015417
2218.0	0.009893	0.521125	0.005156	0.015578
2218.1	0.010000	0.521326	0.005213	0.015752
2218.2	0.010108	0.521527	0.005272	0.015928
2218.3	0.010219	0.521728	0.005332	0.016109
2218.4	0.010335	0.521930	0.005394	0.016298
2218.5	0.010457	0.522131	0.005460	0.016497
2218.6	0.010586	0.522333	0.005529	0.016707
2218.7	0.010724	0.522534	0.005604	0.016931
2218.8	0.010873	0.522736	0.005684	0.017173
2218.9	0.011034	0.523493	0.005776	0.017452
2219.0	0.011209	0.523695	0.005870	0.017736
2219.1	0.011400	0.523910	0.005973	0.018046
2219.2	0.011607	0.524124	0.006084	0.018381
2219.3	0.011832	0.524339	0.006204	0.018745
2219.4	0.012078	0.524554	0.006336	0.019142
2219.5	0.012345	0.524768	0.006478	0.019574
2219.6	0.012635	0.524983	0.006633	0.020042
2219.7	0.012950	0.525198	0.006801	0.020550
2219.8	0.013290	0.525413	0.006983	0.021098
2219.9	0.013655	0.525628	0.007177	0.021686
2220.0	0.014043	0.525843	0.007384	0.022312
2220.1	0.014452	0.526146	0.007604	0.022975
2220.2	0.014881	0.526450	0.007834	0.023670
2220.3	0.015327	0.526754	0.008074	0.024394
2220.4	0.015790	0.527057	0.008322	0.025145
2220.5	0.016268	0.527361	0.008579	0.025921
2220.6	0.016758	0.527665	0.008843	0.026717
2220.7	0.017260	0.527970	0.009113	0.027534
2220.8	0.017772	0.528835	0.009398	0.028397
2220.9	0.018294	0.529140	0.009680	0.029248
2221.0	0.018828	0.529445	0.009968	0.030119
2221.1	0.019373	0.529705	0.010262	0.031006
2221.2	0.019930	0.529965	0.010562	0.031913
2221.3	0.020500	0.530225	0.010870	0.032842
2221.4	0.021083	0.530485	0.011184	0.033792
2221.5	0.021680	0.530745	0.011507	0.034766
2221.6	0.022293	0.531005	0.011838	0.035767
2221.7	0.022920	0.531266	0.012177	0.036791
2221.8	0.023563	0.531526	0.012524	0.037841
2221.9	0.024223	0.531787	0.012881	0.038921
2222.0	0.024900	0.532048	0.013248	0.040028
2222.1	0.025594	0.531950	0.013615	0.041136

2222.2	0.026305	0.531853	0.013990	0.042271
2222.3	0.027036	0.531755	0.014377	0.043438
2222.4	0.027785	0.531657	0.014772	0.044633
2222.5	0.028553	0.531559	0.015178	0.045858
2222.6	0.029341	0.532026	0.015610	0.047165
2222.7	0.030150	0.531928	0.016038	0.048457
2222.8	0.030980	0.531830	0.016476	0.049781
2222.9	0.031831	0.531732	0.016926	0.051139
2223.0	0.032707	0.531634	0.017388	0.052537
2223.1	0.033607	0.531518	0.017863	0.053971
2223.2	0.034534	0.531402	0.018351	0.055448
2223.3	0.035488	0.531286	0.018854	0.056967
2223.4	0.036472	0.531170	0.019373	0.058534
2223.5	0.037485	0.531054	0.019907	0.060146
2223.6	0.038531	0.530937	0.020458	0.061811
2223.7	0.039610	0.530821	0.021026	0.063528
2223.8	0.040724	0.530705	0.021612	0.065301
2223.9	0.041873	0.530589	0.022217	0.067128
2224.0	0.043061	0.530473	0.022843	0.069018
2224.1	0.044288	0.530543	0.023497	0.070994
2224.2	0.045556	0.530613	0.024173	0.073036
2224.3	0.046867	0.530683	0.024872	0.075148
2224.4	0.048222	0.530753	0.025594	0.077330
2224.5	0.049623	0.530823	0.026341	0.079588
2224.6	0.051072	0.530893	0.027114	0.081922
2224.7	0.052570	0.531526	0.027942	0.084426
2224.8	0.054119	0.531596	0.028769	0.086925
2224.9	0.055720	0.531666	0.029624	0.089508
2225.0	0.057375	0.531736	0.030508	0.092179
2225.1	0.059085	0.531801	0.031421	0.094938
2225.2	0.060852	0.531867	0.032365	0.097789
2225.3	0.062676	0.531933	0.033339	0.100733
2225.4	0.064560	0.531999	0.034346	0.103774
2225.5	0.066504	0.532064	0.035384	0.106912
2225.6	0.068510	0.532130	0.036456	0.110150
2225.7	0.070580	0.532196	0.037562	0.113492
2225.8	0.072715	0.532261	0.038703	0.116940
2225.9	0.074915	0.532327	0.039879	0.120493
2226.0	0.077184	0.532393	0.041092	0.124157
2226.1	0.079521	0.532536	0.042348	0.127951
2226.2	0.081928	0.532680	0.043641	0.131860
2226.3	0.084406	0.532824	0.044974	0.135884
2226.4	0.086958	0.532967	0.046346	0.140031

2226.5	0.089583	0.533111	0.047758	0.144297
2226.6	0.092283	0.533255	0.049210	0.148686
2226.7	0.095060	0.533399	0.050705	0.153201
2226.8	0.097915	0.533543	0.052242	0.157845
2226.9	0.100850	0.533686	0.053822	0.162620
2227.0	0.103860	0.533830	0.055444	0.167519
2227.1	0.106960	0.533967	0.057113	0.172564
2227.2	0.110130	0.534104	0.058821	0.177723
2227.3	0.113390	0.534241	0.060578	0.183031
2227.4	0.116730	0.534378	0.062378	0.188471
2227.5	0.120150	0.534515	0.064222	0.194043
2227.6	0.123660	0.534086	0.066045	0.199551
2227.7	0.127260	0.534223	0.067985	0.205413
2227.8	0.130940	0.534360	0.069969	0.211407
2227.9	0.134710	0.534496	0.072002	0.217549
2228.0	0.138570	0.534633	0.074084	0.223840
2228.1	0.142510	0.534508	0.076173	0.230151
2228.2	0.146540	0.534384	0.078309	0.236604
2228.3	0.150650	0.534259	0.080486	0.243183
2228.4	0.154850	0.534134	0.082711	0.249905
2228.5	0.159130	0.534008	0.084977	0.256752
2228.6	0.163500	0.533883	0.087290	0.263741
2228.7	0.167950	0.533758	0.089645	0.270855
2228.8	0.172490	0.533633	0.092046	0.278112
2228.9	0.177110	0.533508	0.094490	0.285494
2229.0	0.181800	0.533382	0.096969	0.292985
2229.1	0.186580	0.533250	0.099494	0.300614
2229.2	0.191440	0.533118	0.102060	0.308368
2229.3	0.196370	0.532985	0.104662	0.316230
2229.4	0.201370	0.532853	0.107301	0.324202
2229.5	0.206450	0.532720	0.109980	0.332298
2229.6	0.211600	0.532588	0.112696	0.340502
2229.7	0.216810	0.532455	0.115442	0.348799
2229.8	0.222090	0.532323	0.118224	0.357205
2229.9	0.227430	0.532190	0.121036	0.365702
2230.0	0.232840	0.532058	0.123884	0.374308
2230.1	0.238300	0.532213	0.126826	0.383197
2230.2	0.243810	0.532368	0.129797	0.392172
2230.3	0.249380	0.532523	0.132801	0.401248
2230.4	0.254990	0.532678	0.135827	0.410394
2230.5	0.260650	0.532832	0.138883	0.419625
2230.6	0.266340	0.532987	0.141956	0.428910
2230.7	0.272080	0.533142	0.145057	0.438281

2230.8	0.277850	0.533298	0.148177	0.447706
2230.9	0.283650	0.533453	0.151314	0.457185
2231.0	0.289480	0.533608	0.154469	0.466717
2231.1	0.295330	0.533749	0.157632	0.476275
2231.2	0.301190	0.533889	0.160802	0.485853
2231.3	0.307070	0.534030	0.163985	0.495469
2231.4	0.312960	0.534171	0.167174	0.505105
2231.5	0.318850	0.534312	0.170365	0.514747
2231.6	0.324740	0.533886	0.173374	0.523838
2231.7	0.330620	0.534026	0.176560	0.533464
2231.8	0.336490	0.534167	0.179742	0.543078
2231.9	0.342350	0.534308	0.182920	0.552681
2232.0	0.348190	0.534448	0.186090	0.562257
2232.1	0.354010	0.535127	0.189440	0.572382
2232.2	0.359800	0.535239	0.192579	0.581865
2232.3	0.365560	0.535350	0.195703	0.591303
2232.4	0.371280	0.534895	0.198596	0.600044
2232.5	0.376960	0.535006	0.201676	0.609350
2232.6	0.382600	0.535117	0.204736	0.618596
2232.7	0.388180	0.535229	0.207765	0.627749
2232.8	0.393710	0.535341	0.210769	0.636824
2232.9	0.399180	0.535452	0.213742	0.645807
2233.0	0.404590	0.535564	0.216684	0.654696
2233.1	0.409940	0.535674	0.219594	0.663490
2233.2	0.415220	0.535785	0.222468	0.672174
2233.3	0.420430	0.535895	0.225306	0.680748
2233.4	0.425570	0.536005	0.228108	0.689212
2233.5	0.430630	0.536115	0.230867	0.697551
2233.6	0.435620	0.536226	0.233591	0.705779
2233.7	0.440520	0.536336	0.236267	0.713864
2233.8	0.445340	0.536446	0.238901	0.721824
2233.9	0.450070	0.536557	0.241488	0.729640
2234.0	0.454720	0.536667	0.244033	0.737330
2234.1	0.459270	0.536584	0.246437	0.744594
2234.2	0.463740	0.536502	0.248797	0.751725
2234.3	0.468120	0.536419	0.251108	0.758708
2234.4	0.472400	0.536336	0.253365	0.765526
2234.5	0.476590	0.536253	0.255573	0.772197
2234.6	0.480690	0.536170	0.257732	0.778719
2234.7	0.484690	0.536087	0.259836	0.785078
2234.8	0.488590	0.536004	0.261886	0.791272
2234.9	0.492400	0.535922	0.263888	0.797319
2235.0	0.496110	0.535839	0.265835	0.803203

2235.1	0.499720	0.535767	0.267734	0.808940
2235.2	0.503230	0.535696	0.269578	0.814513
2235.3	0.506640	0.535625	0.271369	0.819923
2235.4	0.509950	0.535553	0.273105	0.825170
2235.5	0.513150	0.535482	0.274783	0.830237
2235.6	0.516260	0.535410	0.276411	0.835158
2235.7	0.519270	0.535339	0.277985	0.839915
2235.8	0.522180	0.535267	0.279506	0.844509
2235.9	0.524980	0.535196	0.280967	0.848924
2236.0	0.527680	0.535124	0.282374	0.853176
2236.1	0.530290	0.535032	0.283722	0.857247
2236.2	0.532790	0.534939	0.285010	0.861139
2236.3	0.535200	0.534846	0.286250	0.864884
2236.4	0.537510	0.534753	0.287435	0.868465
2236.5	0.539730	0.534092	0.288266	0.870976
2236.6	0.541840	0.533999	0.289342	0.874229
2236.7	0.543870	0.533907	0.290376	0.877351
2236.8	0.545800	0.533814	0.291356	0.880312
2236.9	0.547640	0.533721	0.292287	0.883126
2237.0	0.549380	0.533628	0.293165	0.885777
2237.1	0.551040	0.533554	0.294010	0.888331
2237.2	0.552600	0.533480	0.294801	0.890722
2237.3	0.554070	0.533406	0.295544	0.892967
2237.4	0.555440	0.533332	0.296234	0.895051
2237.5	0.556730	0.533258	0.296881	0.897005
2237.6	0.557930	0.533183	0.297479	0.898813
2237.7	0.559030	0.533109	0.298024	0.900460
2237.8	0.560040	0.533035	0.298521	0.901961
2237.9	0.560970	0.532960	0.298975	0.903332
2238.0	0.561810	0.532886	0.299381	0.904559
2238.1	0.562550	0.533004	0.299841	0.905950
2238.2	0.563220	0.533121	0.300265	0.907230
2238.3	0.563790	0.533239	0.300635	0.908348
2238.4	0.564280	0.533357	0.300962	0.909338
2238.5	0.564680	0.533474	0.301242	0.910184
2238.6	0.565000	0.533592	0.301480	0.910901
2238.7	0.565240	0.533710	0.301674	0.911489
2238.8	0.565390	0.533828	0.301821	0.911932
2238.9	0.565470	0.533945	0.301930	0.912262
2239.0	0.565460	0.534063	0.301991	0.912447
2239.1	0.565370	0.534154	0.301995	0.912457
2239.2	0.565200	0.534246	0.301956	0.912339
2239.3	0.564960	0.534337	0.301879	0.912108

2239.4	0.564640	0.534429	0.301760	0.911748
2239.5	0.564240	0.534520	0.301598	0.911258
2239.6	0.563770	0.534612	0.301398	0.910654
2239.7	0.563230	0.534703	0.301161	0.909938
2239.8	0.562620	0.534795	0.300886	0.909108
2239.9	0.561930	0.534886	0.300569	0.908148
2240.0	0.561180	0.534978	0.300219	0.907091
2240.1	0.560360	0.534992	0.299788	0.905790
2240.2	0.559480	0.535006	0.299325	0.904391
2240.3	0.558540	0.535020	0.298830	0.902895
2240.4	0.557540	0.535034	0.298303	0.901302
2240.5	0.556490	0.535048	0.297749	0.899628
2240.6	0.555370	0.535062	0.297157	0.897841
2240.7	0.554210	0.535076	0.296544	0.895989
2240.8	0.553000	0.535090	0.295905	0.894056
2240.9	0.551730	0.535104	0.295233	0.892026
2241.0	0.550420	0.535118	0.294540	0.889932
2241.1	0.549070	0.535165	0.293843	0.887827
2241.2	0.547680	0.535212	0.293125	0.885658
2241.3	0.546250	0.535259	0.292385	0.883423
2241.4	0.544780	0.535306	0.291624	0.881123
2241.5	0.543280	0.535354	0.290847	0.878775
2241.6	0.541740	0.535401	0.290048	0.876361
2241.7	0.540180	0.535448	0.289238	0.873915
2241.8	0.538590	0.535496	0.288413	0.871420
2241.9	0.536980	0.535543	0.287576	0.868891
2242.0	0.535350	0.535590	0.286728	0.866331
2242.1	0.533700	0.535789	0.285950	0.863980
2242.2	0.532030	0.535987	0.285161	0.861596
2242.3	0.530360	0.536186	0.284371	0.859209
2242.4	0.528690	0.536384	0.283581	0.856821
2242.5	0.527000	0.536583	0.282779	0.854398
2242.6	0.525330	0.536779	0.281986	0.852002
2242.7	0.523650	0.536974	0.281186	0.849586
2242.8	0.521980	0.537169	0.280392	0.847185
2242.9	0.520330	0.537365	0.279607	0.844814
2243.0	0.518680	0.537560	0.278822	0.842441
2243.1	0.517050	0.537771	0.278054	0.840123
2243.2	0.515450	0.537411	0.277008	0.836962
2243.3	0.513860	0.537621	0.276262	0.834708
2243.4	0.512300	0.537832	0.275532	0.832500
2243.5	0.510770	0.538043	0.274816	0.830340
2243.6	0.509270	0.538255	0.274117	0.828226

2243.7	0.507800	0.538466	0.273433	0.826160
2243.8	0.506370	0.538677	0.272770	0.824156
2243.9	0.504980	0.538888	0.272128	0.822216
2244.0	0.503630	0.539099	0.271507	0.820339
2244.1	0.502330	0.539363	0.270938	0.818622
2244.2	0.501080	0.539627	0.270397	0.816985
2244.3	0.499880	0.539891	0.269881	0.815427
2244.4	0.498750	0.540156	0.269403	0.813982
2244.5	0.497670	0.540420	0.268951	0.812617
2244.6	0.496650	0.540684	0.268531	0.811348
2244.7	0.495700	0.540948	0.268148	0.810192
2244.8	0.494820	0.541213	0.267803	0.809149
2244.9	0.494010	0.541477	0.267495	0.808219
2245.0	0.493290	0.541741	0.267236	0.807435
2245.1	0.492640	0.541951	0.266987	0.806683
2245.2	0.492070	0.542161	0.266781	0.806062
2245.3	0.491580	0.542371	0.266619	0.805571
2245.4	0.491190	0.542581	0.266510	0.805243
2245.5	0.490890	0.542214	0.266167	0.804207
2245.6	0.490680	0.542423	0.266156	0.804174
2245.7	0.490570	0.542633	0.266200	0.804304
2245.8	0.490560	0.542843	0.266297	0.804599
2245.9	0.490650	0.543052	0.266449	0.805057
2246.0	0.490850	0.543262	0.266660	0.805696
2246.1	0.491160	0.543189	0.266793	0.806097
2246.2	0.491580	0.543116	0.266985	0.806678
2246.3	0.492110	0.543043	0.267237	0.807439
2246.4	0.492760	0.542971	0.267554	0.808397
2246.5	0.493530	0.542897	0.267936	0.809552
2246.6	0.494420	0.542824	0.268383	0.810902
2246.7	0.495430	0.542751	0.268895	0.812449
2246.8	0.496570	0.542678	0.269478	0.814209
2246.9	0.497830	0.542605	0.270125	0.816165
2247.0	0.499230	0.542532	0.270848	0.818350
2247.1	0.500750	0.542454	0.271634	0.820724
2247.2	0.502400	0.542376	0.272490	0.823310
2247.3	0.504180	0.542298	0.273416	0.826108
2247.4	0.506080	0.542221	0.274407	0.829103
2247.5	0.508120	0.542143	0.275474	0.832325
2247.6	0.510290	0.542065	0.276610	0.835759
2247.7	0.512590	0.541987	0.277817	0.839406
2247.8	0.515020	0.541909	0.279094	0.843264
2247.9	0.517570	0.541831	0.280435	0.847317

2248.0	0.520250	0.541753	0.281847	0.851582
2248.1	0.523040	0.541758	0.283361	0.856157
2248.2	0.525940	0.541764	0.284935	0.860913
2248.3	0.528940	0.541769	0.286563	0.865832
2248.4	0.532050	0.541774	0.288251	0.870930
2248.5	0.535240	0.541202	0.289673	0.875228
2248.6	0.538530	0.541208	0.291457	0.880617
2248.7	0.541890	0.541213	0.293278	0.886120
2248.8	0.545330	0.541218	0.295143	0.891754
2248.9	0.548830	0.541224	0.297040	0.897486
2249.0	0.552380	0.541229	0.298964	0.903300
2249.1	0.555960	0.541223	0.300898	0.909145
2249.2	0.559570	0.541217	0.302849	0.915038
2249.3	0.563170	0.541211	0.304794	0.920915
2249.4	0.566770	0.541205	0.306739	0.926792
2249.5	0.570340	0.541199	0.308668	0.932619
2249.6	0.573870	0.541194	0.310575	0.938381
2249.7	0.577350	0.541188	0.312455	0.944062
2249.8	0.580760	0.541182	0.314297	0.949627
2249.9	0.584080	0.541176	0.316090	0.955045
2250.0	0.587290	0.541170	0.317824	0.960283
2250.1	0.590380	0.541302	0.319574	0.965571
2250.2	0.593310	0.541434	0.321238	0.970600
2250.3	0.596060	0.541566	0.322806	0.975336
2250.4	0.598630	0.541698	0.324276	0.979780
2250.5	0.600980	0.541830	0.325629	0.983866
2250.6	0.603100	0.541962	0.326857	0.987577
2250.7	0.604960	0.542094	0.327945	0.990864
2250.8	0.606550	0.542226	0.328887	0.993710
2250.9	0.607840	0.542358	0.329667	0.996066
2251.0	0.608820	0.542489	0.330278	0.997914
2251.1	0.609470	0.542600	0.330698	0.999183
2251.2	0.609780	0.542710	0.330934	0.999895
2251.3	0.609720	0.542821	0.330969	1.000000
2251.4	0.609280	0.542931	0.330797	0.999482
2251.5	0.608450	0.543042	0.330414	0.998323
2251.6	0.607190	0.543152	0.329796	0.996458
2251.7	0.605510	0.543262	0.328951	0.993903
2251.8	0.603380	0.543373	0.327860	0.990608
2251.9	0.600790	0.542904	0.326171	0.985505
2252.0	0.597760	0.543014	0.324592	0.980733
2252.1	0.594270	0.542854	0.322602	0.974721
2252.2	0.590330	0.542695	0.320369	0.967975

2252.3	0.585930	0.542536	0.317888	0.960478
2252.4	0.581080	0.542377	0.315164	0.952248
2252.5	0.575760	0.542217	0.312187	0.943253
2252.6	0.570000	0.542058	0.308973	0.933542
2252.7	0.563770	0.541899	0.305506	0.923068
2252.8	0.557090	0.541740	0.301798	0.911863
2252.9	0.549960	0.541581	0.297848	0.899927
2253.0	0.542410	0.541422	0.293673	0.887312
2253.1	0.534460	0.541277	0.289291	0.874074
2253.2	0.526120	0.541133	0.284701	0.860204
2253.3	0.517410	0.540988	0.279913	0.845737
2253.4	0.508350	0.540843	0.274938	0.830706
2253.5	0.498960	0.540698	0.269787	0.815143
2253.6	0.489250	0.540554	0.264466	0.799066
2253.7	0.479240	0.540986	0.259262	0.783343
2253.8	0.468960	0.540841	0.253633	0.766335
2253.9	0.458420	0.540696	0.247866	0.748911
2254.0	0.447670	0.540552	0.241989	0.731153
2254.1	0.436710	0.540502	0.236043	0.713187
2254.2	0.425600	0.540453	0.230017	0.694980
2254.3	0.414340	0.540403	0.223911	0.676531
2254.4	0.402970	0.540354	0.217746	0.657906
2254.5	0.391520	0.540304	0.211540	0.639154
2254.6	0.380020	0.540255	0.205308	0.620324
2254.7	0.368490	0.540206	0.199060	0.601448
2254.8	0.356960	0.540156	0.192814	0.582575
2254.9	0.345460	0.540107	0.186585	0.563755
2255.0	0.334000	0.540057	0.180379	0.545003
2255.1	0.322620	0.540020	0.174221	0.526398
2255.2	0.311320	0.539983	0.168107	0.507926
2255.3	0.300150	0.539946	0.162065	0.489668
2255.4	0.289110	0.539908	0.156093	0.471625
2255.5	0.278230	0.539871	0.150208	0.453845
2255.6	0.267540	0.539834	0.144427	0.436377
2255.7	0.257060	0.539797	0.138760	0.419255
2255.8	0.246800	0.539760	0.133213	0.402493
2255.9	0.236790	0.539722	0.127801	0.386142
2256.0	0.227010	0.539685	0.122514	0.370168
2256.1	0.217490	0.539834	0.117408	0.354742
2256.2	0.208230	0.539982	0.112440	0.339731
2256.3	0.199240	0.540131	0.107616	0.325154
2256.4	0.190530	0.540279	0.102939	0.311025
2256.5	0.182090	0.540428	0.098407	0.297329

2256.6	0.173950	0.540839	0.094079	0.284253
2256.7	0.166110	0.541282	0.089912	0.271664
2256.8	0.158570	0.541431	0.085855	0.259404
2256.9	0.151330	0.541580	0.081957	0.247628
2257.0	0.144390	0.541728	0.078220	0.236337
2257.1	0.137740	0.541855	0.074635	0.225505
2257.2	0.131370	0.541982	0.071200	0.215127
2257.3	0.125280	0.542109	0.067915	0.205202
2257.4	0.119460	0.542235	0.064775	0.195715
2257.5	0.113910	0.542362	0.061780	0.186666
2257.6	0.108630	0.542489	0.058931	0.178055
2257.7	0.103600	0.542615	0.056215	0.169850
2257.8	0.098822	0.542742	0.053635	0.162054
2257.9	0.094287	0.542868	0.051185	0.154653
2258.0	0.089986	0.542995	0.048862	0.147633
2258.1	0.085908	0.542868	0.046637	0.140910
2258.2	0.082046	0.542742	0.044530	0.134544
2258.3	0.078389	0.542615	0.042535	0.128517
2258.4	0.074930	0.542489	0.040649	0.122817
2258.5	0.071658	0.542362	0.038865	0.117427
2258.6	0.068564	0.542236	0.037178	0.112330
2258.7	0.065640	0.542109	0.035584	0.107515
2258.8	0.062876	0.541982	0.034078	0.102963
2258.9	0.060265	0.541856	0.032655	0.098665
2259.0	0.057798	0.541729	0.031311	0.094604
2259.1	0.055467	0.541572	0.030039	0.090762
2259.2	0.053264	0.541416	0.028838	0.087132
2259.3	0.051182	0.541260	0.027703	0.083702
2259.4	0.049213	0.540527	0.026601	0.080373
2259.5	0.047348	0.540370	0.025585	0.077305
2259.6	0.045580	0.540214	0.024623	0.074397
2259.7	0.043900	0.540058	0.023709	0.071634
2259.8	0.042302	0.539902	0.022839	0.069006
2259.9	0.040780	0.539746	0.022011	0.066504
2260.0	0.039331	0.539589	0.021223	0.064123
2260.1	0.037950	0.539630	0.020479	0.061876
2260.2	0.036634	0.539670	0.019770	0.059735
2260.3	0.035379	0.539710	0.019094	0.057692
2260.4	0.034179	0.539750	0.018448	0.055740
2260.5	0.033033	0.539790	0.017831	0.053875
2260.6	0.031934	0.539830	0.017239	0.052086
2260.7	0.030880	0.539870	0.016671	0.050371
2260.8	0.029866	0.539910	0.016125	0.048721

2260.9	0.028892	0.539950	0.015600	0.047135
2261.0	0.027954	0.539990	0.015095	0.045608
2261.1	0.027051	0.540031	0.014608	0.044138
2261.2	0.026183	0.540072	0.014141	0.042725
2261.3	0.025346	0.539537	0.013675	0.041318
2261.4	0.024540	0.539579	0.013241	0.040008
2261.5	0.023763	0.540196	0.012837	0.038785
2261.6	0.023014	0.540237	0.012433	0.037566
2261.7	0.022290	0.540278	0.012043	0.036387
2261.8	0.021590	0.540319	0.011665	0.035246
2261.9	0.020914	0.540360	0.011301	0.034145
2262.0	0.020261	0.540401	0.010949	0.033082
2262.1	0.019631	0.540436	0.010609	0.032055
2262.2	0.019022	0.540472	0.010281	0.031063
2262.3	0.018435	0.540508	0.009964	0.030106
2262.4	0.017869	0.540544	0.009659	0.029184
2262.5	0.017323	0.540580	0.009364	0.028294
2262.6	0.016797	0.540616	0.009081	0.027437
2262.7	0.016290	0.541228	0.008817	0.026639
2262.8	0.015802	0.541264	0.008553	0.025842
2262.9	0.015332	0.541300	0.008299	0.025076
2263.0	0.014879	0.541336	0.008055	0.024336
2263.1	0.014443	0.541972	0.007828	0.023651
2263.2	0.014023	0.542030	0.007601	0.022966
2263.3	0.013618	0.542089	0.007382	0.022305
2263.4	0.013228	0.542149	0.007172	0.021668
2263.5	0.012853	0.542784	0.006976	0.021079
2263.6	0.012490	0.542843	0.006780	0.020486
2263.7	0.012141	0.542902	0.006591	0.019915
2263.8	0.011804	0.542961	0.006409	0.019365
2263.9	0.011478	0.543020	0.006233	0.018832
2264.0	0.011163	0.543078	0.006062	0.018317
2264.1	0.010859	0.543188	0.005898	0.017822
2264.2	0.010564	0.543409	0.005741	0.017345
2264.3	0.010278	0.543295	0.005584	0.016872
2264.4	0.010000	0.543182	0.005432	0.016412
2264.5	0.009730	0.543068	0.005284	0.015965
2264.6	0.009467	0.542954	0.005140	0.015531
2264.7	0.009212	0.542841	0.005001	0.015109
2264.8	0.008964	0.542727	0.004865	0.014699
2264.9	0.008723	0.542613	0.004733	0.014301
2265.0	0.008489	0.542500	0.004605	0.013915
2265.1	0.008262	0.542402	0.004481	0.013540

2265.2	0.008042	0.542304	0.004361	0.013176
2265.3	0.007828	0.542205	0.004244	0.012824
2265.4	0.007620	0.542107	0.004131	0.012482
2265.5	0.007420	0.542009	0.004021	0.012151
2265.6	0.007225	0.541911	0.003915	0.011830
2265.7	0.007036	0.541813	0.003812	0.011518
2265.8	0.006853	0.541715	0.003713	0.011217
2265.9	0.006677	0.541617	0.003616	0.010926
2266.0	0.006505	0.541520	0.003523	0.010644
2266.1	0.006340	0.541500	0.003433	0.010372
2266.2	0.006180	0.541481	0.003346	0.010110
2266.3	0.006025	0.541461	0.003262	0.009856
2266.4	0.005875	0.541442	0.003181	0.009611
2266.5	0.005730	0.541998	0.003106	0.009384
2266.6	0.005591	0.541979	0.003030	0.009155
2266.7	0.005456	0.541960	0.002957	0.008934
2266.8	0.005326	0.541941	0.002886	0.008721
2266.9	0.005200	0.541921	0.002818	0.008515
2267.0	0.005079	0.541902	0.002752	0.008316
2267.1	0.004962	0.541905	0.002689	0.008125
2267.2	0.004849	0.541908	0.002628	0.007940
2267.3	0.004741	0.541911	0.002569	0.007762
2267.4	0.004636	0.541914	0.002512	0.007591
2267.5	0.004535	0.541917	0.002458	0.007426
2267.6	0.004438	0.541920	0.002405	0.007266
2267.7	0.004344	0.541923	0.002354	0.007113
2267.8	0.004254	0.541923	0.002305	0.006965
2267.9	0.004167	0.541920	0.002258	0.006822
2268.0	0.004083	0.541918	0.002212	0.006685
2268.1	0.004002	0.542737	0.002172	0.006562
2268.2	0.003924	0.542981	0.002131	0.006437
2268.3	0.003849	0.543225	0.002091	0.006317
2268.4	0.003776	0.543469	0.002052	0.006201
2268.5	0.003706	0.543713	0.002015	0.006088
2268.6	0.003638	0.543957	0.001979	0.005980
2268.7	0.003573	0.544202	0.001944	0.005875
2268.8	0.003510	0.545023	0.001913	0.005780
2268.9	0.003449	0.545268	0.001880	0.005681
2269.0	0.003389	0.545512	0.001849	0.005586
2269.1	0.003331	0.545791	0.001818	0.005494
2269.2	0.003276	0.546071	0.001789	0.005404
2269.3	0.003221	0.546350	0.001760	0.005317
2269.4	0.003168	0.546629	0.001732	0.005232

2269.5	0.003116	0.546909	0.001704	0.005149
2269.6	0.003065	0.547188	0.001677	0.005068
2269.7	0.003015	0.547467	0.001651	0.004988
2269.8	0.002966	0.547747	0.001625	0.004909
2269.9	0.002918	0.548026	0.001599	0.004832
2270.0	0.002871	0.548306	0.001574	0.004756
2270.1	0.002824	0.548424	0.001548	0.004679
2270.2	0.002777	0.548543	0.001523	0.004602
2270.3	0.002730	0.549243	0.001500	0.004531
2270.4	0.002684	0.549361	0.001474	0.004455
2270.5	0.002637	0.549480	0.001449	0.004378
2270.6	0.002591	0.549598	0.001424	0.004302
2270.7	0.002544	0.549717	0.001398	0.004225
2270.8	0.002496	0.549835	0.001373	0.004147
2270.9	0.002449	0.549954	0.001347	0.004069
2271.0	0.002400	0.550072	0.001320	0.003989
2271.1	0.002351	0.550175	0.001293	0.003907
2271.2	0.002300	0.550278	0.001266	0.003825
2271.3	0.002249	0.550381	0.001238	0.003740
2271.4	0.002197	0.550483	0.001209	0.003653
2271.5	0.002143	0.550586	0.001180	0.003565
2271.6	0.002087	0.550689	0.001150	0.003473
2271.7	0.002031	0.550791	0.001118	0.003379
2271.8	0.001972	0.550894	0.001086	0.003283
2271.9	0.001912	0.550997	0.001053	0.003183
2272.0	0.001850	0.551100	0.001019	0.003080
2272.1	0.001785	0.551043	0.000984	0.002972
2272.2	0.001719	0.550985	0.000947	0.002861
2272.3	0.001650	0.550928	0.000909	0.002746
2272.4	0.001579	0.550870	0.000870	0.002627
2272.5	0.001505	0.550813	0.000829	0.002504
2272.6	0.001428	0.550755	0.000787	0.002376
2272.7	0.001349	0.550698	0.000743	0.002244
2272.8	0.001266	0.550640	0.000697	0.002107
2272.9	0.001181	0.550583	0.000650	0.001964
2273.0	0.001092	0.550525	0.000601	0.001816
2273.1	0.001000	0.550442	0.000550	0.001663
2273.2	0.000904	0.550358	0.000498	0.001504
2273.3	0.000805	0.550275	0.000443	0.001339
2273.4	0.000703	0.550191	0.000387	0.001168
2273.5	0.000596	0.550108	0.000328	0.000990
2273.6	0.000485	0.550024	0.000267	0.000806
2273.7	0.000370	0.549941	0.000204	0.000615

2273.8	0.000251	0.549857	0.000138	0.000417
2273.9	0.000128	0.549774	0.000070	0.000212
2274.0	0.000000	0.549690	0.000000	0.000000
Channel 17				
Wavenumber	HIRS Filter Transmittance	Optical Element Transmittance	Product of the HIRS Filter and Optical Element Transmittances	Normalized Value of Column 4
2361.9	0.001000	0.569504	0.000570	0.001499
2362.0	0.001000	0.569766	0.000570	0.001499
2362.1	0.001000	0.569340	0.000569	0.001498
2362.2	0.001000	0.568915	0.000569	0.001497
2362.3	0.001000	0.568489	0.000568	0.001496
2362.4	0.001000	0.568064	0.000568	0.001495
2362.5	0.001000	0.567638	0.000568	0.001494
2362.6	0.001000	0.567213	0.000567	0.001493
2362.7	0.001000	0.566787	0.000567	0.001492
2362.8	0.001000	0.566362	0.000566	0.001490
2362.9	0.002000	0.565936	0.001132	0.002979
2363.0	0.003000	0.565510	0.001697	0.004465
2363.1	0.003000	0.565078	0.001695	0.004461
2363.2	0.003000	0.564645	0.001694	0.004458
2363.3	0.004000	0.564213	0.002257	0.005939
2363.4	0.004000	0.563780	0.002255	0.005935
2363.5	0.004000	0.563347	0.002253	0.005930
2363.6	0.004000	0.562914	0.002252	0.005926
2363.7	0.004000	0.562482	0.002250	0.005921
2363.8	0.004000	0.562049	0.002248	0.005916
2363.9	0.004000	0.561616	0.002246	0.005912
2364.0	0.004000	0.561183	0.002245	0.005907
2364.1	0.004000	0.561163	0.002245	0.005907
2364.2	0.004000	0.561144	0.002245	0.005907
2364.3	0.005000	0.561125	0.002806	0.007383
2364.4	0.005000	0.561106	0.002806	0.007383
2364.5	0.004000	0.561086	0.002244	0.005906
2364.6	0.004000	0.561067	0.002244	0.005906
2364.7	0.004000	0.561047	0.002244	0.005906
2364.8	0.005000	0.561028	0.002805	0.007382
2364.9	0.005000	0.561009	0.002805	0.007382
2365.0	0.006000	0.560989	0.003366	0.008858
2365.1	0.007000	0.560946	0.003927	0.010334
2365.2	0.007000	0.560919	0.003926	0.010333
2365.3	0.007000	0.560982	0.003927	0.010334

2365.4	0.006000	0.561044	0.003366	0.008859
2365.5	0.005000	0.561107	0.002806	0.007383
2365.6	0.005000	0.561169	0.002806	0.007384
2365.7	0.004000	0.561232	0.002245	0.005908
2365.8	0.004000	0.561235	0.002245	0.005908
2365.9	0.004000	0.561192	0.002245	0.005907
2366.0	0.005000	0.561149	0.002806	0.007384
2366.1	0.005000	0.561305	0.002807	0.007386
2366.2	0.006000	0.561461	0.003369	0.008865
2366.3	0.006000	0.561388	0.003368	0.008864
2366.4	0.007000	0.561200	0.003928	0.010338
2366.5	0.007000	0.561356	0.003929	0.010341
2366.6	0.008000	0.561511	0.004492	0.011822
2366.7	0.008000	0.561667	0.004493	0.011825
2366.8	0.008000	0.561822	0.004495	0.011828
2366.9	0.008000	0.561978	0.004496	0.011831
2367.0	0.008000	0.562133	0.004497	0.011835
2367.1	0.008000	0.562290	0.004498	0.011838
2367.2	0.008000	0.562448	0.004500	0.011841
2367.3	0.008000	0.562606	0.004501	0.011845
2367.4	0.008000	0.562763	0.004502	0.011848
2367.5	0.008000	0.562921	0.004503	0.011851
2367.6	0.007000	0.563078	0.003942	0.010373
2367.7	0.007000	0.563235	0.003943	0.010376
2367.8	0.006000	0.563392	0.003380	0.008896
2367.9	0.006000	0.563549	0.003381	0.008898
2368.0	0.007000	0.563706	0.003946	0.010384
2368.1	0.007000	0.563618	0.003945	0.010383
2368.2	0.005000	0.563392	0.002817	0.007413
2368.3	0.004000	0.563523	0.002254	0.005932
2368.4	0.004000	0.563653	0.002255	0.005933
2368.5	0.004000	0.563783	0.002255	0.005935
2368.6	0.004000	0.563914	0.002256	0.005936
2368.7	0.004000	0.564044	0.002256	0.005937
2368.8	0.004000	0.564174	0.002257	0.005939
2368.9	0.004000	0.564305	0.002257	0.005940
2369.0	0.004000	0.564435	0.002258	0.005942
2369.1	0.004000	0.564553	0.002258	0.005943
2369.2	0.004000	0.564670	0.002259	0.005944
2369.3	0.004000	0.564788	0.002259	0.005945
2369.4	0.004000	0.564905	0.002260	0.005947
2369.5	0.004000	0.565023	0.002260	0.005948
2369.6	0.004000	0.565140	0.002261	0.005949

2369.7	0.004000	0.565257	0.002261	0.005950
2369.8	0.005000	0.565375	0.002827	0.007439
2369.9	0.005000	0.565492	0.002827	0.007441
2370.0	0.005000	0.565609	0.002828	0.007442
2370.1	0.005000	0.565263	0.002826	0.007438
2370.2	0.005000	0.564916	0.002825	0.007433
2370.3	0.004000	0.564570	0.002258	0.005943
2370.4	0.004000	0.564223	0.002257	0.005939
2370.5	0.004000	0.563877	0.002256	0.005936
2370.6	0.004000	0.563531	0.002254	0.005932
2370.7	0.004000	0.563185	0.002253	0.005928
2370.8	0.004000	0.562839	0.002251	0.005925
2370.9	0.004000	0.562493	0.002250	0.005921
2371.0	0.004000	0.562148	0.002249	0.005918
2371.1	0.004000	0.561800	0.002247	0.005914
2371.2	0.004000	0.561451	0.002246	0.005910
2371.3	0.004000	0.561103	0.002244	0.005907
2371.4	0.004000	0.560804	0.002243	0.005903
2371.5	0.004000	0.560561	0.002242	0.005901
2371.6	0.004000	0.560318	0.002241	0.005898
2371.7	0.004000	0.560076	0.002240	0.005896
2371.8	0.004000	0.559833	0.002239	0.005893
2371.9	0.004000	0.559590	0.002238	0.005891
2372.0	0.004000	0.559259	0.002237	0.005887
2372.1	0.003000	0.559111	0.001677	0.004414
2372.2	0.003000	0.558963	0.001677	0.004413
2372.3	0.004000	0.558815	0.002235	0.005882
2372.4	0.004000	0.558668	0.002235	0.005881
2372.5	0.004000	0.558520	0.002234	0.005879
2372.6	0.004000	0.558372	0.002233	0.005878
2372.7	0.004000	0.558224	0.002233	0.005876
2372.8	0.004000	0.558076	0.002232	0.005875
2372.9	0.004000	0.557929	0.002232	0.005873
2373.0	0.004000	0.557781	0.002231	0.005872
2373.1	0.004000	0.557641	0.002231	0.005870
2373.2	0.004000	0.557500	0.002230	0.005869
2373.3	0.004000	0.557361	0.002229	0.005867
2373.4	0.005000	0.557221	0.002786	0.007332
2373.5	0.005000	0.557081	0.002785	0.007330
2373.6	0.005000	0.556941	0.002785	0.007328
2373.7	0.005000	0.556801	0.002784	0.007327
2373.8	0.006000	0.556661	0.003340	0.008790
2373.9	0.006000	0.556521	0.003339	0.008787

2374.0	0.007000	0.556381	0.003895	0.010249
2374.1	0.006000	0.556359	0.003338	0.008785
2374.2	0.006000	0.556337	0.003338	0.008785
2374.3	0.006000	0.556315	0.003338	0.008784
2374.4	0.006000	0.556293	0.003338	0.008784
2374.5	0.006000	0.556271	0.003338	0.008784
2374.6	0.006000	0.556249	0.003337	0.008783
2374.7	0.006000	0.556227	0.003337	0.008783
2374.8	0.006000	0.556204	0.003337	0.008782
2374.9	0.006000	0.556182	0.003337	0.008782
2375.0	0.006000	0.556160	0.003337	0.008782
2375.1	0.006000	0.556135	0.003337	0.008781
2375.2	0.006000	0.556110	0.003337	0.008781
2375.3	0.006000	0.556085	0.003337	0.008781
2375.4	0.006000	0.556060	0.003336	0.008780
2375.5	0.006000	0.556035	0.003336	0.008780
2375.6	0.006000	0.556010	0.003336	0.008779
2375.7	0.006000	0.555985	0.003336	0.008779
2375.8	0.006000	0.555960	0.003336	0.008779
2375.9	0.006000	0.555935	0.003336	0.008778
2376.0	0.006000	0.555909	0.003335	0.008778
2376.1	0.006000	0.555644	0.003334	0.008774
2376.2	0.006000	0.555960	0.003336	0.008779
2376.3	0.006000	0.555702	0.003334	0.008775
2376.4	0.006000	0.555443	0.003333	0.008770
2376.5	0.006000	0.555184	0.003331	0.008766
2376.6	0.006000	0.554925	0.003330	0.008762
2376.7	0.006000	0.554666	0.003328	0.008758
2376.8	0.006000	0.554407	0.003326	0.008754
2376.9	0.006000	0.554148	0.003325	0.008750
2377.0	0.006000	0.553890	0.003323	0.008746
2377.1	0.006000	0.553619	0.003322	0.008742
2377.2	0.006000	0.553349	0.003320	0.008737
2377.3	0.006000	0.553079	0.003318	0.008733
2377.4	0.007000	0.552809	0.003870	0.010184
2377.5	0.008000	0.552539	0.004420	0.011633
2377.6	0.007000	0.552269	0.003866	0.010174
2377.7	0.006000	0.551999	0.003312	0.008716
2377.8	0.007000	0.551729	0.003862	0.010164
2377.9	0.007000	0.551460	0.003860	0.010159
2378.0	0.008000	0.551190	0.004410	0.011604
2378.1	0.008000	0.551123	0.004409	0.011603
2378.2	0.008000	0.551056	0.004408	0.011602

2378.3	0.008000	0.550988	0.004408	0.011600
2378.4	0.008000	0.550921	0.004407	0.011599
2378.5	0.008000	0.550853	0.004407	0.011597
2378.6	0.009000	0.550786	0.004957	0.013045
2378.7	0.010000	0.550718	0.005507	0.014493
2378.8	0.010000	0.550651	0.005507	0.014491
2378.9	0.010000	0.550584	0.005506	0.014489
2379.0	0.010000	0.550516	0.005505	0.014488
2379.1	0.010000	0.550440	0.005504	0.014486
2379.2	0.010000	0.550363	0.005504	0.014484
2379.3	0.010000	0.550286	0.005503	0.014482
2379.4	0.010000	0.550209	0.005502	0.014480
2379.5	0.011000	0.550132	0.006051	0.015925
2379.6	0.011000	0.550055	0.006051	0.015923
2379.7	0.012000	0.549978	0.006600	0.017368
2379.8	0.012000	0.549902	0.006599	0.017366
2379.9	0.012000	0.549825	0.006598	0.017363
2380.0	0.011000	0.549748	0.006047	0.015914
2380.1	0.010000	0.549792	0.005498	0.014469
2380.2	0.010000	0.549835	0.005498	0.014470
2380.3	0.012000	0.549879	0.006599	0.017365
2380.4	0.011000	0.549922	0.006049	0.015919
2380.5	0.009000	0.549966	0.004950	0.013026
2380.6	0.009000	0.550009	0.004950	0.013027
2380.7	0.010000	0.550052	0.005501	0.014476
2380.8	0.010000	0.550096	0.005501	0.014477
2380.9	0.009000	0.550139	0.004951	0.013030
2381.0	0.009000	0.550183	0.004952	0.013031
2381.1	0.009000	0.550235	0.004952	0.013032
2381.2	0.009000	0.550287	0.004953	0.013034
2381.3	0.009000	0.550339	0.004953	0.013035
2381.4	0.009000	0.550390	0.004954	0.013036
2381.5	0.009000	0.550442	0.004954	0.013037
2381.6	0.009000	0.550494	0.004954	0.013038
2381.7	0.009000	0.550546	0.004955	0.013040
2381.8	0.009000	0.550598	0.004955	0.013041
2381.9	0.009000	0.550650	0.004956	0.013042
2382.0	0.009000	0.550702	0.004956	0.013043
2382.1	0.009000	0.550462	0.004954	0.013038
2382.2	0.009000	0.550222	0.004952	0.013032
2382.3	0.009000	0.549981	0.004950	0.013026
2382.4	0.009000	0.549741	0.004948	0.013021
2382.5	0.009000	0.549501	0.004946	0.013015

2382.6	0.009000	0.549261	0.004943	0.013009
2382.7	0.009000	0.549068	0.004942	0.013005
2382.8	0.009000	0.548930	0.004940	0.013001
2382.9	0.009000	0.548791	0.004939	0.012998
2383.0	0.009000	0.548653	0.004938	0.012995
2383.1	0.009000	0.548515	0.004937	0.012992
2383.2	0.009000	0.548377	0.004935	0.012988
2383.3	0.009000	0.548160	0.004933	0.012983
2383.4	0.009000	0.547921	0.004931	0.012977
2383.5	0.009000	0.547681	0.004929	0.012972
2383.6	0.009000	0.547442	0.004927	0.012966
2383.7	0.009000	0.547203	0.004925	0.012960
2383.8	0.009000	0.546964	0.004923	0.012955
2383.9	0.009000	0.546724	0.004921	0.012949
2384.0	0.009000	0.546485	0.004918	0.012943
2384.1	0.009000	0.546421	0.004918	0.012942
2384.2	0.009000	0.546356	0.004917	0.012940
2384.3	0.009000	0.546292	0.004917	0.012939
2384.4	0.009000	0.546227	0.004916	0.012937
2384.5	0.009000	0.546163	0.004915	0.012936
2384.6	0.009000	0.546099	0.004915	0.012934
2384.7	0.009000	0.546035	0.004914	0.012933
2384.8	0.009000	0.545970	0.004914	0.012931
2384.9	0.009000	0.545906	0.004913	0.012930
2385.0	0.010000	0.545841	0.005458	0.014365
2385.1	0.010000	0.545799	0.005458	0.014364
2385.2	0.010000	0.545757	0.005458	0.014362
2385.3	0.010000	0.545715	0.005457	0.014361
2385.4	0.010000	0.545673	0.005457	0.014360
2385.5	0.011000	0.545631	0.006002	0.015795
2385.6	0.011000	0.545589	0.006001	0.015794
2385.7	0.011000	0.545547	0.006001	0.015793
2385.8	0.012000	0.545505	0.006546	0.017227
2385.9	0.012000	0.545463	0.006546	0.017226
2386.0	0.012000	0.545421	0.006545	0.017224
2386.1	0.012000	0.545684	0.006548	0.017233
2386.2	0.012000	0.545946	0.006551	0.017241
2386.3	0.012000	0.546209	0.006555	0.017249
2386.4	0.012000	0.546472	0.006558	0.017258
2386.5	0.012000	0.546735	0.006561	0.017266
2386.6	0.012000	0.546997	0.006564	0.017274
2386.7	0.012000	0.547260	0.006567	0.017282
2386.8	0.013000	0.547523	0.007118	0.018732

2386.9	0.014000	0.547786	0.007669	0.020182
2387.0	0.014000	0.548049	0.007673	0.020192
2387.1	0.014000	0.548291	0.007676	0.020201
2387.2	0.014000	0.548533	0.007679	0.020210
2387.3	0.014000	0.548775	0.007683	0.020219
2387.4	0.014000	0.549017	0.007686	0.020228
2387.5	0.014000	0.549259	0.007690	0.020236
2387.6	0.015000	0.549501	0.008243	0.021692
2387.7	0.016000	0.549743	0.008796	0.023148
2387.8	0.016000	0.549985	0.008800	0.023158
2387.9	0.016000	0.550227	0.008804	0.023168
2388.0	0.016000	0.550469	0.008808	0.023178
2388.1	0.016000	0.550391	0.008806	0.023175
2388.2	0.016000	0.550314	0.008805	0.023172
2388.3	0.016000	0.550236	0.008804	0.023169
2388.4	0.016000	0.550158	0.008803	0.023165
2388.5	0.016000	0.550080	0.008801	0.023162
2388.6	0.017000	0.550002	0.009350	0.024606
2388.7	0.017000	0.549925	0.009349	0.024603
2388.8	0.017000	0.549746	0.009346	0.024595
2388.9	0.017000	0.549207	0.009337	0.024571
2389.0	0.017000	0.549129	0.009335	0.024567
2389.1	0.017000	0.549029	0.009333	0.024563
2389.2	0.017000	0.548929	0.009332	0.024558
2389.3	0.017000	0.548828	0.009330	0.024554
2389.4	0.017000	0.548728	0.009328	0.024549
2389.5	0.017000	0.548627	0.009327	0.024545
2389.6	0.017000	0.548527	0.009325	0.024540
2389.7	0.018000	0.548427	0.009872	0.025979
2389.8	0.019000	0.548896	0.010429	0.027446
2389.9	0.020000	0.548796	0.010976	0.028885
2390.0	0.020000	0.548695	0.010974	0.028880
2390.1	0.019000	0.548491	0.010421	0.027425
2390.2	0.020000	0.548286	0.010966	0.028858
2390.3	0.020000	0.548081	0.010962	0.028847
2390.4	0.020000	0.547876	0.010958	0.028836
2390.5	0.020000	0.547671	0.010953	0.028826
2390.6	0.020000	0.547466	0.010949	0.028815
2390.7	0.019000	0.547261	0.010398	0.027364
2390.8	0.019000	0.547056	0.010394	0.027354
2390.9	0.019000	0.546851	0.010390	0.027343
2391.0	0.019000	0.546646	0.010386	0.027333
2391.1	0.019000	0.546422	0.010382	0.027322

2391.2	0.020000	0.546199	0.010924	0.028748
2391.3	0.020000	0.545975	0.010920	0.028736
2391.4	0.019000	0.545752	0.010369	0.027288
2391.5	0.019000	0.545528	0.010365	0.027277
2391.6	0.020000	0.545304	0.010906	0.028701
2391.7	0.021000	0.545081	0.011447	0.030124
2391.8	0.022000	0.544857	0.011987	0.031545
2391.9	0.022000	0.544633	0.011982	0.031532
2392.0	0.022000	0.544410	0.011977	0.031519
2392.1	0.022000	0.544492	0.011979	0.031524
2392.2	0.022000	0.544575	0.011981	0.031529
2392.3	0.022000	0.544657	0.011982	0.031534
2392.4	0.023000	0.544740	0.012529	0.032972
2392.5	0.024000	0.544822	0.013076	0.034411
2392.6	0.025000	0.544905	0.013623	0.035850
2392.7	0.025000	0.544988	0.013625	0.035856
2392.8	0.025000	0.545071	0.013627	0.035861
2392.9	0.024000	0.545154	0.013084	0.034432
2393.0	0.025000	0.545319	0.013633	0.035877
2393.1	0.027000	0.545581	0.014731	0.038766
2393.2	0.028000	0.546245	0.015295	0.040251
2393.3	0.029000	0.546429	0.015846	0.041702
2393.4	0.030000	0.546613	0.016398	0.043155
2393.5	0.030000	0.546787	0.016404	0.043169
2393.6	0.030000	0.546870	0.016406	0.043175
2393.7	0.032000	0.546954	0.017503	0.046061
2393.8	0.033000	0.547038	0.018052	0.047507
2393.9	0.033000	0.547122	0.018055	0.047515
2394.0	0.033000	0.547206	0.018058	0.047522
2394.1	0.033000	0.547116	0.018055	0.047514
2394.2	0.033000	0.547027	0.018052	0.047506
2394.3	0.033000	0.546937	0.018049	0.047499
2394.4	0.034000	0.546848	0.018593	0.048930
2394.5	0.035000	0.546759	0.019137	0.050361
2394.6	0.036000	0.546669	0.019680	0.051791
2394.7	0.036000	0.546580	0.019677	0.051783
2394.8	0.037000	0.546491	0.020220	0.053213
2394.9	0.038000	0.546402	0.020763	0.054642
2395.0	0.040000	0.546312	0.021852	0.057508
2395.1	0.040000	0.546284	0.021851	0.057505
2395.2	0.040000	0.546256	0.021850	0.057502
2395.3	0.042000	0.546227	0.022942	0.060374
2395.4	0.044000	0.546199	0.024033	0.063246

2395.5	0.044000	0.546171	0.024032	0.063243
2395.6	0.045000	0.546143	0.024576	0.064677
2395.7	0.046000	0.546115	0.025121	0.066111
2395.8	0.048000	0.546087	0.026212	0.068982
2395.9	0.048000	0.546058	0.026211	0.068978
2396.0	0.048000	0.546030	0.026209	0.068974
2396.1	0.049000	0.546026	0.026755	0.070411
2396.2	0.051000	0.546021	0.027847	0.073284
2396.3	0.053000	0.546017	0.028939	0.076157
2396.4	0.055000	0.546012	0.030031	0.079031
2396.5	0.056000	0.546008	0.030576	0.080467
2396.6	0.057000	0.546003	0.031122	0.081903
2396.7	0.058000	0.545999	0.031668	0.083339
2396.8	0.058000	0.545994	0.031668	0.083339
2396.9	0.061000	0.545990	0.033305	0.087648
2397.0	0.065000	0.546053	0.035493	0.093407
2397.1	0.067000	0.546135	0.036591	0.096295
2397.2	0.067000	0.546217	0.036597	0.096310
2397.3	0.067000	0.546298	0.036602	0.096324
2397.4	0.068000	0.546947	0.037192	0.097878
2397.5	0.070000	0.547029	0.038292	0.100772
2397.6	0.071000	0.547017	0.038838	0.102209
2397.7	0.074000	0.546998	0.040478	0.106524
2397.8	0.076000	0.546979	0.041570	0.109399
2397.9	0.077000	0.546960	0.042116	0.110835
2398.0	0.078000	0.546941	0.042661	0.112270
2398.1	0.080000	0.546961	0.043757	0.115153
2398.2	0.081000	0.546981	0.044305	0.116597
2398.3	0.083000	0.547001	0.045401	0.119480
2398.4	0.085000	0.547021	0.046497	0.122364
2398.5	0.086000	0.547040	0.047045	0.123808
2398.6	0.088000	0.547060	0.048141	0.126692
2398.7	0.089000	0.547080	0.048690	0.128136
2398.8	0.091000	0.547099	0.049786	0.131020
2398.9	0.093000	0.547119	0.050882	0.133904
2399.0	0.094000	0.547138	0.051431	0.135349
2399.1	0.096000	0.547138	0.052525	0.138229
2399.2	0.100000	0.547137	0.054714	0.143988
2399.3	0.103000	0.547137	0.056355	0.148307
2399.4	0.104000	0.547136	0.056902	0.149747
2399.5	0.104000	0.547135	0.056902	0.149747
2399.6	0.106000	0.547135	0.057996	0.152627
2399.7	0.109000	0.547134	0.059638	0.156946

2399.8	0.112000	0.547133	0.061279	0.161265
2399.9	0.114000	0.547132	0.062373	0.164145
2400.0	0.116000	0.547131	0.063467	0.167024
2400.1	0.118000	0.547144	0.064563	0.169908
2400.2	0.122000	0.547156	0.066753	0.175671
2400.3	0.124000	0.547173	0.067850	0.178557
2400.4	0.128000	0.547193	0.070041	0.184323
2400.5	0.138000	0.547212	0.075515	0.198730
2400.6	0.140000	0.547231	0.076612	0.201618
2400.7	0.141000	0.547250	0.077162	0.203065
2400.8	0.143000	0.547269	0.078259	0.205952
2400.9	0.147000	0.547288	0.080451	0.211721
2401.0	0.150000	0.547308	0.082096	0.216049
2401.1	0.153000	0.547335	0.083742	0.220381
2401.2	0.157000	0.547363	0.085936	0.226154
2401.3	0.160000	0.547390	0.087582	0.230487
2401.4	0.163000	0.547418	0.089229	0.234821
2401.5	0.168000	0.547446	0.091971	0.242036
2401.6	0.174000	0.547473	0.095260	0.250693
2401.7	0.183000	0.547501	0.100193	0.263673
2401.8	0.193000	0.547529	0.105673	0.278096
2401.9	0.195000	0.547557	0.106774	0.280992
2402.0	0.197000	0.547585	0.107874	0.283888
2402.1	0.198000	0.547733	0.108451	0.285407
2402.2	0.199000	0.547882	0.109029	0.286926
2402.3	0.201000	0.548030	0.110154	0.289888
2402.4	0.203000	0.548179	0.111280	0.292852
2402.5	0.205000	0.548328	0.112407	0.295818
2402.6	0.210000	0.548477	0.115180	0.303115
2402.7	0.213000	0.548627	0.116857	0.307529
2402.8	0.214000	0.549345	0.117560	0.309377
2402.9	0.216000	0.549494	0.118691	0.312354
2403.0	0.219000	0.549644	0.120372	0.316778
2403.1	0.223000	0.549727	0.122589	0.322613
2403.2	0.225000	0.549810	0.123707	0.325555
2403.3	0.228000	0.549893	0.125376	0.329946
2403.4	0.232000	0.549976	0.127594	0.335785
2403.5	0.235000	0.550059	0.129264	0.340179
2403.6	0.236000	0.550143	0.129834	0.341678
2403.7	0.246000	0.550226	0.135356	0.356210
2403.8	0.257000	0.550309	0.141430	0.372195
2403.9	0.259000	0.550393	0.142552	0.375148
2404.0	0.261000	0.550476	0.143674	0.378102

2404.1	0.266000	0.550422	0.146412	0.385308
2404.2	0.271000	0.550386	0.149155	0.392524
2404.3	0.277000	0.550878	0.152593	0.401574
2404.4	0.285000	0.550825	0.156985	0.413131
2404.5	0.285000	0.550771	0.156970	0.413091
2404.6	0.286000	0.550718	0.157505	0.414501
2404.7	0.294000	0.550665	0.161895	0.426054
2404.8	0.298000	0.550611	0.164082	0.431808
2404.9	0.300000	0.550557	0.165167	0.434664
2405.0	0.310000	0.550504	0.170656	0.449109
2405.1	0.323000	0.550494	0.177809	0.467934
2405.2	0.326000	0.550483	0.179458	0.472272
2405.3	0.326000	0.550473	0.179454	0.472263
2405.4	0.328000	0.550463	0.180552	0.475151
2405.5	0.330000	0.550452	0.181649	0.478039
2405.6	0.331000	0.550442	0.182196	0.479479
2405.7	0.332000	0.550432	0.182743	0.480919
2405.8	0.340000	0.550421	0.187143	0.492498
2405.9	0.351000	0.550411	0.193194	0.508422
2406.0	0.357000	0.550400	0.196493	0.517103
2406.1	0.361000	0.550522	0.198739	0.523012
2406.2	0.366000	0.550644	0.201536	0.530373
2406.3	0.370000	0.550765	0.203783	0.536288
2406.4	0.374000	0.550887	0.206032	0.542206
2406.5	0.379000	0.551008	0.208832	0.549576
2406.6	0.382000	0.551130	0.210532	0.554048
2406.7	0.385000	0.551251	0.212232	0.558522
2406.8	0.394000	0.551373	0.217241	0.571704
2406.9	0.403000	0.551494	0.222252	0.584892
2407.0	0.405000	0.551615	0.223404	0.587924
2407.1	0.405000	0.551830	0.223491	0.588153
2407.2	0.407000	0.552045	0.224682	0.591288
2407.3	0.411000	0.552831	0.227214	0.597950
2407.4	0.417000	0.553046	0.230620	0.606914
2407.5	0.422000	0.553261	0.233476	0.614430
2407.6	0.425000	0.553475	0.235227	0.619038
2407.7	0.426000	0.554256	0.236113	0.621369
2407.8	0.427000	0.554471	0.236759	0.623070
2407.9	0.430000	0.554686	0.238515	0.627690
2408.0	0.433000	0.554901	0.240272	0.632315
2408.1	0.437000	0.555133	0.242593	0.638423
2408.2	0.443000	0.555365	0.246027	0.647459
2408.3	0.452000	0.555597	0.251130	0.660889

2408.4	0.457000	0.555829	0.254014	0.668479
2408.5	0.460000	0.556084	0.255799	0.673175
2408.6	0.462000	0.556417	0.257065	0.676507
2408.7	0.467000	0.556750	0.260002	0.684238
2408.8	0.474000	0.557083	0.264057	0.694909
2408.9	0.478000	0.557416	0.266445	0.701193
2409.0	0.480000	0.557749	0.267720	0.704548
2409.1	0.482000	0.557967	0.268940	0.707759
2409.2	0.486000	0.558125	0.271249	0.713835
2409.3	0.494000	0.558284	0.275792	0.725792
2409.4	0.502000	0.558442	0.280338	0.737755
2409.5	0.511000	0.558601	0.285445	0.751195
2409.6	0.518000	0.558760	0.289438	0.761702
2409.7	0.518000	0.558919	0.289520	0.761918
2409.8	0.518000	0.559077	0.289602	0.762135
2409.9	0.521000	0.559236	0.291362	0.766766
2410.0	0.524000	0.559395	0.293123	0.771401
2410.1	0.526000	0.559300	0.294192	0.774213
2410.2	0.528000	0.559205	0.295260	0.777025
2410.3	0.532000	0.559111	0.297447	0.782779
2410.4	0.537000	0.559016	0.300192	0.790002
2410.5	0.541000	0.558921	0.302376	0.795752
2410.6	0.544000	0.558826	0.304002	0.800029
2410.7	0.547000	0.558732	0.305626	0.804305
2410.8	0.550000	0.558637	0.307250	0.808579
2410.9	0.554000	0.558542	0.309432	0.814321
2411.0	0.557000	0.558447	0.311055	0.818592
2411.1	0.559000	0.558815	0.312378	0.822073
2411.2	0.561000	0.558605	0.313378	0.824703
2411.3	0.564000	0.558395	0.314935	0.828802
2411.4	0.568000	0.558185	0.317049	0.834366
2411.5	0.569000	0.557975	0.317488	0.835520
2411.6	0.571000	0.557765	0.318484	0.838141
2411.7	0.577000	0.557555	0.321709	0.846630
2411.8	0.579000	0.557345	0.322703	0.849244
2411.9	0.579000	0.557135	0.322581	0.848925
2412.0	0.581000	0.556925	0.323574	0.851536
2412.1	0.585000	0.556675	0.325655	0.857013
2412.2	0.586000	0.556424	0.326064	0.858091
2412.3	0.588000	0.556173	0.327030	0.860631
2412.4	0.592000	0.555922	0.329106	0.866095
2412.5	0.596000	0.555672	0.331180	0.871554
2412.6	0.598000	0.555421	0.332142	0.874085

2412.7	0.600000	0.555171	0.333102	0.876613
2412.8	0.604000	0.554920	0.335172	0.882059
2412.9	0.608000	0.554670	0.337239	0.887500
2413.0	0.610000	0.554420	0.338196	0.890017
2413.1	0.612000	0.554153	0.339142	0.892507
2413.2	0.614000	0.553887	0.340087	0.894994
2413.3	0.616000	0.553622	0.341031	0.897478
2413.4	0.617000	0.553356	0.341421	0.898503
2413.5	0.618000	0.553090	0.341810	0.899527
2413.6	0.620000	0.552824	0.342751	0.902005
2413.7	0.624000	0.552559	0.344797	0.907388
2413.8	0.629000	0.552293	0.347392	0.914219
2413.9	0.633000	0.552028	0.349434	0.919591
2414.0	0.634000	0.551762	0.349817	0.920601
2414.1	0.635000	0.551684	0.350319	0.921922
2414.2	0.637000	0.551606	0.351373	0.924694
2414.3	0.641000	0.551527	0.353529	0.930369
2414.4	0.644000	0.551450	0.355134	0.934591
2414.5	0.647000	0.551941	0.357106	0.939782
2414.6	0.649000	0.551863	0.358159	0.942553
2414.7	0.650000	0.551784	0.358660	0.943871
2414.8	0.652000	0.551706	0.359712	0.946641
2414.9	0.655000	0.551627	0.361316	0.950861
2415.0	0.657000	0.551549	0.362368	0.953629
2415.1	0.657000	0.551497	0.362334	0.953539
2415.2	0.658000	0.551445	0.362851	0.954900
2415.3	0.660000	0.551392	0.363919	0.957711
2415.4	0.662000	0.551340	0.364987	0.960522
2415.5	0.664000	0.551287	0.366055	0.963332
2415.6	0.665000	0.551235	0.366571	0.964691
2415.7	0.665000	0.551182	0.366536	0.964599
2415.8	0.665000	0.551130	0.366501	0.964507
2415.9	0.665000	0.551077	0.366466	0.964415
2416.0	0.666000	0.551025	0.366982	0.965774
2416.1	0.668000	0.551041	0.368095	0.968702
2416.2	0.668000	0.551056	0.368106	0.968729
2416.3	0.669000	0.551072	0.368667	0.970207
2416.4	0.673000	0.551088	0.370882	0.976036
2416.5	0.674000	0.551104	0.371444	0.977514
2416.6	0.674000	0.551119	0.371454	0.977542
2416.7	0.675000	0.551135	0.372016	0.979020
2416.8	0.677000	0.551150	0.373129	0.981949
2416.9	0.679000	0.551166	0.374242	0.984877

2417.0	0.679000	0.551181	0.374252	0.984905
2417.1	0.679000	0.551162	0.374239	0.984870
2417.2	0.681000	0.551143	0.375328	0.987737
2417.3	0.681000	0.551124	0.375315	0.987702
2417.4	0.681000	0.551104	0.375302	0.987668
2417.5	0.683000	0.551085	0.376391	0.990533
2417.6	0.685000	0.551635	0.377870	0.994425
2417.7	0.685000	0.551615	0.377856	0.994390
2417.8	0.686000	0.551595	0.378394	0.995806
2417.9	0.686000	0.551575	0.378381	0.995770
2418.0	0.686000	0.551556	0.378367	0.995734
2418.1	0.687000	0.551275	0.378726	0.996679
2418.2	0.688000	0.550995	0.379085	0.997622
2418.3	0.689000	0.550715	0.379443	0.998564
2418.4	0.689000	0.550455	0.379263	0.998093
2418.5	0.689000	0.550273	0.379138	0.997764
2418.6	0.690000	0.550092	0.379563	0.998882
2418.7	0.691000	0.549910	0.379988	1.000000
2418.8	0.691000	0.549729	0.379863	0.999670
2418.9	0.691000	0.549547	0.379737	0.999339
2419.0	0.691000	0.549331	0.379587	0.998945
2419.1	0.691000	0.549038	0.379385	0.998413
2419.2	0.692000	0.548745	0.379731	0.999325
2419.3	0.692000	0.548452	0.379529	0.998792
2419.4	0.692000	0.548160	0.379327	0.998259
2419.5	0.691000	0.547867	0.378576	0.996285
2419.6	0.691000	0.547575	0.378374	0.995753
2419.7	0.691000	0.547283	0.378172	0.995221
2419.8	0.690000	0.546990	0.377423	0.993250
2419.9	0.689000	0.546698	0.376675	0.991280
2420.0	0.689000	0.546406	0.376473	0.990751
2420.1	0.689000	0.546256	0.376370	0.990480
2420.2	0.688000	0.546107	0.375721	0.988771
2420.3	0.687000	0.545957	0.375073	0.987064
2420.4	0.687000	0.546371	0.375357	0.987811
2420.5	0.687000	0.546222	0.375254	0.987542
2420.6	0.686000	0.546072	0.374605	0.985835
2420.7	0.685000	0.545922	0.373957	0.984128
2420.8	0.684000	0.545773	0.373309	0.982422
2420.9	0.683000	0.545623	0.372661	0.980717
2421.0	0.682000	0.545474	0.372013	0.979013
2421.1	0.682000	0.545393	0.371958	0.978868
2421.2	0.682000	0.545312	0.371903	0.978723

2421.3	0.681000	0.545232	0.371303	0.977143
2421.4	0.680000	0.545151	0.370703	0.975564
2421.5	0.680000	0.545070	0.370648	0.975420
2421.6	0.680000	0.544990	0.370593	0.975275
2421.7	0.680000	0.544909	0.370538	0.975131
2421.8	0.678000	0.544828	0.369394	0.972119
2421.9	0.678000	0.544748	0.369339	0.971976
2422.0	0.678000	0.544668	0.369285	0.971832
2422.1	0.677000	0.544840	0.368857	0.970707
2422.2	0.676000	0.545013	0.368429	0.969581
2422.3	0.676000	0.545187	0.368546	0.969889
2422.4	0.676000	0.545360	0.368663	0.970197
2422.5	0.675000	0.545533	0.368235	0.969069
2422.6	0.673000	0.546180	0.367579	0.967343
2422.7	0.674000	0.546436	0.368298	0.969235
2422.8	0.673000	0.546610	0.367868	0.968105
2422.9	0.672000	0.546784	0.367439	0.966974
2423.0	0.672000	0.547521	0.367934	0.968277
2423.1	0.672000	0.547736	0.368079	0.968658
2423.2	0.671000	0.547951	0.367675	0.967597
2423.3	0.671000	0.548166	0.367820	0.967977
2423.4	0.671000	0.548382	0.367964	0.968357
2423.5	0.671000	0.548597	0.368109	0.968737
2423.6	0.671000	0.548812	0.368253	0.969117
2423.7	0.671000	0.549028	0.368398	0.969498
2423.8	0.671000	0.549243	0.368542	0.969878
2423.9	0.671000	0.549459	0.368687	0.970259
2424.0	0.671000	0.549674	0.368832	0.970640
2424.1	0.670000	0.549533	0.368187	0.968944
2424.2	0.670000	0.549391	0.368092	0.968694
2424.3	0.669000	0.549250	0.367448	0.966999
2424.4	0.670000	0.549108	0.367902	0.968195
2424.5	0.670000	0.548966	0.367807	0.967945
2424.6	0.670000	0.548825	0.367712	0.967695
2424.7	0.670000	0.548683	0.367617	0.967445
2424.8	0.670000	0.548541	0.367522	0.967194
2424.9	0.669000	0.548399	0.366879	0.965501
2425.0	0.668000	0.548257	0.366235	0.963808
2425.1	0.669000	0.548133	0.366701	0.965032
2425.2	0.669000	0.548009	0.366618	0.964814
2425.3	0.668000	0.547885	0.365987	0.963154
2425.4	0.668000	0.547761	0.365905	0.962937
2425.5	0.668000	0.548201	0.366198	0.963709

2425.6	0.668000	0.548076	0.366115	0.963491
2425.7	0.668000	0.547952	0.366032	0.963272
2425.8	0.668000	0.547827	0.365948	0.963052
2425.9	0.668000	0.547702	0.365865	0.962833
2426.0	0.668000	0.547577	0.365781	0.962613
2426.1	0.668000	0.547537	0.365755	0.962543
2426.2	0.668000	0.547497	0.365728	0.962473
2426.3	0.668000	0.547457	0.365702	0.962403
2426.4	0.668000	0.547417	0.365675	0.962332
2426.5	0.669000	0.547377	0.366195	0.963702
2426.6	0.670000	0.547337	0.366716	0.965072
2426.7	0.670000	0.547297	0.366689	0.965002
2426.8	0.670000	0.547257	0.366662	0.964931
2426.9	0.670000	0.547216	0.366635	0.964859
2427.0	0.670000	0.547176	0.366608	0.964788
2427.1	0.670000	0.547059	0.366529	0.964581
2427.2	0.669000	0.546941	0.365904	0.962935
2427.3	0.670000	0.546824	0.366372	0.964167
2427.4	0.671000	0.546706	0.366840	0.965399
2427.5	0.671000	0.546589	0.366761	0.965191
2427.6	0.671000	0.546471	0.366682	0.964984
2427.7	0.672000	0.546354	0.367150	0.966214
2427.8	0.673000	0.545791	0.367317	0.966654
2427.9	0.674000	0.545562	0.367709	0.967685
2428.0	0.675000	0.545445	0.368175	0.968912
2428.1	0.677000	0.545586	0.369362	0.972035
2428.2	0.677000	0.545727	0.369457	0.972286
2428.3	0.678000	0.545868	0.370098	0.973973
2428.4	0.679000	0.546009	0.370740	0.975662
2428.5	0.679000	0.546150	0.370836	0.975913
2428.6	0.679000	0.546290	0.370931	0.976165
2428.7	0.679000	0.546431	0.371027	0.976416
2428.8	0.679000	0.546572	0.371122	0.976668
2428.9	0.679000	0.546712	0.371218	0.976919
2429.0	0.679000	0.546853	0.371313	0.977171
2429.1	0.679000	0.547028	0.371432	0.977483
2429.2	0.679000	0.547203	0.371551	0.977796
2429.3	0.679000	0.547378	0.371669	0.978108
2429.4	0.679000	0.547552	0.371788	0.978420
2429.5	0.679000	0.547727	0.371907	0.978732
2429.6	0.679000	0.547902	0.372025	0.979044
2429.7	0.679000	0.548076	0.372144	0.979357
2429.8	0.679000	0.548251	0.372263	0.979669

2429.9	0.679000	0.548426	0.372381	0.979981
2430.0	0.679000	0.548601	0.372500	0.980294
2430.1	0.679000	0.548478	0.372416	0.980074
2430.2	0.679000	0.548355	0.372333	0.979854
2430.3	0.679000	0.548232	0.372249	0.979634
2430.4	0.679000	0.548109	0.372166	0.979414
2430.5	0.679000	0.547986	0.372082	0.979194
2430.6	0.678000	0.547862	0.371451	0.977533
2430.7	0.677000	0.547739	0.370820	0.975871
2430.8	0.676000	0.547616	0.370188	0.974211
2430.9	0.674000	0.547493	0.369010	0.971110
2431.0	0.673000	0.547370	0.368380	0.969451
2431.1	0.673000	0.547281	0.368320	0.969293
2431.2	0.673000	0.547192	0.368260	0.969135
2431.3	0.673000	0.547103	0.368200	0.968978
2431.4	0.671000	0.547014	0.367046	0.965941
2431.5	0.668000	0.546929	0.365348	0.961473
2431.6	0.666000	0.547269	0.364481	0.959192
2431.7	0.666000	0.546753	0.364138	0.958287
2431.8	0.662000	0.546668	0.361894	0.952383
2431.9	0.654000	0.546583	0.357465	0.940727
2432.0	0.650000	0.546497	0.355223	0.934827
2432.1	0.648000	0.546589	0.354190	0.932107
2432.2	0.646000	0.546681	0.353156	0.929386
2432.3	0.643000	0.546772	0.351575	0.925225
2432.4	0.641000	0.546864	0.350540	0.922502
2432.5	0.636000	0.546956	0.347864	0.915460
2432.6	0.631000	0.547047	0.345187	0.908415
2432.7	0.628000	0.547139	0.343603	0.904248
2432.8	0.624000	0.547231	0.341472	0.898639
2432.9	0.621000	0.547323	0.339887	0.894468
2433.0	0.619000	0.547414	0.338849	0.891737
2433.1	0.617000	0.547372	0.337728	0.888787
2433.2	0.614000	0.547330	0.336061	0.884397
2433.3	0.597000	0.547706	0.326981	0.860502
2433.4	0.583000	0.547803	0.319369	0.840472
2433.5	0.579000	0.547761	0.317154	0.834641
2433.6	0.577000	0.547719	0.316034	0.831693
2433.7	0.569000	0.547676	0.311628	0.820099
2433.8	0.557000	0.547634	0.305032	0.802741
2433.9	0.552000	0.547591	0.302270	0.795474
2434.0	0.546000	0.547549	0.298962	0.786766
2434.1	0.540000	0.547519	0.295660	0.778077

2434.2	0.520000	0.547488	0.284694	0.749218
2434.3	0.518000	0.547457	0.283583	0.746294
2434.4	0.516000	0.547427	0.282472	0.743371
2434.5	0.514000	0.547396	0.281362	0.740448
2434.6	0.510000	0.547365	0.279156	0.734645
2434.7	0.502000	0.547334	0.274762	0.723080
2434.8	0.489000	0.547303	0.267631	0.704315
2434.9	0.483000	0.547272	0.264332	0.695634
2435.0	0.480000	0.547241	0.262676	0.691274
2435.1	0.478000	0.547173	0.261549	0.688307
2435.2	0.476000	0.547104	0.260422	0.685341
2435.3	0.474000	0.547035	0.259295	0.682376
2435.4	0.452000	0.546966	0.247229	0.650622
2435.5	0.450000	0.546897	0.246104	0.647662
2435.6	0.448000	0.547391	0.245231	0.645366
2435.7	0.446000	0.547322	0.244106	0.642403
2435.8	0.443000	0.547252	0.242433	0.638001
2435.9	0.413000	0.547183	0.225987	0.594720
2436.0	0.398000	0.547113	0.217751	0.573047
2436.1	0.396000	0.546769	0.216521	0.569809
2436.2	0.393000	0.546425	0.214745	0.565136
2436.3	0.391000	0.546081	0.213518	0.561907
2436.4	0.378000	0.545738	0.206289	0.542882
2436.5	0.378000	0.545394	0.206159	0.542540
2436.6	0.377000	0.545051	0.205484	0.540764
2436.7	0.343000	0.544707	0.186835	0.491685
2436.8	0.332000	0.544364	0.180729	0.475617
2436.9	0.332000	0.544021	0.180615	0.475317
2437.0	0.331000	0.543678	0.179957	0.473587
2437.1	0.331000	0.543426	0.179874	0.473367
2437.2	0.312000	0.543174	0.169470	0.445988
2437.3	0.308000	0.542865	0.167202	0.440020
2437.4	0.305000	0.542517	0.165468	0.435455
2437.5	0.301000	0.542170	0.163193	0.429469
2437.6	0.297000	0.541822	0.160921	0.423490
2437.7	0.282000	0.541475	0.152696	0.401844
2437.8	0.273000	0.541127	0.147728	0.388769
2437.9	0.266000	0.540842	0.143864	0.378601
2438.0	0.259000	0.540591	0.140013	0.368467
2438.1	0.255000	0.540449	0.137814	0.362681
2438.2	0.250000	0.540307	0.135077	0.355476
2438.3	0.245000	0.540165	0.132340	0.348275
2438.4	0.240000	0.540023	0.129606	0.341078

2438.5	0.222000	0.539881	0.119854	0.315414
2438.6	0.218000	0.539739	0.117663	0.309650
2438.7	0.217000	0.539597	0.117093	0.308148
2438.8	0.217000	0.539455	0.117062	0.308067
2438.9	0.204000	0.539314	0.110020	0.289535
2439.0	0.193000	0.539172	0.104060	0.273851
2439.1	0.192000	0.539070	0.103502	0.272381
2439.2	0.188000	0.538969	0.101326	0.266656
2439.3	0.182000	0.538868	0.098074	0.258097
2439.4	0.177000	0.538767	0.095362	0.250960
2439.5	0.172000	0.538666	0.092651	0.243825
2439.6	0.166000	0.538565	0.089402	0.235275
2439.7	0.158000	0.538463	0.085077	0.223894
2439.8	0.151000	0.538362	0.081293	0.213935
2439.9	0.147000	0.538260	0.079124	0.208228
2440.0	0.144000	0.538159	0.077495	0.203940
2440.1	0.140000	0.538389	0.075374	0.198360
2440.2	0.137000	0.538618	0.073791	0.194192
2440.3	0.130000	0.538847	0.070050	0.184348
2440.4	0.130000	0.539077	0.070080	0.184427
2440.5	0.129000	0.539306	0.069571	0.183086
2440.6	0.126000	0.539536	0.067982	0.178904
2440.7	0.123000	0.539765	0.066391	0.174719
2440.8	0.120000	0.539995	0.064799	0.170530
2440.9	0.118000	0.540224	0.063746	0.167759
2441.0	0.116000	0.540454	0.062693	0.164986
2441.1	0.112000	0.540673	0.060555	0.159361
2441.2	0.106000	0.540891	0.057334	0.150885
2441.3	0.102000	0.541110	0.055193	0.145250
2441.4	0.100000	0.541328	0.054133	0.142459
2441.5	0.100000	0.541546	0.054155	0.142517
2441.6	0.100000	0.541765	0.054176	0.142574
2441.7	0.100000	0.541983	0.054198	0.142632
2441.8	0.090000	0.541644	0.048748	0.128288
2441.9	0.083000	0.541862	0.044975	0.118358
2442.0	0.082000	0.542080	0.044451	0.116979
2442.1	0.080000	0.542233	0.043379	0.114158
2442.2	0.078000	0.542387	0.042306	0.111335
2442.3	0.077000	0.542540	0.041776	0.109939
2442.4	0.076000	0.542694	0.041245	0.108542
2442.5	0.074000	0.542847	0.040171	0.105716
2442.6	0.073000	0.543001	0.039639	0.104317
2442.7	0.071000	0.543154	0.038564	0.101487

2442.8	0.069000	0.543308	0.037488	0.098656
2442.9	0.069000	0.543461	0.037499	0.098684
2443.0	0.067000	0.543615	0.036422	0.095851
2443.1	0.065000	0.543762	0.035345	0.093015
2443.2	0.064000	0.543908	0.034810	0.091608
2443.3	0.064000	0.544055	0.034819	0.091633
2443.4	0.062000	0.544201	0.033740	0.088793
2443.5	0.061000	0.544347	0.033205	0.087385
2443.6	0.059000	0.544494	0.032125	0.084543
2443.7	0.056000	0.544641	0.030500	0.080265
2443.8	0.053000	0.545148	0.028893	0.076036
2443.9	0.053000	0.545489	0.028911	0.076084
2444.0	0.053000	0.545636	0.028919	0.076104
2444.1	0.051000	0.545561	0.027824	0.073222
2444.2	0.049000	0.545487	0.026729	0.070341
2444.3	0.048000	0.545412	0.026180	0.068896
2444.4	0.047000	0.545338	0.025631	0.067452
2444.5	0.046000	0.545264	0.025082	0.066008
2444.6	0.045000	0.545189	0.024534	0.064564
2444.7	0.043000	0.545115	0.023440	0.061686
2444.8	0.043000	0.545040	0.023437	0.061678
2444.9	0.043000	0.544966	0.023434	0.061669
2445.0	0.042000	0.544891	0.022885	0.060227
2445.1	0.039000	0.544268	0.021226	0.055861
2445.2	0.038000	0.544206	0.020680	0.054422
2445.3	0.037000	0.544144	0.020133	0.052984
2445.4	0.036000	0.544081	0.019587	0.051546
2445.5	0.035000	0.544019	0.019041	0.050109
2445.6	0.034000	0.543957	0.018495	0.048671
2445.7	0.032000	0.543546	0.017393	0.045774
2445.8	0.031000	0.543279	0.016842	0.044321
2445.9	0.031000	0.543216	0.016840	0.044316
2446.0	0.029000	0.543154	0.015751	0.041453
2446.1	0.027000	0.543294	0.014669	0.038604
2446.2	0.027000	0.543434	0.014673	0.038614
2446.3	0.027000	0.543574	0.014677	0.038624
2446.4	0.027000	0.543714	0.014680	0.038634
2446.5	0.027000	0.543855	0.014684	0.038644
2446.6	0.027000	0.543995	0.014688	0.038653
2446.7	0.027000	0.544135	0.014692	0.038663
2446.8	0.026000	0.544275	0.014151	0.037241
2446.9	0.025000	0.544415	0.013610	0.035818
2447.0	0.024000	0.544555	0.013069	0.034394

2447.1	0.024000	0.544658	0.013072	0.034401
2447.2	0.024000	0.545100	0.013082	0.034428
2447.3	0.024000	0.545420	0.013090	0.034449
2447.4	0.024000	0.545524	0.013093	0.034455
2447.5	0.023000	0.545627	0.012549	0.033026
2447.6	0.022000	0.545731	0.012006	0.031596
2447.7	0.021000	0.545834	0.011463	0.030165
2447.8	0.021000	0.545938	0.011465	0.030171
2447.9	0.021000	0.546041	0.011467	0.030177
2448.0	0.021000	0.546145	0.011469	0.030183
2448.1	0.020000	0.546060	0.010921	0.028741
2448.2	0.020000	0.545974	0.010919	0.028736
2448.3	0.020000	0.545889	0.010918	0.028732
2448.4	0.020000	0.545242	0.010905	0.028698
2448.5	0.020000	0.545156	0.010903	0.028693
2448.6	0.020000	0.545071	0.010901	0.028689
2448.7	0.019000	0.544986	0.010355	0.027250
2448.8	0.019000	0.544900	0.010353	0.027246
2448.9	0.019000	0.544815	0.010351	0.027242
2449.0	0.018000	0.544730	0.009805	0.025804
2449.1	0.018000	0.544599	0.009803	0.025798
2449.2	0.018000	0.544467	0.009800	0.025791
2449.3	0.017000	0.544336	0.009254	0.024353
2449.4	0.016000	0.544205	0.008707	0.022915
2449.5	0.016000	0.544073	0.008705	0.022909
2449.6	0.017000	0.543942	0.009247	0.024335
2449.7	0.018000	0.543811	0.009789	0.025760
2449.8	0.017000	0.543680	0.009243	0.024323
2449.9	0.016000	0.543549	0.008697	0.022887
2450.0	0.016000	0.543418	0.008695	0.022881
2450.1	0.016000	0.543206	0.008691	0.022873
2450.2	0.016000	0.542994	0.008688	0.022864
2450.3	0.016000	0.542782	0.008685	0.022855
2450.4	0.016000	0.542571	0.008681	0.022846
2450.5	0.016000	0.542359	0.008678	0.022837
2450.6	0.015000	0.542148	0.008132	0.021401
2450.7	0.015000	0.541936	0.008129	0.021393
2450.8	0.015000	0.541725	0.008126	0.021385
2450.9	0.015000	0.541513	0.008123	0.021376
2451.0	0.015000	0.541302	0.008120	0.021368
2451.1	0.014000	0.541111	0.007576	0.019936
2451.2	0.013000	0.540919	0.007032	0.018506
2451.3	0.014000	0.540727	0.007570	0.019922

2451.4	0.014000	0.540536	0.007568	0.019915
2451.5	0.013000	0.540345	0.007024	0.018486
2451.6	0.011000	0.540153	0.005942	0.015637
2451.7	0.011000	0.539962	0.005940	0.015631
2451.8	0.011000	0.539770	0.005937	0.015625
2451.9	0.011000	0.539579	0.005935	0.015620
2452.0	0.011000	0.539388	0.005933	0.015614
2452.1	0.011000	0.539472	0.005934	0.015617
2452.2	0.011000	0.539556	0.005935	0.015619
2452.3	0.011000	0.539640	0.005936	0.015622
2452.4	0.010000	0.539724	0.005397	0.014204
2452.5	0.010000	0.539808	0.005398	0.014206
2452.6	0.010000	0.539892	0.005399	0.014208
2452.7	0.010000	0.539419	0.005394	0.014196
2452.8	0.010000	0.539503	0.005395	0.014198
2452.9	0.010000	0.539586	0.005396	0.014200
2453.0	0.010000	0.539670	0.005397	0.014202
2453.1	0.010000	0.539791	0.005398	0.014205
2453.2	0.010000	0.539912	0.005399	0.014209
2453.3	0.010000	0.540033	0.005400	0.014212
2453.4	0.010000	0.540154	0.005402	0.014215
2453.5	0.011000	0.540275	0.005943	0.015640
2453.6	0.011000	0.540395	0.005944	0.015644
2453.7	0.010000	0.540517	0.005405	0.014225
2453.8	0.010000	0.540639	0.005406	0.014228
2453.9	0.010000	0.540760	0.005408	0.014231
2454.0	0.010000	0.540871	0.005409	0.014234
2454.1	0.010000	0.540822	0.005408	0.014233
2454.2	0.010000	0.540773	0.005408	0.014231
2454.3	0.010000	0.540724	0.005407	0.014230
2454.4	0.010000	0.540674	0.005407	0.014229
2454.5	0.010000	0.540625	0.005406	0.014227
2454.6	0.010000	0.540585	0.005406	0.014226
2454.7	0.010000	0.540630	0.005406	0.014228
2454.8	0.010000	0.540675	0.005407	0.014229
2454.9	0.010000	0.540720	0.005407	0.014230
2455.0	0.010000	0.540765	0.005408	0.014231
2455.1	0.010000	0.540758	0.005408	0.014231
2455.2	0.010000	0.540750	0.005408	0.014231
2455.3	0.010000	0.540743	0.005407	0.014231
2455.4	0.010000	0.540735	0.005407	0.014230
2455.5	0.011000	0.540727	0.005948	0.015653
2455.6	0.011000	0.540720	0.005948	0.015653

2455.7	0.011000	0.540712	0.005948	0.015653
2455.8	0.011000	0.540704	0.005948	0.015652
2455.9	0.011000	0.540696	0.005948	0.015652
2456.0	0.011000	0.540688	0.005948	0.015652
2456.1	0.011000	0.540535	0.005946	0.015648
2456.2	0.011000	0.540382	0.005944	0.015643
2456.3	0.011000	0.540229	0.005943	0.015639
2456.4	0.011000	0.540076	0.005941	0.015634
2456.5	0.011000	0.539923	0.005939	0.015630
2456.6	0.011000	0.539770	0.005937	0.015625
2456.7	0.010000	0.539617	0.005396	0.014201
2456.8	0.009000	0.539464	0.004855	0.012777
2456.9	0.008000	0.539311	0.004314	0.011354
2457.0	0.008000	0.539158	0.004313	0.011351
2457.1	0.008000	0.538972	0.004312	0.011347
2457.2	0.007000	0.538786	0.003772	0.009925
2457.3	0.005000	0.538600	0.002693	0.007087
2457.4	0.006000	0.538414	0.003230	0.008502
2457.5	0.006000	0.538228	0.003229	0.008499
2457.6	0.006000	0.538042	0.003228	0.008496
2457.7	0.005000	0.537856	0.002689	0.007077
2457.8	0.004000	0.537670	0.002151	0.005660
2457.9	0.004000	0.537484	0.002150	0.005658
2458.0	0.004000	0.537299	0.002149	0.005656
2458.1	0.005000	0.537284	0.002686	0.007070
2458.2	0.005000	0.537269	0.002686	0.007070
2458.3	0.004000	0.537254	0.002149	0.005655
2458.4	0.004000	0.537240	0.002149	0.005655
2458.5	0.004000	0.537225	0.002149	0.005655
2458.6	0.004000	0.537210	0.002149	0.005655
2458.7	0.004000	0.537750	0.002151	0.005661
2458.8	0.004000	0.537735	0.002151	0.005661
2458.9	0.004000	0.537721	0.002151	0.005660
2459.0	0.005000	0.537706	0.002689	0.007075
2459.1	0.006000	0.537699	0.003226	0.008490
2459.2	0.006000	0.537692	0.003226	0.008490
2459.3	0.006000	0.537685	0.003226	0.008490
2459.4	0.006000	0.537678	0.003226	0.008490
2459.5	0.006000	0.537671	0.003226	0.008490
2459.6	0.006000	0.537665	0.003226	0.008490
2459.7	0.006000	0.537657	0.003226	0.008490
2459.8	0.006000	0.537650	0.003226	0.008489
2459.9	0.006000	0.537643	0.003226	0.008489

2460.0	0.006000	0.537637	0.003226	0.008489
2460.1	0.006000	0.537717	0.003226	0.008491
2460.2	0.006000	0.537797	0.003227	0.008492
2460.3	0.006000	0.537878	0.003227	0.008493
2460.4	0.006000	0.537958	0.003228	0.008494
2460.5	0.006000	0.538038	0.003228	0.008496
2460.6	0.006000	0.538118	0.003229	0.008497
2460.7	0.006000	0.538199	0.003229	0.008498
2460.8	0.006000	0.538279	0.003230	0.008499
2460.9	0.006000	0.538359	0.003230	0.008501
2461.0	0.006000	0.538440	0.003231	0.008502
2461.1	0.006000	0.538531	0.003231	0.008503
2461.2	0.006000	0.538622	0.003232	0.008505
2461.3	0.007000	0.538714	0.003771	0.009924
2461.4	0.008000	0.538805	0.004310	0.011344
2461.5	0.008000	0.538896	0.004311	0.011346
2461.6	0.008000	0.538987	0.004312	0.011347
2461.7	0.008000	0.539078	0.004313	0.011349
2461.8	0.008000	0.539170	0.004313	0.011351
2461.9	0.008000	0.539261	0.004314	0.011353
2462.0	0.008000	0.539352	0.004315	0.011355
2462.1	0.008000	0.539186	0.004313	0.011352
2462.2	0.008000	0.539020	0.004312	0.011348
2462.3	0.008000	0.538854	0.004311	0.011345
2462.4	0.008000	0.538688	0.004310	0.011341
2462.5	0.008000	0.538522	0.004308	0.011338
2462.6	0.008000	0.538356	0.004307	0.011334
2462.7	0.008000	0.538190	0.004306	0.011331
2462.8	0.008000	0.538024	0.004304	0.011327
2462.9	0.007000	0.537858	0.003765	0.009908
2463.0	0.006000	0.537692	0.003226	0.008490
2463.1	0.006000	0.537504	0.003225	0.008487
2463.2	0.006000	0.537316	0.003224	0.008484
2463.3	0.006000	0.537129	0.003223	0.008481
2463.4	0.006000	0.536941	0.003222	0.008478
2463.5	0.006000	0.536753	0.003221	0.008475
2463.6	0.005000	0.536565	0.002683	0.007060
2463.7	0.004000	0.536378	0.002146	0.005646
2463.8	0.004000	0.536190	0.002145	0.005644
2463.9	0.003000	0.536003	0.001608	0.004232
2464.0	0.003000	0.535815	0.001607	0.004230
2464.1	0.003000	0.535813	0.001607	0.004230
2464.2	0.003000	0.535258	0.001606	0.004226

2464.3	0.003000	0.535255	0.001606	0.004226
2464.4	0.003000	0.535253	0.001606	0.004226
2464.5	0.003000	0.535251	0.001606	0.004226
2464.6	0.003000	0.535248	0.001606	0.004226
2464.7	0.003000	0.535246	0.001606	0.004226
2464.8	0.003000	0.535244	0.001606	0.004226
2464.9	0.003000	0.535242	0.001606	0.004226
2465.0	0.003000	0.535240	0.001606	0.004226
2465.1	0.003000	0.535244	0.001606	0.004226
2465.2	0.003000	0.535249	0.001606	0.004226
2465.3	0.003000	0.535253	0.001606	0.004226
2465.4	0.004000	0.535258	0.002141	0.005634
2465.5	0.006000	0.535263	0.003212	0.008452
2465.6	0.006000	0.535267	0.003212	0.008452
2465.7	0.006000	0.535272	0.003212	0.008452
2465.8	0.006000	0.535277	0.003212	0.008452
2465.9	0.006000	0.535281	0.003212	0.008452
2466.0	0.006000	0.535286	0.003212	0.008452
2466.1	0.006000	0.535334	0.003212	0.008453
2466.2	0.006000	0.535381	0.003212	0.008454
2466.3	0.006000	0.535429	0.003213	0.008454
2466.4	0.005000	0.535476	0.002677	0.007046
2466.5	0.006000	0.535524	0.003213	0.008456
2466.6	0.007000	0.535572	0.003749	0.009866
2466.7	0.007000	0.535619	0.003749	0.009867
2466.8	0.007000	0.535667	0.003750	0.009868
2466.9	0.007000	0.535715	0.003750	0.009869
2467.0	0.007000	0.535763	0.003750	0.009870
2467.1	0.008000	0.535818	0.004287	0.011281
2467.2	0.007000	0.535874	0.003751	0.009872
2467.3	0.007000	0.535930	0.003752	0.009873
2467.4	0.008000	0.535985	0.004288	0.011284
2467.5	0.008000	0.536041	0.004288	0.011285
2467.6	0.008000	0.536097	0.004289	0.011287
2467.7	0.008000	0.536153	0.004289	0.011288
2467.8	0.008000	0.536209	0.004290	0.011289
2467.9	0.008000	0.536264	0.004290	0.011290
2468.0	0.008000	0.536320	0.004291	0.011291
2468.1	0.008000	0.536210	0.004290	0.011289
2468.2	0.008000	0.536099	0.004289	0.011287
2468.3	0.008000	0.535989	0.004288	0.011284
2468.4	0.008000	0.535879	0.004287	0.011282
2468.5	0.008000	0.535768	0.004286	0.011280

2468.6	0.008000	0.535876	0.004287	0.011282
2468.7	0.007000	0.536092	0.003753	0.009876
2468.8	0.006000	0.535982	0.003216	0.008463
2468.9	0.005000	0.535318	0.002677	0.007044
2469.0	0.005000	0.535207	0.002676	0.007042
2469.1	0.004000	0.535086	0.002140	0.005633
2469.2	0.003000	0.534966	0.001605	0.004224
2469.3	0.003000	0.534845	0.001605	0.004223
2469.4	0.003000	0.534724	0.001604	0.004222
2469.5	0.003000	0.534604	0.001604	0.004221
2469.6	0.003000	0.534483	0.001603	0.004220
2469.7	0.003000	0.534362	0.001603	0.004219
2469.8	0.003000	0.534241	0.001603	0.004218
2469.9	0.003000	0.534120	0.001602	0.004217
2470.0	0.003000	0.533999	0.001602	0.004216
2470.1	0.003000	0.534127	0.001602	0.004217
2470.2	0.003000	0.534254	0.001603	0.004218
2470.3	0.003000	0.534382	0.001603	0.004219
2470.4	0.003000	0.534509	0.001604	0.004220
2470.5	0.003000	0.534636	0.001604	0.004221
2470.6	0.004000	0.534764	0.002139	0.005629
2470.7	0.004000	0.534891	0.002140	0.005631
2470.8	0.004000	0.535018	0.002140	0.005632
2470.9	0.004000	0.535146	0.002141	0.005633
2471.0	0.004000	0.535273	0.002141	0.005635
2471.1	0.004000	0.535419	0.002142	0.005636
2471.2	0.004000	0.535564	0.002142	0.005638
2471.3	0.004000	0.535710	0.002143	0.005639
2471.4	0.004000	0.535855	0.002143	0.005641
2471.5	0.004000	0.536001	0.002144	0.005642
2471.6	0.004000	0.536146	0.002145	0.005644
2471.7	0.005000	0.536292	0.002681	0.007057
2471.8	0.006000	0.536437	0.003219	0.008470
2471.9	0.006000	0.536583	0.003219	0.008473
2472.0	0.005000	0.536728	0.002684	0.007062
2472.1	0.005000	0.537191	0.002686	0.007069
2472.2	0.007000	0.537795	0.003765	0.009907
2472.3	0.008000	0.538056	0.004304	0.011328
2472.4	0.008000	0.538316	0.004307	0.011333
2472.5	0.008000	0.538577	0.004309	0.011339
2472.6	0.008000	0.538838	0.004311	0.011344
2472.7	0.009000	0.539099	0.004852	0.012769
2472.8	0.010000	0.539360	0.005394	0.014194

2472.9	0.011000	0.539620	0.005936	0.015621
2473.0	0.010000	0.539881	0.005399	0.014208
2473.1	0.009000	0.540114	0.004861	0.012793
2473.2	0.009000	0.539789	0.004858	0.012785
2473.3	0.009000	0.540021	0.004860	0.012790
2473.4	0.009000	0.540253	0.004862	0.012796
2473.5	0.010000	0.540486	0.005405	0.014224
2473.6	0.009000	0.540718	0.004866	0.012807
2473.7	0.008000	0.540950	0.004328	0.011389
2473.8	0.009000	0.541183	0.004871	0.012818
2473.9	0.010000	0.541416	0.005414	0.014248
2474.0	0.010000	0.541648	0.005416	0.014254
2474.1	0.009000	0.541504	0.004874	0.012825
2474.2	0.008000	0.541360	0.004331	0.011397
2474.3	0.008000	0.541216	0.004330	0.011394
2474.4	0.008000	0.541072	0.004329	0.011391
2474.5	0.008000	0.540929	0.004327	0.011388
2474.6	0.008000	0.540785	0.004326	0.011385
2474.7	0.008000	0.540641	0.004325	0.011382
2474.8	0.008000	0.540497	0.004324	0.011379
2474.9	0.008000	0.540353	0.004323	0.011376
2475.0	0.008000	0.540210	0.004322	0.011373
2475.1	0.008000	0.540027	0.004320	0.011369
2475.2	0.007000	0.539845	0.003779	0.009945
2475.3	0.006000	0.539662	0.003238	0.008521
2475.4	0.005000	0.539480	0.002697	0.007099
2475.5	0.006000	0.539297	0.003236	0.008515
2475.6	0.005000	0.539115	0.002696	0.007094
2475.7	0.006000	0.538932	0.003234	0.008510
2475.8	0.006000	0.538750	0.003232	0.008507
2475.9	0.005000	0.538567	0.002693	0.007087
2476.0	0.004000	0.538385	0.002154	0.005667
2476.1	0.004000	0.538284	0.002153	0.005666
2476.2	0.004000	0.538183	0.002153	0.005665
2476.3	0.004000	0.538081	0.002152	0.005664
2476.4	0.004000	0.537980	0.002152	0.005663
2476.5	0.004000	0.537879	0.002152	0.005662
2476.6	0.004000	0.537777	0.002151	0.005661
2476.7	0.004000	0.537676	0.002151	0.005660
2476.8	0.004000	0.537575	0.002150	0.005659
2476.9	0.004000	0.537473	0.002150	0.005658
2477.0	0.004000	0.537372	0.002149	0.005657
2477.1	0.004000	0.537278	0.002149	0.005656

2477.2	0.004000	0.537184	0.002149	0.005655
2477.3	0.004000	0.537090	0.002148	0.005654
2477.4	0.004000	0.536996	0.002148	0.005653
2477.5	0.004000	0.536902	0.002148	0.005652
2477.6	0.004000	0.536808	0.002147	0.005651
2477.7	0.004000	0.536714	0.002147	0.005650
2477.8	0.004000	0.536620	0.002146	0.005649
2477.9	0.004000	0.536526	0.002146	0.005648
2478.0	0.004000	0.536432	0.002146	0.005647
2478.1	0.004000	0.536602	0.002146	0.005649
2478.2	0.004000	0.536771	0.002147	0.005650
2478.3	0.004000	0.536941	0.002148	0.005652
2478.4	0.004000	0.537111	0.002148	0.005654
2478.5	0.004000	0.537281	0.002149	0.005656
2478.6	0.004000	0.537450	0.002150	0.005658
2478.7	0.004000	0.537620	0.002150	0.005659
2478.8	0.004000	0.537789	0.002151	0.005661
2478.9	0.004000	0.537959	0.002152	0.005663
2479.0	0.004000	0.538129	0.002153	0.005665
2479.1	0.004000	0.538334	0.002153	0.005667
2479.2	0.004000	0.538540	0.002154	0.005669
2479.3	0.004000	0.538745	0.002155	0.005671
2479.4	0.004000	0.538951	0.002156	0.005673
2479.5	0.004000	0.539156	0.002157	0.005676
2479.6	0.004000	0.539362	0.002157	0.005678
2479.7	0.004000	0.539568	0.002158	0.005680
2479.8	0.004000	0.539773	0.002159	0.005682
2479.9	0.004000	0.539979	0.002160	0.005684
2480.0	0.004000	0.540184	0.002161	0.005686
2480.1	0.005000	0.540196	0.002701	0.007108
2480.2	0.005000	0.540208	0.002701	0.007108
2480.3	0.004000	0.540220	0.002161	0.005687
2480.4	0.004000	0.540232	0.002161	0.005687
2480.5	0.004000	0.540244	0.002161	0.005687
2480.6	0.004000	0.540256	0.002161	0.005687
2480.7	0.004000	0.540268	0.002161	0.005687
2480.8	0.003000	0.540280	0.001621	0.004265
2480.9	0.003000	0.540291	0.001621	0.004266
2481.0	0.003000	0.540303	0.001621	0.004266
2481.1	0.003000	0.540308	0.001621	0.004266
2481.2	0.003000	0.540313	0.001621	0.004266
2481.3	0.003000	0.540319	0.001621	0.004266
2481.4	0.002000	0.540324	0.001081	0.002844

2481.5	0.001000	0.540329	0.000540	0.001422
2481.6	0.000000	0.540334	0.000000	0.000000
CHANNEL 18				
Wavenumber	HIRS Filter Transmittance	Optical Element Transmittance	Product of the HIRS Filter and Optical Element Transmittances	Normalized Value of Column 4
2450.1	0.000127	0.543206	0.000069	0.000168
2450.2	0.000248	0.542994	0.000135	0.000328
2450.3	0.000363	0.542782	0.000197	0.000480
2450.4	0.000472	0.542571	0.000256	0.000624
2450.5	0.000575	0.542359	0.000312	0.000760
2450.6	0.000672	0.542148	0.000365	0.000888
2450.7	0.000763	0.541936	0.000414	0.001008
2450.8	0.000848	0.541725	0.000460	0.001119
2450.9	0.000927	0.541513	0.000502	0.001223
2451.0	0.001000	0.541302	0.000541	0.001319
2451.1	0.001040	0.541111	0.000563	0.001370
2451.2	0.001079	0.540919	0.000584	0.001422
2451.3	0.001119	0.540727	0.000605	0.001474
2451.4	0.001159	0.540536	0.000626	0.001526
2451.5	0.001198	0.540345	0.000647	0.001577
2451.6	0.001238	0.540153	0.000669	0.001629
2451.7	0.001278	0.539962	0.000690	0.001680
2451.8	0.001317	0.539770	0.000711	0.001732
2451.9	0.001357	0.539579	0.000732	0.001783
2452.0	0.001397	0.539388	0.000753	0.001835
2452.1	0.001436	0.539472	0.000775	0.001887
2452.2	0.001476	0.539556	0.000796	0.001940
2452.3	0.001515	0.539640	0.000818	0.001992
2452.4	0.001555	0.539724	0.000839	0.002045
2452.5	0.001595	0.539808	0.000861	0.002097
2452.6	0.001634	0.539892	0.000882	0.002150
2452.7	0.001674	0.539419	0.000903	0.002200
2452.8	0.001714	0.539503	0.000925	0.002252
2452.9	0.001753	0.539586	0.000946	0.002305
2453.0	0.001793	0.539670	0.000968	0.002357
2453.1	0.001833	0.539791	0.000989	0.002410
2453.2	0.001872	0.539912	0.001011	0.002462
2453.3	0.001912	0.540033	0.001032	0.002515
2453.4	0.001951	0.540154	0.001054	0.002568
2453.5	0.001991	0.540275	0.001076	0.002621
2453.6	0.002031	0.540395	0.001097	0.002673

2453.7	0.002070	0.540517	0.001119	0.002726
2453.8	0.002110	0.540639	0.001141	0.002779
2453.9	0.002150	0.540760	0.001163	0.002832
2454.0	0.002189	0.540871	0.001184	0.002885
2454.1	0.002229	0.540822	0.001206	0.002937
2454.2	0.002269	0.540773	0.001227	0.002989
2454.3	0.002308	0.540724	0.001248	0.003041
2454.4	0.002348	0.540674	0.001270	0.003093
2454.5	0.002388	0.540625	0.001291	0.003145
2454.6	0.002427	0.540585	0.001312	0.003197
2454.7	0.002467	0.540630	0.001334	0.003249
2454.8	0.002507	0.540675	0.001355	0.003302
2454.9	0.002546	0.540720	0.001377	0.003354
2455.0	0.002586	0.540765	0.001398	0.003407
2455.1	0.002626	0.540758	0.001420	0.003459
2455.2	0.002665	0.540750	0.001441	0.003511
2455.3	0.002705	0.540743	0.001463	0.003563
2455.4	0.002745	0.540735	0.001484	0.003615
2455.5	0.002784	0.540727	0.001505	0.003667
2455.6	0.002824	0.540720	0.001527	0.003720
2455.7	0.002863	0.540712	0.001548	0.003772
2455.8	0.002903	0.540704	0.001570	0.003824
2455.9	0.002943	0.540696	0.001591	0.003876
2456.0	0.002982	0.540688	0.001613	0.003928
2456.1	0.003022	0.540535	0.001633	0.003979
2456.2	0.003062	0.540382	0.001654	0.004030
2456.3	0.003101	0.540229	0.001675	0.004081
2456.4	0.003141	0.540076	0.001696	0.004133
2456.5	0.003181	0.539923	0.001717	0.004183
2456.6	0.003220	0.539770	0.001738	0.004234
2456.7	0.003260	0.539617	0.001759	0.004285
2456.8	0.003300	0.539464	0.001780	0.004336
2456.9	0.003339	0.539311	0.001801	0.004387
2457.0	0.003379	0.539158	0.001822	0.004438
2457.1	0.003419	0.538972	0.001842	0.004488
2457.2	0.003458	0.538786	0.001863	0.004539
2457.3	0.003498	0.538600	0.001884	0.004589
2457.4	0.003537	0.538414	0.001905	0.004640
2457.5	0.003577	0.538228	0.001925	0.004690
2457.6	0.003617	0.538042	0.001946	0.004740
2457.7	0.003656	0.537856	0.001967	0.004791
2457.8	0.003696	0.537670	0.001987	0.004841
2457.9	0.003736	0.537484	0.002008	0.004891

2458.0	0.003775	0.537299	0.002028	0.004941
2458.1	0.003815	0.537284	0.002050	0.004993
2458.2	0.003855	0.537269	0.002071	0.005045
2458.3	0.003894	0.537254	0.002092	0.005097
2458.4	0.003934	0.537240	0.002113	0.005149
2458.5	0.003974	0.537225	0.002135	0.005200
2458.6	0.004013	0.537210	0.002156	0.005252
2458.7	0.004053	0.537750	0.002179	0.005309
2458.8	0.004092	0.537735	0.002201	0.005361
2458.9	0.004132	0.537721	0.002222	0.005413
2459.0	0.004172	0.537706	0.002243	0.005465
2459.1	0.004212	0.537699	0.002265	0.005517
2459.2	0.004251	0.537692	0.002286	0.005568
2459.3	0.004291	0.537685	0.002307	0.005620
2459.4	0.004330	0.537678	0.002328	0.005672
2459.5	0.004370	0.537671	0.002350	0.005724
2459.6	0.004410	0.537665	0.002371	0.005776
2459.7	0.004449	0.537657	0.002392	0.005828
2459.8	0.004489	0.537650	0.002414	0.005879
2459.9	0.004529	0.537643	0.002435	0.005931
2460.0	0.004568	0.537637	0.002456	0.005983
2460.1	0.004608	0.537717	0.002478	0.006036
2460.2	0.004648	0.537797	0.002499	0.006089
2460.3	0.004687	0.537878	0.002521	0.006142
2460.4	0.004727	0.537958	0.002543	0.006195
2460.5	0.004766	0.538038	0.002565	0.006247
2460.6	0.004806	0.538118	0.002586	0.006300
2460.7	0.004846	0.538199	0.002608	0.006353
2460.8	0.004886	0.538279	0.002630	0.006406
2460.9	0.004925	0.538359	0.002651	0.006459
2461.0	0.004965	0.538440	0.002673	0.006512
2461.1	0.005004	0.538531	0.002695	0.006565
2461.2	0.005044	0.538622	0.002717	0.006618
2461.3	0.005084	0.538714	0.002739	0.006672
2461.4	0.005123	0.538805	0.002760	0.006725
2461.5	0.005163	0.538896	0.002782	0.006778
2461.6	0.005203	0.538987	0.002804	0.006831
2461.7	0.005242	0.539078	0.002826	0.006884
2461.8	0.005282	0.539170	0.002848	0.006938
2461.9	0.005322	0.539261	0.002870	0.006991
2462.0	0.005361	0.539352	0.002892	0.007044
2462.1	0.005401	0.539186	0.002912	0.007094
2462.2	0.005441	0.539020	0.002933	0.007144

2462.3	0.005480	0.538854	0.002953	0.007194
2462.4	0.005520	0.538688	0.002973	0.007244
2462.5	0.005560	0.538522	0.002994	0.007293
2462.6	0.005599	0.538356	0.003014	0.007343
2462.7	0.005639	0.538190	0.003035	0.007393
2462.8	0.005678	0.538024	0.003055	0.007442
2462.9	0.005718	0.537858	0.003076	0.007492
2463.0	0.005758	0.537692	0.003096	0.007542
2463.1	0.005797	0.537504	0.003116	0.007591
2463.2	0.005837	0.537316	0.003136	0.007640
2463.3	0.005877	0.537129	0.003157	0.007690
2463.4	0.005916	0.536941	0.003177	0.007739
2463.5	0.005956	0.536753	0.003197	0.007788
2463.6	0.005996	0.536565	0.003217	0.007837
2463.7	0.006035	0.536378	0.003237	0.007886
2463.8	0.006075	0.536190	0.003257	0.007935
2463.9	0.006115	0.536003	0.003277	0.007984
2464.0	0.006154	0.535815	0.003298	0.008033
2464.1	0.006194	0.535813	0.003319	0.008085
2464.2	0.006234	0.535258	0.003337	0.008128
2464.3	0.006273	0.535255	0.003358	0.008180
2464.4	0.006313	0.535253	0.003379	0.008231
2464.5	0.006352	0.535251	0.003400	0.008283
2464.6	0.006392	0.535248	0.003421	0.008335
2464.7	0.006432	0.535246	0.003443	0.008386
2464.8	0.006471	0.535244	0.003464	0.008438
2464.9	0.006511	0.535242	0.003485	0.008490
2465.0	0.006551	0.535240	0.003506	0.008541
2465.1	0.006590	0.535244	0.003527	0.008593
2465.2	0.006630	0.535249	0.003549	0.008645
2465.3	0.006670	0.535253	0.003570	0.008697
2465.4	0.006709	0.535258	0.003591	0.008748
2465.5	0.006749	0.535263	0.003612	0.008800
2465.6	0.006789	0.535267	0.003634	0.008852
2465.7	0.006828	0.535272	0.003655	0.008904
2465.8	0.006868	0.535277	0.003676	0.008955
2465.9	0.006907	0.535281	0.003697	0.009007
2466.0	0.006947	0.535286	0.003719	0.009059
2466.1	0.006987	0.535334	0.003740	0.009112
2466.2	0.007026	0.535381	0.003762	0.009164
2466.3	0.007066	0.535429	0.003783	0.009217
2466.4	0.007106	0.535476	0.003805	0.009269
2466.5	0.007145	0.535524	0.003827	0.009322

2466.6	0.007185	0.535572	0.003848	0.009374
2466.7	0.007225	0.535619	0.003870	0.009427
2466.8	0.007264	0.535667	0.003891	0.009479
2466.9	0.007304	0.535715	0.003913	0.009532
2467.0	0.007337	0.535763	0.003931	0.009575
2467.1	0.007369	0.535818	0.003949	0.009619
2467.2	0.007402	0.535874	0.003967	0.009663
2467.3	0.007436	0.535930	0.003985	0.009708
2467.4	0.007469	0.535985	0.004003	0.009752
2467.5	0.007503	0.536041	0.004022	0.009797
2467.6	0.007537	0.536097	0.004040	0.009843
2467.7	0.007571	0.536153	0.004059	0.009888
2467.8	0.007605	0.536209	0.004078	0.009934
2467.9	0.007639	0.536264	0.004097	0.009980
2468.0	0.007674	0.536320	0.004116	0.010026
2468.1	0.007709	0.536210	0.004134	0.010070
2468.2	0.007744	0.536099	0.004152	0.010114
2468.3	0.007779	0.535989	0.004170	0.010158
2468.4	0.007815	0.535879	0.004188	0.010202
2468.5	0.007851	0.535768	0.004206	0.010247
2468.6	0.007887	0.535876	0.004226	0.010296
2468.7	0.007923	0.536092	0.004247	0.010347
2468.8	0.007959	0.535982	0.004266	0.010392
2468.9	0.007996	0.535318	0.004280	0.010427
2469.0	0.008033	0.535207	0.004299	0.010473
2469.1	0.008070	0.535086	0.004318	0.010519
2469.2	0.008107	0.534966	0.004337	0.010565
2469.3	0.008144	0.534845	0.004356	0.010611
2469.4	0.008182	0.534724	0.004375	0.010658
2469.5	0.008220	0.534604	0.004394	0.010705
2469.6	0.008258	0.534483	0.004414	0.010752
2469.7	0.008296	0.534362	0.004433	0.010800
2469.8	0.008335	0.534241	0.004453	0.010847
2469.9	0.008373	0.534120	0.004472	0.010895
2470.0	0.008412	0.533999	0.004492	0.010943
2470.1	0.008451	0.534127	0.004514	0.010997
2470.2	0.008491	0.534254	0.004536	0.011051
2470.3	0.008530	0.534382	0.004558	0.011105
2470.4	0.008570	0.534509	0.004581	0.011159
2470.5	0.008610	0.534636	0.004603	0.011214
2470.6	0.008650	0.534764	0.004626	0.011269
2470.7	0.008691	0.534891	0.004648	0.011324
2470.8	0.008731	0.535018	0.004671	0.011380

2470.9	0.008772	0.535146	0.004694	0.011436
2471.0	0.008813	0.535273	0.004717	0.011492
2471.1	0.008854	0.535419	0.004741	0.011549
2471.2	0.008896	0.535564	0.004764	0.011606
2471.3	0.008937	0.535710	0.004788	0.011663
2471.4	0.008979	0.535855	0.004811	0.011721
2471.5	0.009021	0.536001	0.004835	0.011779
2471.6	0.009064	0.536146	0.004859	0.011838
2471.7	0.009106	0.536292	0.004883	0.011897
2471.8	0.009149	0.536437	0.004908	0.011956
2471.9	0.009192	0.536583	0.004932	0.012015
2472.0	0.009235	0.536728	0.004957	0.012074
2472.1	0.009278	0.537191	0.004984	0.012142
2472.2	0.009322	0.537795	0.005013	0.012212
2472.3	0.009365	0.538056	0.005039	0.012276
2472.4	0.009409	0.538316	0.005065	0.012339
2472.5	0.009454	0.538577	0.005091	0.012403
2472.6	0.009498	0.538838	0.005118	0.012467
2472.7	0.009542	0.539099	0.005144	0.012532
2472.8	0.009587	0.539360	0.005171	0.012597
2472.9	0.009632	0.539620	0.005198	0.012662
2473.0	0.009678	0.539881	0.005225	0.012728
2473.1	0.009723	0.540114	0.005251	0.012793
2473.2	0.009769	0.539789	0.005273	0.012845
2473.3	0.009814	0.540021	0.005300	0.012911
2473.4	0.009860	0.540253	0.005327	0.012977
2473.5	0.009907	0.540486	0.005354	0.013044
2473.6	0.009953	0.540718	0.005382	0.013111
2473.7	0.010000	0.540950	0.005410	0.013178
2473.8	0.010047	0.541183	0.005437	0.013246
2473.9	0.010094	0.541416	0.005465	0.013313
2474.0	0.010141	0.541648	0.005493	0.013381
2474.1	0.010189	0.541504	0.005517	0.013441
2474.2	0.010237	0.541360	0.005542	0.013500
2474.3	0.010285	0.541216	0.005566	0.013560
2474.4	0.010333	0.541072	0.005591	0.013620
2474.5	0.010381	0.540929	0.005615	0.013679
2474.6	0.010430	0.540785	0.005640	0.013740
2474.7	0.010479	0.540641	0.005665	0.013801
2474.8	0.010528	0.540497	0.005690	0.013862
2474.9	0.010577	0.540353	0.005715	0.013923
2475.0	0.010626	0.540210	0.005740	0.013984
2475.1	0.010676	0.540027	0.005765	0.014045

2475.2	0.010726	0.539845	0.005790	0.014106
2475.3	0.010776	0.539662	0.005815	0.014167
2475.4	0.010826	0.539480	0.005840	0.014228
2475.5	0.010877	0.539297	0.005866	0.014290
2475.6	0.010927	0.539115	0.005891	0.014351
2475.7	0.010978	0.538932	0.005916	0.014413
2475.8	0.011029	0.538750	0.005942	0.014475
2475.9	0.011081	0.538567	0.005968	0.014538
2476.0	0.011132	0.538385	0.005993	0.014600
2476.1	0.011184	0.538284	0.006020	0.014666
2476.2	0.011236	0.538183	0.006047	0.014731
2476.3	0.011288	0.538081	0.006074	0.014796
2476.4	0.011341	0.537980	0.006101	0.014863
2476.5	0.011393	0.537879	0.006128	0.014928
2476.6	0.011446	0.537777	0.006155	0.014995
2476.7	0.011499	0.537676	0.006183	0.015062
2476.8	0.011552	0.537575	0.006210	0.015128
2476.9	0.011606	0.537473	0.006238	0.015196
2477.0	0.011659	0.537372	0.006265	0.015263
2477.1	0.011713	0.537278	0.006293	0.015331
2477.2	0.011767	0.537184	0.006321	0.015399
2477.3	0.011822	0.537090	0.006349	0.015468
2477.4	0.011876	0.536996	0.006377	0.015536
2477.5	0.011931	0.536902	0.006406	0.015605
2477.6	0.011986	0.536808	0.006434	0.015674
2477.7	0.012041	0.536714	0.006463	0.015743
2477.8	0.012096	0.536620	0.006491	0.015812
2477.9	0.012152	0.536526	0.006520	0.015883
2478.0	0.012208	0.536432	0.006549	0.015953
2478.1	0.012263	0.536602	0.006580	0.016030
2478.2	0.012320	0.536771	0.006613	0.016110
2478.3	0.012376	0.536941	0.006645	0.016188
2478.4	0.012433	0.537111	0.006678	0.016268
2478.5	0.012489	0.537281	0.006710	0.016346
2478.6	0.012547	0.537450	0.006743	0.016427
2478.7	0.012604	0.537620	0.006776	0.016507
2478.8	0.012661	0.537789	0.006809	0.016587
2478.9	0.012719	0.537959	0.006842	0.016668
2479.0	0.012777	0.538129	0.006876	0.016750
2479.1	0.012835	0.538334	0.006910	0.016832
2479.2	0.012893	0.538540	0.006943	0.016915
2479.3	0.012952	0.538745	0.006978	0.016999
2479.4	0.013010	0.538951	0.007012	0.017081

2479.5	0.013069	0.539156	0.007046	0.017165
2479.6	0.013119	0.539362	0.007076	0.017237
2479.7	0.013161	0.539568	0.007101	0.017299
2479.8	0.013199	0.539773	0.007124	0.017356
2479.9	0.013237	0.539979	0.007148	0.017412
2480.0	0.013277	0.540184	0.007172	0.017472
2480.1	0.013325	0.540196	0.007198	0.017535
2480.2	0.013385	0.540208	0.007231	0.017614
2480.3	0.013459	0.540220	0.007271	0.017712
2480.4	0.013553	0.540232	0.007322	0.017836
2480.5	0.013670	0.540244	0.007385	0.017991
2480.6	0.013813	0.540256	0.007463	0.018179
2480.7	0.013980	0.540268	0.007553	0.018400
2480.8	0.014168	0.540280	0.007655	0.018647
2480.9	0.014375	0.540291	0.007767	0.018920
2481.0	0.014598	0.540303	0.007887	0.019214
2481.1	0.014835	0.540308	0.008015	0.019526
2481.2	0.015082	0.540313	0.008149	0.019852
2481.3	0.015337	0.540319	0.008287	0.020187
2481.4	0.015597	0.540324	0.008427	0.020530
2481.5	0.015860	0.540329	0.008570	0.020876
2481.6	0.016123	0.540334	0.008712	0.021223
2481.7	0.016385	0.540339	0.008853	0.021568
2481.8	0.016646	0.540344	0.008995	0.021911
2481.9	0.016907	0.540350	0.009136	0.022255
2482.0	0.017166	0.540355	0.009276	0.022596
2482.1	0.017425	0.540466	0.009418	0.022942
2482.2	0.017681	0.540577	0.009558	0.023284
2482.3	0.017936	0.540689	0.009698	0.023625
2482.4	0.018189	0.540800	0.009837	0.023963
2482.5	0.018440	0.540911	0.009974	0.024298
2482.6	0.018700	0.541022	0.010117	0.024646
2482.7	0.019000	0.541133	0.010282	0.025047
2482.8	0.019300	0.541245	0.010446	0.025447
2482.9	0.019600	0.541356	0.010611	0.025848
2483.0	0.019900	0.541468	0.010775	0.026249
2483.1	0.020300	0.541526	0.010993	0.026780
2483.2	0.020600	0.541583	0.011157	0.027178
2483.3	0.020900	0.541641	0.011320	0.027577
2483.4	0.021271	0.541699	0.011522	0.028070
2483.5	0.021620	0.541756	0.011713	0.028533
2483.6	0.022000	0.541814	0.011920	0.029038
2483.7	0.022300	0.541872	0.012084	0.029437

2483.8	0.022700	0.541929	0.012302	0.029968
2483.9	0.023100	0.541987	0.012520	0.030499
2484.0	0.023500	0.542045	0.012738	0.031031
2484.1	0.023900	0.542015	0.012954	0.031557
2484.2	0.024300	0.541984	0.013170	0.032084
2484.3	0.024700	0.541954	0.013386	0.032610
2484.4	0.025100	0.541924	0.013602	0.033136
2484.5	0.025540	0.541893	0.013840	0.033715
2484.6	0.026000	0.541863	0.014088	0.034320
2484.7	0.026400	0.541833	0.014304	0.034847
2484.8	0.026900	0.541803	0.014574	0.035505
2484.9	0.027400	0.541772	0.014845	0.036162
2485.0	0.027800	0.541742	0.015060	0.036688
2485.1	0.028326	0.541744	0.015345	0.037382
2485.2	0.028800	0.541747	0.015602	0.038008
2485.3	0.029300	0.541749	0.015873	0.038668
2485.4	0.029900	0.541752	0.016198	0.039460
2485.5	0.030400	0.541754	0.016469	0.040121
2485.6	0.030900	0.541757	0.016740	0.040781
2485.7	0.031500	0.541759	0.017065	0.041573
2485.8	0.032100	0.541762	0.017391	0.042365
2485.9	0.032700	0.541764	0.017716	0.043157
2486.0	0.033300	0.541767	0.018041	0.043949
2486.1	0.033900	0.541640	0.018362	0.044730
2486.2	0.034500	0.541513	0.018682	0.045511
2486.3	0.035100	0.541387	0.019003	0.046292
2486.4	0.035800	0.541260	0.019377	0.047204
2486.5	0.036470	0.541133	0.019735	0.048076
2486.6	0.037200	0.541006	0.020125	0.049027
2486.7	0.037800	0.540880	0.020445	0.049806
2486.8	0.038600	0.540753	0.020873	0.050848
2486.9	0.039300	0.540626	0.021247	0.051758
2487.0	0.040000	0.540447	0.021618	0.052663
2487.1	0.040800	0.540258	0.022043	0.053697
2487.2	0.041600	0.540068	0.022467	0.054731
2487.3	0.042338	0.539879	0.022857	0.055682
2487.4	0.043100	0.539689	0.023261	0.056665
2487.5	0.043960	0.539500	0.023716	0.057775
2487.6	0.044800	0.539345	0.024163	0.058862
2487.7	0.045600	0.539247	0.024590	0.059902
2487.8	0.046500	0.539150	0.025070	0.061074
2487.9	0.047400	0.539052	0.025551	0.062244
2488.0	0.048318	0.538954	0.026041	0.063439

2488.1	0.049200	0.539020	0.026520	0.064604
2488.2	0.050200	0.539086	0.027062	0.065925
2488.3	0.051200	0.539152	0.027605	0.067247
2488.4	0.052200	0.539217	0.028147	0.068569
2488.5	0.053190	0.539283	0.028684	0.069877
2488.6	0.054200	0.539348	0.029233	0.071213
2488.7	0.055300	0.539414	0.029830	0.072667
2488.8	0.056400	0.539479	0.030427	0.074122
2488.9	0.057500	0.539545	0.031024	0.075576
2489.0	0.058674	0.539611	0.031661	0.077129
2489.1	0.059900	0.539621	0.032323	0.078742
2489.2	0.061100	0.539631	0.032971	0.080321
2489.3	0.062300	0.539641	0.033620	0.081900
2489.4	0.063600	0.539651	0.034322	0.083610
2489.5	0.064850	0.539661	0.034997	0.085255
2489.6	0.066200	0.539671	0.035726	0.087032
2489.7	0.067500	0.539681	0.036428	0.088742
2489.8	0.068900	0.539691	0.037185	0.090585
2489.9	0.070300	0.539701	0.037941	0.092427
2490.0	0.071800	0.539711	0.038751	0.094401
2490.1	0.073300	0.539753	0.039564	0.096381
2490.2	0.074800	0.539795	0.040377	0.098361
2490.3	0.076400	0.539837	0.041244	0.100472
2490.4	0.078000	0.539879	0.042111	0.102584
2490.5	0.079600	0.539921	0.042978	0.104697
2490.6	0.081300	0.539963	0.043899	0.106941
2490.7	0.083000	0.540005	0.044820	0.109186
2490.8	0.084700	0.540046	0.045742	0.111431
2490.9	0.086500	0.540088	0.046718	0.113808
2491.0	0.088400	0.540130	0.047748	0.116316
2491.1	0.090300	0.540121	0.048773	0.118815
2491.2	0.092200	0.540112	0.049798	0.121313
2491.3	0.094200	0.540104	0.050878	0.123942
2491.4	0.096200	0.540095	0.051957	0.126572
2491.5	0.098300	0.540087	0.053091	0.129332
2491.6	0.100440	0.540078	0.054245	0.132145
2491.7	0.102635	0.540069	0.055430	0.135031
2491.8	0.104886	0.540060	0.056644	0.137990
2491.9	0.107194	0.540051	0.057890	0.141025
2492.0	0.109562	0.540043	0.059168	0.144138
2492.1	0.111990	0.539908	0.060464	0.147295
2492.2	0.114479	0.539774	0.061793	0.150532
2492.3	0.117032	0.539640	0.063155	0.153850

2492.4	0.119648	0.539506	0.064551	0.157251
2492.5	0.122330	0.539465	0.065993	0.160763
2492.6	0.125079	0.539785	0.067516	0.164473
2492.7	0.127895	0.539651	0.069019	0.168135
2492.8	0.130781	0.539517	0.070559	0.171886
2492.9	0.133737	0.539382	0.072135	0.175727
2493.0	0.136764	0.539248	0.073750	0.179660
2493.1	0.139864	0.539141	0.075406	0.183695
2493.2	0.143037	0.539033	0.077102	0.187826
2493.3	0.146285	0.538926	0.078837	0.192052
2493.4	0.149609	0.538819	0.080612	0.196377
2493.5	0.153010	0.538712	0.082428	0.200801
2493.6	0.156489	0.538604	0.084286	0.205326
2493.7	0.160048	0.538497	0.086186	0.209955
2493.8	0.163689	0.538390	0.088129	0.214688
2493.9	0.167413	0.538283	0.090116	0.219528
2494.0	0.171222	0.538176	0.092147	0.224478
2494.1	0.175117	0.538083	0.094228	0.229545
2494.2	0.179101	0.537432	0.096255	0.234484
2494.3	0.183175	0.537420	0.098442	0.239812
2494.4	0.187341	0.537790	0.100750	0.245434
2494.5	0.191600	0.537696	0.103023	0.250971
2494.6	0.195954	0.537603	0.105346	0.256630
2494.7	0.200404	0.537509	0.107719	0.262411
2494.8	0.204950	0.537416	0.110143	0.268317
2494.9	0.209592	0.537322	0.112618	0.274347
2495.0	0.214331	0.537229	0.115145	0.280501
2495.1	0.219166	0.537177	0.117731	0.286802
2495.2	0.224100	0.537125	0.120370	0.293230
2495.3	0.229131	0.537074	0.123061	0.299785
2495.4	0.234261	0.537022	0.125804	0.306467
2495.5	0.239490	0.536970	0.128599	0.313277
2495.6	0.244818	0.536919	0.131447	0.320215
2495.7	0.250244	0.536867	0.134348	0.327281
2495.8	0.255768	0.536816	0.137300	0.334474
2495.9	0.261391	0.536764	0.140305	0.341794
2496.0	0.267110	0.536712	0.143361	0.349239
2496.1	0.272926	0.537044	0.146574	0.357064
2496.2	0.278839	0.537377	0.149842	0.365025
2496.3	0.284847	0.537709	0.153165	0.373122
2496.4	0.290951	0.538042	0.156544	0.381353
2496.5	0.297150	0.538374	0.159978	0.389718
2496.6	0.303443	0.538707	0.163467	0.398217

2496.7	0.309828	0.539039	0.167010	0.406848
2496.8	0.316304	0.539372	0.170605	0.415608
2496.9	0.322868	0.539705	0.174253	0.424494
2497.0	0.329518	0.540037	0.177952	0.433505
2497.1	0.336252	0.540350	0.181694	0.442620
2497.2	0.343069	0.540662	0.185484	0.451854
2497.3	0.349965	0.540974	0.189322	0.461203
2497.4	0.356940	0.541286	0.193207	0.470666
2497.5	0.363990	0.541599	0.197137	0.480239
2497.6	0.371114	0.541911	0.201111	0.489921
2497.7	0.378307	0.542224	0.205127	0.499705
2497.8	0.385564	0.542536	0.209183	0.509584
2497.9	0.392882	0.543410	0.213496	0.520092
2498.0	0.400254	0.543723	0.217628	0.530157
2498.1	0.407677	0.543735	0.221669	0.540001
2498.2	0.415146	0.543748	0.225735	0.549906
2498.3	0.422656	0.543760	0.229823	0.559866
2498.4	0.430202	0.543771	0.233932	0.569875
2498.5	0.437780	0.543783	0.238057	0.579926
2498.6	0.445385	0.543795	0.242198	0.590013
2498.7	0.453010	0.543807	0.246350	0.600127
2498.8	0.460650	0.543819	0.250510	0.610262
2498.9	0.468299	0.543831	0.254675	0.620408
2499.0	0.475949	0.543843	0.258841	0.630557
2499.1	0.483595	0.543832	0.262994	0.640674
2499.2	0.491230	0.543822	0.267142	0.650777
2499.3	0.498848	0.543812	0.271280	0.660858
2499.4	0.506444	0.543801	0.275405	0.670907
2499.5	0.514010	0.543791	0.279514	0.680917
2499.6	0.521540	0.543780	0.283603	0.690879
2499.7	0.529028	0.544333	0.287967	0.701510
2499.8	0.536467	0.544323	0.292011	0.711361
2499.9	0.543849	0.544312	0.296024	0.721136
2500.0	0.551168	0.544302	0.300002	0.730828
2500.1	0.558418	0.544207	0.303895	0.740311
2500.2	0.565591	0.544111	0.307744	0.749688
2500.3	0.572680	0.544015	0.311547	0.758951
2500.4	0.579679	0.543919	0.315298	0.768089
2500.5	0.586580	0.543822	0.318995	0.777096
2500.6	0.593378	0.543725	0.322634	0.785961
2500.7	0.600067	0.543628	0.326213	0.794680
2500.8	0.606643	0.543532	0.329729	0.803246
2500.9	0.613101	0.543435	0.333180	0.811652

2501.0	0.619437	0.543338	0.336564	0.819895
2501.1	0.625647	0.543260	0.339889	0.827996
2501.2	0.631726	0.543183	0.343143	0.835921
2501.3	0.637669	0.543105	0.346321	0.843665
2501.4	0.643472	0.543028	0.349423	0.851221
2501.5	0.649130	0.542950	0.352445	0.858584
2501.6	0.654640	0.542873	0.355386	0.865748
2501.7	0.660000	0.542796	0.358245	0.872712
2501.8	0.665209	0.542718	0.361021	0.879474
2501.9	0.670265	0.542641	0.363713	0.886033
2502.0	0.675168	0.542563	0.366322	0.892387
2502.1	0.679917	0.542589	0.368916	0.898707
2502.2	0.684511	0.542615	0.371426	0.904822
2502.3	0.688949	0.542641	0.373852	0.910731
2502.4	0.693229	0.542667	0.376192	0.916433
2502.5	0.697350	0.542693	0.378447	0.921925
2502.6	0.701312	0.542719	0.380615	0.927208
2502.7	0.705117	0.542745	0.382698	0.932282
2502.8	0.708764	0.542771	0.384697	0.937150
2502.9	0.712257	0.542797	0.386611	0.941813
2503.0	0.715596	0.542823	0.388442	0.946274
2503.1	0.718783	0.542840	0.390184	0.950519
2503.2	0.721820	0.542857	0.391845	0.954564
2503.3	0.724707	0.542875	0.393425	0.958413
2503.4	0.727447	0.542892	0.394925	0.962067
2503.5	0.730040	0.542909	0.396346	0.965528
2503.6	0.732489	0.542927	0.397688	0.968798
2503.7	0.734797	0.542944	0.398954	0.971881
2503.8	0.736966	0.542962	0.400145	0.974782
2503.9	0.739001	0.542979	0.401262	0.977505
2504.0	0.740905	0.542997	0.402309	0.980055
2504.1	0.742681	0.542957	0.403244	0.982332
2504.2	0.744332	0.542917	0.404111	0.984444
2504.3	0.745861	0.542878	0.404912	0.986395
2504.4	0.747273	0.542838	0.405648	0.988190
2504.5	0.748570	0.542799	0.406323	0.989833
2504.6	0.749756	0.542759	0.406937	0.991328
2504.7	0.750833	0.542719	0.407492	0.992680
2504.8	0.751807	0.542680	0.407990	0.993895
2504.9	0.752679	0.543201	0.408856	0.996004
2505.0	0.753454	0.543162	0.409248	0.996958
2505.1	0.754135	0.543089	0.409563	0.997726
2505.2	0.754726	0.543016	0.409829	0.998373

2505.3	0.755230	0.542944	0.410047	0.998906
2505.4	0.755650	0.542871	0.410220	0.999328
2505.5	0.755990	0.542799	0.410350	0.999644
2505.6	0.756254	0.542726	0.410438	0.999859
2505.7	0.756444	0.542653	0.410487	0.999976
2505.8	0.756563	0.542581	0.410496	1.000000
2505.9	0.756614	0.542508	0.410469	0.999934
2506.0	0.756599	0.542436	0.410407	0.999782
2506.1	0.756523	0.542446	0.410373	0.999700
2506.2	0.756387	0.542457	0.410307	0.999539
2506.3	0.756194	0.542467	0.410210	0.999303
2506.4	0.755948	0.542477	0.410084	0.998996
2506.5	0.755650	0.542488	0.409931	0.998622
2506.6	0.755304	0.542498	0.409751	0.998184
2506.7	0.754913	0.542508	0.409547	0.997686
2506.8	0.754480	0.542518	0.409319	0.997133
2506.9	0.754009	0.542529	0.409071	0.996528
2507.0	0.753501	0.542539	0.408804	0.995877
2507.1	0.752962	0.542574	0.408537	0.995228
2507.2	0.752392	0.542609	0.408255	0.994540
2507.3	0.751797	0.542644	0.407958	0.993817
2507.4	0.751178	0.542679	0.407649	0.993064
2507.5	0.750540	0.542715	0.407329	0.992284
2507.6	0.749884	0.542750	0.407000	0.991481
2507.7	0.749214	0.542785	0.406662	0.990659
2507.8	0.748531	0.542820	0.406317	0.989820
2507.9	0.747837	0.542855	0.405967	0.988966
2508.0	0.747134	0.542890	0.405611	0.988100
2508.1	0.746423	0.542875	0.405214	0.987132
2508.2	0.745708	0.542859	0.404814	0.986157
2508.3	0.744989	0.542843	0.404412	0.985178
2508.4	0.744269	0.542828	0.404010	0.984198
2508.5	0.743550	0.542812	0.403608	0.983219
2508.6	0.742833	0.542796	0.403207	0.982243
2508.7	0.742120	0.542781	0.402809	0.981272
2508.8	0.741411	0.542765	0.402412	0.980306
2508.9	0.740707	0.542750	0.402019	0.979347
2509.0	0.740008	0.542734	0.401628	0.978396
2509.1	0.739317	0.542717	0.401239	0.977449
2509.2	0.738632	0.542699	0.400855	0.976512
2509.3	0.737956	0.542681	0.400475	0.975586
2509.4	0.737288	0.542664	0.400099	0.974672
2509.5	0.736630	0.542646	0.399729	0.973771

2509.6	0.735982	0.542628	0.399365	0.972883
2509.7	0.735345	0.542611	0.399006	0.972010
2509.8	0.734720	0.542593	0.398654	0.971151
2509.9	0.734106	0.542576	0.398308	0.970309
2510.0	0.733505	0.542558	0.397969	0.969483
2510.1	0.732916	0.542516	0.397619	0.968630
2510.2	0.732341	0.542475	0.397277	0.967796
2510.3	0.731780	0.542433	0.396941	0.966979
2510.4	0.731232	0.542391	0.396614	0.966181
2510.5	0.730700	0.542349	0.396294	0.965403
2510.6	0.730183	0.542307	0.395983	0.964645
2510.7	0.729680	0.542265	0.395680	0.963907
2510.8	0.729193	0.542223	0.395385	0.963188
2510.9	0.728720	0.542182	0.395099	0.962490
2511.0	0.728262	0.542140	0.394820	0.961811
2511.1	0.727819	0.542059	0.394521	0.961082
2511.2	0.727391	0.541977	0.394229	0.960372
2511.3	0.726976	0.541896	0.393945	0.959681
2511.4	0.726576	0.541815	0.393670	0.959009
2511.5	0.726190	0.541733	0.393401	0.958355
2511.6	0.725818	0.541652	0.393141	0.957721
2511.7	0.725460	0.541571	0.392888	0.957106
2511.8	0.725116	0.542028	0.393033	0.957458
2511.9	0.724785	0.541957	0.392803	0.956897
2512.0	0.724469	0.541876	0.392572	0.956335
2512.1	0.724166	0.541857	0.392395	0.955903
2512.2	0.723877	0.541839	0.392224	0.955488
2512.3	0.723601	0.541820	0.392062	0.955092
2512.4	0.723339	0.541801	0.391906	0.954712
2512.5	0.723090	0.541783	0.391758	0.954351
2512.6	0.722855	0.541730	0.391592	0.953948
2512.7	0.722632	0.541621	0.391393	0.953462
2512.8	0.722422	0.541512	0.391200	0.952993
2512.9	0.722224	0.541403	0.391014	0.952540
2513.0	0.722037	0.541294	0.390834	0.952102
2513.1	0.721861	0.541221	0.390687	0.951743
2513.2	0.721696	0.541154	0.390549	0.951406
2513.3	0.721541	0.541171	0.390477	0.951232
2513.4	0.721396	0.541188	0.390411	0.951071
2513.5	0.721260	0.541205	0.390350	0.950921
2513.6	0.721133	0.541223	0.390293	0.950784
2513.7	0.721014	0.541240	0.390242	0.950658
2513.8	0.720903	0.541257	0.390194	0.950543

2513.9	0.720801	0.541275	0.390151	0.950438
2514.0	0.720707	0.541292	0.390113	0.950344
2514.1	0.720620	0.541278	0.390056	0.950205
2514.2	0.720542	0.541264	0.390003	0.950077
2514.3	0.720471	0.541250	0.389955	0.949959
2514.4	0.720407	0.541236	0.389910	0.949850
2514.5	0.720350	0.541222	0.389869	0.949751
2514.6	0.720300	0.541208	0.389832	0.949661
2514.7	0.720257	0.541753	0.390201	0.950560
2514.8	0.720220	0.541739	0.390172	0.950487
2514.9	0.720189	0.541725	0.390145	0.950422
2515.0	0.720163	0.541711	0.390121	0.950363
2515.1	0.720142	0.541707	0.390106	0.950328
2515.2	0.720126	0.541703	0.390095	0.950300
2515.3	0.720114	0.541699	0.390085	0.950276
2515.4	0.720105	0.541695	0.390077	0.950257
2515.5	0.720100	0.541691	0.390071	0.950243
2515.6	0.720098	0.541686	0.390067	0.950233
2515.7	0.720097	0.541682	0.390064	0.950225
2515.8	0.720099	0.541678	0.390062	0.950221
2515.9	0.720102	0.541674	0.390061	0.950218
2516.0	0.720106	0.541670	0.390060	0.950215
2516.1	0.720110	0.541684	0.390073	0.950246
2516.2	0.720114	0.541699	0.390085	0.950277
2516.3	0.720118	0.541714	0.390098	0.950307
2516.4	0.720120	0.541728	0.390109	0.950335
2516.5	0.720120	0.541743	0.390120	0.950361
2516.6	0.720118	0.541757	0.390129	0.950384
2516.7	0.720113	0.541772	0.390137	0.950403
2516.8	0.720105	0.541786	0.390143	0.950417
2516.9	0.720092	0.541801	0.390147	0.950426
2517.0	0.720075	0.541815	0.390148	0.950429
2517.1	0.720053	0.541811	0.390133	0.950393
2517.2	0.720025	0.541807	0.390114	0.950348
2517.3	0.719991	0.541802	0.390092	0.950294
2517.4	0.719949	0.541798	0.390067	0.950232
2517.5	0.719900	0.541793	0.390037	0.950159
2517.6	0.719843	0.541789	0.390003	0.950076
2517.7	0.719777	0.541784	0.389964	0.949981
2517.8	0.719701	0.541780	0.389920	0.949874
2517.9	0.719616	0.541776	0.389870	0.949753
2518.0	0.719520	0.541771	0.389815	0.949619
2518.1	0.719412	0.541700	0.389706	0.949353

2518.2	0.719293	0.541630	0.389591	0.949072
2518.3	0.719162	0.541559	0.389469	0.948775
2518.4	0.719018	0.541488	0.389340	0.948461
2518.5	0.718860	0.541417	0.389203	0.948128
2518.6	0.718688	0.541346	0.389059	0.947777
2518.7	0.718501	0.541275	0.388907	0.947406
2518.8	0.718299	0.541204	0.388747	0.947016
2518.9	0.718081	0.541133	0.388577	0.946604
2519.0	0.717847	0.541062	0.388399	0.946170
2519.1	0.717594	0.541020	0.388233	0.945764
2519.2	0.717324	0.540977	0.388056	0.945334
2519.3	0.717036	0.540935	0.387870	0.944879
2519.4	0.716728	0.540892	0.387672	0.944399
2519.5	0.716400	0.540850	0.387465	0.943893
2519.6	0.716052	0.540807	0.387246	0.943360
2519.7	0.715683	0.540765	0.387016	0.942800
2519.8	0.715293	0.540722	0.386774	0.942212
2519.9	0.714881	0.540679	0.386521	0.941595
2520.0	0.714447	0.540637	0.386256	0.940950
2520.1	0.713992	0.540717	0.386068	0.940489
2520.2	0.713513	0.540796	0.385865	0.939996
2520.3	0.713012	0.540875	0.385650	0.939473
2520.4	0.712488	0.540953	0.385423	0.938918
2520.5	0.711940	0.541032	0.385182	0.938333
2520.6	0.711368	0.541111	0.384929	0.937716
2520.7	0.710773	0.541189	0.384663	0.937067
2520.8	0.710153	0.541268	0.384383	0.936386
2520.9	0.709509	0.541347	0.384090	0.935673
2521.0	0.708841	0.541425	0.383784	0.934927
2521.1	0.708148	0.541461	0.383434	0.934075
2521.2	0.707431	0.541496	0.383071	0.933190
2521.3	0.706689	0.541532	0.382695	0.932273
2521.4	0.705922	0.541568	0.382305	0.931322
2521.5	0.705130	0.541604	0.381901	0.930339
2521.6	0.704313	0.541639	0.381484	0.929323
2521.7	0.703471	0.541675	0.381052	0.928272
2521.8	0.702602	0.541711	0.380607	0.927188
2521.9	0.701707	0.541747	0.380148	0.926068
2522.0	0.700785	0.541782	0.379673	0.924913
2522.1	0.699836	0.541879	0.379227	0.923825
2522.2	0.698860	0.541976	0.378766	0.922701
2522.3	0.697855	0.542073	0.378289	0.921540
2522.4	0.696822	0.542171	0.377797	0.920341

2522.5	0.695760	0.542750	0.377624	0.919920
2522.6	0.694669	0.542913	0.377145	0.918753
2522.7	0.693547	0.543011	0.376603	0.917434
2522.8	0.692396	0.543108	0.376046	0.916075
2522.9	0.691214	0.543205	0.375471	0.914675
2523.0	0.690001	0.543302	0.374879	0.913234
2523.1	0.688757	0.543346	0.374233	0.911660
2523.2	0.687481	0.543389	0.373570	0.910044
2523.3	0.686173	0.543432	0.372889	0.908385
2523.4	0.684833	0.543476	0.372190	0.906683
2523.5	0.683460	0.543519	0.371474	0.904938
2523.6	0.682054	0.543563	0.370739	0.903148
2523.7	0.680615	0.543606	0.369986	0.901314
2523.8	0.679142	0.543650	0.369215	0.899436
2523.9	0.677637	0.543693	0.368427	0.897515
2524.0	0.676100	0.543736	0.367620	0.895550
2524.1	0.674530	0.543421	0.366554	0.892953
2524.2	0.672928	0.543106	0.365471	0.890315
2524.3	0.671294	0.542791	0.364372	0.887638
2524.4	0.669628	0.542476	0.363257	0.884921
2524.5	0.667930	0.542161	0.362126	0.882166
2524.6	0.666201	0.541847	0.360978	0.879371
2524.7	0.664440	0.541532	0.359815	0.876537
2524.8	0.662647	0.541217	0.358636	0.873665
2524.9	0.660824	0.540903	0.357441	0.870754
2525.0	0.658969	0.540588	0.356231	0.867806
2525.1	0.657083	0.540315	0.355032	0.864884
2525.2	0.655166	0.539577	0.353513	0.861183
2525.3	0.653218	0.539222	0.352229	0.858057
2525.4	0.651239	0.538948	0.350984	0.855024
2525.5	0.649230	0.538675	0.349724	0.851953
2525.6	0.647190	0.538401	0.348448	0.848845
2525.7	0.645118	0.538128	0.347156	0.845698
2525.8	0.643016	0.537855	0.345849	0.842514
2525.9	0.640882	0.537581	0.344526	0.839291
2526.0	0.638716	0.537308	0.343187	0.836030
2526.1	0.636518	0.537436	0.342088	0.833351
2526.2	0.634288	0.537564	0.340970	0.830628
2526.3	0.632025	0.537692	0.339834	0.827862
2526.4	0.629729	0.537819	0.338680	0.825051
2526.5	0.627400	0.537947	0.337508	0.822195
2526.6	0.625038	0.538075	0.336317	0.819293
2526.7	0.622643	0.538202	0.335108	0.816348

2526.8	0.620216	0.538330	0.333880	0.813358
2526.9	0.617757	0.538457	0.332636	0.810326
2527.0	0.615267	0.538585	0.331374	0.807251
2527.1	0.612748	0.538715	0.330096	0.804139
2527.2	0.610198	0.538844	0.328802	0.800986
2527.3	0.607620	0.538974	0.327491	0.797793
2527.4	0.605014	0.539103	0.326165	0.794562
2527.5	0.602380	0.539233	0.324823	0.791293
2527.6	0.599719	0.539363	0.323466	0.787987
2527.7	0.597031	0.539492	0.322093	0.784644
2527.8	0.594316	0.539622	0.320706	0.781263
2527.9	0.591573	0.539751	0.319302	0.777844
2528.0	0.588803	0.539881	0.317884	0.774388
2528.1	0.586006	0.540042	0.316468	0.770939
2528.2	0.583181	0.540202	0.315036	0.767451
2528.3	0.580329	0.540363	0.313588	0.763924
2528.4	0.577448	0.540524	0.312124	0.760358
2528.5	0.574540	0.540684	0.310645	0.756754
2528.6	0.571604	0.540845	0.309149	0.753110
2528.7	0.568639	0.541006	0.307637	0.749427
2528.8	0.565646	0.541167	0.306109	0.745704
2528.9	0.562625	0.541327	0.304564	0.741941
2529.0	0.559574	0.541488	0.303003	0.738137
2529.1	0.556495	0.541610	0.301403	0.734241
2529.2	0.553385	0.541733	0.299787	0.730304
2529.3	0.550247	0.541855	0.298154	0.726326
2529.4	0.547079	0.541978	0.296504	0.722307
2529.5	0.543880	0.542100	0.294837	0.718246
2529.6	0.540651	0.542223	0.293153	0.714144
2529.7	0.537393	0.542345	0.291453	0.710001
2529.8	0.534107	0.542468	0.289736	0.705818
2529.9	0.530793	0.542590	0.288003	0.701596
2530.0	0.527451	0.542712	0.286254	0.697337
2530.1	0.524084	0.542600	0.284368	0.692742
2530.2	0.520691	0.542488	0.282469	0.688116
2530.3	0.517274	0.542377	0.280557	0.683459
2530.4	0.513833	0.542265	0.278634	0.678773
2530.5	0.510370	0.542153	0.276699	0.674059
2530.6	0.506884	0.542042	0.274753	0.669318
2530.7	0.503377	0.541930	0.272795	0.664550
2530.8	0.499849	0.541818	0.270827	0.659755
2530.9	0.496298	0.541707	0.268848	0.654935
2531.0	0.492727	0.541596	0.266859	0.650088

2531.1	0.489135	0.541513	0.264873	0.645251
2531.2	0.485522	0.541431	0.262877	0.640387
2531.3	0.481888	0.541349	0.260870	0.635498
2531.4	0.478234	0.541267	0.258852	0.630584
2531.5	0.474560	0.541185	0.256825	0.625644
2531.6	0.470866	0.541103	0.254787	0.620680
2531.7	0.467152	0.541020	0.252739	0.615691
2531.8	0.463419	0.540938	0.250681	0.610679
2531.9	0.459669	0.541414	0.248871	0.606268
2532.0	0.455900	0.541332	0.246793	0.601207
2532.1	0.452114	0.541337	0.244746	0.596219
2532.2	0.448311	0.541341	0.242689	0.591209
2532.3	0.444493	0.541345	0.240624	0.586178
2532.4	0.440659	0.541349	0.238550	0.581126
2532.5	0.436810	0.541353	0.236468	0.576055
2532.6	0.432947	0.541357	0.234379	0.570964
2532.7	0.429071	0.541361	0.232282	0.565857
2532.8	0.425183	0.541365	0.230179	0.560734
2532.9	0.421286	0.541369	0.228071	0.555598
2533.0	0.417379	0.541373	0.225958	0.550451
2533.1	0.413466	0.541390	0.223847	0.545307
2533.2	0.409547	0.541407	0.221732	0.540155
2533.3	0.405624	0.541425	0.219615	0.534998
2533.4	0.401698	0.541442	0.217496	0.529836
2533.5	0.397770	0.541459	0.215376	0.524672
2533.6	0.393842	0.541475	0.213256	0.519507
2533.7	0.389915	0.541492	0.211136	0.514344
2533.8	0.385990	0.541509	0.209017	0.509181
2533.9	0.382066	0.541526	0.206899	0.504021
2534.0	0.378145	0.541543	0.204782	0.498863
2534.1	0.374227	0.541557	0.202665	0.493708
2534.2	0.370313	0.541572	0.200551	0.488557
2534.3	0.366403	0.541586	0.198439	0.483412
2534.4	0.362499	0.541601	0.196330	0.478274
2534.5	0.358600	0.541615	0.194223	0.473142
2534.6	0.354708	0.541629	0.192120	0.468019
2534.7	0.350822	0.541644	0.190020	0.462904
2534.8	0.346943	0.541658	0.187924	0.457798
2534.9	0.343071	0.541672	0.185832	0.452701
2535.0	0.339206	0.541686	0.183743	0.447613
2535.1	0.335349	0.541626	0.181634	0.442474
2535.2	0.331500	0.541566	0.179529	0.437346
2535.3	0.327658	0.541506	0.177429	0.432230

2535.4	0.323825	0.541445	0.175333	0.427126
2535.5	0.320000	0.541385	0.173243	0.422033
2535.6	0.316184	0.541325	0.171158	0.416954
2535.7	0.312377	0.541264	0.169079	0.411888
2535.8	0.308582	0.541204	0.167006	0.406839
2535.9	0.304799	0.541143	0.164940	0.401806
2536.0	0.301029	0.541083	0.162882	0.396792
2536.1	0.297274	0.540791	0.160763	0.391631
2536.2	0.293534	0.540500	0.158655	0.386495
2536.3	0.289811	0.540208	0.156558	0.381387
2536.4	0.286106	0.539917	0.154473	0.376309
2536.5	0.282420	0.539626	0.152401	0.371261
2536.6	0.278755	0.539335	0.150342	0.366244
2536.7	0.275110	0.539044	0.148296	0.361261
2536.8	0.271487	0.538753	0.146264	0.356310
2536.9	0.267885	0.538462	0.144246	0.351394
2537.0	0.264307	0.538171	0.142242	0.346513
2537.1	0.260751	0.537917	0.140262	0.341690
2537.2	0.257219	0.537664	0.138297	0.336903
2537.3	0.253711	0.537410	0.136347	0.332151
2537.4	0.250228	0.537157	0.134412	0.327437
2537.5	0.246770	0.536903	0.132492	0.322760
2537.6	0.243338	0.536650	0.130587	0.318120
2537.7	0.239931	0.536397	0.128698	0.313519
2537.8	0.236551	0.536144	0.126825	0.308956
2537.9	0.233197	0.535890	0.124968	0.304431
2538.0	0.229869	0.535637	0.123126	0.299945
2538.1	0.226568	0.535695	0.121371	0.295670
2538.2	0.223293	0.535753	0.119630	0.291427
2538.3	0.220045	0.535811	0.117902	0.287219
2538.4	0.216824	0.535868	0.116189	0.283045
2538.5	0.213630	0.535926	0.114490	0.278906
2538.6	0.210463	0.535432	0.112689	0.274518
2538.7	0.207324	0.535490	0.111020	0.270453
2538.8	0.204214	0.535547	0.109366	0.266424
2538.9	0.201132	0.535605	0.107728	0.262432
2539.0	0.198080	0.535661	0.106104	0.258477
2539.1	0.195059	0.535777	0.104508	0.254590
2539.2	0.192069	0.535893	0.102928	0.250741
2539.3	0.189110	0.536008	0.101365	0.246932
2539.4	0.186184	0.536124	0.099817	0.243163
2539.5	0.183290	0.536240	0.098287	0.239435
2539.6	0.180430	0.536741	0.096844	0.235920

2539.7	0.177603	0.537014	0.095375	0.232342
2539.8	0.174810	0.537130	0.093896	0.228737
2539.9	0.172050	0.537246	0.092433	0.225174
2540.0	0.169324	0.537362	0.090988	0.221654
2540.1	0.166631	0.537568	0.089575	0.218212
2540.2	0.163971	0.537774	0.088179	0.214811
2540.3	0.161344	0.537979	0.086800	0.211451
2540.4	0.158750	0.538185	0.085437	0.208131
2540.5	0.156190	0.538390	0.084091	0.204852
2540.6	0.153663	0.538596	0.082762	0.201615
2540.7	0.151168	0.538801	0.081449	0.198417
2540.8	0.148705	0.539007	0.080153	0.195259
2540.9	0.146274	0.539212	0.078873	0.192140
2541.0	0.143875	0.539418	0.077608	0.189060
2541.1	0.141506	0.539545	0.076349	0.185991
2541.2	0.139167	0.539672	0.075105	0.182961
2541.3	0.136859	0.539800	0.073876	0.179969
2541.4	0.134580	0.539927	0.072663	0.177013
2541.5	0.132330	0.540054	0.071465	0.174095
2541.6	0.130109	0.540181	0.070282	0.171213
2541.7	0.127916	0.540308	0.069114	0.168367
2541.8	0.125753	0.540435	0.067961	0.165558
2541.9	0.123618	0.540562	0.066823	0.162786
2542.0	0.121512	0.540688	0.065700	0.160050
2542.1	0.119435	0.540473	0.064551	0.157252
2542.2	0.117387	0.540257	0.063419	0.154494
2542.3	0.115369	0.539484	0.062240	0.151621
2542.4	0.113380	0.539269	0.061142	0.148947
2542.5	0.111420	0.539054	0.060061	0.146314
2542.6	0.109490	0.538839	0.058997	0.143722
2542.7	0.107589	0.538623	0.057950	0.141171
2542.8	0.105719	0.538408	0.056920	0.138661
2542.9	0.103878	0.538193	0.055906	0.136192
2543.0	0.102067	0.537978	0.054910	0.133764
2543.1	0.100287	0.537758	0.053930	0.131377
2543.2	0.098500	0.537539	0.052948	0.128984
2543.3	0.096800	0.537629	0.052043	0.126779
2543.4	0.095100	0.537500	0.051116	0.124523
2543.5	0.093470	0.537193	0.050211	0.122319
2543.6	0.091800	0.536887	0.049286	0.120065
2543.7	0.090200	0.536581	0.048400	0.117905
2543.8	0.088700	0.536274	0.047568	0.115878
2543.9	0.087100	0.535984	0.046684	0.113726

2544.0	0.085600	0.535765	0.045861	0.111722
2544.1	0.084100	0.535595	0.045044	0.109729
2544.2	0.082700	0.535425	0.044280	0.107869
2544.3	0.081200	0.535255	0.043463	0.105878
2544.4	0.079800	0.535085	0.042700	0.104020
2544.5	0.078400	0.534916	0.041937	0.102163
2544.6	0.077100	0.534746	0.041229	0.100437
2544.7	0.075700	0.534576	0.040467	0.098582
2544.8	0.074400	0.534406	0.039760	0.096858
2544.9	0.073100	0.534237	0.039053	0.095135
2545.0	0.071800	0.534067	0.038346	0.093414
2545.1	0.070600	0.533954	0.037697	0.091833
2545.2	0.069360	0.533841	0.037027	0.090201
2545.3	0.068149	0.533728	0.036373	0.088607
2545.4	0.067000	0.533615	0.035752	0.087095
2545.5	0.065790	0.533502	0.035099	0.085504
2545.6	0.064600	0.533389	0.034457	0.083940
2545.7	0.063516	0.533276	0.033872	0.082514
2545.8	0.062400	0.533163	0.033269	0.081047
2545.9	0.061300	0.533050	0.032676	0.079601
2546.0	0.060261	0.532937	0.032115	0.078235
2546.1	0.059200	0.533186	0.031565	0.076894
2546.2	0.058200	0.533436	0.031046	0.075630
2546.3	0.057200	0.533685	0.030527	0.074366
2546.4	0.056200	0.533935	0.030007	0.073100
2546.5	0.055230	0.534184	0.029503	0.071872
2546.6	0.054300	0.534434	0.029020	0.070694
2546.7	0.053400	0.534683	0.028552	0.069555
2546.8	0.052400	0.534933	0.028030	0.068284
2546.9	0.051500	0.535183	0.027562	0.067143
2547.0	0.050700	0.535432	0.027146	0.066131
2547.1	0.049800	0.535669	0.026676	0.064985
2547.2	0.049000	0.535905	0.026259	0.063970
2547.3	0.048100	0.536141	0.025788	0.062822
2547.4	0.047300	0.536377	0.025371	0.061805
2547.5	0.046520	0.536614	0.024963	0.060812
2547.6	0.045700	0.536850	0.024534	0.059767
2547.7	0.045000	0.537087	0.024169	0.058877
2547.8	0.044200	0.537878	0.023774	0.057916
2547.9	0.043480	0.538115	0.023397	0.056997
2548.0	0.042800	0.538351	0.023041	0.056131
2548.1	0.042000	0.538246	0.022606	0.055071
2548.2	0.041300	0.538140	0.022225	0.054142

2548.3	0.040700	0.538035	0.021898	0.053345
2548.4	0.040000	0.537929	0.021517	0.052417
2548.5	0.039330	0.537824	0.021153	0.051529
2548.6	0.038700	0.537382	0.020797	0.050662
2548.7	0.038046	0.537070	0.020434	0.049778
2548.8	0.037422	0.536965	0.020095	0.048952
2548.9	0.036800	0.536860	0.019756	0.048128
2549.0	0.036200	0.536755	0.019431	0.047334
2549.1	0.035600	0.536643	0.019104	0.046540
2549.2	0.035000	0.536531	0.018779	0.045746
2549.3	0.034500	0.536420	0.018506	0.045083
2549.4	0.033900	0.536308	0.018181	0.044290
2549.5	0.033390	0.536197	0.017904	0.043615
2549.6	0.032900	0.536085	0.017637	0.042966
2549.7	0.032300	0.535974	0.017312	0.042173
2549.8	0.031800	0.535862	0.017040	0.041512
2549.9	0.031300	0.535750	0.016769	0.040851
2550.0	0.030844	0.535639	0.016521	0.040247
2550.1	0.030400	0.535436	0.016277	0.039653
2550.2	0.029900	0.535234	0.016003	0.038986
2550.3	0.029399	0.535031	0.015729	0.038317
2550.4	0.028900	0.534828	0.015457	0.037653
2550.5	0.028450	0.534625	0.015210	0.037053
2550.6	0.027999	0.534422	0.014963	0.036452
2550.7	0.027554	0.534219	0.014720	0.035859
2550.8	0.027115	0.534340	0.014489	0.035295
2550.9	0.026684	0.534352	0.014259	0.034735
2551.0	0.026259	0.534149	0.014026	0.034169
2551.1	0.025840	0.533972	0.013798	0.033613
2551.2	0.025428	0.533795	0.013573	0.033066
2551.3	0.025022	0.533617	0.013352	0.032527
2551.4	0.024623	0.533440	0.013135	0.031998
2551.5	0.024230	0.533263	0.012921	0.031476
2551.6	0.023843	0.533085	0.012710	0.030963
2551.7	0.023463	0.532907	0.012504	0.030460
2551.8	0.023089	0.532730	0.012300	0.029964
2551.9	0.022721	0.532552	0.012100	0.029477
2552.0	0.022359	0.532374	0.011903	0.028997
2552.1	0.022003	0.532576	0.011718	0.028547
2552.2	0.021653	0.532777	0.011536	0.028103
2552.3	0.021310	0.532978	0.011358	0.027668
2552.4	0.020972	0.533179	0.011182	0.027240
2552.5	0.020640	0.533381	0.011009	0.026819

2552.6	0.020314	0.533582	0.010839	0.026405
2552.7	0.019994	0.533783	0.010672	0.025999
2552.8	0.019680	0.533985	0.010509	0.025600
2552.9	0.019371	0.534186	0.010348	0.025208
2553.0	0.019069	0.534387	0.010190	0.024824
2553.1	0.018772	0.534546	0.010034	0.024445
2553.2	0.018480	0.534704	0.009881	0.024072
2553.3	0.018195	0.534862	0.009732	0.023707
2553.4	0.017915	0.535020	0.009585	0.023349
2553.5	0.017640	0.535178	0.009441	0.022998
2553.6	0.017371	0.535336	0.009299	0.022654
2553.7	0.017107	0.535494	0.009161	0.022316
2553.8	0.016849	0.535652	0.009025	0.021986
2553.9	0.016596	0.535810	0.008892	0.021662
2554.0	0.016349	0.535968	0.008763	0.021346
2554.1	0.016106	0.535950	0.008632	0.021028
2554.2	0.015869	0.535932	0.008505	0.020718
2554.3	0.015638	0.535914	0.008381	0.020416
2554.4	0.015411	0.535896	0.008259	0.020119
2554.5	0.015190	0.535877	0.008140	0.019830
2554.6	0.014973	0.535859	0.008023	0.019546
2554.7	0.014762	0.535841	0.007910	0.019270
2554.8	0.014556	0.535823	0.007799	0.019000
2554.9	0.014355	0.535804	0.007691	0.018737
2555.0	0.014158	0.535786	0.007586	0.018479
2555.1	0.013967	0.535709	0.007482	0.018227
2555.2	0.013780	0.535632	0.007381	0.017981
2555.3	0.013599	0.535555	0.007283	0.017742
2555.4	0.013422	0.535478	0.007187	0.017509
2555.5	0.013249	0.535400	0.007094	0.017280
2555.6	0.013082	0.535323	0.007003	0.017060
2555.7	0.012919	0.535246	0.006915	0.016845
2555.8	0.012761	0.535169	0.006829	0.016637
2555.9	0.012607	0.535091	0.006746	0.016434
2556.0	0.012458	0.535014	0.006665	0.016237
2556.1	0.012313	0.534995	0.006587	0.016047
2556.2	0.012173	0.534975	0.006512	0.015864
2556.3	0.012037	0.534955	0.006439	0.015687
2556.4	0.011906	0.534935	0.006369	0.015515
2556.5	0.011779	0.534915	0.006301	0.015349
2556.6	0.011656	0.534895	0.006235	0.015188
2556.7	0.011538	0.534875	0.006171	0.015034
2556.8	0.011423	0.534855	0.006110	0.014884

2556.9	0.011313	0.534835	0.006051	0.014740
2557.0	0.011207	0.534815	0.005994	0.014601
2557.1	0.011105	0.534832	0.005939	0.014469
2557.2	0.011008	0.534849	0.005888	0.014343
2557.3	0.010914	0.534865	0.005838	0.014221
2557.4	0.010824	0.534882	0.005790	0.014104
2557.5	0.010738	0.534898	0.005744	0.013992
2557.6	0.010656	0.534915	0.005700	0.013886
2557.7	0.010578	0.534931	0.005659	0.013785
2557.8	0.010504	0.534948	0.005619	0.013689
2557.9	0.010433	0.534964	0.005581	0.013596
2558.0	0.010366	0.534981	0.005546	0.013510
2558.1	0.010303	0.535303	0.005515	0.013436
2558.2	0.010244	0.535625	0.005487	0.013367
2558.3	0.010188	0.535948	0.005460	0.013302
2558.4	0.010136	0.536270	0.005436	0.013242
2558.5	0.010087	0.536592	0.005413	0.013186
2558.6	0.010042	0.536914	0.005392	0.013135
2558.7	0.010000	0.537237	0.005372	0.013087
2558.8	0.009932	0.537559	0.005339	0.013007
2558.9	0.009865	0.537881	0.005306	0.012926
2559.0	0.009798	0.538203	0.005273	0.012846
2559.1	0.009732	0.538516	0.005241	0.012767
2559.2	0.009666	0.538828	0.005208	0.012688
2559.3	0.009601	0.539141	0.005176	0.012610
2559.4	0.009536	0.539453	0.005144	0.012532
2559.5	0.009472	0.539764	0.005113	0.012455
2559.6	0.009409	0.540075	0.005081	0.012379
2559.7	0.009345	0.540385	0.005050	0.012302
2559.8	0.009283	0.540696	0.005019	0.012227
2559.9	0.009220	0.541007	0.004988	0.012152
2560.0	0.009159	0.541318	0.004958	0.012078
2560.1	0.009097	0.541152	0.004923	0.011993
2560.2	0.009037	0.540986	0.004889	0.011909
2560.3	0.008976	0.540820	0.004855	0.011826
2560.4	0.008917	0.540654	0.004821	0.011744
2560.5	0.008857	0.540488	0.004787	0.011662
2560.6	0.008798	0.540322	0.004754	0.011580
2560.7	0.008739	0.540156	0.004721	0.011500
2560.8	0.008681	0.539990	0.004688	0.011420
2560.9	0.008623	0.539825	0.004655	0.011340
2561.0	0.008566	0.539659	0.004623	0.011262
2561.1	0.008509	0.539456	0.004590	0.011182

2561.2	0.008453	0.539253	0.004558	0.011104
2561.3	0.008397	0.539051	0.004526	0.011026
2561.4	0.008341	0.538848	0.004494	0.010949
2561.5	0.008285	0.538646	0.004463	0.010872
2561.6	0.008231	0.538444	0.004432	0.010796
2561.7	0.008176	0.538241	0.004401	0.010720
2561.8	0.008122	0.538039	0.004370	0.010645
2561.9	0.008068	0.537836	0.004339	0.010571
2562.0	0.008014	0.537634	0.004309	0.010496
2562.1	0.007961	0.537453	0.004279	0.010423
2562.2	0.007908	0.537272	0.004249	0.010351
2562.3	0.007856	0.537091	0.004219	0.010278
2562.4	0.007804	0.536910	0.004190	0.010207
2562.5	0.007752	0.536729	0.004161	0.010136
2562.6	0.007700	0.536548	0.004132	0.010065
2562.7	0.007649	0.536368	0.004103	0.009995
2562.8	0.007598	0.536187	0.004074	0.009925
2562.9	0.007548	0.536006	0.004046	0.009855
2563.0	0.007497	0.535825	0.004017	0.009786
2563.1	0.007447	0.535648	0.003989	0.009718
2563.2	0.007398	0.535470	0.003961	0.009650
2563.3	0.007348	0.535292	0.003933	0.009582
2563.4	0.007299	0.535115	0.003906	0.009515
2563.5	0.007250	0.534937	0.003878	0.009448
2563.6	0.007201	0.534760	0.003851	0.009381
2563.7	0.007153	0.534582	0.003824	0.009315
2563.8	0.007105	0.534405	0.003797	0.009249
2563.9	0.007057	0.534227	0.003770	0.009184
2564.0	0.007009	0.534050	0.003743	0.009119
2564.1	0.006962	0.534012	0.003718	0.009057
2564.2	0.006914	0.533423	0.003688	0.008985
2564.3	0.006868	0.533385	0.003663	0.008923
2564.4	0.006821	0.533347	0.003638	0.008862
2564.5	0.006774	0.533309	0.003613	0.008801
2564.6	0.006728	0.533272	0.003588	0.008740
2564.7	0.006682	0.533234	0.003563	0.008679
2564.8	0.006636	0.533196	0.003538	0.008619
2564.9	0.006590	0.533158	0.003513	0.008559
2565.0	0.006544	0.533120	0.003489	0.008499
2565.1	0.006499	0.533113	0.003464	0.008440
2565.2	0.006453	0.533106	0.003440	0.008381
2565.3	0.006408	0.533098	0.003416	0.008322
2565.4	0.006363	0.533091	0.003392	0.008263

2565.5	0.006318	0.533084	0.003368	0.008205
2565.6	0.006274	0.533077	0.003344	0.008147
2565.7	0.006229	0.533070	0.003320	0.008089
2565.8	0.006184	0.533063	0.003297	0.008031
2565.9	0.006140	0.533055	0.003273	0.007973
2566.0	0.006096	0.533048	0.003249	0.007916
2566.1	0.006052	0.533018	0.003226	0.007858
2566.2	0.006008	0.532988	0.003202	0.007801
2566.3	0.005964	0.532958	0.003179	0.007743
2566.4	0.005920	0.532928	0.003155	0.007686
2566.5	0.005876	0.532898	0.003132	0.007629
2566.6	0.005833	0.532868	0.003108	0.007572
2566.7	0.005789	0.532838	0.003085	0.007515
2566.8	0.005746	0.532808	0.003061	0.007458
2566.9	0.005703	0.532777	0.003038	0.007401
2567.0	0.005659	0.532197	0.003012	0.007337
2567.1	0.005616	0.532227	0.002989	0.007282
2567.2	0.005573	0.532257	0.002966	0.007226
2567.3	0.005530	0.532287	0.002944	0.007171
2567.4	0.005487	0.532317	0.002921	0.007116
2567.5	0.005444	0.532347	0.002898	0.007061
2567.6	0.005402	0.532377	0.002876	0.007005
2567.7	0.005359	0.532407	0.002853	0.006951
2567.8	0.005316	0.532436	0.002831	0.006896
2567.9	0.005274	0.532466	0.002808	0.006841
2568.0	0.005231	0.532495	0.002786	0.006786
2568.1	0.005189	0.532593	0.002764	0.006732
2568.2	0.005147	0.532691	0.002742	0.006679
2568.3	0.005104	0.533020	0.002721	0.006628
2568.4	0.005062	0.533424	0.002700	0.006578
2568.5	0.005020	0.533521	0.002678	0.006525
2568.6	0.004978	0.533619	0.002656	0.006471
2568.7	0.004936	0.533716	0.002634	0.006418
2568.8	0.004894	0.533814	0.002613	0.006364
2568.9	0.004852	0.533911	0.002591	0.006311
2569.0	0.004810	0.533457	0.002566	0.006251
2569.1	0.004769	0.533480	0.002544	0.006198
2569.2	0.004727	0.533504	0.002522	0.006144
2569.3	0.004685	0.533528	0.002500	0.006090
2569.4	0.004644	0.533551	0.002478	0.006036
2569.5	0.004602	0.533574	0.002456	0.005982
2569.6	0.004561	0.533598	0.002434	0.005929
2569.7	0.004519	0.533621	0.002412	0.005875

2569.8	0.004478	0.533644	0.002390	0.005821
2569.9	0.004437	0.533667	0.002368	0.005768
2570.0	0.004395	0.533691	0.002346	0.005714
2570.1	0.004354	0.533839	0.002324	0.005662
2570.2	0.004313	0.533988	0.002303	0.005610
2570.3	0.004272	0.534136	0.002282	0.005558
2570.4	0.004230	0.534285	0.002260	0.005506
2570.5	0.004189	0.534433	0.002239	0.005454
2570.6	0.004148	0.534581	0.002217	0.005402
2570.7	0.004107	0.534729	0.002196	0.005350
2570.8	0.004066	0.534877	0.002175	0.005298
2570.9	0.004025	0.535026	0.002153	0.005246
2571.0	0.003984	0.535174	0.002132	0.005194
2571.1	0.003943	0.535253	0.002110	0.005141
2571.2	0.003902	0.535332	0.002089	0.005089
2571.3	0.003861	0.535410	0.002067	0.005036
2571.4	0.003820	0.535489	0.002046	0.004983
2571.5	0.003779	0.535567	0.002024	0.004931
2571.6	0.003738	0.535862	0.002003	0.004880
2571.7	0.003698	0.536265	0.001983	0.004830
2571.8	0.003657	0.536343	0.001961	0.004778
2571.9	0.003616	0.536422	0.001940	0.004725
2572.0	0.003575	0.536500	0.001918	0.004672
2572.1	0.003534	0.536302	0.001895	0.004617
2572.2	0.003493	0.536105	0.001873	0.004562
2572.3	0.003453	0.535907	0.001850	0.004507
2572.4	0.003412	0.535709	0.001828	0.004452
2572.5	0.003371	0.535512	0.001805	0.004398
2572.6	0.003330	0.535868	0.001785	0.004347
2572.7	0.003289	0.535671	0.001762	0.004293
2572.8	0.003249	0.535473	0.001740	0.004238
2572.9	0.003208	0.535275	0.001717	0.004183
2573.0	0.003167	0.535078	0.001695	0.004128
2573.1	0.003126	0.534891	0.001672	0.004074
2573.2	0.003086	0.534704	0.001650	0.004019
2573.3	0.003045	0.534518	0.001627	0.003964
2573.4	0.003004	0.534331	0.001605	0.003910
2573.5	0.002963	0.534144	0.001583	0.003856
2573.6	0.002922	0.533958	0.001560	0.003801
2573.7	0.002881	0.533771	0.001538	0.003746
2573.8	0.002840	0.533585	0.001516	0.003692
2573.9	0.002799	0.533398	0.001493	0.003638
2574.0	0.002759	0.533212	0.001471	0.003583

2574.1	0.002717	0.533117	0.001449	0.003529
2574.2	0.002677	0.533574	0.001428	0.003479
2574.3	0.002635	0.533480	0.001406	0.003425
2574.4	0.002595	0.533385	0.001384	0.003371
2574.5	0.002553	0.533290	0.001362	0.003317
2574.6	0.002512	0.533196	0.001340	0.003263
2574.7	0.002471	0.533102	0.001317	0.003209
2574.8	0.002430	0.533007	0.001295	0.003155
2574.9	0.002389	0.532913	0.001273	0.003101
2575.0	0.002348	0.532819	0.001251	0.003047
2575.1	0.002306	0.532731	0.001229	0.002993
2575.2	0.002265	0.532643	0.001206	0.002939
2575.3	0.002224	0.532555	0.001184	0.002885
2575.4	0.002182	0.532467	0.001162	0.002831
2575.5	0.002141	0.532379	0.001140	0.002777
2575.6	0.002099	0.532291	0.001117	0.002722
2575.7	0.002058	0.532204	0.001095	0.002668
2575.8	0.002016	0.532116	0.001073	0.002614
2575.9	0.001975	0.532577	0.001052	0.002562
2576.0	0.001933	0.532489	0.001029	0.002507
2576.1	0.001891	0.532487	0.001007	0.002453
2576.2	0.001850	0.532485	0.000985	0.002399
2576.3	0.001808	0.532483	0.000963	0.002345
2576.4	0.001766	0.532481	0.000940	0.002291
2576.5	0.001724	0.532479	0.000918	0.002236
2576.6	0.001682	0.532477	0.000896	0.002182
2576.7	0.001640	0.532475	0.000873	0.002127
2576.8	0.001598	0.532471	0.000851	0.002072
2576.9	0.001555	0.532467	0.000828	0.002018
2577.0	0.001513	0.532463	0.000806	0.001963
2577.1	0.001471	0.532436	0.000783	0.001908
2577.2	0.001428	0.532409	0.000760	0.001852
2577.3	0.001386	0.532382	0.000738	0.001797
2577.4	0.001343	0.532287	0.000715	0.001742
2577.5	0.001301	0.532176	0.000692	0.001686
2577.6	0.001258	0.532064	0.000669	0.001631
2577.7	0.001215	0.531953	0.000646	0.001575
2577.8	0.001172	0.531841	0.000623	0.001519
2577.9	0.001129	0.531730	0.000601	0.001463
2578.0	0.001086	0.531632	0.000578	0.001407
2578.1	0.001043	0.530870	0.000554	0.001349
2578.2	0.001000	0.530657	0.000531	0.001293
2578.3	0.000910	0.530444	0.000482	0.001175

2578.4	0.000809	0.530231	0.000429	0.001045
2578.5	0.000699	0.530018	0.000370	0.000902
2578.6	0.000579	0.529805	0.000307	0.000747
2578.7	0.000449	0.529592	0.000238	0.000579
2578.8	0.000309	0.529379	0.000164	0.000399
2578.9	0.000160	0.529166	0.000084	0.000206
2579.0	0.000000	0.528953	0.000000	0.000000
CHANNEL 19				
Wavenumber	HIRS Filter Transmittance	Optical Element Transmittance	Product of the HIRS Filter and Optical Element Transmittances	Normalized Value of Column 4
2523.1	0.000196	0.543346	0.000107	0.000317
2523.2	0.000375	0.543389	0.000204	0.000606
2523.3	0.000535	0.543432	0.000291	0.000866
2523.4	0.000678	0.543476	0.000369	0.001097
2523.5	0.000803	0.543519	0.000437	0.001299
2523.6	0.000910	0.543563	0.000495	0.001473
2523.7	0.001000	0.543606	0.000544	0.001618
2523.8	0.001072	0.543650	0.000583	0.001734
2523.9	0.001126	0.543693	0.000612	0.001821
2524.0	0.001162	0.543736	0.000632	0.001880
2524.1	0.001180	0.543421	0.000641	0.001909
2524.2	0.001181	0.543106	0.000641	0.001909
2524.3	0.001164	0.542791	0.000632	0.001880
2524.4	0.001129	0.542476	0.000612	0.001822
2524.5	0.001147	0.542161	0.000622	0.001851
2524.6	0.001166	0.541847	0.000632	0.001880
2524.7	0.001184	0.541532	0.000641	0.001908
2524.8	0.001203	0.541217	0.000651	0.001937
2524.9	0.001221	0.540903	0.000660	0.001965
2525.0	0.001239	0.540588	0.000670	0.001994
2525.1	0.001258	0.540315	0.000680	0.002022
2525.2	0.001276	0.539577	0.000689	0.002049
2525.3	0.001295	0.539222	0.000698	0.002077
2525.4	0.001313	0.538948	0.000708	0.002106
2525.5	0.001331	0.538675	0.000717	0.002134
2525.6	0.001350	0.538401	0.000727	0.002163
2525.7	0.001368	0.538128	0.000736	0.002191
2525.8	0.001386	0.537855	0.000746	0.002219
2525.9	0.001405	0.537581	0.000755	0.002248
2526.0	0.001423	0.537308	0.000765	0.002276
2526.1	0.001442	0.537436	0.000775	0.002306

2526.2	0.001460	0.537564	0.000785	0.002336
2526.3	0.001479	0.537692	0.000795	0.002366
2526.4	0.001497	0.537819	0.000805	0.002396
2526.5	0.001515	0.537947	0.000815	0.002426
2526.6	0.001534	0.538075	0.000825	0.002456
2526.7	0.001552	0.538202	0.000835	0.002486
2526.8	0.001571	0.538330	0.000846	0.002516
2526.9	0.001589	0.538457	0.000856	0.002546
2527.0	0.001607	0.538585	0.000866	0.002576
2527.1	0.001626	0.538715	0.000876	0.002606
2527.2	0.001644	0.538844	0.000886	0.002637
2527.3	0.001663	0.538974	0.000896	0.002667
2527.4	0.001681	0.539103	0.000906	0.002697
2527.5	0.001699	0.539233	0.000916	0.002727
2527.6	0.001718	0.539363	0.000927	0.002757
2527.7	0.001736	0.539492	0.000937	0.002787
2527.8	0.001755	0.539622	0.000947	0.002818
2527.9	0.001773	0.539751	0.000957	0.002848
2528.0	0.001791	0.539881	0.000967	0.002878
2528.1	0.001810	0.540042	0.000977	0.002909
2528.2	0.001828	0.540202	0.000988	0.002939
2528.3	0.001847	0.540363	0.000998	0.002970
2528.4	0.001865	0.540524	0.001008	0.003000
2528.5	0.001883	0.540684	0.001018	0.003030
2528.6	0.001902	0.540845	0.001029	0.003061
2528.7	0.001920	0.541006	0.001039	0.003092
2528.8	0.001939	0.541167	0.001049	0.003122
2528.9	0.001957	0.541327	0.001059	0.003153
2529.0	0.001975	0.541488	0.001070	0.003183
2529.1	0.001994	0.541610	0.001080	0.003214
2529.2	0.002012	0.541733	0.001090	0.003244
2529.3	0.002031	0.541855	0.001100	0.003275
2529.4	0.002049	0.541978	0.001111	0.003305
2529.5	0.002067	0.542100	0.001121	0.003335
2529.6	0.002086	0.542223	0.001131	0.003366
2529.7	0.002104	0.542345	0.001141	0.003396
2529.8	0.002123	0.542468	0.001151	0.003427
2529.9	0.002141	0.542590	0.001162	0.003457
2530.0	0.002160	0.542712	0.001172	0.003488
2530.1	0.002178	0.542600	0.001182	0.003517
2530.2	0.002196	0.542488	0.001191	0.003546
2530.3	0.002215	0.542377	0.001201	0.003575
2530.4	0.002233	0.542265	0.001211	0.003604

2530.5	0.002252	0.542153	0.001221	0.003633
2530.6	0.002270	0.542042	0.001230	0.003662
2530.7	0.002288	0.541930	0.001240	0.003690
2530.8	0.002307	0.541818	0.001250	0.003719
2530.9	0.002325	0.541707	0.001260	0.003748
2531.0	0.002344	0.541596	0.001269	0.003777
2531.1	0.002362	0.541513	0.001279	0.003806
2531.2	0.002380	0.541431	0.001289	0.003835
2531.3	0.002399	0.541349	0.001299	0.003865
2531.4	0.002417	0.541267	0.001308	0.003894
2531.5	0.002436	0.541185	0.001318	0.003923
2531.6	0.002454	0.541103	0.001328	0.003952
2531.7	0.002472	0.541020	0.001338	0.003981
2531.8	0.002491	0.540938	0.001347	0.004010
2531.9	0.002509	0.541414	0.001359	0.004043
2532.0	0.002528	0.541332	0.001368	0.004072
2532.1	0.002546	0.541337	0.001378	0.004102
2532.2	0.002564	0.541341	0.001388	0.004131
2532.3	0.002583	0.541345	0.001398	0.004161
2532.4	0.002601	0.541349	0.001408	0.004191
2532.5	0.002620	0.541353	0.001418	0.004220
2532.6	0.002638	0.541357	0.001428	0.004250
2532.7	0.002656	0.541361	0.001438	0.004280
2532.8	0.002675	0.541365	0.001448	0.004309
2532.9	0.002693	0.541369	0.001458	0.004339
2533.0	0.002712	0.541373	0.001468	0.004369
2533.1	0.002730	0.541390	0.001478	0.004399
2533.2	0.002749	0.541407	0.001488	0.004428
2533.3	0.002767	0.541425	0.001498	0.004458
2533.4	0.002785	0.541442	0.001508	0.004488
2533.5	0.002804	0.541459	0.001518	0.004518
2533.6	0.002822	0.541475	0.001528	0.004548
2533.7	0.002841	0.541492	0.001538	0.004577
2533.8	0.002859	0.541509	0.001548	0.004607
2533.9	0.002877	0.541526	0.001558	0.004637
2534.0	0.002896	0.541543	0.001568	0.004667
2534.1	0.002914	0.541557	0.001578	0.004697
2534.2	0.002933	0.541572	0.001588	0.004726
2534.3	0.002951	0.541586	0.001598	0.004756
2534.4	0.002969	0.541601	0.001608	0.004786
2534.5	0.002988	0.541615	0.001618	0.004816
2534.6	0.003006	0.541629	0.001628	0.004845
2534.7	0.003024	0.541644	0.001638	0.004875

2534.8	0.003043	0.541658	0.001648	0.004905
2534.9	0.003061	0.541672	0.001658	0.004935
2535.0	0.003080	0.541686	0.001668	0.004965
2535.1	0.003098	0.541626	0.001678	0.004994
2535.2	0.003117	0.541566	0.001688	0.005023
2535.3	0.003135	0.541506	0.001698	0.005052
2535.4	0.003153	0.541445	0.001707	0.005081
2535.5	0.003172	0.541385	0.001717	0.005110
2535.6	0.003190	0.541325	0.001727	0.005139
2535.7	0.003209	0.541264	0.001737	0.005168
2535.8	0.003227	0.541204	0.001746	0.005197
2535.9	0.003245	0.541143	0.001756	0.005226
2536.0	0.003264	0.541083	0.001766	0.005255
2536.1	0.003282	0.540791	0.001775	0.005282
2536.2	0.003301	0.540500	0.001784	0.005309
2536.3	0.003319	0.540208	0.001793	0.005336
2536.4	0.003337	0.539917	0.001802	0.005362
2536.5	0.003356	0.539626	0.001811	0.005389
2536.6	0.003374	0.539335	0.001820	0.005416
2536.7	0.003393	0.539044	0.001829	0.005442
2536.8	0.003411	0.538753	0.001838	0.005469
2536.9	0.003429	0.538462	0.001847	0.005495
2537.0	0.003448	0.538171	0.001856	0.005522
2537.1	0.003466	0.537917	0.001865	0.005549
2537.2	0.003485	0.537664	0.001874	0.005576
2537.3	0.003503	0.537410	0.001883	0.005603
2537.4	0.003521	0.537157	0.001892	0.005629
2537.5	0.003540	0.536903	0.001901	0.005656
2537.6	0.003558	0.536650	0.001910	0.005683
2537.7	0.003577	0.536397	0.001919	0.005709
2537.8	0.003595	0.536144	0.001927	0.005736
2537.9	0.003614	0.535890	0.001936	0.005763
2538.0	0.003632	0.535637	0.001945	0.005789
2538.1	0.003650	0.535695	0.001955	0.005819
2538.2	0.003669	0.535753	0.001966	0.005849
2538.3	0.003687	0.535811	0.001976	0.005879
2538.4	0.003706	0.535868	0.001986	0.005909
2538.5	0.003724	0.535926	0.001996	0.005939
2538.6	0.003742	0.535432	0.002004	0.005963
2538.7	0.003761	0.535490	0.002014	0.005993
2538.8	0.003779	0.535547	0.002024	0.006023
2538.9	0.003798	0.535605	0.002034	0.006053
2539.0	0.003816	0.535661	0.002044	0.006083

2539.1	0.003834	0.535777	0.002054	0.006114
2539.2	0.003853	0.535893	0.002065	0.006144
2539.3	0.003871	0.536008	0.002075	0.006175
2539.4	0.003890	0.536124	0.002085	0.006206
2539.5	0.003908	0.536240	0.002096	0.006236
2539.6	0.003926	0.536741	0.002107	0.006272
2539.7	0.003945	0.537014	0.002118	0.006304
2539.8	0.003963	0.537130	0.002129	0.006335
2539.9	0.003982	0.537246	0.002139	0.006366
2540.0	0.004000	0.537362	0.002149	0.006397
2540.1	0.004018	0.537568	0.002160	0.006429
2540.2	0.004037	0.537774	0.002171	0.006460
2540.3	0.004055	0.537979	0.002182	0.006492
2540.4	0.004074	0.538185	0.002192	0.006524
2540.5	0.004092	0.538390	0.002203	0.006556
2540.6	0.004110	0.538596	0.002214	0.006588
2540.7	0.004129	0.538801	0.002225	0.006620
2540.8	0.004147	0.539007	0.002235	0.006652
2540.9	0.004166	0.539212	0.002246	0.006684
2541.0	0.004184	0.539418	0.002257	0.006716
2541.1	0.004202	0.539545	0.002267	0.006748
2541.2	0.004221	0.539672	0.002278	0.006779
2541.3	0.004239	0.539800	0.002288	0.006810
2541.4	0.004258	0.539927	0.002299	0.006841
2541.5	0.004276	0.540054	0.002309	0.006872
2541.6	0.004294	0.540181	0.002320	0.006904
2541.7	0.004313	0.540308	0.002330	0.006935
2541.8	0.004331	0.540435	0.002341	0.006966
2541.9	0.004350	0.540562	0.002351	0.006997
2542.0	0.004368	0.540688	0.002362	0.007029
2542.1	0.004386	0.540473	0.002371	0.007055
2542.2	0.004405	0.540257	0.002380	0.007082
2542.3	0.004423	0.539484	0.002386	0.007102
2542.4	0.004442	0.539269	0.002395	0.007128
2542.5	0.004460	0.539054	0.002404	0.007155
2542.6	0.004478	0.538839	0.002413	0.007182
2542.7	0.004497	0.538623	0.002422	0.007208
2542.8	0.004515	0.538408	0.002431	0.007235
2542.9	0.004534	0.538193	0.002440	0.007261
2543.0	0.004552	0.537978	0.002449	0.007288
2543.1	0.004571	0.537758	0.002458	0.007315
2543.2	0.004589	0.537539	0.002467	0.007341
2543.3	0.004607	0.537629	0.002477	0.007372

2543.4	0.004626	0.537500	0.002486	0.007399
2543.5	0.004644	0.537193	0.002495	0.007424
2543.6	0.004663	0.536887	0.002503	0.007450
2543.7	0.004681	0.536581	0.002512	0.007475
2543.8	0.004699	0.536274	0.002520	0.007500
2543.9	0.004718	0.535984	0.002529	0.007525
2544.0	0.004736	0.535765	0.002537	0.007551
2544.1	0.004755	0.535595	0.002547	0.007578
2544.2	0.004773	0.535425	0.002556	0.007605
2544.3	0.004791	0.535255	0.002565	0.007632
2544.4	0.004810	0.535085	0.002574	0.007659
2544.5	0.004828	0.534916	0.002583	0.007686
2544.6	0.004847	0.534746	0.002592	0.007713
2544.7	0.004865	0.534576	0.002601	0.007740
2544.8	0.004883	0.534406	0.002610	0.007766
2544.9	0.004902	0.534237	0.002619	0.007793
2545.0	0.004920	0.534067	0.002628	0.007820
2545.1	0.004939	0.533954	0.002637	0.007848
2545.2	0.004957	0.533841	0.002646	0.007875
2545.3	0.004975	0.533728	0.002656	0.007903
2545.4	0.004994	0.533615	0.002665	0.007930
2545.5	0.005012	0.533502	0.002674	0.007958
2545.6	0.005031	0.533389	0.002683	0.007985
2545.7	0.005049	0.533276	0.002693	0.008013
2545.8	0.005068	0.533163	0.002702	0.008040
2545.9	0.005086	0.533050	0.002711	0.008068
2546.0	0.005104	0.532937	0.002720	0.008095
2546.1	0.005123	0.533186	0.002731	0.008128
2546.2	0.005141	0.533436	0.002742	0.008161
2546.3	0.005160	0.533685	0.002754	0.008194
2546.4	0.005178	0.533935	0.002765	0.008227
2546.5	0.005196	0.534184	0.002776	0.008261
2546.6	0.005215	0.534434	0.002787	0.008294
2546.7	0.005233	0.534683	0.002798	0.008327
2546.8	0.005252	0.534933	0.002809	0.008360
2546.9	0.005270	0.535183	0.002820	0.008393
2547.0	0.005288	0.535432	0.002832	0.008426
2547.1	0.005307	0.535669	0.002843	0.008460
2547.2	0.005325	0.535905	0.002854	0.008493
2547.3	0.005344	0.536141	0.002865	0.008526
2547.4	0.005362	0.536377	0.002876	0.008559
2547.5	0.005380	0.536614	0.002887	0.008592
2547.6	0.005399	0.536850	0.002898	0.008625

2547.7	0.005417	0.537087	0.002910	0.008659
2547.8	0.005436	0.537878	0.002924	0.008701
2547.9	0.005454	0.538115	0.002935	0.008734
2548.0	0.005472	0.538351	0.002946	0.008767
2548.1	0.005491	0.538246	0.002955	0.008795
2548.2	0.005509	0.538140	0.002965	0.008823
2548.3	0.005528	0.538035	0.002974	0.008851
2548.4	0.005546	0.537929	0.002983	0.008878
2548.5	0.005564	0.537824	0.002993	0.008906
2548.6	0.005583	0.537382	0.003000	0.008928
2548.7	0.005601	0.537070	0.003008	0.008952
2548.8	0.005620	0.536965	0.003018	0.008980
2548.9	0.005638	0.536860	0.003027	0.009008
2549.0	0.005656	0.536755	0.003036	0.009035
2549.1	0.005675	0.536643	0.003045	0.009063
2549.2	0.005693	0.536531	0.003055	0.009090
2549.3	0.005712	0.536420	0.003064	0.009118
2549.4	0.005730	0.536308	0.003073	0.009145
2549.5	0.005749	0.536197	0.003082	0.009173
2549.6	0.005767	0.536085	0.003092	0.009200
2549.7	0.005785	0.535974	0.003101	0.009228
2549.8	0.005804	0.535862	0.003110	0.009255
2549.9	0.005822	0.535750	0.003119	0.009283
2550.0	0.005841	0.535639	0.003128	0.009310
2550.1	0.005859	0.535436	0.003137	0.009336
2550.2	0.005877	0.535234	0.003146	0.009362
2550.3	0.005896	0.535031	0.003154	0.009387
2550.4	0.005914	0.534828	0.003163	0.009413
2550.5	0.005933	0.534625	0.003172	0.009439
2550.6	0.005951	0.534422	0.003180	0.009464
2550.7	0.005969	0.534219	0.003189	0.009490
2550.8	0.005988	0.534340	0.003199	0.009521
2550.9	0.006006	0.534352	0.003209	0.009551
2551.0	0.006025	0.534149	0.003218	0.009577
2551.1	0.006043	0.533972	0.003227	0.009603
2551.2	0.006061	0.533795	0.003235	0.009629
2551.3	0.006080	0.533617	0.003244	0.009655
2551.4	0.006098	0.533440	0.003253	0.009681
2551.5	0.006117	0.533263	0.003262	0.009707
2551.6	0.006135	0.533085	0.003270	0.009733
2551.7	0.006153	0.532907	0.003279	0.009759
2551.8	0.006172	0.532730	0.003288	0.009785
2551.9	0.006190	0.532552	0.003297	0.009811

2552.0	0.006209	0.532374	0.003305	0.009836
2552.1	0.006227	0.532576	0.003316	0.009869
2552.2	0.006245	0.532777	0.003327	0.009902
2552.3	0.006264	0.532978	0.003338	0.009935
2552.4	0.006282	0.533179	0.003350	0.009968
2552.5	0.006301	0.533381	0.003361	0.010001
2552.6	0.006319	0.533582	0.003372	0.010034
2552.7	0.006337	0.533783	0.003383	0.010067
2552.8	0.006356	0.533985	0.003394	0.010100
2552.9	0.006374	0.534186	0.003405	0.010133
2553.0	0.006393	0.534387	0.003416	0.010166
2553.1	0.006411	0.534546	0.003427	0.010198
2553.2	0.006429	0.534704	0.003438	0.010231
2553.3	0.006448	0.534862	0.003449	0.010263
2553.4	0.006466	0.535020	0.003460	0.010296
2553.5	0.006485	0.535178	0.003470	0.010328
2553.6	0.006503	0.535336	0.003481	0.010360
2553.7	0.006522	0.535494	0.003492	0.010393
2553.8	0.006540	0.535652	0.003503	0.010425
2553.9	0.006558	0.535810	0.003514	0.010457
2554.0	0.006577	0.535968	0.003525	0.010490
2554.1	0.006595	0.535950	0.003535	0.010519
2554.2	0.006613	0.535932	0.003544	0.010548
2554.3	0.006632	0.535914	0.003554	0.010577
2554.4	0.006650	0.535896	0.003564	0.010606
2554.5	0.006669	0.535877	0.003574	0.010635
2554.6	0.006687	0.535859	0.003583	0.010664
2554.7	0.006705	0.535841	0.003593	0.010693
2554.8	0.006724	0.535823	0.003603	0.010722
2554.9	0.006742	0.535804	0.003613	0.010751
2555.0	0.006761	0.535786	0.003622	0.010780
2555.1	0.006779	0.535709	0.003632	0.010808
2555.2	0.006797	0.535632	0.003641	0.010835
2555.3	0.006816	0.535555	0.003650	0.010863
2555.4	0.006834	0.535478	0.003660	0.010891
2555.5	0.006853	0.535400	0.003669	0.010919
2555.6	0.006871	0.535323	0.003678	0.010946
2555.7	0.006890	0.535246	0.003688	0.010974
2555.8	0.006908	0.535169	0.003697	0.011002
2555.9	0.006926	0.535091	0.003706	0.011030
2556.0	0.006945	0.535014	0.003716	0.011057
2556.1	0.006963	0.534995	0.003725	0.011086
2556.2	0.006982	0.534975	0.003735	0.011115

2556.3	0.007000	0.534955	0.003745	0.011144
2556.4	0.007018	0.534935	0.003754	0.011173
2556.5	0.007037	0.534915	0.003764	0.011202
2556.6	0.007055	0.534895	0.003774	0.011231
2556.7	0.007074	0.534875	0.003783	0.011259
2556.8	0.007092	0.534855	0.003793	0.011288
2556.9	0.007110	0.534835	0.003803	0.011317
2557.0	0.007129	0.534815	0.003813	0.011346
2557.1	0.007147	0.534832	0.003823	0.011376
2557.2	0.007166	0.534849	0.003833	0.011405
2557.3	0.007184	0.534865	0.003842	0.011435
2557.4	0.007202	0.534882	0.003852	0.011465
2557.5	0.007221	0.534898	0.003862	0.011494
2557.6	0.007239	0.534915	0.003872	0.011524
2557.7	0.007258	0.534931	0.003882	0.011554
2557.8	0.007276	0.534948	0.003892	0.011583
2557.9	0.007294	0.534964	0.003902	0.011613
2558.0	0.007313	0.534981	0.003912	0.011643
2558.1	0.007331	0.535303	0.003924	0.011679
2558.2	0.007350	0.535625	0.003937	0.011715
2558.3	0.007368	0.535948	0.003949	0.011752
2558.4	0.007386	0.536270	0.003961	0.011788
2558.5	0.007405	0.536592	0.003973	0.011825
2558.6	0.007423	0.536914	0.003986	0.011861
2558.7	0.007442	0.537237	0.003998	0.011898
2558.8	0.007460	0.537559	0.004010	0.011934
2558.9	0.007478	0.537881	0.004023	0.011971
2559.0	0.007497	0.538203	0.004035	0.012008
2559.1	0.007515	0.538516	0.004047	0.012044
2559.2	0.007534	0.538828	0.004059	0.012080
2559.3	0.007552	0.539141	0.004072	0.012117
2559.4	0.007571	0.539453	0.004084	0.012154
2559.5	0.007589	0.539764	0.004096	0.012190
2559.6	0.007607	0.540075	0.004109	0.012227
2559.7	0.007626	0.540385	0.004121	0.012264
2559.8	0.007644	0.540696	0.004133	0.012300
2559.9	0.007663	0.541007	0.004146	0.012337
2560.0	0.007681	0.541318	0.004158	0.012374
2560.1	0.007699	0.541152	0.004167	0.012399
2560.2	0.007718	0.540986	0.004175	0.012425
2560.3	0.007736	0.540820	0.004184	0.012451
2560.4	0.007755	0.540654	0.004193	0.012477
2560.5	0.007773	0.540488	0.004201	0.012503

2560.6	0.007791	0.540322	0.004210	0.012528
2560.7	0.007810	0.540156	0.004219	0.012554
2560.8	0.007828	0.539990	0.004227	0.012580
2560.9	0.007847	0.539825	0.004236	0.012605
2561.0	0.007865	0.539659	0.004244	0.012631
2561.1	0.007883	0.539456	0.004253	0.012656
2561.2	0.007902	0.539253	0.004261	0.012681
2561.3	0.007920	0.539051	0.004269	0.012705
2561.4	0.007939	0.538848	0.004278	0.012730
2561.5	0.007957	0.538646	0.004286	0.012755
2561.6	0.007976	0.538444	0.004294	0.012780
2561.7	0.007994	0.538241	0.004303	0.012804
2561.8	0.008012	0.538039	0.004311	0.012829
2561.9	0.008031	0.537836	0.004319	0.012854
2562.0	0.008049	0.537634	0.004327	0.012878
2562.1	0.008068	0.537453	0.004336	0.012903
2562.2	0.008086	0.537272	0.004344	0.012929
2562.3	0.008104	0.537091	0.004353	0.012954
2562.4	0.008123	0.536910	0.004361	0.012979
2562.5	0.008141	0.536729	0.004370	0.013004
2562.6	0.008160	0.536548	0.004378	0.013029
2562.7	0.008178	0.536368	0.004386	0.013054
2562.8	0.008196	0.536187	0.004395	0.013079
2562.9	0.008215	0.536006	0.004403	0.013103
2563.0	0.008233	0.535825	0.004412	0.013128
2563.1	0.008252	0.535648	0.004420	0.013153
2563.2	0.008270	0.535470	0.004428	0.013178
2563.3	0.008288	0.535292	0.004437	0.013203
2563.4	0.008307	0.535115	0.004445	0.013228
2563.5	0.008325	0.534937	0.004453	0.013253
2563.6	0.008344	0.534760	0.004462	0.013278
2563.7	0.008362	0.534582	0.004470	0.013303
2563.8	0.008380	0.534405	0.004479	0.013328
2563.9	0.008399	0.534227	0.004487	0.013353
2564.0	0.008417	0.534050	0.004495	0.013377
2564.1	0.008436	0.534012	0.004505	0.013406
2564.2	0.008454	0.533423	0.004510	0.013420
2564.3	0.008472	0.533385	0.004519	0.013448
2564.4	0.008491	0.533347	0.004529	0.013477
2564.5	0.008509	0.533309	0.004538	0.013505
2564.6	0.008528	0.533272	0.004548	0.013533
2564.7	0.008546	0.533234	0.004557	0.013561
2564.8	0.008564	0.533196	0.004567	0.013590

2564.9	0.008583	0.533158	0.004576	0.013618
2565.0	0.008601	0.533120	0.004585	0.013646
2565.1	0.008620	0.533113	0.004595	0.013675
2565.2	0.008638	0.533106	0.004605	0.013704
2565.3	0.008656	0.533098	0.004615	0.013733
2565.4	0.008675	0.533091	0.004624	0.013762
2565.5	0.008693	0.533084	0.004634	0.013791
2565.6	0.008712	0.533077	0.004644	0.013820
2565.7	0.008730	0.533070	0.004654	0.013849
2565.8	0.008748	0.533063	0.004663	0.013878
2565.9	0.008767	0.533055	0.004673	0.013907
2566.0	0.008785	0.533048	0.004683	0.013936
2566.1	0.008804	0.533018	0.004693	0.013965
2566.2	0.008822	0.532988	0.004702	0.013993
2566.3	0.008840	0.532958	0.004712	0.014022
2566.4	0.008859	0.532928	0.004721	0.014050
2566.5	0.008877	0.532898	0.004731	0.014078
2566.6	0.008896	0.532868	0.004740	0.014107
2566.7	0.008914	0.532838	0.004750	0.014135
2566.8	0.008932	0.532808	0.004759	0.014163
2566.9	0.008951	0.532777	0.004769	0.014192
2567.0	0.008969	0.532197	0.004773	0.014205
2567.1	0.008988	0.532227	0.004783	0.014235
2567.2	0.009006	0.532257	0.004794	0.014265
2567.3	0.009024	0.532287	0.004804	0.014295
2567.4	0.009043	0.532317	0.004814	0.014325
2567.5	0.009061	0.532347	0.004824	0.014355
2567.6	0.009080	0.532377	0.004834	0.014385
2567.7	0.009098	0.532407	0.004844	0.014415
2567.8	0.009117	0.532436	0.004854	0.014445
2567.9	0.009135	0.532466	0.004864	0.014475
2568.0	0.009153	0.532495	0.004874	0.014505
2568.1	0.009172	0.532593	0.004885	0.014537
2568.2	0.009190	0.532691	0.004896	0.014569
2568.3	0.009209	0.533020	0.004908	0.014607
2568.4	0.009227	0.533424	0.004922	0.014647
2568.5	0.009245	0.533521	0.004933	0.014679
2568.6	0.009264	0.533619	0.004943	0.014711
2568.7	0.009282	0.533716	0.004954	0.014743
2568.8	0.009301	0.533814	0.004965	0.014775
2568.9	0.009319	0.533911	0.004976	0.014807
2569.0	0.009337	0.533457	0.004981	0.014823
2569.1	0.009356	0.533480	0.004991	0.014853

2569.2	0.009374	0.533504	0.005001	0.014883
2569.3	0.009393	0.533528	0.005011	0.014913
2569.4	0.009411	0.533551	0.005021	0.014943
2569.5	0.009429	0.533574	0.005031	0.014973
2569.6	0.009448	0.533598	0.005041	0.015003
2569.7	0.009466	0.533621	0.005051	0.015033
2569.8	0.009485	0.533644	0.005061	0.015063
2569.9	0.009503	0.533667	0.005071	0.015093
2570.0	0.009522	0.533691	0.005082	0.015122
2570.1	0.009540	0.533839	0.005093	0.015156
2570.2	0.009558	0.533988	0.005104	0.015189
2570.3	0.009577	0.534136	0.005115	0.015223
2570.4	0.009595	0.534285	0.005127	0.015256
2570.5	0.009614	0.534433	0.005138	0.015290
2570.6	0.009632	0.534581	0.005149	0.015323
2570.7	0.009650	0.534729	0.005160	0.015357
2570.8	0.009669	0.534877	0.005172	0.015390
2570.9	0.009687	0.535026	0.005183	0.015424
2571.0	0.009706	0.535174	0.005194	0.015457
2571.1	0.009724	0.535253	0.005205	0.015489
2571.2	0.009742	0.535332	0.005215	0.015521
2571.3	0.009761	0.535410	0.005226	0.015552
2571.4	0.009779	0.535489	0.005237	0.015584
2571.5	0.009798	0.535567	0.005247	0.015615
2571.6	0.009816	0.535862	0.005260	0.015654
2571.7	0.009834	0.536265	0.005274	0.015695
2571.8	0.009853	0.536343	0.005284	0.015726
2571.9	0.009871	0.536422	0.005295	0.015758
2572.0	0.009890	0.536500	0.005306	0.015790
2572.1	0.009908	0.536302	0.005314	0.015813
2572.2	0.009926	0.536105	0.005322	0.015837
2572.3	0.009945	0.535907	0.005329	0.015860
2572.4	0.009963	0.535709	0.005337	0.015884
2572.5	0.009982	0.535512	0.005345	0.015907
2572.6	0.010000	0.535868	0.005359	0.015947
2572.7	0.010019	0.535671	0.005367	0.015972
2572.8	0.010039	0.535473	0.005376	0.015998
2572.9	0.010060	0.535275	0.005385	0.016025
2573.0	0.010081	0.535078	0.005394	0.016053
2573.1	0.010102	0.534891	0.005403	0.016080
2573.2	0.010124	0.534704	0.005413	0.016110
2573.3	0.010147	0.534518	0.005424	0.016141
2573.4	0.010170	0.534331	0.005434	0.016172

2573.5	0.010194	0.534144	0.005445	0.016204
2573.6	0.010218	0.533958	0.005456	0.016237
2573.7	0.010242	0.533771	0.005467	0.016269
2573.8	0.010268	0.533585	0.005479	0.016305
2573.9	0.010293	0.533398	0.005490	0.016339
2574.0	0.010320	0.533212	0.005503	0.016376
2574.1	0.010346	0.533117	0.005516	0.016414
2574.2	0.010374	0.533574	0.005535	0.016473
2574.3	0.010402	0.533480	0.005549	0.016514
2574.4	0.010430	0.533385	0.005563	0.016556
2574.5	0.010459	0.533290	0.005578	0.016599
2574.6	0.010489	0.533196	0.005593	0.016644
2574.7	0.010519	0.533102	0.005608	0.016688
2574.8	0.010550	0.533007	0.005623	0.016734
2574.9	0.010581	0.532913	0.005639	0.016781
2575.0	0.010613	0.532819	0.005655	0.016828
2575.1	0.010628	0.532731	0.005662	0.016849
2575.2	0.010646	0.532643	0.005671	0.016875
2575.3	0.010667	0.532555	0.005681	0.016906
2575.4	0.010692	0.532467	0.005693	0.016942
2575.5	0.010719	0.532379	0.005707	0.016982
2575.6	0.010749	0.532291	0.005722	0.017027
2575.7	0.010783	0.532204	0.005739	0.017078
2575.8	0.010819	0.532116	0.005757	0.017132
2575.9	0.010859	0.532577	0.005783	0.017211
2576.0	0.010902	0.532489	0.005805	0.017276
2576.1	0.010947	0.532487	0.005829	0.017347
2576.2	0.010996	0.532485	0.005855	0.017425
2576.3	0.011048	0.532483	0.005883	0.017507
2576.4	0.011103	0.532481	0.005912	0.017594
2576.5	0.011161	0.532479	0.005943	0.017686
2576.6	0.011222	0.532477	0.005975	0.017783
2576.7	0.011286	0.532475	0.006010	0.017884
2576.8	0.011354	0.532471	0.006046	0.017992
2576.9	0.011424	0.532467	0.006083	0.018102
2577.0	0.011497	0.532463	0.006122	0.018218
2577.1	0.011574	0.532436	0.006162	0.018339
2577.2	0.011653	0.532409	0.006204	0.018463
2577.3	0.011736	0.532382	0.006248	0.018594
2577.4	0.011821	0.532287	0.006292	0.018725
2577.5	0.011910	0.532176	0.006338	0.018862
2577.6	0.012002	0.532064	0.006386	0.019004
2577.7	0.012097	0.531953	0.006435	0.019150

2577.8	0.012195	0.531841	0.006486	0.019301
2577.9	0.012296	0.531730	0.006538	0.019457
2578.0	0.012400	0.531632	0.006592	0.019618
2578.1	0.012600	0.530870	0.006689	0.019906
2578.2	0.012700	0.530657	0.006739	0.020056
2578.3	0.012870	0.530444	0.006827	0.020316
2578.4	0.013000	0.530231	0.006893	0.020513
2578.5	0.013200	0.530018	0.006996	0.020820
2578.6	0.013300	0.529805	0.007046	0.020970
2578.7	0.013400	0.529592	0.007097	0.021119
2578.8	0.013600	0.529379	0.007200	0.021426
2578.9	0.013700	0.529166	0.007250	0.021574
2579.0	0.013900	0.528953	0.007352	0.021881
2579.1	0.014000	0.528716	0.007402	0.022028
2579.2	0.014100	0.528479	0.007452	0.022175
2579.3	0.014290	0.527696	0.007541	0.022441
2579.4	0.014400	0.527459	0.007595	0.022604
2579.5	0.014600	0.527222	0.007697	0.022907
2579.6	0.014700	0.526985	0.007747	0.023054
2579.7	0.014900	0.526748	0.007849	0.023357
2579.8	0.015000	0.526511	0.007898	0.023503
2579.9	0.015100	0.526274	0.007947	0.023649
2580.0	0.015269	0.526038	0.008032	0.023903
2580.1	0.015400	0.525529	0.008093	0.024085
2580.2	0.015500	0.525565	0.008146	0.024243
2580.3	0.015670	0.525600	0.008236	0.024510
2580.4	0.015800	0.525636	0.008305	0.024715
2580.5	0.015900	0.525672	0.008358	0.024874
2580.6	0.016100	0.525707	0.008464	0.025188
2580.7	0.016200	0.525743	0.008517	0.025346
2580.8	0.016299	0.525778	0.008570	0.025503
2580.9	0.016400	0.525813	0.008623	0.025663
2581.0	0.016500	0.525304	0.008668	0.025794
2581.1	0.016700	0.525394	0.008774	0.026111
2581.2	0.016800	0.525484	0.008828	0.026272
2581.3	0.016890	0.525573	0.008877	0.026417
2581.4	0.017000	0.525663	0.008936	0.026594
2581.5	0.017100	0.525753	0.008990	0.026755
2581.6	0.017200	0.525842	0.009044	0.026916
2581.7	0.017348	0.525932	0.009124	0.027152
2581.8	0.017500	0.526022	0.009205	0.027395
2581.9	0.017600	0.526111	0.009260	0.027556
2582.0	0.017700	0.526201	0.009314	0.027717

2582.1	0.017800	0.525846	0.009360	0.027855
2582.2	0.017900	0.526038	0.009416	0.028022
2582.3	0.018050	0.526229	0.009498	0.028267
2582.4	0.018200	0.526420	0.009581	0.028512
2582.5	0.018300	0.526611	0.009637	0.028679
2582.6	0.018400	0.526802	0.009693	0.028846
2582.7	0.018500	0.526993	0.009749	0.029014
2582.8	0.018700	0.527184	0.009858	0.029338
2582.9	0.018800	0.527375	0.009915	0.029505
2583.0	0.018900	0.527566	0.009971	0.029673
2583.1	0.019068	0.527759	0.010063	0.029947
2583.2	0.019200	0.527952	0.010137	0.030166
2583.3	0.019330	0.528145	0.010209	0.030382
2583.4	0.019500	0.528338	0.010303	0.030660
2583.5	0.019600	0.528531	0.010359	0.030828
2583.6	0.019700	0.528724	0.010416	0.030997
2583.7	0.019900	0.528916	0.010525	0.031323
2583.8	0.020000	0.529109	0.010582	0.031492
2583.9	0.020100	0.529302	0.010639	0.031661
2584.0	0.020300	0.529495	0.010749	0.031988
2584.1	0.020400	0.529267	0.010797	0.032131
2584.2	0.020500	0.529038	0.010845	0.032275
2584.3	0.020690	0.528810	0.010941	0.032560
2584.4	0.020800	0.528581	0.010994	0.032719
2584.5	0.020986	0.528353	0.011088	0.032997
2584.6	0.021100	0.528124	0.011143	0.033162
2584.7	0.021300	0.527895	0.011244	0.033462
2584.8	0.021446	0.527667	0.011316	0.033677
2584.9	0.021600	0.527438	0.011393	0.033904
2585.0	0.021800	0.527209	0.011493	0.034203
2585.1	0.021900	0.526966	0.011541	0.034344
2585.2	0.022100	0.526723	0.011641	0.034642
2585.3	0.022250	0.526480	0.011714	0.034861
2585.4	0.022400	0.526237	0.011788	0.035080
2585.5	0.022581	0.525994	0.011877	0.035346
2585.6	0.022700	0.525751	0.011935	0.035517
2585.7	0.022900	0.525508	0.012034	0.035813
2585.8	0.023100	0.525265	0.012134	0.036109
2585.9	0.023300	0.525022	0.012233	0.036405
2586.0	0.023400	0.524779	0.012280	0.036544
2586.1	0.023610	0.524751	0.012389	0.036870
2586.2	0.023800	0.524723	0.012488	0.037165
2586.3	0.023970	0.524695	0.012577	0.037428

2586.4	0.024154	0.524667	0.012673	0.037713
2586.5	0.024340	0.525183	0.012783	0.038041
2586.6	0.024528	0.525155	0.012881	0.038334
2586.7	0.024700	0.525127	0.012971	0.038600
2586.8	0.024900	0.525098	0.013075	0.038910
2586.9	0.025100	0.525070	0.013179	0.039221
2587.0	0.025300	0.525042	0.013284	0.039531
2587.1	0.025500	0.525032	0.013388	0.039843
2587.2	0.025700	0.525021	0.013493	0.040155
2587.3	0.025890	0.525011	0.013593	0.040451
2587.4	0.026100	0.525001	0.013703	0.040778
2587.5	0.026300	0.524990	0.013807	0.041090
2587.6	0.026500	0.524980	0.013912	0.041401
2587.7	0.026700	0.524969	0.014017	0.041713
2587.8	0.026900	0.524959	0.014121	0.042025
2587.9	0.027100	0.524948	0.014226	0.042336
2588.0	0.027300	0.524938	0.014331	0.042648
2588.1	0.027500	0.525122	0.014441	0.042975
2588.2	0.027700	0.525307	0.014551	0.043303
2588.3	0.027920	0.525491	0.014672	0.043662
2588.4	0.028100	0.525676	0.014771	0.043959
2588.5	0.028347	0.525860	0.014906	0.044361
2588.6	0.028563	0.526045	0.015026	0.044715
2588.7	0.028800	0.526229	0.015155	0.045102
2588.8	0.029000	0.526414	0.015266	0.045431
2588.9	0.029200	0.526598	0.015377	0.045760
2589.0	0.029400	0.526783	0.015487	0.046090
2589.1	0.029700	0.526948	0.015650	0.046575
2589.2	0.029900	0.527113	0.015761	0.046903
2589.3	0.030130	0.527278	0.015887	0.047279
2589.4	0.030400	0.527444	0.016034	0.047717
2589.5	0.030592	0.527609	0.016141	0.048034
2589.6	0.030826	0.528321	0.016286	0.048467
2589.7	0.031100	0.528487	0.016436	0.048912
2589.8	0.031300	0.528652	0.016547	0.049242
2589.9	0.031500	0.528817	0.016658	0.049573
2590.0	0.031800	0.528983	0.016822	0.050060
2590.1	0.032000	0.528985	0.016928	0.050375
2590.2	0.032300	0.528988	0.017086	0.050848
2590.3	0.032540	0.528990	0.017213	0.051226
2590.4	0.032800	0.528992	0.017351	0.051636
2590.5	0.033100	0.528995	0.017510	0.052108
2590.6	0.033300	0.528997	0.017616	0.052423

2590.7	0.033600	0.529000	0.017774	0.052896
2590.8	0.033900	0.529002	0.017933	0.053368
2590.9	0.034200	0.529005	0.018092	0.053841
2591.0	0.034400	0.529008	0.018198	0.054156
2591.1	0.034700	0.528982	0.018356	0.054626
2591.2	0.035008	0.528957	0.018518	0.055107
2591.3	0.035300	0.528931	0.018671	0.055565
2591.4	0.035600	0.528906	0.018829	0.056034
2591.5	0.035900	0.528880	0.018987	0.056504
2591.6	0.036200	0.528855	0.019145	0.056973
2591.7	0.036500	0.528830	0.019302	0.057443
2591.8	0.036800	0.528805	0.019460	0.057912
2591.9	0.037128	0.528780	0.019632	0.058425
2592.0	0.037400	0.528755	0.019775	0.058851
2592.1	0.037800	0.528703	0.019985	0.059474
2592.2	0.038100	0.528651	0.020142	0.059940
2592.3	0.038420	0.528600	0.020309	0.060438
2592.4	0.038800	0.528548	0.020508	0.061030
2592.5	0.039089	0.528497	0.020658	0.061479
2592.6	0.039400	0.528446	0.020821	0.061961
2592.7	0.039800	0.528394	0.021030	0.062584
2592.8	0.040100	0.528342	0.021187	0.063050
2592.9	0.040500	0.528291	0.021396	0.063673
2593.0	0.040800	0.528240	0.021552	0.064138
2593.1	0.041200	0.528198	0.021762	0.064762
2593.2	0.041545	0.528157	0.021943	0.065300
2593.3	0.041910	0.528115	0.022133	0.065868
2593.4	0.042300	0.528073	0.022338	0.066475
2593.5	0.042600	0.528032	0.022494	0.066941
2593.6	0.043000	0.527990	0.022704	0.067565
2593.7	0.043400	0.527949	0.022913	0.068188
2593.8	0.043800	0.527907	0.023122	0.068811
2593.9	0.044200	0.527865	0.023332	0.069434
2594.0	0.044600	0.527824	0.023541	0.070057
2594.1	0.045000	0.527672	0.023745	0.070665
2594.2	0.045300	0.527493	0.023895	0.071112
2594.3	0.045750	0.527314	0.024125	0.071794
2594.4	0.046200	0.527135	0.024354	0.072475
2594.5	0.046600	0.526956	0.024556	0.073078
2594.6	0.047000	0.526777	0.024759	0.073680
2594.7	0.047400	0.526597	0.024961	0.074282
2594.8	0.047800	0.526495	0.025166	0.074894
2594.9	0.048200	0.526398	0.025372	0.075507

2595.0	0.048700	0.526301	0.025631	0.076276
2595.1	0.049100	0.526236	0.025838	0.076893
2595.2	0.049549	0.526170	0.026071	0.077587
2595.3	0.049990	0.526104	0.026300	0.078267
2595.4	0.050400	0.526038	0.026512	0.078899
2595.5	0.050900	0.525972	0.026772	0.079672
2595.6	0.051300	0.525906	0.026979	0.080288
2595.7	0.051800	0.525840	0.027238	0.081060
2595.8	0.052245	0.525773	0.027469	0.081747
2595.9	0.052700	0.525707	0.027705	0.082448
2596.0	0.053200	0.525641	0.027964	0.083220
2596.1	0.053600	0.525574	0.028169	0.083830
2596.2	0.054100	0.525538	0.028432	0.084611
2596.3	0.054600	0.525344	0.028684	0.085361
2596.4	0.055100	0.525250	0.028941	0.086128
2596.5	0.055600	0.525156	0.029199	0.086894
2596.6	0.056067	0.525062	0.029439	0.087609
2596.7	0.056600	0.524967	0.029713	0.088425
2596.8	0.057100	0.524873	0.029970	0.089190
2596.9	0.057600	0.524778	0.030227	0.089955
2597.0	0.058100	0.524684	0.030484	0.090719
2597.1	0.058600	0.524568	0.030740	0.091480
2597.2	0.059100	0.524453	0.030995	0.092240
2597.3	0.059670	0.524338	0.031287	0.093109
2597.4	0.060200	0.524222	0.031558	0.093916
2597.5	0.060700	0.524107	0.031813	0.094675
2597.6	0.061300	0.523992	0.032121	0.095590
2597.7	0.061900	0.523876	0.032428	0.096504
2597.8	0.062400	0.523761	0.032683	0.097262
2597.9	0.063000	0.523645	0.032990	0.098175
2598.0	0.063600	0.523529	0.033296	0.099089
2598.1	0.064100	0.523422	0.033551	0.099847
2598.2	0.064700	0.523315	0.033858	0.100761
2598.3	0.065310	0.523749	0.034206	0.101796
2598.4	0.065910	0.523642	0.034513	0.102709
2598.5	0.066500	0.523535	0.034815	0.103608
2598.6	0.067131	0.523427	0.035138	0.104569
2598.7	0.067800	0.523320	0.035481	0.105590
2598.8	0.068400	0.523212	0.035788	0.106502
2598.9	0.069000	0.523105	0.036094	0.107415
2599.0	0.069700	0.522997	0.036453	0.108482
2599.1	0.070300	0.522854	0.036757	0.109386
2599.2	0.071000	0.522710	0.037112	0.110445

2599.3	0.071640	0.522567	0.037437	0.111410
2599.4	0.072300	0.522423	0.037771	0.112405
2599.5	0.073000	0.522280	0.038126	0.113462
2599.6	0.073700	0.522136	0.038481	0.114519
2599.7	0.074400	0.521993	0.038836	0.115575
2599.8	0.075100	0.521849	0.039191	0.116630
2599.9	0.075800	0.521706	0.039545	0.117685
2600.0	0.076500	0.521562	0.039900	0.118739
2600.1	0.077300	0.521736	0.040330	0.120021
2600.2	0.078000	0.521370	0.040667	0.121022
2600.3	0.078760	0.521543	0.041077	0.122242
2600.4	0.079500	0.521717	0.041476	0.123432
2600.5	0.080300	0.521890	0.041908	0.124715
2600.6	0.081100	0.522064	0.042339	0.126000
2600.7	0.081800	0.522237	0.042719	0.127130
2600.8	0.082600	0.522410	0.043151	0.128415
2600.9	0.083400	0.522584	0.043583	0.129702
2601.0	0.084200	0.522757	0.044016	0.130990
2601.1	0.085000	0.522935	0.044449	0.132279
2601.2	0.085900	0.523112	0.044935	0.133725
2601.3	0.086700	0.523290	0.045369	0.135017
2601.4	0.087543	0.523468	0.045826	0.136376
2601.5	0.088400	0.523645	0.046290	0.137757
2601.6	0.089300	0.523823	0.046777	0.139207
2601.7	0.090100	0.524543	0.047261	0.140647
2601.8	0.091000	0.524721	0.047750	0.142100
2601.9	0.091900	0.524899	0.048238	0.143554
2602.0	0.092794	0.525077	0.048724	0.144999
2602.1	0.093700	0.524974	0.049190	0.146387
2602.2	0.094600	0.524871	0.049653	0.147764
2602.3	0.095540	0.524768	0.050136	0.149203
2602.4	0.096500	0.524665	0.050630	0.150673
2602.5	0.097400	0.524562	0.051092	0.152048
2602.6	0.098400	0.524459	0.051607	0.153579
2602.7	0.099327	0.524357	0.052083	0.154995
2602.8	0.100297	0.524254	0.052581	0.156479
2602.9	0.101277	0.524151	0.053084	0.157977
2603.0	0.102267	0.524048	0.053593	0.159490
2603.1	0.103268	0.523933	0.054105	0.161015
2603.2	0.104278	0.523819	0.054623	0.162555
2603.3	0.105300	0.523704	0.055146	0.164112
2603.4	0.106333	0.523048	0.055617	0.165513
2603.5	0.107376	0.522932	0.056151	0.167101

2603.6	0.108431	0.522818	0.056690	0.168706
2603.7	0.109497	0.522703	0.057235	0.170327
2603.8	0.110575	0.522631	0.057790	0.171980
2603.9	0.111664	0.523000	0.058400	0.173797
2604.0	0.112765	0.522886	0.058963	0.175472
2604.1	0.113878	0.522928	0.059550	0.177218
2604.2	0.115003	0.522970	0.060143	0.178983
2604.3	0.116140	0.523013	0.060743	0.180767
2604.4	0.117289	0.523055	0.061349	0.182571
2604.5	0.118451	0.523098	0.061961	0.184394
2604.6	0.119626	0.523140	0.062581	0.186238
2604.7	0.120813	0.523724	0.063273	0.188297
2604.8	0.122015	0.523767	0.063907	0.190184
2604.9	0.123229	0.523809	0.064549	0.192093
2605.0	0.124458	0.523852	0.065197	0.194024
2605.1	0.125701	0.523885	0.065853	0.195974
2605.2	0.126958	0.523917	0.066515	0.197947
2605.3	0.128230	0.523950	0.067186	0.199942
2605.4	0.129517	0.523983	0.067865	0.201962
2605.5	0.130819	0.524015	0.068551	0.204005
2605.6	0.132135	0.524048	0.069245	0.206071
2605.7	0.133467	0.524081	0.069947	0.208160
2605.8	0.134812	0.524113	0.070657	0.210271
2605.9	0.136172	0.524146	0.071374	0.212405
2606.0	0.137546	0.524179	0.072099	0.214562
2606.1	0.138933	0.524273	0.072839	0.216765
2606.2	0.140335	0.524367	0.073587	0.218991
2606.3	0.141750	0.524460	0.074342	0.221239
2606.4	0.143178	0.524554	0.075105	0.223508
2606.5	0.144621	0.524648	0.075875	0.225800
2606.6	0.146077	0.524742	0.076652	0.228114
2606.7	0.147546	0.524836	0.077438	0.230450
2606.8	0.149031	0.524930	0.078231	0.232810
2606.9	0.150529	0.525023	0.079031	0.235193
2607.0	0.152042	0.525117	0.079840	0.237599
2607.1	0.153570	0.525211	0.080656	0.240029
2607.2	0.155112	0.525305	0.081481	0.242484
2607.3	0.156670	0.525398	0.082314	0.244963
2607.4	0.158243	0.525492	0.083155	0.247466
2607.5	0.159832	0.525585	0.084005	0.249996
2607.6	0.161438	0.525679	0.084864	0.252552
2607.7	0.163060	0.525772	0.085733	0.255136
2607.8	0.164701	0.525866	0.086611	0.257749

2607.9	0.166359	0.525960	0.087498	0.260391
2608.0	0.168037	0.526053	0.088397	0.263064
2608.1	0.169735	0.526021	0.089284	0.265704
2608.2	0.171452	0.525988	0.090182	0.268376
2608.3	0.173190	0.525955	0.091090	0.271080
2608.4	0.174949	0.525922	0.092010	0.273817
2608.5	0.176730	0.525890	0.092940	0.276586
2608.6	0.178531	0.525857	0.093882	0.279387
2608.7	0.180352	0.525824	0.094834	0.282220
2608.8	0.182194	0.525791	0.095796	0.285084
2608.9	0.184055	0.525759	0.096769	0.287978
2609.0	0.185936	0.525726	0.097751	0.290902
2609.1	0.187835	0.525666	0.098738	0.293841
2609.2	0.189753	0.525605	0.099735	0.296807
2609.3	0.191690	0.525545	0.100742	0.299802
2609.4	0.193645	0.525484	0.101757	0.302824
2609.5	0.195617	0.525424	0.102782	0.305873
2609.6	0.197607	0.525364	0.103815	0.308949
2609.7	0.199613	0.525303	0.104858	0.312051
2609.8	0.201637	0.525243	0.105908	0.315177
2609.9	0.203676	0.525182	0.106967	0.318328
2610.0	0.205732	0.525122	0.108034	0.321504
2610.1	0.207803	0.524956	0.109087	0.324638
2610.2	0.209889	0.524790	0.110148	0.327793
2610.3	0.211990	0.524624	0.111215	0.330970
2610.4	0.214106	0.524458	0.112289	0.334168
2610.5	0.216236	0.524292	0.113371	0.337386
2610.6	0.218382	0.524126	0.114460	0.340626
2610.7	0.220544	0.523960	0.115556	0.343889
2610.8	0.222721	0.523794	0.116660	0.347174
2610.9	0.224915	0.523628	0.117772	0.350482
2611.0	0.227125	0.523462	0.118891	0.353815
2611.1	0.229353	0.523268	0.120013	0.357152
2611.2	0.231598	0.523075	0.121143	0.360515
2611.3	0.233860	0.522881	0.122281	0.363902
2611.4	0.236141	0.522687	0.123428	0.367314
2611.5	0.238439	0.522494	0.124583	0.370752
2611.6	0.240756	0.522300	0.125747	0.374216
2611.7	0.243091	0.522106	0.126920	0.377706
2611.8	0.245445	0.521913	0.128101	0.381221
2611.9	0.247817	0.521719	0.129291	0.384763
2612.0	0.250207	0.521525	0.130489	0.388330
2612.1	0.252616	0.521406	0.131716	0.391979

2612.2	0.255044	0.521288	0.132951	0.395656
2612.3	0.257490	0.521169	0.134196	0.399360
2612.4	0.259955	0.521050	0.135450	0.403091
2612.5	0.262438	0.520931	0.136712	0.406849
2612.6	0.264940	0.520813	0.137984	0.410634
2612.7	0.267460	0.520694	0.139265	0.414445
2612.8	0.269998	0.520575	0.140554	0.418282
2612.9	0.272554	0.520456	0.141852	0.422145
2613.0	0.275127	0.520338	0.143159	0.426034
2613.1	0.277718	0.520253	0.144483	0.429975
2613.2	0.280325	0.520168	0.145816	0.433942
2613.3	0.282950	0.520083	0.147158	0.437933
2613.4	0.285592	0.519998	0.148507	0.441950
2613.5	0.288250	0.519914	0.149865	0.445991
2613.6	0.290926	0.519829	0.151232	0.450058
2613.7	0.293619	0.519744	0.152607	0.454150
2613.8	0.296329	0.519122	0.153831	0.457793
2613.9	0.299057	0.519038	0.155222	0.461932
2614.0	0.301803	0.518953	0.156622	0.466098
2614.1	0.304567	0.519063	0.158090	0.470467
2614.2	0.307349	0.519174	0.159568	0.474865
2614.3	0.310150	0.519284	0.161056	0.479294
2614.4	0.312969	0.519394	0.162554	0.483753
2614.5	0.315806	0.519505	0.164063	0.488242
2614.6	0.318660	0.519616	0.165581	0.492759
2614.7	0.321530	0.519726	0.167107	0.497303
2614.8	0.324416	0.519837	0.168643	0.501873
2614.9	0.327316	0.520486	0.170363	0.506992
2615.0	0.330230	0.520597	0.171917	0.511616
2615.1	0.333158	0.520673	0.173467	0.516227
2615.2	0.336098	0.520750	0.175023	0.520860
2615.3	0.339050	0.520827	0.176586	0.525512
2615.4	0.342013	0.520904	0.178156	0.530183
2615.5	0.344986	0.520981	0.179731	0.534870
2615.6	0.347969	0.521058	0.181312	0.539574
2615.7	0.350960	0.521135	0.182897	0.544294
2615.8	0.353960	0.521212	0.184488	0.549027
2615.9	0.356967	0.521288	0.186083	0.553773
2616.0	0.359982	0.521365	0.187682	0.558532
2616.1	0.363003	0.521218	0.189203	0.563060
2616.2	0.366029	0.521071	0.190727	0.567593
2616.3	0.369060	0.520923	0.192252	0.572132
2616.4	0.372096	0.520776	0.193779	0.576675

2616.5	0.375136	0.520629	0.195307	0.581222
2616.6	0.378180	0.520482	0.196836	0.585774
2616.7	0.381230	0.520335	0.198367	0.590331
2616.8	0.384285	0.520188	0.199900	0.594893
2616.9	0.387344	0.520041	0.201435	0.599460
2617.0	0.390410	0.519894	0.202972	0.604033
2617.1	0.393481	0.519733	0.204505	0.608596
2617.2	0.396557	0.519572	0.206040	0.613165
2617.3	0.399640	0.519411	0.207577	0.617740
2617.4	0.402729	0.519250	0.209117	0.622321
2617.5	0.405823	0.519089	0.210658	0.626908
2617.6	0.408922	0.518928	0.212201	0.631500
2617.7	0.412025	0.518767	0.213745	0.636095
2617.8	0.415132	0.518607	0.215290	0.640692
2617.9	0.418241	0.518367	0.216802	0.645192
2618.0	0.421352	0.518126	0.218313	0.649690
2618.1	0.424464	0.518096	0.219914	0.654451
2618.2	0.427577	0.518067	0.221514	0.659213
2618.3	0.430690	0.518037	0.223113	0.663974
2618.4	0.433802	0.518007	0.224712	0.668733
2618.5	0.436913	0.517988	0.226316	0.673503
2618.6	0.440022	0.518038	0.227948	0.678362
2618.7	0.443130	0.518087	0.229580	0.683219
2618.8	0.446237	0.518137	0.231212	0.688075
2618.9	0.449342	0.518186	0.232843	0.692928
2619.0	0.452445	0.518236	0.234473	0.697780
2619.1	0.455545	0.518338	0.236127	0.702701
2619.2	0.458644	0.518440	0.237780	0.707620
2619.3	0.461740	0.518542	0.239432	0.712537
2619.4	0.464833	0.518644	0.241083	0.717451
2619.5	0.467923	0.518746	0.242733	0.722362
2619.6	0.471008	0.518848	0.244381	0.727267
2619.7	0.474087	0.518950	0.246027	0.732165
2619.8	0.477159	0.519052	0.247670	0.737054
2619.9	0.480223	0.519154	0.249310	0.741933
2620.0	0.483278	0.519256	0.250945	0.746800
2620.1	0.486324	0.519185	0.252492	0.751403
2620.2	0.489358	0.519114	0.254033	0.755988
2620.3	0.492380	0.519044	0.255567	0.760553
2620.4	0.495389	0.518436	0.256828	0.764306
2620.5	0.498384	0.518365	0.258345	0.768821
2620.6	0.501365	0.518294	0.259854	0.773314
2620.7	0.504331	0.518223	0.261356	0.777781

2620.8	0.507281	0.518152	0.262849	0.782224
2620.9	0.510214	0.518082	0.264332	0.786640
2621.0	0.513130	0.518011	0.265807	0.791028
2621.1	0.516029	0.517925	0.267264	0.795365
2621.2	0.518909	0.517840	0.268712	0.799672
2621.3	0.521770	0.517754	0.270149	0.803949
2621.4	0.524611	0.517669	0.271575	0.808193
2621.5	0.527432	0.517584	0.272990	0.812405
2621.6	0.530232	0.517498	0.274394	0.816582
2621.7	0.533009	0.517413	0.275786	0.820724
2621.8	0.535764	0.517327	0.277165	0.824830
2621.9	0.538496	0.517242	0.278532	0.828898
2622.0	0.541203	0.517157	0.279886	0.832928
2622.1	0.543884	0.516943	0.281158	0.836710
2622.2	0.546540	0.516730	0.282414	0.840450
2622.3	0.549170	0.516517	0.283656	0.844145
2622.4	0.551772	0.516305	0.284882	0.847796
2622.5	0.554346	0.516092	0.286094	0.851400
2622.6	0.556892	0.515879	0.287289	0.854957
2622.7	0.559409	0.515666	0.288468	0.858467
2622.8	0.561896	0.515453	0.289631	0.861928
2622.9	0.564353	0.515241	0.290778	0.865340
2623.0	0.566780	0.515029	0.291908	0.868703
2623.1	0.569175	0.514803	0.293013	0.871992
2623.2	0.571539	0.514578	0.294101	0.875230
2623.3	0.573870	0.514353	0.295172	0.878415
2623.4	0.576168	0.514128	0.296224	0.881548
2623.5	0.578434	0.513903	0.297259	0.884626
2623.6	0.580665	0.513678	0.298275	0.887650
2623.7	0.582863	0.513453	0.299273	0.890620
2623.8	0.585026	0.513228	0.300252	0.893534
2623.9	0.587154	0.513003	0.301212	0.896391
2624.0	0.589247	0.512779	0.302153	0.899193
2624.1	0.591304	0.512930	0.303297	0.902598
2624.2	0.593325	0.513081	0.304424	0.905949
2624.3	0.595310	0.513231	0.305532	0.909247
2624.4	0.597258	0.513382	0.306622	0.912490
2624.5	0.599170	0.513533	0.307693	0.915680
2624.6	0.601046	0.513684	0.308748	0.918817
2624.7	0.602888	0.513835	0.309785	0.921903
2624.8	0.604695	0.513986	0.310805	0.924939
2624.9	0.606470	0.514137	0.311808	0.927925
2625.0	0.608212	0.514287	0.312796	0.930863

2625.1	0.609922	0.514471	0.313787	0.933814
2625.2	0.611601	0.514654	0.314763	0.936718
2625.3	0.613250	0.514837	0.315724	0.939578
2625.4	0.614869	0.515021	0.316670	0.942394
2625.5	0.616459	0.515203	0.317601	0.945165
2625.6	0.618017	0.515385	0.318517	0.947889
2625.7	0.619545	0.515567	0.319417	0.950568
2625.8	0.621041	0.515749	0.320301	0.953199
2625.9	0.622505	0.515930	0.321169	0.955783
2626.0	0.623936	0.516112	0.322021	0.958319
2626.1	0.625335	0.516239	0.322822	0.960702
2626.2	0.626699	0.516365	0.323606	0.963034
2626.3	0.628030	0.516492	0.324372	0.965315
2626.4	0.629326	0.516618	0.325121	0.967544
2626.5	0.630587	0.516744	0.325853	0.969720
2626.6	0.631814	0.516871	0.326566	0.971845
2626.7	0.633007	0.516997	0.327263	0.973917
2626.8	0.634165	0.517123	0.327941	0.975937
2626.9	0.635288	0.517250	0.328603	0.977905
2627.0	0.636378	0.517376	0.329246	0.979820
2627.1	0.637433	0.517511	0.329878	0.981701
2627.2	0.638453	0.517646	0.330493	0.983531
2627.3	0.639440	0.517782	0.331090	0.985308
2627.4	0.640393	0.517917	0.331670	0.987034
2627.5	0.641311	0.518052	0.332233	0.988708
2627.6	0.642196	0.518188	0.332778	0.990331
2627.7	0.643048	0.518323	0.333307	0.991904
2627.8	0.643867	0.518458	0.333818	0.993427
2627.9	0.644654	0.518594	0.334313	0.994900
2628.0	0.645408	0.518729	0.334792	0.996323
2628.1	0.646130	0.518455	0.334989	0.996911
2628.2	0.646821	0.518181	0.335170	0.997449
2628.3	0.647480	0.517907	0.335334	0.997937
2628.4	0.648108	0.517632	0.335482	0.998377
2628.5	0.648705	0.517358	0.335613	0.998767
2628.6	0.649270	0.517084	0.335727	0.999108
2628.7	0.649804	0.516810	0.335825	0.999399
2628.8	0.650306	0.516536	0.335906	0.999640
2628.9	0.650776	0.516262	0.335971	0.999831
2629.0	0.651214	0.515987	0.336018	0.999972
2629.1	0.651618	0.515681	0.336027	1.000000
2629.2	0.651991	0.515375	0.336019	0.999977
2629.3	0.652330	0.515068	0.335995	0.999902

2629.4	0.652636	0.514762	0.335952	0.999777
2629.5	0.652910	0.514456	0.335893	0.999601
2629.6	0.653151	0.514150	0.335817	0.999375
2629.7	0.653360	0.513844	0.335725	0.999100
2629.8	0.653538	0.513538	0.335616	0.998777
2629.9	0.653685	0.513232	0.335492	0.998406
2630.0	0.653801	0.512926	0.335351	0.997988
2630.1	0.653887	0.512835	0.335336	0.997944
2630.2	0.653943	0.512745	0.335306	0.997854
2630.3	0.653970	0.512655	0.335261	0.997719
2630.4	0.653968	0.512564	0.335201	0.997540
2630.5	0.653938	0.512474	0.335126	0.997317
2630.6	0.653880	0.512383	0.335037	0.997053
2630.7	0.653795	0.512293	0.334934	0.996747
2630.8	0.653684	0.512202	0.334818	0.996401
2630.9	0.653546	0.512111	0.334689	0.996016
2631.0	0.653384	0.512021	0.334546	0.995592
2631.1	0.653196	0.511925	0.334388	0.995121
2631.2	0.652985	0.511830	0.334217	0.994613
2631.3	0.652750	0.511734	0.334034	0.994069
2631.4	0.652492	0.511638	0.333840	0.993491
2631.5	0.652212	0.511543	0.333634	0.992878
2631.6	0.651910	0.511447	0.333417	0.992233
2631.7	0.651586	0.511352	0.333189	0.991554
2631.8	0.651240	0.511256	0.332950	0.990843
2631.9	0.650874	0.511160	0.332701	0.990101
2632.0	0.650488	0.511064	0.332441	0.989328
2632.1	0.650081	0.511004	0.332194	0.988592
2632.2	0.649655	0.510943	0.331937	0.987828
2632.3	0.649210	0.510883	0.331670	0.987034
2632.4	0.648746	0.510823	0.331394	0.986212
2632.5	0.648264	0.510762	0.331109	0.985362
2632.6	0.647764	0.510702	0.330814	0.984486
2632.7	0.647248	0.510641	0.330511	0.983585
2632.8	0.646715	0.510580	0.330200	0.982659
2632.9	0.646167	0.510520	0.329881	0.981709
2633.0	0.645604	0.510460	0.329555	0.980737
2633.1	0.645026	0.510387	0.329213	0.979721
2633.2	0.644435	0.510315	0.328865	0.978685
2633.3	0.643830	0.510243	0.328510	0.977629
2633.4	0.643213	0.510171	0.328149	0.976554
2633.5	0.642584	0.510099	0.327782	0.975462
2633.6	0.641944	0.510027	0.327409	0.974352

2633.7	0.641292	0.509955	0.327030	0.973225
2633.8	0.640629	0.509883	0.326646	0.972082
2633.9	0.639956	0.509811	0.326257	0.970924
2634.0	0.639274	0.509739	0.325863	0.969751
2634.1	0.638581	0.509454	0.325328	0.968158
2634.2	0.637880	0.509168	0.324788	0.966554
2634.3	0.637170	0.508883	0.324245	0.964937
2634.4	0.636452	0.508598	0.323698	0.963309
2634.5	0.635726	0.508313	0.323148	0.961670
2634.6	0.634992	0.508028	0.322593	0.960021
2634.7	0.634250	0.507743	0.322036	0.958363
2634.8	0.633501	0.507458	0.321475	0.956694
2634.9	0.632744	0.507174	0.320911	0.955016
2635.0	0.631981	0.506890	0.320345	0.953329
2635.1	0.631211	0.506606	0.319775	0.951634
2635.2	0.630433	0.506322	0.319202	0.949930
2635.3	0.629650	0.506038	0.318627	0.948217
2635.4	0.628860	0.505754	0.318049	0.946496
2635.5	0.628065	0.504947	0.317140	0.943791
2635.6	0.627264	0.504664	0.316558	0.942059
2635.7	0.626458	0.504381	0.315974	0.940321
2635.8	0.625648	0.504098	0.315388	0.938579
2635.9	0.624834	0.503816	0.314801	0.936832
2636.0	0.624017	0.503533	0.314213	0.935082
2636.1	0.623197	0.503682	0.313893	0.934129
2636.2	0.622374	0.503831	0.313572	0.933173
2636.3	0.621550	0.503981	0.313249	0.932214
2636.4	0.620724	0.504130	0.312926	0.931251
2636.5	0.619897	0.504279	0.312601	0.930284
2636.6	0.619068	0.504428	0.312275	0.929315
2636.7	0.618237	0.504577	0.311948	0.928342
2636.8	0.617405	0.504726	0.311620	0.927366
2636.9	0.616570	0.504875	0.311291	0.926386
2637.0	0.615734	0.505024	0.310960	0.925402
2637.1	0.614895	0.505167	0.310625	0.924403
2637.2	0.614054	0.505835	0.310610	0.924358
2637.3	0.613210	0.505978	0.310271	0.923350
2637.4	0.612364	0.506121	0.309930	0.922337
2637.5	0.611515	0.506265	0.309588	0.921319
2637.6	0.610665	0.506408	0.309245	0.920298
2637.7	0.609812	0.506551	0.308901	0.919272
2637.8	0.608957	0.506694	0.308555	0.918243
2637.9	0.608100	0.506837	0.308208	0.917211

2638.0	0.607242	0.506980	0.307860	0.916175
2638.1	0.606383	0.507117	0.307507	0.915126
2638.2	0.605522	0.507255	0.307154	0.914074
2638.3	0.604660	0.507392	0.306800	0.913020
2638.4	0.603797	0.507529	0.306445	0.911963
2638.5	0.602934	0.507666	0.306089	0.910905
2638.6	0.602071	0.507803	0.305733	0.909847
2638.7	0.601208	0.507940	0.305378	0.908788
2638.8	0.600347	0.508077	0.305022	0.907730
2638.9	0.599486	0.508214	0.304667	0.906674
2639.0	0.598628	0.508351	0.304313	0.905620
2639.1	0.597772	0.508498	0.303966	0.904588
2639.2	0.596920	0.508646	0.303621	0.903560
2639.3	0.596070	0.508794	0.303277	0.902536
2639.4	0.595224	0.508941	0.302934	0.901517
2639.5	0.594383	0.509089	0.302594	0.900504
2639.6	0.593545	0.509237	0.302255	0.899495
2639.7	0.592711	0.509384	0.301918	0.898492
2639.8	0.591882	0.509532	0.301583	0.897495
2639.9	0.591057	0.509679	0.301250	0.896503
2640.0	0.590236	0.509827	0.300918	0.895517
2640.1	0.589419	0.509975	0.300586	0.894534
2640.2	0.588607	0.510123	0.299857	0.893559
2640.3	0.587800	0.510271	0.299330	0.892592
2640.4	0.586997	0.510419	0.298806	0.891632
2640.5	0.586199	0.510567	0.298285	0.890680
2640.6	0.585406	0.510715	0.297766	0.889738
2640.7	0.584618	0.510863	0.297251	0.888804
2640.8	0.583836	0.511011	0.296739	0.887880
2640.9	0.583060	0.511159	0.296230	0.886965
2641.0	0.582291	0.511307	0.295725	0.886061
2641.1	0.581527	0.511455	0.295213	0.885169
2641.2	0.580770	0.511603	0.294705	0.884288
2641.3	0.580020	0.511751	0.294202	0.883419
2641.4	0.579277	0.511899	0.293702	0.882561
2641.5	0.578542	0.512047	0.293206	0.881715
2641.6	0.577814	0.512195	0.292714	0.880880
2641.7	0.577094	0.512343	0.292227	0.880056
2641.8	0.576382	0.512491	0.291744	0.879243
2641.9	0.575678	0.512639	0.291265	0.878441
2642.0	0.574983	0.512787	0.290791	0.877650
2642.1	0.574296	0.512935	0.290374	0.876870
2642.2	0.573619	0.513083	0.289962	0.876101

2642.3	0.572950	0.505374	0.289554	0.861698
2642.4	0.572291	0.505252	0.289151	0.860499
2642.5	0.571640	0.505131	0.288753	0.859314
2642.6	0.570999	0.505009	0.288360	0.858143
2642.7	0.570366	0.504887	0.287971	0.856986
2642.8	0.569742	0.504766	0.287586	0.855842
2642.9	0.569126	0.504644	0.287206	0.854711
2643.0	0.568518	0.504523	0.286830	0.853592
2643.1	0.567918	0.504342	0.286425	0.852385
2643.2	0.567325	0.504161	0.286023	0.851190
2643.3	0.566740	0.503980	0.285626	0.850007
2643.4	0.566162	0.503799	0.285232	0.848836
2643.5	0.565591	0.503546	0.284801	0.847554
2643.6	0.565028	0.503289	0.284373	0.846279
2643.7	0.564473	0.503033	0.283949	0.845016
2643.8	0.563926	0.502776	0.283529	0.843767
2643.9	0.563388	0.502520	0.283113	0.842531
2644.0	0.562857	0.502263	0.282703	0.841308
2644.1	0.562336	0.502329	0.282477	0.840638
2644.2	0.561823	0.502467	0.282298	0.840104
2644.3	0.561320	0.502609	0.282124	0.839587
2644.4	0.560826	0.502750	0.281955	0.839084
2644.5	0.560342	0.502891	0.281791	0.838594
2644.6	0.559866	0.503032	0.281630	0.838118
2644.7	0.559400	0.503172	0.281475	0.837654
2644.8	0.558943	0.503313	0.281323	0.837203
2644.9	0.558495	0.503453	0.281176	0.836766
2645.0	0.558056	0.503593	0.281033	0.836340
2645.1	0.557625	0.503778	0.280919	0.836001
2645.2	0.557203	0.503962	0.280809	0.835675
2645.3	0.556790	0.504491	0.280896	0.835931
2645.4	0.556385	0.504838	0.280884	0.835897
2645.5	0.555989	0.505022	0.280787	0.835607
2645.6	0.555602	0.505206	0.280693	0.835329
2645.7	0.555223	0.505390	0.280604	0.835064
2645.8	0.554853	0.505574	0.280519	0.834811
2645.9	0.554492	0.505758	0.280439	0.834571
2646.0	0.554140	0.505941	0.280363	0.834345
2646.1	0.553798	0.505981	0.280211	0.833895
2646.2	0.553464	0.506021	0.280065	0.833458
2646.3	0.553140	0.506061	0.279923	0.833036
2646.4	0.552825	0.506101	0.279785	0.832627
2646.5	0.552520	0.506141	0.279653	0.832232

2646.6	0.552222	0.506181	0.279524	0.831850
2646.7	0.551934	0.506220	0.279400	0.831481
2646.8	0.551653	0.506260	0.279280	0.831124
2646.9	0.551381	0.506300	0.279164	0.830778
2647.0	0.551115	0.506340	0.279051	0.830443
2647.1	0.550857	0.506430	0.278970	0.830201
2647.2	0.550605	0.506520	0.278892	0.829970
2647.3	0.550360	0.506610	0.278818	0.829748
2647.4	0.550121	0.506700	0.278746	0.829534
2647.5	0.549888	0.506790	0.278678	0.829330
2647.6	0.549661	0.506880	0.278612	0.829134
2647.7	0.549439	0.506970	0.278549	0.828948
2647.8	0.549224	0.507060	0.278489	0.828770
2647.9	0.549015	0.507149	0.278433	0.828602
2648.0	0.548812	0.507239	0.278379	0.828442
2648.1	0.548616	0.507091	0.278198	0.827903
2648.2	0.548425	0.506942	0.278020	0.827372
2648.3	0.548240	0.506793	0.277844	0.826850
2648.4	0.548061	0.506644	0.277672	0.826338
2648.5	0.547889	0.506495	0.277503	0.825835
2648.6	0.547722	0.506346	0.277337	0.825341
2648.7	0.547561	0.506197	0.277174	0.824856
2648.8	0.547406	0.506048	0.277014	0.824379
2648.9	0.547257	0.505899	0.276857	0.823912
2649.0	0.547114	0.505750	0.276703	0.823454
2649.1	0.546977	0.505520	0.276508	0.822873
2649.2	0.546846	0.505290	0.276316	0.822301
2649.3	0.546720	0.505060	0.276126	0.821738
2649.4	0.546600	0.504830	0.275940	0.821183
2649.5	0.546486	0.504600	0.275757	0.820638
2649.6	0.546378	0.504370	0.275577	0.820103
2649.7	0.546277	0.504140	0.275400	0.819578
2649.8	0.546184	0.503910	0.275227	0.819063
2649.9	0.546097	0.503680	0.275058	0.818559
2650.0	0.546018	0.503450	0.274893	0.818067
2650.1	0.545947	0.503553	0.274913	0.818128
2650.2	0.545884	0.503656	0.274938	0.818200
2650.3	0.545830	0.503758	0.274966	0.818286
2650.4	0.545785	0.503861	0.275000	0.818385
2650.5	0.545749	0.503964	0.275037	0.818497
2650.6	0.545722	0.504066	0.275080	0.818623
2650.7	0.545704	0.504169	0.275127	0.818763
2650.8	0.545696	0.504271	0.275179	0.818918

2650.9	0.545697	0.504374	0.275235	0.819086
2651.0	0.545708	0.504476	0.275297	0.819269
2651.1	0.545729	0.504538	0.275341	0.819400
2651.2	0.545759	0.504600	0.275390	0.819546
2651.3	0.545800	0.504661	0.275444	0.819708
2651.4	0.545851	0.504409	0.275332	0.819373
2651.5	0.545912	0.504277	0.275291	0.819251
2651.6	0.545983	0.504338	0.275360	0.819458
2651.7	0.546064	0.504400	0.275435	0.819679
2651.8	0.546155	0.504461	0.275514	0.819916
2651.9	0.546256	0.504523	0.275599	0.820168
2652.0	0.546367	0.504584	0.275688	0.820434
2652.1	0.546488	0.504428	0.275664	0.820362
2652.2	0.546619	0.504272	0.275645	0.820304
2652.3	0.546760	0.504115	0.275630	0.820261
2652.4	0.546910	0.503959	0.275621	0.820233
2652.5	0.547071	0.503803	0.275616	0.820218
2652.6	0.547239	0.503646	0.275615	0.820217
2652.7	0.547417	0.503800	0.275788	0.820732
2652.8	0.547603	0.503841	0.275905	0.821079
2652.9	0.547796	0.503685	0.275917	0.821115
2653.0	0.547997	0.503529	0.275932	0.821160
2653.1	0.548205	0.503389	0.275960	0.821244
2653.2	0.548419	0.503249	0.275992	0.821337
2653.3	0.548640	0.503109	0.276026	0.821439
2653.4	0.548866	0.502970	0.276063	0.821550
2653.5	0.549098	0.502830	0.276103	0.821669
2653.6	0.549335	0.502691	0.276146	0.821796
2653.7	0.549578	0.502552	0.276191	0.821931
2653.8	0.549825	0.502412	0.276239	0.822072
2653.9	0.550077	0.502272	0.276289	0.822221
2654.0	0.550334	0.502133	0.276341	0.822376
2654.1	0.550595	0.502010	0.276404	0.822565
2654.2	0.550861	0.501887	0.276470	0.822760
2654.3	0.551130	0.501764	0.276537	0.822960
2654.4	0.551403	0.501641	0.276606	0.823167
2654.5	0.551680	0.501518	0.276678	0.823378
2654.6	0.551961	0.501395	0.276751	0.823595
2654.7	0.552245	0.501272	0.276825	0.823818
2654.8	0.552533	0.501150	0.276902	0.824045
2654.9	0.552824	0.501027	0.276980	0.824277
2655.0	0.553118	0.500904	0.277059	0.824514
2655.1	0.553416	0.500712	0.277102	0.824641

2655.2	0.553716	0.500519	0.277146	0.824772
2655.3	0.554020	0.500327	0.277191	0.824907
2655.4	0.554326	0.500135	0.277238	0.825046
2655.5	0.554636	0.499943	0.277286	0.825190
2655.6	0.554948	0.499751	0.277336	0.825337
2655.7	0.555263	0.499559	0.277387	0.825489
2655.8	0.555582	0.499367	0.277439	0.825644
2655.9	0.555903	0.499174	0.277492	0.825803
2656.0	0.556227	0.498466	0.277260	0.825113
2656.1	0.556555	0.498472	0.277427	0.825609
2656.2	0.556886	0.498478	0.277595	0.826110
2656.3	0.557220	0.498484	0.277765	0.826615
2656.4	0.557557	0.498490	0.277937	0.827125
2656.5	0.557898	0.498496	0.278110	0.827641
2656.6	0.558243	0.498501	0.278285	0.828162
2656.7	0.558592	0.498507	0.278462	0.828688
2656.8	0.558945	0.498512	0.278641	0.829221
2656.9	0.559304	0.498517	0.278822	0.829761
2657.0	0.559667	0.498522	0.279006	0.830309
2657.1	0.560036	0.498584	0.279225	0.830959
2657.2	0.560410	0.498646	0.279446	0.831617
2657.3	0.560790	0.498708	0.279670	0.832284
2657.4	0.561176	0.498769	0.279898	0.832961
2657.5	0.561569	0.498831	0.280128	0.833646
2657.6	0.561968	0.498892	0.280361	0.834341
2657.7	0.562372	0.498953	0.280598	0.835044
2657.8	0.562783	0.499014	0.280837	0.835756
2657.9	0.563199	0.499076	0.281079	0.836476
2658.0	0.563621	0.499137	0.281324	0.837205
2658.1	0.564048	0.499052	0.281489	0.837698
2658.2	0.564482	0.498967	0.281658	0.838199
2658.3	0.564920	0.498882	0.281829	0.838708
2658.4	0.565364	0.498798	0.282002	0.839224
2658.5	0.565812	0.498713	0.282178	0.839747
2658.6	0.566266	0.498628	0.282356	0.840277
2658.7	0.566723	0.498544	0.282536	0.840813
2658.8	0.567185	0.498459	0.282718	0.841355
2658.9	0.567650	0.498374	0.282902	0.841901
2659.0	0.568118	0.498289	0.283087	0.842453
2659.1	0.568590	0.498228	0.283288	0.843049
2659.2	0.569064	0.498167	0.283489	0.843649
2659.3	0.569540	0.497590	0.283398	0.843377
2659.4	0.570018	0.497530	0.283601	0.843982

2659.5	0.570498	0.497469	0.283805	0.844590
2659.6	0.570980	0.497389	0.284000	0.845168
2659.7	0.571464	0.497254	0.284163	0.845655
2659.8	0.571950	0.497119	0.284327	0.846144
2659.9	0.572438	0.496984	0.284493	0.846635
2660.0	0.572928	0.496849	0.284659	0.847129
2660.1	0.573420	0.496746	0.284844	0.847682
2660.2	0.573914	0.496643	0.285030	0.848236
2660.3	0.574410	0.496554	0.285225	0.848816
2660.4	0.574908	0.496525	0.285456	0.849503
2660.5	0.575408	0.496497	0.285688	0.850193
2660.6	0.575910	0.496468	0.285921	0.850886
2660.7	0.576413	0.496440	0.286155	0.851581
2660.8	0.576919	0.496411	0.286389	0.852279
2660.9	0.577426	0.496383	0.286624	0.852979
2661.0	0.577935	0.496354	0.286860	0.853681
2661.1	0.578445	0.495742	0.286759	0.853381
2661.2	0.578957	0.495645	0.286957	0.853969
2661.3	0.579470	0.495548	0.287155	0.854560
2661.4	0.579985	0.495452	0.287354	0.855152
2661.5	0.580500	0.495355	0.287554	0.855745
2661.6	0.581017	0.495258	0.287754	0.856340
2661.7	0.581535	0.495162	0.287954	0.856936
2661.8	0.582054	0.495065	0.288154	0.857532
2661.9	0.582573	0.494968	0.288355	0.858129
2662.0	0.583092	0.494871	0.288555	0.858726
2662.1	0.583611	0.494876	0.288815	0.859499
2662.2	0.584131	0.494881	0.289075	0.860273
2662.3	0.584650	0.494886	0.289335	0.861046
2662.4	0.585169	0.494890	0.289594	0.861818
2662.5	0.585688	0.494895	0.289854	0.862590
2662.6	0.586207	0.494899	0.290113	0.863363
2662.7	0.586726	0.494904	0.290373	0.864135
2662.8	0.587246	0.494908	0.290633	0.864909
2662.9	0.587766	0.494913	0.290893	0.865683
2663.0	0.588288	0.494917	0.291154	0.866459
2663.1	0.588811	0.494929	0.291420	0.867250
2663.2	0.589334	0.494942	0.291686	0.868043
2663.3	0.589860	0.494953	0.291953	0.868838
2663.4	0.590387	0.494965	0.292221	0.869635
2663.5	0.590916	0.494977	0.292490	0.870435
2663.6	0.591446	0.494989	0.292759	0.871237
2663.7	0.591978	0.495001	0.293030	0.872041

2663.8	0.592510	0.495013	0.293300	0.872846
2663.9	0.593043	0.495024	0.293571	0.873652
2664.0	0.593577	0.495036	0.293842	0.874459
2664.1	0.594111	0.494737	0.293929	0.874717
2664.2	0.594646	0.494437	0.294015	0.874974
2664.3	0.595180	0.494138	0.294101	0.875230
2664.4	0.595714	0.493839	0.294187	0.875485
2664.5	0.596248	0.493540	0.294272	0.875738
2664.6	0.596781	0.493241	0.294357	0.875991
2664.7	0.597314	0.492942	0.294441	0.876242
2664.8	0.597846	0.492643	0.294525	0.876490
2664.9	0.598377	0.492344	0.294607	0.876737
2665.0	0.598907	0.492045	0.294690	0.876981
2665.1	0.599436	0.491766	0.294782	0.877256
2665.2	0.599964	0.491486	0.294874	0.877529
2665.3	0.600490	0.491207	0.294965	0.877800
2665.4	0.601015	0.490927	0.295054	0.878067
2665.5	0.601538	0.490648	0.295143	0.878331
2665.6	0.602061	0.490368	0.295231	0.878594
2665.7	0.602582	0.490089	0.295319	0.878854
2665.8	0.603102	0.489810	0.295405	0.879111
2665.9	0.603622	0.489530	0.295491	0.879368
2666.0	0.604142	0.489251	0.295577	0.879623
2666.1	0.604661	0.489263	0.295838	0.880400
2666.2	0.605181	0.489275	0.296100	0.881178
2666.3	0.605700	0.489287	0.296361	0.881955
2666.4	0.606220	0.489298	0.296622	0.882733
2666.5	0.606740	0.489310	0.296884	0.883511
2666.6	0.607260	0.489322	0.297146	0.884290
2666.7	0.607781	0.489333	0.297408	0.885070
2666.8	0.608302	0.489345	0.297669	0.885849
2666.9	0.608823	0.489356	0.297931	0.886629
2667.0	0.609345	0.489368	0.298194	0.887409
2667.1	0.609866	0.489413	0.298476	0.888250
2667.2	0.610388	0.489458	0.298759	0.889092
2667.3	0.610910	0.489503	0.299042	0.889934
2667.4	0.611432	0.489547	0.299325	0.890775
2667.5	0.611953	0.489592	0.299608	0.891617
2667.6	0.612474	0.489128	0.299578	0.891529
2667.7	0.612993	0.489173	0.299859	0.892366
2667.8	0.613510	0.489217	0.300140	0.893201
2667.9	0.614025	0.489262	0.300419	0.894032
2668.0	0.614537	0.489307	0.300697	0.894858

2668.1	0.615045	0.489472	0.301047	0.895901
2668.2	0.615550	0.489636	0.301396	0.896938
2668.3	0.616050	0.489801	0.301742	0.897969
2668.4	0.616545	0.489966	0.302086	0.898993
2668.5	0.617036	0.490131	0.302428	0.900011
2668.6	0.617521	0.490296	0.302768	0.901023
2668.7	0.618002	0.490461	0.303106	0.902028
2668.8	0.618478	0.490626	0.303441	0.903025
2668.9	0.618948	0.490791	0.303774	0.904016
2669.0	0.619414	0.490955	0.304105	0.905000
2669.1	0.619874	0.491116	0.304430	0.905969
2669.2	0.620330	0.491277	0.304754	0.906931
2669.3	0.620780	0.491437	0.305074	0.907886
2669.4	0.621225	0.491598	0.305393	0.908834
2669.5	0.621665	0.491759	0.305709	0.909775
2669.6	0.622100	0.491920	0.306023	0.910709
2669.7	0.622529	0.492080	0.306334	0.911635
2669.8	0.622954	0.492241	0.306644	0.912555
2669.9	0.623373	0.492402	0.306950	0.913468
2670.0	0.623788	0.492563	0.307255	0.914374
2670.1	0.624197	0.492349	0.307323	0.914576
2670.2	0.624601	0.492135	0.307388	0.914770
2670.3	0.625000	0.491921	0.307450	0.914956
2670.4	0.625394	0.491706	0.307510	0.915135
2670.5	0.625783	0.491492	0.307568	0.915305
2670.6	0.626168	0.491278	0.307622	0.915469
2670.7	0.626548	0.491064	0.307675	0.915625
2670.8	0.626923	0.490850	0.307725	0.915774
2670.9	0.627294	0.490635	0.307773	0.915917
2671.0	0.627662	0.490421	0.307819	0.916053
2671.1	0.628025	0.490203	0.307860	0.916175
2671.2	0.628384	0.489985	0.307899	0.916291
2671.3	0.628740	0.489767	0.307936	0.916402
2671.4	0.629092	0.489549	0.307972	0.916507
2671.5	0.629441	0.489331	0.308005	0.916608
2671.6	0.629788	0.489113	0.308037	0.916703
2671.7	0.630132	0.488895	0.308068	0.916795
2671.8	0.630474	0.488677	0.308098	0.916884
2671.9	0.630815	0.488459	0.308127	0.916970
2672.0	0.631154	0.488241	0.308155	0.917054
2672.1	0.631493	0.488076	0.308217	0.917237
2672.2	0.631832	0.487911	0.308278	0.917418
2672.3	0.632170	0.487746	0.308338	0.917599

2672.4	0.632509	0.487581	0.308399	0.917780
2672.5	0.632847	0.487416	0.308460	0.917961
2672.6	0.633185	0.487251	0.308520	0.918140
2672.7	0.633522	0.487086	0.308580	0.918317
2672.8	0.633857	0.486415	0.308317	0.917537
2672.9	0.634190	0.486250	0.308375	0.917708
2673.0	0.634520	0.486085	0.308431	0.917875
2673.1	0.634848	0.485876	0.308457	0.917952
2673.2	0.635171	0.485666	0.308481	0.918023
2673.3	0.635490	0.485456	0.308503	0.918088
2673.4	0.635804	0.485247	0.308522	0.918146
2673.5	0.636114	0.485037	0.308539	0.918197
2673.6	0.636419	0.484828	0.308554	0.918240
2673.7	0.636719	0.484619	0.308566	0.918276
2673.8	0.637014	0.484409	0.308575	0.918304
2673.9	0.637303	0.484200	0.308582	0.918325
2674.0	0.637588	0.483990	0.308586	0.918338
2674.1	0.637867	0.484066	0.308770	0.918883
2674.2	0.638141	0.484141	0.308951	0.919421
2674.3	0.638410	0.484216	0.309129	0.919951
2674.4	0.638673	0.484291	0.309304	0.920472
2674.5	0.638931	0.483862	0.309154	0.920027
2674.6	0.639182	0.483937	0.309324	0.920531
2674.7	0.639427	0.484011	0.309490	0.921026
2674.8	0.639666	0.484086	0.309653	0.921512
2674.9	0.639898	0.483656	0.309490	0.921028
2675.0	0.640122	0.483730	0.309646	0.921492
2675.1	0.640339	0.483749	0.309764	0.921841
2675.2	0.640549	0.483769	0.309877	0.922179
2675.3	0.640750	0.483788	0.309987	0.922505
2675.4	0.640943	0.483806	0.310092	0.922819
2675.5	0.641128	0.483825	0.310194	0.923122
2675.6	0.641306	0.483844	0.310292	0.923413
2675.7	0.641477	0.483862	0.310386	0.923694
2675.8	0.641640	0.483881	0.310477	0.923965
2675.9	0.641798	0.483899	0.310565	0.924226
2676.0	0.641949	0.483917	0.310650	0.924478
2676.1	0.642095	0.483834	0.310667	0.924530
2676.2	0.642235	0.483752	0.310682	0.924574
2676.3	0.642370	0.483669	0.310695	0.924611
2676.4	0.642501	0.483082	0.310381	0.923677
2676.5	0.642626	0.482999	0.310388	0.923699
2676.6	0.642748	0.482917	0.310394	0.923715

2676.7	0.642865	0.482834	0.310397	0.923725
2676.8	0.642977	0.482751	0.310398	0.923728
2676.9	0.643085	0.482668	0.310397	0.923724
2677.0	0.643188	0.482585	0.310393	0.923714
2677.1	0.643286	0.482516	0.310396	0.923722
2677.2	0.643381	0.482447	0.310397	0.923725
2677.3	0.643470	0.482377	0.310395	0.923720
2677.4	0.643555	0.482308	0.310392	0.923710
2677.5	0.643636	0.482238	0.310386	0.923692
2677.6	0.643713	0.482169	0.310378	0.923669
2677.7	0.643785	0.482099	0.310368	0.923640
2677.8	0.643854	0.482029	0.310357	0.923605
2677.9	0.643920	0.481960	0.310343	0.923566
2678.0	0.643982	0.481890	0.310329	0.923522
2678.1	0.644041	0.481774	0.310282	0.923383
2678.2	0.644097	0.481657	0.310234	0.923240
2678.3	0.644150	0.481541	0.310184	0.923093
2678.4	0.644201	0.481424	0.310134	0.922942
2678.5	0.644248	0.481308	0.310082	0.922787
2678.6	0.644293	0.481191	0.310028	0.922628
2678.7	0.644335	0.481075	0.309973	0.922465
2678.8	0.644373	0.480959	0.309917	0.922296
2678.9	0.644407	0.480843	0.309858	0.922122
2679.0	0.644437	0.480726	0.309798	0.921942
2679.1	0.644462	0.480619	0.309741	0.921774
2679.2	0.644484	0.480512	0.309682	0.921599
2679.3	0.644500	0.480405	0.309621	0.921417
2679.4	0.644511	0.480299	0.309558	0.921228
2679.5	0.644518	0.480192	0.309492	0.921033
2679.6	0.644520	0.480085	0.309424	0.920831
2679.7	0.644518	0.479477	0.309031	0.919662
2679.8	0.644512	0.479370	0.308960	0.919448
2679.9	0.644502	0.479263	0.308886	0.919229
2680.0	0.644489	0.479157	0.308811	0.919006
2680.1	0.644472	0.479214	0.308840	0.919091
2680.2	0.644452	0.479271	0.308867	0.919173
2680.3	0.644430	0.479328	0.308893	0.919251
2680.4	0.644405	0.479385	0.308918	0.919324
2680.5	0.644378	0.479442	0.308942	0.919394
2680.6	0.644346	0.479499	0.308963	0.919459
2680.7	0.644312	0.479556	0.308984	0.919519
2680.8	0.644273	0.479613	0.309002	0.919573
2680.9	0.644229	0.479670	0.309017	0.919619

2681.0	0.644181	0.479727	0.309030	0.919659
2681.1	0.644126	0.479802	0.309053	0.919725
2681.2	0.644066	0.479877	0.309072	0.919783
2681.3	0.644000	0.479952	0.309089	0.919832
2681.4	0.643927	0.480026	0.309102	0.919872
2681.5	0.643847	0.480101	0.309112	0.919901
2681.6	0.643761	0.480176	0.309119	0.919922
2681.7	0.643669	0.480251	0.309123	0.919933
2681.8	0.643571	0.480325	0.309124	0.919936
2681.9	0.643467	0.480400	0.309122	0.919931
2682.0	0.643358	0.480475	0.309117	0.919918
2682.1	0.643244	0.480358	0.308987	0.919530
2682.2	0.643124	0.480241	0.308854	0.919135
2682.3	0.643000	0.480124	0.308720	0.918733
2682.4	0.642871	0.480007	0.308582	0.918325
2682.5	0.642738	0.479890	0.308443	0.917911
2682.6	0.642600	0.479772	0.308302	0.917491
2682.7	0.642459	0.479655	0.308159	0.917065
2682.8	0.642314	0.479538	0.308014	0.916633
2682.9	0.642165	0.478920	0.307546	0.915240
2683.0	0.642013	0.478802	0.307397	0.914799
2683.1	0.641858	0.478680	0.307245	0.914344
2683.2	0.641701	0.478557	0.307090	0.913885
2683.3	0.641540	0.478435	0.306935	0.913423
2683.4	0.641377	0.478312	0.306778	0.912957
2683.5	0.641212	0.478190	0.306621	0.912488
2683.6	0.641045	0.478067	0.306462	0.912016
2683.7	0.640875	0.477944	0.306303	0.911541
2683.8	0.640705	0.477822	0.306143	0.911065
2683.9	0.640532	0.477699	0.305982	0.910585
2684.0	0.640358	0.477576	0.305820	0.910104
2684.1	0.640183	0.477525	0.305703	0.909758
2684.2	0.640007	0.477474	0.305587	0.909410
2684.3	0.639830	0.477422	0.305469	0.909061
2684.4	0.639652	0.477371	0.305352	0.908711
2684.5	0.639474	0.477320	0.305234	0.908361
2684.6	0.639296	0.477269	0.305116	0.908010
2684.7	0.639118	0.477217	0.304998	0.907659
2684.8	0.638941	0.477166	0.304881	0.907310
2684.9	0.638764	0.477115	0.304764	0.906961
2685.0	0.638588	0.477063	0.304647	0.906614
2685.1	0.638414	0.477056	0.304559	0.906353
2685.2	0.638241	0.477050	0.304473	0.906095

2685.3	0.638070	0.477043	0.304387	0.905839
2685.4	0.637901	0.477036	0.304302	0.905586
2685.5	0.637734	0.477029	0.304218	0.905336
2685.6	0.637568	0.477022	0.304134	0.905088
2685.7	0.637404	0.477015	0.304052	0.904842
2685.8	0.637241	0.477008	0.303969	0.904597
2685.9	0.637079	0.477001	0.303887	0.904353
2686.0	0.636917	0.476995	0.303806	0.904110
2686.1	0.636755	0.477038	0.303756	0.903963
2686.2	0.636593	0.477081	0.303706	0.903815
2686.3	0.636430	0.477125	0.303657	0.903666
2686.4	0.636267	0.477168	0.303606	0.903517
2686.5	0.636103	0.477211	0.303556	0.903366
2686.6	0.635938	0.477255	0.303505	0.903214
2686.7	0.635773	0.477298	0.303453	0.903062
2686.8	0.635607	0.477291	0.303370	0.902812
2686.9	0.635441	0.477264	0.303273	0.902526
2687.0	0.635274	0.477238	0.303177	0.902238
2687.1	0.635107	0.477209	0.303079	0.901946
2687.2	0.634938	0.477180	0.302980	0.901654
2687.3	0.634770	0.477152	0.302882	0.901360
2687.4	0.634601	0.477123	0.302783	0.901066
2687.5	0.634431	0.477130	0.302706	0.900838
2687.6	0.634261	0.477171	0.302651	0.900674
2687.7	0.634089	0.477213	0.302596	0.900509
2687.8	0.633917	0.477254	0.302540	0.900342
2687.9	0.633743	0.477296	0.302483	0.900173
2688.0	0.633567	0.477337	0.302425	0.900002
2688.1	0.633390	0.477109	0.302196	0.899321
2688.2	0.633211	0.476881	0.301966	0.898637
2688.3	0.633030	0.476653	0.301736	0.897950
2688.4	0.632847	0.476425	0.301504	0.897261
2688.5	0.632661	0.476197	0.301272	0.896569
2688.6	0.632475	0.475969	0.301039	0.895876
2688.7	0.632287	0.475742	0.300805	0.895181
2688.8	0.632099	0.475514	0.300572	0.894486
2688.9	0.631910	0.475286	0.300338	0.893791
2689.0	0.631721	0.475058	0.300104	0.893096
2689.1	0.631533	0.474709	0.299795	0.892174
2689.2	0.631346	0.474361	0.299486	0.891254
2689.3	0.631160	0.474012	0.299177	0.890337
2689.4	0.630976	0.473663	0.298870	0.889422
2689.5	0.630793	0.473315	0.298564	0.888510

2689.6	0.630612	0.472471	0.297946	0.886672
2689.7	0.630433	0.472123	0.297642	0.885768
2689.8	0.630256	0.471775	0.297339	0.884866
2689.9	0.630081	0.471428	0.297038	0.883969
2690.0	0.629908	0.471080	0.296737	0.883074
2690.1	0.629737	0.470957	0.296579	0.882602
2690.2	0.629567	0.470833	0.296421	0.882133
2690.3	0.629400	0.470709	0.296264	0.881667
2690.4	0.629235	0.470585	0.296109	0.881204
2690.5	0.629072	0.470461	0.295954	0.880744
2690.6	0.628912	0.470337	0.295801	0.880288
2690.7	0.628754	0.470213	0.295649	0.879835
2690.8	0.628600	0.470089	0.295498	0.879386
2690.9	0.628449	0.469965	0.295349	0.878942
2691.0	0.628301	0.469840	0.295201	0.878503
2691.1	0.628157	0.469685	0.295036	0.878011
2691.2	0.628016	0.469530	0.294872	0.877525
2691.3	0.627880	0.469375	0.294711	0.877045
2691.4	0.627748	0.469219	0.294551	0.876570
2691.5	0.627621	0.469064	0.294394	0.876102
2691.6	0.627498	0.468908	0.294239	0.875640
2691.7	0.627380	0.468261	0.293778	0.874268
2691.8	0.627268	0.468106	0.293628	0.873821
2691.9	0.627161	0.467950	0.293480	0.873381
2692.0	0.627059	0.467794	0.293335	0.872948
2692.1	0.626963	0.467902	0.293357	0.873016
2692.2	0.626874	0.468009	0.293383	0.873092
2692.3	0.626790	0.468117	0.293411	0.873176
2692.4	0.626713	0.468224	0.293442	0.873269
2692.5	0.626642	0.468332	0.293476	0.873370
2692.6	0.626578	0.468439	0.293513	0.873480
2692.7	0.626520	0.468545	0.293553	0.873598
2692.8	0.626468	0.468652	0.293595	0.873725
2692.9	0.626422	0.468759	0.293641	0.873859
2693.0	0.626382	0.468865	0.293689	0.874002
2693.1	0.626349	0.469027	0.293775	0.874258
2693.2	0.626321	0.469189	0.293863	0.874522
2693.3	0.626300	0.469352	0.293955	0.874795
2693.4	0.626285	0.469514	0.294049	0.875075
2693.5	0.626275	0.469676	0.294146	0.875364
2693.6	0.626271	0.469838	0.294245	0.875659
2693.7	0.626272	0.469999	0.294347	0.875962
2693.8	0.626278	0.470161	0.294452	0.876273

2693.9	0.626289	0.470323	0.294558	0.876590
2694.0	0.626305	0.470484	0.294667	0.876913
2694.1	0.626326	0.470169	0.294479	0.876354
2694.2	0.626351	0.469854	0.294294	0.875802
2694.3	0.626380	0.469539	0.294110	0.875256
2694.4	0.626413	0.469225	0.293928	0.874716
2694.5	0.626450	0.468910	0.293749	0.874181
2694.6	0.626492	0.468595	0.293571	0.873653
2694.7	0.626539	0.468281	0.293396	0.873131
2694.8	0.626590	0.467967	0.293223	0.872617
2694.9	0.626646	0.467653	0.293053	0.872110
2695.0	0.626708	0.467339	0.292885	0.871611
2695.1	0.626776	0.467066	0.292746	0.871197
2695.2	0.626850	0.466793	0.292609	0.870791
2695.3	0.626930	0.466032	0.292169	0.869480
2695.4	0.627016	0.465759	0.292039	0.869092
2695.5	0.627108	0.465487	0.291911	0.868712
2695.6	0.627206	0.465215	0.291786	0.868340
2695.7	0.627308	0.464943	0.291663	0.867973
2695.8	0.627414	0.464672	0.291541	0.867612
2695.9	0.627523	0.464400	0.291422	0.867256
2696.0	0.627635	0.464128	0.291303	0.866903
2696.1	0.627749	0.464099	0.291338	0.867006
2696.2	0.627864	0.464071	0.291373	0.867112
2696.3	0.627980	0.464042	0.291409	0.867218
2696.4	0.628096	0.464013	0.291445	0.867325
2696.5	0.628213	0.463984	0.291481	0.867432
2696.6	0.628331	0.463955	0.291517	0.867541
2696.7	0.628450	0.463926	0.291554	0.867651
2696.8	0.628571	0.463897	0.291592	0.867764
2696.9	0.628695	0.463869	0.291632	0.867881
2697.0	0.628821	0.463840	0.291672	0.868001
2697.1	0.628950	0.463761	0.291683	0.868032
2697.2	0.629083	0.463682	0.291695	0.868068
2697.3	0.629220	0.463603	0.291709	0.868110
2697.4	0.629362	0.463525	0.291725	0.868157
2697.5	0.629507	0.463446	0.291743	0.868211
2697.6	0.629658	0.463367	0.291763	0.868271
2697.7	0.629813	0.463288	0.291785	0.868337
2697.8	0.629972	0.463210	0.291809	0.868408
2697.9	0.630135	0.463131	0.291835	0.868486
2698.0	0.630302	0.463052	0.291863	0.868569
2698.1	0.630474	0.463148	0.292003	0.868985

2698.2	0.630650	0.463244	0.292145	0.869408
2698.3	0.630830	0.463339	0.292288	0.869835
2698.4	0.631014	0.463435	0.292434	0.870269
2698.5	0.631201	0.463605	0.292628	0.870847
2698.6	0.631392	0.464092	0.293024	0.872024
2698.7	0.631585	0.464188	0.293174	0.872471
2698.8	0.631780	0.464283	0.293325	0.872920
2698.9	0.631977	0.464378	0.293476	0.873371
2699.0	0.632175	0.464474	0.293628	0.873823
2699.1	0.632373	0.464553	0.293771	0.874248
2699.2	0.632572	0.464145	0.293605	0.873754
2699.3	0.632770	0.464224	0.293747	0.874177
2699.4	0.632968	0.464304	0.293889	0.874599
2699.5	0.633164	0.464383	0.294031	0.875020
2699.6	0.633359	0.464463	0.294172	0.875440
2699.7	0.633554	0.464542	0.294312	0.875858
2699.8	0.633747	0.464621	0.294452	0.876274
2699.9	0.633939	0.464700	0.294591	0.876688
2700.0	0.634129	0.464779	0.294730	0.877100
2700.1	0.634318	0.464460	0.294615	0.876759
2700.2	0.634505	0.464141	0.294499	0.876415
2700.3	0.634690	0.463822	0.294383	0.876069
2700.4	0.634873	0.463503	0.294266	0.875720
2700.5	0.635055	0.463184	0.294147	0.875368
2700.6	0.635234	0.462866	0.294028	0.875012
2700.7	0.635411	0.462547	0.293908	0.874654
2700.8	0.635585	0.462229	0.293786	0.874292
2700.9	0.635756	0.461911	0.293663	0.873926
2701.0	0.635925	0.461593	0.293539	0.873556
2701.1	0.636090	0.461250	0.293396	0.873133
2701.2	0.636252	0.460907	0.293253	0.872705
2701.3	0.636410	0.460564	0.293107	0.872272
2701.4	0.636564	0.460221	0.292960	0.871834
2701.5	0.636715	0.459878	0.292811	0.871391
2701.6	0.636862	0.459535	0.292660	0.870942
2701.7	0.637004	0.459193	0.292508	0.870488
2701.8	0.637143	0.458851	0.292353	0.870029
2701.9	0.637277	0.458508	0.292197	0.869563
2702.0	0.637407	0.458166	0.292038	0.869092
2702.1	0.637533	0.457980	0.291977	0.868908
2702.2	0.637654	0.457257	0.291571	0.867702
2702.3	0.637770	0.456666	0.291248	0.866739
2702.4	0.637882	0.456480	0.291180	0.866537

2702.5	0.637988	0.456294	0.291110	0.866328
2702.6	0.638090	0.456107	0.291038	0.866113
2702.7	0.638187	0.455921	0.290963	0.865890
2702.8	0.638278	0.455735	0.290886	0.865661
2702.9	0.638364	0.455549	0.290806	0.865423
2703.0	0.638444	0.455363	0.290723	0.865178
2703.1	0.638519	0.455176	0.290638	0.864924
2703.2	0.638587	0.454989	0.290550	0.864663
2703.3	0.638650	0.454802	0.290460	0.864393
2703.4	0.638706	0.454616	0.290366	0.864114
2703.5	0.638756	0.454429	0.290269	0.863827
2703.6	0.638799	0.454242	0.290169	0.863529
2703.7	0.638833	0.454056	0.290066	0.863220
2703.8	0.638858	0.453869	0.289958	0.862900
2703.9	0.638874	0.453682	0.289846	0.862566
2704.0	0.638880	0.453496	0.289729	0.862219
2704.1	0.638875	0.453566	0.289772	0.862346
2704.2	0.638858	0.453636	0.289809	0.862457
2704.3	0.638830	0.453706	0.289841	0.862551
2704.4	0.638789	0.453775	0.289867	0.862628
2704.5	0.638734	0.453845	0.289886	0.862686
2704.6	0.638664	0.453914	0.289899	0.862724
2704.7	0.638579	0.453983	0.289904	0.862740
2704.8	0.638478	0.453575	0.289597	0.861827
2704.9	0.638359	0.453644	0.289587	0.861797
2705.0	0.638221	0.453712	0.289569	0.861742
2705.1	0.638065	0.453815	0.289563	0.861725
2705.2	0.637888	0.453917	0.289548	0.861681
2705.3	0.637690	0.454020	0.289524	0.861608
2705.4	0.637470	0.454122	0.289489	0.861505
2705.5	0.637228	0.454224	0.289444	0.861371
2705.6	0.636964	0.454326	0.289389	0.861208
2705.7	0.636678	0.454427	0.289324	0.861014
2705.8	0.636370	0.454488	0.289223	0.860712
2705.9	0.636040	0.454174	0.288873	0.859671
2706.0	0.635688	0.454275	0.288777	0.859386
2706.1	0.635314	0.453885	0.288360	0.858144
2706.2	0.634918	0.453495	0.287932	0.856872
2706.3	0.634500	0.453106	0.287496	0.855572
2706.4	0.634060	0.452716	0.287049	0.854244
2706.5	0.633597	0.452327	0.286593	0.852886
2706.6	0.633110	0.451938	0.286126	0.851498
2706.7	0.632598	0.451586	0.285672	0.850146

2706.8	0.632061	0.451615	0.285448	0.849478
2706.9	0.631497	0.451226	0.284948	0.847990
2707.0	0.630906	0.450837	0.284436	0.846467
2707.1	0.630287	0.450387	0.283873	0.844792
2707.2	0.629638	0.449938	0.283298	0.843080
2707.3	0.628960	0.449488	0.282710	0.841331
2707.4	0.628251	0.449039	0.282109	0.839542
2707.5	0.627511	0.448590	0.281495	0.837715
2707.6	0.626739	0.448142	0.280868	0.835849
2707.7	0.625937	0.447693	0.280228	0.833944
2707.8	0.625104	0.447245	0.279575	0.832000
2707.9	0.624240	0.446797	0.278909	0.830018
2708.0	0.623344	0.446350	0.278229	0.827996
2708.1	0.622417	0.446440	0.277872	0.826933
2708.2	0.621459	0.446061	0.277208	0.824958
2708.3	0.620470	0.445681	0.276532	0.822945
2708.4	0.619449	0.445302	0.275842	0.820892
2708.5	0.618397	0.444923	0.275139	0.818800
2708.6	0.617312	0.444544	0.274423	0.816667
2708.7	0.616195	0.444165	0.273693	0.814495
2708.8	0.615045	0.443787	0.272949	0.812282
2708.9	0.613861	0.443409	0.272191	0.810027
2709.0	0.612643	0.443031	0.271419	0.807730
2709.1	0.611390	0.442661	0.270639	0.805407
2709.2	0.610103	0.442292	0.269844	0.803041
2709.3	0.608780	0.441923	0.269034	0.800632
2709.4	0.607421	0.441555	0.268210	0.798179
2709.5	0.606027	0.441186	0.267371	0.795682
2709.6	0.604597	0.440818	0.266517	0.793141
2709.7	0.603131	0.440450	0.265649	0.790557
2709.8	0.601629	0.440082	0.264766	0.787929
2709.9	0.600091	0.439714	0.263868	0.785258
2710.0	0.598517	0.439346	0.262956	0.782544
2710.1	0.596907	0.439354	0.262253	0.780453
2710.2	0.595262	0.439361	0.261535	0.778314
2710.3	0.593580	0.439369	0.260800	0.776128
2710.4	0.591862	0.439376	0.260050	0.773895
2710.5	0.590109	0.439383	0.259284	0.771614
2710.6	0.588319	0.439389	0.258501	0.769286
2710.7	0.586492	0.439396	0.257703	0.766910
2710.8	0.584629	0.439865	0.257158	0.765289
2710.9	0.582730	0.439872	0.256326	0.762814
2711.0	0.580793	0.439878	0.255478	0.760289

2711.1	0.578819	0.439872	0.254606	0.757695
2711.2	0.576808	0.439866	0.253718	0.755052
2711.3	0.574760	0.439859	0.252814	0.752360
2711.4	0.572674	0.439853	0.251892	0.749619
2711.5	0.570552	0.439846	0.250955	0.746830
2711.6	0.568394	0.439840	0.250002	0.743994
2711.7	0.566202	0.439833	0.249034	0.741113
2711.8	0.563975	0.439826	0.248051	0.738187
2711.9	0.561716	0.439818	0.247053	0.735218
2712.0	0.559425	0.439811	0.246041	0.732207
2712.1	0.557103	0.439606	0.244906	0.728828
2712.2	0.554751	0.439402	0.243759	0.725414
2712.3	0.552370	0.439198	0.242600	0.721964
2712.4	0.549960	0.438993	0.241429	0.718481
2712.5	0.547523	0.438789	0.240247	0.714963
2712.6	0.545057	0.438585	0.239054	0.711411
2712.7	0.542562	0.438842	0.238099	0.708570
2712.8	0.540039	0.438637	0.236881	0.704946
2712.9	0.537487	0.438433	0.235652	0.701288
2713.0	0.534906	0.438220	0.234406	0.697582
2713.1	0.532296	0.437580	0.232922	0.693165
2713.2	0.529658	0.437372	0.231657	0.689401
2713.3	0.526990	0.437164	0.230381	0.685602
2713.4	0.524293	0.436956	0.229093	0.681769
2713.5	0.521567	0.436748	0.227793	0.677901
2713.6	0.518813	0.436540	0.226482	0.674000
2713.7	0.516030	0.436336	0.225162	0.670072
2713.8	0.513219	0.436563	0.224052	0.666767
2713.9	0.510379	0.436355	0.222706	0.662763
2714.0	0.507513	0.436147	0.221350	0.658726
2714.1	0.504619	0.435847	0.219937	0.654520
2714.2	0.501698	0.435548	0.218513	0.650284
2714.3	0.498750	0.435248	0.217080	0.646019
2714.4	0.495776	0.434949	0.215637	0.641725
2714.5	0.492776	0.434650	0.214185	0.637404
2714.6	0.489752	0.434351	0.212724	0.633056
2714.7	0.486704	0.434508	0.211477	0.629344
2714.8	0.483633	0.434209	0.209998	0.624944
2714.9	0.480542	0.433910	0.208512	0.620521
2715.0	0.477430	0.433612	0.207019	0.616078
2715.1	0.474298	0.433362	0.205543	0.611684
2715.2	0.471148	0.433112	0.204060	0.607271
2715.3	0.467980	0.432862	0.202571	0.602840

2715.4	0.464796	0.432612	0.201076	0.598393
2715.5	0.461596	0.432362	0.199577	0.593931
2715.6	0.458382	0.432113	0.198073	0.589455
2715.7	0.455155	0.431863	0.196565	0.584966
2715.8	0.451915	0.431614	0.195053	0.580467
2715.9	0.448663	0.431365	0.193537	0.575957
2716.0	0.445401	0.431115	0.192019	0.571439
2716.1	0.442129	0.431247	0.190667	0.567414
2716.2	0.438848	0.431378	0.189309	0.563375
2716.3	0.435560	0.431509	0.187948	0.559324
2716.4	0.432265	0.431640	0.186583	0.555261
2716.5	0.428964	0.431771	0.185214	0.551188
2716.6	0.425656	0.431902	0.183842	0.547104
2716.7	0.422344	0.432033	0.182467	0.543011
2716.8	0.419027	0.432164	0.181088	0.538910
2716.9	0.415706	0.432295	0.179707	0.534800
2717.0	0.412381	0.432425	0.178324	0.530683
2717.1	0.409053	0.432523	0.176925	0.526520
2717.2	0.405723	0.433074	0.175708	0.522898
2717.3	0.402390	0.433172	0.174304	0.518720
2717.4	0.399056	0.433270	0.172899	0.514538
2717.5	0.395721	0.433367	0.171492	0.510353
2717.6	0.392387	0.433464	0.170086	0.506166
2717.7	0.389054	0.433562	0.168679	0.501980
2717.8	0.385724	0.433659	0.167273	0.497795
2717.9	0.382398	0.433756	0.165867	0.493612
2718.0	0.379076	0.433853	0.164463	0.489434
2718.1	0.375760	0.433641	0.162945	0.484916
2718.2	0.372451	0.433429	0.161431	0.480411
2718.3	0.369150	0.433218	0.159922	0.475921
2718.4	0.365858	0.433006	0.158419	0.471446
2718.5	0.362575	0.432795	0.156920	0.466987
2718.6	0.359301	0.432584	0.155428	0.462545
2718.7	0.356037	0.432372	0.153940	0.458119
2718.8	0.352783	0.432161	0.152459	0.453710
2718.9	0.349539	0.431949	0.150983	0.449318
2719.0	0.346305	0.431738	0.149513	0.444944
2719.1	0.343083	0.431552	0.148058	0.440613
2719.2	0.339871	0.431365	0.146609	0.436299
2719.3	0.336670	0.431179	0.145165	0.432004
2719.4	0.333481	0.430993	0.143728	0.427727
2719.5	0.330303	0.430807	0.142297	0.423468
2719.6	0.327137	0.430621	0.140872	0.419228

2719.7	0.323984	0.430435	0.139454	0.415007
2719.8	0.320843	0.430249	0.138042	0.410807
2719.9	0.317715	0.430063	0.136637	0.406626
2720.0	0.314601	0.429876	0.135239	0.402466
2720.1	0.311500	0.429615	0.133825	0.398256
2720.2	0.308413	0.428942	0.132291	0.393692
2720.3	0.305340	0.428659	0.130887	0.389512
2720.4	0.302282	0.428397	0.129497	0.385375
2720.5	0.299238	0.428135	0.128115	0.381262
2720.6	0.296210	0.427874	0.126741	0.377174
2720.7	0.293198	0.427612	0.125375	0.373110
2720.8	0.290202	0.427351	0.124018	0.369072
2720.9	0.287223	0.427090	0.122670	0.365059
2721.0	0.284261	0.426828	0.121331	0.361073
2721.1	0.281316	0.426509	0.119984	0.357065
2721.2	0.278389	0.426189	0.118646	0.353085
2721.3	0.275480	0.425870	0.117319	0.349134
2721.4	0.272590	0.425550	0.116001	0.345212
2721.5	0.269718	0.425231	0.114693	0.341320
2721.6	0.266866	0.424912	0.113395	0.337456
2721.7	0.264032	0.424593	0.112106	0.333622
2721.8	0.261216	0.424275	0.110827	0.329817
2721.9	0.258420	0.423956	0.109559	0.326041
2722.0	0.255642	0.423638	0.108299	0.322294
2722.1	0.252882	0.423359	0.107110	0.318755
2722.2	0.250142	0.423479	0.105930	0.315242
2722.3	0.247420	0.423400	0.104758	0.311753
2722.4	0.244717	0.423320	0.103594	0.308289
2722.5	0.242033	0.423240	0.102438	0.304850
2722.6	0.239368	0.423143	0.101287	0.301425
2722.7	0.236723	0.423002	0.100134	0.297995
2722.8	0.234098	0.422862	0.098991	0.294592
2722.9	0.231492	0.422722	0.097857	0.291217
2723.0	0.228908	0.422581	0.096732	0.287870
2723.1	0.226344	0.422414	0.095611	0.284533
2723.2	0.223801	0.422246	0.094499	0.281225
2723.3	0.221280	0.422079	0.093398	0.277946
2723.4	0.218780	0.421965	0.092318	0.274732
2723.5	0.216302	0.421858	0.091249	0.271552
2723.6	0.213846	0.421750	0.090190	0.268400
2723.7	0.211412	0.422033	0.089223	0.265523
2723.8	0.209000	0.421960	0.088189	0.262447
2723.9	0.206609	0.421852	0.087159	0.259380

2724.0	0.204241	0.421745	0.086138	0.256341
2724.1	0.201895	0.421431	0.085085	0.253208
2724.2	0.199571	0.421118	0.084043	0.250108
2724.3	0.197270	0.420804	0.083012	0.247040
2724.4	0.194991	0.420491	0.081992	0.244004
2724.5	0.192734	0.420178	0.080983	0.241000
2724.6	0.190500	0.419865	0.079984	0.238030
2724.7	0.188289	0.419552	0.078997	0.235091
2724.8	0.186100	0.419240	0.078021	0.232185
2724.9	0.183934	0.418927	0.077055	0.229312
2725.0	0.181791	0.418614	0.076100	0.226471
2725.1	0.179671	0.418264	0.075150	0.223642
2725.2	0.177574	0.417913	0.074210	0.220846
2725.3	0.175500	0.417562	0.073282	0.218084
2725.4	0.173449	0.417211	0.072365	0.215354
2725.5	0.171422	0.416860	0.071459	0.212658
2725.6	0.169417	0.416510	0.070564	0.209995
2725.7	0.167436	0.416159	0.069680	0.207365
2725.8	0.165479	0.415809	0.068807	0.204768
2725.9	0.163544	0.415459	0.067946	0.202203
2726.0	0.161633	0.415109	0.067095	0.199672
2726.1	0.159745	0.414710	0.066248	0.197151
2726.2	0.157881	0.414311	0.065412	0.194662
2726.3	0.156040	0.413912	0.064587	0.192207
2726.4	0.154222	0.413513	0.063773	0.189785
2726.5	0.152428	0.413115	0.062970	0.187396
2726.6	0.150656	0.412716	0.062178	0.185039
2726.7	0.148906	0.412317	0.061397	0.182713
2726.8	0.147178	0.411919	0.060625	0.180418
2726.9	0.145472	0.411520	0.059865	0.178154
2727.0	0.143786	0.411122	0.059114	0.175919
2727.1	0.142121	0.410646	0.058361	0.173680
2727.2	0.140476	0.410170	0.057619	0.171471
2727.3	0.138850	0.409694	0.056886	0.169290
2727.4	0.137244	0.409218	0.056163	0.167137
2727.5	0.135656	0.408743	0.055449	0.165012
2727.6	0.134087	0.408267	0.054743	0.162913
2727.7	0.132536	0.408219	0.054104	0.161009
2727.8	0.131001	0.407743	0.053415	0.158960
2727.9	0.129484	0.407267	0.052734	0.156935
2728.0	0.127982	0.406791	0.052062	0.154934
2728.1	0.126497	0.406522	0.051424	0.153034
2728.2	0.125026	0.406253	0.050792	0.151155

2728.3	0.123570	0.405983	0.050167	0.149295
2728.4	0.122128	0.405713	0.049549	0.147455
2728.5	0.120701	0.405443	0.048937	0.145635
2728.6	0.119287	0.405172	0.048332	0.143833
2728.7	0.117888	0.404901	0.047733	0.142051
2728.8	0.116503	0.404630	0.047141	0.140288
2728.9	0.115132	0.404358	0.046555	0.138544
2729.0	0.113775	0.404086	0.045975	0.136819
2729.1	0.112433	0.403881	0.045409	0.135136
2729.2	0.111104	0.403675	0.044850	0.133471
2729.3	0.109790	0.403468	0.044297	0.131825
2729.4	0.108490	0.403262	0.043750	0.130197
2729.5	0.107204	0.403055	0.043209	0.128588
2729.6	0.105932	0.402848	0.042674	0.126997
2729.7	0.104673	0.402641	0.042146	0.125423
2729.8	0.103428	0.402433	0.041623	0.123868
2729.9	0.102197	0.402225	0.041106	0.122329
2730.0	0.100978	0.402017	0.040595	0.120808
2730.1	0.099800	0.401597	0.040079	0.119274
2730.2	0.098600	0.401176	0.039556	0.117717
2730.3	0.097400	0.400756	0.039034	0.116162
2730.4	0.096200	0.399994	0.038479	0.114513
2730.5	0.095100	0.399513	0.037994	0.113067
2730.6	0.093900	0.399094	0.037475	0.111523
2730.7	0.092805	0.398675	0.036999	0.110108
2730.8	0.091700	0.398256	0.036520	0.108682
2730.9	0.090600	0.397837	0.036044	0.107265
2731.0	0.089500	0.397418	0.035569	0.105851
2731.1	0.088400	0.397010	0.035096	0.104443
2731.2	0.087345	0.396602	0.034641	0.103090
2731.3	0.086300	0.396195	0.034192	0.101752
2731.4	0.085200	0.395787	0.033721	0.100352
2731.5	0.084200	0.395380	0.033291	0.099072
2731.6	0.083200	0.394973	0.032862	0.097795
2731.7	0.082197	0.394566	0.032432	0.096517
2731.8	0.081200	0.394159	0.032006	0.095247
2731.9	0.080200	0.393752	0.031579	0.093977
2732.0	0.079300	0.393346	0.031192	0.092827
2732.1	0.078303	0.392971	0.030771	0.091573
2732.2	0.077400	0.392596	0.030387	0.090430
2732.3	0.076430	0.392221	0.029977	0.089211
2732.4	0.075500	0.391847	0.029584	0.088042
2732.5	0.074600	0.391472	0.029204	0.086909

2732.6	0.073700	0.391098	0.028824	0.085779
2732.7	0.072800	0.390724	0.028445	0.084650
2732.8	0.072000	0.390350	0.028105	0.083640
2732.9	0.071099	0.389976	0.027727	0.082514
2733.0	0.070300	0.389603	0.027389	0.081508
2733.1	0.069400	0.389251	0.027014	0.080392
2733.2	0.068600	0.388900	0.026679	0.079394
2733.3	0.067780	0.388548	0.026336	0.078374
2733.4	0.067000	0.388197	0.026009	0.077402
2733.5	0.066200	0.387846	0.025675	0.076409
2733.6	0.065400	0.387495	0.025342	0.075417
2733.7	0.064600	0.387144	0.025010	0.074427
2733.8	0.063900	0.386793	0.024716	0.073554
2733.9	0.063100	0.386443	0.024385	0.072567
2734.0	0.062399	0.386093	0.024092	0.071696
2734.1	0.061700	0.386196	0.023828	0.070912
2734.2	0.061000	0.386057	0.023549	0.070082
2734.3	0.060250	0.385845	0.023247	0.069182
2734.4	0.059600	0.385632	0.022984	0.068398
2734.5	0.058900	0.385420	0.022701	0.067558
2734.6	0.058200	0.385208	0.022419	0.066718
2734.7	0.057500	0.384995	0.022137	0.065879
2734.8	0.056900	0.384783	0.021894	0.065156
2734.9	0.056200	0.384570	0.021613	0.064319
2735.0	0.055600	0.384358	0.021370	0.063597
2735.1	0.054900	0.384127	0.021089	0.062759
2735.2	0.054315	0.383897	0.020851	0.062052
2735.3	0.053700	0.383667	0.020603	0.061313
2735.4	0.053100	0.383436	0.020360	0.060592
2735.5	0.052500	0.383206	0.020118	0.059871
2735.6	0.051905	0.382975	0.019878	0.059157
2735.7	0.051300	0.382745	0.019635	0.058432
2735.8	0.050700	0.382514	0.019393	0.057714
2735.9	0.050200	0.382283	0.019191	0.057110
2736.0	0.049600	0.382053	0.018950	0.056394
2736.1	0.049072	0.381723	0.018732	0.055745
2736.2	0.048500	0.381393	0.018498	0.055048
2736.3	0.047990	0.381064	0.018287	0.054422
2736.4	0.047500	0.380735	0.018085	0.053820
2736.5	0.046900	0.380405	0.017841	0.053094
2736.6	0.046400	0.380076	0.017636	0.052482
2736.7	0.045900	0.379747	0.017430	0.051872
2736.8	0.045400	0.379417	0.017212	0.051222

2736.9	0.044900	0.378709	0.017004	0.050603
2737.0	0.044400	0.378380	0.016800	0.049996
2737.1	0.043900	0.378038	0.016596	0.049388
2737.2	0.043500	0.377696	0.016430	0.048894
2737.3	0.042980	0.377355	0.016219	0.048266
2737.4	0.042500	0.377013	0.016023	0.047684
2737.5	0.042100	0.376671	0.015858	0.047192
2737.6	0.041600	0.376330	0.015655	0.046589
2737.7	0.041100	0.375989	0.015453	0.045988
2737.8	0.040700	0.375647	0.015289	0.045499
2737.9	0.040300	0.375306	0.015125	0.045011
2738.0	0.039800	0.374965	0.014924	0.044412
2738.1	0.039400	0.374589	0.014759	0.043921
2738.2	0.039000	0.374213	0.014594	0.043432
2738.3	0.038550	0.373837	0.014411	0.042888
2738.4	0.038100	0.373460	0.014229	0.042344
2738.5	0.037700	0.373085	0.014065	0.041858
2738.6	0.037300	0.372709	0.013902	0.041372
2738.7	0.036900	0.372334	0.013739	0.040887
2738.8	0.036500	0.371958	0.013576	0.040403
2738.9	0.036100	0.371583	0.013414	0.039920
2739.0	0.035800	0.371208	0.013289	0.039548
2739.1	0.035400	0.370857	0.013128	0.039069
2739.2	0.035000	0.370505	0.012968	0.038591
2739.3	0.034630	0.370154	0.012818	0.038147
2739.4	0.034300	0.369803	0.012684	0.037748
2739.5	0.033900	0.369452	0.012524	0.037272
2739.6	0.033500	0.369101	0.012365	0.036797
2739.7	0.033200	0.368751	0.012243	0.036433
2739.8	0.032800	0.368400	0.012084	0.035960
2739.9	0.032500	0.368050	0.011962	0.035597
2740.0	0.032200	0.367700	0.011840	0.035235
2740.1	0.031800	0.367533	0.011688	0.034782
2740.2	0.031500	0.367367	0.011572	0.034438
2740.3	0.031170	0.367200	0.011446	0.034062
2740.4	0.030800	0.367034	0.011305	0.033642
2740.5	0.030500	0.366867	0.011189	0.033299
2740.6	0.030200	0.366700	0.011074	0.032957
2740.7	0.029900	0.366533	0.010959	0.032614
2740.8	0.029600	0.366365	0.010844	0.032272
2740.9	0.029300	0.366474	0.010738	0.031955
2741.0	0.029000	0.366398	0.010626	0.031621
2741.1	0.028700	0.366184	0.010509	0.031276

2741.2	0.028400	0.365970	0.010394	0.030931
2741.3	0.028110	0.365756	0.010281	0.030597
2741.4	0.027800	0.365541	0.010162	0.030242
2741.5	0.027500	0.365326	0.010046	0.029898
2741.6	0.027300	0.365111	0.009968	0.029663
2741.7	0.027000	0.364896	0.009852	0.029320
2741.8	0.026700	0.364680	0.009737	0.028977
2741.9	0.026400	0.364464	0.009622	0.028634
2742.0	0.026200	0.364248	0.009543	0.028400
2742.1	0.025900	0.364000	0.009428	0.028056
2742.2	0.025600	0.363752	0.009312	0.027712
2742.3	0.025390	0.363503	0.009229	0.027466
2742.4	0.025100	0.363255	0.009118	0.027134
2742.5	0.024900	0.363006	0.009039	0.026899
2742.6	0.024600	0.362757	0.008924	0.026557
2742.7	0.024400	0.362508	0.008845	0.026323
2742.8	0.024200	0.362259	0.008767	0.026089
2742.9	0.023900	0.362388	0.008661	0.025775
2743.0	0.023700	0.362138	0.008583	0.025542
2743.1	0.023400	0.361934	0.008469	0.025204
2743.2	0.023200	0.361730	0.008392	0.024975
2743.3	0.022990	0.361526	0.008311	0.024735
2743.4	0.022800	0.361321	0.008238	0.024516
2743.5	0.022500	0.361116	0.008125	0.024180
2743.6	0.022300	0.360911	0.008048	0.023951
2743.7	0.022100	0.360706	0.007972	0.023723
2743.8	0.021900	0.360501	0.007895	0.023495
2743.9	0.021700	0.360296	0.007818	0.023267
2744.0	0.021500	0.360090	0.007742	0.023040
2744.1	0.021200	0.359341	0.007618	0.022671
2744.2	0.021000	0.358752	0.007534	0.022420
2744.3	0.020840	0.358265	0.007466	0.022219
2744.4	0.020600	0.357778	0.007370	0.021933
2744.5	0.020400	0.357291	0.007289	0.021691
2744.6	0.020200	0.356804	0.007207	0.021449
2744.7	0.020100	0.356318	0.007162	0.021314
2744.8	0.019900	0.355832	0.007081	0.021073
2744.9	0.019700	0.355347	0.007000	0.020833
2745.0	0.019500	0.354862	0.006920	0.020593
2745.1	0.019300	0.354294	0.006838	0.020349
2745.2	0.019200	0.353726	0.006792	0.020211
2745.3	0.018980	0.353159	0.006703	0.019948
2745.4	0.018800	0.352592	0.006629	0.019727

2745.5	0.018600	0.352026	0.006548	0.019486
2745.6	0.018500	0.351460	0.006502	0.019350
2745.7	0.018300	0.350895	0.006421	0.019110
2745.8	0.018200	0.350330	0.006376	0.018975
2745.9	0.018000	0.349766	0.006296	0.018736
2746.0	0.017900	0.349202	0.006251	0.018602
2746.1	0.017700	0.348719	0.006172	0.018369
2746.2	0.017500	0.348237	0.006094	0.018136
2746.3	0.017380	0.347755	0.006044	0.017987
2746.4	0.017200	0.347272	0.005973	0.017776
2746.5	0.017100	0.346790	0.005930	0.017648
2746.6	0.016900	0.346308	0.005853	0.017417
2746.7	0.016700	0.345826	0.005775	0.017187
2746.8	0.016500	0.345344	0.005698	0.016958
2746.9	0.016400	0.344863	0.005656	0.016831
2747.0	0.016200	0.344381	0.005579	0.016603
2747.1	0.016000	0.343866	0.005502	0.016373
2747.2	0.015800	0.343352	0.005425	0.016144
2747.3	0.015670	0.342837	0.005372	0.015988
2747.4	0.015500	0.342323	0.005306	0.015790
2747.5	0.015300	0.341809	0.005230	0.015563
2747.6	0.015100	0.341295	0.005154	0.015337
2747.7	0.015000	0.340781	0.005112	0.015212
2747.8	0.014800	0.340267	0.005036	0.014987
2747.9	0.014600	0.339753	0.004960	0.014762
2748.0	0.014400	0.339239	0.004885	0.014538
2748.1	0.014200	0.338762	0.004810	0.014316
2748.2	0.014000	0.338285	0.004736	0.014094
2748.3	0.013860	0.337808	0.004682	0.013933
2748.4	0.013678	0.337331	0.004614	0.013731
2748.5	0.013500	0.336854	0.004548	0.013533
2748.6	0.013300	0.336377	0.004474	0.013314
2748.7	0.013100	0.335900	0.004400	0.013095
2748.8	0.012949	0.335424	0.004343	0.012926
2748.9	0.012800	0.334947	0.004287	0.012759
2749.0	0.012600	0.334470	0.004214	0.012542
2749.1	0.012400	0.334049	0.004142	0.012327
2749.2	0.012200	0.333627	0.004070	0.012113
2749.3	0.012030	0.333205	0.004008	0.011929
2749.4	0.011800	0.332784	0.003927	0.011686
2749.5	0.011700	0.332362	0.003889	0.011572
2749.6	0.011500	0.331941	0.003817	0.011360
2749.7	0.011300	0.331519	0.003746	0.011148

2749.8	0.011100	0.331098	0.003675	0.010937
2749.9	0.010965	0.330676	0.003626	0.010790
2750.0	0.010800	0.330255	0.003567	0.010614
2750.1	0.010700	0.329493	0.003526	0.010492
2750.2	0.010500	0.329077	0.003455	0.010283
2750.3	0.010420	0.328649	0.003425	0.010191
2750.4	0.010348	0.328187	0.003396	0.010107
2750.5	0.010286	0.327725	0.003371	0.010032
2750.6	0.010231	0.327263	0.003348	0.009964
2750.7	0.010184	0.326802	0.003328	0.009904
2750.8	0.010144	0.326340	0.003310	0.009852
2750.9	0.010110	0.325879	0.003295	0.009805
2751.0	0.010083	0.325418	0.003281	0.009765
2751.1	0.010060	0.324992	0.003269	0.009730
2751.2	0.010042	0.324581	0.003259	0.009700
2751.3	0.010029	0.324170	0.003251	0.009675
2751.4	0.010018	0.323759	0.003243	0.009652
2751.5	0.010011	0.323348	0.003237	0.009633
2751.6	0.010006	0.322937	0.003231	0.009616
2751.7	0.010002	0.322526	0.003226	0.009600
2751.8	0.010000	0.322115	0.003221	0.009586
2751.9	0.009980	0.321704	0.003211	0.009555
2752.0	0.009960	0.321294	0.003200	0.009523
2752.1	0.009940	0.321023	0.003191	0.009496
2752.2	0.009919	0.320752	0.003182	0.009469
2752.3	0.009899	0.320481	0.003173	0.009441
2752.4	0.009879	0.320210	0.003163	0.009414
2752.5	0.009859	0.319939	0.003154	0.009387
2752.6	0.009839	0.319667	0.003145	0.009360
2752.7	0.009819	0.319395	0.003136	0.009333
2752.8	0.009799	0.319124	0.003127	0.009306
2752.9	0.009779	0.318852	0.003118	0.009279
2753.0	0.009758	0.318579	0.003109	0.009252
2753.1	0.009738	0.318313	0.003100	0.009225
2753.2	0.009718	0.318046	0.003091	0.009198
2753.3	0.009698	0.317780	0.003082	0.009171
2753.4	0.009678	0.317513	0.003073	0.009145
2753.5	0.009658	0.317246	0.003064	0.009118
2753.6	0.009638	0.316979	0.003055	0.009091
2753.7	0.009617	0.316711	0.003046	0.009065
2753.8	0.009597	0.316444	0.003037	0.009038
2753.9	0.009577	0.316176	0.003028	0.009011
2754.0	0.009557	0.315908	0.003019	0.008985

2754.1	0.009537	0.315518	0.003009	0.008955
2754.2	0.009517	0.315129	0.002999	0.008925
2754.3	0.009497	0.314740	0.002989	0.008895
2754.4	0.009477	0.314352	0.002979	0.008865
2754.5	0.009456	0.314291	0.002972	0.008845
2754.6	0.009436	0.313902	0.002962	0.008815
2754.7	0.009416	0.313512	0.002952	0.008785
2754.8	0.009396	0.313123	0.002942	0.008756
2754.9	0.009376	0.312734	0.002932	0.008726
2755.0	0.009356	0.312344	0.002922	0.008696
2755.1	0.009336	0.311872	0.002912	0.008665
2755.2	0.009315	0.311400	0.002901	0.008633
2755.3	0.009295	0.310928	0.002890	0.008601
2755.4	0.009275	0.310456	0.002880	0.008569
2755.5	0.009255	0.309984	0.002869	0.008538
2755.6	0.009235	0.309512	0.002858	0.008506
2755.7	0.009215	0.309040	0.002848	0.008475
2755.8	0.009195	0.308568	0.002837	0.008443
2755.9	0.009175	0.308096	0.002827	0.008412
2756.0	0.009154	0.307624	0.002816	0.008381
2756.1	0.009134	0.307064	0.002805	0.008347
2756.2	0.009114	0.306504	0.002794	0.008313
2756.3	0.009094	0.306265	0.002785	0.008289
2756.4	0.009074	0.305705	0.002774	0.008255
2756.5	0.009054	0.305146	0.002763	0.008222
2756.6	0.009034	0.304587	0.002752	0.008188
2756.7	0.009013	0.304028	0.002740	0.008155
2756.8	0.008993	0.303470	0.002729	0.008122
2756.9	0.008973	0.302912	0.002718	0.008089
2757.0	0.008953	0.302354	0.002707	0.008056
2757.1	0.008933	0.301877	0.002697	0.008025
2757.2	0.008913	0.301399	0.002686	0.007994
2757.3	0.008893	0.300922	0.002676	0.007964
2757.4	0.008873	0.300446	0.002666	0.007933
2757.5	0.008852	0.299969	0.002655	0.007902
2757.6	0.008832	0.299493	0.002645	0.007872
2757.7	0.008812	0.299018	0.002635	0.007842
2757.8	0.008792	0.298542	0.002625	0.007811
2757.9	0.008772	0.298067	0.002615	0.007781
2758.0	0.008752	0.297592	0.002604	0.007751
2758.1	0.008731	0.297339	0.002596	0.007726
2758.2	0.008711	0.297086	0.002588	0.007702
2758.3	0.008691	0.296833	0.002580	0.007678

2758.4	0.008671	0.296580	0.002572	0.007653
2758.5	0.008651	0.296326	0.002564	0.007629
2758.6	0.008631	0.296073	0.002555	0.007605
2758.7	0.008611	0.295820	0.002547	0.007580
2758.8	0.008591	0.295567	0.002539	0.007556
2758.9	0.008571	0.295313	0.002531	0.007532
2759.0	0.008550	0.295060	0.002523	0.007508
2759.1	0.008530	0.294843	0.002515	0.007485
2759.2	0.008510	0.294626	0.002507	0.007462
2759.3	0.008490	0.294409	0.002500	0.007438
2759.4	0.008470	0.294192	0.002492	0.007415
2759.5	0.008450	0.293975	0.002484	0.007392
2759.6	0.008429	0.293758	0.002476	0.007369
2759.7	0.008409	0.293541	0.002469	0.007346
2759.8	0.008389	0.293324	0.002461	0.007323
2759.9	0.008369	0.293107	0.002453	0.007300
2760.0	0.008349	0.292890	0.002445	0.007277
2760.1	0.008329	0.292610	0.002437	0.007253
2760.2	0.008309	0.292331	0.002429	0.007228
2760.3	0.008289	0.292051	0.002421	0.007204
2760.4	0.008268	0.291772	0.002413	0.007180
2760.5	0.008248	0.291493	0.002404	0.007155
2760.6	0.008228	0.291213	0.002396	0.007131
2760.7	0.008208	0.290934	0.002388	0.007107
2760.8	0.008188	0.290655	0.002380	0.007082
2760.9	0.008168	0.290376	0.002372	0.007058
2761.0	0.008148	0.290097	0.002364	0.007034
2761.1	0.008127	0.289773	0.002355	0.007009
2761.2	0.008107	0.289448	0.002347	0.006984
2761.3	0.008087	0.289124	0.002338	0.006958
2761.4	0.008067	0.288800	0.002330	0.006933
2761.5	0.008047	0.288476	0.002321	0.006908
2761.6	0.008027	0.288152	0.002313	0.006883
2761.7	0.008007	0.287828	0.002305	0.006858
2761.8	0.007987	0.287504	0.002296	0.006833
2761.9	0.007966	0.287180	0.002288	0.006808
2762.0	0.007946	0.286856	0.002279	0.006784
2762.1	0.007926	0.286453	0.002270	0.006757
2762.2	0.007906	0.286050	0.002262	0.006730
2762.3	0.007886	0.285647	0.002253	0.006704
2762.4	0.007866	0.285244	0.002244	0.006677
2762.5	0.007846	0.284842	0.002235	0.006651
2762.6	0.007826	0.284440	0.002226	0.006624

2762.7	0.007805	0.284037	0.002217	0.006598
2762.8	0.007785	0.283635	0.002208	0.006571
2762.9	0.007765	0.283234	0.002199	0.006545
2763.0	0.007745	0.282832	0.002191	0.006519
2763.1	0.007725	0.282133	0.002179	0.006486
2763.2	0.007705	0.281730	0.002171	0.006460
2763.3	0.007685	0.281327	0.002162	0.006434
2763.4	0.007664	0.280923	0.002153	0.006408
2763.5	0.007644	0.280521	0.002144	0.006382
2763.6	0.007624	0.280118	0.002136	0.006356
2763.7	0.007604	0.279715	0.002127	0.006330
2763.8	0.007584	0.279313	0.002118	0.006304
2763.9	0.007564	0.278911	0.002110	0.006278
2764.0	0.007544	0.278509	0.002101	0.006252
2764.1	0.007523	0.278137	0.002093	0.006227
2764.2	0.007503	0.277765	0.002084	0.006202
2764.3	0.007483	0.277683	0.002078	0.006184
2764.4	0.007463	0.277311	0.002070	0.006159
2764.5	0.007443	0.276939	0.002061	0.006134
2764.6	0.007423	0.276567	0.002053	0.006109
2764.7	0.007403	0.276195	0.002045	0.006085
2764.8	0.007383	0.275823	0.002036	0.006060
2764.9	0.007362	0.275451	0.002028	0.006035
2765.0	0.007342	0.275079	0.002020	0.006011
2765.1	0.007322	0.274697	0.002011	0.005986
2765.2	0.007302	0.274316	0.002003	0.005961
2765.3	0.007282	0.273934	0.001995	0.005936
2765.4	0.007262	0.273553	0.001986	0.005912
2765.5	0.007242	0.273171	0.001978	0.005887
2765.6	0.007221	0.272790	0.001970	0.005862
2765.7	0.007201	0.272409	0.001962	0.005838
2765.8	0.007181	0.272028	0.001953	0.005813
2765.9	0.007161	0.271647	0.001945	0.005789
2766.0	0.007141	0.271266	0.001937	0.005765
2766.1	0.007121	0.270993	0.001930	0.005743
2766.2	0.007101	0.270720	0.001922	0.005721
2766.3	0.007081	0.270447	0.001915	0.005699
2766.4	0.007060	0.270173	0.001908	0.005677
2766.5	0.007040	0.269900	0.001900	0.005655
2766.6	0.007020	0.269627	0.001893	0.005633
2766.7	0.007000	0.269354	0.001885	0.005611
2766.8	0.006980	0.269080	0.001878	0.005589
2766.9	0.006960	0.268807	0.001871	0.005567

2767.0	0.006940	0.268534	0.001864	0.005546
2767.1	0.006920	0.268357	0.001857	0.005526
2767.2	0.006899	0.268181	0.001850	0.005506
2767.3	0.006879	0.268005	0.001844	0.005487
2767.4	0.006859	0.267829	0.001837	0.005467
2767.5	0.006839	0.267652	0.001830	0.005447
2767.6	0.006819	0.267476	0.001824	0.005428
2767.7	0.006799	0.267300	0.001817	0.005408
2767.8	0.006778	0.267123	0.001811	0.005389
2767.9	0.006758	0.266947	0.001804	0.005369
2768.0	0.006738	0.266770	0.001798	0.005350
2768.1	0.006718	0.266529	0.001791	0.005329
2768.2	0.006698	0.266288	0.001784	0.005308
2768.3	0.006678	0.266047	0.001777	0.005287
2768.4	0.006658	0.265806	0.001770	0.005266
2768.5	0.006638	0.265565	0.001763	0.005246
2768.6	0.006617	0.265324	0.001756	0.005225
2768.7	0.006597	0.265084	0.001749	0.005204
2768.8	0.006577	0.264843	0.001742	0.005184
2768.9	0.006557	0.264478	0.001734	0.005161
2769.0	0.006537	0.264096	0.001726	0.005138
2769.1	0.006517	0.263794	0.001719	0.005116
2769.2	0.006497	0.263492	0.001712	0.005094
2769.3	0.006476	0.263190	0.001705	0.005073
2769.4	0.006456	0.262889	0.001697	0.005051
2769.5	0.006436	0.262587	0.001690	0.005030
2769.6	0.006416	0.262285	0.001683	0.005008
2769.7	0.006396	0.261984	0.001676	0.004987
2769.8	0.006376	0.261683	0.001668	0.004965
2769.9	0.006356	0.261109	0.001660	0.004939
2770.0	0.006336	0.260808	0.001652	0.004917
2770.1	0.006315	0.260489	0.001645	0.004896
2770.2	0.006295	0.260170	0.001638	0.004874
2770.3	0.006275	0.259851	0.001631	0.004853
2770.4	0.006255	0.259533	0.001623	0.004831
2770.5	0.006235	0.259214	0.001616	0.004810
2770.6	0.006215	0.258895	0.001609	0.004788
2770.7	0.006195	0.258576	0.001602	0.004767
2770.8	0.006175	0.258258	0.001595	0.004745
2770.9	0.006154	0.257939	0.001587	0.004724
2771.0	0.006134	0.257620	0.001580	0.004703
2771.1	0.006114	0.257276	0.001573	0.004681
2771.2	0.006094	0.256932	0.001566	0.004660

2771.3	0.006074	0.256588	0.001558	0.004638
2771.4	0.006054	0.256244	0.001551	0.004616
2771.5	0.006034	0.255900	0.001544	0.004595
2771.6	0.006013	0.255555	0.001537	0.004573
2771.7	0.005993	0.255211	0.001530	0.004552
2771.8	0.005973	0.254867	0.001522	0.004531
2771.9	0.005953	0.254523	0.001515	0.004509
2772.0	0.005933	0.254179	0.001508	0.004488
2772.1	0.005913	0.253921	0.001501	0.004468
2772.2	0.005893	0.253663	0.001495	0.004448
2772.3	0.005873	0.253405	0.001488	0.004429
2772.4	0.005852	0.253147	0.001481	0.004409
2772.5	0.005832	0.252777	0.001474	0.004387
2772.6	0.005812	0.252376	0.001467	0.004365
2772.7	0.005792	0.252118	0.001460	0.004346
2772.8	0.005772	0.251860	0.001454	0.004326
2772.9	0.005752	0.251602	0.001447	0.004307
2773.0	0.005731	0.251344	0.001441	0.004287
2773.1	0.005711	0.251131	0.001434	0.004268
2773.2	0.005691	0.250919	0.001428	0.004250
2773.3	0.005671	0.250707	0.001422	0.004231
2773.4	0.005651	0.250494	0.001416	0.004213
2773.5	0.005631	0.250282	0.001409	0.004194
2773.6	0.005611	0.250069	0.001403	0.004175
2773.7	0.005591	0.249856	0.001397	0.004157
2773.8	0.005570	0.249643	0.001391	0.004138
2773.9	0.005550	0.249430	0.001384	0.004120
2774.0	0.005530	0.249217	0.001378	0.004102
2774.1	0.005510	0.248948	0.001372	0.004082
2774.2	0.005490	0.248678	0.001365	0.004063
2774.3	0.005470	0.248409	0.001359	0.004044
2774.4	0.005450	0.248140	0.001352	0.004024
2774.5	0.005430	0.247871	0.001346	0.004005
2774.6	0.005409	0.247601	0.001339	0.003986
2774.7	0.005389	0.247332	0.001333	0.003967
2774.8	0.005369	0.247063	0.001327	0.003948
2774.9	0.005349	0.246795	0.001320	0.003929
2775.0	0.005329	0.246526	0.001314	0.003910
2775.1	0.005309	0.246200	0.001307	0.003890
2775.2	0.005289	0.245875	0.001300	0.003870
2775.3	0.005268	0.245806	0.001295	0.003854
2775.4	0.005248	0.245480	0.001288	0.003834
2775.5	0.005228	0.245155	0.001282	0.003814

2775.6	0.005208	0.244829	0.001275	0.003795
2775.7	0.005188	0.244504	0.001268	0.003775
2775.8	0.005168	0.244179	0.001262	0.003755
2775.9	0.005148	0.243599	0.001254	0.003732
2776.0	0.005128	0.243274	0.001247	0.003712
2776.1	0.005107	0.242950	0.001241	0.003693
2776.2	0.005087	0.242627	0.001234	0.003673
2776.3	0.005067	0.242304	0.001228	0.003654
2776.4	0.005047	0.241981	0.001221	0.003634
2776.5	0.005027	0.241658	0.001215	0.003615
2776.6	0.005007	0.241335	0.001208	0.003596
2776.7	0.004987	0.241012	0.001202	0.003577
2776.8	0.004966	0.240690	0.001195	0.003557
2776.9	0.004946	0.240367	0.001189	0.003538
2777.0	0.004926	0.240045	0.001183	0.003519
2777.1	0.004906	0.239792	0.001176	0.003501
2777.2	0.004886	0.239538	0.001170	0.003483
2777.3	0.004866	0.239285	0.001164	0.003465
2777.4	0.004846	0.239032	0.001158	0.003447
2777.5	0.004825	0.238779	0.001152	0.003429
2777.6	0.004805	0.238526	0.001146	0.003411
2777.7	0.004785	0.238273	0.001140	0.003393
2777.8	0.004765	0.238021	0.001134	0.003375
2777.9	0.004745	0.237768	0.001128	0.003357
2778.0	0.004725	0.237515	0.001122	0.003340
2778.1	0.004705	0.237290	0.001116	0.003322
2778.2	0.004685	0.237065	0.001111	0.003305
2778.3	0.004664	0.236592	0.001104	0.003284
2778.4	0.004644	0.236367	0.001098	0.003267
2778.5	0.004624	0.236142	0.001092	0.003250
2778.6	0.004604	0.235918	0.001086	0.003232
2778.7	0.004584	0.235693	0.001080	0.003215
2778.8	0.004564	0.235469	0.001075	0.003198
2778.9	0.004544	0.235244	0.001069	0.003181
2779.0	0.004523	0.235020	0.001063	0.003164
2779.1	0.004503	0.234841	0.001058	0.003147
2779.2	0.004483	0.234663	0.001052	0.003131
2779.3	0.004463	0.234485	0.001047	0.003114
2779.4	0.004443	0.234306	0.001041	0.003098
2779.5	0.004423	0.234128	0.001036	0.003082
2779.6	0.004403	0.233950	0.001030	0.003065
2779.7	0.004383	0.233772	0.001025	0.003049
2779.8	0.004362	0.233593	0.001019	0.003033

2779.9	0.004342	0.233502	0.001014	0.003017
2780.0	0.004322	0.233472	0.001009	0.003003
2780.1	0.004302	0.233332	0.001004	0.002987
2780.2	0.004282	0.233192	0.000999	0.002971
2780.3	0.004262	0.233052	0.000993	0.002956
2780.4	0.004242	0.232912	0.000988	0.002940
2780.5	0.004222	0.232771	0.000983	0.002924
2780.6	0.004201	0.232631	0.000977	0.002909
2780.7	0.004181	0.232491	0.000972	0.002893
2780.8	0.004161	0.232351	0.000967	0.002877
2780.9	0.004141	0.232211	0.000962	0.002862
2781.0	0.004121	0.232071	0.000956	0.002846
2781.1	0.004101	0.231923	0.000951	0.002830
2781.2	0.004080	0.231775	0.000946	0.002815
2781.3	0.004060	0.231628	0.000941	0.002799
2781.4	0.004040	0.231480	0.000935	0.002783
2781.5	0.004020	0.231332	0.000930	0.002768
2781.6	0.004000	0.230943	0.000924	0.002749
2781.7	0.003980	0.230795	0.000919	0.002734
2781.8	0.003960	0.230648	0.000913	0.002718
2781.9	0.003940	0.230500	0.000908	0.002702
2782.0	0.003920	0.230353	0.000903	0.002687
2782.1	0.003899	0.230241	0.000898	0.002672
2782.2	0.003879	0.230129	0.000893	0.002657
2782.3	0.003859	0.230017	0.000888	0.002642
2782.4	0.003839	0.229904	0.000883	0.002627
2782.5	0.003819	0.229792	0.000878	0.002611
2782.6	0.003799	0.229680	0.000872	0.002596
2782.7	0.003779	0.229568	0.000867	0.002581
2782.8	0.003758	0.229456	0.000862	0.002566
2782.9	0.003738	0.229343	0.000857	0.002551
2783.0	0.003718	0.229231	0.000852	0.002536
2783.1	0.003698	0.229127	0.000847	0.002522
2783.2	0.003678	0.228782	0.000841	0.002504
2783.3	0.003658	0.228601	0.000836	0.002488
2783.4	0.003638	0.228343	0.000831	0.002472
2783.5	0.003617	0.228238	0.000826	0.002457
2783.6	0.003597	0.228134	0.000821	0.002442
2783.7	0.003577	0.228030	0.000816	0.002428
2783.8	0.003557	0.227925	0.000811	0.002413
2783.9	0.003537	0.227821	0.000806	0.002398
2784.0	0.003517	0.227716	0.000801	0.002383
2784.1	0.003497	0.227571	0.000796	0.002368

2784.2	0.003477	0.227425	0.000791	0.002353
2784.3	0.003456	0.227279	0.000786	0.002338
2784.4	0.003436	0.227134	0.000780	0.002323
2784.5	0.003416	0.226988	0.000775	0.002308
2784.6	0.003396	0.226843	0.000770	0.002293
2784.7	0.003376	0.226460	0.000764	0.002275
2784.8	0.003356	0.226314	0.000759	0.002260
2784.9	0.003336	0.226169	0.000754	0.002245
2785.0	0.003315	0.226024	0.000749	0.002230
2785.1	0.003295	0.225865	0.000744	0.002215
2785.2	0.003275	0.225706	0.000739	0.002200
2785.3	0.003255	0.225547	0.000734	0.002185
2785.4	0.003235	0.225388	0.000729	0.002170
2785.5	0.003215	0.225230	0.000724	0.002155
2785.6	0.003195	0.225071	0.000719	0.002140
2785.7	0.003174	0.224912	0.000714	0.002125
2785.8	0.003154	0.224754	0.000709	0.002110
2785.9	0.003134	0.224595	0.000704	0.002095
2786.0	0.003114	0.224436	0.000699	0.002080
2786.1	0.003094	0.224260	0.000694	0.002065
2786.2	0.003074	0.224084	0.000689	0.002050
2786.3	0.003054	0.223908	0.000684	0.002035
2786.4	0.003034	0.223732	0.000679	0.002020
2786.5	0.003013	0.223556	0.000674	0.002005
2786.6	0.002993	0.223380	0.000669	0.001990
2786.7	0.002973	0.222970	0.000663	0.001973
2786.8	0.002953	0.222794	0.000658	0.001958
2786.9	0.002933	0.222619	0.000653	0.001943
2787.0	0.002913	0.222443	0.000648	0.001928
2787.1	0.002893	0.222242	0.000643	0.001913
2787.2	0.002873	0.222041	0.000638	0.001898
2787.3	0.002852	0.221840	0.000633	0.001883
2787.4	0.002832	0.221639	0.000628	0.001868
2787.5	0.002812	0.221438	0.000623	0.001853
2787.6	0.002792	0.221237	0.000618	0.001838
2787.7	0.002772	0.221036	0.000613	0.001823
2787.8	0.002752	0.220835	0.000608	0.001808
2787.9	0.002732	0.220634	0.000603	0.001793
2788.0	0.002711	0.220433	0.000598	0.001779
2788.1	0.002691	0.220241	0.000593	0.001764
2788.2	0.002671	0.220049	0.000588	0.001749
2788.3	0.002651	0.219857	0.000583	0.001735
2788.4	0.002631	0.219666	0.000578	0.001720

2788.5	0.002611	0.219474	0.000573	0.001705
2788.6	0.002591	0.219282	0.000568	0.001691
2788.7	0.002570	0.219067	0.000563	0.001676
2788.8	0.002550	0.218845	0.000558	0.001661
2788.9	0.002530	0.218624	0.000553	0.001646
2789.0	0.002510	0.218403	0.000548	0.001631
2789.1	0.002490	0.218229	0.000543	0.001617
2789.2	0.002470	0.218055	0.000539	0.001603
2789.3	0.002450	0.217881	0.000534	0.001588
2789.4	0.002429	0.217707	0.000529	0.001574
2789.5	0.002409	0.217562	0.000524	0.001560
2789.6	0.002389	0.217418	0.000519	0.001546
2789.7	0.002369	0.217046	0.000514	0.001530
2789.8	0.002349	0.216902	0.000510	0.001516
2789.9	0.002329	0.216758	0.000505	0.001502
2790.0	0.002309	0.216614	0.000500	0.001488
2790.1	0.002289	0.216569	0.000496	0.001475
2790.2	0.002269	0.216524	0.000491	0.001462
2790.3	0.002248	0.216479	0.000487	0.001448
2790.4	0.002228	0.216434	0.000482	0.001435
2790.5	0.002208	0.216389	0.000478	0.001422
2790.6	0.002188	0.216344	0.000473	0.001409
2790.7	0.002168	0.216300	0.000469	0.001395
2790.8	0.002148	0.216255	0.000464	0.001382
2790.9	0.002128	0.216210	0.000460	0.001369
2791.0	0.002107	0.216165	0.000456	0.001356
2791.1	0.002087	0.216198	0.000451	0.001343
2791.2	0.002067	0.216231	0.000447	0.001330
2791.3	0.002047	0.216264	0.000443	0.001317
2791.4	0.002027	0.216297	0.000438	0.001305
2791.5	0.002007	0.216330	0.000434	0.001292
2791.6	0.001987	0.216363	0.000430	0.001279
2791.7	0.001966	0.216396	0.000426	0.001266
2791.8	0.001946	0.216429	0.000421	0.001254
2791.9	0.001926	0.216462	0.000417	0.001241
2792.0	0.001906	0.216267	0.000412	0.001227
2792.1	0.001886	0.216343	0.000408	0.001214
2792.2	0.001866	0.216419	0.000404	0.001202
2792.3	0.001846	0.216495	0.000400	0.001189
2792.4	0.001826	0.216571	0.000395	0.001177
2792.5	0.001805	0.216648	0.000391	0.001164
2792.6	0.001785	0.216724	0.000387	0.001151
2792.7	0.001765	0.216800	0.000383	0.001139

2792.8	0.001745	0.216876	0.000378	0.001126
2792.9	0.001725	0.216952	0.000374	0.001114
2793.0	0.001705	0.217257	0.000370	0.001102
2793.1	0.001685	0.217285	0.000366	0.001089
2793.2	0.001664	0.217313	0.000362	0.001076
2793.3	0.001644	0.217341	0.000357	0.001064
2793.4	0.001624	0.217369	0.000353	0.001051
2793.5	0.001604	0.217397	0.000349	0.001038
2793.6	0.001584	0.217196	0.000344	0.001024
2793.7	0.001564	0.217224	0.000340	0.001011
2793.8	0.001544	0.217252	0.000335	0.000998
2793.9	0.001523	0.217280	0.000331	0.000985
2794.0	0.001503	0.217308	0.000327	0.000972
2794.1	0.001483	0.217245	0.000322	0.000959
2794.2	0.001463	0.217182	0.000318	0.000946
2794.3	0.001443	0.217170	0.000313	0.000933
2794.4	0.001423	0.217275	0.000309	0.000920
2794.5	0.001403	0.217212	0.000305	0.000907
2794.6	0.001383	0.217149	0.000300	0.000893
2794.7	0.001362	0.217086	0.000296	0.000880
2794.8	0.001342	0.217023	0.000291	0.000867
2794.9	0.001322	0.216960	0.000287	0.000854
2795.0	0.001302	0.216897	0.000282	0.000840
2795.1	0.001282	0.216812	0.000278	0.000827
2795.2	0.001262	0.216727	0.000273	0.000814
2795.3	0.001242	0.216642	0.000269	0.000800
2795.4	0.001221	0.216557	0.000265	0.000787
2795.5	0.001201	0.216472	0.000260	0.000774
2795.6	0.001181	0.216387	0.000256	0.000761
2795.7	0.001161	0.216075	0.000251	0.000747
2795.8	0.001141	0.215990	0.000246	0.000733
2795.9	0.001121	0.215905	0.000242	0.000720
2796.0	0.001101	0.215820	0.000238	0.000707
2796.1	0.001081	0.215713	0.000233	0.000694
2796.2	0.001060	0.215606	0.000229	0.000680
2796.3	0.001040	0.215498	0.000224	0.000667
2796.4	0.001020	0.215391	0.000220	0.000654
2796.5	0.001000	0.215284	0.000215	0.000641
2796.6	0.000955	0.215176	0.000206	0.000612
2796.7	0.000907	0.215069	0.000195	0.000581
2796.8	0.000856	0.214962	0.000184	0.000547
2796.9	0.000802	0.214628	0.000172	0.000512
2797.0	0.000744	0.214521	0.000160	0.000475

2797.1	0.000684	0.214448	0.000147	0.000436
2797.2	0.000620	0.214374	0.000133	0.000396
2797.3	0.000554	0.214301	0.000119	0.000353
2797.4	0.000484	0.214228	0.000104	0.000308
2797.5	0.000411	0.214154	0.000088	0.000262
2797.6	0.000335	0.214081	0.000072	0.000213
2797.7	0.000256	0.214008	0.000055	0.000163
2797.8	0.000174	0.213934	0.000037	0.000111
2797.9	0.000088	0.213635	0.000019	0.000056
2798.0	0.000000	0.213562	0.000000	0.000000

Table D.7-14. MetOp-B HIRS/307 Channel 20 Slope and Intercept (Albedo %).		
Source	Slope	Intercept
Pre-launch calibration	0.02715	82.3500
Post-launch calibration	TBD	TBD

AMSU:

Table D.7-15. MetOp-B AMSU-A1 (S/N 108, ID=XX) PRT Temperature Conversion Coefficients.					
	PRT #	f_{k0} (K)	f_{k1} (K/count)	f_{k2} (K/count2)	f_{k3} (K/count3)
Scan Motor A1-1	1	263.4500	1.758281E-03	3.776942E-09	1.045518E-14
Scan Motor A1-2	2	263.6895	1.750961E-03	3.906845E-09	9.214732E-15
Feedhorn A1-1	3	263.2957	1.748610E-03	3.620275E-09	1.955832E-14
Feedhorn A1-2	4	263.2468	1.754621E-03	3.729692E-09	1.224483E-14
RF Mux A1-1	5	264.0316	1.758565E-03	3.633179E-09	1.415604E-14
RF Mux A1-2	6	263.5459	1.745708E-03	4.087797E-09	6.877655E-15
L.O. CH 3	7	264.1317	1.776428E-03	1.743998E-09	5.693570E-14
L.O. CH 4	8	2.631476	1.756688E-03	3.432068E-09	1.715760E-14
L.O. CH 5	9	263.9358	1.759666E-03	3.64910E-09	1.314828E-14
L.O. CH 6	10	263.5296	1.753765E-03	3.563556E-09	1.442709E-14
L.O. CH 7	11	263.3737	1.757464E-03	3.680657E-09	1.305827E-14
L.O. CH 8	12	263.5568	1.754537E-03	3.784778E-09	1.139240E-14
L.O. CH 15	13	263.4084	1.754741E-03	3.737990E-09	1.255287E-14
PLLO #2 CH9-14	14	263.6483	1.756937E-03	3.750167E-09	1.241121E-14
PLLO #1 CH9-14	15	263.8492	1.746799E-03	4.098968E-09	6.707079E-15
Not Used	16	0.000000	.0000000	0.000000	0.000000
Mixer/IF CH 3	17	263.9014	1.758879E-03	3.700657E-09	1.142527E-14
Mixer/IF CH 4	18	263.5892	1.765190E-03	3.310742E-09	1.555509E-14
Mixer/IF CH 5	19	264.0800	1.761166E-03	3.760229E-09	9.199774E-15
Mixer/IF CH 6	20	263.5704	1.758490E-03	3.551755E-09	1.509689E-14
Mixer/IF CH 7	21	263.6794	1.753715E-03	3.850171E-09	1.004074E-14
Mixer/IF CH 8	22	263.7309	1.754421E-03	3.846902E-09	1.015909E-14
Mixer/IF CH9 -14	23	263.6108	1.758385E-03	3.735271E-09	1.251413E-14
Mixer/IF CH 15	24	263.8234	1.816009E-03	-1.123325E-9	1.118221E-13
IF Amp.CH11 - 14	25	263.6217	1.758621E-03	3.847305E-09	1.077732E-14
IF Amp. CH 9	26	263.3883	1.750234E-03	3.822652E-09	1.058365E-14
IF Amp. Ch.10	27	263.6809	1.750587E-03	4.155557E-09	5.377089E-15
IF Amp. Ch.11	28	263.1202	1.753775E-03	3.824615E-09	1.097406E-14
DC/DC Converter	29	263.2312	1.757984E-03	3.863116E-09	1.034859E-14
IF Amp. Ch.13	30	263.6065	1.760069E-03	3.743452E-09	1.195857E-14
IF Amp. Ch.14	31	263.3785	1.757888E-03	3.508320E-09	1.548673E-14

IF Amp. Ch.12	32	264.4315	1.758692E-03	3.716511E-09	1.281829E-14
RF Shelf A1-1	33	263.3667	1.753562E-03	3.773557E-09	1.157848E-14
RF Shelf A1-2	34	263.4328	1.746659E-03	3.980124E-09	7.519710E-15
Detector/PreAmp	35	263.4804	1.747772E-03	4.072002E-09	6.546018E-15
A1-1WarmLoad#1	36	254.8997	1.648687E-03	5.991585E-09	3.065891E-14
A1-1WarmLoad#2	37	254.7430	1.652318E-03	6.019787E-09	2.985889E-14
A1-1WarmLoad#3	38	254.6643	1.653924E-03	5.984108E-09	2.977630E-14
A1-1WarmLoad#4	39	254.8877	1.657419E-03	5.934120E-09	3.170922E-14
A1-1WmLdCenter	40	254.1918	1.646504E-03	6.076072E-09	2.822418E-14
A1-2WarmLoad#1	41	255.6000	1.616267E-03	6.159216E-09	3.710113E-14
A1-2WarmLoad#2	42	254.7424	1.648622E-03	5.930811E-09	3.039077E-14
A1-2WarmLoad#3	43	255.5381	1.618047E-03	6.105881E-09	3.642724E-14
A1-2WarmLoad#4	44	255.4768	1.629635E-03	6.206130E-09	3.855268E-14
A1-2WmLdCenter	45	254.4784	1.647034E-03	5.951871E-09	2.956863E-14

Table D.7-16. METOP-B AMSU-A2 (S/N 106) PRT Temperature Conversion Coefficients.					
	PRT #	f_{k0} (K)	f_{k1} (K/count)	f_{k2} (K/count²)	f_{k3} (K/count³)
Scan Motor	1	263.0500	1.768701E-03	3.035826E-09	2.411055E-14
Feedhorn	2	263.9791	1.755278E-03	3.676936E-09	1.338868E-14
RF Diplexer	3	263.0303	1.751818E-03	3.772822E-09	1.201623E-14
Mixer/IF Ch 1	4	262.8936	1.750950E-03	3.741844E-09	1.193591E-14
Mixer/IF Ch 2	5	263.3983	1.747844E-03	3.904778E-09	1.124681E-14
Ch1 DRO	6	263.6706	1.748606E-03	3.732496E-09	1.196941E-14
Ch2 DRO	7	264.0607	1.757530E-03	3.787052E-09	1.074201E-14
Compensator Motor	8	263.5399	1.756535E-03	3.293439E-09	2.392853E-14
Sub Reflector	9	263.6364	1.762558E-03	3.111749E-09	2.573409E-14
DC/DC Converter	10	264.0059	1.752656E-03	3.763642E-09	1.140793E-14
RF Shelf	11	263.9771	1.667745E-03	4.409753E-09	2.290814E-14
Detector Pre-Amp	12	263.8627	1.757180E-03	3.719581E-09	1.268086E-14
Warm Load Ctr	13	254.5488	1.652287E-03	5.853095E-09	3.339400E-14
Warm Load #1	14	254.8630	1.659508E-03	6.012053E-09	3.185466E-14
Warm Load #2	15	254.4708	1.651211E-03	5.842483E-09	3.249341E-14
Warm Load #3	16	254.6503	1.647149E-03	6.171147E-09	2.653088E-14
Warm Load #4	17	254.5548	1.652328E-03	5.916694E-09	3.096232E-14
Warm Load #5	18	254.4847	1.649702E-03	6.029762E-09	2.927145E-14
Warm Load #6	19	254.7206	1.651919E-03	6.051796E-09	2.758804E-14

Ch #	Instrument/Serial #	Central Frequency (GHz)	Central Wavenumber (cm ⁻¹)	I/F Frequencies (GHz)			
				Sideband 1		Sideband 2	
				Begin (f ₁)	End (f ₂)	Begin (f ₃)	End (f ₄)
1*	A2/108	23.80084	0.793897	0.00872	0.13423	N/A	N/A
2*	A2/108	31.39952	1.047421	0.00877	0.08912	N/A	N/A
3*	A1-2/106	50.29974	1.677830	0.00890	0.08900	N/A	N/A
4*	A1-2/106	52.80007	1.761235	0.00912	0.19916	N/A	N/A
5	A1-2/106	53.59597	1.787785	0.03138	0.19886	N/A	N/A
6*	A1-1/106	54.40008	1.814590	0.00915	0.19933	N/A	N/A
7*	A1-1/106	54.94034	1.832608	0.00910	0.19919	N/A	N/A
8*	A1-2/106	55.50025	1.851295	0.00914	0.16402	N/A	N/A
9*	A1-1/106	57.29034	1.911001	0.00911	0.16415	N/A	N/A
10	A1-1/106	57.29034	1.911001	0.17901	0.25534	N/A	N/A
11	A1-1/106	57.29034	1.911001	0.25681	0.29166	0.35266	0.38803
12	A1-1/106	57.29034	1.911001	0.29255	0.30798	0.33633	0.35183
13	A1-1/106	57.29034	1.911001	0.30829	0.31614	0.32822	0.33609
14	A1-1/106	57.29034	1.911001	0.31632	0.31925	0.32531	0.32825
15*	A1-1/106	89.00971	2.968887	0.49208	1.48898	N/A	N/A

* The lower frequency cutoff in these single passband channels is due to the stop band.

Table D.7-17 contains the measured channel characteristics for METOP-B AMSU-A (channels 1-15). The central frequencies are interpolated from the temperature dependent data to 15 C. The f₁, f₂, f₃, and f₄ for channels 11-14 are computed from tabulated values. All values are for 15 C. Detailed information on the terminology used in this table can be found in Section 3.3.2.1.

MHS:

PRT #	f _{k0}	f _{k1}	f _{k2}	f _{k3}	PIE-A/B
A1	25.22634	2.416384	4.649441E-04	1.63655E-06	PIE-A
A2	30.20554	2.271096	1.856288E-04	-2.779819E-07	
A3	29.08906	2.304027	1.546938E-03	-1.813721E-07	
A4	27.69009	2.343849	1.173131E-03	-6.559966E-07	
A5	31.28914	2.239868	2.168793E-03	-3.815892E-05	
B1	26.17037	2.389775	7.117249E-04	-8.779940E-05	PIE-B
B2	27.87629	2.338990	1.213371E-03	-7.601953E-07	
B3	24.75568	2.430677	3.197226E-03	2.130234E-06	
B4	29.85037	2.283257	1.736160E-03	-2.388943E-06	
B5	26.96129	2.367066	9.293956E-02	-1.877201E-07	

Rcal 1	Rcal 2	Rcal 3	PIE-A or -B
117.970	95.279	85.594	PIE-A
117.986	95.283	80.601	PIE-B

g₀	g₁	g₂	g₃	g₄
355.9982	-0.239278	-4.85712E-03	3.59838E-05	-8.02652E-08

Note:
1. One set of coefficients applies to 24 housekeeping thermistors.

Name	Intercept	Slope
RDM Motor	0.000000	0.0133700
FDM Motor	0.000000	0.0133700
EE+SM+5V	0.000000	0.0168100
Receiver+8V	-.0769000	0.0207200
Receiver+15V	-.0628000	0.0078900
Receiver-15V	-.0005358	0.0019030

h₀	h₁	h₂	h₃	h₄	h₅
363.4522	-108.1000	64.2120	-22.8659	4.1100	-0.2950

Instru- ment Temp. (See Note 1)	Ch 16	Ch 17	Ch. 18	Ch. 19	Ch. 20	LO (C)
14.4						LO-A
25.4	-5.638002 E-03	-2.39221 3E-04	-2.953739E-02	-2.247278E-02	-2.606214E-03	LO-A
38.1						LO-A
14.4						LO-B
25.4						LO-B
38.1						LO-B

Note:
1. QBS5 temperature.

Table D.7-24. MetOp-B MHS Wavenumbers and Band-Correction Factors.			
Channel Number	Wavenumber (cm-1)	Band-correction factors: $T_w' = b + c * T_w$	
		b	c
16	2.968720	0.0	1.0
17	5.236956	0.0	1.0
18	6.114597	0.0	1.0
19	6.114597	-0.0031	1.00027
20	6.348092	0.0	1.0

Table D.7-25. MetOp-B MHS (PFM, S/N=103) Channel IF Characteristics.				
Channel	Nominal Center Frequency (GHz)	Lower IF -3 dB Frequency (GHz)	Upper IF -3 dB Frequency (GHz)	# Bandpasses
H1				1
H2				1
H3				2
H4				2
H5				1

APPENDIX E: INDEX OF INTERNET RESOURCES

The following list of Internet sites, while not inclusive, provides important sources of information about the NOAA-operated polar orbiting satellites, navigation information, and the satellite programs of other countries. Sites that are primarily sources of imagery, general meteorological or other environmental information, are not included.

NOAA Satellite Information System (NOAASIS):

<http://noaasis.noaa.gov/NOAASIS/>

The NOAASIS contains orbital elements and information, operating schedules, status reports and technical information about all NOAA operated satellites. The NOAA Satellite Information System (NOAASIS) web site is a central location for finding information about NOAA environmental satellites (GOES and POES). Information is provided by various contributors within the National Environmental Satellite, Data, and Information Service (NESDIS) and the external satellite community.

National Environmental Satellite, Data, and Information Service (NESDIS):

<http://www.nesdis.noaa.gov>

NESDIS home page contains information about the NOAA satellite operations, operational products produced and new research with many links to other components of NESDIS.

Office of Satellite and Product Operations (OSPO):

<http://www.ospo.noaa.gov>

NESDIS Office of Satellite and Product Operations contains general information about the Division and pointers to Division branches. Branch pages contain details of activities, technical information and some examples of image products.

STAR / SMCD / SPB Solar Backscatter Ultraviolet (SBUV/2)

Project:<http://www.star.nesdis.noaa.gov/smcd/spb/ozone/>

NOAA National Climate Prediction Center

(NCEP):<http://www.cpc.ncep.noaa.gov/products/stratosphere/sbu2to/>

home page contains information on daily SBUV/2 maps and monitoring of the ozone hole.

Coordination Group for Meteorological Satellites (CGMS):

<http://www.cgms-info.org/index.php/cgms/index> Contains general information about the satellite programs of all Group members, i.e., all nations operating meteorological/environmental satellites.

European Space Agency (ESA):<http://www.esa.int/esaCP/index.html>

ESA is an international organisation with 20 Member States. By coordinating the financial and intellectual resources of its members, it can undertake programmes and activities far beyond the scope of any single European country..

European Organization for the Exploitation of Meteorological Satellites

EUMETSAT):<http://www.eumetsat.int/Home/index.htm>

EUMETSAT is an intergovernmental organization founded in 1986. Its purpose is to supply weather and climate-related satellite data, images and products. It contains extensive information about the METEOSAT and METOP satellite programs.

Comprehensive Large Array-data Stewardship System (CLASS): <http://www.class.noaa.gov>
CLASS is NOAA's information technology system designed to support long-term, secure preservation and standards-based access to environmental data collections and information. Currently, the NOAA National Data Centers support POES, DMSP, GOES, MetOp, Jason-2, Suomi NPP data and selected model reanalysis data within the CLASS infrastructure. Future satellite-based collections planned for archival storage in the system include JPSS, GOES-R, and Jason-3. Users must register to have complete access to all data and services.

Historical TBUS Orbital Element Messages

<ftp://ftp.tkl.iis.u-tokyo.ac.jp/pub/TBUS/>

An archive of the TBUS orbital element messages for NOAA satellites is contained in this directory dating back to 1983. The file extension indicates the NOAA satellite number (e.g., the file TBUS020602.14 would be the TBUS for NOAA-14 for Feb. 6, 2002). Maintained by the Institute of Industrial Science, University of Tokyo.

Direct Near Real-time Data Access Request:

<http://www.ospo.noaa.gov/Organization/About/access.html>

NOAA's Satellite and Information Services (NESDIS) recognizes the need for full and open exchange of environmental satellite data and products, as allowed and governed by relevant laws, international agreements, national and organizational policies and the availability of resources. The link shown above contains instructions for submitting a Data Access Request Form and an overview of the review process.

APPENDIX F: ORDERING RETROSPECTIVE DATA

Orders for retrospective AVHRR and TOVS Level 1b data can be placed through the Comprehensive Large Array-data Stewardship System (CLASS) website at www.class.noaa.gov. All ad hoc orders placed via the CLASS website are free. Requests for bulk orders or data to be copied to physical media for shipping must go to the National Climatic Data Center (NCDC). Please contact the NCDC Satellite Services Group at NCDC.satorder@noaa.gov with details. Each bulk order request will be reviewed to ascertain cost and delivery schedule. All servicing costs must be paid in advance before the order is fulfilled.

Subscriptions to near real-time data can be requested via the CLASS Help Desk at class.help@noaa.gov.

When placing a bulk order request to NCDC, the following parameters should be specified to insure accuracy in estimating cost and delivery time:

- Type of data (also specify whether Level 1b or operational product)
- Dates and times of data
- Channels
- Satellite name
- Day, night or both
- Area (latitude/longitude box)
- Orbit numbers if known
- Media type (only external hard drives are offered – preferably formatted for LINUX)
- Packed or unpacked (Level 1b data only)

APPENDIX G: DATA CHANGES AND PROBLEM RECORD

This appendix is considered outdated and no attempt will be made to keep it current. However, since it contains a historical record of events that affected the NOAA KLM Level 1b data and some of its products up through around 2003, the appendix continues to be accessible. To obtain a complete history of mission and operational changes please see the Level 1b Notices website at <http://www.ospo.noaa.gov/Products/ppp/index.html>. Also, users can contact the National Climatic Data Center's Satellite Services Group at NCDC.satorder@noaa.gov with any questions regarding Level 1b data and its products.

Appendix G.1	Changes made to NOAA KLM Level 1b data
Appendix G.2	Changes made to NESDIS' SST Observation Product
Appendix G.3	Changes made to Navy's SST Observation Product
Appendix G.4	Changes made to Mapped GAC Products
Appendix G.5	Changes made to Radiation Budget Products
Appendix G.6	Changes made to Sounding Products (ATOVS and AMSU-B)
Appendix G.7	Changes made to CoastWatch Products
Appendix G.8	Changes made to Snow and Ice Products
Appendix G.9	Changes made to Ozone (SBUV/2) Products
Appendix G.10	Changes made to Aerosol/Optical Thickness Products

G.1 CHANGES MADE TO NOAA KLM LEVEL 1B DATA

The following is a chronological list of changes that were made to the Level 1b data.

01 Sep 1999

On September 15, 1999, we plan to update the NOAA-K/15 Level 1b preprocessor to correct AVHRR Telemetry Time Code array Words 1 & 2. The implementation should be transparent to both the Level 1b and the Level 1b* users. Parallel testing was executed from 08/25/99 1400L to 08/26/99 1100L. No anomalies occurred during testing.

14 Sep 1999

On Wednesday, September 15, 1999 Release 2.4.1 of the NOAA-K Preprocessor will be put into operation. The release includes CCR#1310, CCR#1311 and WR#1188. A new load module for the AVHRR preprocessor and an updated version of the CPIDS database will be installed into operations between 1100L and 1300L. The first orbit to be processed will be NSS.HRPT.NK.D99258.S1718.E1730.B0696969.GC scheduled to be ingested at 1318 L.

CCR#1310: Corrects an intermittent problem which causes the AVHRR preprocessor to abort when an invalid Frame Number is received during the extraction of TIP Housekeeping Analog data.

CCR#1311: Corrects formatting errors in items ID_AVHRR word(1) and TIME_CODE words (1 & 2)

WR#1188: Updates the NOAA-K CPIDS AMSU-B bias correction table for STX-2

27 Sep 1999

At 0100 on September 28th the STX-2, and STX-4 antennas on the AMSU-B instrument aboard NOAA-15 will become the new operational antennae. This will be done to stabilize the biases that have been occurring since the launch of NOAA-15. The current bias values in the Level 1b header for STX-2 are compatible with this new configuration. This new configuration will reduce the amount of LAC data from NOAA-15. Also by switching to STX-2 the HRPT data will be less noisy.

03 Jan 2000

After re-configuring the STX antennas on NOAA-15, the previous AMSU-B bias has been minimized and stabilized. The monitoring of this new configuration since September 28, 1999 has shown little change in the bias. Therefore, it has been decided to declare the NOAA-15 Level 1b, 1b* AMSU-B an operational product as of January 6, 2000. Bias correction updates will still be implemented to perform bias corrections as deemed necessary by the instrument scientists.

11 Feb 2000

The following updates to the CPIDS file (calibration parameters instrument data set) will be put into operation on February 16 as planned. This update includes (data changes only):

1. AMSU-B STX antenna bias corrections updated in the Level 1b/1b* header record
2. CPIDS Coefficient Correction - One of the NOAA-15 AMSU-A2 PRT conversion coefficients (which are output into Header Record in AMSU-A Level 1b data) was found to be incorrect. The AMSU-A Level 1b Header Record location is (AMSU-A2 Warm Load 1 Temp. Conv. Coeff. 3) at bytes: 2141-2144. The current incorrect value is 2.812463E-14 and the correct value is 2.824335E-14.

On February 23, 2000, the remainder of the updates will be put into operations. The following updates are included (software changes):

AMSU-A:

AMSU-A PLLO2 Coefficients. Fixes problem which causes incorrect coefficients to be applied to channels 6, 7 and 15.

Corrects AMSU-A data corruption reported by Nigel Atkinson - where on some occasions data to be filled into a portion of the calibration scan were not filled in causing bogus data.

AMSU-B:

Correction of AMSU-B Level 1b to 1b* Retro Converter to return correct values for SARR_A_POWER and SARR_B_POWER.

HIRS:

Corrects problem where HIRS scan line numbers repeat in Level 1b* after a data gap.

07 Mar 2000

On Wednesday March 8, 2000 release 2.5 of the NOAA-K Preprocessor will be put into operation as announced on February 28, 2000. The release includes software changes for

AMSU-A and HIRS, the AMSU-B 1b* to 1b converter, and the AMSU-B 1b to 1b* retro converter. It also includes an updated version of the calibration parameter database with STX bias updates and AMSU-A coefficient changes. The installation of these changes will occur between 1045L and 1230L.

The first orbits to be processed will be
 NSS.GHRR.NK.D00068.S1553.E1725.B0945758.GC
 NSS.HRPT.NK.D00068.S1726.E1739.B0945858.GC .
 The scheduled ingest time for the HRPT orbit is 1226L.

18 May 2000

We are ready to implement changes to the Level 1b data that will correct the anomalies listed in an earlier notice. We are in the process of reviewing the test data internally. This is just a reminder that the change is coming. Below is specific information that you need to update your software. In order to be ready for the NOAA-L launch, our plan is to implement this change along with internal NOAA-L specific changes on July 11, 2000.

SPECIFIC CHANGES

Level 1b users must update their software to utilize the corrections for moonlight detected in the HIRS data.

Correction of NOAA-K HIRS Moon in Space View (CCR 1197): This update requires a change in the HIRS Level 1b data file.

Level 1b data users: A one-bit field per scan line has been inserted in the Level 1b file record format under "QUALITY INDICATORS"; scan line quality flags "CALIBRATION PROBLEM CODE" (to be renamed CALIBRATION ANOMALY CODE); in spare bit 9. The new item indicates moonlight detected in space views for this scan.

Impact on accuracy of data: As reported by Michael Chalfant, the magnitude of this problem becomes apparent when a comparison is made between the calibrated earth measurements using the current operationally generated calibration coefficients and those using the new coefficients.

Table G.1-1 displays the magnitude (in K) of the error for each of the HIRS/3 channels resulting from the incorrect generation of the in-flight thermal calibration coefficients. Please note that the brightness temperatures errors measured for channels # 11-19 using the appended calibration coefficients are greater than indicated by this table because the on-line ATOVS software has a cutoff so that ridiculously low radiances do not cause the Planck function to fail during processing.

Table G.1-1. Comparison of Error in the HIRS/3 Channels Resulting from Incorrect Generation of In-flight Thermal Calibration Coefficients.		
Channel #	Full Moon Operational Error (K)	Partial Moon Operational Error (K)
1	39	4

2	43	4
3	44	4
4	46	4
5	42	3
6	40	3
7	36	3
8	42	5
9	115	5
10	36	3
11	>120	7
12	>107	12
13	>93	11
14	>77	15
15	>72	23
16	>82	28
17	>91	11
18	>104	8
19	>85	8

Testing of a second moonlight event where there was only a partial moon contamination of the HIRS/3 calibration Space View revealed that some channel brightness temperatures were affected by as much as 28 K. Since only the colder end of the spectrum (for each channel) is affected and the nearest cold area was a large cloud (which was not close to the contaminated calibration cycle), there was a smaller (but still unacceptable) impact than the full moon contamination test.

26 May 2000

Beginning sometime after May 19th, we noticed that the earth location error seen in the NOAA-14 AVHRR data is consistently about 1 to 2 kilometers. has not changed and if used with the current data will increase the error. We are observing the Level 1b data to determine if this is a consistent change and to get some idea of why it has occurred. Data for the other NOAA satellites have not changed. If our continued investigation next week indicates that the clock drift data should be updated, the Navigation website will be updated.

01 Jun 2000

On May 24, 2000 at 23:59:00, a clock error of +500 milliseconds occurred on NOAA-15 due to a change in the Flight Software.

05 Jun 2000

In an effort to improve our ability to update and manage clock adjustments, SOCC has conducted a test on the NOAA-15 orbit number 10724. The test began around 1739Z and lasted through 1745Z. During this test time period, adjustments were made every 45 seconds in the following sequence.

+ 100 milliseconds (ms)

- 100 ms
- +900 ms
- 900 ms
- + 250 ms
- 250 ms
- + 750 ms
- 750 ms

At the end of the test, data should have returned to the pretest condition.

07 Jun 2000

The NOAA-15 HIRS Channel 1 Period Monitor over the past 24 hours has reflected sporadic limit violations and an increased filter motor current. The limit violations are for those already expanded due to previous anomalies. There has also been a loss of sync with the filter wheel for 2-3 hours (since 6:30 am). The next pass is expected between 9:30 and 10 am and SOCC, NASA and ITT engineers are monitoring/investigating. FYI: Symptoms at this time are more representative of an intermittent contaminant within the bearing lubrication vs. an end-of-life scenario.

09 Jun 2000

As of 16:07 UTC June 9, 2000 the HIRS Filter Wheel Motor on NOAA-15 was placed in the nominal operation mode. This is an effort to correct the previously observed anomaly on NOAA-15. The motor has been operating in the high mode for approximately the last 36 hours.

09 Jun 2000

At 19:46 UTC June 8, 2000, the ATOVS system was modified to not use the HIRS data in processing. This was done by modifying cloud detection thresholds to flag all retrievals as cloudy and by removing the HIRS channel 2 from the retrieval generation step. We continue to use the HIRS to co-locate the AMSU-A to the HIRS footprint, but we do not use the channel data in our processing. Again, the high quality of the cloudy AMSU-A only soundings continues.

The HIRS instrument has not improved its status after the filter wheel was put in high power mode. The filter wheel continues to slip which causes a shift in the brightness temperatures. The instrument scientists continue to troubleshoot the problem.

13 Jun 2000

This morning a telecon was held with ITT, SAO, NASA, OSO, OSDPD and OSD participants to review the latest status of the HIRS Filter Wheel (FW) anomaly on NOAA-15.

-The FW motor has generally stabilized since we went back to nominal power mode around noon on Friday. There remain some periods of instability when the FW goes out of synchronization for about 2.5 hours and then returns to normal. OSO has been tasked to examine these events and determine if there is something going on within the spacecraft during that period which is causing the problem.

-The soundings people have noticed a general decrease in the number of cloudy soundings generated from NOAA 15. The percentage of cloudy soundings have dropped from 90% last Thursday (during FW high power mode) to less than 70% as of this morning. They are still using the AMSU-only soundings mode of operation until they decide to go to normal HIRS-AMSU soundings. They will make a decision this afternoon whether or not to return to normal operations.

The Longwave Outgoing Radiation group does not notice any change in the quality of their data.

-ITT and NASA will draft a fault path analysis for all to follow to narrow down the cause of the anomaly. At the moment, ITT and NASA have not eliminated the "debris in the bearings" theory. Two other hypotheses are:

1. The 1Hz clock signal coming from the spacecraft is not precise enough to maintain FW synchronization (OSO to check s/c data), and
 2. FW electronics may have become sensitive to external stimuli (EMI, mechanical, solar event, etc). ITT and OSO to review the data from various sources (including SEM data with the folks from Boulder).
- Dr. Cao, HIRS Instrument Scientist at ORA, has seen some streaks in channel 1 and 2 data since we went back to nominal torque mode on the FW.

13 Jun 2000

On Tuesday June 13, 2000, an updated version of the CPIDS database will be placed into operations to implement the updates to the NOAA-K AMSU-B RFI (Bias Correction tables). The installation of the updated CPIDS will occur between 11:00 am and 12:00 noon (local time). The first orbits to be processed will be:
NSS.GHRR.NK.D00165.S1441.E1613.B1083537.GC and
NSS.HRPT.NK.D00165.S1615.E1626.B1083737.GC .
The scheduled ingest time for the HRPT orbit is 12:15 pm (local time) and the GHRR orbit is 12:40 pm (local time).

19 Jun 2000

Problems with the HIRS parallel test data were corrected over the weekend. Test data is updated on the CEMSCS and the ftp site. The implementation date is set for July 11, 2000.

28 Jun 2000

The clock corrections and constant attitude corrections were turned on beginning with the following orbits. Data has been placed on the anonymous ftp site.
NSS.HRPT.NK.D00180.S1858.E1912.B1105252.GC
NSS.GHRR.NK.D00180.S1711.E1857.B1105152.GC
NSS.LHRR.NK.D00180.S1758.E1806.B1105151.GC

29 June 2000

The clock correction starts with the following orbits. There were apparent parameter adjustments

that had to be made. Therefore start with these orbits: B1106767 GC., B1106667 GC.

Level 1B data users:

NOAA-15 - Header Record

Byte 339 - 340 Earth Location Bit Field

bits 15 - 2: <zero fill>

bit 1: reasonableness test: active (0 = inactive)

bit 0: attitude error: correction (0 = not corrected)

NOAA-15 - Data Record

GAC, HRPT/LAC, AMSU-A/B, HIRS/3

Word 13 and 14: bit 14: 1 = scan time corrected for clock drift

SEM/2

Word 17 and 18: bit 14: 1 = scan time corrected for clock drift

10 Jul 2000

At 12:15 pm local, SOCC switched the MIRS to utilize the internal sync instead of AVHRR sync delta. Problems with data for all instruments other than AVHRR should have cleared up after this change.

The HRPT transmission from NOAA-15 has been experiencing severe problems with signal synchronization since early on 10 July. NOAA is aware of the problems and is investigating the cause and any possible solution to restoring the HRPT service.

Update 1 at 1400 UTC:

First indications are that of a possible failure of the AVHRR instrument scan motor. Scanner problems will affect all AVHRR output, both HRPT and APT data transmissions. NOAA personnel are awaiting more information from telemetry when the satellite is again within view of the NOAA Command and Data Acquisition stations.

11 Jul 2000

The new Preprocessor Release 2.6 was implemented into operations on Tuesday July 11, 2000 . This release implements new executable programs for the following instruments in the AIP preprocessor (AMSU-A, AMSU-B, HIRS, SEM, DCS) and AVHRR (GAC, HRPT, LAC). The Level 1b* to 1bB converter will implement new executable programs for HIRS and AMSU-B.

The last orbits to be processed by NOAA-15 LAC B1123333 and NOAA-15 LAC B11234345.

10 Jul 2000

The ATOVS processing on NOAA-15 has been experiencing problems throughout today, 10 July. Data from 0400 UTC to the present has been affected. Some data was processed from 0400 UTC to 0730 UTC, but the data was unusable from 0730 UTC to 1618 UTC. The data were processed again but the data did not return to its nominal state.

The reduced ATOVS processing is associated with the problems with the AVHRR instrument. The scan motor for the AVHRR is severely degraded and the AVHRR instrument on NOAA-15

is not useful. Unfortunately for the other instruments, the AVHRR is the base instrument to which the others are synchronized; hence no data for the bulk of today. NESDIS is in the process of switching the synchronization from the AVHRR to internal sync so that we can process data from the other instruments.

12 Jul 2000

There was a JCL problem with the HIRS processing of the Level 1b data after our update on yesterday. The problem has been fixed. The following orbits were processed after the fix was made. Data from yesterday (day 193) will be reprocessed for archive purposes only and will not be transmitted (unless requested).

NSS.HIRX.NK.D00194.S1015.E1206.B1124647.WI

NSS.HIRX.NK.D00194.S0825.E1020.B1124546.WI

NSS.HIRX.NK.D00194.S0636.E0831.B1124445.WI

Reprocessed

NSS.HIRX.NK.D00193.S1540.E1724.B1123536.GC

NSS.HIRX.NK.D00194.S0313.E0459.B1124243.GC

NSS.HIRX.NK.D00194.S0454.E0641.B1124344.GC

12 Jul 2000

At 1700Z The AVHRR instrument was placed in the "AVHRR synchronization" mode. Initial passes (HRPT at this time) indicate data is of good quality and can be processed. Operations will continue to monitor passes to determine the quality of products in this mode.

21 Jul 2000

On July 24, a test will be conducted with the NOAA-15 HIRS. At 12:38Z, the HIRS filter wheel housing heater will be turned on for a duration of 48 hours. It is hoped that the filter wheel elevated temperature will draw additional lubricant into the bearing assembly. Product impacts should be expected for the first 12 hours or so after the heater turn-on as the filter wheel reaches a new steady-state operating temperature.

In addition, an on-board command macro is being validated for upload to NOAA-15 early in the week. This command macro, which is loaded directly to flight software, is designed to automatically trigger off elevated HIRS filter wheel current values (280 mA threshold) to command the filter wheel into High Power mode, thereby supplying 35% more current to the filter wheel motor. This action duplicates the current operational procedure during a pass, but extends the capability to 100% of the orbit.

On Thursday, July 27, the recorders will be configured for one day to record continuous AIP data along with GAC. The AIP data, which contains all spacecraft and instrument data aside from the AVHRR, is recorded independent of the MIRP. This operational test will be used to compare data quality between the two data streams to help evaluate MIRP/AVHRR impacts to other instrument data. The prime impact to the users due to this test is the loss of one day of LAC recordings from NOAA-15.

21 July 2000

An emergency release version 2.6.1 will be put into operations today Friday July 21, 2000. This emergency release implements a new executable program for the AIP preprocessor which will correct the AMSU-B anomaly documented as CCR 1583 . This is the anomaly associated with the AMSU-B bias earlier this year.

The first orbits to be processed by Release 2.6.1 will be NOAA-15 HRPT B1137878 scheduled to be ingested at 1:01 pm (local time) and NOAA-15 GHRR B1137677 scheduled to be ingested at 1:32 pm (local time).

25 Jul 2000

Since the Filter Wheel housing heater was turned on around noon local time on Monday the 24th, users have reported problems with the HIRS data. The heater was turned off and the dwell returned to the 28V bus during the 1712z pass this afternoon. We will monitor the data for improvements.

27 Jul 2000

The clock drift correction capability has not been turned on at this time. For NOAA-15, since we do not have the AVHRR to determine the accuracy of our updates and since our corrections for NOAA-15 do not agree with the values reported by SOCC, we are waiting on the recovery of the AVHRR before implementing this option or some other method of assuring the accuracy.

We look forward to beginning the parallel tests for NOAA-12 and -14 next week and turning on the corrections within two weeks of that date. The actual implementation data will be announced next week.

31 July 2000

The NOAA-15 AVHRR synchronization problem continues. In order to be able to perform troubleshooting and engineering observations without disrupting AMSU and other products, SOCC is proposing that we switch to using the stored AIP data (SAIP). This will give them the leeway to use the AVHRR sync delta, so that the AVHRR can be monitored.

We expect that users will not have a problem with the SAIP data. However, a test has been scheduled for Thursday, August 3, 2000, beginning around 00:00Z. We will produce SAIP data in parallel to the operational data. Also, whenever a SAIP orbit is not available, an AIP orbit will be substituted.

14 Aug 2000

Per SOCC, on August 17 at 01:15 Z until 23:17 Z SOCC will go operational with NOAA-15 SAIP. There will be no GAC or HRPT during this time. The STX2 (normally used for HRPT) will be off except for two dual transmissions over the CDA's. One at Wallops Rev 11759 AOS 11:57 Z and one at Fairbanks Rev 11762 AOS 16:53 Z. The AMSU may be adversely affected during these times.

The two week SAIP test previously scheduled to start on August 21 has been delayed for a week (possibly longer).

28 Aug 2000

Another test has been scheduled using the SAIP data. This is a result of the anomalies experienced with the NOAA-15 AVHRR instrument.

The list below contains the scheduled passes where SAIP and GAC datasets will be played to the ground. The list identifies the spacecraft, rev number, downlink site, maximum elevation, YYMMDD, and AOS (in GMT) for the playback pass.

15 12030 W 58.18 000905 130920
15 12033 F 73.04 000905 180550
15 12051 W 70.53 000907 000620
15 12065 W 71.89 000907 234350
15 12079 W 43.79 000908 232130
15 12087 W 46.83 000909 131920
15 12095 F 37.97 000910 023000
15 12104 F 63.12 000910 175250
15 12108 W 56.29 000911 001610
15 12118 F 48.14 000911 173020

05 Sep 2000

Due to transmission problems at the CDA station the scheduled pass of SAIP data NOAA-15 12030 for 13092 has been delayed. The pass scheduled for 180550 GMT will not occur. The next scheduled pass is: NOAA-15 12035 F 19.49 000905 212520.

13 Sep 2000

Starting September 12th and continuing on through September 17th, the MIRP on NOAA-15 will be configured back into synchronization with the AVHRR for up to two orbits each day. This will occur concurrently with an extra data recorder recording SAIP. The MIRP will then be re-configured back to internal synchronization just before the end of the SAIP record. The SAIP will be processed first and then the GAC. This mode will continue until the next scheduled "test rev" (at which time the MIRP/SAIP sequence will be repeated).

This test is being continued to allow engineering insight into the workings of the AVHRR during the back-orbit without comprising operational data from the other instruments on NOAA-15. If the GAC dataset has numerous "breaks in data" coming down from the spacecraft and the SAIP data set does not, do not be alarmed, as this is most likely caused by the AVHRR rephrasing.

Acquisition Orbit	CDA Station	YYMMDD	GAC End (HHMMSS)	HRPT Start (HHMMSS)	HRPT End (HHMMSS)
12136	W	000912	233120	233150	234550
12139	F	000913	044200	044350	045610
12152	F	000914	023950	024200	025340
12161	F	000914	180250	180430	181640

12165	W	000915	002620	002650	004050
12179	W	000916	000340	000410	001820
12193	W	000916	234110	234140	235550
12207	W	000917	231900	231930	233310

18 Oct 2000

The most recent NOAA-L CPIDS update version date D00292 will be placed into operations on Wednesday October 18, 2000 1:30 pm (local time) . The last orbits processed before the promotion will be

NSS.GHRR.NL.D00292.S1535.E1706.B0038485.WI ,
 NSS.HRPT.NL.D00292.S1707.E1720.B0038585.WI .

The first orbits to be processed after promotion will be

NSS.GHRR.NL.D00292.S1701.E1846.B0038586.WI
 and NSS.HRPT.NL.D00292.S1846.E1902.B0038686.WI .

Description of change:

Dr. Cao's message: "After working with Mike Chalfant on a few orbits of HIRS/NOAA-16 data, we found that the calibration coefficients for the visible channel that I sent to you previously has an error in it. This is because the previous coefficients were based on the assumption that delta counts instead of raw counts are used in converting to radiance. To correct this problem, the calibration Intercept for channel 20 (visible channel) in the CPIDS file should be changed to 51.4852 from the previous 0.53521. The slope remains the same. There are some other issues with the calibration coefficients for channel 20 as well, but for now, let's just correct this number first. Without this correction, the Level 1b data produces erroneous results including negative albedos."

27 Oct 2000

As has happened in the past, the NOAA-15 HIRS instrument is experiencing motor filter wheel problems. The process by which this is corrected (to bring the motor current down to normal) is to switch to high power mode. This has caused a problem with HIRS Ch7, the increased temperature (High Power mode) has caused the space view counts to go to saturation in the A/D 4095. Therefore, the data cannot be calibrated for this channel.

30 Oct 2000

On 30 Oct 2000, at 12:25 Eastern Daylight time the AVHRR instrument on NOAA-15 will go into the external synchronization mode for 6 minutes. The purpose is to capture a GAC database. If problems are encountered during this period then SOCC will switch back to the internal mode.

07 Nov 2000

The NOAA-15 HIRS instrument is still operating in the High Power Mode. This causes noisy operational data. At this time we are processing the HIRS data, but not using it to generate a product. The instrument also has the Filter Wheel Motor housing heater turned on (this is also a non operational mode). These modes are attempts to correct problems with the instrument. It has not been determined at this time how long these modes of operation will last. However, we are still providing the Level1b datasets. This is because within the Level1b data are appended earth

location and calibration information that is still needed by some users.

08 Nov 2000

On the morning of November 9, 2000, SOCC will perform a test that will involve cutting off the filter wheel motor on the NOAA-15 HIRS instrument for one second in an effort to demagnetize it.

09 Nov 2000

The toggle test of the NOAA-15 HIRS motor filter wheel has been planned for November 13, 2000. The exact time has not been determined.

22 Nov 2000

On November 28, 2000, the Information Processing Division (IPD) will discontinue the distribution of the NOAA-15 AVHRR Level 1b data. The current AVHRR data produced is not useable and will no longer be distributed to the general public. The Satellite Operations Control Center (SOCC) and other offices within the National Oceanic and Atmospheric Administration (NOAA) will continue efforts to identify and correct the problem. The user community will be notified when the AVHRR data is reliable and distribution will resume.

Problems with the AVHRR instrument began in July when the instrument demonstrated synchronization errors. Since the onboard processor normally uses the AVHRR to process all other instrument data, this problem rendered all data unusable. To restore good data for instruments other than AVHRR, the SOCC switched to using internal synchronization. The spacecraft will be operated in this mode until a correction to the AVHRR problem is found.

30 Nov 2000

The Information Processing Division has announced that no changes will be made to operational systems from December 15, 2000 through January 2, 2001. On December 12, the Pre-Product Processing group is planning to make several changes to the Level 1b process before the freeze begins. These changes should have no impact to the user community. The changes will make it possible for us to correct clock drift errors in the NOAA-16 AVHRR data and will correct effects of moon glint in the NOAA-15 AMSU-B data. A summary of the changes is provided below. Parallel testing will be conducted throughout the week of December 4th.

The KLM Level 1b preprocessing software will be updated to include AMSU-B moon glint anomaly corrections. Changes to the Level 1b format are not required. The user will find that previously unusable data will now be processed as normal. User impact - Increased data quality.

The NOAA-16 Calibration file will be updated to allow moon glint corrections for High Resolution Infrared Radiation Sounder (HIRS) data on that spacecraft. User impact - Increased data quality.

Both the KLM and A-J Level 1b preprocessing systems will be updated to allow scan geometry parameters to be changed to user supplied parameters. This will give us the ability to adjust the scan geometry differently for different satellites. User impact - improved earth location data due to use of double precision variables. New MSU scan angle ± 47.3685 degrees

(difference in latitude of 0.01 degrees, longitude 0.03 degrees); AVHRR new stepping angle 0.05407226563 degrees for all satellites except NOAA-16 which will be 0.053955078 degrees; AMSU-A - maximum difference in latitude of 0.005 and longitude of 0.0001; AMSU-B - maximum difference in latitude of 0.0001 and longitude of 0.0001.

The clock drift corrections for the NOAA-16 spacecraft will be turned on to correct the along track error. User impact - improved earth location data removing clock error of about 650 milliseconds (about 4 kilometers).

08 Dec 2000

Pre-Product Processing staff and users have detected several inconsistencies in the parallel test data for the NOAA-16 HIRS, AMSU-B, and HRPT data. Those problems have been identified and corrected where needed. The parallel test data is now the same as the operational data except for the changes that we noted in our initial change notice. Because these problems have made it difficult for you to verify that the test data meets your needs, we are changing the scheduled implementation date to December 14 rather than December 12. We are making every effort to implement the changes before our mandatory freeze period is reached (from December 15 through January 6, no changes are allowed to operational software or hardware).

Below is an explanation of the corrections that had to be made to the parallel tests and information on why you see some differences or errors not seen in the NOAA-15 data.

In the parallel test, the NOAA-15 HIRS calibration was different from the operations because the 24-hour file was not updated for the data provided before day 341. That has been corrected now.

The HIRS Level 1b for NOAA-16 is reflecting calibration problems that will be corrected as soon as we change the algorithm that updates our 24-hour file. Since NOAA-16 is not operational this can be done over the freeze period without impacting other satellites. The permanent fix will be implemented as soon as possible after the freeze is lifted.

Clock corrections for NOAA-16 are turned on in the test data, but we are seeing adjustments of ± 500 ms in the clock error that last for several days. We are adjusting for the change once it is detected. Depending on which set of data you examine you will see descending passes with a very small along track error or an error of about 500 ms. Both of these errors are significantly smaller than the error without clock corrections turned on as seen in the operations data.

We believe that the small differences you see in the NOAA-16 AMSU-B are due to a change to correct for moon glint. The instrument scientist felt that the correction should be incorporated in with other similar anomalous corrections and should be flagged under the existing indicators as shown below. The quality of the data will determine if differences other than moon glint will show up (this will effect calibration).

Existing Level 1b indicators:

QUALITY INDICATORS

Calibration Quality Flags (all bits off implies a good calibration)

Bits set per channel

bit 4: All bad space view counts for scan line
bit 1: Marginal space view counts for this line

Existing Level 1b* indicators:

CALIB_CHAN_PROBLEM_INDICATOR

array item 2: no good space view counts for scan line

array item 5: Some bad space view counts for scan line

13 Dec 2000

The preprocessor release 2.7 will be implemented into operations on December 14, 2000 between the hours 11:05 am and 12:15 pm local time. The following items will be put into operations:

(1) New earth location software changes for all instruments which will support all spacecraft (NOAA-15, NOAA-16, NOAA-14, NOAA-12).

(2) NOAA-16 CPIDS - insert RFI values, and moonlight offset for HIRS channel 19.

The first orbits to be processed for NOAA-16 will be

NSS.HRPT.NL.D00349.S1726.E1741.B0118989.WI ingest time 12:26 pm local and

NSS.GHRR.NL.D00349.S1415.E1610.B0118788.WI ingest time 12:46 pm local .

The first orbits to be processed for NOAA-15 will be

NSS.HRPT.NK.D00349.S1849.E1903.B1345656.GC ingest time 1:49 pm local and

NSS.GHRR.NK.D00349.S1346.E1542.B1345354.GC ingest time 2:16 pm local.

The first pass after the update

NSS.GHRR.ND.D00249.S1420.E1544.B4979091.GC

NSS.HRPT.NJ.D00349.S1633.E1647.B3070808.GC

02 Jan 2001

The Computer Operations Branch will coordinate the reprocessing of the day 001 data that was bad. The data will be processed as time allows between current data processing. This will be done overnight as much as possible.

05 Jan 2001

Normal post launch operations schedules indicate that the NOAA-16 Level 1b data should be declared operational three months after launch (January 8, 2001). The Information Processing Division has an outstanding High-resolution Infrared Sounder (HIRS) calibration issue that will not be resolved by this date. Current plans indicate that an operations date of February 20, 2001 should provide adequate time to implement the necessary changes to correct the identified calibration problem. Official notification will be sent out as soon as a decision has been made.

19 Jan 2001

On January 24, 2001, NOAA-16 Level 1b data will be declared operational for the following instruments:

AMSU-A

AMSU-B

SEM
DCS

30 Jan 2001

MEMORANDUM FOR: All NOAA-16 Level 1b Data Users

FROM: Barbara Banks
Chief, Information Processing Division

SUBJECT: Operational Status of NOAA-16 Level 1b Data

On January 24, the Information Processing Division declared the following Level 1b and 1b* data operational. These data are available to the user community:

- AMSU-A Advanced Microwave Sounding Unit-A
- AMSU-B Advanced Microwave Sounding Unit-B
- SEM Space Environment Monitor
- DCS Data Collection System
- SAR Search and Rescue
- SBUV Solar Backscatter Ultraviolet Spectrometer

Anomalies seen in the Advanced Very High Resolution Radiometer (AVHRR) Level 1b data, the High Resolution Infrared Radiometer (HIRS) Level 1b, and SBUV data are significant enough to delay the operational status of these instruments. National Environmental Satellite, Data, and Information Service(Satellite Operations Control Center (SOCC), Office of Research Applications scientists, Information Processing Division), National Aeronautics and Space Administration, and Lockheed, are working together to resolve the remaining issues as quickly as possible. The user community will be notified when the AVHRR and HIRS Level 1b and 1b* data are deemed reliable and declared operational.

13 Feb 2001

On February 15, the following changes will be implemented:

NOAA-16 HIRS earth locations will be corrected by applying a constant attitude correction to adjust for the across track error. A correction of -1.8 degrees (error of +1.8 degrees) will be used as a constant roll offset.

A NOAA-16 HIRS CPIDS file will be updated to change the minimum number of space FOVs needed to calculate space coefficients from 45 to 40 to correct the problem where channels 17, 18, and 19 are periodically not calibrated.

The software to update the 24-hour calibration coefficients file header will be modified to use a different algorithm to compute the variance of the calibration slopes. The current algorithm uses a shortcut version of the variance formula which is producing negative variances for NOAA-16 and therefore preventing the automatic update of the slopes used for the Level 1b HIRS earth view data. This algorithm change will effect both NOAA-15 and 16 HIRS calibration. On February 15, the algorithm change will be made for NOAA-16 so that the 24-hour file will begin

updating automatically. The change will be made for NOAA-15 on February 21. Parallel testing is on going.

Changes on February 15 will be made between 10:30 am and 11:45 am local time. The updates will be made after the following passes have been processed.

NSS.HRPT.NL.D01046.S1516.E1530.B0207676.GC

NSS.GHRR.NL.D01046.S1330.E1515.B0207576.GC

The first orbits processed after the update will be:

NSS.HRPT.NL.D01046.S1644.E1653.B0207777.WI

NSS.GHRR.NL.D01046.S1510.E1642.B0207677.WI

The following passes will be received out of sequence and will be affected by the change

NSS.GHRR.NL.D01046.S1148.E1336.B0207475.GC

NSS.LHRR.NL.D01046.S1300.E1311.B0207475.GC

On February 21, the following changes will be implemented:

- The algorithm used to update the NOAA-15 HIRS 24-hour calibration file will be changed so that updates will happen more readily.

- The preprocessing software will be updated to correct an error in the attitude algorithm that affects pitch angle adjustments to the earth location data. This will be a no impact change.

- The along track and across track errors seen in the NOAA-16 instrument data will be corrected by adjusting the earth location data with a pitch attitude correction of -0.44 degrees (along track), by using the SOCC reported clock error (along track), and by using a max scan angle of ± 55.25 degrees instead of ± 55.37 degrees (across track).

- The preprocessing software will be updated to properly extract the AVHRR dig-B and analog telemetry data for NOAA-16.

20 Feb 2001

Previously announced updates to the NOAA-KLM preprocessor (Level 1b process) will be made on February 21, between 12:30pm and 1:30 pm local time. The first orbits processed after the change are listed below. This update includes a switch to the NOAA-15 HIRS 24-hour calibration file processing that will improve the frequency of the updates. The NOAA-16 AVHRR processing will be updated to account for a pitch error rather than treating the along track error as a clock error. This includes a software change. All changes should have no adverse impact on the data nor should they require changes by the user community.

NOAA-15

NSS.GHRR.NK.D01052.S1559.E1754.B1443637.GC

NSS.HRPT.NK.D01052.S1926.E1940.B1443838.GC

NOAA-16

NSS.GHRR.NL.D01052.S1713.E1859.B0216163.WI

NSS.HRPT.NL.D01052.S1900.E1914.B0216363.WI

27 Feb 2001

We discovered that when the updates were made to the NOAA-16 operation on February 21, the attitude corrections along track were not turned on for the AIP instruments. This was corrected beginning with the following pass:

NSS.AIPX.NL.D01057.S2316.E0104.B0223637.GC

An official memo declaring all Level 1b data for NOAA-16 operational is forthcoming.

15 March 2001

Plans are to implement changes to NOAA-15 on March 22, 2001. These will include yaw error correction (+0.3 degrees) and clock correction (+584 milliseconds). This will also include an RFI bias update to the AMSU-B instrument that impacts as follows:

Channels 16, 17 and 18: No changes made

Channel 19: Substantial changes in the pixel 50-90 side of the swath. Up to 3.5K. Brightness temperatures had become too high on this side of the swath.

Channel 20: Changes of up to ∇ 0.8K.

Channel 19 has seen larger than normal drifts during December 2000 and January 2001. However, these appeared to stabilize during February. As in the past, it is the SARR interference that has shown the largest changes; STX-2 has been quite stable, though a minor update to the STX-2 RFI tables have been made.

16 Apr 2001

On April 17, 2001, the following update will go into operation for NOAA-16 Level 1b:

We will switch the Level 1b process to correct the along track error using a +1 second in addition to the normal clock error. The user will see changes in the earth location data that will improve the quality with the clock correction offset reflecting a different range from current. Also, the attitude correction information will become zero with the constant attitude correction flag set to zero in the header record.

The change will be made between the hours of 11:00am and 12:30 pm local. The last passes processed before the change will be:

NSS.LHRR.NL.D01107.S0919.E0926.B0293333.GC

NSS.HRPT.NL.D01107.S1447.E1502.B0293636.GC

NSS.GHRR.NL.D01107.S1300.E1447.B0293536.GC

All data with time periods after the above passes will be processed using the changes.

16 Apr 2001

At 16:00 Z SOCC turned off the Aydin Frame Synchronizers and put the GDP Space Systems' Frame Synchronizers in their place. The GDP Frame Synchs were turned on at 16:35Z and the first data received:

from Wallops CDA was a delayed STIP:

NSS.TIPS.NH.D01106.S0809.E1200.B6476567.WI |

and from Fairbanks CDA:
NSS.HRPT.NL.D01106.S1639.E1651.B0292323.GC |

The following data were also delayed and will be ingested using the GDP Frame Synchs:

NSS.GHRR.NK.D01106.S1359.E1540.B1520304.GC |
NSS.LHRR.NJ.D01106.S1256.E1306.B3244242.GC |

(The N-14 LAC appears to be noisy from the CDA.)

30 Apr 2001

Users reported problems processing the NOAA-15 and -16 HRPT and LAC data. The problem was traced to fill data that was not zero filled. Sensor data word 3414 and spare word 3415 (bytes 14919 - 14924) contain spare bits that are not zero filled as specified in the Level 1b format. The problem was corrected in the preprocessor software. No other Level 1b data is affected by the change. This is considered a no impact change and we plan to put the change into operations on tomorrow, May 1, 2001 between the hours of 10am and 11:45am local time.

The first orbits to be processed after the change are:
NSS.HRPT.NL.D01121.S1543.E1555.B0313434.GC
NSS.GHRR.NL.D01121.S1215.E1410.B0313233.GC
NSS.LHRR.NL.D01121.S1346.E1351.B0313333.GC

NSS.HRPT.NK.D01121.S1639.E1651.D1541818.GC
NSS.GHRR.NK.D01121.S1317.E1512.B1541617.GC

17 May 2001

Below is updated information on the status of the current Level 1b data with anomalies and plans for updates.

NOAA-16

We are no longer using the pitch correction for NOAA-16 instrument data. Instead, we are using a timing correction of 1 second for all instruments to fix the along track error along with the normal SOCC clock drift correction. For Example: On May 16 at 0000Z the clock error determined was +862 milliseconds (ms) (+1 sec for along track error and -138 ms SOCC clock drift error).

The across track error seen in the AVHRR data is corrected by using a scan angle of ± 55.25 degrees (stepping angle of 0.05398143624 degrees instead of the normal ± 55.37 (stepping angle 0.05409868099 degrees).

The across track error seen in the HIRS data is believed to be a mirror misalignment. To properly earth locate the data we are correcting for a roll error +1.8 degrees. Any user wishing to collocate the corrected HIRS data with other instruments must realign the spots to match the other instruments unless they are using lat/lons to collocate.

NOAA-15

The AVHRR is still having problems and is not providing reliable data. When the data is good, we are correcting earth locations for clock drift errors as well as correcting for a yaw error of +0.2 degrees.

PLANS FOR UPDATES WITHIN THE NEXT 4 MONTHS

- 1.) Correct the NOAA-16 AVHRR PRT values. (User impact to be determined) We are currently using NOAA-15 PRT values for NOAA-16 and will change them to the appropriate values as identified by the instrument scientist.

- 2.) Correct calibration for first scan line of HIRS pass. (No impact to users) Sometime since the NOAA-16 AIP processing became operational, it was noticed that the intercept in the first scan in the HIRS NOAA-15/16 1b*/1b was incorrect. The problem caused the temperatures in the first scan line to be wrong and appear as a distinct anomaly in the images generated from the HIRS data. Complicating the problem was the erroneous setting of a time sequence error flag. Analysis revealed that the time sequence flag started being set when clock corrections were turned on to correct an along track error. It was discovered that the flag was being inadvertently set because the initial expected time used for comparing successive scans was not a corrected time. This error was corrected and rather than concentrate on a time sequence problem, personnel began examining the HIRS calibration. After much examination of the entire calibration process, an anomaly was discovered in the part of the secondary mirror interpolation scheme which uses a polynomial algorithm to convert counts to secondary mirror temperatures. The interpolation algorithm assumes that three temperatures exist; a previous, a current and a subsequent mirror temperature. At the beginning of an orbit there are usually missing scans and very rarely a complete swath. Consequently one or two of the counts were missing and were assigned a value of zero. The algorithm that converts from counts to temperature was bypassing code based on the count being a missing value (not zero). The algorithm was executed in some cases where some of the counts were 0 causing erroneous secondary mirror temperatures.

- 3.) NOAA-M updates
 - a.) Change HIRS calibration method for first 24 hours after launch so that raw coefficients are produced instead of using a previous satellite's data - no impact to user.
 - b.) Update the HIRS encoder position table to correct the slew values for NOAA-16 and make it easy to change the values per satellite. - no impact to user
 - c.) Put the HIRS 63rd element header in the right position and assign the HIRS scan quality flags after the 63rd element is properly aligned. - possible user impact

- 4.) Change NOAA-15/16 preprocessor to correctly select the primary CPU - no impact to user

OTHER ANOMALIES NOTED:

Recent problem seen in AMSU-B data related to moon glint correction: Under the current algorithm for detecting moon in the space view, we noticed that during the peak of the moon occurrence that three out of the four space view samples per scan are showing moon glint contamination. When this occurs for more than four continuous scans, no calibration

coefficients are computed for that channel. Channel 16 is affected the most, 17 to a lesser extent, and we haven't noticed a loss of data in 18, 19, or 20. We've noted that space view (spot) 1 of the 4 appears unaffected as compared to scans of surrounding good data during this anomaly. We are open to suggestions for possible fixes. One possibility could be to use scan spot 1 when the other 3 are out of tolerance. The anomaly must be investigated further. One example of the anomaly was seen in the NOAA-16 orbit 0313839, scans 1325 (23:13:09Z) through 1334 (23:13:33Z), JDAY 121.

21 May 2001

There is a problem with the spare bytes that should be zero filled (bytes 14921 - 14924) in the LAC and HRPT Level 1b data for NOAA-15 and -16. Also, the fill bits for word 3414 of the AVHRR sensor data in each record are not set to 00 as they should. This is under investigation and as soon as a correction is made to the software, an update will be announced to properly zero fill the data.

25 May 2001

NOAA-16/15 HIRS:

The following software update to the AIP preprocessor will be implemented on May 31, 2001 to correct the calibration for the first scan line of the HIRS passes. This update has been tested internally and no differences in the data were detected when compared to the operational Level 1bs. This should be a no impact change to the user community. Below is a more detailed explanation of why the update is needed. If you need to look at test data, please use only the AIP (HIRS, AMSU-A, and AMSU-B) Level 1b and 1b* data found on the CEMSCS (P1b and P1S) and the same data from the anonymous ftp site ([psbgs11.nesdis.noaa.gov](ftp://psbgs11.nesdis.noaa.gov) under subdirectory `pub/test1b/NOAA15` and `NOAA16`). The AVHRR data contains preliminary corrections for the PRT conversion coefficients and visible calibration coefficients.

NOAA-16 AVHRR PRTs and VISIBLE Calibration Coefficients: Problems with the PRT conversion coefficients was mentioned in the notice outlining our plans over the next four months. Since then, we have discovered that the visible coefficients for NOAA-16 must be updated. We are conducting preliminary tests of the AVHRR Level 1b and 1b* data containing these updates. The test data are on the above sites, however, this data has not been verified by the instrument scientist and should not be considered final. Once internal testing is complete and the instrument scientist has completed the data verification, a notice will be sent out to the user community. We believe the changes will have a minimal impact and a week of testing will be sufficient for all users.

Details on the correct calibration for first scan line of HIRS pass: Sometime since the NOAA-16 AIP processing became operational, it was noticed that the intercept in the first scan in the HIRS NOAA-15/16 1b*/1b was incorrect. The problem caused the temperatures in the first scan line to be wrong and appear as a distinct anomaly in the images generated from the HIRS data.

Complicating the problem was the erroneous setting of a time sequence error flag. Analysis revealed that the time sequence flag started being set when clock corrections were turned on to correct an along track error. It was discovered that the flag was being inadvertently set because the initial expected time used for comparing successive scans was not a corrected time. This error was corrected and rather than concentrate on a time sequence problem, personnel began

examining the HIRS calibration. After much examination of the entire calibration process, an anomaly was discovered in the part of the secondary mirror interpolation scheme which uses a polynomial algorithm to convert counts to secondary mirror temperatures. The interpolation algorithm assumes that three temperatures exist; a previous, a current and a subsequent mirror temperature. At the beginning of an orbit there are usually missing scans and very rarely a complete superswath. Consequently one or two of the counts were missing and were assigned a value of zero. The algorithm that converts from counts to temperature was bypassing code based on the count being a missing value (not zero). The algorithm was executed in some cases where some of the counts were 0 causing erroneous secondary mirror temperatures.

30 May 2001

On May 31, 2001, we will implement a correction to the HIRS Level 1b data. When clock error corrections are turned on the first scan line is inadvertently flagged as having a time sequence error. Also, this scan line has an incorrect calibration parameter causing erroneous brightness temperatures. These problems will be corrected with the changes on May 31. The change will not affect the user community other than improving the Level 1b data. The updates will be effective beginning with the following orbits.

NOAA-16 -- NSS.HIRX.NL.D011151.S1344.E1531.B0355657.GC
NOAA-15 -- NSS.HIRX.NK.D011151.S1712.E1836.B1584546.GC

07 Jun 2001

On June 5, 2001, at 235900Z, the Satellite Operations Control Center (SOCC) updated the NOAA-15 elapsed time clock to correct for the clock drift. The SOCC correction was performed with no problems. However, the preprocessing clock drift file was not updated properly. The NOAA-15 clock error or along track error seen in images from the Advanced Very High Resolution Radiometer (AVHRR) normally does not agree with the clock drift error reported by SOCC. As a result, the preprocessor file must be updated according to corrections that agree with the AVHRR observed error rather than the SOCC reported error. For this particular update, the SOCC correction was used introducing an error in the Level 1b data of approximately a second for all passes processed for day 157 from 0000Z through the passes below. This error affected all NOAA-15 instrument Level 1b earth location data and time codes.

NSS.GHRR.NK.D01157.S1754.E1939.B1593132.GC
NSS.HRPT.NK.D01157.S1940.E1953.B1593232.GC

28 Jun 2001

Below is an update received from the Satellite Operations Control Center relating the current status of the NOAA-15 HIRS instrument:

SATOPS MORNING REPORT June 28, 2001

NOAA-15 rev 16229 / F at 1645Z: Multiple HIRS Flags. The NOAA-15 HIRS filter wheel motor appears to be acting up again. There was a current spike up to ~300 mA at ~1310z and associated period monitor activity and loss of synchronization. Things settled down (although not to pre-1300z Levels) until ~1435z when another, wider, current spike (again ~300 mA) occurred, again with loss of sync and period monitor response. As a result of the erratic

behavior, the HIRS filter motor heater was turned on yesterday at ~1825z (rev 16230). The temperature and current rose for ~45 minutes, when the temperature leveled out, and the current dropped somewhat, but was still noisy and erratic. The current rose slightly again at ~2315z, but both the current and temperature began to fall (~linearly) at ~0100z. At ~0330z, the current began jumping between 2 Levels (~260 mA - ~280 mA), a signature seen last summer. Also at 0330z, the period monitor and sync began to settle out. The latest data shows the current reasonably steady at ~260mA, but noisier than prior to this latest anomaly. The period monitor is varying ~ $\sqrt{3}$ counts, and the filter wheel seems to be in sync. The plan is to monitor the telemetry for the rest of the day and to turn the filter motor heater off tomorrow morning if things continue to improve (or remain in their present state). The telemetry will be monitored tomorrow and through the weekend, with the heater 'on' kept as a contingency procedure.

19 Jul 2001

On July 31, 2001, the Information Processing Division plans to update the NOAA-16 PRT Conversion Coefficients (IR Target Temperature Coefficients - as identified in the NOAA-KLM Users Guide). Jerry Sullivan, Office of Research and Analysis, provided a brief explanation of the problem and the impact on the user that is inserted below for your information. Also, below is a table showing all changes.

Test data is provided for CEMSCS users in datasets named P1S and P1b.*.NL, where "*" is the instrument (LHRR, HRPT, GHRR, AMAX, AMBX, HIRX, ...). For other users, subsets of the data will be provided daily on psbsgi1.nesdis.noaa.gov anonymous ftp site ([pub/test1b/NOAA16](ftp://pub/test1b/NOAA16)). You will need to change to a new file as indicated below.

THE PROBLEM:

To calibrate the thermal channels on any AVHRR, the temperature of the internal blackbody must be known. There are four Platinum Resistance Thermometers (PRTs) imbedded in the blackbody that measure its temperature. NESDIS calculates the blackbody temperature as the average of these four PRT temperatures. The PRTs actually send a count value back to the ground station, so coefficients to convert each PRT count value to temperature are supplied by ITT, the instrument manufacturer. For AVHRRs in the KLM series, the coefficients are different for each PRT. These coefficients must be put into the NESDIS operational computer code that calculates internal blackbody temperature as the first step in computing calibration coefficients. For the NOAA-16 AVHRR, the wrong coefficients were put into the computer code; the NOAA-15 coefficients were put in by mistake.

THE IMPACT of the CHANGE on DATA USERS:

Brightness temperatures were calculated for the same 1,000,000 earth scene pixels in the test dataset in two ways: Using the correct NOAA-16 PRT coefficients and using the wrong ones (current operational values). The conclusions were:

Using GAC test data:

1. The difference between brightness temperatures (equivalent blackbody temperatures) generated by using the correct NOAA-16 PRT coefficients and the incorrect NOAA-15 coefficients was nearly constant for all three channels, 3B, 4, and 5,
2. the difference depends on the Earth scene temperature,
3. the difference was a bias, not a random difference; the temperatures produced from the

correct coefficients are always lower.

The root-mean-square (RMS) differences between temperatures produced from the correct coefficients and temperatures produced from the incorrect coefficients, tabulated as a function of scene temperature are:

Table G.1-3 RMS Differences between temperature coefficients and temperatures produced from the incorrect coefficients	
Scene temperature	RMS temperature differences
215 K	0.04 K
240 K	0.05 K
275 K	0.06 K
295 K	0.07 K
320 K	0.09 K

CHANGES:

The changes to the NOAA-16 PRT Conversion Coefficients 4, 5 and 6 scaling factors resulted in the creation of version 02 of the GAC and HRPT Level 1b structure files (no change to the 1b* structure file). The new structure files are located in:

DEV.PDP.CM.CONVERT.STRUCTUR(GA1bSF02)

DEV.PDP.CM.CONVERT.STRUCTUR(HRPT1b02)

The PRT conversion coefficients are listed in the Level 1b Header beginning with byte 201 through byte 248.

30 Jul 2001

Users have reported anomalies when using the test GAC data, especially for the visible channels. We are delaying the update scheduled for July 31 until further notice to resolve these anomalies. This served as a reminder to us that we did not include information on the visible calibration update that is also included in the current test data. Below are the new values as provided by the instrument scientist.

NOAA-16 AVHRR A301 visible channel calibration

Table G.1-4 New NOAA-16 AVHRR A301 Visible Channel Calibration Coefficients				
Channel #	Contents	Slope	Intercept	Breakpoint
1	0- 25% albedo	0.0523	-2.016	497.5
	25-100% albedo	0.1528	-51.91	497.5
2	0 -25% albedo	0.0513	-1.943	500.3
	25-100% albedo	0.1510	.-51.77	500.3
3A	0 -12.5% albedo	0.0287	-2.043	498.7
	12.5-100% albedo	0.1806	-78.03	498.7

02 Aug 2001

The Satellite Operations Control Center discovered a problem that apparently resulted in the introduction of a 900 millisecond timing error for both NOAA-15 and 16. This will account for the constant along track error that is currently corrected at the user Level. Excerpts from Peter Phillips message are provided below to fill you in on some of the details. On August 7, SOCC plans to correct the error and perform a clock update to remove the 900 milliseconds. At that time we will update our clock drift file to remove the 1 second corrections that we have been applying to the NOAA-15 and 16 data. Direct readout users that are correcting their data should do the same. As soon as the expected error parameters are received from SOCC, a new clock drift file will be placed on our web site to reflect the change.

Message dated July 26, 2001 from Peter Phillips:

"In preparation for ordering new frame synchs for the CDAs, yesterday we started reviewing the present frame synch settings for all data types. We came across a very interesting discrepancy when we compared the blocking factor settings for real-time TIP data. For ATN satellites, PACS sets up the frame synch to collect 5 frames of data before passing the data over the HDLC interface to the Comm Controller. For KLM satellites, PACS sets up the frame synch to collect 11 frames.

This difference in these settings is significant because Ground Receive Time (GRT) is not stamped on the TIP frames until they arrive at the CDA Comm Controller. GRT is used in the calculation of the spacecraft clock error, which is the difference between TIP Time and GRT. ... When calculating the clock error, PACS adds a correction factor to the TIP Time (same as subtracting from GRT) to account for the delay. This correction factor is a constant value of 400 milliseconds that does not vary whether the data is KLM or ATN.

Based on the relatively good correlation between SOCC and CEMSCS estimates of the spacecraft clock error for ATN satellites, this correction factor appears reasonable for the ATN blocking factor setting of 5 frames. However, this correction factor is not adequate for the KLM setting of 11 frames. Based on frame synch tests performed at SOCC in 1999, a delay of 150 milliseconds is introduced for every additional frame of data that is collected in the frame synch. Therefore, collecting an additional 6 frames will lead to an additional delay in stamping GRT of approximately 900 milliseconds. This will cause the SOCC reported spacecraft clock error to be 900 milliseconds less than the true value for KLM spacecraft. Because the spacecraft clock error is used as the basis for setting the spacecraft clock, the net effect of this discrepancy will be that the spacecraft clock will be set 900 milliseconds AHEAD of the true value.

This, in turn, would cause the AVHRR imagery to appear to be lagging the calculated spacecraft position by nearly 1 second, which is the problem users have seen on KLM spacecraft.

SOCC engineers and operators confirmed this phenomenon today on a NOAA-15 pass at Fairbanks. As expected, PACS set up the frame synch to buffer 11 frames of data. The reported TIP clock error was -200 milliseconds. Midway through the pass, the operators changed the buffer setting to 5. The reported TIP clock error changed to +700 milliseconds. The operators then returned the buffer setting to 11, and the reported TIP clock error returned to -200 milliseconds. These results indicate that the "true" clock error on NOAA-15 is approximately

+700 milliseconds, not -200 milliseconds as we have been reporting up to this point. SOCC engineers will perform a similar test on NOAA-16 Friday morning to ensure the results are consistent for all operational KLM spacecraft. If they are consistent, PACS software can be corrected through a PIR to change the frame synch blocking factor setting to 5 frames for KLM TIP data, and the spacecraft clocks can be corrected by -900 milliseconds--or whatever amount is necessary to bring the "true" error to zero--in a coordinated manner between the SOCC engineers and user community."

07 Aug 2001

Following is the bulletin issued by SOCC announcing their intentions to correct the NOAA-15 and 16 elapsed time clocks. The Information Processing Division will update the Level 1b preprocessor replacing our current adjustments at the same time. The Level 1b user should not be impacted by the update. Direct readout data users should update their systems accordingly.

"Due to a configuration error in ground equipment, the TIP clock errors that are being reported for NOAA-15 and NOAA-16 have been determined to be inaccurate by >900 milliseconds, i.e. actual clock errors are 900 milliseconds greater than the values being reported. The NOAA-15 TIP clock is now reading 100 milliseconds and the NOAA-16 TIP clock is reading +100 milliseconds. The actual errors are: NOAA-15 = +800 milliseconds, NOAA-16 = +1000 milliseconds. It is necessary to subtract 1.0 second from both spacecraft clocks to correct this error. These corrections will take place on August 7th, 2001 via SCT at 23:59:00Z for the control OBPs. The standby OBPs will be updated via real time command (in the schedules).

30 Aug 2001

NOAA-10 was deactivated today, August 30, 2001, at 0951Z after continued problems indicated that the useful life of the spacecraft was over. It was launched on September 17, 1986. It began operations on November 17, 1986 and remained operational for 1763 days. At the time of its deactivation it had completed 77741 orbits around the earth. It was the last of the E-F-G series of Advanced TIROS-N spacecraft.

12 Sep 2001

The PRT Conversion Coefficients and scaling factor change will be done today as scheduled.

The first orbits to be processed after the update are:

NSS.GHRR.NL.D01255.S1221.E1416.B0502223.WI

NSS.HRPT.NL.D01255.S1715.E1727.B0502525.WI

14 Sep 2001

Following is information received this week relating to activities or anomalies that may affect NOAA-14 and -15 products.

NOAA-15 AVHRR continues to function erratically. As of September 12, examination of the last 24 hours of trending data indicated that approximately half of the orbits processed were nominal. Also, over the past 2 to 3 weeks channel 4 and 5 have demonstrated erratic behavior where most of the data is affected. This problem is apparently not attributed to the "normal" sync delta or scan motor problems. Investigations continue.

Information reported by SOCC

NOAA-14 AVHRR Testing: A 24-hour test to reduce the amount of overlap in the NOAA-14 orbital data will be conducted on all GAC data recorded starting at 0000Z on Wednesday, September 19. The objective of the test is to try to reduce the age of the oldest data on the recorders without affecting any products. On September 10 at 0513Z, the NOAA-14 spacecraft attitude control mode was switched from nominal mode to Yaw Gyro Compassing (YGC) attitude control mode. An analysis of the data leading up to the switch indicates the sun sensor's field of view was obstructed (probably by the solar array) as it was attempting to take a reading. NOAA-14 has entered a period of time where, over the next several months, it's experiencing spacecraft sun angles lower than any previously encountered by NOAA-14 on-orbit. This is not unusual for older spacecraft whose orbits have precessed.

Since the environmental conditions believed to have caused this problem are expected to continue for several months, SOCC engineers decided to leave NOAA-14's attitude control mode in the YGC mode. The YGC attitude control mode typically has no impact on data products.

Then, at 0125Z on J253, redundancy software on NOAA-14 switched buses from the B-bus to the A-bus and then inhibited further bus switching. The cause of this bus switch is still under investigation. Aside from the loss of bus redundancy (because further bus switching is inhibited), there was no impact to the mission capability of the spacecraft. No NOAA-14 data was lost as a result of these events.

Reported on September 11: NOAA-14 YGC and bus switch investigations continue. The most likely reason for the switching of the control mode and buses is due to apparent shading of the sun sensor by the solar array. Among other actions, engineers are considering an array movement that would give the sun sensor a clear view of the sun.

On September 13, NOAA-14 rev 34563 / F at 1731z : Commanding performed to increase the telemetry time resolution of the sun sensor read output from 8 seconds to 1 second. Executed commands to change the telemetry table 1, word 13, in the control OBP. The result of the commanding was to increase the telemetry time resolution of the sun sensor read output from 8 seconds to 1 second. Other spacecraft systems remain unchanged. Now that the telemetry sampling rate of the Sun Sensor Assembly (SSA) has occurred, engineers plan to change the solar array bias from -55 degrees to -20 degrees while continuing to monitor the SSA's output during the update window. If test results are positive, engineers will (after a suitable time period) return the spacecraft to the B-bus and re-enable bus switching in redundancy management software. For the time being, the spacecraft will remain in the YGC attitude control mode. Aside from the loss of bus redundancy (because further bus switching is inhibited), there is no impact to the mission capability of the spacecraft.

Important note to all involved in N14 product generation: As described above, the N14 array will be moved on Monday, September 17 at approximately 1400z. Short term temperature variations should be expected as the spacecraft achieves a new thermal balance due to the resultant change in bus and instrument shading.

18 Sep 2001

NOAA-14 Solar Array Move Update: The array move for N-14 has been delayed one day. It is now scheduled for Orbit 34618 at 1502 Z (11:02 am local) on J261 (18 September 01).

19 Sep 2001

NOAA-14 Update: The NOAA-14 array move occurred successfully on September 18, 2001, rev 34632 / F at 1451z. The sun sensor is now unshaded. Short term temperature variations have been observed as the spacecraft achieved a new thermal balance due to the resultant change in bus and instrument shading. As of this morning, the spacecraft thermal environment has stabilized and all temperatures look nominal for the new configuration. The plan for September 19 is to restore the spacecraft bus from bus A to bus B at 1800z. After additional on-orbit performance is analyzed, the final step of this recovery process will be to restore the attitude control mode from Yaw Gyro Compassing (YGC) mode to Nominal mode.

24 Sep 2001

On September 21, NOAA-14 was successfully commanded back to Nominal ADACS control mode on rev 34676 / Fairbanks at 1740z . The NOAA-14 ADACS subsystem was placed in YGC control mode since September 8, 2001 due to blockage of the sun sensor field of view by the solar array. The skew gyro was also selected to replace the X (yaw) gyro at the same time due to the bad yaw updates from the blocked sun sensor. The sun sensor blockage has been eliminated by the reduction of solar array offset that was performed on September 18, 2001. Hence, it was possible to return the ADACS subsystem to the NOMINAL control mode and to reselect the orthogonal set of gyros.

01 Oct 2001

Beginning on the evening of September 29 through the afternoon of October 1, the earth locations created for the NOAA-16 Level 1b/1b* contained an error of approximately 15 kilometers along track. This was caused by erroneous drag parameters used to predict the orbit vectors on the evening of the 29th and 30th when creating the User Ephemeris File (UEF). This error in the UEF affected the Level 1b earth location as indicated below; the TBUS bulletins sent out on September 30 and October 1; the Equator Crossing data showed a +2 second error, and the Search and Rescue Ephemeris. The problem was corrected around 1850L on October 1. Level 1b data will be reprocessed for archive purposes as indicated. Other passes are no longer available on the CEMSCS for reprocessing.

First orbits processed with bad Earth location:

NSS.GHRR.NL.D01273.S0025.E0219.B0526970.WI (and AIP)

NSS.HRPT.NL.D01273.S0600.E0613.B0527272.WI

NSS.LHRR.NL.D01273.S0056.E0102.B0526969.WI

Last orbits processed with bad Earth location:

NSS.GHRR.NL.D01274.S1850.E2043.B0529395.GC (and AIP)

NSS.HRPT.NL.D01274.S2228.E2242.B0529696.GC

NSS.LHRR.NL.D01274.S2037.E2041.B0529595.GC

These passes will be reprocessed to replace the archive data: (and AIPs for corresponding GHRR)

NSS.GHRR.NL.D01274.S1041.E1227.B0528990.GC.A
NSS.GHRR.NL.D01274.S1222.E1408.B0529091.GC.A
NSS.GHRR.NL.D01274.S1403.E1557.B0529192.WI.A
NSS.GHRR.NL.D01274.S1554.E1714.B0529293.WI.A
NSS.GHRR.NL.D01274.S1709.E1854.B0529294.WI.A
NSS.GHRR.NL.D01274.S1850.E2043.B0529395.GC.A

NSS.HRPT.NL.D01274.S1856.E1910.B0529494.WI.A
NSS.HRPT.NL.D01274.S2041.E2049.B0529595.MO.A
NSS.HRPT.NL.D01274.S2048.E2101.B0529595.GC.A
NSS.HRPT.NL.D01274.S2221.E2229.B0529696.MO.A
NSS.HRPT.NL.D01274.S2228.E2242.B0529696.GC.A

NSS.LHRR.NL.D01274.S1658.E1709.B0529292.WI.A
NSS.LHRR.NL.D01274.S1710.E1716.B0529393.WI.A
NSS.LHRR.NL.D01274.S1758.E1806.B0529393.WI.A
NSS.LHRR.NL.D01274.S1840.E1852.B0529393.WI.A
NSS.LHRR.NL.D01274.S2037.E2041.B0529595.GC.A
NSS.LHRR.NL.D01274.S2254.E2300.B0529696.GC.A

03 Oct 2001

Earth Location:

In reference to the NOAA-16 earth location problems reported for September 30 and October 1, the following

GAC and AIP (HIRS, AMSU) data were reprocessed to replace the earth location in the Level 1b archive. All

HRPT and LAC passes could not be reprocessed before the data was purged from the mainframe. All other data affected by the problem will not be reprocessed.

NSS.GHRR.NL.D01274.S1041.E1227.B0528990.GC.A
NSS.GHRR.NL.D01274.S1222.E1408.B0529091.GC.A
NSS.GHRR.NL.D01274.S1403.E1557.B0529192.WI.A
NSS.GHRR.NL.D01274.S1554.E1714.B0529293.WI.A
NSS.GHRR.NL.D01274.S1709.E1854.B0529294.WI.A
NSS.GHRR.NL.D01274.S1850.E2043.B0529395.GC.A

20 Oct 2001

The stored command table (SCT) returned the NOAA-14 MIRP to re-phasing 'enabled'. This command goes out at every day/night transition in order to change the APT channel. To remedy this situation, the schedulers are re-creating the SCTs for the next week with the MIRP commands removed. The new set of SCTs will become active at 0000z tonight (JDAY 293 / 0000z). As soon as possible after 0000z, re-phasing will be disabled and should remain so until further notice. The scan motor current continues to run at ~190 mA.

SATOPS Morning Report October 19, 2001

NOAA-14 AVHRR Anomaly: The NOAA-14 AVHRR began behaving erratically yesterday at

approximately 1955z. At that time, the scan motor current spiked up from ~120mA to ~163 mA and decreased slowly to ~135mA by 2230z. Since that time, the current has been steadily rising, reaching values as high as 205 mA. The sync deltas indicated that the MIRP was re-synching constantly in order to compensate for the AVHRR, resulting in corrupted TIP data and AVHRR imagery.

Re-phasing was disabled on the MIRP at 1207z this morning, recovering the rest of the TIP data stream. This is same configuration being used on NOAA-15, and it will remain the NOAA-14 configuration until further notice.

22 Oct 2001

The NOAA-14 AVHRR has been experiencing problems over the past few days. Below is information that we received from SOCC relating to the problem.

SATOPS Morning Report October 22, 2001

As a result of the N14 AVHRR end-of-life condition, the N14 MIRP was recommended to AVHRR Sync Rephase Disabled multiple times on Friday until the new stored command schedule resolved this issue at 0000z on Saturday morning. Multiple data sets prior to the GAC received at 0258z on Saturday, October 20, were corrupted due to AVHRR timing issues; this has now been resolved via SCT and the other data from N14 should continue without corruption due to the AVHRR.

07 Nov 2001

On November 6, on NOAA-14 rev 35326 / F at 1823z, the Satellite Operations Control Center (SOCC) performed an enable and then disable rephase to allow a re-sync of the AVHRR to occur. The HRPT data became very noisy during the brief period that it was enabled (indicating synch problems between the AVHRR and the MIRP). Users should see improvement in the data following this orbit.

13 Nov 2001

The NOAA-15 AMSU-B Channel 4 Warm Black Body counts, drifted into the Lower Limit and Gross filtering occurred over the last 36 hours (3 day weekend holiday). To correct the problem, the Channel 4 WBB gross filtering limit was opened from 23000 to 20000 so that addition data will be accepted. This change was effective after Level 1b orbit number 1820506.

20 Nov 2001

The PreProduct Processing group has plans to implement the following changes within the Level 1b/1b* data before the freeze scheduled for around the December 17th time frame. We are requesting feedback from the instrument scientists on the differences that the users will see due to the Planck constant update, as soon as possible. This information will be passed on to the user community. Initial Level 1b test data has been provided on the anonymous ftp site along with ops data ([psbsgi1.nesdis.noaa.gov](ftp://psbsgi1.nesdis.noaa.gov) under subdirectory `pub/test1b/R2.9A`) as indicated at the end of this message. CEMSCS data users will find Level 1b* data under the P1S data set names and Level 1b data under P1b data set names.

1. Correction of the Planck constants in response to the request from the Satellite Products and Services Review Board to adopt the 1998 CODATA constants for all operational systems in

NESDIS.

Current Planck constants: c1 = 0.119104398E-04 c2 = 1.43876934
1998 CODATA constants: c1 = 0.119104270E-04 c2 = 1.43877506

2. Orbit Parameters in the Header - Under certain circumstances we may be required by the Air Force to discontinue distribution of the orbit parameters in header for a period of time. To meet any such future requests, we are introducing a capability to zero out the orbit parameters (epoch date, time, and 12 orbit parameters) by toggling them on and off. (This change will also impact NOAA-12 and NOAA-14. Test data will be provided.)

Normal parallel test runs will begin on Monday, November 26th, with the orbit parameters provided as normal. After one week the orbit parameters will be turned off for a week (beginning Monday, December 3rd) and then back on the following week (Monday, December 10th).

NOAA-16

P1S.GHRR.NL.D01323.S1206.E1352.B0598182.GC
P1S.HRPT.NL.D01323.S1353.E1407.B0598282.GC
P1S.AMAX.NL.D01323.S1206.E1352.B0598182.GC
P1S.AMBX.NL.D01323.S1206.E1352.B0598182.GC
P1S.HIRX.NL.D01323.S1206.E1352.B0598182.GC

P1b.GHRR.NL.D01323.S1206.E1352.B0598182.GC
P1b.HRPT.NL.D01323.S1353.E1407.B0598282.GC
P1b.AMAX.NL.D01323.S1206.E1352.B0598182.GC
P1b.AMBX.NL.D01323.S1206.E1352.B0598182.GC
P1b.DCSX.NL.D01323.S1206.E1352.B0598182.GC
P1b.HIRX.NL.D01323.S1206.E1352.B0598182.GC
P1b.SBUX.NL.D01323.S1206.E1352.B0598182.GC
P1b.SEMX.NL.D01323.S1206.E1352.B0598182.GC
P1b.TIPX.NL.D01323.S1206.E1352.B0598182.GC

NOAA-15

P1S.GHRR.NK.D01323.S1126.E1310.B1828990.WI
P1S.HRPT.NK.D01323.S1312.E1326.B1829090.WI
P1S.AMAX.NK.D01323.S1126.E1310.B1828990.WI
P1S.AMBX.NK.D01323.S1126.E1310.B1828990.WI
P1S.HIRX.NK.D01323.S1126.E1310.B1828990.WI

P1b.GHRR.NK.D01323.S1126.E1310.B1828990.WI
P1b.HRPT.NK.D01323.S1312.E1326.B1829090.WI
P1b.AMAX.NK.D01323.S1126.E1310.B1828990.WI
P1b.AMBX.NK.D01323.S1126.E1310.B1828990.WI
P1b.DCSX.NK.D01323.S1126.E1310.B1828990.WI
P1b.HIRX.NK.D01323.S1126.E1310.B1828990.WI
P1b.SEMX.NK.D01323.S1126.E1310.B1828990.WI

P1b.TIPX.NK.D01323.S1126.E1310.B1828990.WI

05 Dec 2001

Updated NOAA-16 test data have been placed on the anonymous ftp server for those users that cannot access the CEMSCS. This data will be updated daily (Monday through Friday) until the implementation. We do not believe that the Planck constant change will impact your operations, however instrument scientists have not finalized their evaluations.

The HIRS data were checked and the 24 hour file was reset to ensure that we are in sync with operations and using only data based on the updated CPIDS. The data that I provided today is based on an updated file. The actual constants received in the notice were put in the CPIDS as received. However, the preprocessor treats all real numbers as REAL*4. As a result, after the fifth significant digit you will see differences in the data. You will not see the exact values that were put in from the notice. To fix this in the preprocessor is a MAJOR change (in essence, rewriting the preprocessor). If these new values are giving us bad or worse results, we should never implement them in the current preprocessor but wait for the METOP era. The Soundings Development Team reports that the images look fine.

12 Dec 2001

The two minute overlap test of the recorded data was conducted today on NOAA-16. It was scheduled to begin on orbit 6299/F at 0102z and end on the December 13th on orbit 6313/F at 0051z.

13 Dec 2001

The NOAA-15 HIRS 24-hour calibration test input file was reset to make it coincide with the operational file (except for the Planck constants change). We believe this will eliminate any problems seen in the NOAA-15 HIRS test data. Updated Level 1b test data for all NOAA-15 and 16 instruments has been provided on the anonymous ftp server ([psbsgi1.nesdis.noaa.gov](ftp://psbsgi1.nesdis.noaa.gov); Subdirectory - `pub/test1b/R2.9A`). Both NOAA-15 and 16 are running in parallel to the operation on the CEMSCS with the exception that the NOAA-15 GHRR is run by request (current orbit on the CEMSCS for GHRR is for D01347.S1355). Orbit parameters in the header are zeroed out in the test data. Next week these parameters will be turned back on. An implementation date will be set for mid January.

31 Dec 2001

Based on the response received, we believe that we can go forward with our plans to update the Planck constants and to add the ability to switch the orbit parameters in the header on and off. We plan to put the changes into operation on January 23, 2002. We will continue to provide the orbit parameters in the header and hence this should be a "no impact" change. We have provided test results below for you to compare to what you are seeing. Test data will continually be available until the actual implementation date.

Reports from instrument scientists and users on the observed impact of the change in test data provided.

HIRS

Dr. Changyong Cao of Office of Research and Applications reports that for NOAA-15 and -16,

the max difference observed in HIRS is on the order of 0.003 mW/m²-sr-cm-1.

AVHRR

Dr. Jerry Sullivan, Office of Research and Applications reports the following for AVHRR:

For NOAA-16, comparisons were done using the data sets
 NSS.GHRR.NL.D01340.S1047.E1231.B0622021.GC.OPS
 P1b.GHRR.NL.D01340.S1047.E1231.B0622021.GC

and for NOAA-15, the data sets
 GHRR.NK.D01323.S1126.E1310.B1828990.WI.OPS
 GHRR.NK.D01323.S1126.E1310.B1828990.WI
 These GAC orbits contain 5,000,000 Earthscene pixels.

For AVHRR channels 4 and 5, for both NOAA-15 and -16, the RMS difference between equivalent brightness temperatures generated from the old-Planck and new-Planck datasets was 0.001K.

For AVHRR channel 3B radiances/temperatures computed by using two different values for the Planck constants. Radiance was converted into equivalent blackbody temperature to make the comparison easier. Comparisons were broken down into three temperature ranges: >275K (SST range), 240-275 range, and the cold range from 200-240K. The accuracy of channel 3B temperatures below 240K is always somewhat suspect because on average there is a jump of 2.5K for the minimum count change of one count.

There were 5,000,000 pixels in the NOAA-15 datasets but only 2,500,000 in the NOAA-16 because channel 3A was on part of the time. The table below shows the channel 3B RMS temperature difference between datasets using the old and new Planck constant values.

Table G.1-5 Channel 3B RMS temperature differences (in K) between datasets using the old and new Planck constant values			
	> 275K	240-275	200-240 K
NOAA-15	0.019	0.095	0.400
NOAA-16	0.022	0.106	0.434

AMSU-A and AMSU-B

Dr. Clement Chouinard of Data Assimilation and Satellite Meteorology Division; Dorval P.Q.

CANADA (results of test done on one orbit) reports:

Number of AMSU-A data 347,400 (23,160 pixels * 15 channels)

- 3585 (1.32%) larger than .01 degrees
- 318328 (91.63%) identical
- 12149 (3.50%) smaller than 0.01 degrees
- 7084 (2.04%) smaller than 0.02 degrees
- 5525 (1.59%) smaller than 0.03 degrees
- 241 (0.07%) smaller than 0.04 degrees
- 226 (0.07%) smaller than 0.05 degrees

160 (0.05%) smaller than 0.06 degrees
100 (0.03%) smaller than 0.07 degrees
2 (0.00%) smaller than 0.08 degrees

Number of AMSU-B 1,042,200 (208,530 pixels * 5 channels)

3161 (0.30%) larger than .02 degrees
82700 (7.93%) larger than .01 degrees
765948 (73.46%) identical
167251 (16.04%) smaller than 0.01 degrees
16911 (1.62%) smaller than 0.02 degrees
4778 (0.46%) smaller than 0.03 degrees
1450 (0.14%) smaller than 0.04 degrees
303 (0.03%) smaller than 0.05 degrees
148 (0.01%) smaller than 0.06 degrees

23 Jan 2002

The Level 1b updates to include new Planck constants and the ability to switch orbit parameters in the header on and off will be made operational today as indicated below.

The times of the first orbits to be processed will be the following:

NSS.GHRR.NJ.D02023.S1233.E1428.B3642425.GC
NSS.HRPT.NJ.D02023.S1556.E1610.B3642626.GC

NSS.GHRR.NK.D02023.S1310.E1505.B1921516.GC
NSS.HRPT.NK.D02023.S1632.E1644.B1921717.GC

NSS.GHRR.NL.D02023.S1544.E1707.B0690001.WI
NSS.HRPT.NL.D02023.S1708.E1720.B0690101.WI

24 Jan 2002

NOAA-14: Beginning on the morning of January 18, 2002, the AVHRR GAC data changed so that most parameters reverted back to their normal values after months of problems caused by high scan motor currents. As of today all looks very good for the GAC. The HRPT data does seem to demonstrate a slight problem causing earth locations to look off by about a half pixel but not uniformly. Also, there appear to be numerous pixel dropouts or bad data points throughout the data.

Level 1b update clarification:

We are not planning to zero out the orbit parameters in the header. You should find that the parameters are still present. We have only installed the capability so that if the need arises, we will do so immediately and notify the user community.

When this change was implemented, we also implemented a change to correct the computation of the satellite azimuth angle at nadir. Problems had been reported for the AVHRR data where

the angle was set correctly to zero in the northern hemisphere and 180 in the southern hemisphere, but occasionally the southern hemisphere would have zero set instead of 180. This has been corrected.

05 Feb 2002

On February 6, 2002; the installation of the new frame synchronizers and software updates is scheduled for 11:20 pm to 3:01 am local (038/0420z - 038/0801z). The change should be transparent to the user, however several passes will be delayed and the user will NOT receive HRPT data for NOAA-15 rev 19424/F AOS at 0524z and NOAA-16 rev 7106 AOS at 0621z.

On February 13, 2002; to support the frame sync installation and testing at the Wallops Command and Data Acquisition Station, the NOAA-11 STIP data for REV# 69058 will not be recorded between these times:

JDAY TIME - JDAY TIME
044 20:09:25 - 044 23:47:45

The lost record time total is: 3 hours 36 minutes 20 seconds.

13 Feb 2002

On February 12 (day 43), the NOAA-15 HIRS instrument began showing affects from increased Filter Motor Current. The Filter Motor Current began to rise on orbit 19498 but didn't seriously affect Sync until orbit 19503 when the sync went below 0.999. Sync is currently 70% (0.7) throughout orbits. Channel 7 space view went into saturation at the time of sync loss causing complete data loss for ch7 processing. Monitoring will continue.

14 Feb 2002

It looks like the NOAA-15 HIRS instrument is back to normal. Channel 7 returned to normal after the Level 1b pass B1952324. However, the HIRS 24-hour calibration file must be re-initialized to get rid of bad data. This will be done over the next 24-hours. Assuming the HIRS instrument continues to function properly, we expect to have a good update sometime tomorrow morning.

15 Feb 2002

Within the next 24 hours, we expect the HIRS instrument to stabilize. Useable coefficients should be provided in the Level 1b. Monitoring will continue.

11 Apr 2002

At 19:32z, JD 100, 4 April 2002, the AMSU-A channel 11 detector output changed rendering the data unusable. All readings of Space, Warm Target and Earth counts are approximately 7195 counts. No other parameters seem to be affected at this time. SOCC and instrument scientists have been notified of our observations.

12 Apr 2002

Update from the SOCC SATOPS Morning Report April 12, 2002:

"On Wednesday, April 10 at ~19:30z, the NOAA-15 AMSU-A1 channel 11 signal dropped dramatically. In the hours preceding the anomaly, channel 11 behaved normally, its value varying periodically with orbital position between ~18600 and 18000 counts. At ~17:50z the

pattern changed and by 18:45z it began to drop steadily. Finally at ~19:30z channel 11 dropped instantly from 16500 to 7195 counts. Since then it has been steady between 7196 and 7194 counts. So far the engineering investigation has not revealed any other abnormalities in AMSU data or spacecraft data that coincide with this anomaly, but they are continuing to look into the matter."

30 Apr 2002

The Satellite Operations Control Center (SOCC) reports that due to thermal considerations they began moving the NOAA-14 solar array on April 29. The solar array (SA) offset will change from -20 degrees to -55 degrees over the next few days.

01 May 2002

The SOCC morning report states the following:

NOAA-14 rev 37798/ F at 1928z on April 30: The solar array (SA) offset was modified to -40 degrees. It will remain at this offset for the next several weeks as engineers assess power and thermal balance.

This notice announces changes to the AIP (AMSU-A, AMSU-B, HIRS, DCS, SEM, SBUV) and AVHRR (GAC, LAC, and HRPT) Level 1b pre-processors planned for May 15, 2002. The user should see no changes in the AVHRR data. The following changes may be seen in the AIP Level 1b data to correct telemetry data. We believe these are also "no impact" changes.

Instrument Status: bytes 117 - 120 of the Data Set Quality Indicators in the HIRS Header Record may be different than in the current operation. The pre-processor was corrected to report the proper values for Digital-B telemetry status. The same is true for bytes 125 - 128 of the Second Instrument Status. The affected bits are indicated below.

- bit 15: Instrument power
- bit 14: Electronics power
- bit 13: Filter motor power
- bit 12: Scan motor power
- bit 11: Cooler heater
- bit 10: Filter housing heater
- bit 9: Cooler door release
- bit 8: Cooler window heater
- bit 7: Go to NADIR position
- bit 6: Calibration sequence
- bit 5: Cooler door closed
- bit 4: Cooler door fully open
- bit 3: Filter motor power Level
- bit 2: Patch temperature controller

Also under the Data Set Quality Indicators, bytes 123 - 124, the Record Number of Status Change can be different if the above telemetry instrument status bits are changed.

CPU values in the HIRS Level 1b data record - TIP Euler Angles (roll , pitch, and yaw), attitude

mode, attitude and time associated with TIP Euler angles retrieved from CPU telemetry differ from the operational data. They have been corrected so that values are pulled from the proper scan lines in all cases.

Digital-B Telemetry: Within the HIRS data record in the bytes 4541 - 4542 of the Invalid Word Bit Flags and bytes 4543 - 4544 of the Digital B Data may be different than in the current operation. The preprocessor was corrected to report the proper values as listed below.

bit 15: instrument power
bit 14: electronics power
bit 13: filter motor power
bit 12: scan motor power
bit 11: cooler heater
bit 10: filter housing heater
bit 9: cooler door release
bit 8: cooler window heater
bit 7: go to nadir position
bit 6: calibration sequence
bit 5: cooler door closed
bit 4: cooler door fully open
bit 3: filter motor power Level
bit 2: patch temperature controller

04 May 2002

NOAA/ NESDIS will implement a software change which uses revised AMSU-B Planck constants, on 8 May 2002. Computational values of two constants in AMSU-B needed correction. The constants in Planck's Law (c1 and c2) currently used in AMSU-B are slightly outdated and are being replaced based on an internal NOAA review.

Planck's Law states:

$$B(\nu, T) = 3D c1 * (\nu^3) / [e^{(c2*\nu/T)} - 1]$$

where:

B is radiation (energy/time/area/solid/angle/wavenumber),

ν = 3D wavenumber (number of wavelengths in one centimeter (cm⁻¹)),

T = 3D temperature K

The new values of c1 and c2 are

$$c1 = 3D 1.1910427E-05 \text{ mW/m}^2/\text{steradian/cm}^{-4}$$

$$c2 = 3D 1.4387752 \text{ cm} \cdot \text{K}$$

Changes (if any) will be minimal.

07 May 2002

SOCC announced that today a high speed dwell test will be conducted on NOAA-16 during a Fairbanks pass. The test is scheduled for pass 8367/F at 1518z (11:18 EST). The dwell tests are controlled by onboard macros activated via ground commanding. Any missing data is the result

of this test, and the test will be completed prior to LOS at 1532z (11:32 EST).

The dwell will replace the part of the TIP frames with data from the motor current on Gyro 1. The instruments that are affected by this are the HIRS, the SBUV, and SEM. Also, DCS, CPU-A/B, and DAU data will be lost. The gaps in data will correspond with dwell times, which should occur in 30 second periods. Hopefully no more than one run of the macro will be needed. 15 May 2002

The KLM pre-processor Release 3.0 update will go into operations today, May 15, around 2:00 p.m. local time. The user should not see any change in the Level 1b data. This change is being made to correct software problems. The first orbits to be processed for NOAA-15 and NOAA-16 are listed below.

NOAA-15

NSS.GHRR.NK.D02135.S1632.E1828.B2081112.GC

NSS.HRPT.NK.D02135.S2000.E2013.B2081313.GC

NOAA-16

NSS.GHRR.NL.D02135.S1651.E1836.B0848182.WI

NSS.HRPT.NL.D02135.S1836.E1852.B0848282.WI

NSS.LHRR.NL.D02135.S1739.E1747.B0848181.WI

G.2 CHANGES MADE TO NESDIS' SST OBSERVATION PRODUCT

Not available

G.3 CHANGES MADE TO NAVY'S SST OBSERVATION PRODUCT

June 7, 1999

Began using NOAA-15 for operational processing of MCSST's. Equations based on April 1999 global drifting buoy match ups. Modified nighttime cloud screening, replacing AVHRR Ch5 - Ch3 test with AVHRR Ch4 - Ch3 test. The operational MCSST equations are the NLSST DAY SPLIT and the NLSST NIGHT TRIPLE.

NLSST DAY SPLIT

$$NL(4/5) = .9367T4 + .0864Tf (T4-T5) + .5979 (T4-T5)(SEC(A) - 1) - 253.8050$$

NLSST NIGHT TRIPLE

$$NL(3/4/5) = .9799 T4 + .0364Tf (T3-T5) + 1.195 (SEC (A) - 1) - 266.0100$$

T3 = Channel 3 Brightness Temperature (K)

T4 = Channel 4 Brightness Temperature (K)

T5 = Channel 5 Brightness Temperature (K)

Tf = Analyzed Field Temperature (C)

A = Satellite Zenith Angle

June 24, 1999

NOAA-15: Modified AVHRR Ch4 - Ch5 cloud screening test. Test originally was Ch4 - Ch5 <

3.5, has been modified to $0 < (\text{Ch4} - \text{Ch5}) < 3.5$.

August 23, 1999

NOAA-15: Implemented new visible cloud threshold table, generated with data collected during the July - Aug 1999 time frame.

February 28, 2000

NOAA-15: Operationally implemented new coefficients for the HIRS two part test.

March 7, 2001

NOAA-16: Initiated operational distribution of NOAA-16 MCSST orbital files.

Implemented Orbital MCSST equations derived for NOAA-16 SEATEMP processing. Equations based on December 2000 global drifting buoy matches. The operational MCSST equations are the NLSST DAY SPLIT and the NLSST NIGHT TRIPLE.

NLSST DAY SPLIT

$$NL(4/5) = .9139T4 + .0770Tf(T4-T5) + .7659(T4-T5)(\text{SEC}(A) - 1) - 247.9117$$

NLSST NIGHT TRIPLE

$$NL(3/4/5) = .9407T4 + .0330Tf(T3-T5) + 1.6042(\text{SEC}(A) - 1) - 255.0355$$

T3 = Channel 3 Brightness Temperature (K)

T4 = Channel 4 Brightness Temperature (K)

T5 = Channel 5 Brightness Temperature (K)

Tf = Analyzed Field Temperature (C)

A = Satellite Zenith Angle

April 16, 2001

NOAA-16: Updated NOAA-16 equations based on March 2001 global drifting buoy matches. The operational MCSST equations are the NLSST DAY SPLIT and the NLSST NIGHT TRIPLE.

NLSST DAY SPLIT

$$NL(4/5) = .9233T4 + .0755Tf(T4-T5) + .8015(T4-T5)(\text{SEC}(A) - 1) - 250.6939$$

NLSST NIGHT TRIPLE

$$NL(3/4/5) = .9627T4 + .0327Tf(T3-T5) + 1.5653(\text{SEC}(A) - 1) - 261.4709$$

T3 = Channel 3 Brightness Temperature (K)

T4 = Channel 4 Brightness Temperature (K)

T5 = Channel 5 Brightness Temperature (K)

Tf = Analyzed Field Temperature (C)

A = Satellite Zenith Angle

June 28, 2001

NOAA-16: Implemented a field test for type 159 processing in areas of high specular reflectance. This test will help eliminate the generation of aerosol contaminated observations.

October 9, 2001

NOAA-16: Implemented a two-part nighttime aerosol test. The test has to fail both a SST intercomparison (MC(3/4) equation minus NL (4/5) equation) and a field test to be rejected as aerosol contaminated. Implemented reliability values that are assigned to each MCSST observation.

October 17, 2001

NOAA-16: Updated NOAA-16 equations based on September 2001 global drifting buoy matches. The operational MCSST equations are the NLSST DAY SPLIT and the NLSST NIGHT TRIPLE.

NLSST DAY SPLIT

$$NL(4/5) = .9171T4 + .0795Tf(T4-T5) + .7975(T4-T5)(SEC(A) - 1) - 248.8961$$

NLSST NIGHT TRIPLE

$$NL(3/4/5) = .9622T4 + .0336Tf(T3-T5) + 1.6073(SEC(A) - 1) - 261.3291$$

T3 = Channel 3 Brightness Temperature (K)

T4 = Channel 4 Brightness Temperature (K)

T5 = Channel 5 Brightness Temperature (K)

Tf = Analyzed Field Temperature (C)

A = Satellite Zenith Angle

November 27, 2001

NOAA-16: Increased day/night attempts per target from 10/3 to 15/15 attempts, respectively.

March 25, 2002

NOAA-16: Updated NOAA-16 daytime equations based on February 2002 global drifting buoy matches. The operational MCSST daytime equation is the NLSST DAY SPLIT.

NLSST DAY SPLIT

$$NL(4/5) = .9246T4 + .0775Tf(T4-T5) + .7664(T4-T5)(SEC(A) - 1) - 251.1504$$

T4 = Channel 4 Brightness Temperature (K)

T5 = Channel 5 Brightness Temperature (K)

Tf = Analyzed Field Temperature (C)

A = Satellite Zenith Angle

April 30, 2002

NOAA-16: Implemented 1 km Land/Sea tag file to allow better coastal MCSST generation.

October 22, 2002

NOAA-17: Initiated operational distribution of NOAA-17 MCSST orbital files.

Implemented Orbital MCSST equations derived for NOAA-17 SEATEMP processing. Equations based on August/September 2002 global drifting buoy matches. The operational MCSST equations are the NLSST DAY SPLIT and the NLSST NIGHT TRIPLE.

NLSST DAY SPLIT

$$NL(4/5) = .9404T4 + .0838Tf(T4-T5) + 1.1098(T4-T5)(\text{SEC}(A) - 1) - 255.1277$$

NLSST NIGHT TRIPLE

$$NL(3/4/5) = .9684T4 + .0334Tf(T3-T5) + 1.9245(\text{SEC}(A) - 1) - 262.5276$$

T3 = Channel 3 Brightness Temperature (K)

T4 = Channel 4 Brightness Temperature (K)

T5 = Channel 5 Brightness Temperature (K)

Tf = Analyzed Field Temperature (C)

A = Satellite Zenith Angle

November 5, 2002

NOAA-16: Updated NOAA-16 daytime equations based on September 2002 global drifting buoy matches. The operational MCSST daytime equation is the NLSST DAY SPLIT.

NLSST DAY SPLIT

$$NL(4/5) = .9128T4 + .0803Tf(T4-T5) + .7709(T4-T5)(\text{SEC}(A) - 1) - 247.7182$$

T4 = Channel 4 Brightness Temperature (K)

T5 = Channel 5 Brightness Temperature (K)

Tf = Analyzed Field Temperature (C)

A = Satellite Zenith Angle

November 7, 2002

NOAA-17: Initiated operational production and distribution of MCSST's generated with NOAA-17 LAC data.

April 22, 2003

NOAA-16: Implemented new Visible Cloud Threshold table generated with data collected during the March/April 2003 time frame.

May 28, 2003

NOAA-16 and NOAA-17: Replaced the linear interpolation of Level 1b earth location data with three-point Lagrangian interpolation. This will improve the accuracy of the earth location towards the edge of the scan.

June 11, 2003

NOAA-16 and NOAA-17: Modified processing code to enable MCSST production when solar zenith angles are between 75-90 and channel 3a data is present. Currently a type 159 (relaxed daytime) observation is attempted.

July 2, 2003

NOAA-17: Updated NOAA-17 daytime equations based on May/June 2003 global drifting buoy matches. The operational MCSST daytime equation is the NLSST DAY SPLIT.

NLSST DAY SPLIT

$$NL(4/5) = .9304T4 + .0870Tf(T4-T5) + 1.0076(T4-T5)(\text{SEC}(A) - 1) - 252.4396$$

T4 = Channel 4 Brightness Temperature (K)

T5 = Channel 5 Brightness Temperature (K)

Tf = Analyzed Field Temperature (C)

A = Satellite Zenith Angle

November 24, 2003

NOAA-16: Updated NOAA-16 daytime equations based on November 2003 global drifting buoy matches. The operational MCSST daytime equation is the NLSST DAY SPLIT.

NLSST DAY SPLIT

$$NL(4/5) = .9296T4 + .0813Tf(T4-T5) + .7214(T4-T5)(\text{SEC}(A) - 1) - 252.4412$$

T4 = Channel 4 Brightness Temperature (K)

T5 = Channel 5 Brightness Temperature (K)

Tf = Analyzed Field Temperature (C)

A = Satellite Zenith Angle

February 12, 2004

NOAA-16: Updated NOAA-16 daytime equations based on global drifting buoy matches. The operational MCSST daytime equation is the NLSST DAY SPLIT.

NLSST DAY SPLIT

$$NL(4/5) = .9128T4 + .0803Tf(T4-T5) + .7709(T4-T5)(\text{SEC}(A) - 1) - 247.7182$$

T4 = Channel 4 Brightness Temperature (K)

T5 = Channel 5 Brightness Temperature (K)

Tf = Analyzed Field Temperature (C)

A = Satellite Zenith Angle

May 19, 2004

NOAA-16: Updated NOAA-16 daytime equations based on global drifting buoy matches. The operational MCSST daytime equation is the NLSST DAY SPLIT.

NLSST DAY SPLIT

$$NL(4/5) = .9296T4 + .0813Tf(T4-T5) + .7214(T4-T5)(\text{SEC}(A) - 1) - 252.4412$$

T4 = Channel 4 Brightness Temperature (K)
T5 = Channel 5 Brightness Temperature (K)
Tf = Analyzed Field Temperature (C)
A = Satellite Zenith Angle

August 24, 2004

NOAA-16 and NOAA-17: Modified nighttime low stratus cloud screening test, replacing AVHRR ch5-ch3>0 test with AVHRR ch4-ch3>0 test.

June 7, 2005

NOAA-16: Implemented Orbital MCSST equations derived for NOAA-16 Sea Temp processing. Regression necessary due to improved ch4 + ch5 calibration precision in new NOAA-N formatted 1B data. Equations based on May 2005 global drifting buoy matches. The operational MCSST equations are the NLSST DAY SPLIT and the NLSST NIGHT TRIPLE.

NLSST DAY SPLIT

$$NL(4/5) = .9018T4 + .0824Tf(T4-T5) + .6923(T4-T5)(SEC(A) - 1) - 244.5447$$

NLSST NIGHT TRIPLE

$$NL(3/4/5) = .9802T4 + .0331Tf(T3-T5) + 1.7227(SEC(A) - 1) - 266.5712$$

T3 = Channel 3 Brightness Temperature (K)
T4 = Channel 4 Brightness Temperature (K)
T5 = Channel 5 Brightness Temperature (K)
Tf = Analyzed Field Temperature (C)
A = Satellite Zenith Angle

NOAA-17: Implemented Orbital MCSST equations derived for NOAA-17 SeaTemp processing. Regression necessary due to improved ch4 + ch5 calibration precision in new NOAA-N formatted 1B data. Equations based on May 2005 global drifting buoy matches. The operational MCSST equations are the NLSST DAY SPLIT and the NLSST NIGHT TRIPLE.

NLSST DAY SPLIT

$$NL(4/5) = .9367T4 + .0848Tf(T4-T5) + 1.0270(T4-T5)(SEC(A) - 1) - 254.2330$$

NLSST NIGHT TRIPLE

$$NL(3/4/5) = .9984T4 + .0329Tf(T3-T5) + 1.9592(SEC(A) - 1) - 271.3281$$

T3 = Channel 3 Brightness Temperature (K)
T4 = Channel 4 Brightness Temperature (K)
T5 = Channel 5 Brightness Temperature (K)
Tf = Analyzed Field Temperature (C)
A = Satellite Zenith Angle

G.4 CHANGES MADE TO MAPPED GAC PRODUCTS

November 27, 2001

NOAA-16: Increased day/night attempts per target from 10/3 to 15/15 attempts, respectively.

March 25, 2002

NOAA-16: Updated NOAA-16 daytime equations based on February 2002 global drifting buoy matches. The operational MCSST daytime equation is the NLSST DAY SPLIT.

NLSST DAY SPLIT

$$NL(4/5) = .9246T4 + .0775Tf(T4-T5) + .7664(T4-T5)(SEC(A) - 1) - 251.1504$$

T4 = Channel 4 Brightness Temperature (K)

T5 = Channel 5 Brightness Temperature (K)

Tf = Analyzed Field Temperature (C)

A = Satellite Zenith Angle

April 30, 2002

NOAA-16: Implemented 1 km Land/Sea tag file to allow better coastal MCSST generation.

October 22, 2002

NOAA-17: Initiated operational distribution of NOAA-17 MCSST orbital files. Implemented Orbital MCSST equations derived for NOAA-17 SEATEMP processing. Equations based on August/September 2002 global drifting buoy matches. The operational MCSST equations are the NLSST DAY SPLIT and the NLSST NIGHT TRIPLE.

NLSST DAY SPLIT

$$NL(4/5) = .9404T4 + .0838Tf(T4-T5) + 1.1098(T4-T5)(SEC(A) - 1) - 255.1277$$

NLSST NIGHT TRIPLE

$$NL(3/4/5) = .9684T4 + .0334Tf(T3-T5) + 1.9245(SEC(A) - 1) - 262.5276$$

T3 = Channel 3 Brightness Temperature (K)

T4 = Channel 4 Brightness Temperature (K)

T5 = Channel 5 Brightness Temperature (K)

Tf = Analyzed Field Temperature (C)

A = Satellite Zenith Angle

November 5, 2002

NOAA-16: Updated NOAA-16 daytime equations based on September 2002 global drifting buoy matches. The operational MCSST daytime equation is the NLSST DAY SPLIT.

NLSST DAY SPLIT

$$NL(4/5) = .9128T4 + .0803Tf(T4-T5) + .7709(T4-T5)(SEC(A) - 1) - 247.7182$$

T4 = Channel 4 Brightness Temperature (K)

T5 = Channel 5 Brightness Temperature (K)

Tf = Analyzed Field Temperature (C)

A = Satellite Zenith Angle

November 7, 2002

NOAA-17: Initiated operational production and distribution of MCSSTs generated with NOAA-17 LAC data.

April 22, 2003

NOAA-16: Implemented new Visible Cloud Threshold table generated with data collected during the March/April 2003 time frame.

May 28, 2003

NOAA-16 and NOAA-17: Replaced the linear interpolation of Level 1b earth location data with three-point Lagrangian interpolation. This will improve the accuracy of the earth location towards the edge of the scan.

June 11, 2003

NOAA-16 and NOAA-17: Modified processing code to enable MCSST production when solar zenith angles are between 75-90 and channel 3a data is present. Currently a type 159 (relaxed daytime) observation is attempted.

July 2, 2003

NOAA-17: Updated NOAA-17 daytime equations based on May/June 2003 global drifting buoy matches. The operational MCSST daytime equation is the NLSST DAY SPLIT.

NLSST DAY SPLIT

$$NL(4/5) = .9304T4 + .0870Tf(T4-T5) + 1.0076(T4-T5)(\text{SEC}(A) - 1) - 252.4396$$

T4 = Channel 4 Brightness Temperature (K)

T5 = Channel 5 Brightness Temperature (K)

Tf = Analyzed Field Temperature (C)

A = Satellite Zenith Angle

November 24, 2003

NOAA-16: Updated NOAA-16 daytime equations based on November 2003 global drifting buoy matches. The operational MCSST daytime equation is the NLSST DAY SPLIT.

NLSST DAY SPLIT

$$NL(4/5) = .9296T4 + .0813Tf(T4-T5) + .7214(T4-T5)(\text{SEC}(A) - 1) - 252.4412$$

T4 = Channel 4 Brightness Temperature (K)

T5 = Channel 5 Brightness Temperature (K)

Tf = Analyzed Field Temperature (C)

A = Satellite Zenith Angle

February 12, 2004

NOAA-16: Updated NOAA-16 daytime equations based on global drifting buoy matches. The operational MCSST daytime equation is the NLSST DAY SPLIT.

NLSST DAY SPLIT

$$NL(4/5) = .9128T4 + .0803Tf(T4-T5) + .7709(T4-T5)(\text{SEC}(A) - 1) - 247.7182$$

T4 = Channel 4 Brightness Temperature (K)

T5 = Channel 5 Brightness Temperature (K)

Tf = Analyzed Field Temperature (C)

A = Satellite Zenith Angle

May 19, 2004

NOAA-16: Updated NOAA-16 daytime equations based on global drifting buoy matches. The operational MCSST daytime equation is the NLSST DAY SPLIT.

NLSST DAY SPLIT

$$NL(4/5) = .9296T4 + .0813Tf(T4-T5) + .7214(T4-T5)(\text{SEC}(A) - 1) - 252.4412$$

T4 = Channel 4 Brightness Temperature (K)

T5 = Channel 5 Brightness Temperature (K)

Tf = Analyzed Field Temperature (C)

A = Satellite Zenith Angle

August 24, 2004

NOAA-16 and NOAA-17: Modified nighttime low stratus cloud screening test, replacing AVHRR ch5-ch3>0 test with AVHRR ch4-ch3>0 test.

June 7, 2005

NOAA-16: Implemented Orbital MCSST equations derived for NOAA-16 SeaTemp processing. Regression necessary due to improved ch4 + ch5 calibration precision in new NOAA-N formatted 1B data. Equations based on May 2005 global drifting buoy matches. The operational MCSST equations are the NLSST DAY SPLIT and the NLSST NIGHT TRIPLE.

NLSST DAY SPLIT

$$NL(4/5) = .9018T4 + .0824Tf(T4-T5) + .6923(T4-T5)(\text{SEC}(A) - 1) - 244.5447$$

NLSST NIGHT TRIPLE

$$NL(3/4/5) = .9802T4 + .0331Tf(T3-T5) + 1.7227(\text{SEC}(A)-1) - 266.5712$$

T3 = Channel 3 Brightness Temperature (K)

T4 = Channel 4 Brightness Temperature (K)

T5 = Channel 5 Brightness Temperature (K)

Tf = Analyzed Field Temperature (C)

A = Satellite Zenith Angle

NOAA-17: Implemented Orbital MCSST equations derived for NOAA-17 SeaTemp processing.

Regression necessary due to improved ch4 + ch5 calibration precision in new NOAA-N formatted 1B data. Equations based on May 2005 global drifting buoy matches. The operational MCSST equations are the NLSST DAY SPLIT and the NLSST NIGHT TRIPLE.

NLSST DAY SPLIT

$$NL(4/5) = .9367T4 + .0848Tf(T4-T5) + 1.0270(T4-T5)(\text{SEC}(A) - 1) - 254.2330$$

NLSST NIGHT TRIPLE

$$NL(3/4/5) = .9984T4 + .0329Tf(T3-T5) + 1.9592(\text{SEC}(A) - 1) - 271.3281$$

T3 = Channel 3 Brightness Temperature (K)

T4 = Channel 4 Brightness Temperature (K)

T5 = Channel 5 Brightness Temperature (K)

Tf = Analyzed Field Temperature (C)

A = Satellite Zenith Angle

G.5 CHANGES MADE TO RADIATION BUDGET PRODUCTS

Not Available

G.6 CHANGES MADE TO SOUNDING PRODUCTS (ATOVS AND AMSU-B)

April 27, 1999

ATOVS operational.

May 4, 1999

Update coefficients.

May 11, 1999

Update coefficients.

May 12, 1999

1. Added AMSU-A channel 6 to the CDB high terrain retrieval channel combination. This will only affect high terrain areas like Antarctica and the Himalayas.

2. RETDVR was modified to retrieve coast and ice as land.

3. SPGDVR software was modified to do limb correction only once.

May 17, 1999

Update coefficients.

May 24, 1999

Update coefficients.

June 2, 1999

Update coefficients.

June 8, 1999
Update coefficients.

June 9, 1999
The ATOVS GTS (SATEM) formatter was modified to check for zero thickness values and filter retrievals containing those values from distribution.

June 24, 1999
Implemented new OPCUPD to:
1. Correct problem with summing of total ozone values when values are missing (substitute the values for the US Standard Ozone for missing and then include in sum).
2. Replace global S matrix with "S" bin 5 (everything south of 60S) where the S matrix is only based on that bin's samples. Rest of globe still use the global S matrix.

New Coefficients generated from this implementation were not used in the operations until after the implementation described for June 29, 1999.

June 24, 1999
The GTS formatter (SATEM) was modified to perform quality control and then sub sample. The tasks were being done in reverse, which at times led to a reduced sample size. This will ensure that all retrievals selected for distribution are of acceptable quality.

June 29, 1999
Implemented new SPGDVR to remove AMSU-A channel 6 from the CDB for high terrain retrieval channel combination. This will only affect high terrain areas like Antarctica and the Himalayas.

July 6, 1999
Update Coefficients.

July 13, 1999
Update Coefficients.

July 15, 1999
Implemented new SPGDVR to call new RETOD2 which uses correct measurement for precipitable water.

July 19, 1999
Update Coefficients.

July 22, 1999
A new Unified Radiosonde system was implemented.

July 26, 1999
Update Coefficients.

July 30, 1999

Corrected scaling factors on the Retrieval Operational Data File (RODF) which is the primary output file from SPGDVR and primary input file to all product formatters and the retrieval archive. A total of 20 scaling factors were incorrect.

Parameter	Old Scaling	New (Correct) Scaling
Retrieved Surface Pressure	1	64
1st Guess Water Vapor Mixing Ratio (1st word)	64	1024
1st Guess radiance Temperature (1st word)	1024	64
Forecast Relative Humidity	64	256
Forecast surface pressure	256	10
Forecast Pressure	64	10
Potential Temperature time minus	10	100
Forecast time Stability Departure	10	512
Lower Departure	100	512
Time difference (satellite minus forecast)	512	1
Stability forecast increment	512	1
Total Precipitable water (300-500mb)	100	128
Total Precipitable water (500-700mb)	1	128
Sulfur Dioxide	128	1
Polar Redundancy Flag	128	1
Outgoing long wave radiation	1	10
Layer Cooling rate (240-10mb)	1	1000
Layer cooling rate(500-240mb)	10	1000
Cloud comparison flag	1000	1
Library search closeness	1000	1

August 4, 1999

Corrected $I_1 I_2 I_3 I_4$ term for the SATEM to have I_3 (Instrument Combination Flag) set to 1 when clear and 3 when cloudy and I_4 (Data Processing Technique) set to 3 when cloudy and 4 when clear.

August 9, 1999

Update Coefficients.

August 10, 1999

On August 9, 1999, two NOAA-15 orbits 064344 and 64445 were lost due to antenna problems at Gilmore Creek.

August 17, 1999

Update Coefficients.

August 23, 1999

Update Coefficients.

August 30, 1999
Update Coefficients.

September 1, 1999
Orbit 676364 failed processing.

September 2, 1999
The precipitable water content had been incorrectly distributed in the SATEM as distinct layers when it should have been summation. This was corrected. Additionally, cases were found where the terrain was sea but the sea surface temperature was zero, these situations were eliminated in the SATEM. The problem is the terrain flag comes from the SSM/I processing and the Sea Surface Temperature is from another system with (obviously) a different terrain field.

September 7, 1999
Update coefficients.

September 13, 1999
Update coefficients.

September 20, 1999
Update coefficients.

September 22, 1999
Corrected the “No HIRS” designation to not be flagged when the HIRS really is present. Also changed the initialization of some variables to be properly done.

October 4, 1999
Update coefficients.

October 4 to 6, 1999
Problems with orbital processing resulted in the replacement of the first guess library, CDB and OPCDB at 1545L on October 6.

October 7, 1999
Archive changed to report ‘0’ SST as missing instead of ‘0’ see September 2, 1999 entry for explanation of ‘0’ SST.

October 12, 1999
Update coefficients.

October 13, 1999
Copied clear and cloud Matchup data bases from parallel to operations, changed CDB after orbit 736768 (data time 1650 to 1835Z).

October 19, 1999

Update coefficients.

October 25, 1999

Update coefficients.

November 2, 1999

Change CDB radiosonde match time windows for the latitude bins to reduce the number of matchups in selected bins. (New time windows by bin (3,6,6,6,4,6,6,4,3,2,3,3,3,3,3,2,2,3,3,3,3,3,2)).

November 4, 1999

Update coefficients.

November 10, 1999

Update coefficients.

November 15, 1999 10:35L

Modified thresholds in CDB.

November 17, 1999

Update coefficients.

November 17, 1999

Allocate archive with logical record length of 1000 and block size of 9000.

November 18, 1999

Modified thresholds in CDB.

November 23, 1999

Update coefficients.

November 24, 1999 11:54L

Modified thresholds in CDB.

December 1, 1999

Update coefficients.

December 2, 1999

Update thresholds in CDB.

December 6, 1999

Update coefficients.

December 14, 1999

Update coefficients.

December 21, 1999
Update coefficients.

December 21, 1999
Spike in HIRS filter wheel motor current in orbit 832122 (1841 -2027Z). Did not appear to impact data.

December 28, 1999
Update coefficients.

January 5, 2000
Update coefficients.

January 12, 2000
Update coefficients.

January 12, 2000 10:47L
Change window channel test threshold.

January 19, 2000
Update coefficients.

January 27, 2000
Update coefficients.

February 1, 2000
Implemented significant upgrade:

1. Replaced the radiosonde oriented first guess computation for stratospheric levels with an AMSU-A regression scheme. The two schemes are merged between 50 and 10mb inclusive.
2. The grouping (binning) of the matchups were changed to use ascending/descending node instead of day/night for grouping in addition to latitude zone and terrain. Additionally, the problem of some bins being reported a full (complete set of matchups) when they were actually incomplete and could hold more matches (and hence improve the selection for the first guess) were corrected.
3. Consistent screening of the matchups between the eigenvector update, the operator component update and the first guess library build is now being performed.
4. The eigenvector update was also modified to use ice data for land eigenvectors only (not sea). This program also extends the interpolated temperature profile from the RAOB by merging the interpolated profile generated from AMSU-A channel brightness temperatures.
5. The orbital processing was modified with these changes:

A. Correct the exclusion of HIRS channel 20 on the product file which had been mistakenly removed by the limb correction process and in its place the node was included. (Those who read channel 20 from the BUFR data- you are getting the node!)

B. Used the AMSU-A surface products cloud liquid water and land precipitation index to create a new precipitation contamination flag. This flag is combined with the median filter flag in the overall precipitation editing scheme. Note, we do not send precipitation data to users.

C. The cloud products (currently experimental) were improved by adding a separate calculation of the cloud amount based on the surface temperature estimated HIRS channel 8. Finally, filters were added to remove extraneous clouds over Antarctica. Please note this is NOT the clear/cloudy indicator but the Cloud amount, cloud top temperature, etc. terms.

D. Two layers were added to the computation of the total precipitable water (200-250mb and 250-300mb), these are currently not distributed.

E. Cloud detection tests were modified for high terrain in response to concerns raised about the total ozone computation. This IS the clear/ cloudy indicator.

F. AMSU-A channel 5 is excluded in the computation of the retrieval operator component G for land south of -60 South.

G. Added AMSU-A data mislocation algorithm.

February 8, 2000

Update coefficients.

February 24, 2000

Update coefficients.

February 25, 2000

Copied clear and cloudy matchup data bases from the production parallel system to the operational system.

March 7, 2000

Update coefficients.

March 14, 2000

Update coefficients.

March 16, 2000

Changed CDB thresholds at 11:20 am.

March 20, 2000

Update coefficients.

March 28, 2000

Update coefficients.

April 5, 2000

Update coefficients.

April 11, 2000
Update coefficients.

April 18, 2000
Update coefficients.

April 25, 2000
Update coefficients.

G.7 CHANGES MADE TO COASTWATCH PRODUCTS

Not available.

G.8 CHANGES MADE TO SNOW AND ICE PRODUCTS

Not available.

G.9 CHANGES MADE TO OZONE (SBUV/2) PRODUCTS

Not available.

G.10 CHANGES MADE TO AEROSOL/OPTICAL THICKNESS PRODUCTS

Not available.

APPENDIX H: ORBIT INJECTION

The information below is outdated.

Satellites of the NOAA KLM series will be launched into Sun-synchronous orbits. The first stage booster will be a U.S. Air Force Titan II; second stage propulsion will be provided by a rocket motor integral with the satellite.

The guidance system of the Titan vehicle is used to control the first stage of the satellite launch. The spacecraft system monitors launch parameters and controls the flight after separation from the Titan vehicle. Body rates and accelerations are provided to the CPU by the Inertial Measurement Unit (IMU) which is made up of rate integrating gyros and accelerometers. The CPU uses a stored set of equations to determine the optimum flight profile which, after first stage separation, is maintained by the Reaction Control System (RCS). Hydrazine and nitrogen are used to provide spacecraft control during the solid motor burn, and to trim orbit velocity after insertion, and during the period when the solar array is deployed. Unused nitrogen gas is retained on the satellite for use in the event of unexpected momentum buildup during the lifetime of the satellite. The RCE and the accelerometers are deactivated after the orbital insertion maneuvers are completed.

ACTIVATION AND EVALUATION PERIOD

The four to six week period following the launch of a satellite is reserved for engineering evaluation. Instruments will be tested during the period, but transmission of data will be sporadic at best. Neither the AVHRR/3 or the HIRS/3 will be activated during the first two weeks following a launch. During this period, the radiant cooler covers will remain in place and the coolers will be heated to 40 C to assure that outgassing contaminants from the satellite will not be attracted to the cooler surface and degrade its operation. Following the outgassing period, instrument evaluation will begin.

APPENDIX I: FORMULATION OF A GENERIC ALGORITHM FOR EARTH LOCATING DATA FROM NOAA POLAR SATELLITES

This appendix is a version of a paper written by James K. Ellickson (NOAA/NESDIS), Marie D. Henry (NOAA/NESDIS), Dr. C.K. Wong and Dr. Om P. Sharma (both of Science and Systems Applications, Inc) in August 1988 and included in NOAA Technical Memorandum NESS 107, Revision 1, as Appendix C. Although it was written almost 20 years ago, the information contained herein is still pertinent to the new NOAA KLM series satellites. The present version has been modified by Irv Ruff (NOAA/NESDIS), to include provision for instrument mounting errors, and by Howard Carney (NOAA/NESDIS), to include provision for geodetic subpoint and to correct some inconsistencies.

I.1 GENERAL

This document describes a general algorithm for computing Earth location values for data from scanning radiometers flown on three-axis stabilized polar orbiting satellites. Given the following information about any data point, a corresponding latitude and longitude on Earth can be computed:

- 1) Position and velocity of the satellite as a function of time

$$\vec{P}_{sat}(t) = (X_{sat}, Y_{sat}, Z_{sat})_I$$

where $\vec{P}_{sat}(t)$ is the position vector of the satellite and its components are expressed in the earth-centered-inertial coordinate system I (e.g., equator and equinox of date) at a time in a standard time system (such as UTC).

$$\vec{V}_{sat}(t) = (\dot{X}_{sat}, \dot{Y}_{sat}, \dot{Z}_{sat})_I$$

where $\vec{V}_{sat}(t)$ is the velocity of the satellite relative to the same inertially fixed coordinate system I at time t with its components expressed in that system.

- 2) Rotation of the Earth in the same time system, t, relative to the earth-fixed-inertial coordinate system, I, with a rotation angle written G(t), commonly called the “Greenwich Hour Angle”.
- 3) Misalignments of the instrument from the coordinate system in which the nadir position of the scanner points towards the subsatellite point and scanning is perpendicular to the scan-axis vector/satellite subpoint vector plane. (see not below.)
 - a. the misalignments are constant instrument mounting and/or attitude errors

b. misalignments or attitude errors as functions of time in the t system

- 4) The time difference between the t system and the time-tagging system of the satellite, (i.e., the onboard computer).
- 5) The timing and angular displacements of each data sample in the scanning cycle.

NOTES ON MISALIGNMENTS OF THE INSTRUMENTS:

The constant instrument mounting and/or time dependent attitude errors for NOAA satellites are minimized by the Attitude Determination and Control System (ADACS) onboard the spacecraft. This system orients the satellite in such a way that the nadir position of the scanning instruments always points toward the geodetic satellite subpoint. The residual errors of this system are reported in the data stream and could be used to correct the earth locations calculations in the paper. However, the handling of these misalignment errors, as a function of time, is somewhat complicated and beyond the intended scope of this algorithm description. These misalignments are included here for the sake of completion.

I.2 CALCULATING THE EARTH COORDINATES OF A SCAN SPOT

Consider an inertial coordinate system, I, whose origin is the center of the Earth (Figure I.2-1). The line joining the center of the earth to the Vernal Equinox constitutes the X-axis. The Z-axis is perpendicular to the equatorial plane and in the direction of the North Pole. The Y-axis is defined such that the vectors $\vec{X}, \vec{Y}, \vec{Z}$ constitute a right handed coordinate system. Let \vec{P}_{sat} and \vec{P}_{spot} be position vectors of the satellite and the scan spot, respectively. Then the position of the scan spot on the earth in the inertial coordinate system can be expressed in equation I-1.

$$\begin{pmatrix} X_{spot} \\ Y_{spot} \\ Z_{spot} \end{pmatrix} = \begin{pmatrix} X_{sat} \\ Y_{sat} \\ Z_{sat} \end{pmatrix} + R \begin{pmatrix} d_x \\ d_y \\ d_z \end{pmatrix} \tag{I-1}$$

or

$$\vec{P}_{spot} = \vec{P}_{sat} + R\hat{d} \tag{I-2}$$

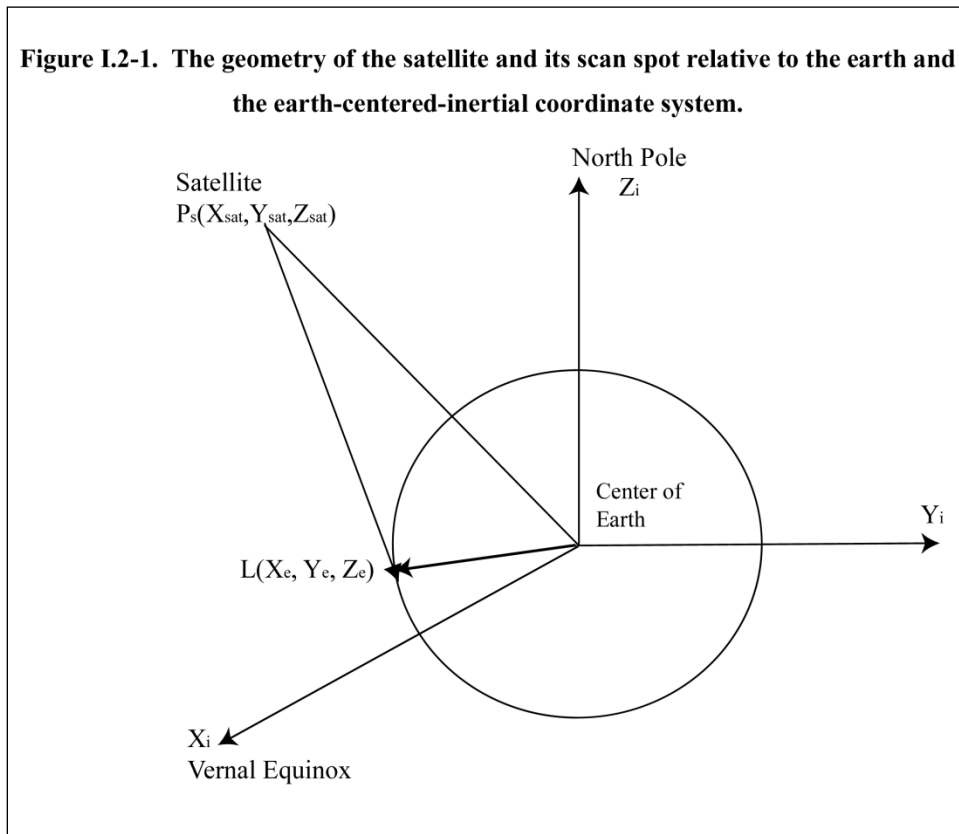

Figure I.2-1. The Geometry of the Satellite and Its Scan Spot Relative to the Earth and the Earth-centered-inertial Coordinate System

Where R is the range or distance from the satellite to the scan spot and (dx, dy, dz) are the direction cosines of the scan spot from the satellite. The subscript I designates the inertial coordinate system. See Figure I.2-1.

In order to solve for $P_{spot} = (X_{spot}, Y_{spot}, Z_{spot})_I$, a new coordinate system centered at the spacecraft is established; call it the nominal scanning coordinate system. The scanner mounting frame is taken as the origin. The positive X_{ns} -axis is in the direction of the satellite's subpoint (See I.3 "Defining the Satellite Subpoint"). The Z_{ns} -axis is along the nominal spin axis of the mirror, perpendicular to X_{ns} and positive in the direction of the velocity vector. The Y_{ns} -axis completes a right handed system. If there are no misalignments, the instrument mirror will scan perpendicular to the X_{ns} - Z_{ns} plane. See Figure I.2- 2.

Define

$$\hat{P} \equiv (X_p, Y_p, Z_p)_I \tag{I-3}$$

where X_p , Y_p and Z_p are the direction cosines, in earth-centered-inertial coordinates, of the

satellite subpoint from the satellite.

The speed of the satellite relative to the earth-centered-inertial frame is

$$|\vec{V}_{sat}| = \sqrt{\dot{X}_{sat}^2 + \dot{Y}_{sat}^2 + \dot{Z}_{sat}^2}$$

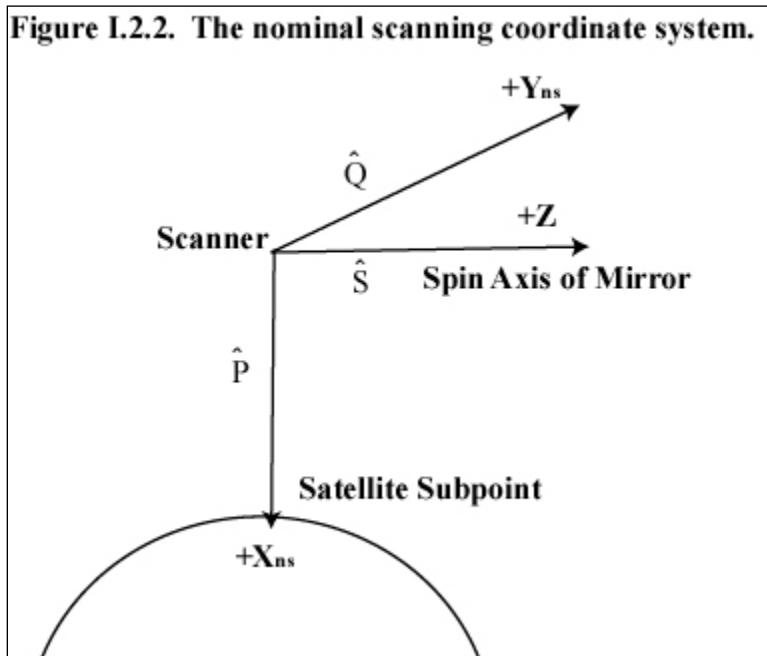

Figure I.2-2. The Nominal Scanning Coordinate System.

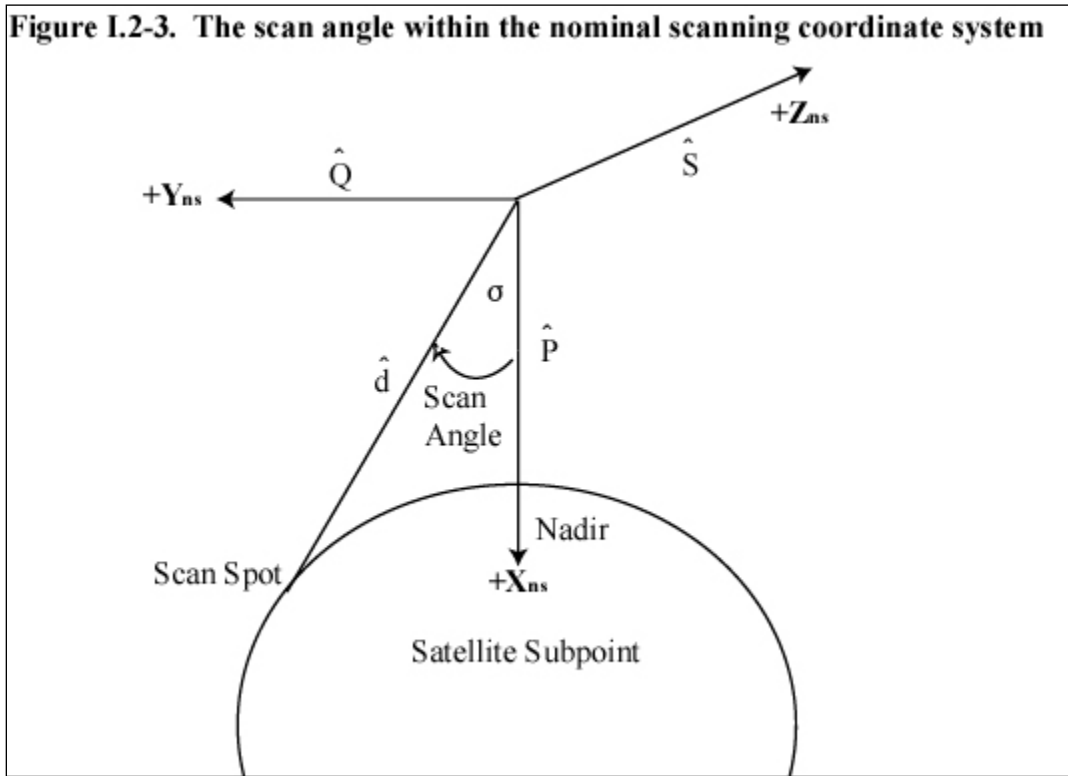

Figure I.2-3. The Scan Angle Within the Nominal Scanning Coordinate System.

Define

$$\begin{aligned}\hat{v} &\equiv (\dot{X}_{sat} / |\vec{V}_{sat}|, \dot{Y}_{sat} / |\vec{V}_{sat}|, \dot{Z}_{sat} / |\vec{V}_{sat}|)_I \\ &\equiv (X_v, Y_v, Z_v)_I\end{aligned}\quad (I-4)$$

where X_v , Y_v and Z_v are the direction cosines of the satellites velocity relative to the earth-centered-inertial frame and expressed as components in the earth-centered-inertial system.

$$\begin{aligned}\hat{Q} &= \frac{\hat{v} \times \hat{P}}{|\hat{v} \times \hat{P}|} = \frac{(Y_v Z_p - Z_v Y_p, Z_v X_p - X_v Z_p, X_v Y_p - Y_v X_p)_I}{|\hat{v} \times \hat{P}|} \\ &= (X_q, Y, Z_q)_I\end{aligned}\quad (I-5)$$

where

$$|\hat{v} \times \hat{P}| = \sqrt{(Y_v Z_p - Z_v Y_p)^2 + (Z_v X_p - X_v Z_p)^2 + (X_v Y_p - Y_v X_p)^2}$$

and X_q , Y_q and Z_q are the direction cosines of \hat{Q} in the earth-centered-inertial system. The spin vector

$$\begin{aligned}\hat{S} &= \hat{P} \times \hat{Q} = \frac{\hat{P} \times (\hat{v} \times \hat{P})}{|\hat{v} \times \hat{P}|} \\ &= (Y_p Z_q - Z_p Y_q, Z_p X_q - X_p Z_q, X_p Y_q - Y_p X_q)_I \\ &= (X_{spin}, Y_{spin}, Z_{spin})_I\end{aligned}\tag{I-6}$$

where X_{spin} , Y_{spin} , and Z_{spin} are the direction cosines of \hat{S} in the earth-centered-inertial system.

In Figure I.2-3, the scanner direction \hat{d} is measured in the PQS system, that is, the nominal scanning system. The unit vector \hat{d} is really \hat{P} rotated about \hat{S} by the right-handed scan angle σ as shown in Figure I.2-3. It should be noted that the scan direction of the AVHRR instrument is right-handed and opposite that of the TOVS instruments. Each of the TOVS instruments scans in the same direction, sun to anti-sun, and its scan is a left-handed rotation about the scan axis.

To transfer any vector, \vec{A} , from the PQS coordinate system to the inertial system,

$$\vec{A}_I = \begin{bmatrix} X_p & X_q & X_{spin} \\ Y_p & Y_q & Y_{spin} \\ Z_p & Z_q & Z_{spin} \end{bmatrix} \vec{A}_{PQS}\tag{I-7}$$

Case 1: If there are no instrument mounting errors, the scan is measured in the nominal scanning coordinate system. The unit vector \hat{d} (along the direction toward the scanned spot) in the PQS system can be written as:

$$\hat{d}_{PQS} = \begin{bmatrix} \cos\sigma & -\sin\sigma & 0 \\ \sin\sigma & \cos\sigma & 0 \\ 0 & 0 & 1 \end{bmatrix} \begin{bmatrix} 1 \\ 0 \\ 0 \end{bmatrix}\tag{I-8}$$

Using the coordinate transformation given by Eq. I.2-7 and employing Eqs I.2-3, I.2-5 and I.2-6, the vector can be written in the inertial system as:

$$\hat{d} = \begin{bmatrix} X_p & X_q & X_{spin} \\ Y_p & Y_q & Y_{spin} \\ Z_p & Z_q & Z_{spin} \end{bmatrix} \begin{bmatrix} \cos\sigma & -\sin\sigma & 0 \\ \sin\sigma & \cos\sigma & 0 \\ 0 & 0 & 1 \end{bmatrix} \begin{bmatrix} 1 \\ 0 \\ 0 \end{bmatrix} \quad (\text{I-9})$$

Case 2: If there are instrument mounting errors, expressed as nonzero right-handed roll(R), pitch (P) and yaw (Y), then the unit vector in the PQS system in equation I-8 becomes:

$$\hat{d}_{PQS} = [B][C][D] \begin{bmatrix} 1 \\ 0 \\ 0 \end{bmatrix} \quad (\text{I-10})$$

Where

[B] is the rotation matrix about the yaw axis, nominally X_{ns}, for an angle (-Y) (to undo the yaw)

$$[B] = \begin{bmatrix} 1 & 0 & 0 \\ 0 & \cos Y & -\sin Y \\ 0 & \sin Y & \cos Y \end{bmatrix} \quad (\text{I-11})$$

[C] is the rotation matrix about the pitch axis, nominally Y_{ns}, for an angle (-P) (to undo the pitch)

$$[C] = \begin{bmatrix} \cos P & 0 & \sin P \\ 0 & 1 & 0 \\ -\sin P & 0 & \cos P \end{bmatrix} \quad (\text{I-12})$$

[D] is the rotation matrix about the roll axis, nominally Z_{ns}, for an angle -(σ+R) (to undo both the roll and the scan)

$$[D] = \begin{bmatrix} \cos(\sigma + R) & -\sin(\sigma + R) & 0 \\ \sin(\sigma + R) & \cos(\sigma + R) & 0 \\ 0 & 0 & 1 \end{bmatrix} \quad (\text{I-13})$$

$$\hat{d} = \begin{bmatrix} X_p & X_q & X_{spin} \\ Y_p & Y_q & Y_{spin} \\ Z_p & Z_q & Z_{spin} \end{bmatrix} \hat{d}_{PQS} \quad (\text{I-14})$$

Since $P_{spot} = P_{sat} + Rd$ and the point L lies on the surface of the Earth, it satisfies the equation:

$$\frac{X_{spot}^2}{r_e^2} + \frac{Y_{spot}^2}{r_e^2} + \frac{Z_{spot}^2}{r_p^2} = 1 \quad (\text{I-15})$$

or

$$\frac{(X_{sat} + Rd_x)^2}{r_e^2} + \frac{(Y_{sat} + Rd_y)^2}{r_e^2} + \frac{(Z_{sat} + Rd_z)^2}{r_p^2} = 1 \quad (\text{I-16})$$

where r_e is the equatorial radius and r_p is the polar radius of the Earth (The WGS72 values, $r_e = 6378.135$ km and $r_p = 6356.75052$ km, are used at NOAA for NOAA satellites). Expanding terms, we have

$$\begin{aligned} & \frac{X_{sat}^2}{r_e^2} + \frac{2X_{sat}Rd_x}{r_e^2} + \frac{R^2d_x^2}{r_e^2} + \frac{Y_{sat}^2}{r_e^2} + \frac{2Y_{sat}Rd_y}{r_e^2} + \frac{R^2d_y^2}{r_e^2} + \\ & \frac{Z_{sat}^2}{r_p^2} + \frac{2Z_{sat}Rd_z}{r_p^2} + \frac{R^2d_z^2}{r_p^2} = 1 \end{aligned} \quad (\text{I-17})$$

or, on simplification,

$$AR^2 + BR + C = 0 \quad (\text{I-18})$$

where

$$A = \frac{d_x^2}{r_e^2} + \frac{d_y^2}{r_e^2} + \frac{d_z^2}{r_p^2} \quad (\text{I-19})$$

$$B = 2 \left[\frac{X_{sat}d_x}{r_e^2} + \frac{Y_{sat}d_y}{r_e^2} + \frac{Z_{sat}d_z}{r_p^2} \right] \quad (\text{I-20})$$

$$C = \frac{X_{sat}^2}{r_e^2} + \frac{Y_{sat}^2}{r_e^2} + \frac{Z_{sat}^2}{r_p^2} - 1 \quad (I-21)$$

solving for R in equation I-18,

$$R = \frac{-B \pm \sqrt{B^2 - 4AC}}{2A} \quad (I-22)$$

Equation I-18 is a quadratic in R and, if the scan ray does in fact intersect the surface of the Earth (i.e., real and positive roots), B above should always be negative. Since A is always positive and C is positive (whenever the satellite is above the surface of the Earth), then the radical in Eq. I-22 must be less than -B. Therefore, in the case of two different real positive solutions for R, the smaller one, closer to the satellite, is visible to the satellite and the larger one, the point away from the satellite, is on the opposite side of the Earth. As such, the smallest of the two solutions should be taken as the distance of the satellite from the scan spot.

In Equation I-1,

$$\begin{pmatrix} X_{spot} \\ Y_{spot} \\ Z_{spot} \end{pmatrix} = \begin{pmatrix} X_{sat} \\ Y_{sat} \\ Z_{sat} \end{pmatrix} + R \begin{pmatrix} d_x \\ d_y \\ d_z \end{pmatrix} \quad (I-23)$$

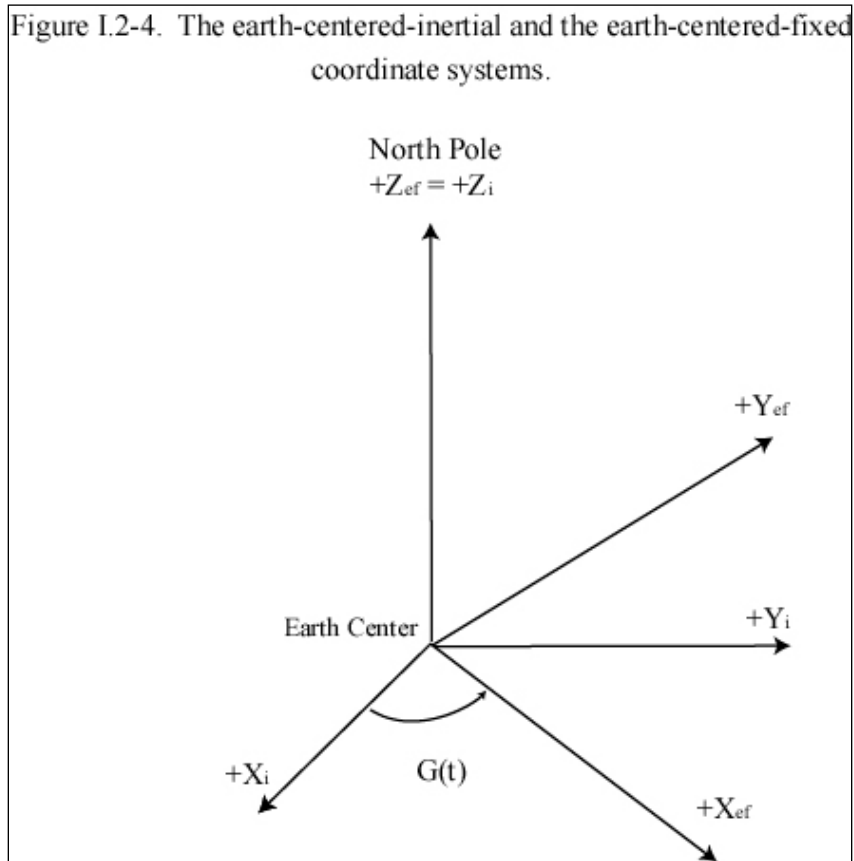

Figure I.2-4. The Earth-centered-inertial Coordinate and the Earth-centered-fixed Coordinate System.

everything on the right hand side is known, so the coordinates of the scan point on the Earth in the inertial coordinate system can be calculated. All that remains is to rotate the Earth using time t obtained from the data sample to calculate a point fixed to the spinning Earth.

The Earth Centered Fixed coordinate system (ECF) rotates with the Earth. It has its center at the center of mass of the Earth with the following defined axes: See Figure I.2-4)

$$x_{ECF} = \text{the axis from the center of the Earth through Greenwich meridian at the equator} \quad (\text{I-24})$$

$$y_{ECF} = \text{toward 90 degrees East longitude} \quad (\text{I-25})$$

$$z_{ECF} = \text{points north along the spin axis of the Earth} \quad (\text{I-26})$$

Next, we calculate the rotation of the ECF system (rotating with the Earth) with respect to the inertially fixed (I) system. The angle $G(t)$, is the rotation of the Greenwich meridian relative to the inertial x-axis. As a function of time,

$$G(t) = G_0 + \dot{G}_1 t_1 + \dot{G}_2 t_2 \quad (\text{I-24})$$

where

$G(t)$ = Hour angle of Greenwich (that is, the eastward angle from the direction of the vernal equinox (0 degrees N, 0 degrees E) measured at the earth's center) at time t (radians)

G_0 = Hour angle of Greenwich at the beginning of the year of interest (radians)

\dot{G}_1 = Increase in the hour angle of Greenwich per day (+0.0172027912 radians/day)

t_1 = Day of year for time of interest, t

\dot{G}_2 = Rotational rate of the Earth (=6.300388098 radians/day)

t_2 = Fraction of a day for time of interest, t

Values of G_0 can be computed or found in the American Ephemeris and Nautical Almanac for the current year. (These should be updated as appropriate to account for leap seconds.)

In order to transform inertial coordinates to geocentric Earth Centered Fixed coordinates, the following equations are used:

$$X_{ECF} = X_I \cos(G(t)) + Y_I \sin(G(t)) \quad (\text{I-27})$$

$$Y_{ECF} = Y_I \cos(G(t)) - X_I \sin(G(t)) \quad (\text{I-28})$$

$$Z_{ECF} = Z_I \quad (\text{I-29})$$

When the “rotating” coordinates are found, the geocentric latitude, ϕ_{gc} , and longitude, θ , can then be calculated according to equations I-30 and I-31.

$$\phi_{gc} = \arctan \left[\frac{Z_{ECF}}{\sqrt{X_{ECF}^2 + Y_{ECF}^2}} \right] \quad (\text{I-30})$$

$$\theta = \arctan \left[\frac{Y_{ECF}}{X_{ECF}} \right] \quad (\text{I-31})$$

Geocentric latitude, ϕ is the angle between the equatorial plane and a line joining the point, L (the scan spot), on the Earth's surface to the center of mass of the Earth. This is in contrast to the geodetic latitude, ϕ_{gd} , which is the angle between the normal at L and the plane of the equator. The longitude, θ , is the angle between two meridian planes both containing the earth's axis of rotation; one of the planes contains L , and the other contains the Greenwich meridian.

Values of latitude given on standard maps are usually ‘geodetic’ latitude. The geodetic latitude, ϕ_{gd} , of a point on the earth ellipsoid (that is, at Mean Sea Level) has the following value:

$$\varphi_{gd} = \arctan \left[\frac{r_e^2 \cdot Z_{EDF}}{r_p^2 \cdot \sqrt{X_{ECF}^2 + Y_{ECF}^2}} \right] \quad (\text{I-32})$$

(See I.4 “Conversion between Geodetic and Geocentric Latitude”)

I.3 DEFINING THE SATELLITE SUBPOINT

There are at least two ways to define the satellite subpoint. The first way is to call it the intersection with the earth ellipsoid surface of a line from the satellite to the earth ellipsoid's center - call this the geocentric subpoint. The second way is to call it the intersection with the earth ellipsoid's surface of a line from the satellite perpendicular to the ellipsoid - call this the geodetic subpoint. (See Figure I.3-1 and imagine that the feature being located is the satellite.) When the satellite is over the North or South Pole or over the Equator, geodetic and geocentric subpoints will be colocated; when it is over 45° North or South, the distance between the geocentric and geodetic subpoints will be about 2.5 kilometers for NOAA satellites. Documents describing the NOAA K, L and M Attitude Detection and Control System (ADACS) define the subpoint to be geodetic.

Case 1 - The satellite subpoint is defined to be the geocentric subpoint.

In this case, the unit vector \vec{P} points in the opposite direction from the Satellite position vector. So, if the satellite's position vector in earth-centered-inertial coordinates is

$$\vec{P}_{sat} = (X_{sat}, Y_{sat}, Z_{sat})_I$$

then

$$\hat{P} = (X_p, Y_p, Z_p)_I = \left[\frac{-X_{sat}}{|\vec{P}_{sat}|}, \frac{-Y_{sat}}{|\vec{P}_{sat}|}, \frac{-Z_{sat}}{|\vec{P}_{sat}|} \right]_I$$

where

$$|\vec{P}_{sat}| = \sqrt{X_{sat}^2 + Y_{sat}^2 + Z_{sat}^2}$$

Case 2 - The satellite subpoint is defined to be the geodetic subpoint.

In this case, the earth-centered-inertial coordinates of the satellite will be known. The problem will be to use them to find the direction cosines from the satellite toward the geodetic subpoint. Again, the position vector of the satellite will be

$$\vec{P}_{sat} = (X_{sat}, Y_{sat}, Z_{sat})_I$$

The magnitude of the component of this vector that is in the equatorial plane is

$$DIST_{sateq} = \sqrt{X_{sat}^2 + Y_{sat}^2}.$$

If $DIST_{sateq} = 0$ and $Z_{sat} > 0.0$ or if $DIST_{sateq} = 0$ and $Z_{sat} < 0.0$, or if $Z_{sat} = 0.0$, or if $Z_{sat} = 0.0$ the satellite is over one of the earth's poles or the earth's equator and the geodetic subpoint is the same as the geocentric subpoint.

If $DIST_{sateq} \neq 0$ and $Z_{sat} \neq 0$, then use the equation relating geocentric latitude and geodetic latitude (See "I.4 CONVERSION BETWEEN GEODETIC AND GEOCENTRIC LATITUDE", equation (I-36)).

$$\tan(\phi_{satgc}) =$$

$$\left[\frac{r_p^2 + h_{sat} \cdot r_p \cdot \sqrt{\left(\frac{r_e}{r_p}\right)^2 \cdot \cos^2(\phi_{satgd}) + \sin^2(\phi_{satgd})}}{r_e^2 + h_{sat} \cdot r_p \cdot \sqrt{\left(\frac{r_e}{r_p}\right)^2 \cdot \cos^2(\phi_{satgd}) + \sin^2(\phi_{satgd})}} \right] \cdot \tan(\phi_{satgd})$$

where h_{sat} , the height of the satellite above the ellipsoid, has been substituted for h_f , the height of the feature of interest, the satellite's geocentric latitude, ϕ_{satgc} , has been substituted for ϕ_{gcf} , the geocentric latitude of the feature, and the satellite's geodetic latitude, ϕ_{satgd} , has been substituted for ϕ_{gdf} , the geodetic latitude of the feature. The tangent of the satellite's geocentric latitude is given by

$$\tan(\phi_{satgc}) = z_{sat} / DIST_{sateq}.$$

Use it in the above equation, and solve for ϕ_{satgd} by the procedures given in section, I.4, B "Conversion from Geodetic Latitude", Case 2. The right ascension of the satellite is $\Theta_{sat} = \arctan(Y_{sat}/X_{sat})$. Find the earth-centered-inertial position vector of the geodetic satellite subpoint, (x_s, y_s, z_s) , by using equations (I-31), (I-32) and (I-33) and replacing ϕ_{gdf} with ϕ_{satgd} and θ_f with Θ_{sat} . The vector from the satellite to its geodetic subpoint will be

$$\vec{P}_{sat2gd} = (x_s - X_{sat}, y_s - Y_{sat}, z_s - Z_{sat})_I$$

and its magnitude will be

$$|\vec{P}_{sat2gd}| = \sqrt{(x_s - X_{sat})^2 + (y_s - Y_{sat})^2 + (z_s - Z_{sat})^2}$$

The unit vector pointing from the satellite toward its geodetic subpoint will be, then,

$$\hat{P} = (X_p Y_p Z_p)_I = \left[\frac{(x_s - X_{sat})}{|\vec{P}_{sat2gd}|}, \frac{(y_s - Y_{sat})}{|\vec{P}_{sat2gd}|}, \frac{(z_s - Z_{sat})}{|\vec{P}_{sat2gd}|} \right]_I$$

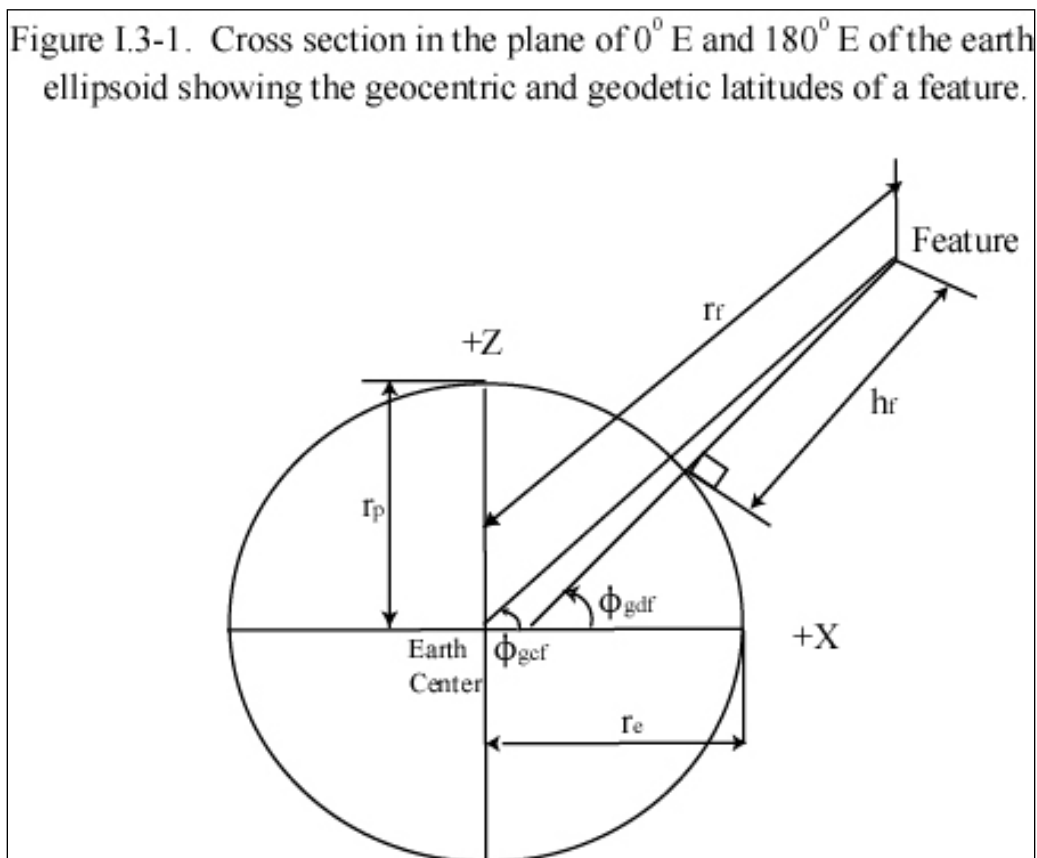

Figure I.3-1. Cross Section in the Plane of 0° E and 180° E of the Earth Ellipsoid Showing the Geocentric and Geodetic Latitudes of a Feature.

I.4 CONVERSION BETWEEN GEODETIC AND GEOCENTRIC LATITUDE

Figure I.3-1 represents a cross section of the earth with polar radius r_p and equatorial radius r_e . A feature is represented at height h_f above Mean Sea Level. The height is measured along a line through the feature and perpendicular to the earth ellipsoid's surface. The distance of the feature

from the earth's center is r_f .

$\phi_{\text{gcf}} \equiv$ geocentric (or geometric) latitude of the feature.

$-90^0 \leq \phi_{\text{gcf}} \leq 90^0$. North is positive.

$\phi_{\text{gdf}} \equiv$ geodetic latitude of the feature.

$-90^0 \leq \phi_{\text{gdf}} \leq 90^0$. North is positive.

The boundary of the earth's cross section is assumed to be an ellipse formed by the equation

$$\frac{x_s^2}{r_e^2} + \frac{z_s^2}{r_p^2} = 1$$

when the cross section in the xz plane.

A. Conversion from Geodetic to Geocentric Latitude

Suppose that ϕ_{gdf} is known. Then the slope of the line tangent to the earth's cross section at ϕ_{gdf} is

$$-\tan(90^0 - \phi_{\text{gdf}}) = 1 / \tan(\phi_{\text{gdf}}).$$

This slope is equal to the derivative dz_s/dx_s . From the equation for the earth's cross section,

$$2 \cdot x_s / r_e^2 + 2 \cdot z_s \cdot (dz_s / dx_s) / r_p^2 = 0$$

$$dz_s / dx_s = -(r_p / r_e)^2 \cdot x_s / z_s$$

So

$$1 / \tan(\phi_{\text{gdf}}) = (r_p / r_e)^2 \cdot x_s / z_s$$

or

$$1 / \tan(\phi_{\text{gdf}}) = (r_p / r_e)^2 \cdot x_s / z_s$$

where (x_s, z_s) is the point on the cross section boundary at geodetic latitude ϕ_{gdf}

Solving for x_s gives $x_s = (r_e / r_p)^2 \cdot z_s / \tan(\phi_{\text{gdf}})$

Substitution in the equation for the earth's cross section gives

$$\frac{r_e^2 \cdot z_s^2}{r_p^4 \cdot \tan^2(\phi_{gdf})} + \frac{z_s^2}{r_p^2} = 1$$

or

$$z_s^2 = \frac{1}{\frac{r_e^2}{r_p^4 \cdot \tan^2(\phi_{gdf}) + \left[\frac{1}{r_p^2} \right]}} = \frac{r_p^4 \cdot \tan^2(\phi_{gdf})}{r_e^2 + r_p^2 \cdot \tan^2(\phi_{gdf})}$$

$$z_s = \pm \frac{r_p^2 \cdot \tan(\phi_{gdf})}{\sqrt{r_e^2 + r_p^2 \cdot \tan^2(\phi_{gdf})}}$$

$$z_s = \pm \frac{r_p \cdot \tan(\phi_{gdf})}{\sqrt{(r_e / r_p)^2 + \tan^2(\phi_{gdf})}}$$

Substitution off this back in the equation for x_s

$$x_s = \pm \frac{(r_e / r_p)^2 \cdot r_p \cdot \tan(\phi_{gdf})}{\tan(\phi_{gdf}) \cdot \sqrt{(r_e / r_p)^2 + \tan^2(\phi_{gdf})}}$$

These equations for x_s and z_s can be put in the forms

$$x_s = \frac{r_e^2 \cdot \cos(\phi_{gdf}) \cdot \cos(\theta_f)}{r_p \cdot \sqrt{(r_e / r_p)^2 \cdot \cos^2(\phi_{gdf}) + \sin^2(\phi_{gdf})}} \quad (\text{I-31})$$

Where 2_f is the East longitude of the feature,

$$y_s = \frac{r_e^2 \cdot \cos(\phi_{gdf}) \cdot \sin(\theta_f)}{r_p \cdot \sqrt{(r_e / r_p)^2 \cdot \cos^2(\phi_{gdf}) + \sin^2(\phi_{gdf})}}$$

and

$$z_s = \frac{r_p^2 \cdot \sin(\phi_{gdf})}{r_p \cdot \sqrt{(r_e / r_p)^2 \cdot \cos^2(\phi_{gdf}) + \sin^2(\phi_{gdf})}} \quad (\text{I-33})$$

because x_s and y_s will always have the same signs as $\cos(\theta_f)$ and $\sin(\theta_f)$, respectively, and z_s will always have the same sign as $\sin(\phi_{gdf})$. The coordinates (x_f, y_f, z_f) of the feature can now be calculated.

$$x_f = \left[\frac{r_e^2}{r_p \cdot \sqrt{(r_e / r_p)^2 \cos^2(\phi_{gdf}) + \sin^2(\phi_{gdf})}} + h_f \right] \cdot \cos(\phi_{gdf}) \cdot \cos(\theta_f),$$

$$y_f = \left[\frac{r_e^2}{r_p \cdot \sqrt{(r_e / r_p)^2 \cdot \cos^2(\phi_{gdf}) + \sin^2(\phi_{gdf})}} + h_f \right] \cdot \cos(\phi_{gdf}) \cdot \sin(\theta_f),$$

and

$$z_f = \left[\frac{r_p^2}{r_p \cdot \sqrt{(r_e / r_p)^2 \cdot \cos^2(\phi_{gdf}) + \sin^2(\phi_{gdf})}} + h_f \right] \cdot \sin(\phi_{gdf})$$

Finally, $\tan(\phi_{gcf}) = \frac{z_f}{\sqrt{x_f^2 + y_f^2}}$ so

$$\tan(\phi_{gcf}) = \left[\frac{r_p^2 + h_f \cdot r_p \cdot \sqrt{(r_e / r_p)^2 \cdot \cos^2(\phi_{gdf}) + \sin^2(\phi_{gdf})}}{r_e^2 + h_f \cdot r_p \cdot \sqrt{(r_e / r_p)^2 \cdot \cos^2(\phi_{gdf}) + \sin^2(\phi_{gdf})}} \right] \cdot \tan(\phi_{gdf}) \quad (\text{I-34})$$

And the distance to the feature from the earth's center is

$$r_f = \sqrt{x_f^2 + y_f^2 + z_f^2}$$

B. Conversion from Geocentric to Geodetic Latitude

Assume that ϕ_{gcf} , the geocentric latitude of a feature is known. If the feature's geodetic latitude is to be found, its height above Mean Sea Level must also be known. The feature's height above Mean Sea Level can be calculated if its distance from the center of the earth is known.

Case 1 - h_f the height of the feature above Mean Sea Level, is known

$$\tan(\phi_{gdf}) = \left[\frac{r_e^2 + h_f \cdot r_p \cdot \sqrt{(r_e / r_p)^2 \cdot \cos^2(\phi_{gdf}) + \sin^2(\phi_{gdf})}}{r_p^2 + h_f \cdot r_p \cdot \sqrt{(r_e / r_p)^2 \cdot \cos^2(\phi_{gdf}) + \sin^2(\phi_{gdf})}} \right] \cdot \tan(\phi_{gcf})$$

Since ϕ_{gdf} will not be known initially for substitution into the right side of the above equation, substitute a guess, starting with $\phi_{gdf} \approx \phi_{gcf}$, to compute a better guess. Iterate until the guesses converge.

Case 2 - r_f , the distance of the feature from the center of the earth, is known. Since

$$r_f = \sqrt{x_f^2 + y_f^2 + z_f^2},$$

$$r_f^2 = \left[\frac{r_e^2}{r_p \cdot \sqrt{(r_e / r_p)^2 \cdot \cos^2(\phi_{gdf}) + \sin^2(\phi_{gdf})}} + h_f \right]^2 \cdot \cos^2(\phi_{gdf}) +$$

$$\left[\frac{r_p^2}{r_p \cdot \sqrt{(r_e / r_p)^2 \cdot \cos^2(\phi_{gdf}) + \sin^2(\phi_{gdf})}} + h_f \right]^2 \cdot \sin^2(\phi_{gdf})$$

$$r_f^2 = \frac{r_e^4 \cdot \cos^2(\phi_{gdf})}{r_p^2 \cdot \left[(r_e / r_p)^2 \cdot \cos^2(\phi_{gdf}) + \sin^2(\phi_{gdf}) \right]^2} +$$

$$\frac{2 \cdot r_e^2 \cdot h_f \cdot \cos^2(\phi_{gdf})}{r_p \cdot \sqrt{(r_e / r_p)^2 \cdot \cos^2(\phi_{gdf}) + \sin^2(\phi_{gdf})}} + h_f^2 \cdot \cos^2(\phi_{gdf}) +$$

$$\frac{r_p^4 \cdot \sin^2(\phi_{gdf})}{r_p^2 \cdot \left[(r_e / r_p)^2 \cdot \cos^2(\phi_{gdf}) + \sin^2(\phi_{gdf}) \right]^2} +$$

$$\frac{2 \cdot r_p^2 \cdot h_f \cdot \sin^2(\phi_{gdf})}{r_p \cdot \sqrt{(r_e / r_p)^2 \cdot \cos^2(\phi_{gdf}) + \sin^2(\phi_{gdf})}} + h_f^2 \cdot \sin^2(\phi_{gdf})$$

$$r_f^2 = h_f^2 + \frac{2 \cdot h_f \cdot \left[r_e^2 \cdot \cos^2(\phi_{gdf}) + r_p^2 \cdot \sin^2(\phi_{gdf}) \right]}{r_p \cdot \sqrt{(r_e / r_p)^2 \cdot \cos^2(\phi_{gdf}) + \sin^2(\phi_{gdf})}} +$$

$$r_f^2 = h_f^2 + 2 \cdot h_f \cdot r_p \cdot \sqrt{\frac{r_e^4 \cdot \cos^2(\phi_{gdf}) + r_p^4 \cdot \sin^2(\phi_{gdf})}{r_p^2 \cdot \left[(r_e / r_p)^2 \cdot \cos^2(\phi_{gdf}) + \sin^2(\phi_{gdf}) \right]}} + \frac{r_p^2 \cdot \left[(r_e / r_p)^4 \cdot \cos^2(\phi_{gdf}) + \sin^2(\phi_{gdf}) \right]}{\left[(r_e / r_f)^2 \cdot \cos^2(\phi_{gdf}) + \sin^2(\phi_{gdf}) \right]}$$

Define

$$A \equiv 2 \cdot r_p \cdot \sqrt{\frac{r_e^4 \cdot \cos^2(\phi_{gdf}) + r_p^4 \cdot \sin^2(\phi_{gdf})}{r_p^2 \cdot \left[(r_e / r_p)^2 \cdot \cos^2(\phi_{gdf}) + \sin^2(\phi_{gdf}) \right]}}$$

$$B \equiv \frac{r_p^2 \cdot \left[(r_e / r_p)^4 \cdot \cos^2(\phi_{gdf}) + \sin^2(\phi_{gdf}) \right]}{\left[(r_e / r_p)^2 \cdot \cos^2(\phi_{gdf}) + \sin^2(\phi_{gdf}) \right]} - r_f^2$$

then $h_f^2 + A \cdot h_f + B = 0$, and this equation could be solved for h_f if ϕ_{gdf} were known.

$$h_f = \frac{-A \pm \sqrt{A^2 - 4B}}{2}$$

Since ϕ_{gdf} is not known initially, guess that $\phi_{gdf} \approx \phi_{gcf}$, solve for the corresponding h_f , use this as a guess height together with the guess ϕ_{gdf} is the same as the most recent guess. Then use ϕ_{gdf} to find a new guess for h_f . Iterate this procedure until both ϕ_{gdf} and h_f converge to stable values.

Appendix I: Formulation of a Generic Algorithm	1
I.1 General	1
I.2 Calculating the Earth Coordinates of a Scan Spot	2
I.3 Defining the Satellite Subpoint	12
I.4 Conversion Between Geodetic and Geocentric Latitude	14

Figure I.2-1. The Geometry of the Satellite and Its Scan Spot Relative to the Earth and the Earth-centered-inertial Coordinate System	3
Figure I.2-2. The Nominal Scanning Coordinate System.	4
Figure I.2-3. The Scan Angle Within the Nominal Scanning Coordinate System.	5
Figure I.2-4. The Earth-centered-inertial Coordinate and the Earth-centered-fixed Coordinate System.	10

Figure I.3-1. Cross Section in the Plane of 0° E and 180° E of the Earth Ellipsoid Showing the Geocentric and Geodetic Latitudes of a Feature.

14

APPENDIX J: INSTRUMENT SCAN PROPERTIES

Each instrument onboard the NOAA KLM and NOAA-N,N' series of spacecraft has its own unique scanning properties. This appendix contains a table of parameters (Table J-1) for the scanning instruments on the TIROS-N through NOAA-14 series (the TIROS-N series), and a table for the instruments on NOAA KLM and NOAA-N, N' (Table J-2). It should be noted that the AVHRR instrument scans from the anti-Sun side to the Sun side; i.e., from right to left when facing in the direction of satellite motion. All other instruments scan in the opposite direction.

The SEM and DCS/2 instruments have not been included in this appendix, because neither instrument scans. The SEM has fixed FOVs and the DCS/2 is a passive instrument acting as a transponder. Technically, the SBUV/2 instrument does not scan, but is a nadir viewing instrument. However, a brief section (J.4) is included describing how it looks at the earth through a sequence of 12 wavelength changes.

In addition, this appendix contains a section for each instrument with figures showing the scan motion.

Table J-1. Satellite Scanning Instrument Parameters for TIROS-N through NOAA-14.				
Parameter	AVHRR/2	HIRS/2 & 2I⁷	SSU	MSU
IFOV (Degrees)	0.0745	HIRS/2: 1.22 HIRS/2I: 1.40	10	7.5
Full scan period (seconds)	0.1667	6.4	32	25.6
Earth View				
Total number of earth view steps	2048	56	8	11
Center to center FOV step angle (Degrees)	0.0541	1.8	10	9.4737
Max scan angle (Degrees from Nadir to the center of outer earth FOV)	55.37	49.5	35	47.3685
Total earth view time (msec)	51.2	5600 ¹	32000 ⁶	20823
FOV integration time + dead time ⁸ (msec)	0.025	100	4000	1893

Integration period/FOV (msec)	0.025	Channel 1=5.1; Channels 2-12=1.8; Channels 13-20=4.5.	3600	1820
Initial offset time from TIP to start of integration period (msec) ⁴	2.529	20.4	400	0
Difference between the TIP start to center of integration period of first FOV (msec)	2.5415	23.0	2200	910
Rotational rate during integration	6 cycles/sec	0	0	0
Space View				
Space view time (msec)	0.250	4800 ²	15600 ⁶	1820
Number of samples	10	48	4	1
Integration time/sample (msec)	0.025	Channel 1=5.1; Channels 2-12=1.8; Channels 13-20=4.5.	3600	1820
Total integration time (msec)	0.250	216	14400	1820
Internal Calibration Target (ICT) View(s)				
Internal calibration target(s) view time (msec)	0.250	Cold: 5600 ³ Warm: 5600 ³	15600 ⁶	1820
Number of samples	10	56	4	1
Integration time/sample (msec)	0.025	4.5	3600	1820
Total integration time (msec)	0.250	256	14400	1820
Ground Resolution ⁵				
IFOV diameter at nadir (km)	1.1	HIRS/2: 17.7 HIRS/2I: 20.4	147.5	109.9
IFOV at center of outer FOV (km)	6.2 x 2.3	HIRS/2: 59.5 x 30.4	243.9 x 183.4	356.4 x 175.8
		HIRS/2I: 68.3 x 34.8		
Half Swath Width ⁵				

Nadir to center of outer FOV (km)	1460.2	HIRS/2: 1089.4 HIRS/2I: 1089.4	604.2	816.8
Nadir to far edge of outer FOV (km)	1463.3	HIRS/2: 1119.8 HIRS/2I: 1124.4	736.3	1173.2
1	The earth view steps rapidly, then holds at each position while the 20 filter segments are sampled. Multispectral data from one visible, seven shortwave, and twelve longwave are obtained.			
2	The space views position is held while the 20 filter segments are sampled 48 sequential times.			
3	The ICT view positions are held while the 20 filter segments are sampled 56 sequential times.			
4	Time offsets from TIP first major frame time to the center of the first FOV when all instruments are at the beginning of scan (every 128 seconds).			
5	All earth dimensions are based on a 833 km height above a spherical earth of radius 6371.22 km.			
6	The space and ICT view sequences are performed every 256 seconds and last 32 seconds. This is followed by 7 cycles of earth view sequences (each lasting 32 seconds).			
7	HIRS/2I was flown on NOAA-14 only.			
8	Dead time is defined as the non-integration time needed for reflector slewing and/or transferring of data.			

Table J-2. NOAA Satellite Scanning Instrument Parameters for NOAA KLM and NOAA-N, N'.							
	AVHRR/3	HIRS/3	HIRS/4	AMSU			MHS
				-A1	-A2	-B	
IFOV (Degrees)	0.0745	1.40	0.69	3.3	3.3	1.1	1.1
Full scan period (seconds)	0.1667	6.4	6.4	8	8	2.67	2.67
Earth View							

Total number of earth view steps	2048	56	56	30	30	90	90
FOV Step angle (Degrees)	0.0541 ⁶	1.8	1.8	3 ¹ / ₃	3 ¹ / ₃	1.1	1.1111
Max scan angle (Degrees from Nadir to the center of outer earth FOV)	55.37 ⁶	49.5	49.5	48.33	48.33	48.95	49.4444
Total earth view time (msec)	51.2	5600 ¹	5600 ¹	6075	6075	1620	1710
FOV integration time + dead time (msec) ⁷	0.025	100	100	202.5	202.5	19	19
Integration period/FOV (msec)	0.025	Channel 1=5.1; Channels 2-12 = 1.8; Channels 13-20 = 4.5.	Channel 1=5.1; Channels 2-12 = 1.8; Channels 13-20 = 4.5.	165	158	18	19
Initial offset time from TIP to start of integration period (msec) ⁴	2.529	20.4	20.4	3.55	3.26	-9	-38 ⁸
Difference between the TIP to center of integration period of first FOV (msec)	2.5415	23.0	23	86.05	82.26	9	-28.5
Rotational rate during integration	6 cycles/sec	0	0	0	0	1 rad/sec	1rad/sec
Space View							
Space view time (msec)	0.250	4800 ²	4800 ²	365	365	75	76

Number of integration samples	10	48	48	2	2	4	4
Integration time (msec)	0.025	Channel 1=5.1; Channels 2-12 = 1.8; Channels 13-20 = 4.5.	Channel 1=5.1; Channels 2-12 = 1.8; Channels 13-20 = 4.5.	165	158	18	19
Total integration time (msec)	0.250	216	216	330	316	72	76
Internal Calibration Target (ICT) View							
Internal calibration target view time (msec)	0.250	5600 ³	5600 ³	365	365	75	76
Number of integration dwells	10	56	56	2	2	4	4
Integration time/dwell (m/sec)	0.025	Channel 1=5.1; Channels 2-12 = 1.8; Channels 13-20 = 4.5.	Channel 1=5.1; Channels 2-12 = 1.8; Channels 13-20 = 4.5.	165	158	18	19
Total integration time (msec)	0.250	252	252	330	316	72	76
Ground Resolution⁵							
IFOV diameter at nadir (km)	1.1	20.4	10.2	48.05	48.05	16.0	16
IFOV at center of outer FOV (km)	6.24 x 2.3	68.3 x 34.8	34.15 x 17.4	149.1 x 79.4	149.1 x 79.4	51.6 x 26.9	51.6 x 26.9
Half Swath Width⁵							

Nadir to center of outer FOV (km)	1460.2	1089.4	1089.4	1034.8	1034.8	1063.1	?
Nadir to far edge of outer FOV (km)	1463.3	1124.4	1107.325	1113.4	1113.4	1089.4	?
1	The earth view steps rapidly, then holds at each position while the 20 filter segments are sampled. Multispectral data from one visible, seven shortwave, and twelve longwave are obtained.						
2	The space views position is held while the 20 filter segments are sampled 48 sequential times.						
3	The ICT view position is held while the 20 filter segments are sampled 56 sequential times.						
4	Time offsets from TIP first major frame time to the center of the first FOV when all instruments are at the beginning of scan (every 128 seconds).						
5	All earth dimensions are based on a 833 km height above a spherical earth of radius 6371.22 km.						
6	NOAA-16 has a max scan angle of 55.25 degrees with a step angle of 0.053981436 degrees.						
7	Dead time is defined as the non-integration time needed for reflector slewing and/or transferring of data.						
8	MHS data is delayed 2 scan periods for data handling overhead prior to the TIP time stamp.						

J.1 AVHRR/3

The AVHRR/3 is an imaging system in which a small field of view (1.3 milliradians by 1.3 milliradians) is scanned across the earth from one horizon to the other by continuous 360 degree rotation of a flat scanning mirror. The orientation of the scan lines are perpendicular to the spacecraft orbit track and the speed of rotation of the scan mirror is selected so that adjacent scan lines are contiguous at the subsatellite (nadir) position. The analog data output from the sensors is digitized on board the satellite at a rate of 39,936 samples per second per channel. Each sample step corresponds to an angle of scanner rotation of 0.95 milliradians. At this sampling rate, there are 1.362 samples per IFOV. A total of 2048 samples will be obtained per channel per Earth scan, which will span an angle of ± 55.4 degrees from the nadir (subpoint view). All six spectral channels of the AVHRR/3 are registered so that they all measure energy from the same spot on the earth at the same time.

As with earlier versions of the AVHRR instrument, the GAC processing of the AVHRR/3 data makes the frame rates directly compatible by only using the data from every third AVHRR/3 scan. The data are further reduced by averaging the value of four adjacent samples and skipping one sample of each channel of AVHRR data across each scan line used. Figure J.1-1 shows the relationship of GAC and LAC data, while Figure J.1-2 shows the signal position as a function of scan angle for the AVHRR/3 instrument.

Figure J.1-1. Simulated Earth Surface Footprint of GAC and LAC Data.

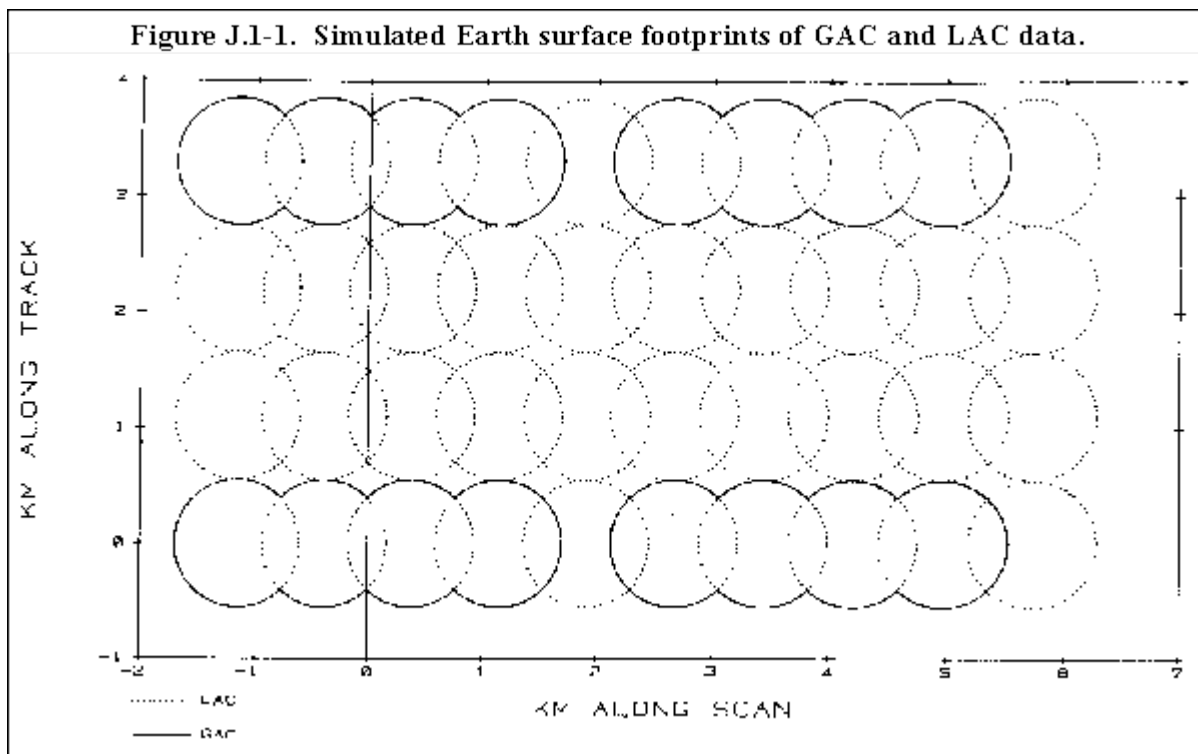

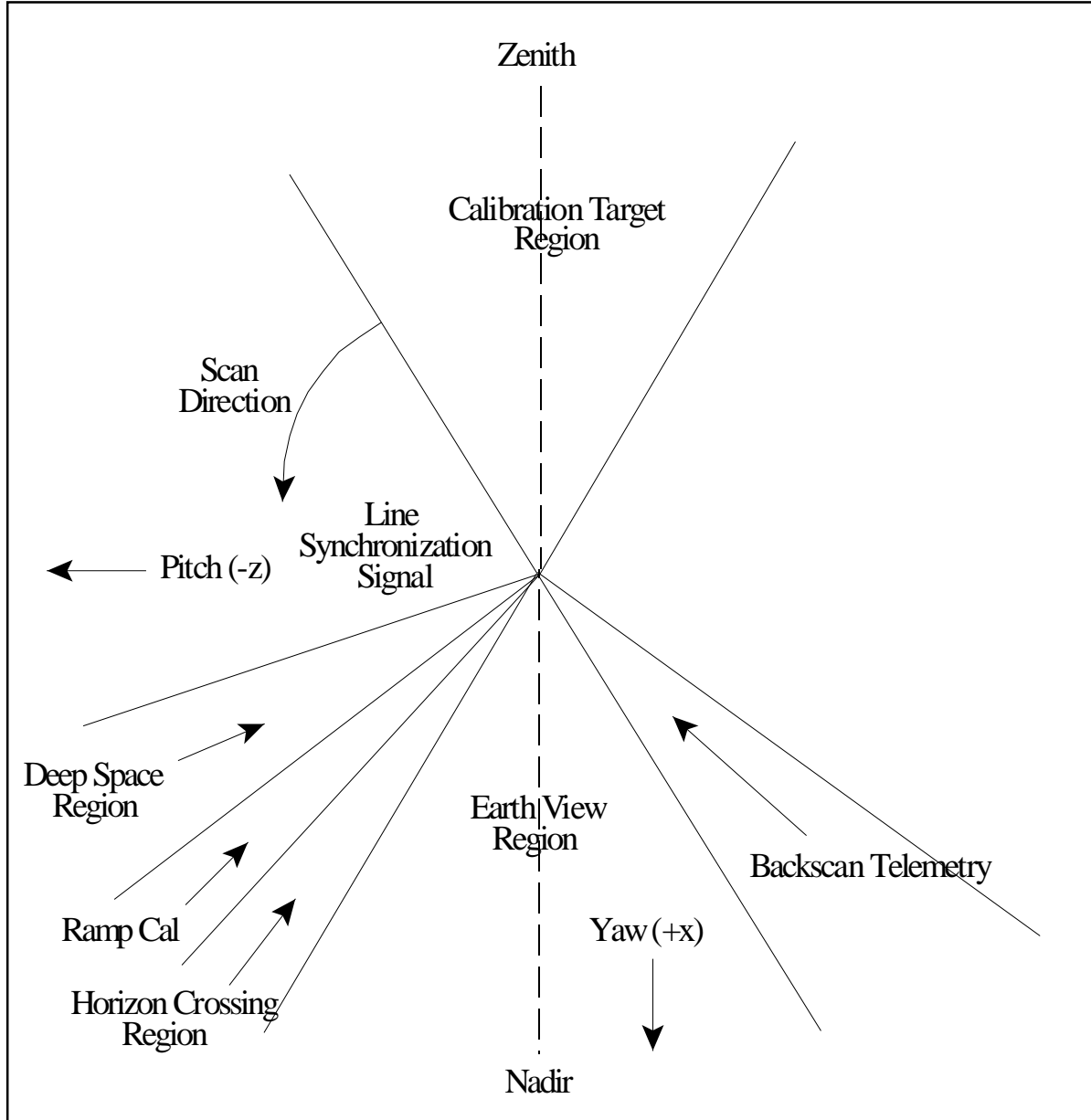

Figure J.1-2. AVHRR/3 Signal Position as a Function of Scan Angle.

J.2 HIRS/3 and HIRS/4

The High Resolution Infrared Radiation Sounder (HIRS/3 and HIRS/4) is a discrete stepping, line-scan instrument. An elliptical scan mirror provides cross-track scanning of 56 increments of 1.8 degrees. The mirror steps rapidly (<35 msec), then holds at each position while the 20 filter segments are sampled. This action takes place each 100 msec. The instantaneous HIRS/3 FOV

for each channel is approximately 1.4 degrees in the visible and shortwave IR, and 1.3 degrees in the longwave IR band which, from an altitude of 833 kilometers, encompasses an area of 20.3 kilometers and 18.9 kilometers in diameter, respectively, at nadir on the Earth. The instantaneous HIRS/4 FOV for each channel is approximately 0.69 degrees in the visible, shortwave and longwave IR bands which, from an altitude of 833 kilometers, encompasses an area of 10.005 kilometers in diameter at nadir on the Earth.

Figure J.2-1 shows the Earth scan pattern and the angular locations of the calibration targets relative to Earth scan for the HIRS/3 and HIRS/4 instrument. Figures J.2-2 and J.2-3 show the simulated earth-surface footprints for HIRS/3 and HIRS/4; and AMSU-A for a half scan and a full scan, respectively. Note: the scan mirror step size remains at 1.8 degrees per step for HIRS/3 and HIRS/4, so Figures J.2-2 and J.2-3 indicate the correct footprint position. However, the FOV of the HIRS/4 instrument is halved, so the footprint diameter for HIRS/4 will be half that of HIRS/3.

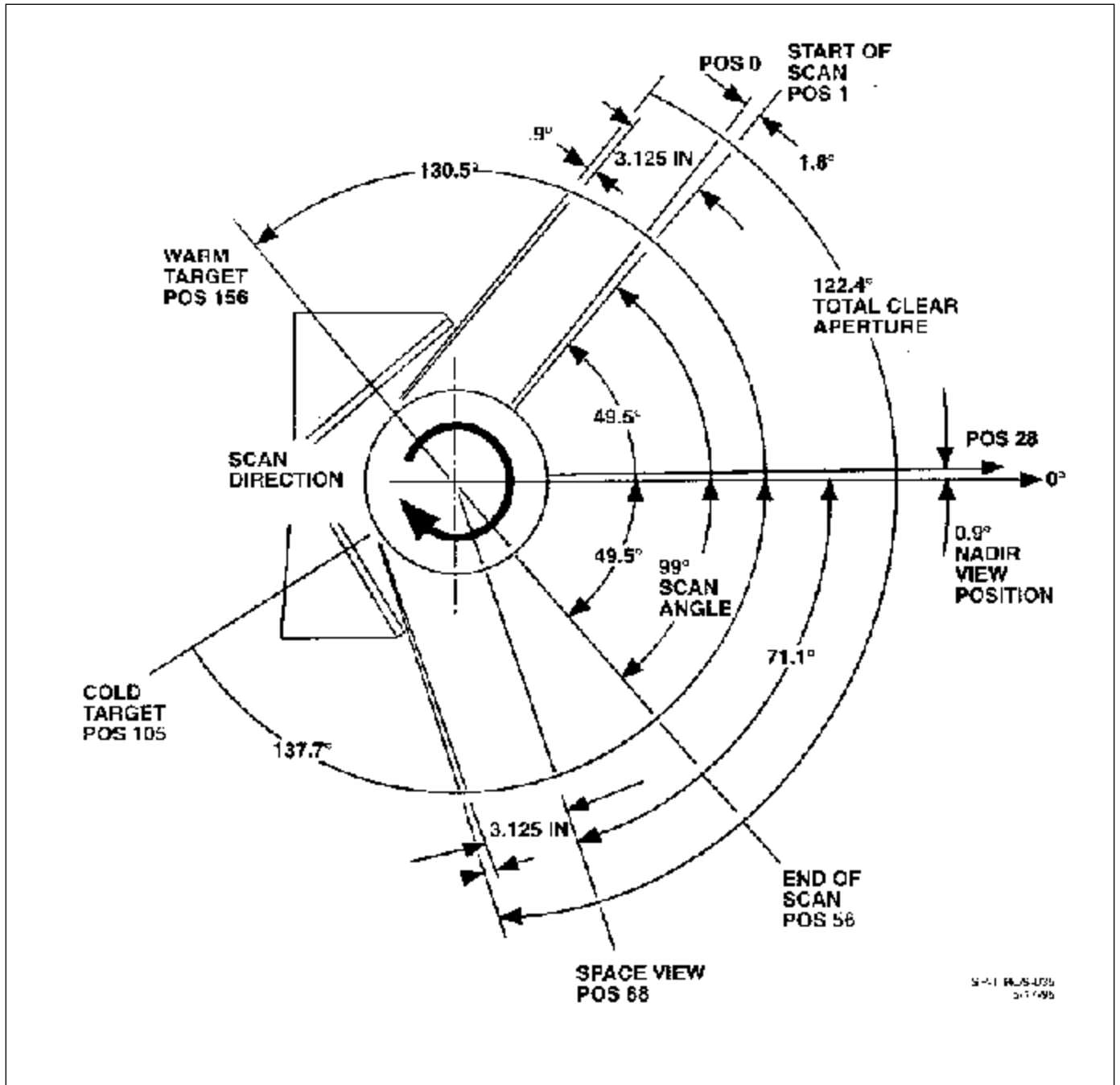

Figure J.2-1. Scan Angles for HIRS/3 and HIRS/4 Instruments

Figure J.2-2. Simulated Earth-surface footprints for HIRS/3 and AMSU-A (detail), half-scan.

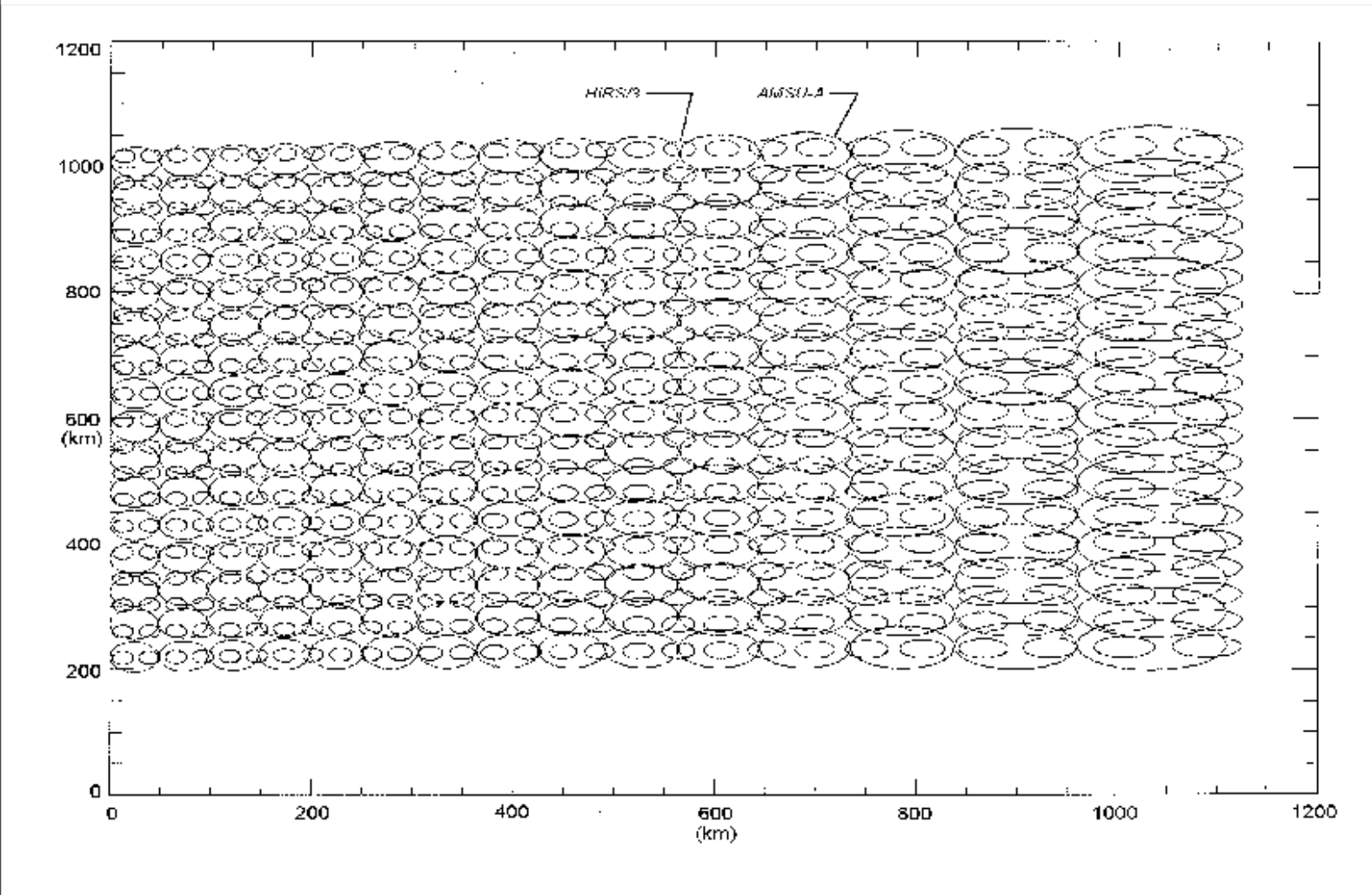

Figure J.2-2. Simulated Earth-surface Footprints for HIRS/3, HIRS/4 and AMSU-A (Detail), Half-Scan.

Figure J.2-3. Simulated Earth-surface footprints for HIRS/3 and AMSU-A, full scan.

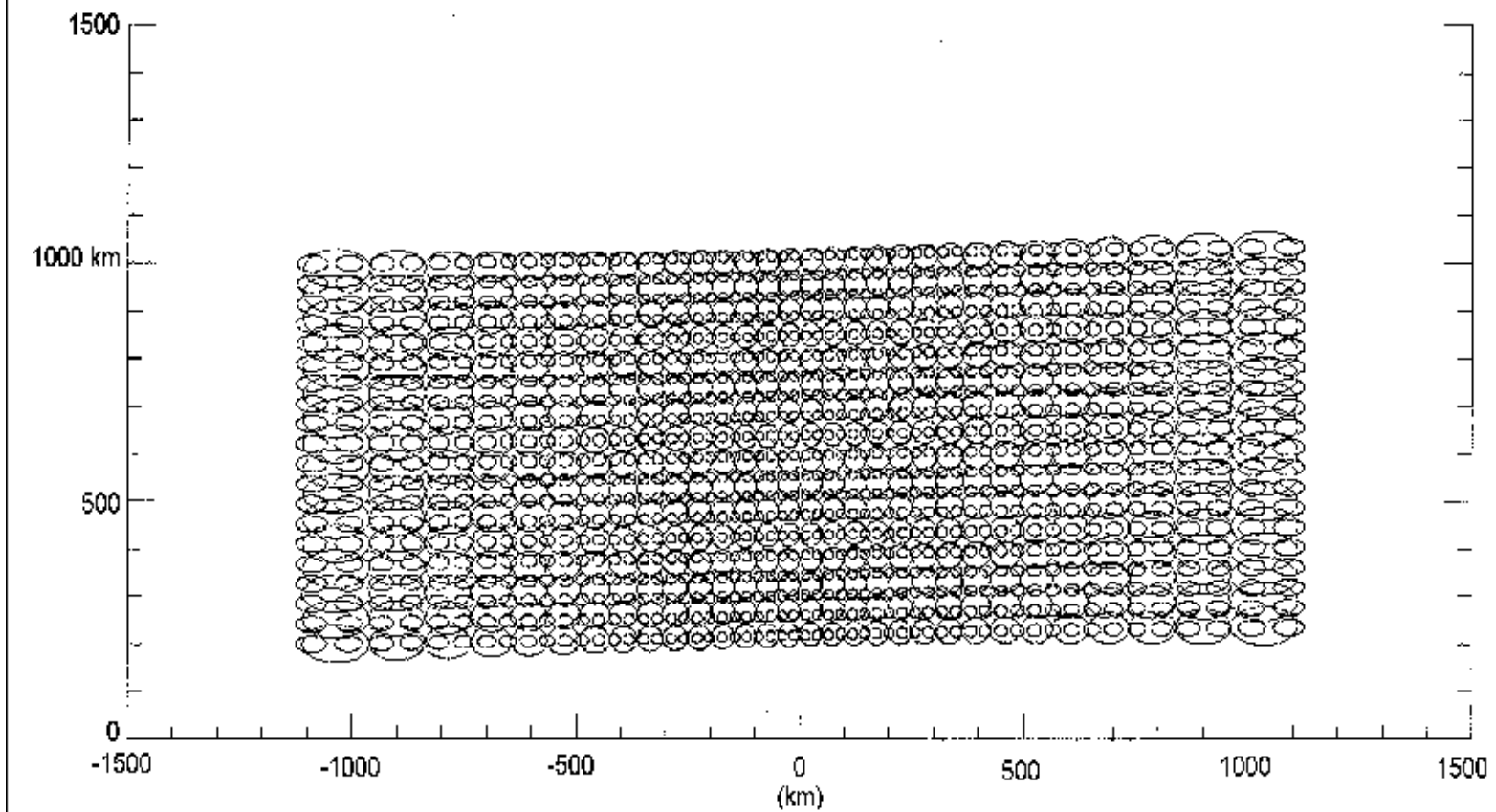

Figure J.2-3. Simulated Earth-Surface Footprints for HIRS/3, HIRS/4 and AMSU-A, Full Scan.

J.3 NOAA-KLM and NOAA-N, N' Microwave Instruments

Table J.3-1 contains a summary of scan initiation and FOV information for the microwave instruments.

Table J.3-1. Synopsis of Microwave Scan Initiation and FOV Information.						
Instrument	Scan Period (seconds)	Integration Start Delay after 8 sec sync pulse (ms)	IFOV + dead time² (ms)	Earth Pixel integration period (ms)	IFOV (degrees)	Separation between adjacent Earth IFOVs (degrees)
AMSU-A1	8	+3.55	202.516	165	3 3/10	3 1/3
AMSU-A2	8	+3.26	202.50	158	3 3/10	3 1/3
AMSU-B	8/3	-9 ¹	19	18	1 1/10	1 1/10
MHS	8/3	0 ³	19	19	1 1/10	1 1/9

Notes:

AMSU-A1 and AMSU-A2 are a step and stare instrument. AMSU-B is a continuous slew instrument.

1 On receipt of the 8 second sync pulse, the AMSU-B FOV will be at Cell 1 centered with its integration period half completed.

2 Dead time defined as the non-integration time needed for reflector slewing and/or transferring of data.

3 MHS data is delayed 2 scan periods (5 2/3 seconds) because of spacecraft and instrument data handling. Level 1b geo-locations are corrected for this data. HRPT data does not adjust for the delay.

AMSU-A is a cross-track, line-scanned instrument designed to measure scene radiances in 15 discrete frequency channels. At each channel frequency, the antenna beamwidth is a constant 3.3 degrees (at the half power point). Thirty contiguous scene resolution cells are sampled in a stepped-scan fashion (i.e., the instrument's FOV rotates to a data collection position, stops, collects data, then moves to the next collection position, stops, collects data, etc.) every eight seconds, each scan covering 50 degrees on each side of the subsatellite path. The AMSU-A

instrument starts at earth position 1, then goes sequentially to earth position 30, then to the cold calibration view position and then to the warm load view position (See Figure J.3-1). These scan patterns and geometric resolution translate to a 50 km diameter cell at nadir and a 2,343 km swath width from the 833 km nominal orbital altitude.

In the step scan, the AMSU-A antenna steps and stops at each beam position for a period equal to the sample period, plus a settle time, sufficient to insure a maximum jitter (percentage overshoot/undershoot of the antenna step). For AMSU-A1, a jitter up to +10% is allowed for any 10 ms period in the first .33 of the step period. Otherwise, the jitter will be less than or equal to $\pm 5\%$. For AMSU-A2, a jitter up to +10% is allowed for any 20 ms period in the first .33 of the step period. Otherwise, the jitter will be less than or equal to $\pm 5\%$. The step time for the 30 earth view beam positions will be equal.

Each channel of the AMSU-A instrument is considered to form a beam. All main beam axes of the AMSU-A will be coincidental, i.e., they will be pointing in the same direction at the same time for any given beam position. In the following paragraphs, if only one beam is discussed, it is inferred to represent any and all beams.

The AMSU-A beams will have cross-track scanning. All beams will scan in a plane perpendicular to the spacecraft orbital velocity vector. Note: The spacecraft velocity vector is pointing in the direction towards the reader (out of the page). The sense of the scan will be counterclockwise as one looks along the spacecraft orbital velocity direction (i.e., the antenna scans from the sun direction through nadir to the cold space direction and repeats as shown in Figure J.3-1).

The AMSU-A beams will scan the earth viewing sector a total of 96.66 degrees (± 48.33 degrees from nadir) on beam centers. There will be a total of 30 beam positions (30 resolution cells on the earth surface), to be called cell numbers 1 through 30, from sun to antisun. There will be 15 cells on either side of nadir. The beam center position of each cell is separated from the adjacent cell along the scan direction by 3.33 degrees (there will be a non-cumulative step tolerance of ± 0.04 degrees).

There will be four beam positions selectable by command, to provide a cold (space look) calibration position. The primary cold calibration beam position will nominally be at 6.66 degrees from the sun X velocity plane in the nadir direction. The three alternate cold calibration positions will nominally be at 8.33, 10.00 and 13.33 degree declinations.

The location of the beam positions (earth viewing) in time with respect to the frame synchronization pulse for AMSU-A1 and AMSU-A2 are illustrated in Figures J.3-2 and J.3-3, respectively.

Figure J.3-1. AMSU-A Scanning Characteristics.

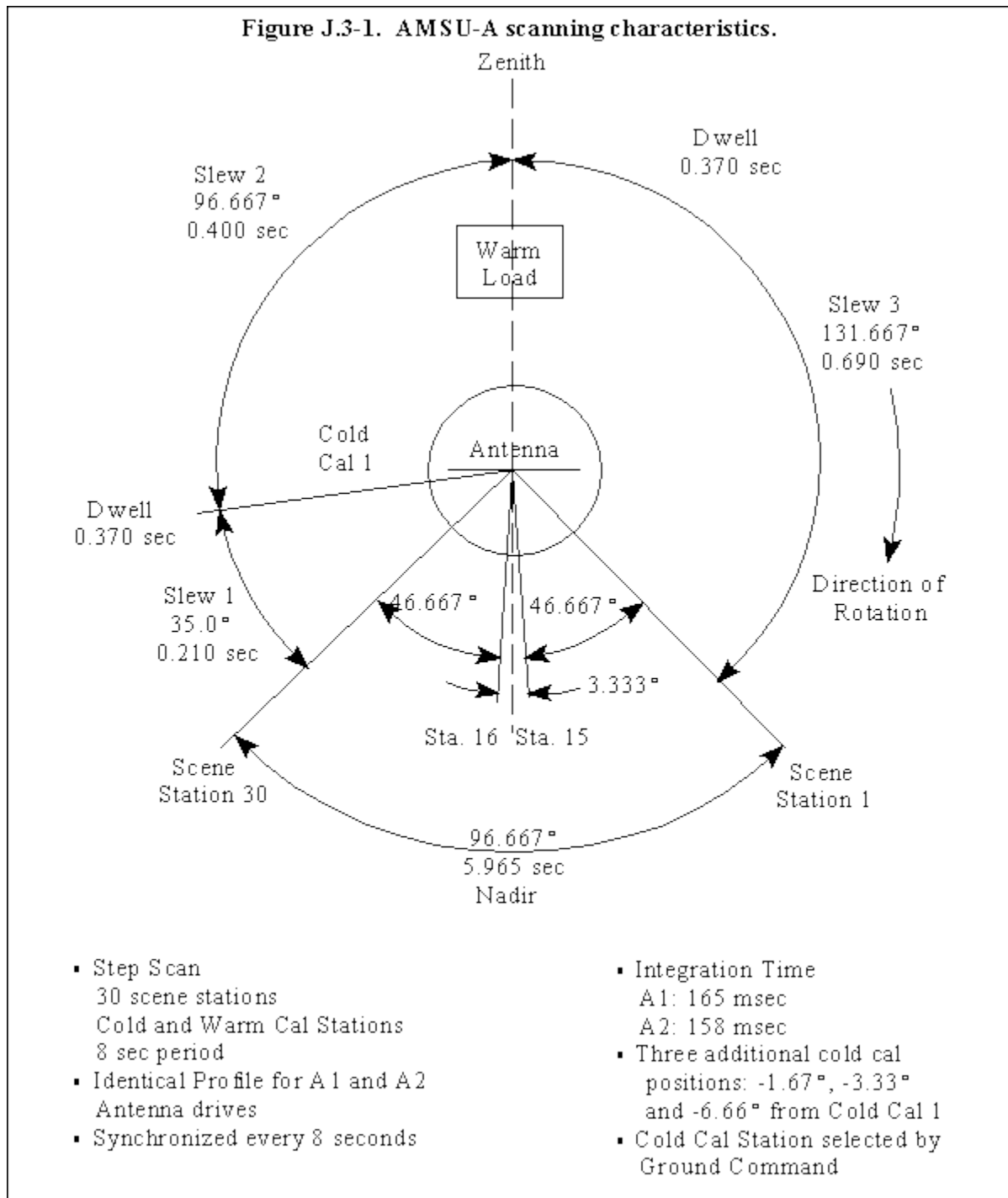

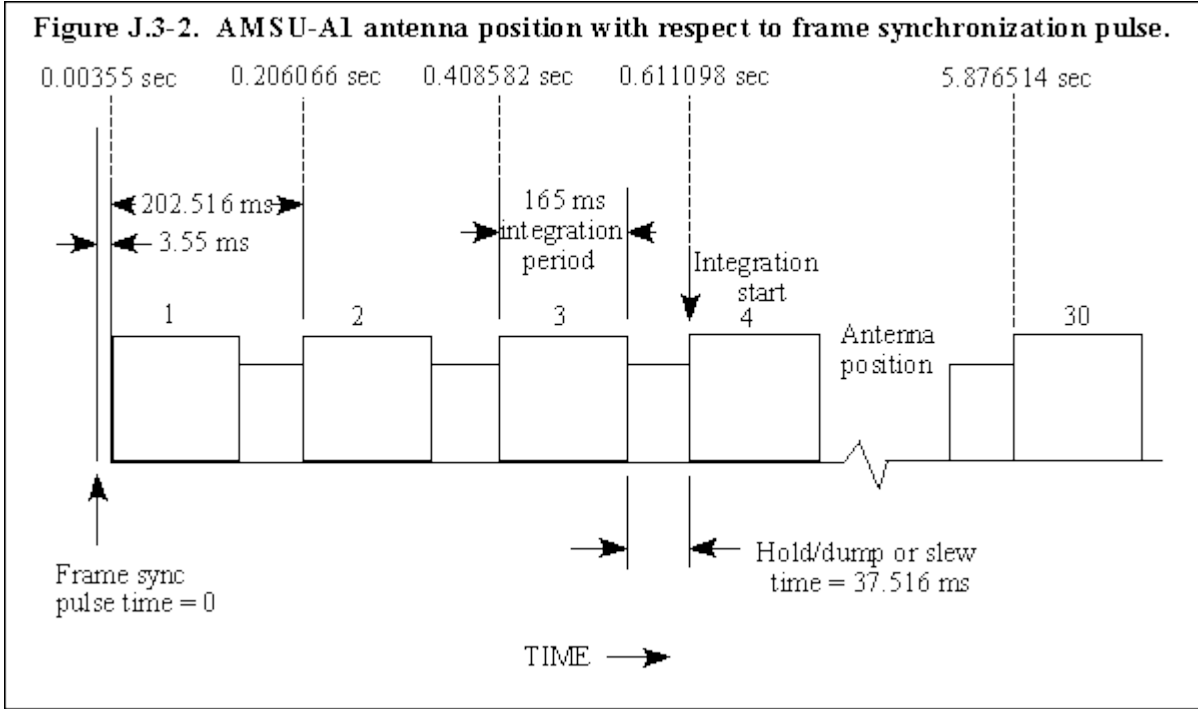

Figure J.3-2. AMSU-A1 Antenna Position with Respect to Frame Synchronization Pulse

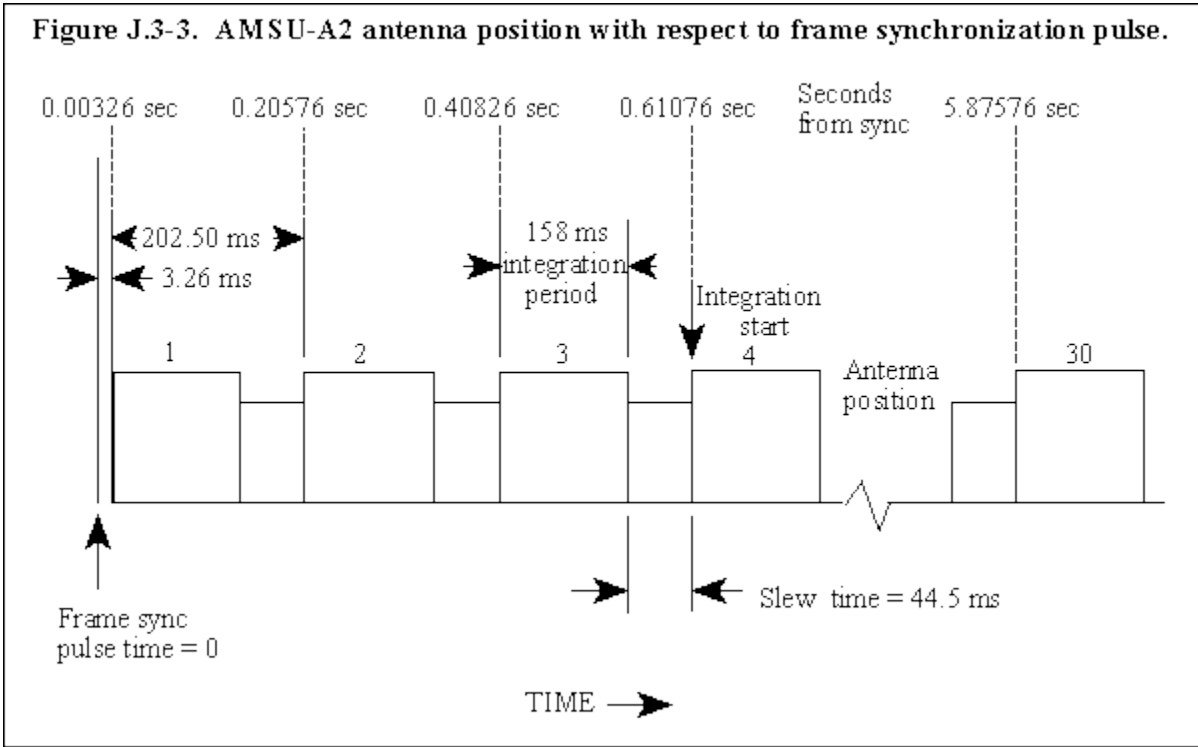

Figure J.3-3. AMSU-A2 Antenna Position with Respect to Frame Synchronization Pulse

AMSU-B is a cross-track, line scanned instrument designed to measure scene radiances in 5 channels. At each channel frequency, the antenna beamwidth is a constant 1.1 degrees (at the half power point). Ninety contiguous scene resolution cells are sampled in a continuous fashion, each scan covering 50 degrees on each side of the subsatellite path. These scan patterns and geometric resolution translate to a 16.3 km diameter cell at nadir at a nominal altitude of 850 km. Figure J.3-4 shows the size of the AMSU-B footprint over the entire Earth scan.

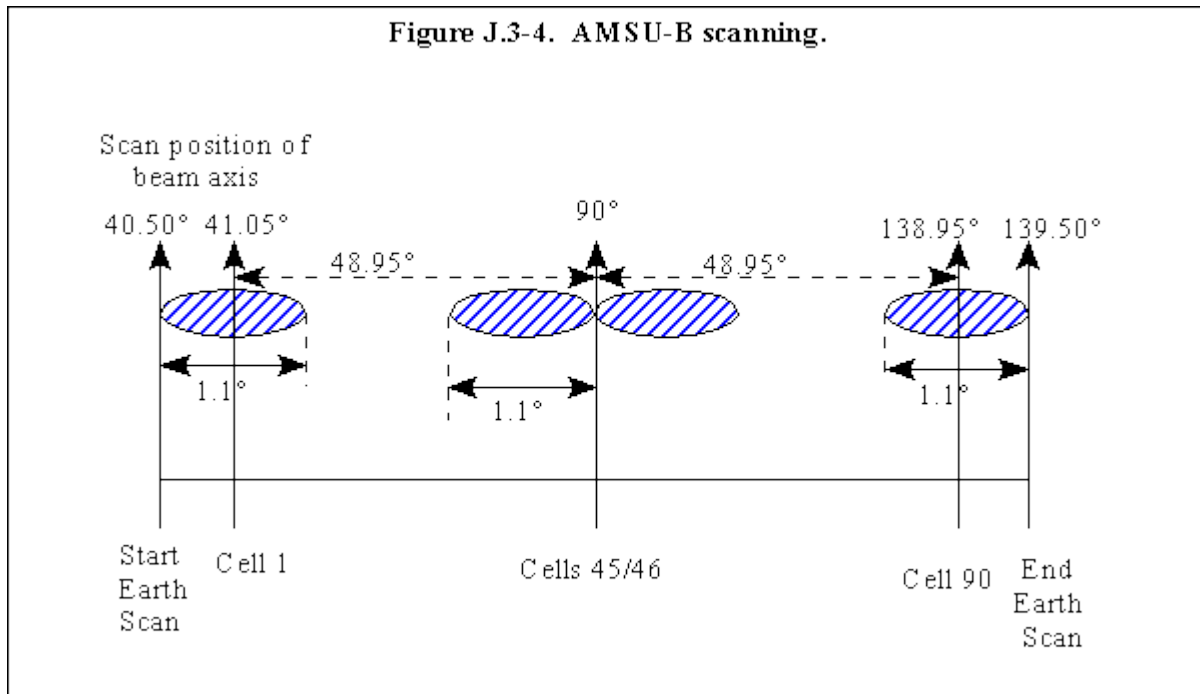

Figure J.3-4. AMSU-B Scanning.

All antenna beams for AMSU-B scan in a plane perpendicular to the instrument's baseplate, containing nadir in the x-z plane. The maximum deviation from the scan plane will be less than or equal to 0.1 degrees. The direction of scan motion is from Sun (+z) to nadir (+x) to anti-Sun side (-z). During earth scan, the cross track motion will be continuous with the angular velocity constant to within $\pm 2\%$. All antenna beams will scan ± 48.95 degrees about nadir with reference to the beam axis. The scan period will be $8/3$ seconds, in order to maintain a relationship with the AMSU-A scan pattern. The scan plane and motion for the AMSU-B instrument are shown in Figure J.3-5.

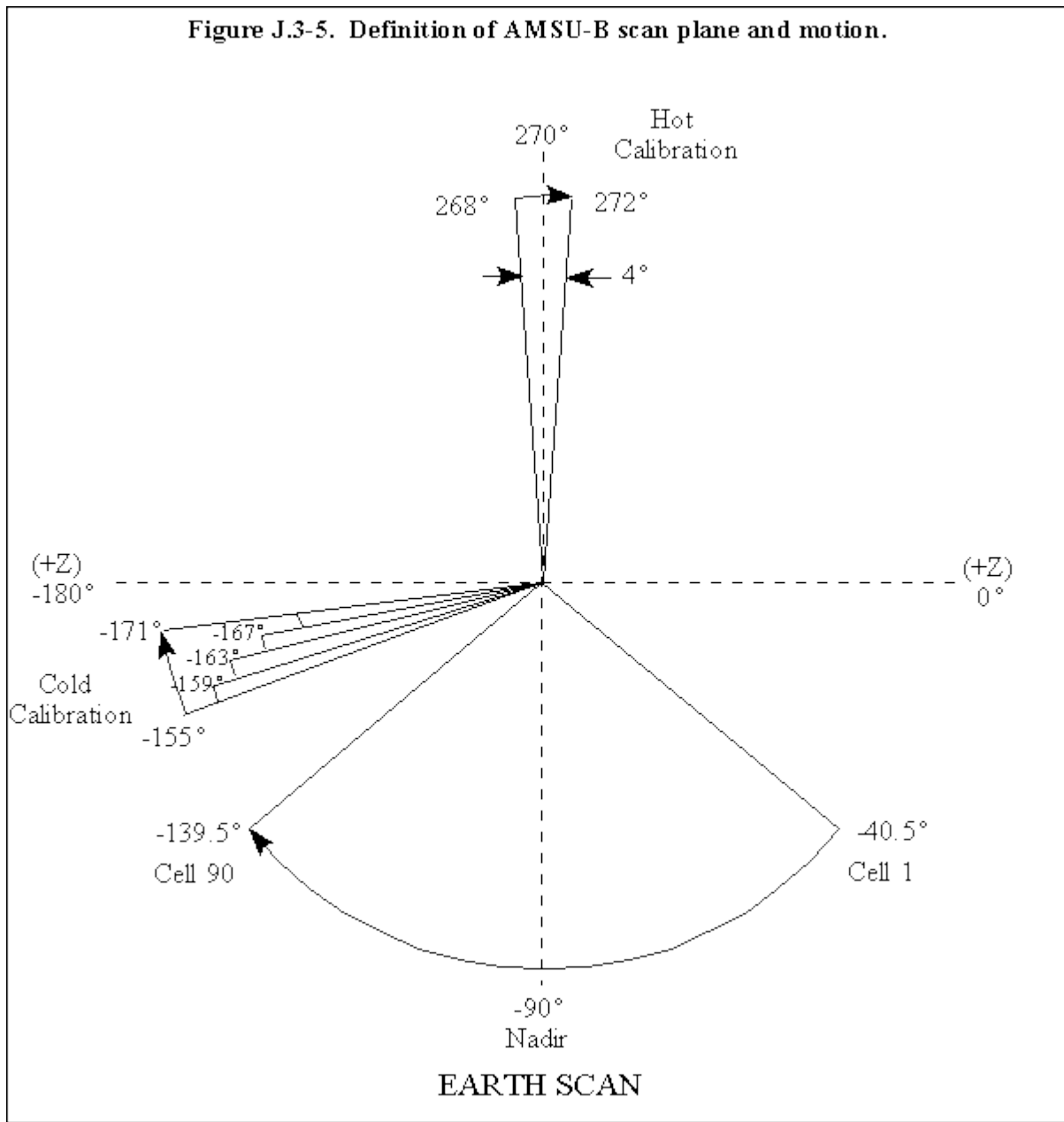

Figure J.3-5. Definition of AMSU-B Scan Plane and Motion

The Microwave Humidity Sounder (MHS) is a self-calibrating microwave radiometer, observing the Earth with a field of view of ± 50 degrees across nadir, in five frequency channels of the millimeter-wave band (89-190 GHz). MHS, together with the complementary AMSU-A instruments, provides the operational microwave sounding capability for the NOAA-N, -N' meteorological satellites.

MHS is a cross-track, line-scanned instrument. Ninety contiguous scene resolution cells are sampled in a continuous scan, covering 49.44444... degrees on each side of the sub-satellite path, with an antenna beam width of 1.11111... degrees at half power point. These scan patterns and geometric resolution translate to a 17-km diameter cell at nadir from the 870 km nominal orbital altitude.

In scan mode, the MHS reflector performs the scan profile. This is a predefined position versus time profile which incorporates the Earth view and the two calibration targets, as shown in

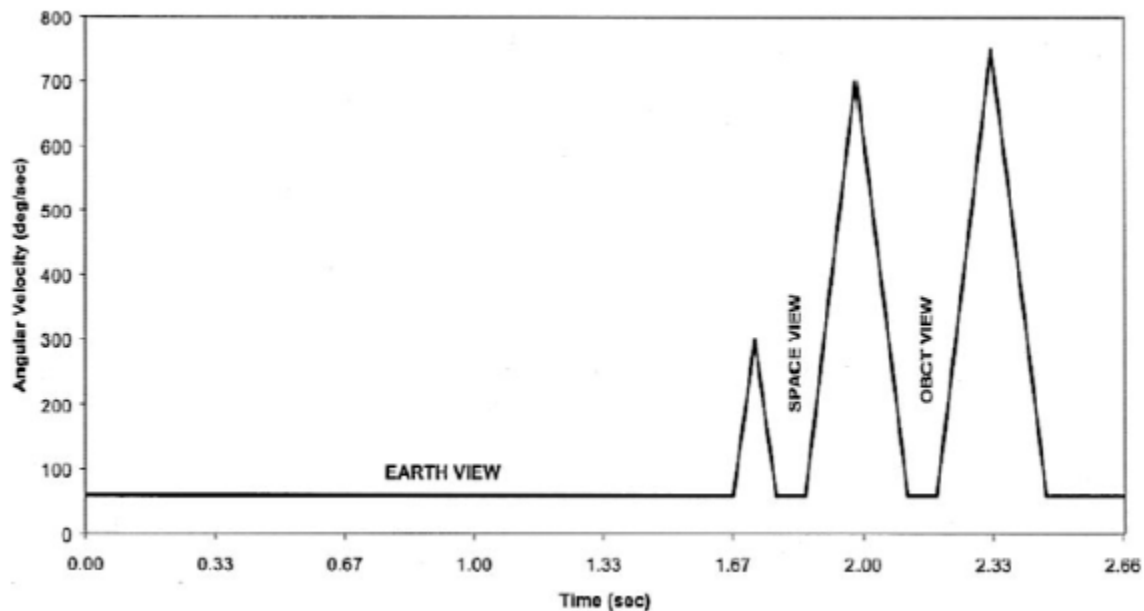

Figure J.3-6. MHS Scan Profile Velocity versus Time

Figures 3.9.2.2-1 and J.3-6. Three predefined profiles are provided: profiles 0, 1 and 2; and these are the same except for small changes in the position of the Space view.

J.4 SBUV/2

The SBUV/2 instrument is a nadir pointing nonspatial scanning instrument sensitive to radiation in the 160 to 400 nm ultraviolet spectrum. The overall radiometric resolution is approximately 1 nm in this spectral band. The SBUV instrument optical hardware and main electronics are carried in two modules. The Sensor Module (SM) contains the optical elements and detectors while the Electronics Module (ELM) houses the main electronics and power supplies.

The use of a deployable diffuser in the SM gives the instrument the versatility of selecting between solar and earth measurements. With the diffuser stowed, the instrument views the earth directly. The data from this configuration corresponds to earth radiance. With the diffuser deployed into the “Sun” position, the detector output measurements correspond to solar irradiation data. Ground and in flight calibration data are used to convert the detector data and diffuser mode data to solar irradiation or earth radiance units.

The SM houses the monochromator optical hardware (see Figure J.6-1) which uses a movable grating to select the wavelength where measurements will be made. The grating mechanism can be commanded to any one of 8,192 positions giving the monochromator approximately 0.1 nm wavelength resolution. Commands which correspond to grating positions come from a Read Only Memory (ROM). Data read from the ROM correspond to 12 discrete wavelength positions in the “Discrete” mode. In the “Sweep” mode, the ROM data is simply a grating position corresponding to the wavelength where the sweep will start.

The photo multiplier tube (PMT) in the monochromator has a very large dynamic range (greater than 120 db). This range is transmitted in 3 ranges requiring a total of .75 seconds for stepping and settling of the grating to a new position and 1.25 seconds of integrating time before transmission, when the instrument is in this “Discrete” grating mode.

In the “Sweep” mode, the grating is stepped every 50 ms and the PMT signal is integrated (while the stepping continues) for 100 ms before transmission.

The Cloud Cover Radiometer (CCR) has a fixed 379 nm filter for wavelength selection and is co-aligned to the monochromator; therefore, it views the same scene as the monochromator. The output of the CCR represents the amount of cloud cover in a scene, as the name implies, and is used to remove the effects of clouds in the monochromator data. CCR data is transmitted once per second in both Discrete and Sweep modes.

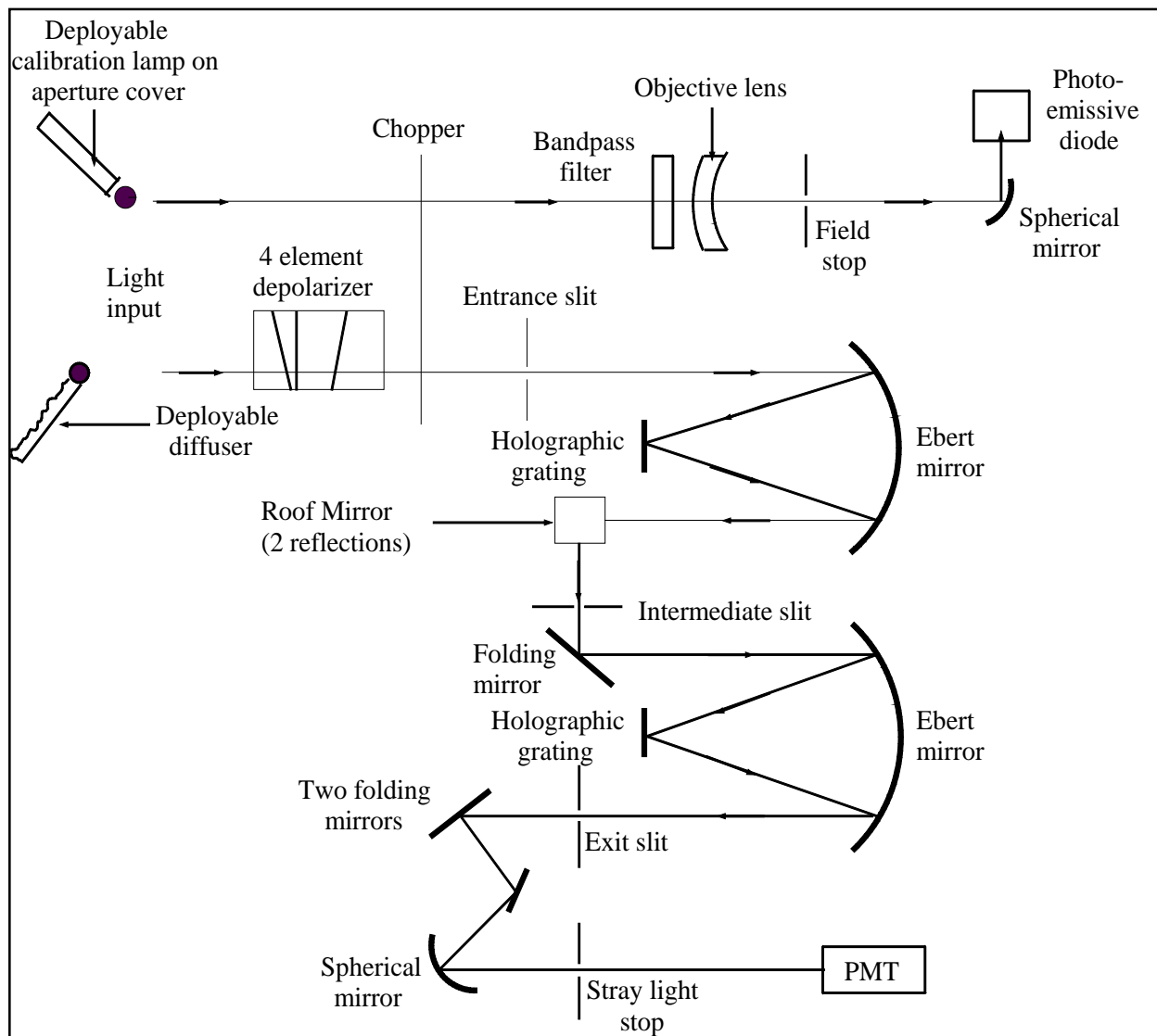

Figure J.4-1. Simplified Optical Path of SBUV/2 Instrument

APPENDIX K: CONVERSION OF BLACKBODY TEMPERATURES TO AVHRR RADIANCES

The radiance N sensed in a particular channel from a blackbody at temperature T is the weighted mean of the Planck function over the spectral response function of the channel:

$$N(T) = \frac{\int_{\nu_1}^{\nu_2} B(\nu, T) \Phi(\nu) d\nu}{\int_{\nu_1}^{\nu_2} \Phi(\nu) d\nu} \quad (\text{K-1})$$

where ν ; is the wavenumber (cm^{-1}), Φ is the spectral response function, and ν_1 and ν_2 are its lower and upper limits, respectively. The Planck function $B(\nu, T)$ is given by,

$$B(\nu, T) = \frac{c_1 \nu^3}{e^{\left(\frac{c_2 \nu}{T}\right)} - 1} \quad (\text{K-2})$$

constants c_1 and c_2 are $1.191042869 \times 10^{-5} \text{ mW}/(\text{m}^2 \cdot \text{sr} \cdot \text{cm}^{-4})$ and $1.4387770 \text{ K} \cdot \text{cm}$, respectively. (The use of these constants was recommended by the Committee on Data for Science and Technology (CODATA) of ICSU in 2010. However, NESDIS may still be using the constants that were formally adopted early in 2002 from the CODATA put forth in 1998.

For the AVHRR, Equation 2 is evaluated numerically by,

$$N(T) = \frac{\sum_{i=1}^n B(\nu_i, T) \Phi(\nu_i) \Delta \nu}{\sum_{i=1}^n \Phi(\nu_i) \Delta \nu} \quad (\text{K-3})$$

For all NOAA satellites, NESDIS has used Equation 3 to generate look-up tables relating blackbody temperature to AVHRR radiance. For each thermal channel, there is one table which specifies the radiance at every tenth of a degree Kelvin for temperatures in the 180K to 340K range. These tables, containing 1701 (temperature, radiance) pairs for each channel, are the standards. For convenience and data compression purposes, NESDIS now provides users of NOAA-15 (and later satellites in that series) AVHRR thermal channel data with a much simpler equation that approximates the values in a look-up table very accurately. This is the two-step equation found in Section 7.1.2 of the main text for converting blackbody temperature to AVHRR radiance and vice-versa. The RMS difference between the approximate value from the Section 7.1.2 equation and the look-up table value is generally less than 0.01K, when expressed in units of equivalent blackbody temperature.

APPENDIX L: REFERENCES

Please note: no attempt has been made to add any new references since the last review on December 2006.

AVHRR S/N A306 Alignment/Calibration Handbook and Optical Data, by ITT Industries (Report 8172845, Rev B), January 2002.

AVHRR S/N A306 Alignment/Calibration Handbook, by ITT Industries (Report 8189613, Rev C), August 2003.

Ball Specification Compliance and Calibration Data Book for Flight Model 4, June 1991: S/N 005 SBUV/2, Ball Document # B6802-101, Boulder CO.

Brown, O.W., J.W. Brown, and R.H. Evans, 1985: *Calibration of the Advanced Very High Resolution Radiometer*, J. Geophys. Res., **90** (11), 677.

Cohen, E.R and B.N. Taylor, August 1997: *The Fundamental Physical Constants*, Physics Today, Buyers' Guide, 9-13.

Escobal, Pedro R., 1965: *Methods of Orbit Determination*, John Wiley, New York, p. 30.

Heidinger, A. K., C. Cao, and J. T. Sullivan, 2002: *Using MODIS to calibrate AVHRR reflectance channels*, J. Geophys. Res. - Atmosphere, in press.

Hilsenrath, E., R.P. Cebula, M.T. Deland, K. Laamann, S. Taylor, C. Wellemeyer, and P.K. Bhartia, 1995: *Calibration of the NOAA-11 Solar Backscatter Ultraviolet (SBUV/2) Ozone Data Set from 1989 to 1993 using In-Flight Calibration Data and SSBUV*, J. Geophys. Res., **100**, 1351-1366.

HIRS/4 H305 Alignment/Calibration Handbook, submitted by ITT Industries (Report 8168951, Rev E), May 2003.

Instruction Manual and Alignment/Calibration Handbook and Optical Data, submitted to NASA/GSFC by ITT Aerospace/Communications (Report 8172836, Rev A), October 1997.

Instruction Manual and Alignment/Calibration Handbook and Optical Data, submitted to NASA/GSFC by ITT Aerospace/Communications (Report 8162681, Rev B), July 1999.

Janssen, M, editor, 1993: *Atmospheric Remote Sensing by Microwave Radiometry*, John Wiley & Sons, New York, New York.

Kigawa, Seiichiro and Tsan Mo, 2002: *An Algorithm for Correction of Lunar Contamination in AMSU-A Data*, NOAA Technical Report NESDIS 111, December 2002.

Maury, J.L. and G.P. Brodsky, 1969: *Cowell Type Numerical Integration as Applied to Satellite Orbit Computation*, Goddard Space Flight Center Report X-553-69-46, also NASA Report NASA-TM-X-63542, December 1969.

Meeus, Jean, 1991: *Astronomical Algorithms*, Willmann-Bell, Richmond, Virginia, p. 32.

Mo, Tsan, 1996: Prelaunch Calibration of the Advanced Microwave Sounding Unit-A for NOAA-K, IEEE Trans. Microwave Theory and Techniques, 44, 1460-1469.

Mo, Tsan, 2002: An Algorithm for Correction of Antenna Temperature Errors due to the Anomaly in NOAA-17 AMSU-A Channel 3, NESDIS Internal Memorandum, August 2002.

Mohr, Peter J. and Barry N. Taylor, 1998: CODATA Recommended Values of the Fundamental Physical Constants, National Institute of Standards and Technology, Gaithersburg, MD 20899-8401

Moore, W. and P. Beandet, P., 1973: *The Testing of Fixed-step Numerical Integration Processes for the Cowell Method of Special Perturbations*, Proceedings of the Conference on the Numerical Solution of Ordinary Differential Equations, Springer Lecture notes in Mathematics, Vol. 362.

NASA and NESDIS Pamphlet, NOAA-K, 29 pp.

Neckel, H. and Labs, D., 1984, The solar radiation between 3300 and 12500 Angstroms, Solar Physics, Vol. 90, pp. 205-258.

Planet, Walter G. (Editor), revised October 1988, Data Extraction and Calibration of TIROS- N/NOAA Radiometers, NOAA Technical Memorandum NESS 107 Revision 1, 130 pp.

Rao, C.R.N., 1987: *Pre-Launch Calibration of Channels 1 and 2 of the Advanced Very High Resolution Radiometer*, NOAA Technical Report NESDIS 36, Department of Commerce, Washington, D.C.

Rao, C.R.N., J.T. Sullivan, C.C. Walton, J.W. Brown, and R.H. Evans, 1993: *Nonlinearity Corrections for the Thermal Infrared Channels of the Advanced Very High Resolution Radiometer: Assessment and Corrections*, NOAA Technical Report NESDIS 69, Department of Commerce, Washington, D.C.

Rao, C.R.N., and J. Chen, 1995: *Inter-satellite calibration linkages for the visible and near-infrared channels of the Advanced Very High Resolution Radiometer on NOAA-7, -9, and -11 spacecraft*, International Journal of Remote Sensing, **16**, 1931-1942.

The American Ephemeris and Nautical Almanac (1855-1980), United States Naval Observatory,

Nautical Almanac Office, Government Printing Office, Washington, D.C.

Weinreb, M.P., G. Hamilton, S. Brown, and R.J. Koczor, 1990: *Nonlinearity corrections in calibration of Advanced Very High Resolution Radiometer*, J. Geophys. Res., **95**, 7381-7388.

APPENDIX M: IMPLEMENTATION OF AMSU-B CORRECTION ALGORITHM

The NOAA-15 S-band antenna anomaly was attributed to a mismatch of materials. The STX-1, STX-2, and STX-3 high gain antennas were fabricated using a non-conductive center core with four conductive strips coiled around it. A metal transition tab was attached to an end of each strip and is used to complete the antenna's electrical path. Regrettably, the metal transition tab and the center core had very different thermal expansion properties. As the STX antennas went in and out of sun conditions the material mismatch condition caused these tabs to experience a small movement. These movements introduced stresses and the tabs eventually cracked due to metal fatigue. The antenna's electrical path was then compromised.

The lost NOAA-15 STX down link capability was successfully recovered through the use of an operational work-around (as described in this appendix). The satellite's data sources were switched to use differently designed antennas, the STX-2 omni and the STX-4 omni.

A corrective redesign to future NOAA satellite antennas was performed. Starting with NOAA-16 the antennas now include stress relief in critical areas and a change of materials to better match the thermal expansion properties. A flight quality antenna was fabricated and subjected to 3675 thermal cycles. No electrical performance degradation was noted. The tested antenna was then disassembled, inspected, and the design was confirmed for flight.

The AMSU-B instruments on NOAA-16 and NOAA-17 were modified before launch to augment the radio frequency shielding within the receiver. Therefore their susceptibility to interference is much reduced compared with NOAA-15.

For NOAA-16 any interference effects are below the noise level of the instrument, so no correction tables are needed.

For NOAA-17 there is low-level interference on Channels 18 and 19. These biases are associated with STX-2 and STX-3. The maximum Earth view bias is 2K for Channel 19 and 1K for Channel 18.

The biases were characterized during the post-launch checkout period, and correction tables issued. Because the spacecraft transmitters are stable there is no need for any additional correction tables or bias detection schemes.

This appendix is an attempt to document the bias characteristics of the AMSU-B instrument for the NOAA KLM spacecraft. The changes are ordered chronologically in this appendix, beginning with the most recent to the earliest changes (note that the tables are numbered in reverse order because of this arrangement).

The current corrections for the RFI contamination can be found by using the tables below to cross-reference the transmitter to the version of the coefficients currently being used.

Table M-1. NOAA-15 RFI Coefficients for AMSU-B

Transmitter	Version	Date	Table
STX1	1.7	Nov 11,1999	Table M.9-3
STX2	2.3	March 6, 2001	Table M.9-9
STX3	1.7	Nov 11,1999	Table M.9-3
SARR	2.3	March 6, 2001	Table M.9-9

Table M-2. NOAA-17 RFI Coefficients for AMSU-B

Transmitter	Version	Date	Table
STX1	1.0	July 12, 2002	M.9-11
STX2	1.0	July 12, 2002	M.9-11
STX3	1.0	July 12, 2002	M.9-11
SARR	1.0	July 12, 2002	M.9-11

M.1 DISCUSSION

The AMSU-B Level 1b dataset currently provides the following primary information:

- Raw instrument counts for Earth views. 90 values per channel per scan line.
- Polynomial coefficients for converting the raw counts to ‘antenna temperature’, i.e. the brightness temperature seen by the instrument with no correction for beam side lobes. Three coefficients per channel per scan line.

Space view counts and internal target counts are also present in the Level 1b dataset but are not required by the user once the polynomial coefficients have been calculated.

The Level 1b dataset is derived from the Level 1a dataset, which contains only raw instrument telemetry (i.e. no conversion coefficients).

In August 1998, a modification was made to the NESDIS Level 1b format to include information on the S-band transmitter status and output power levels. Thus, for any scan line it is possible to determine which transmitters were on. This information is stored in the analog telemetry data field. In general, some of the transmitters are only used during data downlinks (currently, STX2 and STX3) while others are on continuously (currently, STX1 and SARR). The information available in the Level 1b dataset is as follows: STX1, STX2, STX3 and STX4 status; STX1, STX2 and STX3 output power; SARR-A and SARR-B output power. All values are in the range 0 to 255 counts (representing analog voltages in the range 0 to 5.1 volts). For users of direct HRPT transmissions, the transmitter information may be extracted from the TIP data which is embedded in the HRPT data frame - see Section M.8 for details.

The correction scheme may be summarized as follows:

- Information on the required Earth view, space view and internal target view corrections are to be included in the Level 1b header, i.e. applying to the whole orbit.
- The polynomial coefficients are calculated based on corrected space view and target view counts (though the counts values stored in the Level 1b dataset are **not** changed)
- Scan-dependent Earth view corrections are applied by the Level 1b user before converting to radiance.

The advantages of including the correction information in the Level 1b header are as follows:

- It guarantees that the information is available to all Level 1b users
- The user does not have to keep track of any updates to the corrections

The advantages of making the space view and internal target view corrections at the Level 1A-Level 1b stage are as follows:

- Fixed space view and internal target view corrections are already applied at the Level 1A-Level 1b stage, so it is logical to apply the new correction here.
- The Level 1b user only needs to apply an Earth view correction.
- It allows the correction to be made before the quality control procedures are carried out and before the 7-line calibration convolution function is applied. This improves the results at times of transmitter change.

Recent ground-based Electromagnetic Compatibility (EMC) measurements on the F3 instrument have shown that the counts (or temperature) error due to interference is proportional to transmitter power. This cannot be verified at present on the spacecraft since the transmitter powers do not vary significantly. However, it is recommended that the correction algorithm should make some allowance for future variations in transmitter power. The transmitter powers reported in the analog telemetry are sufficiently noise-free that they can be relied on to provide an instantaneous measure of power. Errors due to digitization of the analog powers are less than 0.5 percent, which would contribute less than 0.2K error if these powers were used to scale the AMSU-B corrections (as outlined in sections M.3 and M.4).

Strictly speaking the relationship between analog counts and actual transmitter power level is not linear. However, for the purpose of AMSU-B bias removal, a linear relationship may be assumed, particularly since the transmitters are normally either fully on (with nearly constant power level) or fully off (with zero counts).

M.2 INFORMATION TO BE STORED IN THE HEADER

Rather than attempting to identify which channels are susceptible to which transmitters,

corrections are provided for all channels and transmitters. Thus, some corrections may be zero.

Transmitter - STX1, STX2, STX3 and SARR. (STX4 is not normally used, so may be ignored. Also, no distinction is made between SARR-A and SARR-B: only one of these will be active at any given time).

The count corrections are stored in the AMSU-B header record at byte offset 1001 (420 2-byte integers). The bias corrections in the header are given for 5 channels, 21 views, and 4 transmitters, in that order. The 21 views include 19 Earth scene views (views 1, 5, 10, 15, 20, ..., 85, 90) followed by cold and warm calibration views. The order of the 4 transmitters is STX1, STX2, STX3, and SAR.

Transmitter reference powers - mean power at the time the above corrections were derived.

The reference transmitter powers are stored at byte offset 1849 (four 2-byte integers, scaled by 10 x value in counts, i.e. a precision of 0.1 counts). The mean transmitter power at which the bias corrections were determined are given for each transmitter, in the order STX1, STX2, STX3 and SAR.

M.3 ADDITIONAL TASKS FOR THE LEVEL 1A-LEVEL 1b CALIBRATION PROGRAM

This section applies to users of HRPT direct transmissions or to users of raw GAC or LAC data. Read the bias correction information and 'reference' transmitter powers from an external file (containing data generated by the UKMO- see Section M.9) and incorporate into the Level 1b header.

- For each scan line, extract the transmitter powers from the analog telemetry. Divide each transmitter power by the reference transmitter power.
- For each transmitter that has non-zero power, obtain the space view and target view corrections and multiply by the power ratio. Correct the space view and internal target view counts before doing the space view / target view counts convolution process. If more than one transmitter is on, the combined correction is the sum of the individual corrections. Proceed with the rest of the calibration as before.

The transmitter powers for each scan line can be found at byte offset 2793-2802 in the AMSU-B data record (five 2-byte integer values, corresponding to STX1, STX2, STX3, SARR-A and SARR-B).

Note that since the update time of the analog parameters giving transmitter status is eight seconds, one or two AMSU-B scans before a transmitter switch-on or switch-off could be wrongly corrected, both at this stage and at the later stage (see below) when scan-dependent corrections are made. To indicate this, a scan-line quality flag is set if a transition was detected within $\forall 3$ scan lines of the one being calibrated. The quality flag is bit 4 of the quality indicator at byte offset 25-28 in the AMSU-B Level 1b data record.

For comparison purposes, the NESDIS Level 1b product will contain the uncorrected calibration coefficients in the 'secondary' coefficients locations (byte offset 121-180 in the data record). These secondary coefficients are not normally used. Quality flags will be calculated based on the primary coefficients.

M.4 ADDITIONAL TASKS FOR THE LEVEL 1b USER

- Read the Earth-view correction tables from the Level 1b header and calculate the counts correction as a function of transmitter, channel and pixel (see Section M.6 for discussion of interpolation methods). Store results in a look-up table (4 transmitters x 5 channels x 90 pixels = 1800 values).
- For each scan line, extract the transmitter powers from the analog telemetry. Divide each transmitter power by the reference transmitter power.
- For each transmitter that has non-zero power, obtain the Earth-view corrections and multiply by the power ratio. Hence, correct the Earth view counts. If more than one transmitter is on, the combined correction is the sum of the individual corrections.
- Calculate antenna temperature using the corrected counts and the standard calibration coefficients a_0 , a_1 and a_2 provided in the Level 1b file.

The transmitter powers for each scan line can be found at byte offset 2793-2802 in the AMSU-B data record (5 2-byte integer values, corresponding to STX1, STX2, STX3, SARR-A and SARR-B).

Example FORTRAN subroutines to correct the Earth-view data are provided in Section M.7

M.5 DERIVATION OF CORRECTION DATA

The correction data are obtained by examining the periods immediately before and immediately after a transmitter turn-off or turn-on. Changes in raw counts are measured. By examining several on/off occasions a measure of the repeatability may be obtained. It is preferable to work in units of raw counts in order to ensure that the space view, target view and Earth view corrections are independent. Also, it is known that the interference occurs in the 'back end' of the receiver, i.e. after the stages which have the largest gain variations, so a correction in counts is more appropriate.

The initial set of correction data (see Section M.9) are derived from the six transmitter on-off tests conducted between 24th August and 3rd September 1998. Three of these were conducted over land areas (Australia) and three over the South Pacific. There were no significant differences between the land and sea area results. Further tests will be conducted periodically in order to monitor any long-term changes.

Note that this is an objective test based purely on the AMSU-B data itself. It does not rely on any

particular radiance forward model, though comparisons with forward models can provide a useful additional check on the consistency of the AMSU-B radiances.

M.6 INTERPOLATION METHODS

The AMSU-B bias correction curves are essentially smooth curves that have been fitted to experimental data. Although there is insufficient space in the Level 1b header to provide corrections for all pixels, it is possible to show that by providing corrections at five pixel intervals there is no significant loss of accuracy, provided a suitable interpolation scheme is implemented. In other words, interpolation errors can be made small compared both with uncertainties in the bias and with instrument noise.

A simple linear interpolation method is simple to code and would result in interpolation errors of up to 0.5C; for many applications such errors may be acceptable. However, to achieve the best results higher order interpolations are required.

Many users will have access to cubic spline library routines, and these will give excellent results - within 1 or 2 counts of the original data values from which the correction tables were derived.

Alternatively, quadratic interpolation may be used in which a quadratic curve is provided between each pair of table samples. Any gradient discontinuities at the table sample points will be small provided the second derivative of the correction curve is slowly varying relative to the sample spacing of the table. This is a reasonable assumption for the AMSU-B application because of the underlying smooth nature of the correction curve. The overall accuracy is within 1 or 2 counts. This is the method used in the example in Section M.7, and is nearly as simple to code as the linear interpolation. It is recommended as an alternative to the use of cubic spline library routines.

M.7 FORTRAN EXAMPLES

Two example subroutines are provided below. The first may be used to interpolate the bias correction tables in an AMSU-B Level 1b header. The second may be used to apply corrections to Earth-view data.

```
!+
!ROUTINE  AMB_INTERPOLATE_EX
!
!DISCLAIMER The UK Meteorological Office does not guarantee the correctness
!           of this program and takes no responsibility for its use.
!
!PURPOSE  Example subroutine to interpolate AMSU-B bias correction values.
!         Quadratic interpolation - assumes 2nd derivative of correction
!         curve is approximately constant between input table points.
!
!VERSION  1.0   12 Oct 1998   N C Atkinson, UKMO
!
!ARGUMENTS Integer*2 CorrTable(5,21,4) Correction table in Level 1b header at
!           byte offset 1001
!           Integer*2 CountsCorr(5,90,4) Interpolated Earth-view corrections
!#####
```

```

SUBROUTINE INTERPOLATE_EX(CorrTable,CountsCorr)

INTEGER*2 CorrTable(5,21,4)
INTEGER*2 CountsCorr(5,90,4)
INTEGER Tx,Chan,Pix,Pix1,Pix2,P1,P2
REAL F,FF
REAL Grad(5,19,4) !First derivative of correction curve
!
! Calculate Gradients
!
DO Chan=1,5
DO Tx=1,4
DO Pix=2,18
Grad(Chan,Pix,Tx) = 0.1*(CorrTable(Chan,Pix+1,Tx) -
& CorrTable(Chan,Pix-1,Tx))
ENDDO
Grad(Chan,1,Tx) = 2*Grad(Chan,2,Tx) - Grad(Chan,3,Tx) !Special case
Grad(Chan,19,Tx) = 2*Grad(Chan,18,Tx) - Grad(Chan,17,Tx)
ENDDO
ENDDO
!
! Interpolate
!
DO Pix=1,90
P1 = Pix/5 + 1 ! 1 to 19 !Find nearest 2 points in table
P2 = Pix/5 + 2 ! 2 to 20
Pix1 = (P1-1)*5 !0 to 90
Pix2 = (P2-1)*5 !5 to 95
IF (Pix1 .EQ. 0) Pix1=1 !First point is pixel 1
IF (P2 .GT. 19) P2 = 19
F = (Pix2-Pix)/(1.0*(Pix2-Pix1)) !Linear term
FF = 0.5*F*(Pix-Pix1) !Quadratic term
DO Chan=1,5
DO Tx=1,4
CountsCorr(Chan,Pix,Tx)=NINT(CorrTable(Chan,P1,Tx)*F
& + CorrTable(Chan,P2,Tx)*(1.0-F)
& + (Grad(Chan,P1,Tx)-Grad(Chan,P2,Tx))*FF)
ENDDO
ENDDO
ENDDO
RETURN
END
#####
!+
!ROUTINE AMB_EarthCORRECT_EX
!
!DISCLAIMER The UK Meteorological Office does not guarantee the correctness
! of this program and takes no responsibility for its use.
!
!PURPOSE Example subroutine to correct AMSU-B Earth-view counts for bias
! errors. First convert the I*2 instrument telemetry (byte offset
! 1481-2560) to positive I*4 array. Returns with corrected Earth-view
! counts.
!
!VERSION 1.0 12 Oct 1998 N C Atkinson, UKMO
!
!ARGUMENTS
! Integer*4 Earthcounts(540) AMSU-B sensor data converted to I*4
! Integer*2 CountsCorr(5,90,4) Earth-view correction tables,
! from subroutine INTERPOLATE_EX

```

```

! Integer*2 TxPow(5)          Actual powers, from analog telemetry
! Integer*2 TxPow_ref(4)     10 X Ref Powers, in Level 1b header,
!                             byte offset 1849
#####

SUBROUTINE AMB_EarthCORRECT_EX(Earthcounts,CountsCorr,TxPow,
& TxPow_ref)

INTEGER*4 Earthcounts(540)  !AMSU-B sensor data
INTEGER*2 CountsCorr(5,90,4) !Earth-view Correction tables
INTEGER*2 TxPow_ref(4)      !From Level 1b header
INTEGER*2 TxPow(5)          !From analog telemetry
INTEGER*2 ECorr(5,90)       !Overall correction: 5 channels, 90 views
INTEGER Chan,Sample,I,Tx
REAL F
!
! Initialise
!
DO Chan=1,5
DO I=1,90
ECorr(Chan,I) = 0
ENDDO
ENDDO
!
! Calculate current corrections
!
DO Tx=1,4
IF (Tx.LT.4) THEN
F = TxPow(Tx)/(0.1*TxPow_ref(Tx))
ELSE
!Use sum of SARR-A and SARR-B powers
F = (TxPow(Tx)+TxPow(Tx+1))/(0.1*TxPow_ref(Tx))
ENDIF
IF (F.GT.0.01) THEN
DO Chan=1,5
DO I=1,90
ECorr(Chan,I)=ECorr(Chan,I)+NINT(CountsCorr(Chan,I,Tx)*F)
ENDDO
ENDDO
ENDIF
ENDDO
!
! Apply current corrections, overwriting the original counts values
!
DO Chan=1,5
DO Sample=1,90
I = (Sample-1)*6 + Chan + 1
Earthcounts(I) = Earthcounts(I) + ECorr(Chan,Sample)
ENDDO
ENDDO
RETURN
END
#####

```

M.8 LOCATION OF TRANSMITTER POWER DATA

Table M.8-1 provides the necessary information to extract the transmitter powers from the spacecraft telemetry. This information is required by users of HRPT transmissions or users of raw GAC or LAC data.

Description	Source	TIP Word #	TIP Minor Frame	AMSU-B Level 1b byte #
STX1 Power	TIP 16-sec analog subcom-1	11	48, 128, 208, 288	2793
STX2 Power	TIP 16-sec analog subcom-1	11	50, 130, 210, 290	2795
STX3 Power	TIP 16-sec analog subcom-1	11	40, 120, 200, 280	2797
SARR-A Power	TIP 16-sec analog subcom-2	14	114, 274	2799
SARR-B Power	TIP 16-sec analog subcom-2	14	2, 162	2801

Note: The TIP data are contained in HRPT minor frame 1 (of 3) at HRPT word 104-623.

M.9 BIAS CORRECTION TABLES

AMSU-B Bias corrections, Version 1.1, 22 Sept 1998, UKMO

Table M.9-1 gives the bias corrections for AMSU-B for transmitters: STX1, STX2, STX3 and SARR(A). The corrections (in counts) are provided for Earth views 1, 5, 10...90, Space view (91) and Target view (92) and the mean transmitter power is also given.

Transmitter: STX1 Mean transmitter power = 111.3 counts					
View	Channel 16	Channel 17	Channel 18	Channel 19	Channel 20
1	45	-514	12	-101	113
5	43	-555	27	-117	132
10	44	-595	38	-132	147
15	45	-612	44	-140	159
20	48	-617	45	-148	171
25	52	-626	40	-161	182
30	55	-603	31	-166	183
35	56	-502	22	-143	162
40	57	-362	15	-106	128
45	55	-246	9	-78	97
50	50	-170	7	-59	77
55	43	-126	13	-44	68
60	36	-105	24	-33	66
65	28	-98	29	-30	64
70	2	98	31	-30	61
75	18	-98	35	-27	58
80	18	-86	38	-19	52
85	23	-56	38	-9	41
90	34	-33	39	3	34
91	0	-21	-6	-9	11
92	0	4	0	0	7

Transmitter: STX2 Mean transmitter power = 114.3 counts					
View	Channel 16	Channel 17	Channel 18	Channel 19	Channel 20
1	0	0	0	0	0
5	0	0	0	0	0
10	0	0	0	0	0
15	0	0	0	0	0
20	0	0	0	0	0
25	0	0	0	0	0
30	0	0	0	0	0
35	0	0	0	0	0
40	0	0	0	0	0
45	0	0	0	0	0
50	0	0	0	0	0
55	0	0	0	0	0
60	0	0	0	0	0
65	0	0	0	0	0
70	0	0	0	0	0
75	0	0	0	0	0
80	0	0	0	0	0
85	0	0	0	0	0
90	0	0	0	0	0
91	4	-26	0	-13	10
92	0	0	0	0	0

Transmitter: STX3 Mean transmitter power = 95.0 counts					
View	Channel 16	Channel 17	Channel 18	Channel 19	Channel 20
1	23	-48	33	-42	36
5	17	-40	25	-43	32
10	11	-16	18	-33	19
15	7	-2	14	-18	4
20	3	-6	12	-7	0
25	0	-26	14	-12	12
30	-1	-51	17	-21	29
35	-3	-62	19	-16	28
40	-4	-59	19	-5	12
45	-4	-49	16	0	0
50	-4	-36	12	-4	-4
55	-3	-25	9	-12	-1
60	-3	-16	7	-19	2
65	-2	-8	6	-17	0
70	0	-9	5	-10	-3
75	0	-28	3	-6	0
80	1	-50	0	-6	9
85	3	-52	-4	-9	12

90	4	-39	1	-9	13
91	6	-100	-1	-17	22
92	2	-17	1	0	1
Transmitter: SARR Mean transmitter power = 209.9 counts					
View	Channel 16	Channel 17	Channel 18	Channel 19	Channel 20
1	9	-1	36	-582	-214
5	0	-1	20	-556	-217
10	-6	2	20	-520	-215
15	-9	0	21	-456	-206
20	-9	-4	19	-363	-191
25	-7	-3	13	-252	-168
30	-3	2	6	-146	-138
35	0	6	1	-70	-104
40	4	6	-1	-27	-71
45	6	2	-2	-9	-47
50	7	-2	0	-10	-34
55	6	-3	3	-22	-34
60	5	-2	6	-53	-47
65	3	-4	7	-112	-69
70	1	-7	7	-187	-90
75	0	-7	7	-257	-100
80	1	-4	9	-304	-98
85	3	-2	12	-316	-87
90	8	0	7	-291	-71
91	0	-2	1	-74	-16
92	0	0	-2	-25	-15

Note that on 13th October 1998, an additional bias appeared, which was largest on channel 17 (up to 60K additional error) but was present to some extent on all channels. This new bias has been present on every orbit since then, and is present for typically 75% of every orbit. See Section M.10 for further discussion of this problem.

January 4, 1999:

The S band transmitters on NOAA-K have been shown to interfere with AMSU-B. The effect is largest on channels 17 and 19 but has been shown to be present in the other channels also. The errors are largest in the Earth views, but space views and to a lesser extent internal target views are also affected. This appendix describes the UK Meteorological Office (UKMO) recommendations for correcting the data.

The largest Earth view biases are in channels 17 and 19, with a strong scan-dependence and maximum errors of approximately 40K when the STX1 and SARR transmitters are active. Since these transmitters are normally switched on all the time, the bias appears constant. The largest space view effect is in channel 17 when the STX3 transmitter is active. This

transmitter is currently used for data dumps to a ground station, typically for 5-10 minutes per orbit (not every orbit). When the transmitter is on, the space view counts rise by the equivalent of approximately 5K and the internal target view counts rise by approximately 1K. These rises cause errors in the calibration and result in Earth view brightness temperature errors of typically 2.5K at a scene temperature of 200K, decreasing to 1K at warm scene temperatures.

The correction scheme described below applies both to users of the NESDIS Level 1b product and to users who receive the HRPT transmissions directly. When the scheme is implemented, it is expected that the overall error will be reduced to approximately 1K for all channels.

September 28, 1999:

Table M.9-2 gives the bias corrections for AMSU-B for transmitters: STX2 Omni, STX3 and SARR(A). The corrections (in counts) are provided for Earth views 1, 5, 10...90, Space view (91) and Target view (92) and the mean transmitter power is also given.

Table M.9-2. AMSU-B Bias Corrections for NOAA-15 (as of 28 Sept 1999).					
Transmitter: STX2 Omni, Mean transmitter power: 112.0 counts					
View	Channel # 16	Channel # 17	Channel # 18	Channel # 19	Channel # 20
1	0	-263	-30	-102	98
5	0	-288	-15	-105	100
10	0	-263	-1	-97	93
15	0	-204	7	-80	77
20	0	-137	11	-57	54
25	0	-77	12	-32	29
30	0	-34	10	-13	8
35	0	-14	7	-4	0
40	0	-13	4	-3	-1
45	0	-20	0	-5	1
50	0	-26	-1	-7	3
55	0	-27	-3	-7	3
60	0	-23	-3	-6	2
65	0	-15	-3	-4	0
70	0	-6	-1	-3	0
75	0	-1	0	-2	0
80	0	-5	1	-1	0
85	0	-11	2	0	0
90	0	-7	4	0	0
91	0	0	0	0	0
92	0	0	00	0	0
Transmitter: STX3 Mean transmitter power=95.0 counts					
View	Channel #16	Channel #17	Channel #18	Channel #19	Channel #20
1	23	-48	33	-42	36
5	17	-40	25	-43	32

10	11	-16	18	-33	19
15	7	-2	14	-18	4
20	3	-6	12	-7	0
25	0	-26	14	-12	12
30	-1	-51	17	-21	29
35	-3	-62	19	-16	28
40	-4	-59	19	-5	12
45	-4	-49	16	0	0
50	-4	-36	12	-4	-4
55	-3	-25	9	-12	-1
60	-3	-16	7	-19	2
65	-2	-8	6	-17	0
70	0	-9	5	-10	-3
75	0	-28	3	-6	0
80	1	-50	0	-6	
85	3	-52	-4	-9	1
90	4	-39	1	-9	13
91	6	-100	-1	-17	22
92	2	-17	1	0	1

Transmitter: SARR Mean transmitter power=209.9 counts

View	Channel #16	Channel #17	Channel #18	Channel #19	Channel #20
1	9	-1	36	-582	-214
5	0	-1	20	-556	-217
10	-6	2	20	-520	-215
15	-9	0	21	-456	-206
20	-9	-4	19	-363	-191
25	-7	-3	13	-252	-168
30	-3	2	6	-146	-138
35	0	6	1	-70	-104
40	4	6	-1	-27	-71
45	6	2	-2	-9	-47
50	7	-2	0	-10	-34
55	6	-3	3	-22	-34
60	5	-2	6	-53	-47
65	3	-4	7	-112	-69
70	1	-7	7	-187	-90
75	0	-7	7	-257	-100
80	1	-4	9	-304	-98
85	3	-2	2	-316	87
90	8	0	7	-291	-71
91	0	-2	1	-74	16
92	0	0	-2	-25	-15

November 4, 1999:

Since the launch of NOAA-15, the three high-gain antennas connected to three of the four NOAA-15 transmitters (STX), specifically STX1, STX2 and STX3, have experienced increasing performance degradation. In addition, STX1 and STX3 radio frequency interference is being received by the AMSU-B instrument. The STX-1 high-gain HRPT antenna (1698.0 Mhz) is degraded to a level where small dish (1 m) users experience a significant number of HRPT dropouts, in many cases rendering the data unusable.

NOAA/NESDIS has reconfigured the spacecraft in an effort to maintain many of the missions of NOAA-15; i.e., readout of the full stored GAC data, HRPT direct readout (which also includes the HIRS and AMSU data), and HRPT Level 1b acquisitions at the NOAA CDAs.

At 0100 UTC on 28 September 1999, NOAA/NESDIS moved the HRPT service from STX-1 to the STX-2 OMNI antenna (1702.5 MHz). This transmitter/antenna combination has been tested with small dish receiving stations, and has been found to provide satisfactory reception under most conditions. (The EIRP for the STX-2 OMNI is equal to or greater than 24 dBm over 90% of a sphere). The STX-2 transmissions are Right Hand Circularly polarized and compatible with existing HRPT antenna systems. This change is permanent. APT service is not affected.

Because of these antenna interference problems, all Level 1b AMSU-B data from NOAA-15 received between launch and Sept. 28, 1999 should be considered unusable. A new bias correction table for the STX-2 OMNI antenna was included in the NOAA-K CPIDS AMSU-B preprocessor since Sept. 15, 1999, and is therefore included in the AMSU-B data set header record. These bias corrections must be applied by the user.

November 11, 1999:

AMSU-B Bias corrections, Version 1.7, 11 November 1999, include corrections for anomalous bias. Revised following trending tests of Oct 1999. STX-2 omni substituted for STX-2 high-gain based on October 1999 data. Transmitters STX1, STX2, STX3 and SARR(A) counts corrections for Earth views 1,5,10...90, Space view (91) and Target view (92). Mean transmitter power in counts, ID=4.

Table M.9-3. AMSU-B Bias Corrections for NOAA-15 Version 1.7 (11 Nov 1999).					
Transmitter: STX1, Mean transmitter power: 111.3 counts					
View	Channel # 16	Channel # 17	Channel # 18	Channel # 19	Channel # 20
1	33	-514	-12	-63	76
5	30	-555	13	-88	107
10	31	-595	19	-108	127
15	35	-612	24	-124	134
20	42	-617	32	-139	140
25	50	-626	32	-152	149
30	59	-603	28	-154	154
35	67	-501	28	-133	140

40	74	-362	28	-101	113
45	78	-246	24	-72	91
50	79	-170	17	-53	75
55	76	-126	12	-42	66
60	71	-105	13	-37	61
65	63	-98	17	-34	60
70	53	-98	23	-31	59
75	43	-98	27	-27	53
80	32	-86	29	-20	44
85	22	-56	31	-8	35
90	12	-33	39	3	32
91	0	-21	-6	-9	11
92	0	4	0	0	7

Transmitter: STX2 Omni, Mean transmitter power: 112.0 counts

View	Channel # 16	Channel # 17	Channel # 18	Channel # 19	Channel # 20
1	22	-254	-30	-92	95
5	21	-262	-15	-95	98
10	18	-236	-1	-88	93
15	13	-182	7	-70	76
20	8	-116	11	-45	52
25	5	-59	11	-19	31
30	2	-18	10	0	16
35	1	-1	7	3	7
40	0	-2	4	0	3
45	0	-16	0	-4	1
50	0	-29	-1	-5	2
55	0	-32	-3	-3	5
60	0	-25	-3	0	8
65	0	-14	-2	1	11
70	0	-4	-1	2	12
75	0	0	0	2	9
80	0	-2	1	3	6
85	0	-8	2	3	6
90	0	-4	4	4	8
91	0	0	0	0	0
92	0	0	0	0	0

Transmitter: STX3, Mean transmitter power: 95.0 counts

View	Channel # 16	Channel # 17	Channel # 18	Channel # 19	Channel # 20
1	8	-22	14	-41	29
5	12	-23	12	-37	20
10	16	-14	0	-31	9
15	19	-6	-9	-21	-4
20	22	-18	-11	-18	-6

25	23	-68	-1	-37	24
30	24	-127	15	-61	67
35	24	-156	30	-63	86
40	23	-155	39	7	78
45	21	-141	41	-30	53
50	18	-123	36	-21	28
55	15	-107	23	-24	21
60	10	-91	11	-32	23
65	6	-76	7	-35	20
70	1	-66	8	-31	18
75	-3	-65	9	-25	30
80	-8	-67	9	-19	42
85	-13	62	2	-17	34
90	-17	-54	8	-13	21
91	13	-110	2	-24	31
92	5	-20	-1	-1	3

Transmitter: SARR, Mean transmitter power: 210.0 counts

View	Channel # 16	Channel # 17	Channel # 18	Channel # 19	Channel # 20
1	0	-12	24	-469	-174
5	0	-5	20	-440	-167
10	0	0	14	-397	-165
15	0	3	8	-330	-164
20	0	4	4	-246	-158
25	0	5	0	-155	-141
30	0	4	-3	-74	-114
35	0	3	-5	-22	-82
40	0	1	-7	0	-51
45	0	0	-7	2	-31
50	0	-1	-5	-7	-23
55	0	-3	-2	-23	-28
60	0	-5	0	-54	-43
65	0	-5	4	-112	-66
70	0	-6	8	-187	-88
75	0	-6	10	-257	-102
80	0	-6	12	-306	-102
85	0	-6	12	-318	-85
90	0	-5	9	-294	-70
91	0	-2	1	-74	-16
92	0	0	-2	-25	-15

Anomalous STX1 correction tables for Scan 1

View	Channel # 16	Channel # 17	Channel # 18	Channel # 19	Channel # 20
1	43	-831	261	-330	277
3	44	-749	243	-292	243

6	23	-462	213	-202	152
9	-16	-105	173	-97	48
12	-48	228	123	0	-43
15	-66	454	67	72	-108
18	-71	538	18	114	-147
21	-64	553	-15	133	-162
24	-50	516	-27	140	-159
27	-39	462	-19	134	-142
30	-31	393	5	119	-115
33	-20	304	37	97	-82
36	-11	220	67	76	-59
39	-10	156	87	60	-50
42	-15	101	98	47	-48
45	-21	52	102	36	-46
48	-26	12	99	28	-43
51	-30	-21	95	21	-44
54	-33	-39	90	17	-50
57	-35	-28	78	19	-52
60	-40	5	59	26	-52
63	-50	34	35	34	-54
66	-60	46	9	40	-56
69	-66	39	-16	43	-57
72	-65	22	-35	40	-56
75	-58	8	-44	34	-53
78	-47	6	-42	28	-49
81	-38	11	-33	21	-42
84	-30	15	-23	14	-34
87	-19	9	-14	7	-25
90	-14	0	-6	0	-19
91	0	-46	-12	-9	-16
92	16	-74	39	-22	25

Anomalous STX1 correction tables for Scan 2

View	Channel # 16	Channel # 17	Channel # 18	Channel # 19	Channel # 20
1	54	-895	291	-359	298
3	54	-804	274	-316	264
6	31	-502	238	-220	168
9	-10	-127	189	-104	58
12	-44	216	132	-4	-39
15	-64	436	73	69	-107
18	-71	536	21	113	-146
21	-66	555	-14	135	-162
24	-53	520	-27	139	-160
27	-43	466	-18	132	-143
30	-34	398	6	116	-115

33	-22	311	37	94	-85
36	-13	227	67	73	-62
39	-13	161	88	57	-53
42	-17	106	99	45	-51
45	-23	61	101	35	-50
48	-29	25	97	29	-48
51	-34	-6	91	24	-49
54	-38	-25	83	19	-55
57	-41	-18	69	20	-58
60	-45	8	49	25	-59
63	-52	32	27	31	-60
66	-61	41	3	35	-62
69	-66	34	-20	38	-62
72	-65	20	-37	36	-60
75	-57	8	-44	31	-56
78	-47	6	-42	26	-51
81	-38	10	-33	21	-44
84	-30	13	-23	14	-35
87	-20	9	-13	4	-25
90	-14	1	-3	-1	-18
91	0	-46	-12	-9	-16
92	16	-74	39	-22	25

Anomalous STX1 correction tables for Scan 3

View	Channel # 16	Channel # 17	Channel # 18	Channel # 19	Channel # 20
1	51	-879	282	-352	301
3	52	-795	262	-313	260
6	29	-495	232	-219	168
9	-10	-135	190	-111	62
12	-45	202	136	-12	-33
15	-66	439	77	63	-104
18	-73	535	24	110	-143
21	-68	559	-12	135	-160
24	-56	528	-26	142	-160
27	-48	480	-22	137	-143
30	-41	414	-2	122	-114
33	-27	319	31	98	-81
36	-17	233	61	76	-57
39	-16	174	79	62	-49
42	-18	112	95	49	-46
45	-20	50	106	36	-43
48	-23	7	106	26	-39
51	-28	-22	100	21	-41
54	-33	-37	91	19	-49

57	-37	-26	76	23	-53
60	-42	2	54	31	-54
63	-50	28	28	40	-57
66	-59	38	2	45	-59
69	-65	29	-21	45	-59
72	-64	15	-37	40	-58
75	-57	7	-45	35	-54
78	-46	6	-43	32	-50
81	-37	11	-34	28	-42
84	-30	16	-23	22	-32
87	-20	11	-14	14	-25
90	-14	5	-3	8	-15
91	0	-46	-12	-9	-16
92	16	-74	39	-22	25

November 24, 1999:

The following updates to the AMSU-B RFI bias corrections are based on the October 1999 trending tests (performed by the UKMO).

These are the following differences compared with the previous version:

- 1) Only STX2 and SARR have changed (the other transmitters are not used operationally now, so the old values remain).
- 2) The largest change is for SARR in channel 19. Maximum change=3K. Would not expect any obvious difference in imagery products, but the new version gives a much flatter scan-dependence when compared with NWP model background.
- 3) Have left channel 18 completely unchanged. Changes in channels 17 and 20 are less than 1K.
- 4) Channel 16 uses a new technique involving AMSU-A to remove the unwanted effects of scene variation, the RFI corrections for this channel should be more accurate than before (probably about 0.2K). Other channels should be within 1K. Channel 19 is the one most likely to drift with time.

For RFI corrections, the users don't have to use the values in the Level 1b header if they don't want to.

December 1, 1999:

Updated values for the antenna bias will be implemented for NOAA-15. The changes are in response to the request to update the AMSU-B RFI Correction tables with data submitted by the UK Meteorological Office (UKMO) on Nov. 12, 1999. The first orbits to be processed will be: NSS.HRPT.NK.D99335.S1709.E1721.B0806464.GC scheduled to be ingested at 12:09 pm local time and NSS.GHRR.NK.D99335.S1535.E1707.B0806364.GC scheduled to be ingested at 12:23 pm local time.

January 4, 2000:

After re-configuring the STX antennas on NOAA-15, the previous AMSU-B bias has been minimized and stabilized. The monitoring of this new configuration since September 28, 1999 has shown little change in the bias. Therefore, it has been decided to declare the NOAA-15 1b, 1b* AMSU-B Level 1b an operational product as of January 6, 2000. Bias correction updates will still be implemented to perform bias corrections as deemed necessary by the instrument scientists.

January 10, 2000:

Revised following trending tests of 23 December 1999. STX-2 Omni antenna substituted for STX-2 high gain antenna. Transmitters STX2 Omni, STX4 and SARR(A) are operational per Nigel Atkinson (UKMO). It should be noted that there is no correction table for STX4 because it does not contribute to the interference with the AMSU-B instrument

Table M.9-4. AMSU-B Bias Corrections for NOAA-15, Version 1.8 (10 January 2000).					
Transmitter: STX2 Omni, Mean transmitter power: 112.0 counts					
View	Channel # 16	Channel # 17	Channel # 18	Channel # 19	Channel # 20
1	22	-240	-30	-86	87
5	21	-251	-15	-88	93
10	8	-228	-1	-78	89
15	13	-178	7	-61	72
20	8	-115	11	-42	48
25	5	-59	11	-24	24
30	2	-20	10	-11	6
35	1	-8	7	-5	-1
40	0	-12	4	-6	-2
45	0	-20	0	-7	-2
50	0	-25	-1	-8	-2
55	0	-26	-3	-8	0
60	0	-22	-3	-7	4
65	0	-12	-2	-6	7
70	0	-2	-1	-4	8
75	0	1	0	-2	6
80	0	-2	1	-1	3
85	0	-9	2	-3	4
90	0	-2	4	-2	6
91	0	0	0	0	0
92	0	0	0	0	0
Transmitter: SARR (A), Mean transmitter power: 210.0 counts					
View	Channel # 16	Channel # 17	Channel # 18	Channel # 19	Channel # 20
1	0	-10	24	-443	-166
5	0	-3	20	-416	-165

10	0	2	14	-400	-168
15	0	5	8	-344	-164
20	0	5	4	-251	-152
25	0	5	0	-151	-131
30	0	4	-3	-69	-105
35	0	1	-5	-24	-77
40	0	-1	-7	-5	-51
45	0	-3	-7	-6	-33
50	0	-6	-5	-19	-25
55	0	-8	-2	-40	-31
60	0	-11	0	-77	-47
65	0	-11	4	-142	-70
70	0	-12	8	-217	-90
75	0	-11	10	-284	-101
80	0	-9	12	-326	-100
85	0	-6	12	-326	-87
90	0	-1	9	-294	-75
91	0	-2	1	-74	-16
92	0	0	-2	-25	-15

May 4, 2000

An AMSU-B bias trending test was conducted on 26-27 April 2000. Results of this test, plus monitoring of daily mean brightness temperatures, show that a minor update to the bias correction tables is required. The last update was issued in January 2000. Only the STX2 and SARR tables have been updated.

Differences are as follows:

Channel 16: None

Channel 17: Maximum change 1.3K, mainly affecting pixels 1-30. This is probably not an instrument change but rather an improvement in the characterization method. Globally-averaged brightness temperatures were showing unrealistic structure between pixels 1-30, which has now been removed.

Channel 18: None

Channel 19: Maximum change 1.7K at pixels 1-10. This is real, and is probably associated with a change in thermal forcing. The bias pattern changed slightly around 13th April, coinciding with a change from falling instrument temperatures to rising. Note that channel 19 shows the largest EMI effects and is therefore the most sensitive to environment changes.

Channel 20: None

AMSU-B Bias corrections, Version 1.9, 4 May 2000, include corrections for anomalous bias.

Revised following trending tests of 26-27 April 2000. STX-2 Omni substituted for STX-2 high-gain per Nigel Atkinson (UKMO). The other active transmitters include STX4 Omni and SARR. The STX-4 Omni does not appear to cause any interference, so there is no table for it.

Table M.9-5. AMSU-B Bias Corrections for NOAA-15, Version 1.9 (4 May 2000).					
Transmitter: STX2 Omni, Mean transmitter power: 112.0 counts					
View	Channel # 16	Channel # 17	Channel # 18	Channel # 19	Channel # 20
1	22	-218	-30	-84	87
5	21	-249	-15	-86	93
10	18	-245	-1	-79	89
15	13	-208	7	-63	72
20	8	-138	11	-44	48
25	5	-67	11	-25	24
30	2	-24	10	-10	6
35	1	-15	7	-1	-1
40	0	-16	4	1	-2
45	0	-23	0	1	-2
50	0	-28	-1	-1	-2
55	0	-33	-3	-4	0
60	0	-23	-3	-6	4
65	0	-12	-2	-6	7
70	0	0	-1	-4	8
75	0	1	0	-2	6
80	0	-1	1	-1	3
85	0	-2	2	-1	4
90	0	-3	4	-3	6
91	0	0	0	0	0
92	0	0	0	0	0
Transmitter: SARR, Mean transmitter power: 210.0 counts					
View	Channel # 16	Channel # 17	Channel # 18	Channel # 19	Channel # 20
1	0	-10	24	-423	-166
5	0	0	20	-394	-165
10	0	6	14	-387	-168
15	0	10	8	-337	-164
20	0	11	4	-247	-152
25	0	10	0	-144	-131
30	0	7	-3	-64	-105
35	0	3	-5	-20	-77
40	0	0	-7	-2	-51

45	0	-2	-7	-6	-33
50	0	-5	-5	-18	-25
55	0	-6	-2	-38	-31
60	0	-8	0	-76	-47
65	0	-7	4	-144	-70
70	0	-7	8	-223	-90
75	0	-7	10	-293	-101
80	0	-6	12	-335	-100
85	0	-5	12	-332	-87
90	0	-5	9	-288	-75
91	0	-2	1	-74	-16
92	0	0	-2	-25	-15

July 10, 2000

An AMSU-B bias trending test was conducted on 27-28 June 2000. Results of this test, plus monitoring of daily mean brightness temperatures and NWP model comparisons, show that an update to the bias correction tables is required. The last update was issued in May 2000. Channel 19 bias due to SARR interference, and to a lesser extent channel 20, is continuing to drift at up to 1K per month, depending on scan position. This does not appear to be directly related to temperature change, or any other external factor.

This time only the SARR table has been updated. STX-2 has not changed.

AMSU-B Bias corrections, Version 2.0, 10 July 2000

STX-2 omni was substituted for STX-2 high-gain per Nigel Atkinson (UKMO). The other active transmitters include STX2 omni, STX4 omni and SARR(A). Counts corrections for Earth views 1, 5, 10...90, space view (91) and Target view (92).

Table M.9-6. AMSU-B Bias Corrections for NOAA-15, Version 2.0 (10 July 2000).					
Transmitter: SARR, Mean transmitter power: 210.0 counts					
View	Channel # 16	Channel # 17	Channel # 18	Channel # 19	Channel # 20
1	0	-10	24	-440	-166
5	0	0	20	-415	-165
10	0	6	14	-410	-168
15	0	10	8	-358	-164
20	0	11	4	-267	-152
25	0	10	0	-163	-135
30	0	7	-3	-80	-111
35	0	3	-5	-36	-83
40	0	0	-7	-17	-57
45	0	-2	-7	-20	-40

50	0	-5	-5	-33	-32
55	0	-6	-2	-58	-39
60	0	-8	0	-105	-60
65	0	-7	4	-179	-85
70	0	-7	8	-260	-106
75	0	-7	10	-326	-111
80	0	-6	12	-364	-105
85	0	-5	12	-357	-92
90	0	-5	9	-308	-75
91	0	-2	1	-74	-16
92	0	0	-2	-25	-15

November 9, 2000

An AMSU-B trending test was conducted on 3-4 November 2000. Results were as expected, i.e. a small change in the Channel 19 SARR interference, and otherwise no significant change. Results agree well with those obtained by other methods, including comparison with NOAA-16.

The only change in the new bias correction is the SARR table for channel 19. Changes range from -0.8K (around pixel 50) to +1.7K (pixel 20). The last update was issued in June 2000. The STX-2 omni antenna was substituted for STX-2 high-gain. Transmitters STX2 omni, STX4 omni and SARR(A) are active. Count corrections for Earth views 1, 5, 10...90, space view (91) and Target view (92).

Table M.9-7. AMSU-B Bias Corrections for NOAA-15, Version 2.1 (9 November 2000).					
Transmitter: SARR, Mean transmitter power: 210.0 counts					
View	Channel # 16	Channel # 17	Channel # 18	Channel # 19	Channel # 20
1	0	-10	24	-436	-166
5	0	0	20	-408	-165
10	0	6	14	-392	-168
15	0	0	8	-337	-164
20	0	11	4	-246	-152
25	0	10	0	-147	-135
30	0	7	-3	-75	-111
35	0	3	-5	-36	-83
40	0	0	-7	-20	-57
45	0	-2	-7	-29	-40
50	0	-5	-5	-45	-32
55	0	-6	-2	-68	-39
60	0	-8	0	-111	-60
65	0	-7	4	-177	-85
70	0	-7	8	-252	-106
75	0	-7	10	-316	-111

80	0	-6	12	-354	-105
85	0	-5	12	-354	-92
90	0	-5	9	-305	-75
91	0	-2	1	-74	-16
92	0	0	-2	-25	-15

December 8, 2000

An AMSU-B trending test was conducted on 4 December 2000 and was based on internal consistency and comparisons with NOAA-16. This revision includes corrections for anomalous bias, revised following trending tests of 3-4 November 2000 and updated for November drift. Only the channel 19 Earth-view SARR table was affected. The STX-2 omni antenna was substituted for the STX-2 high-gain antenna. Transmitters STX2 omni, STX4 omni and SARR(A) are active. Count corrections for Earth views 1,5,10...90, Space view (91) and Target view (92).

Table M.9-8. AMSU-B Bias Corrections for NOAA-15, Version 2.2 (4 December 2000).					
Transmitter: SARR, Mean transmitter power: 210.0 counts					
View	Channel # 16	Channel # 17	Channel # 18	Channel # 19	Channel # 20
1	0	-10	24	-441	-166
5	0	0	20	-414	-165
10	0	6	14	-396	-168
15	0	10	8	-336	-164
20	0	11	4	-242	-152
25	0	10	0	-143	-135
30	0	7	-3	-74	-111
35	0	3	-5	-37	-83
40	0	0	-7	-25	-57
45	0	-2	-7	-35	-40
50	0	-5	-5	-53	-32
55	0	-6	-2	-80	-39
60	0	-8	0	-125	-60
65	0	-7	4	-193	-85
70	0	-7	8	-271	-106
75	0	-7	10	-331	-111
80	0	-6	12	-367	-105
85	0	-5	12	-365	-92
90	0	-5	9	-314	-75
91	0	-2	1	-74	-16
92	0	0	-2	-25	-15

March 15, 2001

An AMSU-B trending test was conducted on 3 March 2001. Channels 19 and 20 of the SARR table were affected, as well as Channel 19 of the STX-2 omni table. Transmitters STX2 omni, STX4 omni and SARR(A) are active. Count corrections for Earth views 1,5,10...90, Space view (91) and Target view (92).

Table M.9-9. AMSU-B Bias Corrections for NOAA-15, Version 2.3 (6 March 2001).					
Transmitter: SARR, Mean transmitter power: 213.0 counts					
View	Channel # 16	Channel # 17	Channel # 18	Channel # 19	Channel # 20
1	0	-10	24	-416	-162
5	0	0	20	-397	-168
10	0	6	14	-387	-171
15	0	10	8	-332	-160
20	0	11	4	-238	-142
25	0	10	0	-139	-125
30	0	7	-3	-73	-102
35	0	3	-5	-37	-75
40	0	0	-7	-26	-52
45	0	-2	-7	-37	-36
50	0	-5	-5	-59	-31
55	0	-6	-2	-91	-41
60	0	-8	0	-150	-63
65	0	-7	4	-239	-90
70	0	-7	8	-327	-113
75	0	-7	10	-391	-124
80	0	-6	12	-418	-117
85	0	-5	12	-407	-103
90	0	-5	9	-344	-77
91	0	-2	1	-74	-16
92	0	0	-2	-25	-15
Transmitter: STX2 Omni, Mean transmitter power: 114.0 counts					
View	Channel # 16	Channel # 17	Channel # 18	Channel # 19	Channel # 20
1	22	-218	-30	-91	87
5	21	-249	-15	-92	93
10	18	-245	-1	-85	89
15	13	-208	7	-69	72
20	8	-138	11	-48	48
25	5	-67	11	-27	24
30	2	-24	10	-9	6
35	1	-15	7	0	-1
40	0	-16	4	2	-2
45	0	-23	0	4	-2

50	0	-28	-1	4	-2
55	0	-33	-3	1	0
60	0	-23	-3	-2	4
65	0	-12	-2	0	7
70	0	0	-1	2	8
75	0	1	0	3	6
80	0	-1	1	0	3
85	0	-2	2	-2	4
90	0	-3	4	-1	6
91	0	0	0	0	0
92	0	0	0	0	0

July 12, 2002

Table M.9-10. AMSU-B RFI Corrections for NOAA-17, Version 1.0 (12 July 2002).					
Transmitter: STX1, Mean transmitter power: 114.0 counts					
View	Channel # 16	Channel # 17	Channel # 18	Channel # 19	Channel # 20
1	0	0	0	0	0
5	0	0	0	0	0
10	0	0	0	0	0
15	0	0	0	0	0
20	0	0	0	0	0
25	0	0	0	0	0
30	0	0	0	0	0
35	0	0	0	0	0
40	0	0	0	0	0
45	0	0	0	0	0
50	0	0	0	0	0
55	0	0	0	0	0
60	0	0	0	0	0
65	0	0	0	0	0
70	0	0	0	0	0
75	0	0	0	0	0
80	0	0	0	0	0
85	0	0	0	0	0
90	0	0	0	0	0
91	0	0	0	0	0
92	0	0	0	0	0
Transmitter: STX2, Mean transmitter power: 76.8 counts					
View	Channel # 16	Channel # 17	Channel # 18	Channel # 19	Channel # 20
1	0	0	0	-2	0
5	0	0	0	-2	0

10	0	0	0	-2	0
15	0	0	0	-2	0
20	0	0	0	-4	0
25	0	0	0	-9	0
30	0	0	0	-16	0
35	0	0	0	-25	0
40	0	0	0	-29	0
45	0	0	0	-29	0
50	0	0	0	-25	0
55	0	0	0	-21	0
60	0	0	0	-18	0
65	0	0	0	-15	0
70	0	0	0	-5	0
75	0	0	0	-2	0
80	0	0	0	-6	0
85	0	0	-5	-21	0
90	0	0	-10	-34	0
91	0	0	-16	-81	0
92	0	0	0	0	0

Transmitter: STX3, Mean transmitter power: 88.7 counts

View	Channel # 16	Channel # 17	Channel # 18	Channel # 19	Channel # 20
1	0	0	0	0	0
5	0	0	0	3	0
10	0	0	0	3	0
15	0	0	0	-3	0
20	0	0	0	-13	0
25	0	0	0	-18	0
30	0	0	0	-19	0
35	0	0	0	-22	0
40	0	0	0	-30	0
45	0	0	0	-40	0
50	0	0	0	-37	0
55	0	0	0	-30	0
60	0	0	0	-19	0
65	0	0	0	-7	0
70	0	0	0	0	0
75	0	0	0	2	0
80	0	0	0	3	0
85	0	0	0	3	0
90	0	0	0	3	0
91	0	0	-8	-20	0
92	0	0	0	0	0

Transmitter: SARR, Mean transmitter power: 195.5 counts					
View	Channel # 16	Channel # 17	Channel # 18	Channel # 19	Channel # 20
1	0	0	0	0	0
5	0	0	0	0	0
10	0	0	0	0	0
15	0	0	0	0	0
20	0	0	0	0	0
25	0	0	0	0	0
30	0	0	0	0	0
35	0	0	0	0	0
40	0	0	0	0	0
45	0	0	0	0	0
50	0	0	0	0	0
55	0	0	0	0	0
60	0	0	0	0	0
65	0	0	0	0	0
70	0	0	0	0	0
75	0	0	0	0	0
80	0	0	0	0	0
85	0	0	0	0	0
90	0	0	0	0	0
91	0	0	0	0	0
92	0	0	0	0	0

August 13, 2004

RFI corrections for the NOAA-15 SARR transmitter were updated in August of 2004. Only channels 19 and 20 of the SARR table were affected. Count corrections for Earth views 1,5,10...90, Space view (91) and Target view (92).

Table M.9-11. AMSU-B RFI Corrections for NOAA-15, Version 2.4 (13 Aug. 2004).					
Transmitter: SARR, Mean transmitter power: 213.0 counts					
View	Channel # 16	Channel # 17	Channel # 18	Channel # 19	Channel # 20
1	0	-10	24	-434	-173
5	0	0	20	-421	-180
10	0	6	14	-408	-178
15	0	10	8	-344	-162
20	0	11	4	-246	-143
25	0	10	0	-147	-125
30	0	7	-3	-79	-104
35	0	3	-5	-41	-81
40	0	0	-7	-26	-59

45	0	-2	-7	-35	-44
50	0	-5	-5	-55	-37
55	0	-6	-2	-93	-46
60	0	-8	0	-168	-70
65	0	-7	4	-277	-102
70	0	-7	8	-386	-136
75	0	-7	10	-461	-144
80	0	-6	12	-491	-139
85	0	-5	12	-472	-121
90	0	-5	9	-389	-83
91	0	-2	1	-74	-16
92	0	0	-2	-25	-15

M.10 IMPLEMENTATION OF NEW AMSU-B BIAS CORRECTION CHANGES (AFTER OCTOBER 13, 1998)

Nigel Atkinson of the UKMO has devised a scheme for correcting AMSU-B processing for the “new” transmitter bias, which began on October 13, 1998. This new bias is associated with a change in operating mode of the STX1 transmitter, and is characterized by a strong positive bias for Earth views 1 to 10, and a strong negative bias for views 11 to 20 in channel 17. In addition, the bias is dependent on the relative position of the AMSU-B and AMSU-A2 antennae; since there are three AMSU-B scans for each A2 scan, there are three sets of values for the AMSU-B new bias correction.

According to the UKMO scheme, the following changes will be implemented in the AMSU-B Level 1b dataset:

M.10.1 Level 1b header record

Spares in the Level 1b dataset header are replaced by arrays of bias count corrections for Earth and calibration views. Three sets of bias corrections are given, each set having values for five channels and 33 views, in that order. The first set is applied to the first scan in an 8 second cycle, the second set to the second scan, etc. The 33 views include 31 Earth scene views (views 1, 3, 6, 9, 12, ..., 87, 90) followed by cold and warm calibration views. These bias corrections are 2-byte integer values. The bias correction values begin at byte offset 1865 in the Level 1b header.

M.10.2 Level 1b data record

A flag in the scan data record indicates whether the new bias is on or off. This flag is useful for indicating to users if corrections for the new bias are needed for the Earth view data in the scan line. Availability of the flag obviates the need for users to implement the new bias detection algorithm in their code. This flag is contained in bit 5 of Quality Indicator Bit Field at byte offset 25 (see Table 8.3.1.7.3-1 for the AMSU-B Level 1b format).

For the scan line at which the bias first occurs, as well as for the preceding line, there is some uncertainty in the bias corrections since the exact point within these two lines where transmitter mode changes is unknown. Thus, the change in new bias condition adversely affects calibration of a scan line if the change occurs within the convolution interval for the scan. Consequently, if a new bias change is detected within three scan lines of the line being calibrated, the existing “transmitter switchover” flag (bit 4 of Quality Indicator Bit Field at byte offset 25) is set to indicate uncertainty in the calibration of the scan.

The scan number in an 8 second cycle may be found from the 'Scan Line Number' data field at byte 1 in the Level 1b data record. Using FORTRAN notation, the scan number is $\text{MOD}(\text{amb_scnlin}-1,3)+1$, where amb scnlin is the Scan Line Number. This value is used to select the correct set of new bias corrections from the Level 1b header record.

The bias count corrections supplied by UKMO are input to the algorithm for computation of the primary calibration coefficients a_0 , a_1 , a_2 , which begin at byte offset 61 in the Level 1b data record. Secondary calibration coefficients (starting at byte offset 121) are computed without bias corrections. The quality flags in the header and data records reflect conditions pertaining to the primary calibration algorithm, as is currently the case.

The calibration algorithm includes gross count filtering and tests for consistency among readings within the scan. These tests are performed using the bias corrected values in the primary calibration procedure.

APPENDIX N: CONVERSION ROUTINE FOR IBM FLOATING POINT NUMBERS TO IEEE REAL NUMBERS

This appendix contains FORTRAN software that will convert IBM Floating Point numbers to IEEE real numbers. This software can be used to convert SST data.

```
FUNCTION R4CONV(R4IBM)
C
C *****
C
C NAME- R4CONV
C
C LANGUAGE- MICROSOFT FORTRAN  TYPE- FUNCTION  COMPUTER- PC
C
C VERSION- 1.0  DATE- 08/14/91  PROGRAMMER- KARL COX
C
C DESCRIPTION- THIS FUNCTION CONVERTS THE INPUT  IBM VS FORTRAN
C              INTERNAL REPRESENTATION FOR R*4 INTO AN IEEE R*4
C              INTERNAL REPRESENTATION FOR USE WITH THE RS/6000.
C
C              VS FORTRAN R*4 INTERNAL REPRESENTATION
C
C              |-----|-----|
C              |S| CHAR | FRACTION      |
C              |-----|-----|
C              0 1.....7 8.....31
C
C              1) THE CHARACTERISTIC IS IN BASE 16, AND AN
C                  OFFSET OF 64 IS USED. I.E., 16**(CHAR - 64)
C
C              2) THE DECIMAL VALUE IS OBTAINED BY DIVIDING
C                  THE FRACTION BY 2**24, AND MULTIPLYING BY
C                  THE DECIMAL NUMBER REPRESENTED BY THE
C                  CHARACTERISTIC.
C
C              IEEE R*4 INTERNAL REPRESENTATION
C
C              |-----|-----|
C              |S| CHAR | FRACTION      |
C              |-----|-----|
C              0 1.....8 9.....31
C
C              1) THE CHARACTERISTIC IS IN BASE 2, AND AN
C                  OFFSET OF 127 IS USED.
C                  I.E., 2**(CHAR - 127)
C
C              2) THE DECIMAL VALUE IS OBTAINED BY DIVIDING
C                  THE FRACTION BY 2**23, ADDING 1.0, AND
```

C MULTIPLYING BY THE DECIMAL NUMBER
C REPRESENTED BY THE CHARACTERISTIC.

C CALLING PARAMETERS-

C

C VARIABLE TYPE I/O DESCRIPTION

C -----

C R4IBM R*4 I THE VALUE THAT IS TO BE CONVERTED.

C

C LOCAL VARIABLES-

C

C VARIABLE TYPE DESCRIPTION

C -----

C VALUE R*4 HOLDS THE VALUE TO BE CONVERTED FOR
C EQUIVALENCING PURPOSES.

C

C IVALUE I*4 HOLDS THE INTEGER REPRESENTATION OF
C THE VALUE TO BE CONVERTED VIA AN
C EQUIVALENCE.

C

C SIGN I*4 HOLDS THE SIGN OF THE VALUE.

C

C CHARAC I*4 HOLDS THE CHARACTERISTIC OF THE VALUE

C

C FRACT I*4 HOLDS THE FRACTION OF THE VALUE.

C

C MAXFRA I*4 MAXIMUM FRACTION VALUE.

C

C NEGSIG I*4 NEGATIVE SIGN VALUE.

C

C POSSIG I*4 POSITIVE SIGN VALUE.

C

C IMASK1 I*4 MASK OF ONES.

C

C IMASK2 I*4 MASK OF ZEROS.

C

C R8MXFR R*8 DOUBLE PRECISION MAXIMUM FRACTION.

C

C MASKCH I*4 MASK FOR THE CHARACTERISTIC PORTION.

C

C MASKFR I*4 MASK FOR THE FRACTIONAL PORTION.

C

C R4SPV R*4 REAL*4 SPECIAL VALUE.

C

C AR4SPV I*4 EQUIVALENCED TO R4SPV.

C

C FUNCTIONS USED- BTEST, DBLE, IAND, IOR, ISHFT

C

C EXIT STATES- NONE

C

C*****

```

C
REAL*4 R4IBM
REAL*4 R4CONV
C
REAL*4 VALUE
INTEGER*4 IVALUE
EQUIVALENCE (VALUE,IVALUE)
INTEGER*4 SIGN, CHARAC, FRACT
C
C PARAMETER DECLARATIONS.
C
INTEGER*4 MAXFRA, NEGSIG, POSSIG, IMASK1, IMASK2
REAL*8 R8MXFR
INTEGER*4 MASKCH,MASKFR
C
C REAL*4 SPECIAL VALUE.
C
REAL*4 R4SPV
INTEGER*4 AR4SPV
EQUIVALENCE (R4SPV,AR4SPV)
DATA AR4SPV /Z80000001/
DATA MAXFRA / Z01000000/, NEGSIG / Z80000000/,
1    POSSIG / Z00000000/, IMASK1 / Z7F7FFFFFF/,
2    IMASK2 / Z00800000/
DATA MASKCH /Z7F000000/,MASKFR /Z00FFFFFF/
R8MXFR = MAXFRA
C
C          TEST IF SPECIAL VALUE.
C
IF(R4IBM .EQ. R4SPV) THEN
  R4CONV = R4SPV
ELSE
C
C   NOT SPECIAL VALUE, GET SIGN AND CHARACTERISTIC.
C
VALUE = R4IBM
IF(BTEST(IVALUE,31)) THEN
  SIGN = NEGSIG
ELSE
  SIGN = POSSIG
ENDIF
CHARAC = IAND(IVALUE,MASKCH)
C
C   RIGHT JUSTIFY CHARAC, REMOVE BIAS
C   AND CONVERT FROM BASE 16 TO BASE 2.
C
CHARAC = ( ISHFT(CHARAC, -24) - 64)*4
C
C   IF VS FORTRAN CHARAC IS GREATER THAN THE
C   LARGEST IEEE CHARAC VALUE OR LESS THAN

```

```

C   THE SMALLEST IEEE CHARACTERISTIC VALUE, RETURN
C   THE CORRESPONDING EXTREME IEEE VALUE.
C
  IF(CHARAC .GT. 127) THEN
    IVALUE = IOR(SIGN,IMASK1)
    R4CONV = VALUE
  ELSE IF(CHARAC .LT. -126) THEN
    IVALUE = IOR(SIGN,IMASK2)
    R4CONV = VALUE
  ELSE
C
C   EXTRACT BINARY FRACT AND COMPUTE IEEE VALUE.
C
    FRACT = IAND(IVALUE,MASKFR)
    VALUE = (2.0**CHARAC) * (DBLE(FRACT)/R8MXFR)
    IVALUE = IOR(SIGN,IVALUE)
    R4CONV = VALUE
  ENDIF
ENDIF
C
RETURN
END

```

APPENDIX O: PROCEDURE FOR SCHEDULING AVHRR LAC DATA

This appendix contains procedures to schedule AVHRR LAC recording over specific areas of the world where coverage is not possible from a number of direct readout stations maintained by NOAA. Because recorder space and transmission time must be shared by many requestors, requests must be received at least one month prior to the data acquisition period. Requests will be considered on a first-come, first-served basis, and according to the following priority considerations:

1. National emergencies, as specified in the various national emergency plans
2. Situations where human life is in immediate danger (i.e., search and rescue operations)
3. U.S. strategic requirements
4. Commercial requirements
5. Scientific investigations and studies
6. Other miscellaneous activities

Requests must also be accompanied by the following:

- a. Brief description of application
- b. Geographical area (i.e., East Greenland, Korea Straits, etc.)
- c. Latitude and longitude coordinates bounding the area of interest
- d. Desired frequency of coverage (i.e., once weekly, etc.)
- e. Spectral channels required for image processing - Channel 1, 2 or 3A = visible; Channel 3B, 4, or 5 = infrared. Include range of expected brightness values or temperatures for image enhancement purposes. Please be aware that channels 3A and 3B are shared and may be configured differently on each satellite.
- f. Beginning and ending dates of the study period.
- h. Satellite preference: Morning NOAA polar orbiter - daylight descending, nighttime ascending with a descending local crossing time of 0730. Afternoon NOAA polar orbiter - daylight ascending, nighttime descending with an ascending local crossing time of 1400
- i. Name, address, telephone number and email address of requestor.

Failure to provide this information at the time of the request may cause a delay in scheduling of the LAC data. Requests for AVHRR LAC data preferably should be e-mailed to address listed below. Contacts by phone need to be followed by written documentation and sent to:

Keith Catalan
POES Scheduling Team Lead
Mission Operations Division
NOAA/NESDIS/OSPO
NSOF Bld., Room 1527
4231 Suitland Road
Suitland, MD 20746-4304

Voice: 301-817-4161

Cell: 301-892-0469

Email: nesdis.oso.poes.scheduling@noaa.gov

Every effort is made to accommodate each request, for example, by combining requests of overlapping areas. However, because the number of requests for LAC coverage always surpasses scheduling and spacecraft resources, NESDIS does not guarantee complete or even partial fulfillment of LAC requirements. If scheduling conflicts severely limit the acquisition of LAC coverage, requestors will be notified by the POES Scheduling Team. Users are not charged a fee for scheduling services.

Users should be aware that a request for LAC scheduling is not an implicit request for data. All AVHRR LAC data can be acquired through the Comprehensive Large Array-data Stewardship System (CLASS) at www.class.noaa.gov.

APPENDIX P: FUNDAMENTAL CONSTANTS

NOAA/NESDIS uses the following fundamental constants in radiation calculations for all operational satellite systems. They have been adopted from the 1998 Committee on Data for Science and Technology (CODATA) of the International Council of Scientific Unions (CODATA,1998)*.

The fundamental constants include the speed of light (c), The Boltzman constant (k), and the Planck constant (h). The 1998 CODATA values are:

$$c = 299,792,458 \text{ m/sec}$$

$$k = 1.38065030 \times 10^{-23} \text{ J/deg K}$$

$$h = 6.62606876 \times 10^{-34} \text{ J sec}$$

Thus, the Planck formula radiation constants are:

$$c_1 = 1.1910427 \times 10^{-05} \text{ mW}/(\text{m}^2 \text{ sr cm}^{-4})$$

$$c_2 = 1.4387770 \text{ cm K}$$

* CODATA has since revised these constants, except the speed of light. These are published on the National Institute of Standards and Technology (NIST) website at <http://physics.nist.gov/cuu/Constants/index.html>